

Yi 熠

5W Series

“Yi [Yi] is the English translation for the Chinese word meaning Dazzling or Sparkling. This multi-chip package has the brightness to illuminate the space around it, a beacon in the dark.”



Introduction

The Yi series is a high power, 4-chip device with very low thermal resistance as a result of the ceramic substrate. The series is a surface-mount high-power device featuring high brightness combined with a compact size that is suitable for all kinds of lighting applications such as general illumination, spot, signal, industrial and commercial lighting.

Features

- ◆ Soldering method: SMT
- ◆ Binning Parameters: Brightness, Forward Voltage, Wavelength and Chromaticity
- ◆ Moisture Sensitivity Level:1
- ◆ RoHS compliant
- ◆ Matches ANSI binning
- ◆ Reliability testing conforms to IESNA LM80 Lumen maintenance test method

Applications

- ◆ General Lighting
- ◆ Indoor and Outdoor Lighting
- ◆ Retrofit Bulbs
- ◆ Decorative and Entertainment Lighting
- ◆ Signal Lighting/Beacon Lighting
- ◆ Exterior and Interior Automotive Illumination

Table of Contents

Product Nomenclature	3
Absolute Maximum Ratings.....	4
JEDEC Moisture Sensitivity.....	4
Luminous Flux Characteristics for the Yi series.....	5
PN of Yi High Luminous Series: White LEDs.....	11
White Bin Structure.....	17
Forward Voltage Bins	23
Optical Characteristics.....	24
Mechanical Dimension.....	25
Pad Configuration.....	26
Reflow Soldering Characteristics	27
Wavelength Characteristics	28
Typical Light Output Characteristic vs. Thermal Pad Temperature	29
Typical Electrical Characteristics	30
Typical Relative Luminous Flux vs. Forward Current.....	30
Typical CCT Shift Characteristics vs. Forward Current.....	31
Current Derating Curves.....	32
Typical Radiation Patterns.....	33
Typical Radiation Patterns.....	35
Emitter Tape Packaging.....	37
Emitter Reel Packaging	38
Product Labeling	38
Storage Conditions	40
Revision History.....	41

Product Nomenclature

The product name is designated as below:

ELYI- ABCDE – FGHIJ – V1234

Designation:

AB = min. luminous flux (lm) or radiation power (mW) performance

C = radiation pattern ^[1]

D = color ^[2]

E = power consumption ^[3]

F = reserved for future product offerings

G = internal code

H = packaging type ^[4]

IJ = internal code

V = forward voltage bin

1234 = color bin or CCT bin

Notes

1. Table of radiation patterns

Symbol	Description
1	Lambertian
2	Others

2. Table of color offerings:

Symbol	Color	Color Temperature
C	Cool-White	4745~7050K
N	Neutral-White	3710~4745K
M	Warm-White	2580~3710K

3. Table of power consumptions:

Symbol	Description
5	5W

4. Table of packaging types:

Symbol	Description
P	Tape
B	Tube
T	Tray

Absolute Maximum Ratings

Parameter	Symbol	Ratings	Unit
Max. DC Forward Current (mA)	I_F	1000 ^[1]	mA
Max. Peak Pulse Current (mA)	I_{Pulse}	1400 ^[2]	mA
Reverse Voltage	V_R	Note 3	V
Thermal Resistance	R_{th}	6	°C/W
Max. Junction Temperature	T_J	125 ^[4]	°C
Operating Temperature	T_{Opr}	-40 ~ +100 ^{[5] [6]}	°C
Storage Temperature	T_{Stg}	-40 ~ +100	°C
Max. Soldering Temperature	T_{Sol}	260	°C
Max. Allowable Reflow Cycles	n/a	3	cycles

Notes:

- Maximum forward current is 1000mA (Thermal Pad=25°C).
- Duty cycle = 1/10@1KHz
- The Yi series LEDs are not designed for reverse bias operation.
- Maximum junction temperature is 125°C for White LEDs.
- Maximum Operating Temperature (Thermal Pad) is 100°C for White LEDs.
- Avoid operating Yi LEDs at maximum operating temperature exceeding 1 hour.

JEDEC Moisture Sensitivity

Level	Floor Life		Soak Requirements Standard	
	Time (hours)	Conditions	Time (hours)	Conditions
1	Unlimited	≤ 30°C / 85% RH	168 (+5/-0)	85°C / 85% RH

Luminous Flux Characteristics for the Yi series

Color	Part Number	5W	
		Minimum Luminous Flux(lm) _[1]	Drive Current (mA)
Cool White 6500	ELYI – K52C5	325	700
	ELYI – K62C5	350	
	*ELYI – K72C5	375	
Cool White 5700	ELYI – K52C5	325	
	ELYI – K62C5	350	
	*ELYI – K72C5	375	
Cool White 5000	ELYI – K42C5	300	
	ELYI – K52C5	325	
	*ELYI – K62C5	350	
Neutral White 4500	ELYI – K32N5	275	
	ELYI – K42N5	300	
	*ELYI – K52N5	325	
Neutral White 4000	ELYI – K32N5	275	
	ELYI – K42N5	300	
	*ELYI – K52N5	325	
Warm White 3500	ELYI – K22M5	250	
	ELYI – K32M5	275	
	*ELYI – K42M5	300	
Warm White 3000	ELYI – K22M5	250	
	ELYI – K32M5	275	
	*ELYI – K42M5	300	
Warm White 2700	ELYI – K12M5	225	
	ELYI – K22M5	250	
	*ELYI – K32M5	275	

*Product lead-time of at least 8 weeks.

Notes:

1. Luminous flux measurement tolerance: $\pm 10\%$.
2. The data of luminous flux measured at thermal pad=25°C
3. Typical luminous flux or light output performance is operated within the condition guided by this datasheet



PN of the Yi series: White LEDs

ELYI-xxxx5-xLxxx-xxxxx

The table below lists part numbers for the Everlight Yi series 5W White LED. All parts listed match ANSI binning standards. Bin offerings of 6500K, 5700K, and 5000K, 4500K, 4000K, 3500K, 3000K, and 2700K are listed and currently available. CRI is also listed with min 70 to 80. Typical view angle is **105°**. These clearly listed binning options allow for proper design and implementation into lighting applications. The Order Codes below are currently available White Yi LEDs.

For example: If you order product using P/N **ELYI-K62C5-0LPGS-P5700**, you will be specifying White, Yi series LEDs at 700mA are listed below

Color Variant	Radiation Pattern	CRI	CCT	Forward Voltage (V)	Minimum Luminous Flux (lm)
Cool White	Lambertian	70	57K-1 ~ 57K-2 ~ 57K-3 ~ 57K-4	6~8	325

Color	Order Code of ELYI	Minimum Luminous Flux (lm)		CCT (K)	Forward Voltage (V)	CRI (Min)
Cool White 6500	ELYI – K52C5 – 0LPGS – P6500	K5	325	65K-1~65K-4	6~8	70
		K6	350			
		K7	375			
		K8	400			
	ELYI – K62C5– 0LPGS – P6500	K6	350	65K-1~65K-4	6~8	70
		K7	375			
		K8	400			
		K9	425			
	*ELYI – K72C5– 0LPGS – P6500	K7	375	65K-1~65K-4	6~8	70
		K8	400			
		K9	425			
		N1	450			

*Product lead- time of at least 8 weeks.

Color	Order Code of ELYI	Minimum Luminous Flux (lm)		CCT (K)	Forward Voltage (V)	CRI (Min)
Cool White 5700	ELYI – K52C5 – 0LPGS – P5700	K5	325	65K-1~65K-4	6~8	70
		K6	350			
		K7	375			
		K8	400			
	ELYI – K62C5– 0LPGS – P5700	K6	350	65K-1~65K-4	6~8	70
		K7	375			
		K8	400			
		K9	425			
	*ELYI – K72C5– 0LPGS – P5700	K7	375	65K-1~65K-4	6~8	70
		K8	400			
		K9	425			
		N1	450			
Cool White 5000	ELYI – K42C5– 0LPGS – P5000	K4	300	50K-1~50K-4	6~8	70
		K5	325			
		K6	350			
		K7	375			
	ELYI – K52C5– 0LPGS – P5000	K5	325	50K-1~50K-4	6~8	70
		K6	350			
		K7	375			
		K8	400			
	*ELYI – K62C5– 0LPGS – P5000	K6	350	50K-1~50K-4	6~8	70
		K7	375			
		K8	400			
		K9	425			

*Product lead- time of at least 8 weeks.

Notes:

1. CRI measurement tolerance: ± 2

Color	Order Code of ELYI	Minimum Luminous Flux (lm)		CCT (K)	Forward Voltage (V)	CRI (Min)
		K	Value			
Neutral White 4500	ELYI – K32N5– 0LPGS – P4500	K3	275	45K-1~45K-4	6~8	70
		K4	300			
		K5	325			
		K6	350			
	ELYI – K42N5– 0LPGS – P4500	K4	300	45K-1~45K-4	6~8	70
		K5	325			
		K6	350			
		K7	375			
	*ELYI – K52N5– 0LPGS – P4500	K5	325	45K-1~45K-4	6~8	70
		K6	350			
		K7	375			
		K8	400			
Neutral White 4000	ELYI – K32N5– 0LPGS – P4000	K3	275	40K-1~40K-4	6~8	70
		K4	300			
		K5	325			
		K6	350			
	ELYI – K42N5– 0LPGS – P4000	K4	300	40K-1~40K-4	6~8	70
		K5	325			
		K6	350			
		K7	375			
	*ELYI – K52N5– 0LPGS – P4000	K5	325	40K-1~40K-4	6~8	70
		K6	350			
		K7	375			
		K8	400			

*Product lead- time of at least 8 weeks.

Notes:

1. CRI measurement tolerance: ± 2

Color	Order Code of ELYI	Minimum Luminous Flux (lm)		CCT (K)	Forward Voltage (V)	CRI (Min)
		K	Flux (lm)			
Warm White 3500	ELYI – K22M5– 0LPGS – P3500	K2	250	35K-1~35K-4	6~8	70
		K3	275			
		K4	300			
		K5	325			
	ELYI – K32M5– 0LPGS – P3500	K3	275	35K-1~35K-4	6~8	70
		K4	300			
		K5	325			
		K6	350			
	*ELYI – K42M5– 0LPGS – P3500	K4	300	35K-1~35K-4	6~8	70
		K5	325			
		K6	350			
		K7	375			
Warm White 3000	ELYI – K22M5– 0LPGS – P3000	K2	250	30K-1~30K-4	6~8	70
		K3	275			
		K4	300			
		K5	325			
	ELYI – K32M5– 0LPGS – P3000	K3	275	30K-1~30K-4	6~8	70
		K4	300			
		K5	325			
		K6	350			
	*ELYI – K42M5– 0LPGS – P3000	K4	300	30K-1~30K-4	6~8	70
		K5	325			
		K6	350			
		K7	375			

*Product lead- time of at least 8 weeks.

Notes:

1. CRI measurement tolerance: ± 2

Color	Order Code of ELYI	Minimum Luminous Flux (lm)		CCT (K)	Forward Voltage (V)	CRI (Min)
		K	Flux (lm)			
Warm White 2700	ELYI – K12M5 – 0LPGS – P2700	K1	225	27K-1~27K-4	6~8	70
		K2	250			
		K3	275			
		K4	300			
	ELYI – K22M5 – 0LPGS – P2700	K2	250	27K-1~27K-4	6~8	70
		K3	275			
		K4	300			
		K5	325			
	*ELYI – K32M5 – 0LPGS – P2700	K3	275	27K-1~27K-4	6~8	70
		K4	300			
		K5	325			
		K6	350			

*Product lead-time of at least 8 weeks.

Notes:

1. CRI measurement tolerance: ± 2

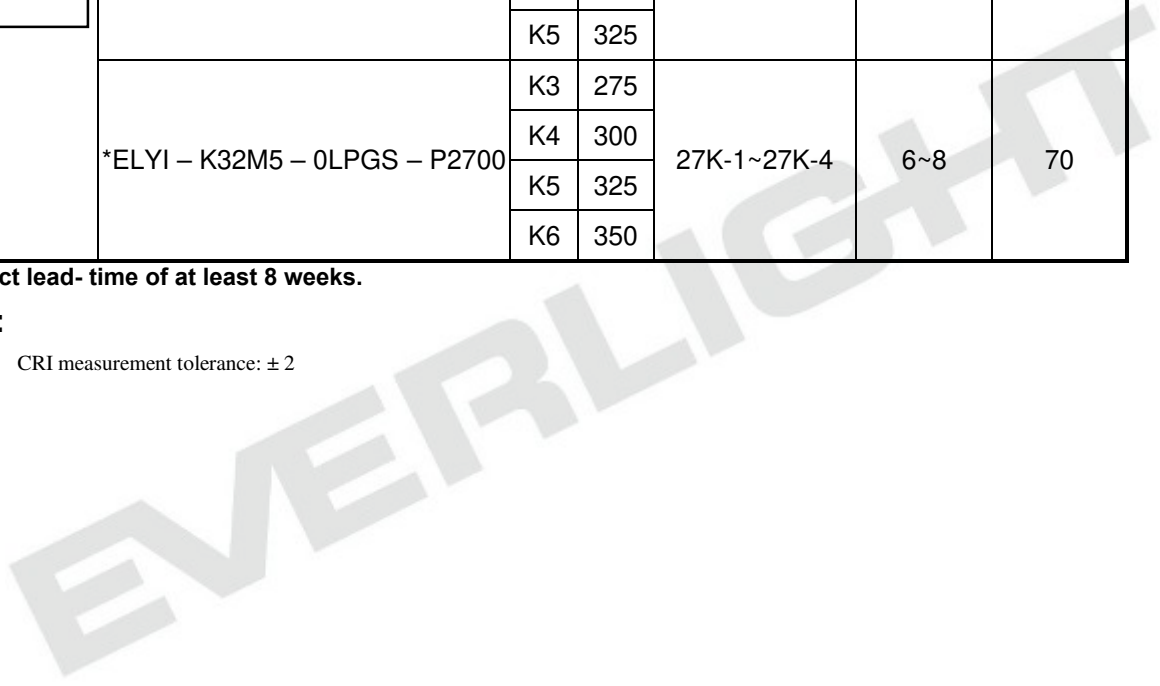



PN of Yi High Luminous Series: White LEDs

ELYI-xxxx5-xCxxx-xxxxx

The table below is a list of part numbers for the Everlight Yi 5W high luminous series White LED. All parts listed match ANSI binning standards. Bin offerings of 2700K to 6500K are listed and currently available. CRI is also listed with min 70 to 80. Typical view angle is **90°**. These clearly listed binning options allow for proper design and implementation into lighting applications. The Order Codes below are currently available White Yi LEDs.

For example: If you order product using P/N **ELYI-K62C5-0CPGS-D5700**, you will get White, Yi series LEDs at 700mA are listed below.

Color Variant	Radiation Pattern	CRI	CCT	Forward Voltage (V)	Minimum Luminous Flux (lm)
Cool White	Lambertian	70	57K-1 ~ 57K-2 ~ 57K-3 ~ 57K-4	6~8	325

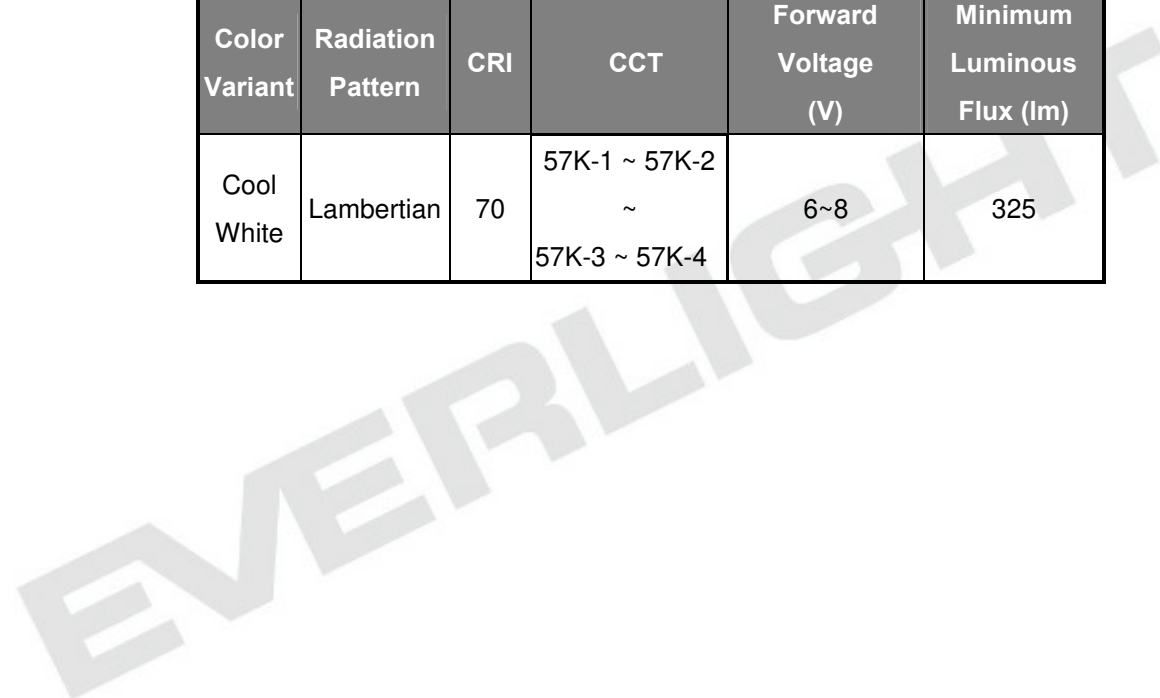

Color	Order Code of ELYI	Minimum Luminous Flux (lm)		CCT (K)	Forward Voltage (V)	CRI (Min)
Cool White 6500	ELYI – K62C5– 0CPGS – P6500	K6	350	65K-1~65K-4	6~8	70
		K7	375			
		K8	400			
		K9	425			
	ELYI – K72C5– 0CPGS – P6500	K7	375	65K-1~65K-4	6~8	70
		K8	400			
		K9	425			
		N1	450			
Cool White 5700	ELYI – K62C5– 0CPGS – P5700	K6	350	57K-1~57K-4	6~8	70
		K7	375			
		K8	400			
		K9	425			
	ELYI – K72C5– 0CPGS – P5700	K7	375	57K-1~57K-4	6~8	70
		K8	400			
		K9	425			
		N1	450			

Notes:

1. CRI measurement tolerance: ± 2

Color	Order Code of ELYI	Minimum Luminous Flux (lm)		CCT (K)	Forward Voltage (V)	CRI (Min)
		K	Value			
Cool White 5000	ELYI – K52C5– 0CPGS – P5000	K5	325	50K-1~50K-4	6~8	70
		K6	350			
		K7	375			
		K8	400			
	ELYI – K62C5– 0CPGS – P5000	K6	350	50K-1~50K-4	6~8	70
		K7	375			
		K8	400			
		K9	425			
Neutral White 4500	ELYI – K42N5– 0CPGS – P4500	K4	300	45K-1~45K-4	6~8	70
		K5	325			
		K6	350			
		K7	375			
	ELYI – K52N5– 0CPGS – P4500	K5	325	45K-1~45K-4	6~8	70
		K6	350			
		K7	375			
		K8	400			
Neutral White 4000	ELYI – K42N5– 0CPGS – P4000	K4	300	40K-1~40K-4	6~8	70
		K5	325			
		K6	350			
		K7	375			
	ELYI – K52N5– 0CPGS – P4000	K5	325	40K-1~40K-4	6~8	70
		K6	350			
		K7	375			
		K8	400			

Notes:

1. CRI measurement tolerance: ± 2

Color	Order Code of ELYI	Minimum Luminous Flux (lm)		CCT (K)	Forward Voltage (V)	CRI (Min)
		K	Value			
Warm White 3500	ELYI – K32M5– 0CPGS – P3500	K3	275	35K-1~35K-4	6~8	70
		K4	300			
		K5	325			
		K6	350			
	ELYI – K42M5– 0CPGS – P3500	K4	300	35K-1~35K-4	6~8	70
		K5	325			
		K6	350			
		K7	375			
Warm White 3000	ELYI – K32M5– 0CPGS – P3000	K3	275	30K-1~30K-4	6~8	70
		K4	300			
		K5	325			
		K6	350			
	ELYI – K42M5– 0CPGS – P3000	K4	300	30K-1~30K-4	6~8	70
		K5	325			
		K6	350			
		K7	375			
Warm White 2700	ELYI – K22M5– 0CPGS – P2700	K2	250	27K-1~27K-4	6~8	70
		K3	275			
		K4	300			
		K5	325			
	ELYI – K32M5– 0CPGS – P2700	K3	275	27K-1~27K-4	6~8	70
		K4	300			
		K5	325			
		K6	350			

Notes:

1. CRI measurement tolerance: ± 2

Product Binning

Luminous Flux Bins

Group	Bin	Minimum	Maximum
		Photometric Flux (lm)	Photometric Flux (lm)
E	1	4	5
	2	5	6
	3	6	8
	4	8	10
	5	10	13
	6	13	17
	7	17	20
	8	20	23
	9	23	27
F	1	27	33
	2	33	39
	3	39	45
	4	45	52
	5	52	60
	6	60	70
	7	70	80
	8	80	90
	9	90	100

Group	Bin	Minimum	Maximum
		Photometric Flux (lm)	Photometric Flux (lm)
K	1	225	250
	2	250	275
	3	275	300
	4	300	325
	5	325	350
	6	350	375
	7	375	400
	8	400	425
	9	425	450
N	1	450	475
	2	475	500
	3	500	525
	4	525	550
	5	550	575
	6	575	600
	7	600	625
	8	625	650
	9	650	675

Luminous Flux Bins

Group	Bin	Minimum Photometric Flux (lm)	Maximum Photometric Flux (lm)
J	1	100	110
	2	110	120
	3	120	130
	4	130	140
	5	140	150
	6	150	160
	7	160	180
	8	180	200
	9	200	225

Group	Bin	Minimum Photometric Flux (lm)	Maximum Photometric Flux (lm)
P	1	675	700
	2	700	725
	3	725	750
	4	750	775
	5	775	800
	6	800	850
	7	850	900
	8	900	950
	9	950	1000
S	1	1000	1100
	2	1100	1200
	3	1200	1300
	4	1300	1400
	5	1400	1600
	6	1600	1800
	7	1800	2000

Note:

1. Currently available brightness bins for White LEDs are highlighted and bolded.

White Bin Structure

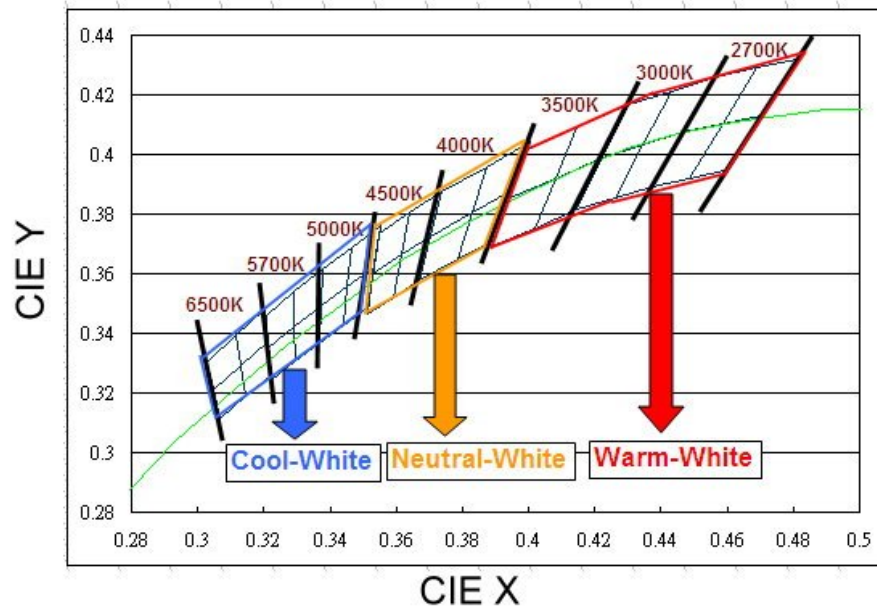

Chromaticity specification defined by ANSI

Notes:

1. The CCT range of Cool-White varies from 4745K to 7050K.
2. The CCT range of Neutral-White varies from 3710K to 4745K.
3. The CCT range of Warm-White varies from 2580K to 3710K
4. Color coordinates measurement allowance : ± 0.01
5. Color bins are defined as $I_F=700\text{mA}$ operation.

Cool-White Bin Structure

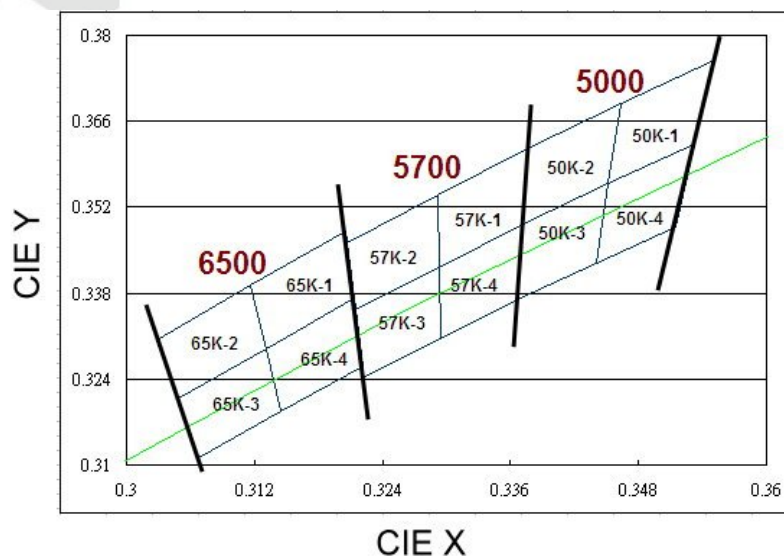

Cool-White Bin Coordinates

5000K

Bin	CIE X	CIE Y
50K-1	0.346	0.369
	0.345	0.356
	0.353	0.362
	0.355	0.376
Reference Range: 4745~5000K		

Bin	CIE X	CIE Y
50K-2	0.338	0.362
	0.337	0.349
	0.345	0.356
	0.346	0.369
Reference Range: 5000~5310K		

Bin	CIE X	CIE Y
50K-4	0.345	0.356
	0.344	0.343
	0.352	0.349
	0.353	0.362
Reference Range: 4745~5000K		

Bin	CIE X	CIE Y
50K-3	0.337	0.349
	0.337	0.337
	0.344	0.343
	0.345	0.356
Reference Range: 5000~5310K		

5700K

Bin	CIE X	CIE Y
57K-1	0.329	0.354
	0.329	0.342
	0.337	0.349
	0.338	0.362
Reference Range: 5310~5700K		

Bin	CIE X	CIE Y
57K-2	0.321	0.346
	0.321	0.335
	0.329	0.342
	0.329	0.354
Reference Range: 5700~6020K		

Bin	CIE X	CIE Y
57K-4	0.329	0.342
	0.329	0.331
	0.337	0.337
	0.337	0.349
Reference Range: 5310~5700K		

Bin	CIE X	CIE Y
57K-3	0.321	0.335
	0.322	0.324
	0.329	0.331
	0.329	0.342
Reference Range: 5700~6020K		

6500K

Bin	CIE X	CIE Y
65K-1	0.312	0.339
	0.313	0.329
	0.321	0.337
	0.321	0.348
Reference Range: 6020~6500K		

Bin	CIE X	CIE Y
65K-2	0.303	0.330
	0.305	0.321
	0.313	0.329
	0.312	0.339
Reference Range: 6500~7050K		

Bin	CIE X	CIE Y
65K-4	0.313	0.329
	0.315	0.319
	0.322	0.326
	0.321	0.337
Reference Range: 6020~6500K		

Bin	CIE X	CIE Y
65K-3	0.305	0.321
	0.307	0.311
	0.315	0.319
	0.313	0.329
Reference Range: 6500~7050K		

Neutral-White Bin Structure

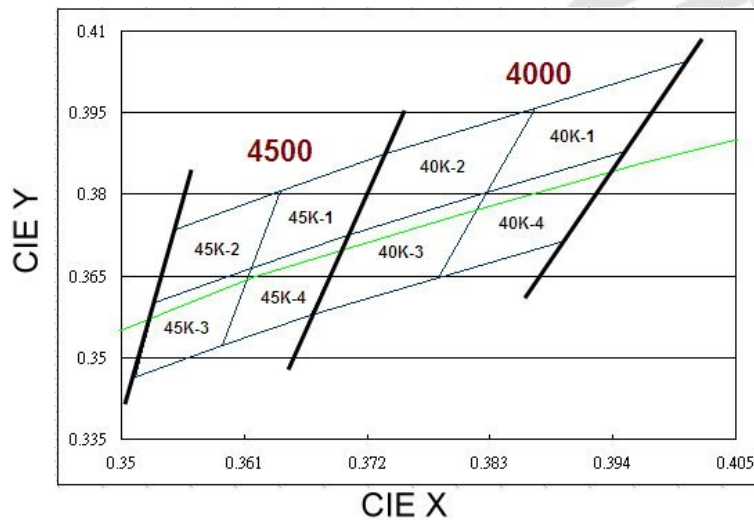

Neutral-White Bin Coordinates

4000K

Bin	CIE X	CIE Y
40K-1	0.387	0.396
	0.383	0.380
	0.395	0.388
	0.401	0.404
Reference Range: 3710~4000K		

Bin	CIE X	CIE Y
40K-2	0.374	0.387
	0.370	0.373
	0.383	0.380
	0.387	0.396
Reference Range: 4000~4260K		

Bin	CIE X	CIE Y
40K-4	0.383	0.380
	0.378	0.365
	0.390	0.372
	0.395	0.388
Reference Range: 3710~4000K		

Bin	CIE X	CIE Y
40K-3	0.370	0.373
	0.367	0.358
	0.378	0.365
	0.383	0.380
Reference Range: 4000~4260K		

4500K

Bin	CIE X	CIE Y
45K-1	0.364	0.381
	0.362	0.366
	0.370	0.373
	0.374	0.387
Reference Range: 4260~4500K		

Bin	CIE X	CIE Y
45K-2	0.355	0.374
	0.353	0.360
	0.362	0.366
	0.364	0.381
Reference Range: 4500~4745K		

Bin	CIE X	CIE Y
45K-4	0.362	0.366
	0.359	0.352
	0.367	0.358
	0.370	0.373
Reference Range: 4260~4500K		

Bin	CIE X	CIE Y
45K-3	0.353	0.360
	0.351	0.347
	0.359	0.352
	0.362	0.366
Reference Range: 4500~4745K		

Warm-White Bin Structure

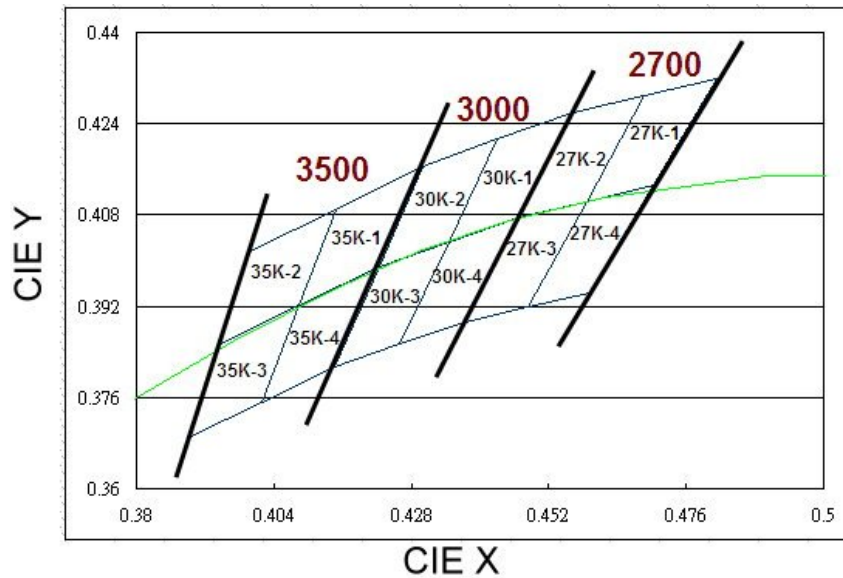

Warm-White Bin Coordinates

2700K

Bin	CIE X	CIE Y
27K-1	0.469	0.429
	0.459	0.410
	0.470	0.413
	0.481	0.432
Reference Range: 2580~2700K		

Bin	CIE X	CIE Y
27K-2	0.456	0.426
	0.447	0.408
	0.459	0.410
	0.469	0.429
Reference Range: 2700~2870K		

Bin	CIE X	CIE Y
27K-4	0.459	0.410
	0.448	0.392
	0.459	0.394
	0.470	0.413
Reference Range: 2580~2700K		

Bin	CIE X	CIE Y
27K-3	0.447	0.408
	0.437	0.389
	0.448	0.392
	0.459	0.410
Reference Range: 2700~2870K		

3000K

Bin	CIE X	CIE Y
30K-1	0.443	0.421
	0.435	0.403
	0.447	0.408
	0.456	0.426
Reference Range: 2870~3000K		

Bin	CIE X	CIE Y
30K-2	0.430	0.417
	0.422	0.399
	0.435	0.403
	0.443	0.421
Reference Range: 3000~3220K		

Bin	CIE X	CIE Y
30K-4	0.435	0.403
	0.426	0.385
	0.437	0.389
	0.447	0.408
Reference Range: 2870~3000K		

Bin	CIE X	CIE Y
30K-3	0.422	0.399
	0.415	0.381
	0.426	0.385
	0.435	0.403
Reference Range: 3000~3220K		

3500K

Bin	CIE X	CIE Y
35K-1	0.415	0.409
	0.408	0.392
	0.422	0.399
	0.430	0.417
Reference Range: 3220~3500K		

Bin	CIE X	CIE Y
35K-2	0.400	0.402
	0.394	0.385
	0.408	0.392
	0.415	0.409
Reference Range: 3500~3710K		

Bin	CIE X	CIE Y
35K-4	0.408	0.392
	0.402	0.375
	0.415	0.381
	0.422	0.399
Reference Range: 3220~3500K		

Bin	CIE X	CIE Y
35K-3	0.394	0.385
	0.389	0.369
	0.402	0.375
	0.408	0.392
Reference Range: 3500~3710K		

Forward Voltage Bins

Group Name	Bins
N	O4+O5+O6
O	O5+O6+O7
P	O4+O5+O6+O7
Q	O7+R1+R2
R	R1+R2+R3
S	R2+R3
T	R2+R3+R4

Bin	Minimum Forward Voltage (V)	Maximum Forward Voltage (V)
O1	4.5	5.0
O2	5.0	5.5
O3	5.5	6.0
O4	6.0	6.5
O5	6.5	7.0
O6	7.0	7.5
O7	7.5	8.0
R1	8.0	9.0
R2	9.0	10.0
R3	10.0	11.0
R4	11.0	12.0

Notes:

1. Forward voltage measurement tolerance: $\pm 0.1V$.
2. Forward voltage bins are defined as $I_F=700$ mA operation.
3. Currently available Forward Voltage bins for White LEDs are highlighted and bolded.
4. Other Forward Voltage bins for White LEDs available upon request. Please contact your local Everlight sales office.

Optical Characteristics

Color	Part Number	Color Temperature CCT			Typical Viewing Angle (degrees) $2\theta_{1/2}$
		Min.	Typ.	Max.	
Cool-White	ELYI – XX2C5-0LPGS	4745K	5700K	7050K	105
Neutral-White	ELYI – XX2N5-0LPGS	3710K	4260K	4745K	105
Warm-White	ELYI – XX2M5-0LPGS	2580K	3000K	3710K	105
Cool-White	ELYI – XX2C5-0CPGS	4745K	5700K	7050K	90
Neutral-White	ELYI – XX2N5-0CPGS	3710K	4260K	4745K	90
Warm-White	ELYI – XX2M5-0CPGS	2580K	3000K	3710K	90

Notes:

1. The test tolerance of Everlight is $\pm 5\%$ for CCT.
2. Viewing angle is the width of half the light output intensity in all directions of 180° .
3. All Cool-White, Neutral-White, Warm-White LEDs are made with Indium Gallium Nitride (InGaN).

Mechanical Dimension

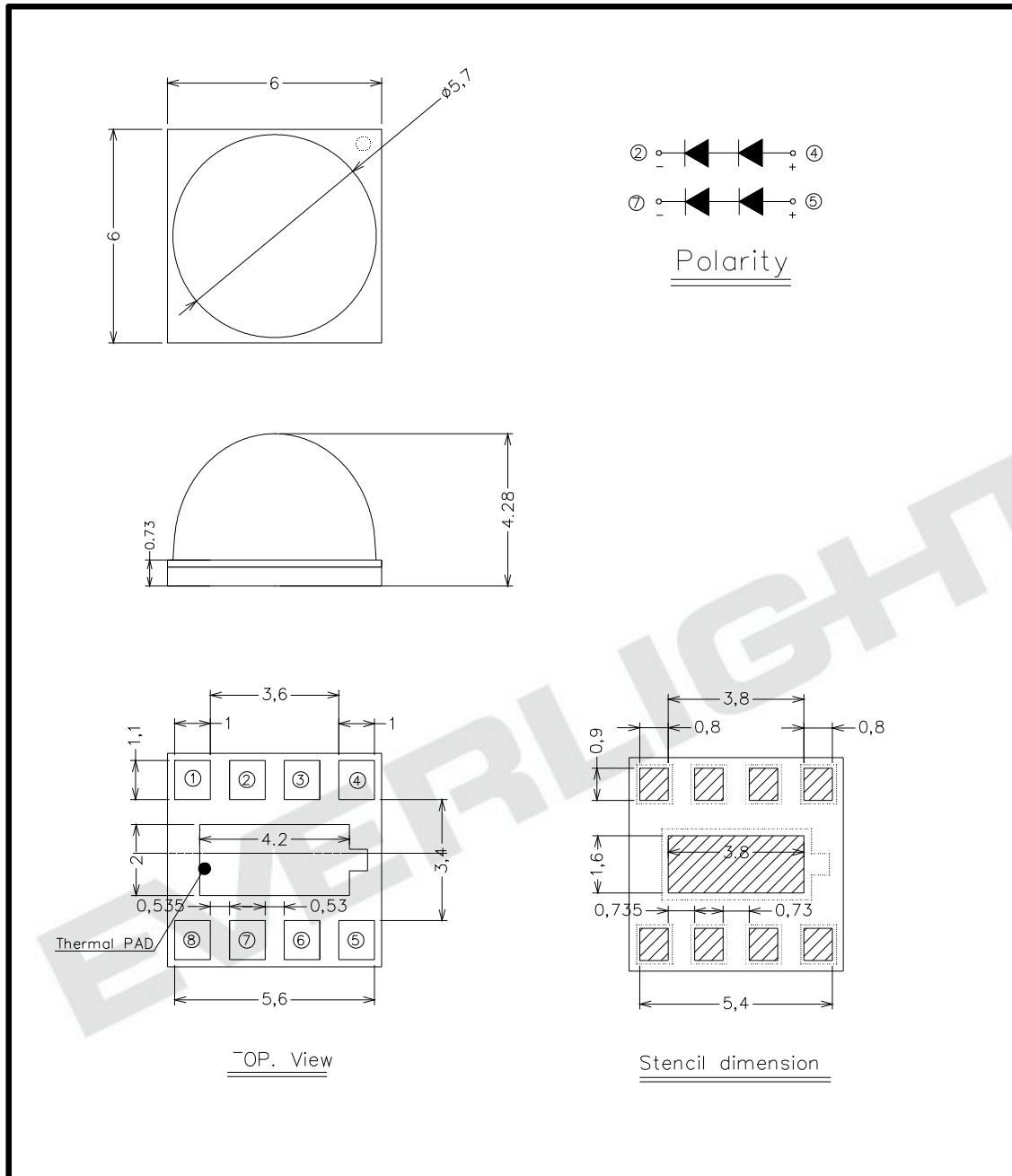

Notes:

1. Dimensions are in millimeters.
2. Tolerances unless mentioned are $\pm 0.15\text{mm}$.
3. Do not handle the device by the lens. Incorrect force applied to the lens may lead to the failure of devices.
4. The thermal pad is electrically isolated from the Anode and Cathode contact pads.

Pad Configuration

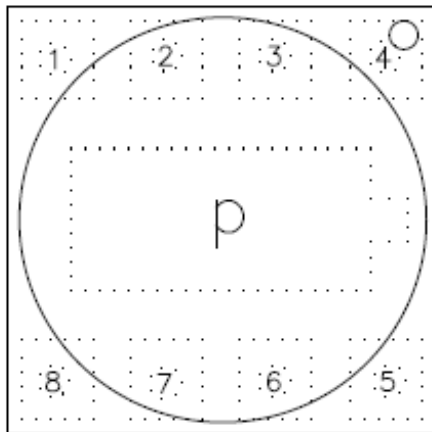

Top view

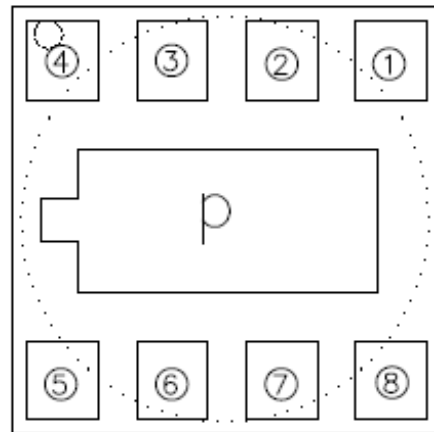

Bottom view

PAD	FUNCTION
4 and 5	ANODE
2 and 7	CATHODE
1,3,6 and 8	[1]
P	THERMAL PAD[2]

Notes:

1. No designing and soldering any electrical circuit
2. The thermal pad is electrically isolated from the cathode and anode contact pads.

Reflow Soldering Characteristics

For Reflow Process

- ELYI series are suitable for SMT processes.
- Curing of glue in oven must be according to standard operation flow processes.

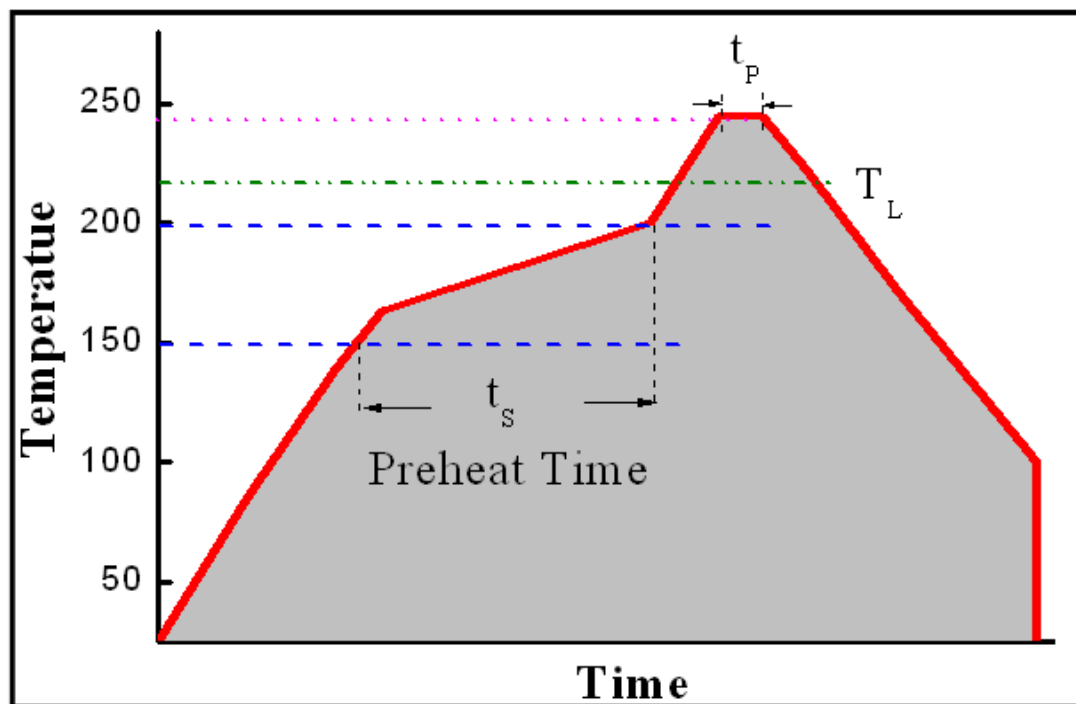

Profile Feature	Lead Free Assembly
Ramp-Up Rate	2-3 °C/S
Preheat Temperature	150-200 °C
Preheat Time (t_s)	60-120 S
Liquid Temperature (T_L)	217 °C
Time maintained above T_L	60-90 S
Peak Temperature (T_P)	240±5 °C
Peak Time (t_p)	Max 20 S
Ramp-Down Rate	3-5 °C/S

- Reflow soldering should not be done more than twice.
- In soldering process, stress on the LEDs during heating should be avoided.
- After soldering, do not bend the circuit board.

Wavelength Characteristics

For Cool-White, @ Thermal Pad Temperature = 25°C

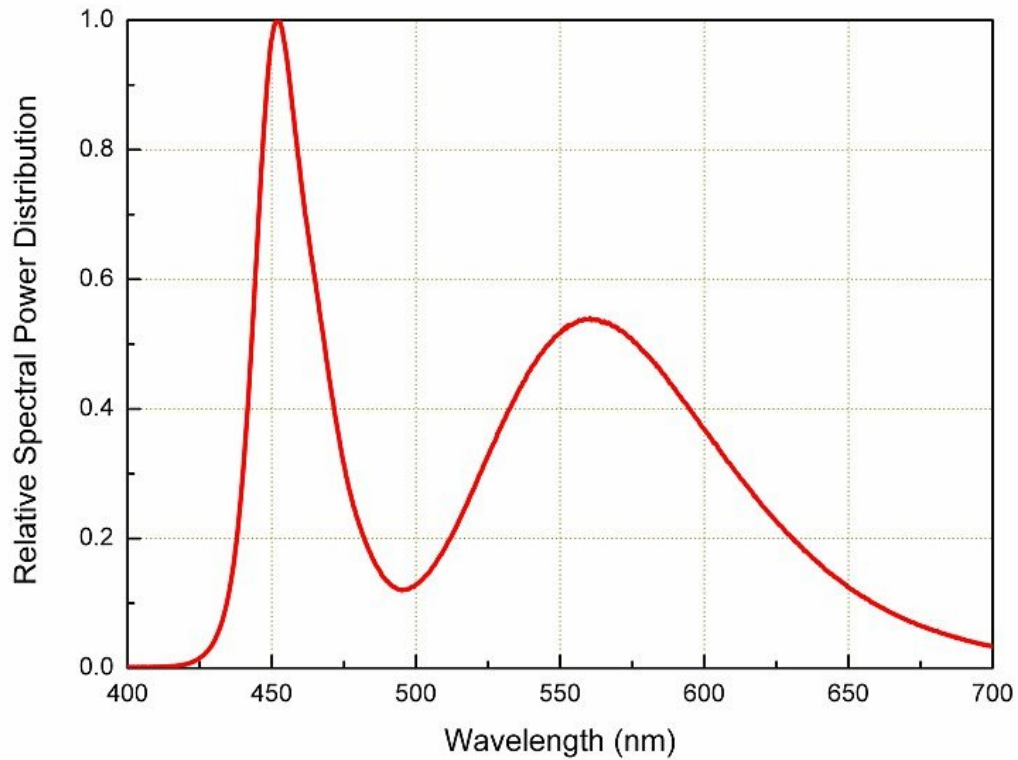

For Neutral-White, @ Thermal Pad Temperature = 25°C

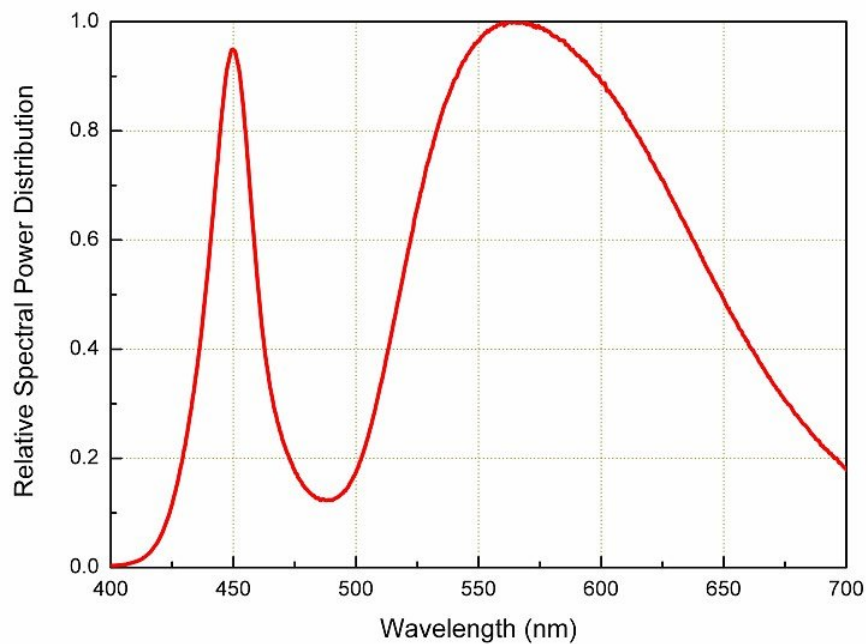

For Warm-White, @ Thermal Pad Temperature = 25°C

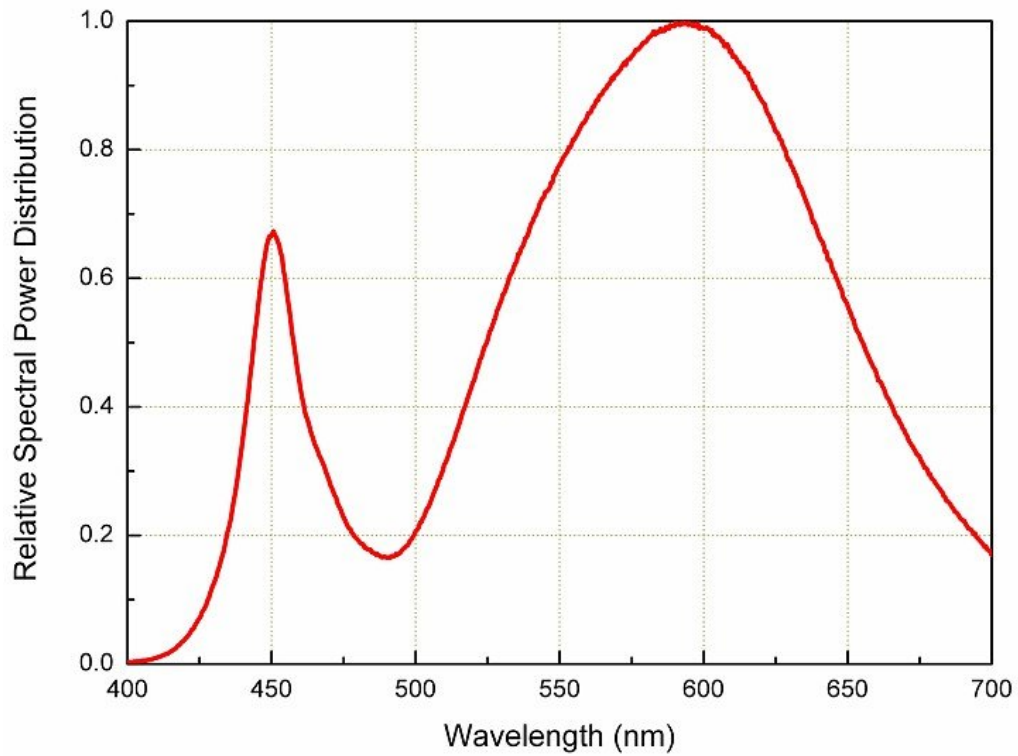

Typical Light Output Characteristic vs. Thermal Pad Temperature

Cool-White, Neutral-White, Warm-White for 700mA Drive Current

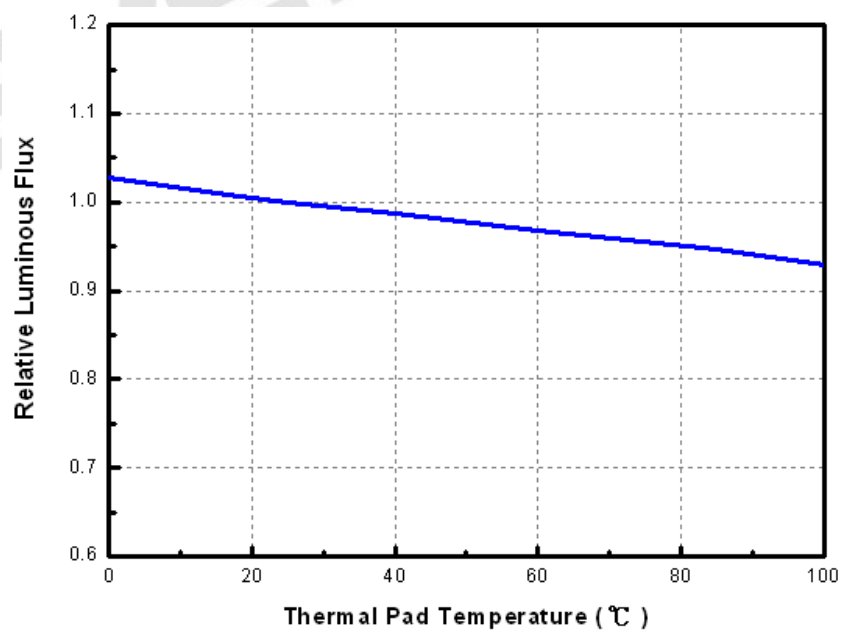

Typical Electrical Characteristics

For Cool-White, Neutral-White, Warm-White
@ Thermal Pad Temperature = 25°C

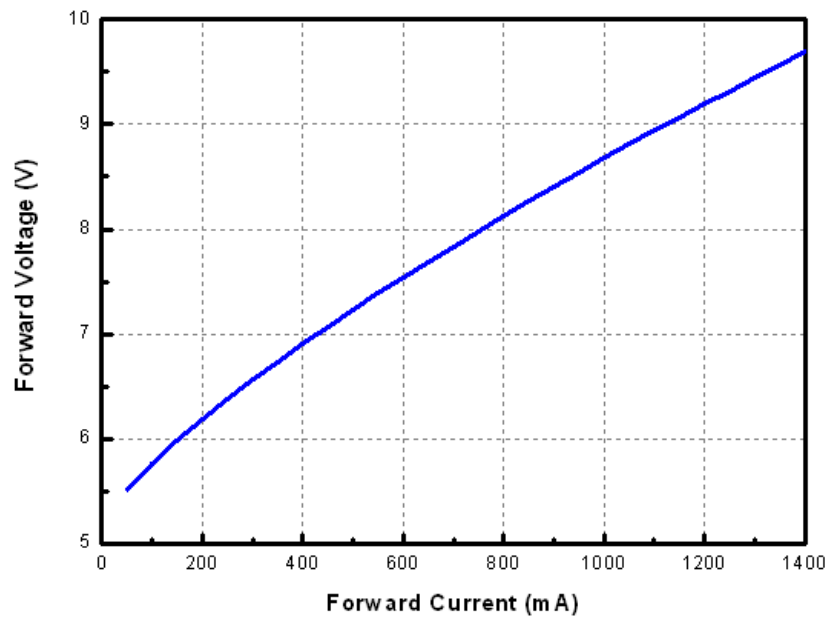

Typical Relative Luminous Flux vs. Forward Current

For Cool-White, Neutral-White, Warm-White
@ Thermal Pad Temperature = 25°C

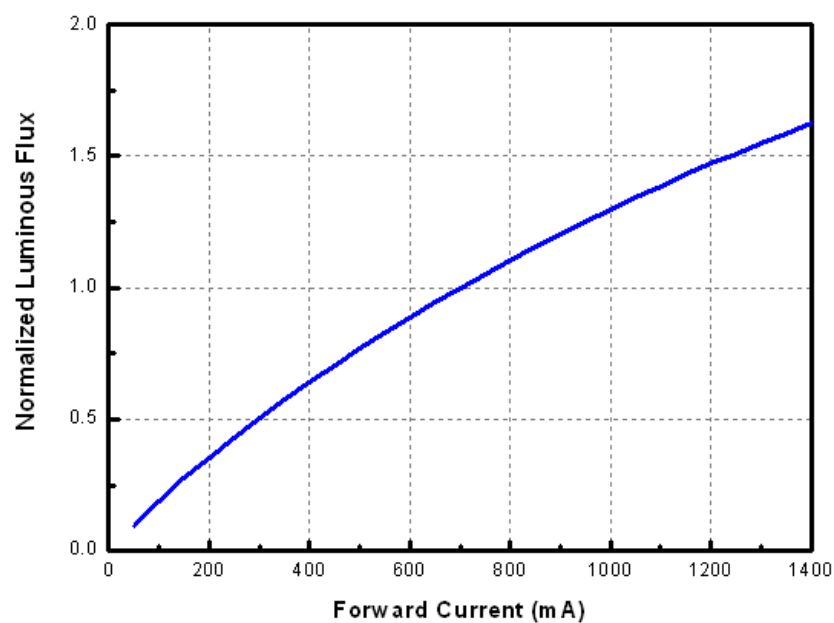

Typical CCT Shift Characteristics vs. Forward Current

For Cool-White @ Thermal Pad Temperature = 25°C

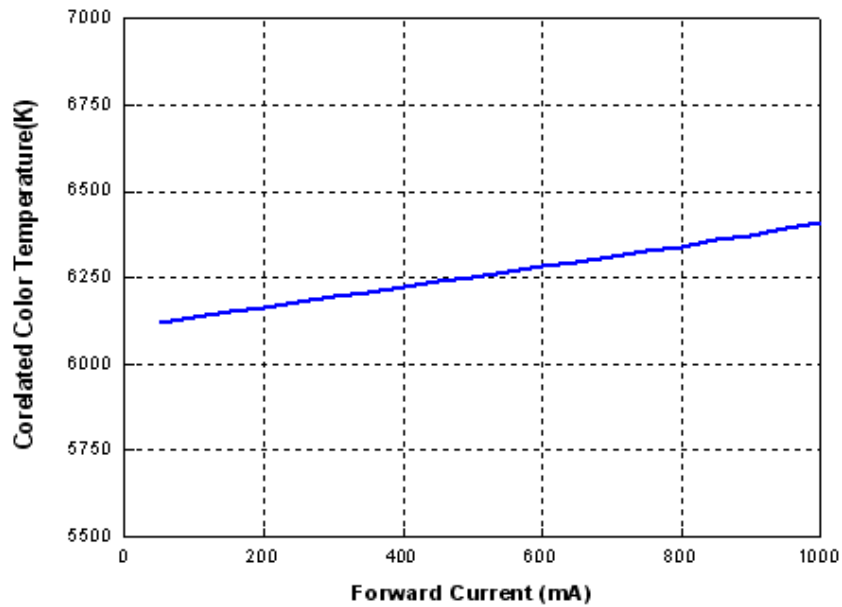

For Neutral -White @ Thermal Pad Temperature = 25°C

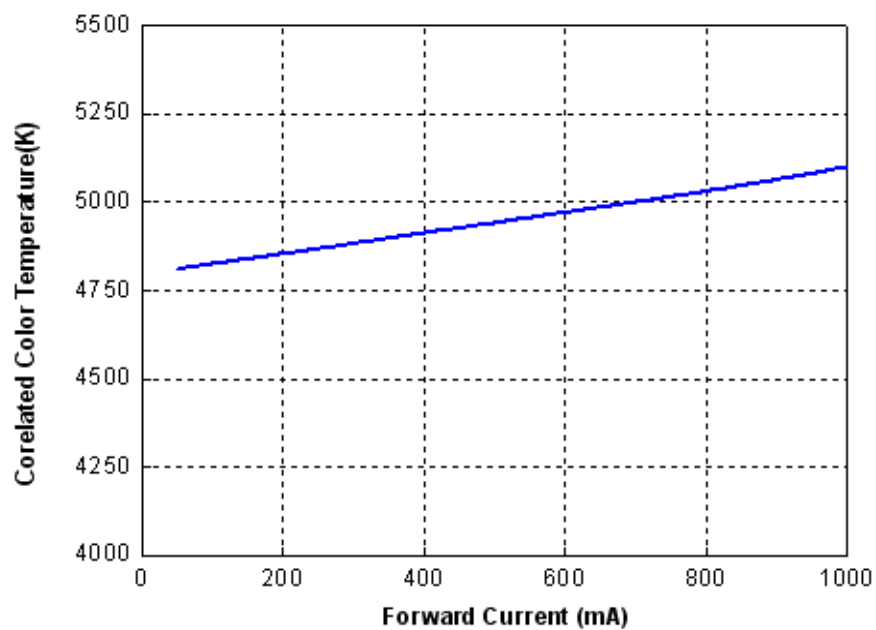

For Warm-White @ Thermal Pad Temperature = 25°C

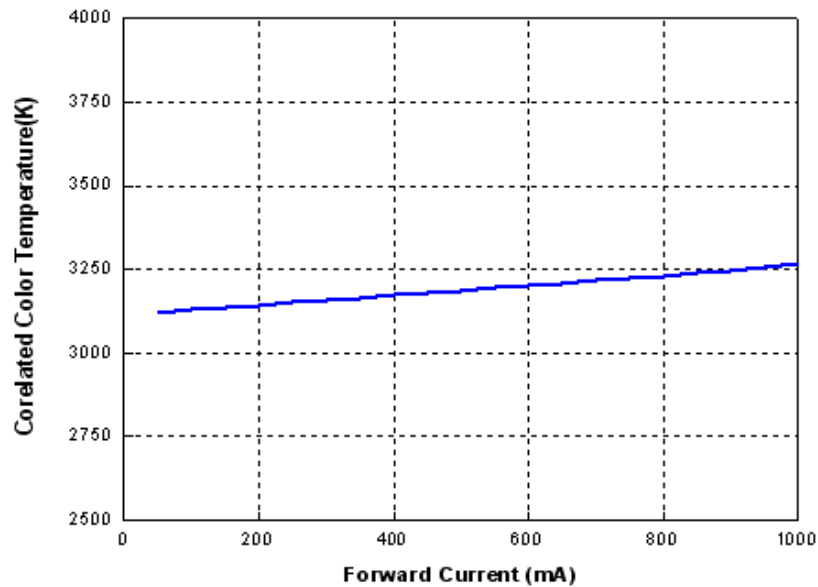

Current Derating Curves

Current Derating Curve for 800mA Drive Current
Cool-White, Neutral-White, Warm-White

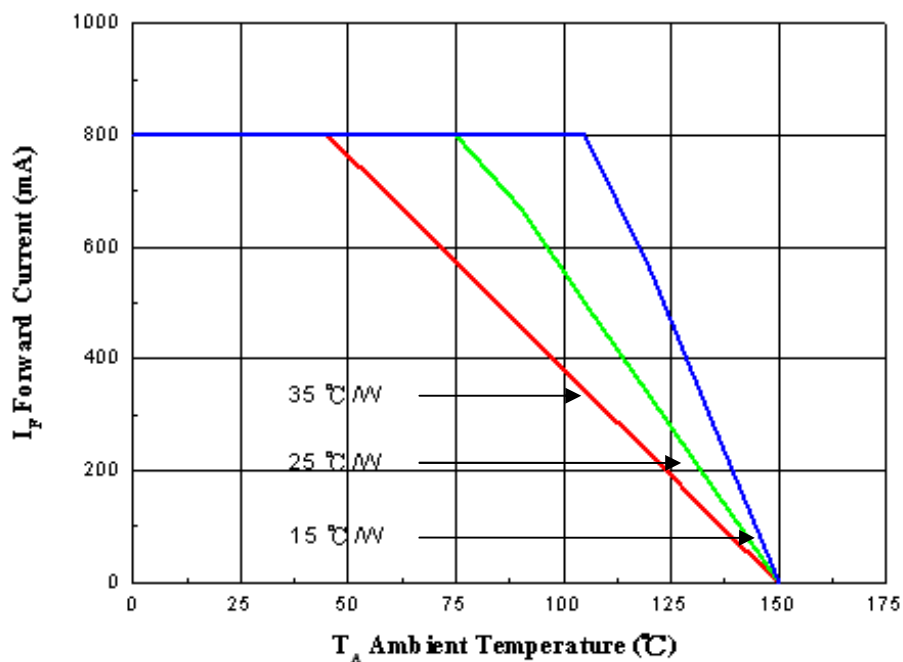

Typical Radiation Patterns

Typical Spatial and Polar Radiation Pattern for Cool-White,
Neutral-White, Warm-White
(For ELYI-KXXX5-0LXXX-XXXXX)

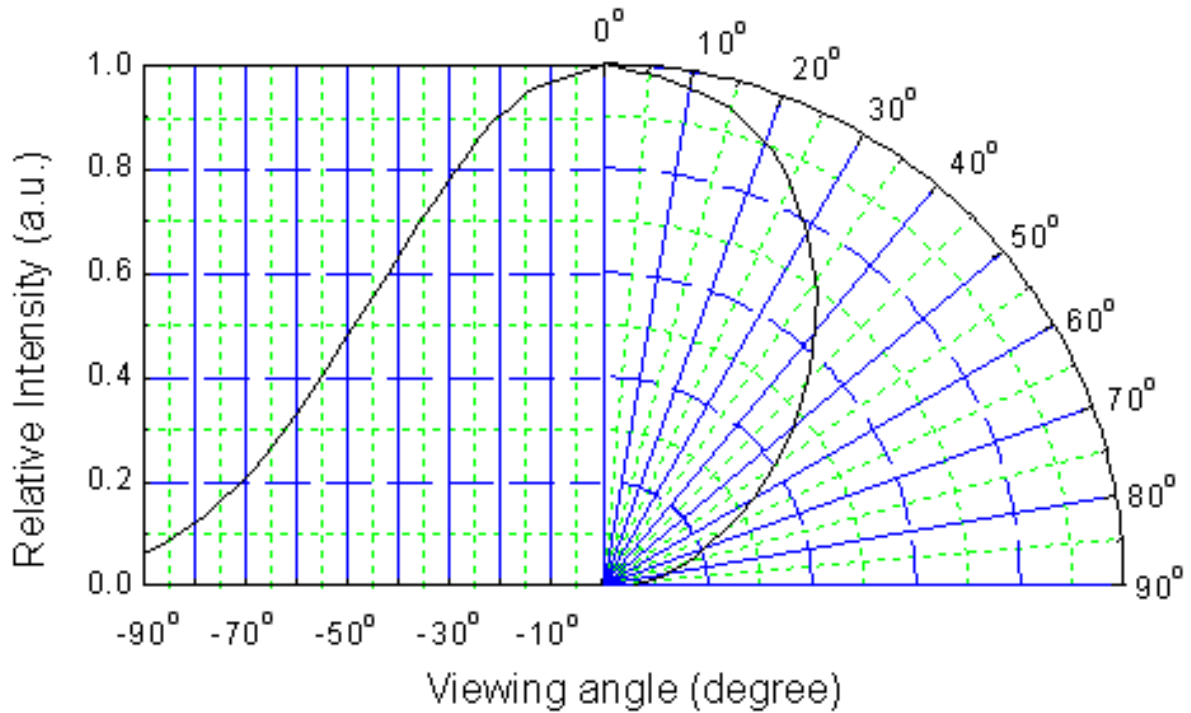

Notes:

1. $2\theta_{1/2}$ is the off axis angle from lamp centerline where the luminous intensity is 1/2 of the peak value.
2. View angle tolerance is $\pm 10^\circ$.

Typical Difference of CIE X of Cool-White versus Angle (For ELYI-KXXX5-0LXXX-XXXXX)

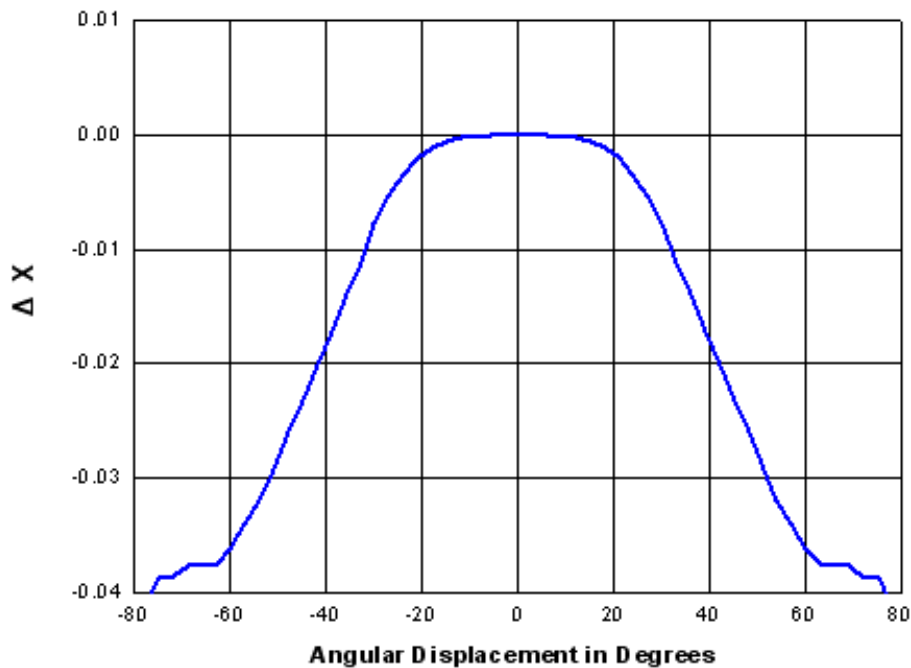

Typical Difference of CIE Y of Cool-White versus Angle (For ELYI-KXXX5-0LXXX-XXXXX)

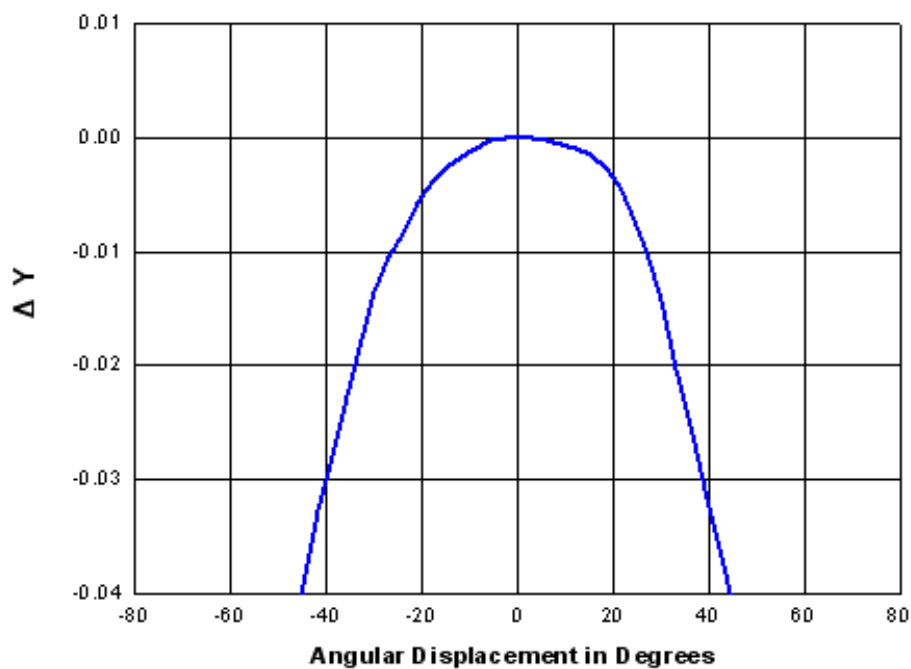

Typical Radiation Patterns

Typical Spatial and Polar Radiation Pattern for Cool-White,
Neutral-White, Warm-White
(For ELYI-KXXX5-0CXXX-XXXXX)

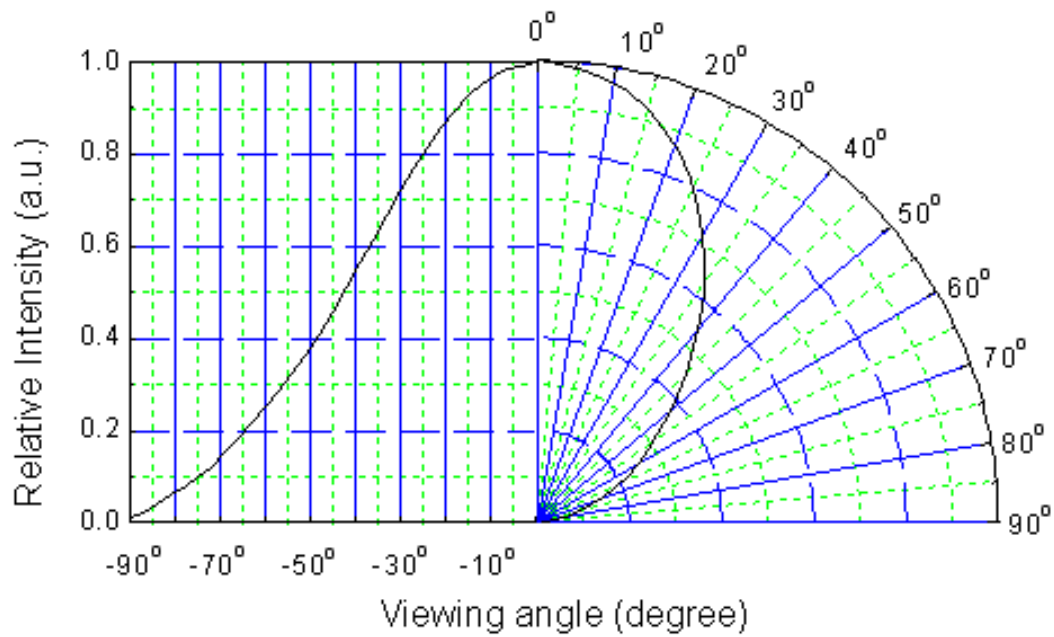

Notes:

3. $2\theta_{1/2}$ is the off axis angle from lamp centerline where the luminous intensity is 1/2 of the peak value.
4. View angle tolerance is $\pm 10^\circ$.

Typical Difference of CIE X of Cool-White versus Angle (For ELYI-KXXX5-0CXXX-XXXXX)

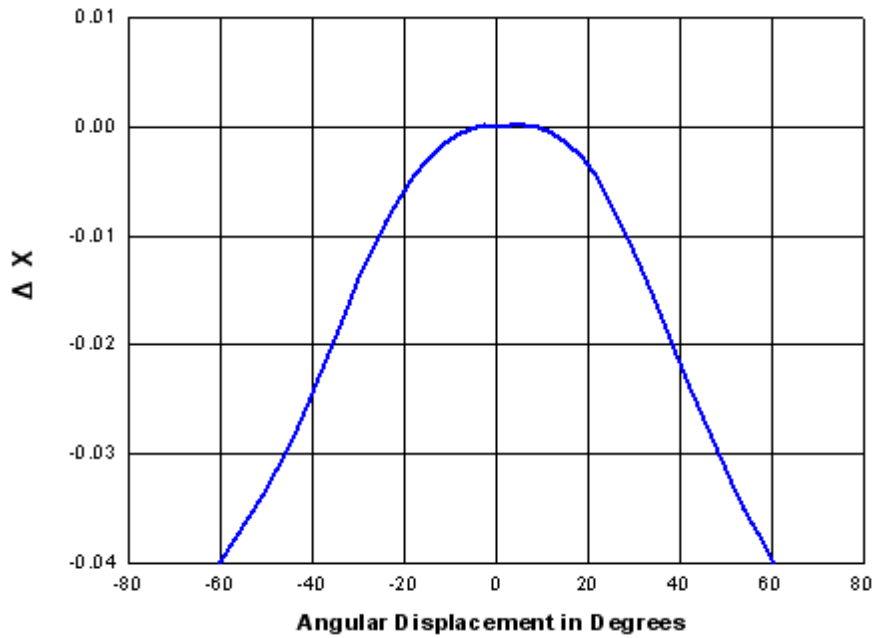

Typical Difference of CIE Y of Cool-White versus Angle (For ELYI-KXXX5-0CXXX-XXXXX)

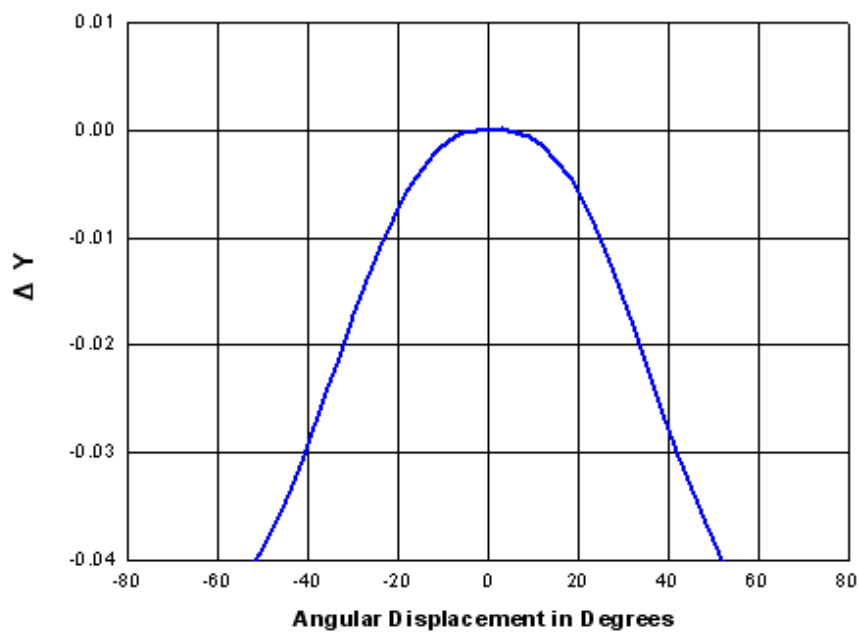

Emitter Tape Packaging

Carrier Tape Dimensions As The Below :

If order quantity is $\geq 1K$, the minimum packing quantity is not less than 250pcs per reel

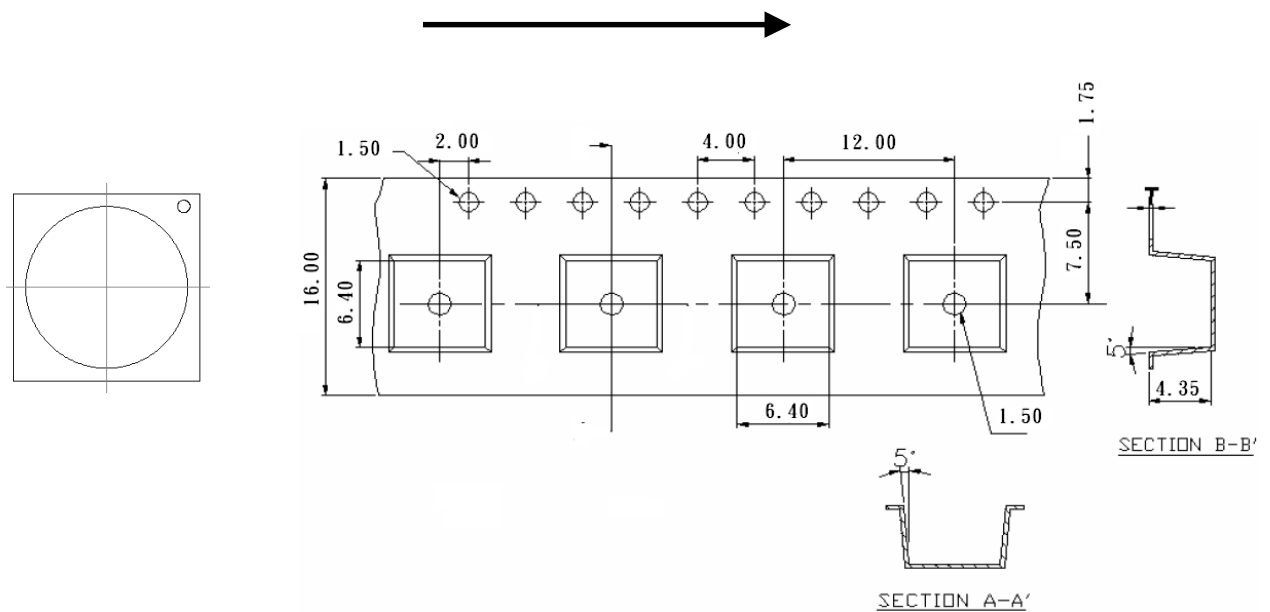

Notes:

1. Dimensions are in millimeters.
2. Tolerances for fixed dimensions are ± 0.1 mm.

Moisture Resistant Packaging

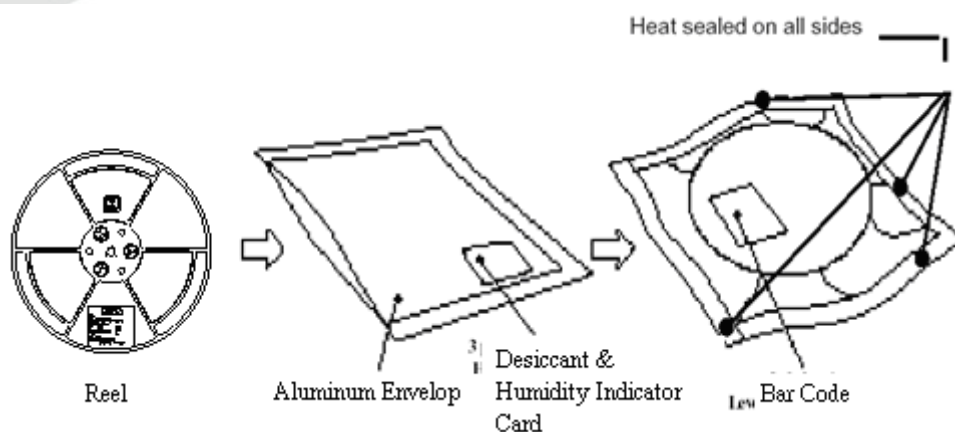

Emitter Reel Packaging

Reel Dimensions

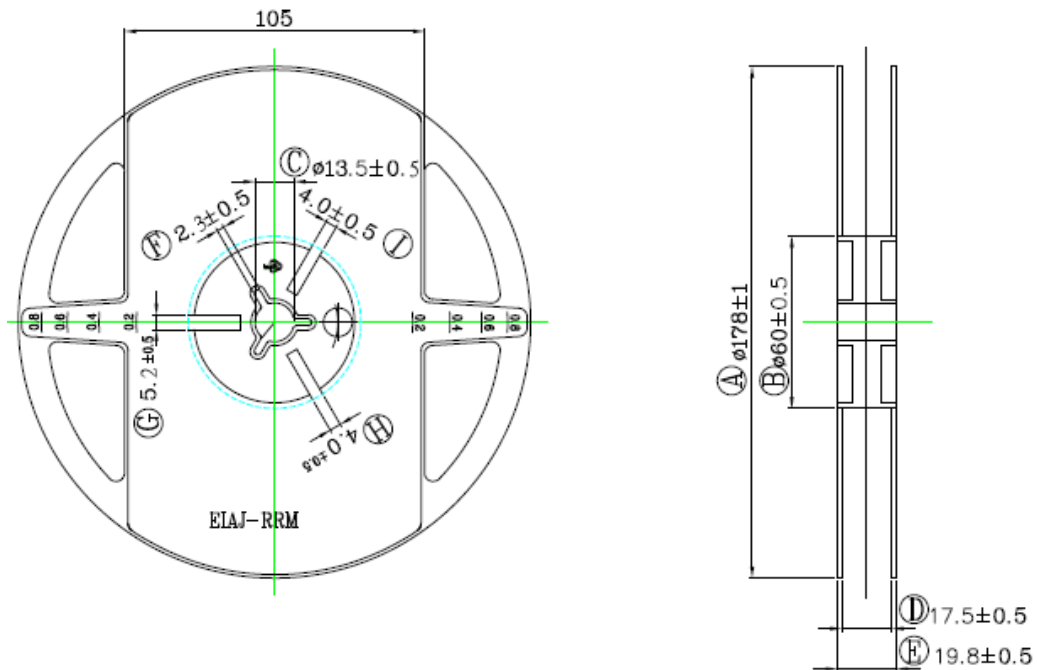

Notes:

1. Dimensions are in millimeters.
2. Tolerances unless mentioned are ± 0.1 mm.

Product Labeling

Label Explanation



CPN: Customer Specification (when required)

P/N: Everlight Production Number

QTY: Packing Quantity

CAT: Luminous Flux (Brightness) Bin

HUE: Color Bin

REF: Forward Voltage Bin

LOT No: Lot Number

MADE IN TAIWAN: Production Place

EVERLIGHT

Storage Conditions

- Before the package is opened. The LEDs should be stored at 30°C or less and 85%RH or less after being shipped from Everlight and the storage life limits are 1 year. If the LEDs are stored for 1 year or more, they can be stored for 3 years in a sealed container with a nitrogen atmosphere and moisture absorbent material.
- After opening the package: The LED's floor life is 1 year under 30°C or less and 60%RH or less. The LED should be soldered with 168hrs (7days) after opening the package. If unused LEDs remain, it should be stored in moisture proof packages.
- If the moisture absorbent material (silica gel) has faded away or the LEDs have exceeded the storage time, baking treatment should be performed using the following conditions. Baking treatment: 60±5°C for 24 hours.

EVERLIGHT

Revision History

Current version: **10/27/2011**

Previous version: N/A

Device No. DHE-0001157

Rev. Ver. 10

Page	Subjects (major change in previous version)	Date of change
14	In the mechanical dimension, the polarity is changed.	05/30/2010
23	In the emitter tape packaging, the polarity is changed.	05/30/2010
14	In the mechanical dimension, the polarity is changed.	06/04/2010
15	In the pad configuration, the polarity is changed.	06/04/2010
3	In the product nomenclature, the designation is changed.	08/27/2010
4	In the absolute maximum ratings, the parameter is changed.	08/27/2010
23	In the emitter tape packaging, the diagram is changed.	08/27/2010
5	In the product nomenclature, the designation is changed.	04/08/2011
14	In the product mechanical dimension, the diagram is changed.	06/03/2011
10	Addition to PN of The Yi High Luminous Series.	08/02/2011
35	Carrier Tape Dimensions.	08/02/2011
33-34	Increased (For ELYI-KXXX5-0LXXX-XXXXX)	08/18/2011
35-36	Increased (For ELYI-KXXX5-0CXXX-XXXXX)	08/18/2011
5-10	Increased * Product lead-time of at least 8 weeks and *product	09/15/2011
19	Modified 65K-4 & 65K-3 CIE-X is 0314 changed of 0.315	10/06/2011
25	Modified Mechanical Dimension of the tolerances unless mentioned are $\pm 0.15\text{mm}$	10/27/2011
37	Modified of Emitter Tape Packaging	10/27/2011