



# MOP-TFT800480-50A-BLM-TPN

---

Hardware Manual

Revision 1.0

## Revision History

Revision	Date	Description	Author
1.0	May 26, 2017	Initial Release	Divino



# Contents

- Revision History .....1
- Contents .....2
- 1 General Information .....3
- 2 Absolute Maximum Ratings.....3
- 3 Electrical Characteristics.....3
- 4 Backlight Characteristics.....3
- 5 External Dimensions .....4
- 6 Electro-Optical Characteristics .....5
- 7 Interface Description .....6
  - 7.1 TFT Module Interface Description .....6
- 8 AC Characteristics .....7
  - 8.1 Pixel Timing.....7
  - 8.2 Data Timing.....8
- 9 Power Sequence .....10
  - 9.1 Power Up Sequence .....10
- 10 Inspection Criterion .....11
  - 10.1 Description .....11
  - 10.2 Sampling Plan and Reference Standards .....11
  - 10.3 Inspection condition .....11
  - 10.4 Definition of Inspection Zone in LCD .....11
  - 10.5 Function Defect .....12
  - 10.6 LCD Pixel Defect .....12
  - 10.7 Dot and line defect .....13
- 11 Handling Precautions.....14
  - 11.1 Mounting method .....14
  - 11.2 LCD Handling and Cleaning Precaution .....14
  - 11.3 Static Charge Precaution .....14
  - 11.4 Packing.....14
  - 11.5 Precautions during Operation .....14
  - 11.6 Storage Recommendations .....15
  - 11.7 Safety Precautions .....15
- 12 Ordering .....16
  - 12.1 Part Numbering Scheme.....16
  - 12.2 Options .....16
- 13 Contact .....16



## 1 General Information

No.	Item	Contents	Unit
1	LCD size	5.0 inch (Diagonal)	/
2	LCD type	TN/Normally white/Transmissive(Anti-glare)	/
3	Viewing direction(eye)	12 O'clock	/
4	Gray scale inversion direction	6 O'clock	/
5	Resolution(H*V)	800 *480 Pixels	/
6	Module size (L*W*H)	120.70*75.80*2.8	mm
7	Active area (L*W)	108.00*64.80	mm
8	Pixel pitch (L*W)	0.135*0.135	mm
9	Interface type	RGB interface	/
10	Module power consumption	1.297(with backlight)	W
11	Back light type	LED	/
12	Driver IC	ILI6122+ILI5960 OR COMPATIBLE	/
13	Weight	56.1	g

## 2 Absolute Maximum Ratings

Item	Symbol	Min.	Max.	Unit
Power supply input voltage(TFT Module)	VDD	-0.3	5.0	V
Backlight current (normal temp.)	ILED	-	50	mA
Operation temperature	Top	-20	70	°C
Storage temperature	Tst	-30	80	°C
Humidity	RH	-	90%(Max60 °C)	RH

## 3 Electrical Characteristics

### DC Characteristics (at Ta=25 °C)

Item	Symbol	Min.	Typ.	Max.	Unit
Power supply input voltage(TFT Module)	VDD	3.0	3.3	3.6	V
I/O logic voltage	VDDIO	N/A	N/A	N/A	V
Input voltage 'H' level	VIH	0.7VDDI	-	VDDI	V
Input voltage 'L' level	VIL	VSS	-	0.3VDDI	V
Power supply current	IVDD	-	131.6	-	mA
TFT gate on voltage	VGH	-	N/A	-	V
TFT gate off voltage	VGL	-	N/A	-	V
Analog power supply voltage	AVDD	-	N/A	-	V
Differential input common mode voltage	Vcom	-	N/A	-	V

## 4 Backlight Characteristics

(at Ta=25 °C, RH=60%)

Item	Symbol	Min.	Typ.	Max.	Unit	Note
LED forward voltage	VF	-	18.6	19.8	V	IF=20*2mA
LED forward current	IF	-	40	-	mA	
LED power consumption	PLED	-	0.744	-	W	Note1
Number of LED	-		12		PCS	
Connection mode	-	6 in series, 2 in parallel			/	
LED life-time	-	20000	-	-	Hrs	Note2

**\*Note:** Calculate Value for reference  $IF \times VF = PLED$

**\*\*Note:** The LED Life-time is defined as the estimated time to 50% degradation of initial brightness at Ta=25°C and IF =40mA. The LED lifetime could be decreased if operating IF is larger than 40mA, and increased if IF is less than 40mA.



# 5 External Dimensions

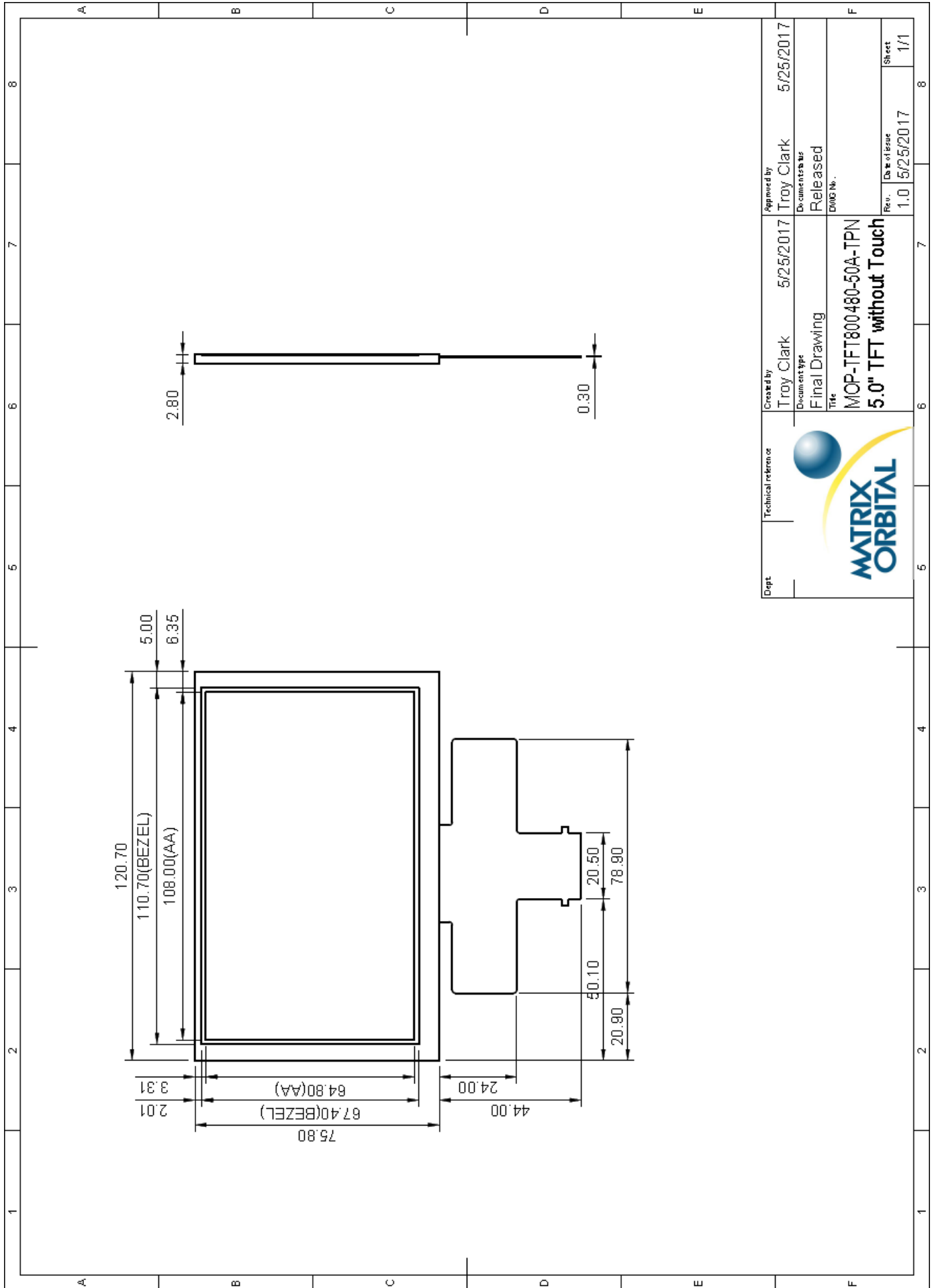

Figure 1: MOP-TFT800480-50A-BLM-TPN Drawing



## 6 Electro-Optical Characteristics

Item	Symbol	Condition	Min.	Typ.	Max.	Unit	Remark	Note
Response time	Tr+ Tf	-	-	25	50	ms	FIG.1	Note 4
Contrast ratio	Cr		400	500	-	-	FIG.2	Note 1
Surface luminance	Lv	$\theta=0^\circ$	380	480	-	cd/m <sup>2</sup>	FIG.2	Note 2
Luminance uniformity	Yu	$\theta=0^\circ$	75	80	-	%	FIG.2	Note 3
NTSC	-	$\theta=0^\circ$	-	50	-	%	FIG.2	Note 5
Viewing angle	$\theta$	$\varnothing=90^\circ$	60	70	-	deg	FIG.3	Note 6
		$\varnothing=270^\circ$	40	50	-	deg	FIG.3	
		$\varnothing=0^\circ$	60	70	-	deg	FIG.3	
		$\varnothing=180^\circ$	60	70	-	deg	FIG.3	
CIE (x,y) chromaticity	Red x	$\theta=0^\circ$ $\varnothing=0^\circ$ Ta=25°C	0.5212	0.5612	0.6012	-	FIG.2 CIE1931	Note 5
	Red y		0.2959	0.3359	0.3759	-		
	Green x		0.3055	0.3455	0.3855	-		
	Green y		0.5450	0.5850	0.6250	-		
	Blue x		0.1090	0.1490	0.1890	-		
	Blue y		0.4833	0.5233	0.5633	-		
	White x		0.2730	0.3130	0.3530	-		
	White y		0.2969	0.3369	0.3769	-		

**\*Note 1:** Definition of contrast ratio

Contrast Ratio (CR) is defined mathematically by the following formula.

$$\text{CONTRAST RATIO} = \frac{\text{Luminance measured when LCD on the "White" State}}{\text{Luminance measured when LCD on the "Black" State}}$$

Measured at the center area of the LCD

**\*Note 2:** Definition of surface luminance

Surface luminance is the LCD luminance from the surface with all pixels displaying white.

$$L_v = \text{Average Surface Luminance with all white pixels (P1, P2, P3 ... Pn)}$$

**\*Note 3:** Definition of luminance uniformity

The luminance uniformity in surface luminance (Yu) is determined by measuring luminance at each test position 1 through n, and then dividing the maximum luminance of n point's luminance by minimum luminance of n points luminance.

$$Y_u = \frac{\text{Minimum Surface Luminance with all white pixels (P1, P2, P3 ... Pn)}}{\text{Maximum Surface Luminance with all white pixels (P1, P2, P3 ... Pn)}}$$

**\*Note 4:** Definition of Response time

The response time is defined as the LCD optical switching time interval between "White" state and "Black" state. Rise time (TON) is the time between photo detector output intensity changed from 90% to 10%. And fall time (TOFF) is the time between photo detector output intensity changed from 10% to 90%.

**\*Note 5:** Definition of color chromaticity (CIE1931)

CIE (x, y) chromaticity, the x, y value is determined by screen active area center position P5.

**\*Note 6:** Definition of Viewing angle.

Viewing angle is the angle at which the contrast ratio is greater than 10. The angles are determined for the horizontal or x axis and the vertical or y axis with respect to the z axis which is normal to the LCD surface.

For Viewing angle and response time testing, the testing data is based on Autronic-Melchers's ConoScope or DMS series Instruments or compatible. For contrast ratio, Surface Luminance, Luminance uniformity and CIE, the testing data is based on TOPCON's BM-7 or BM-5 photo detector or compatible.

**\*Note 7:** For TFT module, Gray scale reverse occurs in the direction of panel viewing angle.



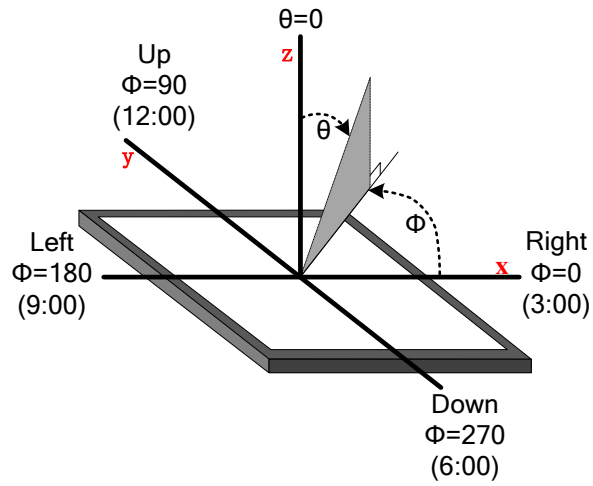

Figure 2: The definition of viewing angle

## 7 Interface Description

### 7.1 TFT Module Interface Description

Interface No.	Name	I/O or connect to	Description
1	LEDK	P	Power for LED backlight(Cathode)
2	LEDA	P	Power for LED backlight(Anode)
3	CS(NC)	/	No connection
4	VDD	P	Power for LCD
5-12	Red(0-7)	I	Red data signal
13-20	Green(0-7)	I	Green data signal
21-28	Blue(0-7)	I	Blue data signal
29	GND	I	Ground
30	DCLK	I	Dot clock signal
31	DISP	I	Display on/off
32	HSYNC	I	Horizontal sync input.
33	VSYNC	I	Vertical sync input
34	DE	I	Data enable
35	SCL(NC)	/	No connection
36	SDA(NC)	/	No connection
37	XR(NC)	/	No connection
38	YD(NC)	/	No connection
39	XL(NC)	/	No connection
40	YU(NC)	/	No connection

# 8 AC Characteristics

## 8.1 Pixel Timing

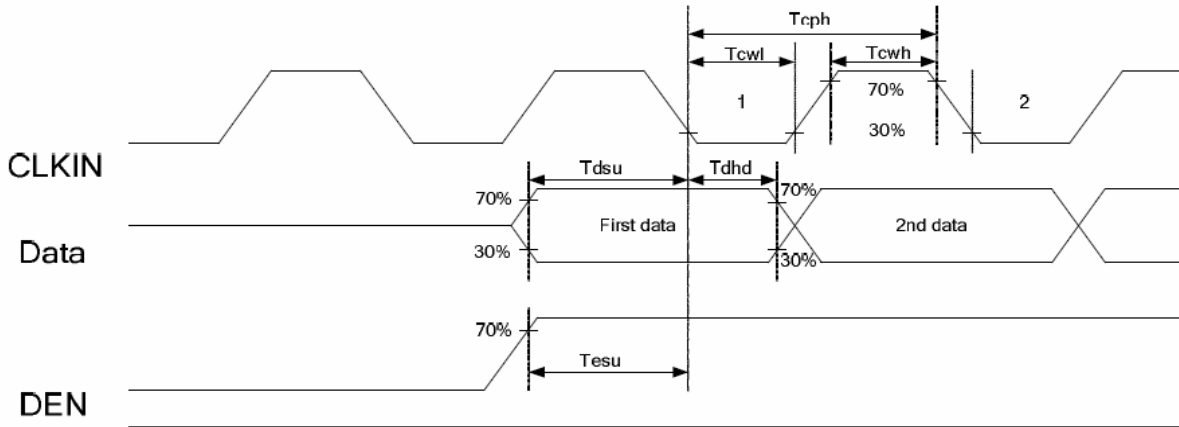

Figure 3: Pixel Timing

Parameter	Symbol	Spec.			Unit	Conditions
		Min.	Typ.	Max.		
VDD Power ON slew rate	$t_{POR}$	-	-	20	ms	$0v \sim 0.9VDD$
RSTB pulse width	$t_{RST}$	10	-	-	$\mu s$	CLKIN =50MHz
CLKIN cycle time	$t_{CPH}$	20	-	-	ns	
CLKIN pulse duty	$t_{CWH}$	40	50	60	%	
VSD setup time	$t_{VST}$	8	-	-	ns	
VSD hold time	$t_{VHD}$	8	-	-	ns	
HSD setup time	$t_{HST}$	8	-	-	ns	
HSD hold time	$t_{HHD}$	8	-	-	ns	
Data setup time	$t_{DST}$	8	-	-	ns	D0[7:0], D1[7:0], D2[7:0] to CLKIN
Data hold time	$t_{DHD}$	8	-	-	ns	D0[7:0], D1[7:0], D2[7:0] to CLKIN
DE setup time	$t_{EST}$	8	-	-	ns	
DE hold time	$t_{EHD}$	8	-	-	ns	
Output stable time	$t_{SST}$	-	-	6	$\mu s$	10% to 90% target voltage. CL=120pf, R=10k $\Omega$
CLKIN frequency	$f_{CLK}$	-	40	50	MHz	VDD=3.0~3.6V
CLKIN cycle time	$t_{CLK}$	20	25	-	ns	
CLKIN pulse duty	$t_{CWH}$	40	50	60	%	$T_{CLK}$
Time from HSD to source output	$t_{HSO}$	-	20	-	CLKIN	
Time from HSD to LD	$t_{HLD}$	-	20	-	CLKIN	**Note
Time from HSD to STV	$t_{HSTV}$	-	2	-	CLKIN	
Time from HSD to CKV	$t_{HCKV}$	-	20	-	CLKIN	
Time from HSD to OEV	$t_{HOEV}$	-	4	-	CLKIN	
LD pulse width	$t_{WLD}$	-	10	-	CLKIN	**Note
CKV pulse width	$t_{WCKV}$	-	66	-	CLKIN	
OEV pulse width	$t_{WOEV}$	-	74	-	CLKIN	

**\*Note:** VDD=3.0~3.6V, VDDA=6.5~13.5V, DGND=AGND=0V, Ta=-20~+85°C

**\*\*Note:** The contents of the data register are transferred to the latch circuit at the rising edge of LD. Then the gray scale voltage is output from the device at the falling edge of LD

**\*\*\*Note:** Output loading condition:

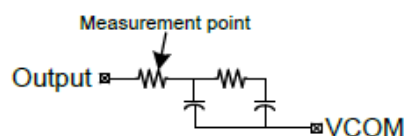



## 8.2 Data Timing

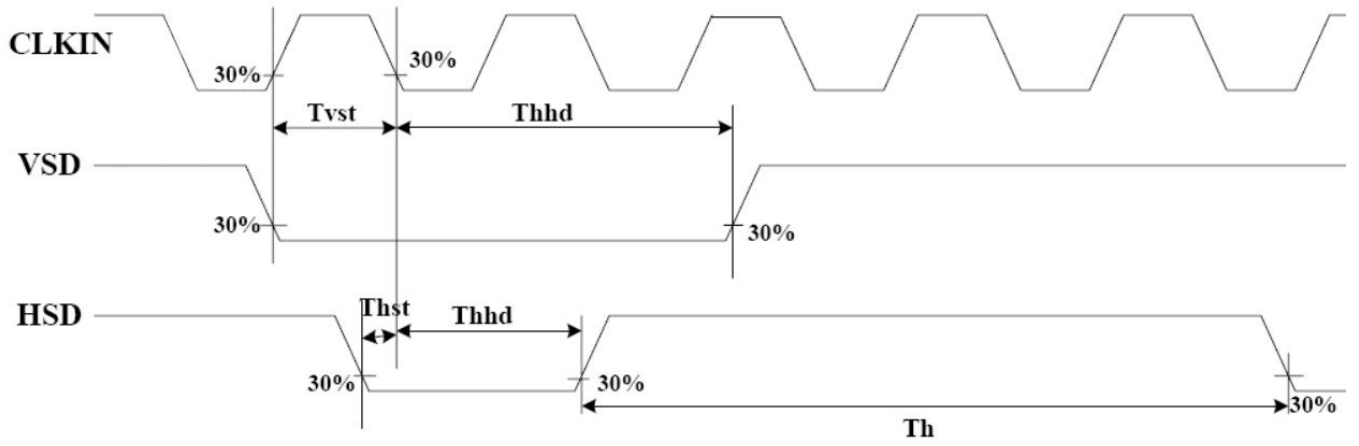

Figure 4: Data Transaction Timing in Parallel RGB (24Bit) interface (SYNC Mode)

Horizontal Input Timing						
Parameter	Symbol	Value			Unit	
		Min.	Typ.	Max.		
Horizontal display area	$t_{HD}$	-	800	-	CLKIN	
CLKIN frequency	$f_{CLK}$	-	33.3	50	MHz	
1 Horizontal line period	$t_H$	862	1056	1200	CLKIN	
HSD Pulse Width	Min.	-	1	-	CLKIN	
	Typ.	-	-	-	CLKIN	
	Max.	-	40	-	CLKIN	
HSD back porch	SYNC	$t_{HBP}$	46	46	46	CLKIN
HSD front porch	SYNC	$t_{HFP}$	16	210	354	CLKIN

Vertical Input Timing					
Parameter	Symbol	Value			Unit
		Min.	Typ.	Max.	
Vertical display area	$t_{VD}$	-	480	-	HSD
VSD period time	$t_V$	510	525	650	HSD
VSD pulse width	$t_{VPW}$	1	-	20	HSD
VSD back porch	$t_{VBP}$	23	23	23	HSD
VSD front porch	$t_{VFP}$	7	22	147	HSD

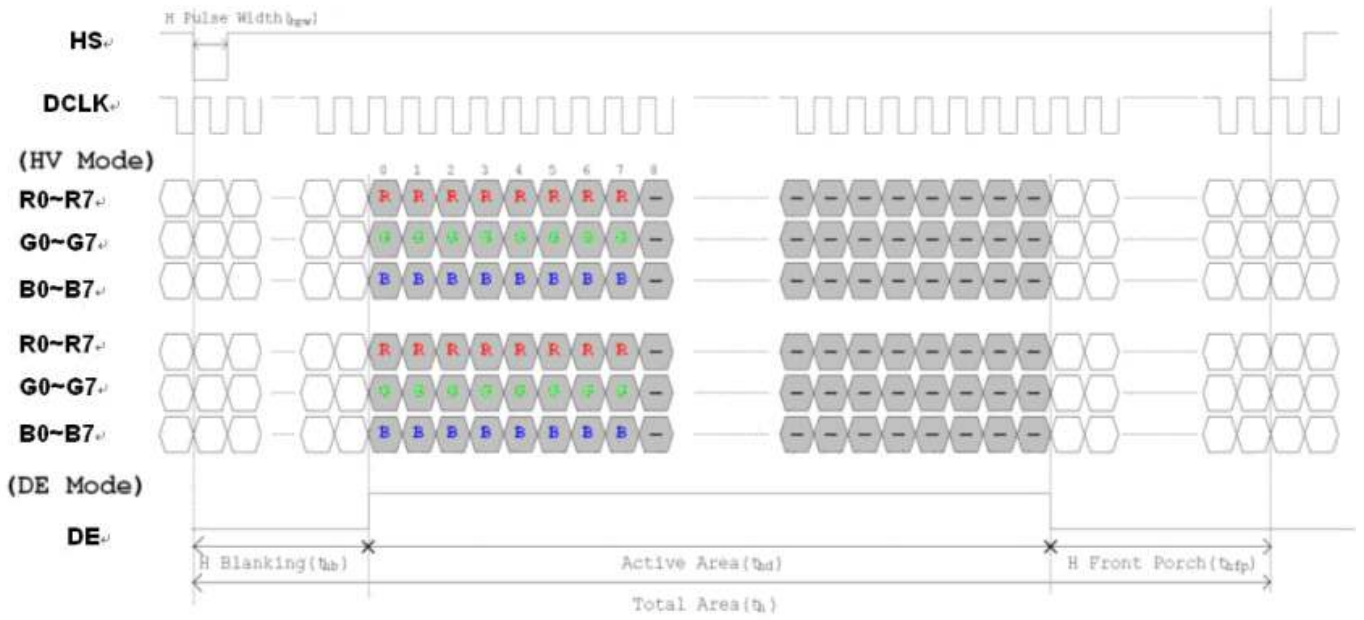

Figure 5: Horizontal Input Timing Diagram

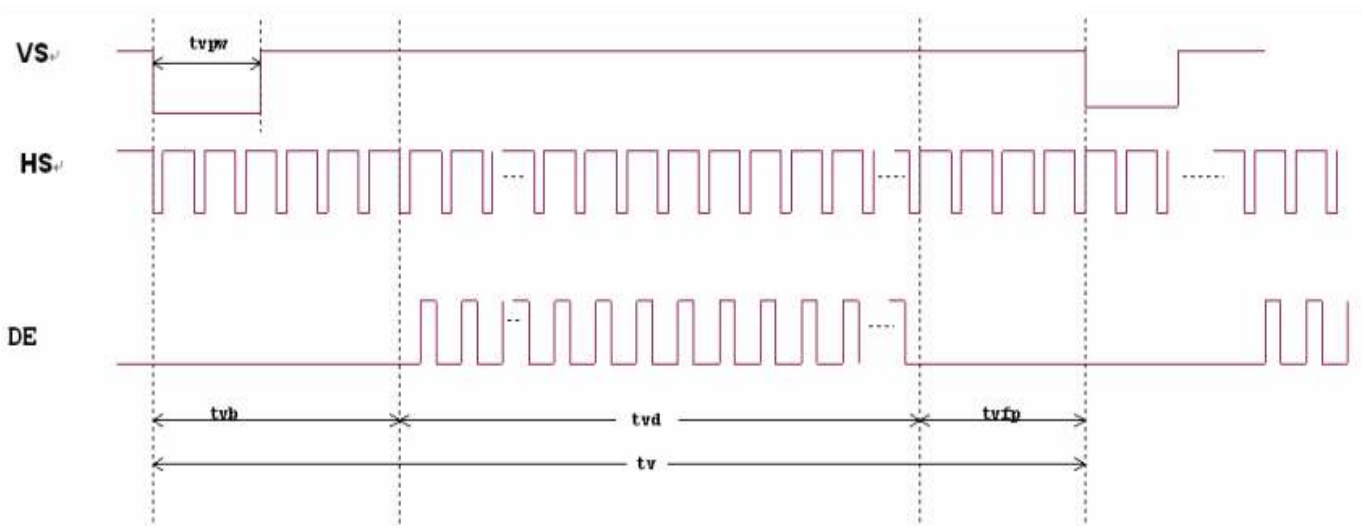

Figure 6: Vertical Input Timing Diagram



# 9 Power Sequence

## 9.1 Power Up Sequence

To prevent the device damage from latch up, the power ON/OFF sequence shown below must be followed.

Power On: VDD, DGND → VDDA, AGND, → V1 to V14

Power OFF: V1 to V14 → VDDA, AGND → VDD, DGND

In order to prevent ILI6122 from power ON reset fail, the rising time ( $t_{POR}$ ) of the digital power supply VDD should be maintained within given specifications. The power ON/OFF timing sequence is illustrated as below:

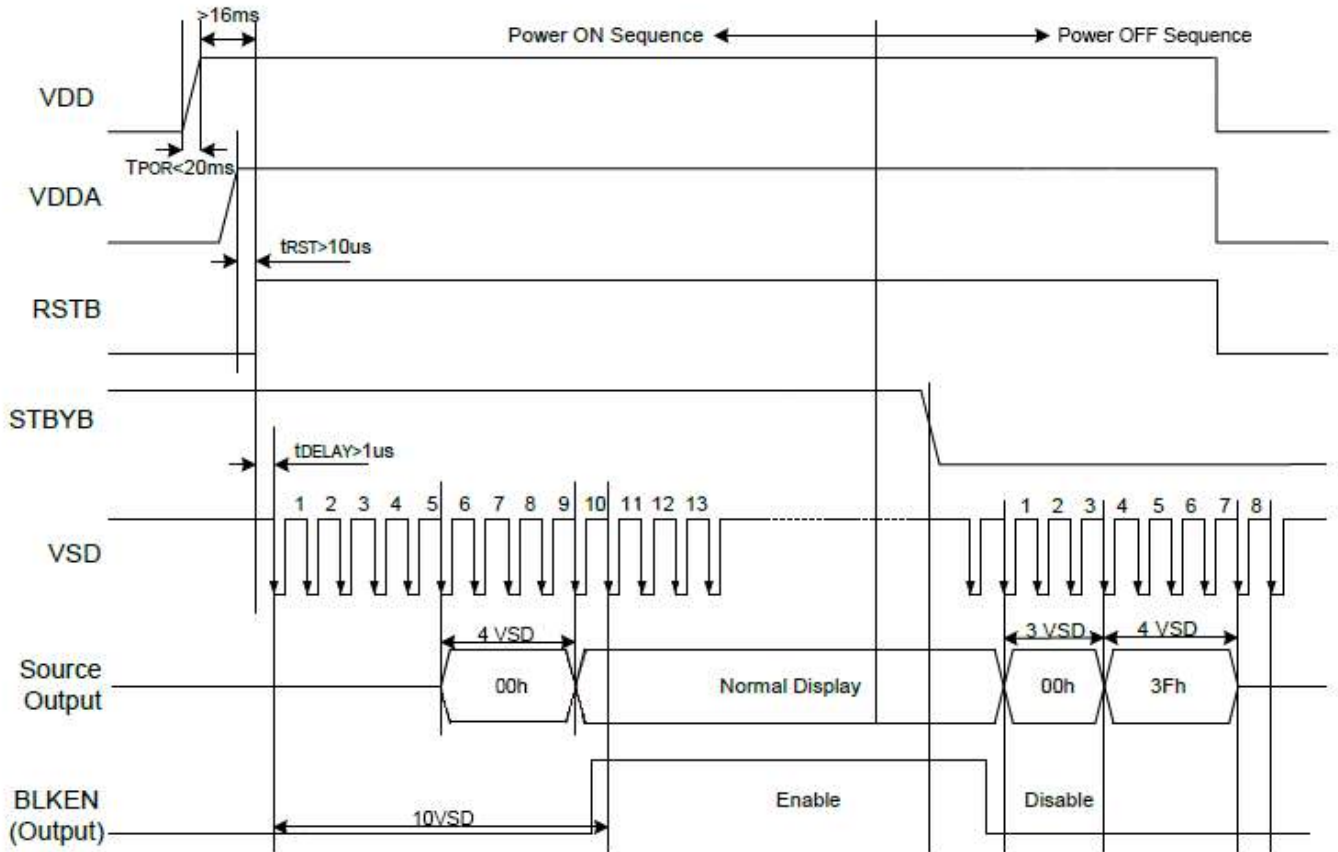

Figure 7: Power up sequence timing diagram

**\*Note:** To prevent abnormal operations,  $t_{RST}$  must be longer than 10us during the Power ON sequence.



# 10 Inspection Criterion

## 10.1 Description

This specification is made to be used as the standard acceptance/rejection criteria for the MOP-TFT800480-50A-BLM-TPN.

## 10.2 Sampling Plan and Reference Standards

Sampling plan :

Refer to National Standard GB/T 2828.1---2012/ISO2859-1:1999, level II of normal levels:

Major defect: AQL 0.4

Minor defect: AQL 1.0

## 10.3 Inspection condition

- Cosmetic inspection: shall be done normally at  $23\pm 5^{\circ}\text{C}$  of the ambient temperature and 45~75%RH of relative humidity, under the ambient luminance between 500lux~1000lux and at the distance of 30cm apart between the inspector's eyes and the LCD panel and normally in reflected light. For backlight LCM, cosmetic inspection shall be done under the ambient luminance less than 100lux with the backlight on.
- The TFT shall be tested at the angle of  $45^{\circ}$  left and right and  $0-45^{\circ}$  top and bottom as the following picture showing:

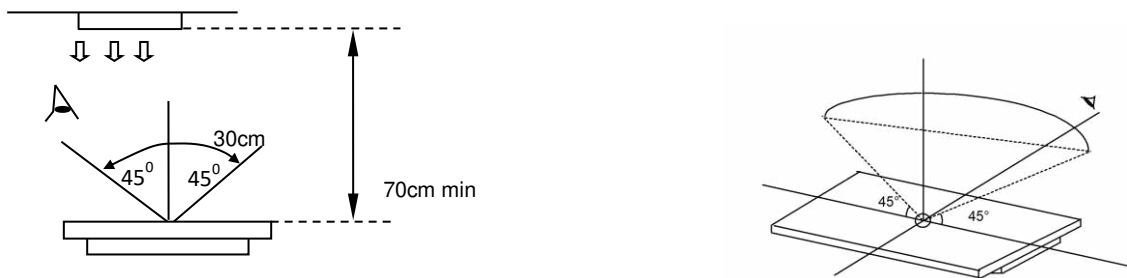

## 10.4 Definition of Inspection Zone in LCD

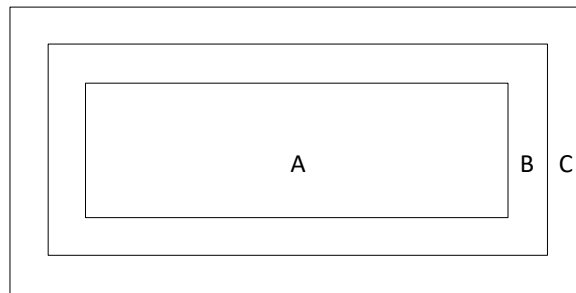

Figure 8: Inspection Zones in an LCD

Zone A: character/Digit area

Zone B: viewing area except Zone A (ZoneA + ZoneB=minimum Viewing area)

Zone C: Outside viewing area (invisible area after assembly in customer's product)

**\*Note:** As a general rule, visual defects in Zone C are permissible, if it does not affect display quality and assembly of customer's product.



## 10.5 Function Defect

Items to be inspected	Inspection criterion	Classification of defects
All Functional defects	1)No Display 2)Display Abnormal 3)Missing Segment 4)Sealing Defects 5)No backlight, flickering and abnormal lighting 6)Obvious striation 7)Current beyond specification value	MA
Missing	Missing Components	
Outline Dimension	Overall outline dimension exceed the drawing is not allowed	

## 10.6 LCD Pixel Defect

(Bad Dot) (Defect type: MI)

Item	Inspection criterion
Color pixel dot defect(RGB dot)	2
2 connected bright dot	1
3 connected bright dot or more	0
Bright dot quantity	2
Random dark dot quantity	3
2 connected dark dot	1
3 connected dark dot or more	0
Dark dot quantity	4
Multi-bright dot	ND 3%hidden, OK
Remark: 2 bright dots distance $DS \geq 15mm$ 2 dark dots distance $DS \geq 5mm$	
1) Bright dot: Power on TFT and RGB dot in black display	
2) Dark dot: Power on TFT and gray or black dot in RGB display	
3) Multi-bright dot: Power on TFT and fluorescent tiny dot in black display(only visible in black display)	



## 10.7 Dot and line defect

(defect type: MI)

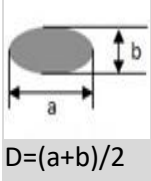
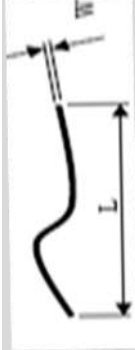
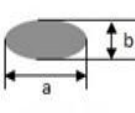
Item	Inspection criterion		Picture	Inspection method/tools	
	Size	5 Inch ≤ S < 10 Inch			
Dot defect (black dot, white dot)	D ≤ 0.15	Not count	 $D=(a+b)/2$	Naked eyes /film card /magnifier	
	0.15 < D ≤ 0.25	3			
	0.25 < D ≤ 0.30	2			
	0.30 < D ≤ 0.35	1			
	0.35 < D ≤ 0.50	0			
	D > 0.5	0			
Remark: D ≤ 0.15mm, not count. Multi-dot as bulk is not accepted. Count dot quantity ≤ 5 2 round dots or linear dots in 1 cm is judged as multi-dot.					
Line defect (visible when power on)	Length (mm)	Width (mm)	Judgement Criterion		Naked eyes /film card /magnifier
	Not count	W ≤ 0.03	Accepted		
	L ≤ 5	0.03 ≤ W < 0.05	3		
	L ≤ 5	0.05 ≤ W < 0.08	1		
	L ≤ 8	0.05 ≤ W < 0.08	0		
	L > 8	W > 0.08	0		
Remark: Invisible when power on, only visible in special angle against light, show as watermark/folding/scratch but cannot be touched, no control or refer to keeping sample.					
Polarizer convex-concave dot defect, polarizer bubble defect	Size(mm)	Judgement Criterion		Naked eyes /film card /magnifier	
	D ≤ 0.20	Not count			
	0.20 < D ≤ 0.5	2			
	0.50 < D ≤ 0.8	1			
	0.8 < D ≤ 1.5	0			
D > 1.5mm	0				



# 11 Handling Precautions

## 11.1 Mounting method

Do not make extra holes in the display or modify its shape. When mounting the display, ensure that the display does not flex, bend or twist. Extreme care should be used when handling the LCD modules.

## 11.2 LCD Handling and Cleaning Precaution

To clean the display surface, it is recommended to wipe lightly using a soft cloth with either Isopropyl alcohol or Ethyl alcohol.

Do not wipe the display surface with dry or hard materials as it may damage the polarizer surface.

Do not use Water or Aromatics to clean the display.

Do not wipe ITO pad area with dry or hard materials that will damage the ITO patterns

Do not use Soldering flux, Chlorine(Cl), and Sulfur(S) on the pad or prevent it from being contaminated.

If the display is sent without applying a silicon coat on the pad, the ITO patterns could be damaged due to corrosion as time goes on.

If ITO corrosion occurs due to customer miss-handling, or if the customer applies materials such as Chlorine (Cl), Sulfur (S) to the display, the responsibility is placed the customer.

## 11.3 Static Charge Precaution

The LCD module uses CMOS LSI drivers, so we recommend that you:

- Connect any unused input terminal to VDD or VSS
- Do not input any signals before power is turned on
- Ground your body, work/assembly areas, and assembly equipment to protect against static electricity.

## 11.4 Packing

The module employs LCD elements and must be treated as such.

- Avoid intense shock and falls from a height.
- To prevent modules from degradation, do not operate or store them exposed direct to sunshine or high temperature/humidity

## 11.5 Precautions during Operation

- It is an indispensable condition to drive the LCD module within the specified voltage limits. Applying voltage higher than the limit will reduce the life span of the LCD.
- Using direct drive current should be avoided, as it will induce an electrochemical reaction causing undesirable deterioration.
- The LCD's response time will be delayed when operating at a temperature lower than the suggested operating range. When operating at a temperature higher than the suggested range, the LCD will be noticeably darker. The display will return to normal when it is brought back to the specified operation temperature.
- If the display area is pushed hard during operation, some font may be abnormally drawn but the LCD will return to normal after it is reset.
- Slight dew depositing on terminals can cause an electro-chemical reaction, damaging traces and resulting in an open circuit.

Usage under the maximum operating temperature, 50%Rh or less is required.



## 11.6 Storage Recommendations

When storing the LCD for a prolonged period of time, the following recommendations will help prevent damage or deterioration

- Store the display in an ambient temperature range between 10°C to 30°C, and in a relative humidity of 45% to 75%.
- Do not leave the display exposed to sunlight or fluorescent light.
- Place the display in a polyethylene bag with the opening sealed.
- Ensure that nothing is making contact with the polarizer surface.
- It is recommended to store them in the same packaging that was provided upon purchase

## 11.7 Safety Precautions

In the case that the LCD glass has shattered, it is recommended to remove any glass pieces, wash off the liquid crystal using either acetone or ethanol, and proceed to burn any remaining display pieces.

If any liquid leaked out of a damaged glass cell, and comes in contact with your hands, please wash it off well with soap and water





## 12 Ordering

### 12.1 Part Numbering Scheme

Table 1: Parallel TFT Part Numbering Scheme

MOP	TFT	800	480	50	A	BLM	TPN
1	2	3	4	5	6	7	8

### 12.2 Options

Table 2: Parallel Part Options

#	Designator	Options
1	Product Line	MOP: Matrix Orbital Parallel Display
2	Screen Type	TFT: Graphic TFT
3	Display Columns	800: Eight Hundred Pixel Columns
4	Display Rows	480: Four Hundred Eighty Pixel Columns
5	Display Size	50: 5.0"
6	Display Form Factor	A: A Form Factor
7	Brightness Level	-BLS: Brightness < 300 Nit -BLM: 300 Nit < Brightness < 600 Nit -BLH: 600 Nit < Brightness < 1000 Nit -BLD: Brightness > 1000 Nit
8	Touch Panel Type	TPN: None TPR: Resistive TPC: Capacitive

## 13 Contact

### Sales

Phone: 403.229.2737

Email: [sales@matrixorbital.ca](mailto:sales@matrixorbital.ca)

### Support

Phone: 403.204.3750

Email: [support@matrixorbital.ca](mailto:support@matrixorbital.ca)

### Online

Purchasing: [www.matrixorbital.com](http://www.matrixorbital.com)

Support: [www.matrixorbital.ca](http://www.matrixorbital.ca)

