

MAXIM

MAX9981 Evaluation Kit

Evaluates: MAX9981

General Description

The MAX9981 evaluation kit (EV kit) simplifies the evaluation of the MAX9981 825MHz to 915MHz dual high-linearity active down-converter mixer. It is fully assembled and tested at the factory. Standard 50Ω SMA connectors are included for the inputs and outputs to allow quick and easy evaluation on the test bench.

This document provides a list of equipment required to evaluate the device, a straightforward test procedure to verify functionality, a description of the EV kit circuit, the circuit schematic, a bill of materials (BOM) and artwork for each layer of the PC board.

Contact MaximDirect sales at 888-629-4642 to check on pricing and availability for these kits.

Component Suppliers

SUPPLIER	PHONE	WEBSITE
Coilcraft	800-322-2645	www.coilcraft.com
Digi-Key	800-344-4539	www.digikey.com
Johnson	507-833-8822	www.johnsoncomponents.com
Mini-Circuits	718-934-4500	www.minicircuits.com
Murata	770-436-1300	www.murata.com

Features

- ◆ Fully Assembled and Tested
- ◆ +27.3dBm Input IP3
- ◆ +13.6dBm Input 1dB Compression Point
- ◆ 825MHz to 915MHz RF Frequency
- ◆ 725MHz to 1085MHz LO Frequency
- ◆ 70MHz to 170MHz IF Frequency
- ◆ 2.1dB Conversion Gain
- ◆ 10.8dB Noise Figure
- ◆ 42dB Channel-to-Channel Isolation
- ◆ -5dBm to +5dBm LO Drive
- ◆ Built-In LO Switch with 52dB LO1-to-LO2 Isolation

Ordering Information

PART	TEMP RANGE	IC PACKAGE
MAX9981EVKIT	-40°C to +85°C	36 QFN-EP* (6mm x 6mm)

*EP = Exposed paddle.

Component List

DESIGNATION	QTY	DESCRIPTION
C1, C4	2	33pF ±5%, 50V C0G ceramic capacitors (0603) Murata GRM1885C1H330J
C2, C3	2	3.9pF ±0.25pF, 50V C0G ceramic capacitors (0603) Murata GRM1885C1H3R9C
C5, C6, C9, C10	4	100pF ±5%, 50V C0G ceramic capacitors (0603) Murata GRM1885C1H101J
C7, C8	2	15pF ±5%, 50V C0G ceramic capacitors (0603) Murata GRM1885C1H150J
C11, C12	2	0.033μF ±10%, 25V X7R ceramic capacitors (0603) Murata GRM188R71E333K
C13, C16, C17, C20	4	220pF ±5%, 50V C0G ceramic capacitors (0603) Murata GRM1885C1H221J
C14, C15, C18, C19	4	330pF ±5%, 50V C0G ceramic capacitors (0603) Murata GRM1885C1H331J

DESIGNATION	QTY	DESCRIPTION
L1-L4	4	560nH ±5% wire-wound inductors (1008) Coilcraft 1008CS-561XJBC
R1, R2	2	267Ω ±1% resistors (0603)
R3-R6	4	137Ω ±1% resistors (0603)
R7	1	47kΩ ±5% resistor (0603)
J1-J6	6	PC board edge-mount SMA RF connectors (flat tab launch) Johnson 142-0741-856
T1, T2	1	4:1 transformers (200:50) Mini-Circuits TC4-1W-7A
TP1	1	Large test point for 0.063in PC board (red) Mouser 151-107
TP2	1	Large test point for 0.063in PC board (black) Mouser 151-103
TP3	1	Large test point for 0.063in PC board (white) Mouser 151-101
U1	1	MAX9981EGX-T*

*The exposed paddle conductor on U1 must be solder attached to a grounded pad on the circuit to ensure a proper electrical/thermal design.

MAX9981 Evaluation Kit

Quick Start

The MAX9981 EV kit is fully assembled and factory tested. Follow the instructions in the *Connections and Setup* section for proper device evaluation.

Test Equipment Required

Table 1 lists the equipment required to verify the operation of the MAX9981 EV kit. It is intended as a guide only, and some substitutions can be made.

Connections and Setup

This section provides a step-by-step guide for testing the basic functionality of the EV kit. As a general precaution to prevent damaging the outputs by driving high-VSWR loads, **do not turn on DC power or RF signals until all connections are made.**

This procedure is specific to operation with an RF input frequency range of 825MHz to 915MHz, low-side injected LO for a 100MHz IF. Choose the test frequency based on the particular system's frequency plan, and adjust the following procedure accordingly. See Figure 1 for the main mixer test setup diagram.

- 1) Calibrate the power meter for 870MHz. For safety margin, use a power sensor rated to at least +20dBm, or use padding to protect the power head as necessary.
- 2) Connect 3dB pads to DUT ends of each of the three RF signal generators' SMA cables. This padding improves VSWR and reduces the errors due to mismatch.
- 3) Use the power meter to set the RF signal generators according to the following:
 - RFMAIN signal source: -5dBm into DUT at 870MHz (approximately -2dBm before the 3dB pad)
 - LO1 signal source: 0dBm into DUT at 770MHz (approximately +3dBm before the 3dB pad)
 - LO2 signal source: 0dBm into DUT at 771MHz (approximately +3dBm before the 3dB pad)
- 4) Disable the signal generator outputs.
- 5) Connect the RF source (with pad) to RFMAIN.
- 6) Connect the LO1 and LO2 signal sources to the EV kit LO inputs.
- 7) Measure loss in the 3dB pad and the cable that is connected to IFMAIN. Losses are frequency dependent, so test this at 100MHz (IF frequency). Use this loss as an offset in all output power/gain calculations.

Table 1. Test Equipment Required

EQUIPMENT	QTY	DESCRIPTION
HP E3631A	1	DC power supply
Fluke 75 series II	1	Digital multimeter (ammeter)
HP/Agilent 8648B	3	RF signal generators
HP 437B	1	RF power meter
HP 8561	1	Spectrum analyzer
HP 8482A	1	High-power sensor (power head)
3dB pad	4	3dB attenuators
50Ω termination	2	50Ω (1W) terminations

- 8) Connect this 3dB pad to the EV kit's IFMAIN connector, and connect a cable from the pad to the spectrum analyzer.
- 9) Connect a 50Ω terminator to the unused RF input and IF output.
- 10) Set the DC supply to +5.0V, and set a current limit to around 500mA if possible. Disable the output voltage and connect supply to the EV kit through a low internal resistance ammeter. Enable the supply. Re-adjust the supply to get +5.0V at the EV kit since there will be a voltage drop across the ammeter when the mixer is drawing current.
- 11) Select LO1 by leaving LOSEL (TP3) unconnected or connecting it to +5V. If left floating, LOSEL will be pulled high by an on-board pullup resistor.
- 12) Enable the LO and the RF sources.

To test the diversity mixer, disable the LO and RF sources, turn off the DC supply and repeat steps 3 through 12, replacing RFDIV for RFMAIN and IFDIV for IFMAIN. Be sure to terminate RFMAIN and IFMAIN with 50Ω terminators. See Figure 2 for diversity mixer test setup.

Testing the Mixer

Adjust the center and span of the spectrum analyzer to observe the IF output tone at 100MHz. The level should be about -5.4dBm (2.6dB conversion gain, 3dB pad loss). The spectrum analyzer's absolute magnitude accuracy is typically no better than ±1dB; therefore, use the power meter to get an accurate output power measurement. There will also be a tone at 99MHz which is due to the LO signal applied to LO2. The amount of suppression between the 100MHz and 99MHz signals is the switch isolation.

Connect LOSEL to GND to select LO2. Observe that the IF output level at 99MHz increases while the 100MHz level decreases.

MAX9981 Evaluation Kit

Evaluates: MAX9981

Detailed Description

The MAX9981 is a highly integrated downconverter. RF and LO baluns are integrated on-chip, as well as an LO buffer and a SPDT LO input select switch. The EV kit circuit consists mostly of supply decoupling capacitors and DC-blocking capacitors, allowing for a simple design-in.

Supply Decoupling Capacitors

Ceramic capacitors C5, C6, C9, and C10 are 100pF used for high-frequency bypass on the supply. C13 and C17 are 220pF bypass capacitors for IF frequencies. C16 and C20 are used to provide IF ground for the center tap of T1 and T2. Although called out, replacing C16 and C20 with a short circuit causes little to no change in performance.

DC-Blocking Capacitors

The MAX9981 has internal baluns on the RFMAIN, RFDIV, LO1, and LO2 inputs. These inputs have almost 0Ω resistance at DC. C1 and C4 are 33pF DC-blocking capacitors on the RF ports and C7 and C8 are 15pF DC blocks for the LO ports. C14, C15, C18, and C19 are used to block DC current from flowing into the transformers along with providing flexibility for matching.

RFBIAS

Bias current for the mixer is set with resistors R1 and R2 (267Ω ±1%). This value was carefully chosen for best linearity and lowest supply current through testing at the factory. Changing this value, or using lower tolerance resistors degrades performance.

IF±

The MAX9981 employs a differential IF output to offer increased IP2 system performance. The IF outputs look like an open collector with 1.8pF of differential capacitance. Inductors L1–L4 are used to resonate out the on-chip and evaluation board capacitance at the IF frequency of interest along with providing a low-resistance path for biasing of the IF amplifier. R3–R6 provide a real impedance used to establish the 200Ω differential impedance. C14, C15, C18, and C19 provide DC blocking along with adding in the flexibility for tuning. The 4:1 baluns (T1 and T2) transform the 200Ω differential impedance to 50Ω single ended for ease of measurement. The EV kit IF is matched for operation over the 70MHz to 100MHz frequency range.

Resistors R3–R6 affect the gain of the mixer. For a typical 2.0dB gain, 137Ω resistors are used for R3–R6. Higher mixer gain can be realized by increasing R3–R6 and retuning L1–L4, C14, C15, C18, and C19 for IF impedance matching. For example, R3 through R6 = 250Ω, L1 through L4 = 330nH, C14 = C15 = C18 = C19 = 56pF yields a mixer gain of 4.6dB at 70MHz IF with an IF return loss of 12dB.

As the differential IF outputs are relatively high impedance (200Ω), they are more susceptible to component parasitics. It is often good practice to relieve the ground plane directly underneath large components to reduce associated shunt-C parasitics.

LOSEL

The EV kit includes a 47kΩ pullup resistor to allow for easy selection of the LO port. Providing a ground at TP3 selects LO2, while leaving TP3 open selects LO1. To drive TP3 from an external source, follow the limits called out in the MAX9981 data sheet. Logic voltages should not be applied to TP3 without the +5V applied. Doing so can cause the on-chip ESD diodes to conduct and could damage the part.

Modifying the EV Kit

The RF and LO inputs are broadband matched, so there is no need to modify the circuit for use anywhere in the 825MHz to 915MHz RF range (725MHz to 1085MHz LO range).

Retuning for a different IF is as simple as scaling the values of the IF pullup inductors up or down with frequency. The IF outputs look like an open collector with 3.6pF to ground (1.8pF differential) from the chip. This capacitance, along with approximately 5.6pF from the evaluation board, can be resonated out at the frequency of interest by proper selection of the bias inductor (L1–L4). To determine the inductor value use the following equation:

$$f_{IF} = \frac{1}{2\pi\sqrt{L \times C}}$$

The IF output network is tuned for operation at approximately 70MHz, so a 560nH inductor is used. For lower IF frequencies (i.e., larger component values), maintain the component's Q value at the cost of a larger case size unless it is unavoidable.

MAX9981 Evaluation Kit

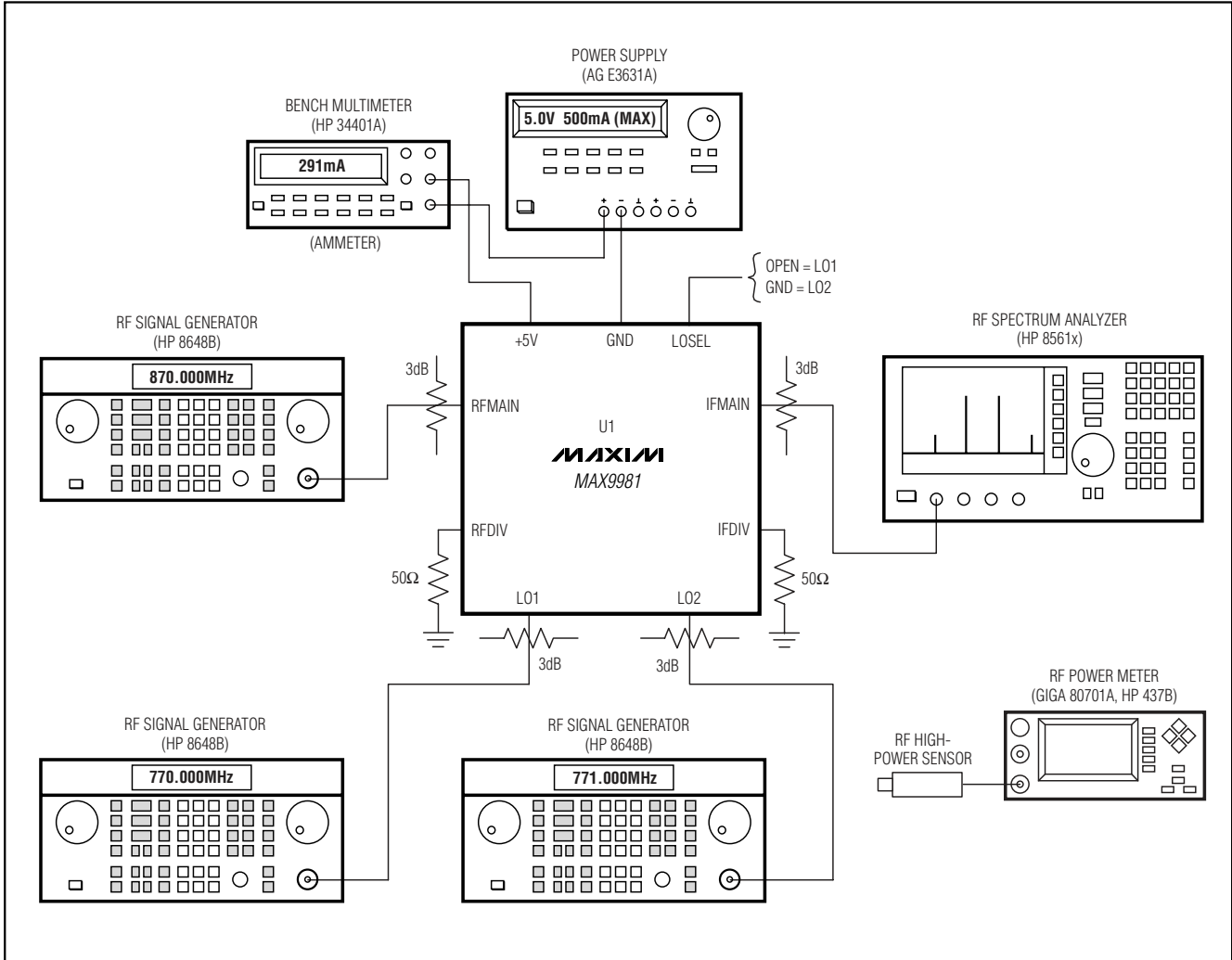

Figure 1. MAX9981 EV Kit Main Mixer Test Setup Diagram

Layout Considerations

The MAX9981 evaluation board can be a guide for your board layout. Pay close attention to thermal design and close placement of parts to the IC. The MAX9981 package exposed paddle (EP), conducts heat from the part and provides a low-impedance electrical connection. The EP must be attached to the PC board ground plane with a low thermal and electrical impedance contact.

Ideally, this can be achieved by soldering the backside package contact directly to a top metal ground plane on the PC board. Alternatively, the EP can be connected to a ground plane using an array of plated vias directly below the EP.

Depending on the ground plane spacing, large surface-mount pads in the IF path may need to have the ground plane relieved under them to reduce shunt capacitance.

MAX9981 Evaluation Kit

Evaluates: MAX9981

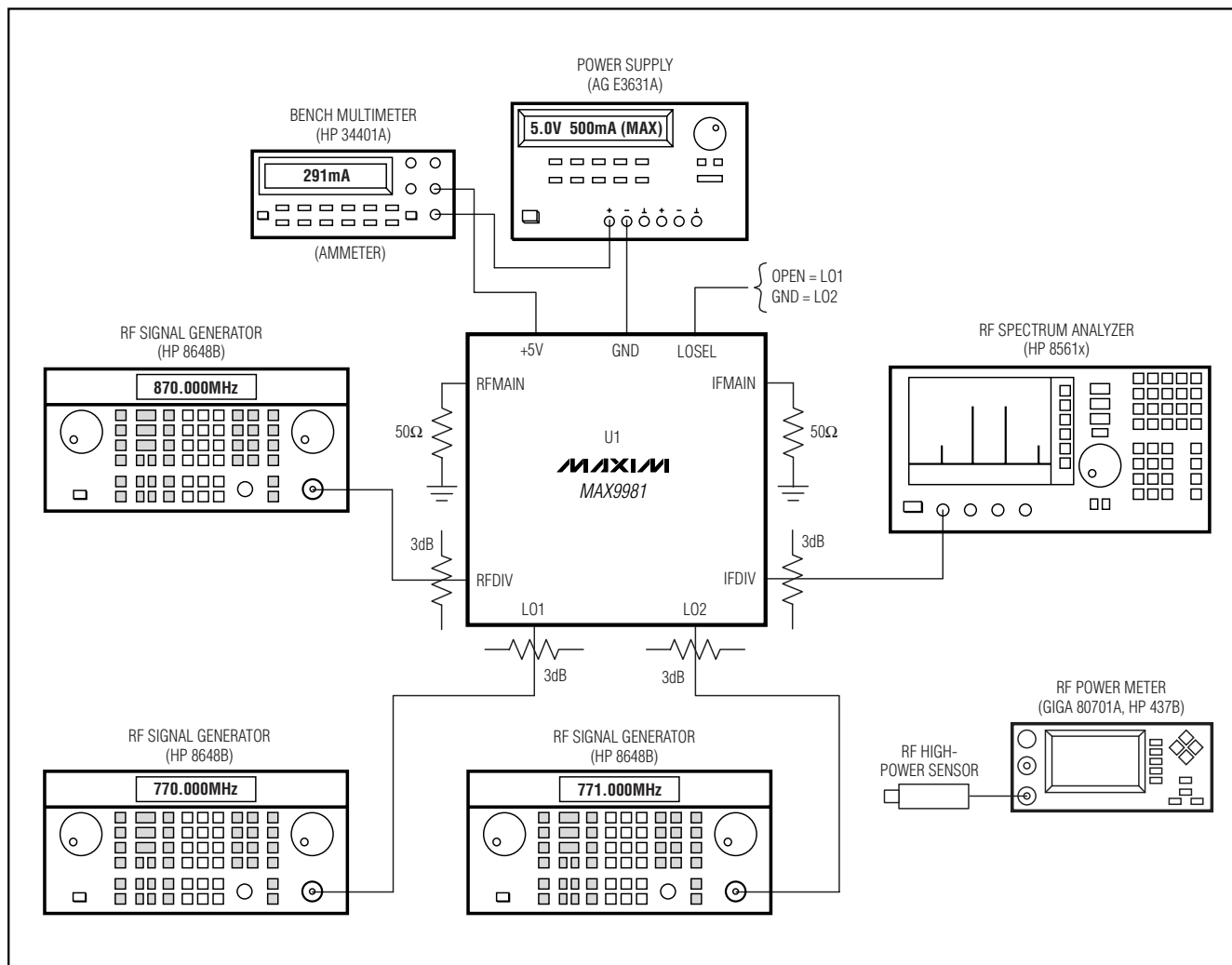

Figure 2. MAX9981 EV Kit Diversity Mixer Test Setup Diagram

MAX9981 Evaluation Kit

Evaluates: MAX9981

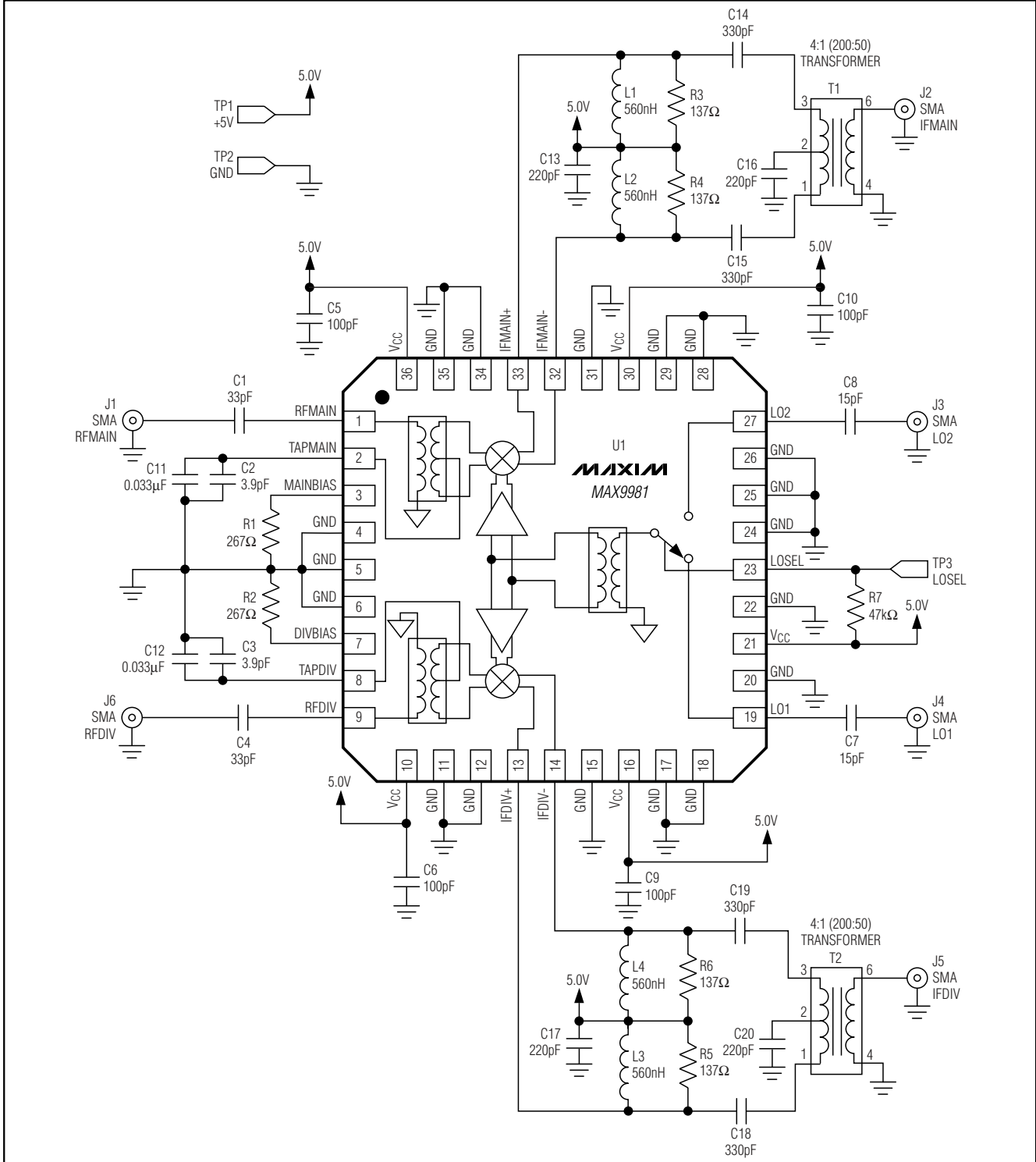

Figure 3. MAX9981 EV Kit Schematic

MAX9981 Evaluation Kit

Evaluates: MAX9981

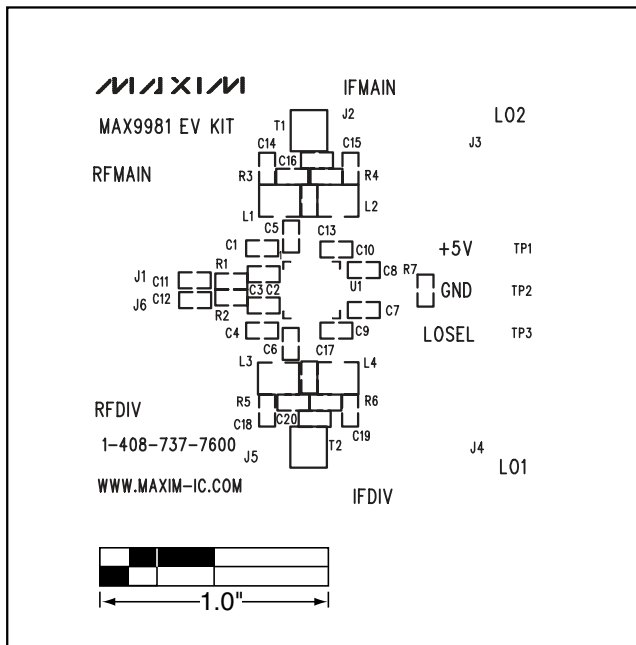

Figure 4. MAX9981 EV Kit PC Board Layout—Top Silkscreen

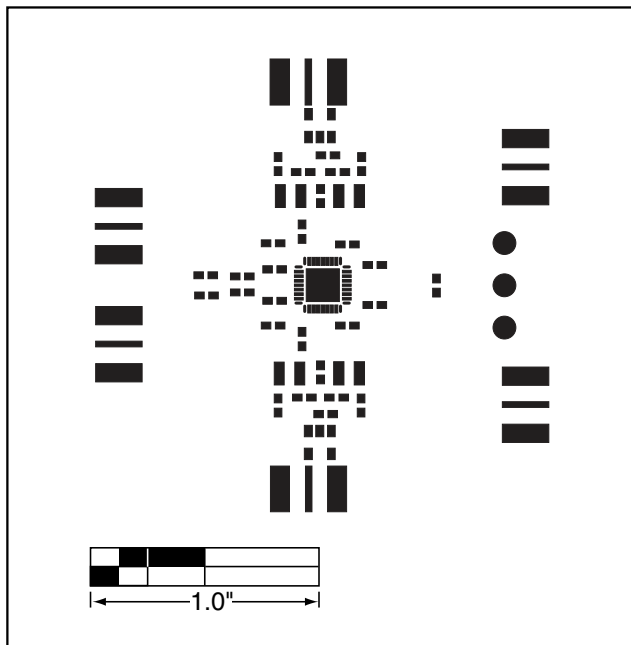

Figure 5. MAX9981 EV Kit PC Board Layout—Top Soldermask

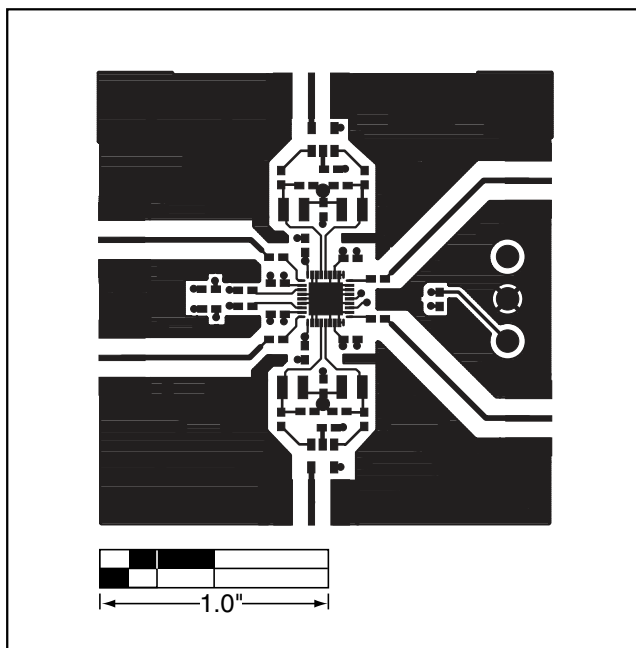

Figure 6. MAX9981 EV Kit PC Board Layout—Top Layer Metal

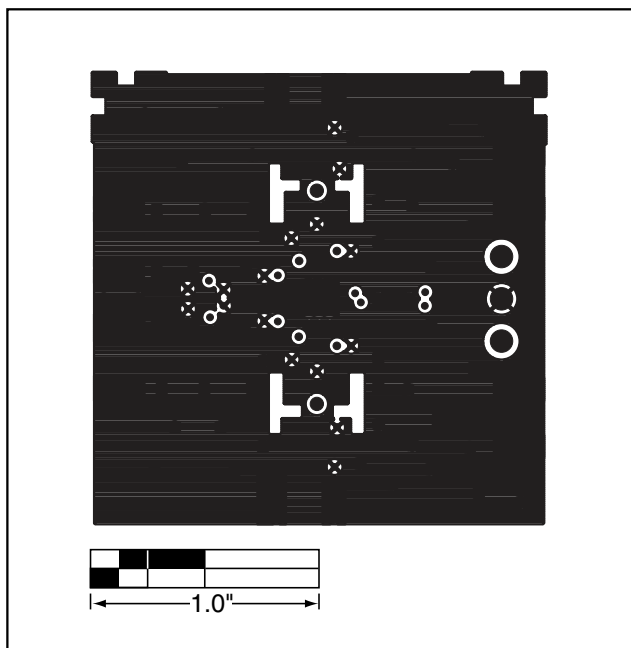

Figure 7. MAX9981 EV Kit PC Board Layout—Inner Layer 2 (GND)

MAX9981 Evaluation Kit

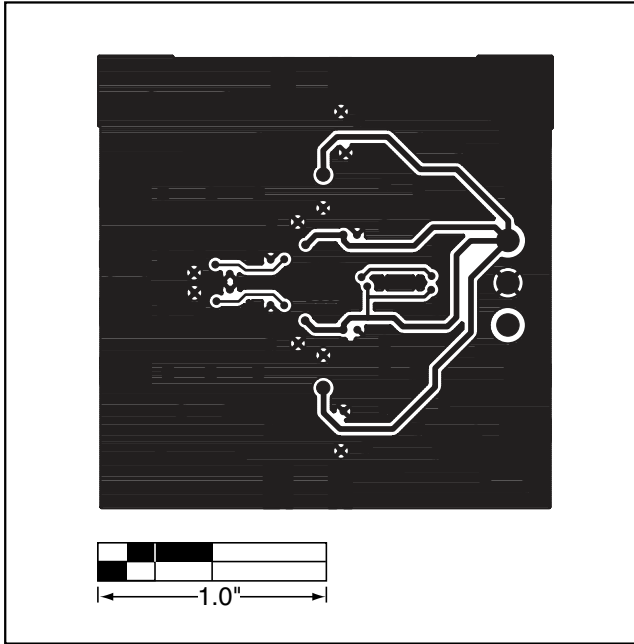

Figure 8. MAX9981 EV Kit PC Board Layout—Inner Layer 3 (Routes)

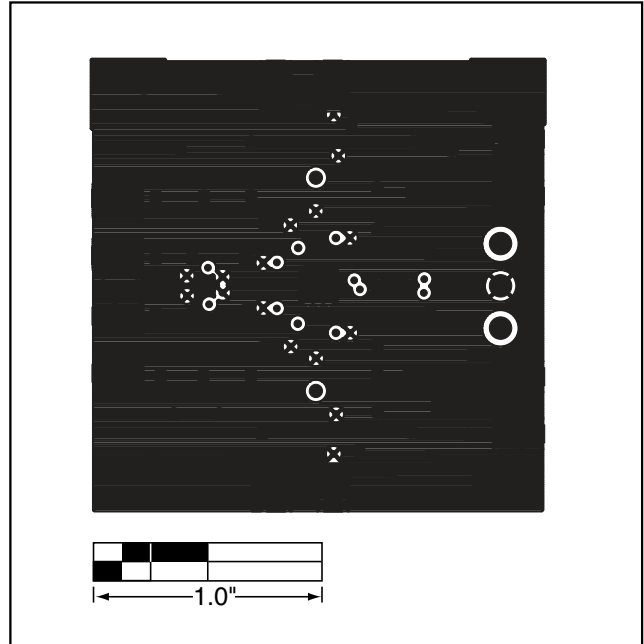

Figure 9. MAX9981 EV Kit PC Board Layout—Bottom Layer Metal

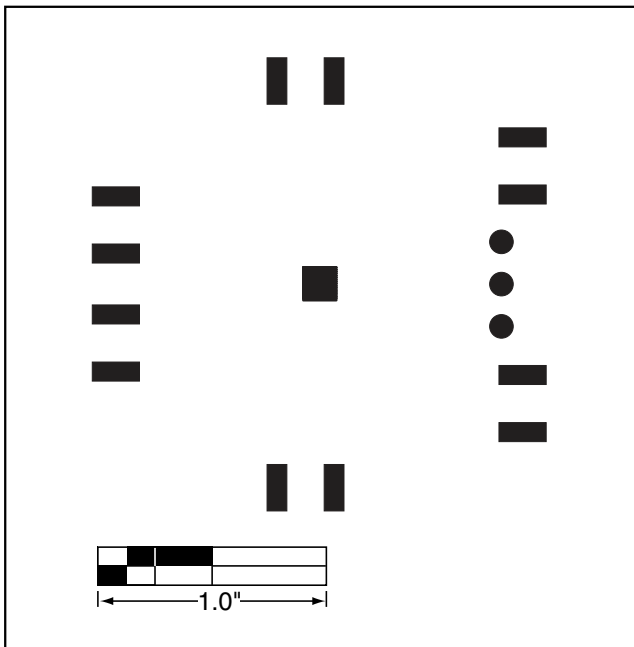

Figure 10. MAX9981 EV Kit PC Board Layout—Bottom Soldermask

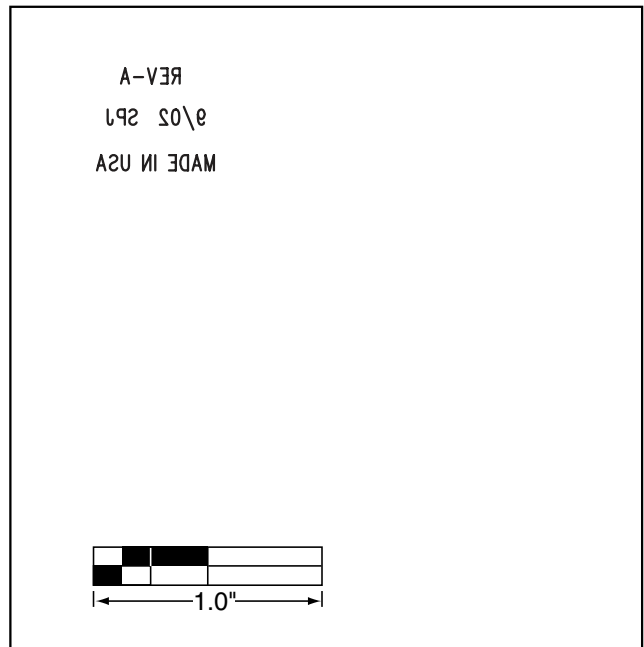

Figure 11. MAX9981 EV Kit PC Board Layout—Bottom Silkscreen

Maxim cannot assume responsibility for use of any circuitry other than circuitry entirely embodied in a Maxim product. No circuit patent licenses are implied. Maxim reserves the right to change the circuitry and specifications without notice at any time.

8 **Maxim Integrated Products, 120 San Gabriel Drive, Sunnyvale, CA 94086 408-737-7600**