

Main Product Characteristics

$V_{(BR)DSS}$	100V
$R_{DS(on)}$	21mΩ
I_D	30A

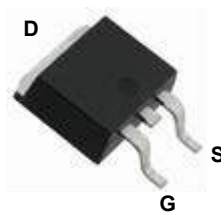

TO-252 (DPAK)

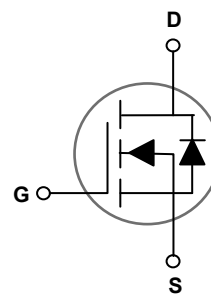

Schematic Diagram

Features and Benefits

- Advanced MOSFET process technology
- Ideal for high efficiency switched mode power supplies
- Low on-resistance with low gate charge
- Fast switching and reverse body recovery



Description

The GSFD1028 utilizes the latest techniques to achieve high cell density and low on-resistance. These features make this device extremely efficient and reliable for use in high efficiency switch mode power supplies and a wide variety of other applications.

Absolute Maximum Ratings ($T_C=25^{\circ}C$ unless otherwise specified)

Parameter	Symbol	Max.	Unit
Drain-Source Voltage	V_{DS}	100	V
Gate-Source Voltage	V_{GS}	± 20	V
Drain Current-Continuous ($T_C=25^{\circ}C$)	I_D	30	A
Drain Current-Continuous ($T_C=100^{\circ}C$)		19	
Drain Current-Pulsed ¹	I_{DM}	120	A
Single Pulse Avalanche Energy ²	E_{AS}	51	mJ
Single Pulse Avalanche Current ²	I_{AS}	32	A
Power Dissipation ($T_C=25^{\circ}C$)	P_D	53	W
Power Dissipation-Derate above 25°C		0.42	
Thermal Resistance, Junction-to-Ambient	$R_{\theta JA}$	62	°C/W
Thermal Resistance, Junction-to-Case	$R_{\theta JC}$	2.37	°C/W
Operating Junction Temperature Range	T_J	-55 To +150	°C
Storage Temperature Range	T_{STG}	-55 To +150	°C

Electrical Characteristics ($T_J=25^{\circ}\text{C}$ unless otherwise specified)

Parameter	Symbol	Conditions	Min.	Typ.	Max.	Unit
On / Off Characteristics						
Drain-Source Breakdown Voltage	BV_{DSS}	$V_{GS}=0V, I_D=250\mu A$	100	-	-	V
Drain-Source Leakage Current	I_{DSS}	$V_{DS}=80V, V_{GS}=0V, T_J=25^{\circ}\text{C}$	-	-	1	μA
		$V_{DS}=80V, V_{GS}=0V, T_J=85^{\circ}\text{C}$	-	-	10	μA
Gate-Source Leakage Current	I_{GSS}	$V_{GS}=\pm 20V, V_{DS}=0V$	-	-	± 100	nA
Static Drain-Source On-Resistance	$R_{DS(ON)}$	$V_{GS}=10V, I_D=14A$	-	17.5	21	m Ω
		$V_{GS}=4.5V, I_D=10A$	-	22	29	
Gate Threshold Voltage	$V_{GS(th)}$	$V_{GS}=V_{DS}, I_D=250\mu A$	1.2	1.6	2.5	V
Forward Transconductance	g_{fs}	$V_{DS}=10V, I_D=3A$	-	9	-	S
Dynamic and Switching Characteristics						
Total Gate Charge ^{3,4}	Q_g	$V_{DS}=50V, I_D=15A, V_{GS}=10V$	-	12.5	20	nC
Gate-Source Charge ^{3,4}	Q_{gs}		-	1.5	3	
Gate-Drain Charge ^{3,4}	Q_{gd}		-	4.3	6	
Turn-On Delay Time ^{3,4}	$t_{d(on)}$	$V_{DD}=50V, R_G=6\Omega, V_{GS}=10V, I_D=15A$	-	20	30	nS
Rise Time ^{3,4}	t_r		-	30	45	
Turn-Off Delay Time ^{3,4}	$t_{d(off)}$		-	55	70	
Fall Time ^{3,4}	t_f		-	30	45	
Input Capacitance	C_{iss}	$V_{DS}=50V, V_{GS}=0V, F=1\text{MHz}$	-	690	1030	pF
Output Capacitance	C_{oss}		-	135	200	
Reverse Transfer Capacitance	C_{rss}		-	6	9	
Gate Resistance	R_g	$V_{GS}=0V, V_{DS}=0V, F=1\text{MHz}$	-	0.8	-	Ω
Drain-Source Diode Characteristics and Maximum Ratings						
Continuous Source Current	I_S	$V_G=V_D=0V, \text{Force Current}$	-	-	30	A
Pulsed Source Current	I_{SM}		-	-	60	A
Diode Forward Voltage	V_{SD}	$V_{GS}=0V, I_S=1A, T_J=25^{\circ}\text{C}$	-	-	1	V
Reverse Recovery Time	t_{rr}	$I_S=10A, V_R=100V, di/dt=100A/\mu s, T_J=25^{\circ}\text{C}$	-	180	-	nS
Reverse Recovery Charge	Q_{rr}		-	300	-	nC

Note:

1. Repetitive Rating: Pulsed width limited by maximum junction temperature.
2. $V_{DD}=50V, L=0.1\text{mH}, I_{AS}=32A, R_G=25\Omega, \text{Starting } T_J=25^{\circ}\text{C}$.
3. Pulse test: pulse width $\leq 300\mu s$, duty cycle $\leq 2\%$.
4. Essentially independent of operating temperature.

Typical Electrical and Thermal Characteristic Curves

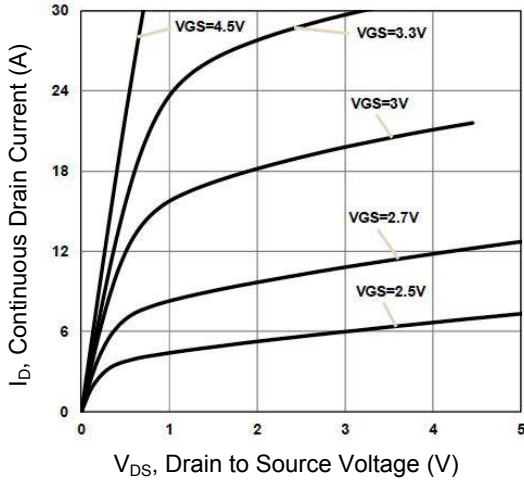

Figure 1. Typical Output Characteristics

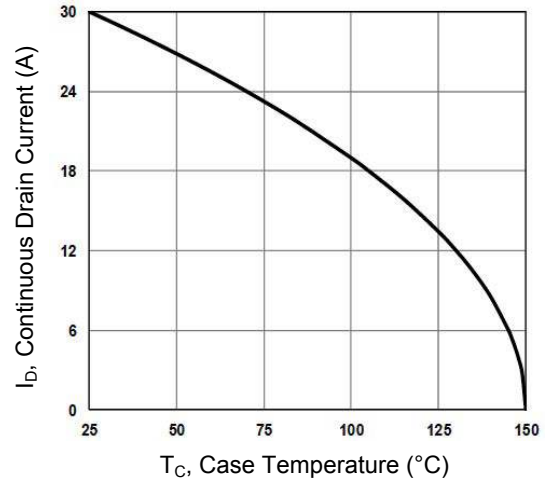

Figure 2. Continuous Drain Current vs. T_C

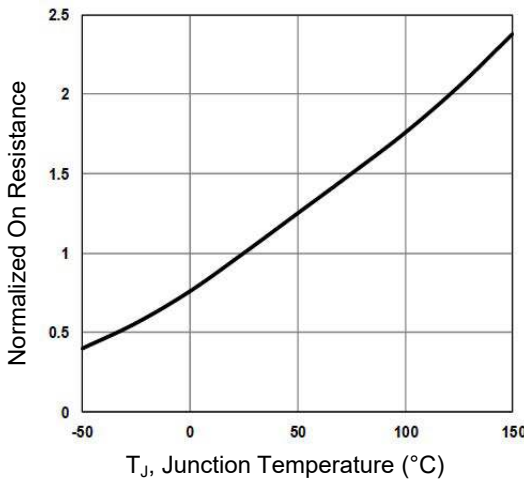

Figure 3. Normalized R_{DSON} vs. T_J

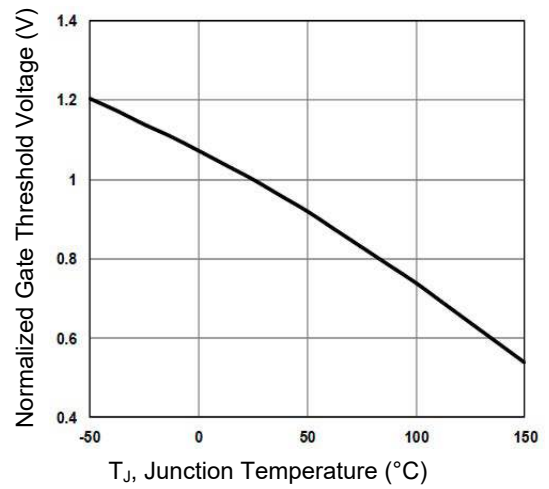

Figure 4. Normalized V_{th} vs. T_J

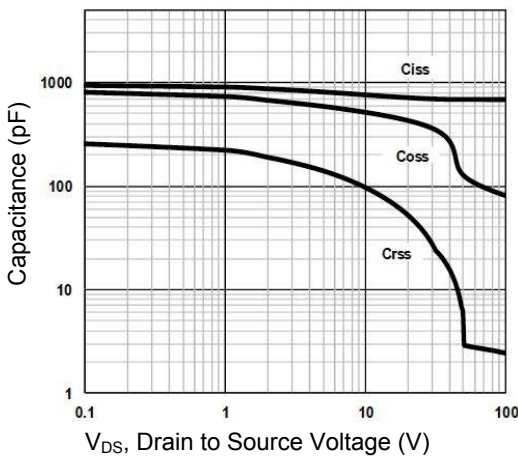

Figure 5. Capacitance Characteristics

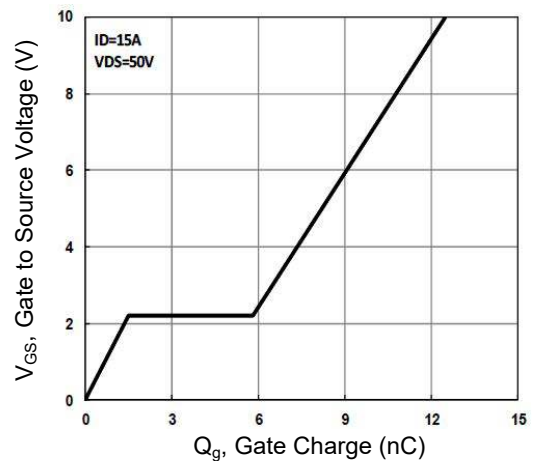

Figure 6. Gate Charge Characteristics

Typical Electrical and Thermal Characteristic Curves

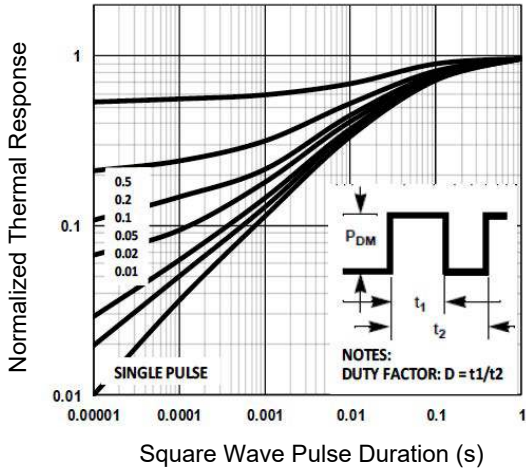

Figure 7. Normalized Transient Impedance

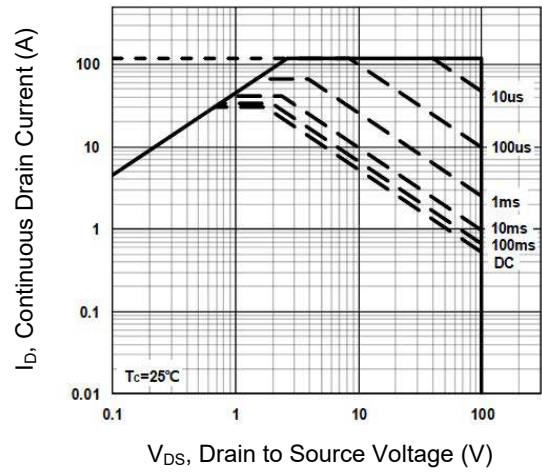

Figure 8. Maximum Safe Operation Area

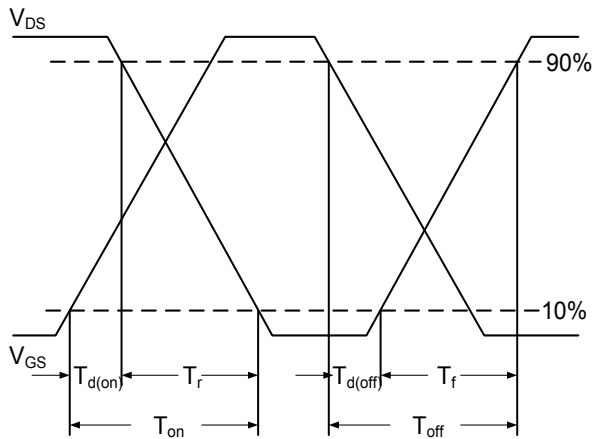

Figure 9. Switching Time Waveform

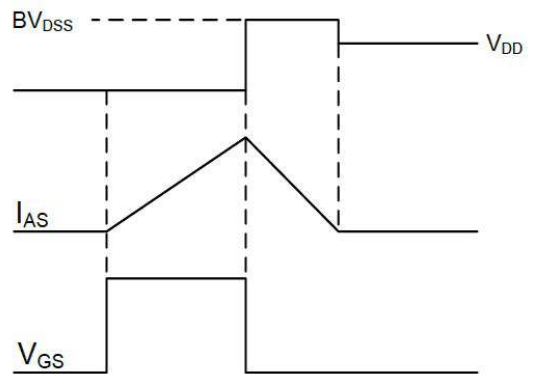
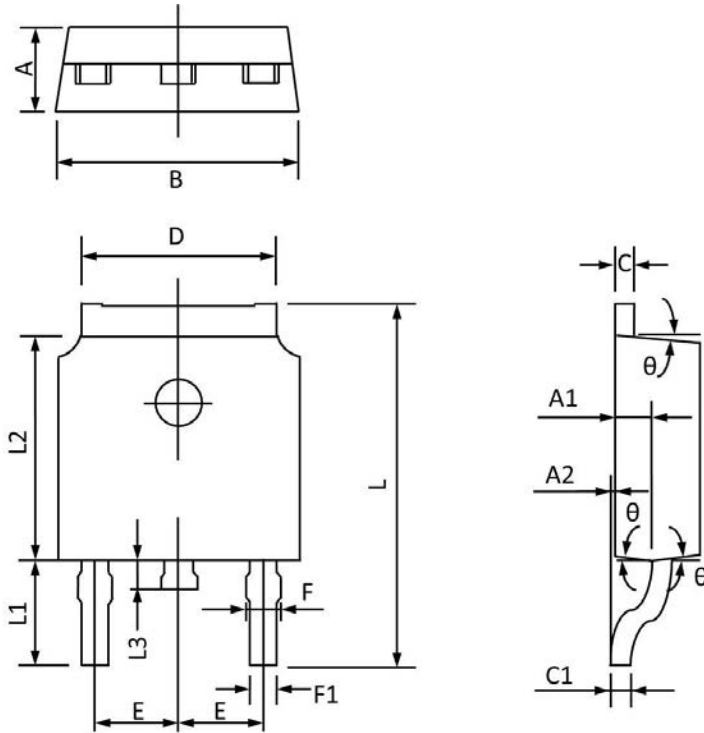

Figure 10. EAS Waveform

Package Outline Dimensions TO-252 (DPAK)



Symbol	Dimensions in Millimeters		Dimensions in Inches	
	Min	Max	Min	Max
A	2.150	2.450	0.085	0.096
A1	0.910	1.200	0.036	0.047
A2	0.000	0.150	0.000	0.006
B	6.300	6.800	0.248	0.268
C	0.350	0.580	0.014	0.023
C1	0.380	0.550	0.015	0.022
D	5.100	5.500	0.201	0.217
E	2.000	2.390	0.079	0.094
F	0.600	0.940	0.024	0.037
F1	0.500	0.860	0.020	0.034
L	9.400	10.400	0.370	0.409
L1	2.400	3.000	0.094	0.118
L2	5.300	6.200	0.209	0.244
L3	0.600	1.200	0.024	0.047
θ	3°	9°	3°	9°