

ASSEMBLY - VIEW FROM FRONT

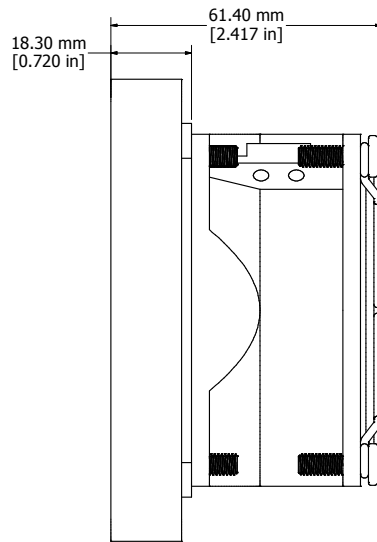

ASSEMBLY - VIEW FROM SIDE

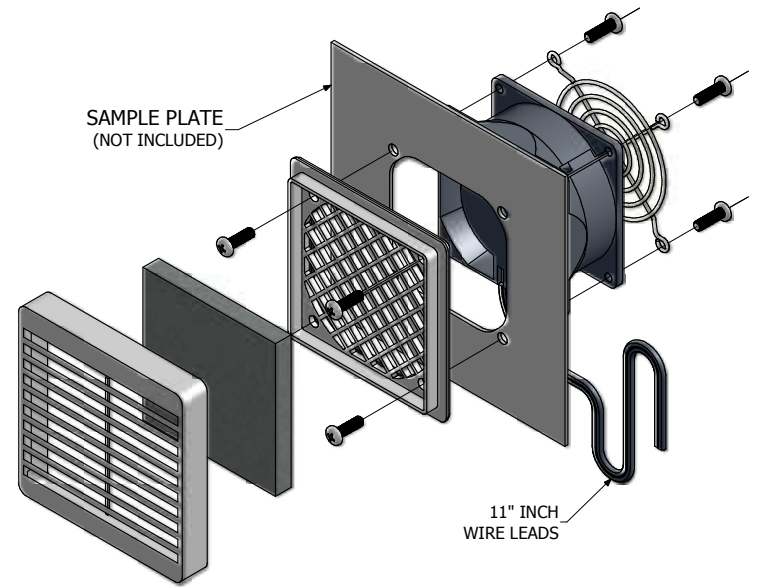

EXPLODED ISOMETRIC VIEW

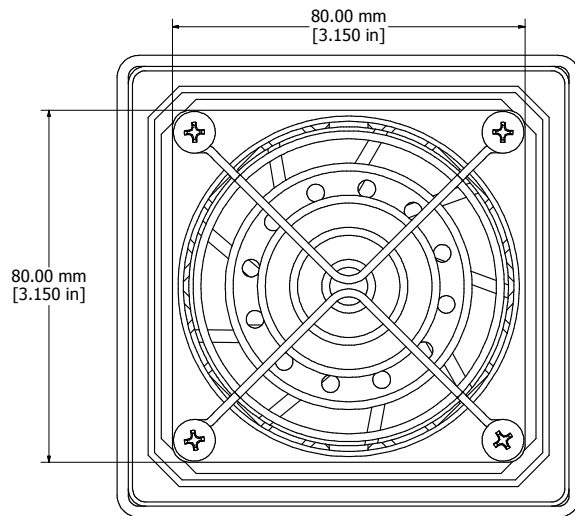

ASSEMBLY - VIEW FROM BACK

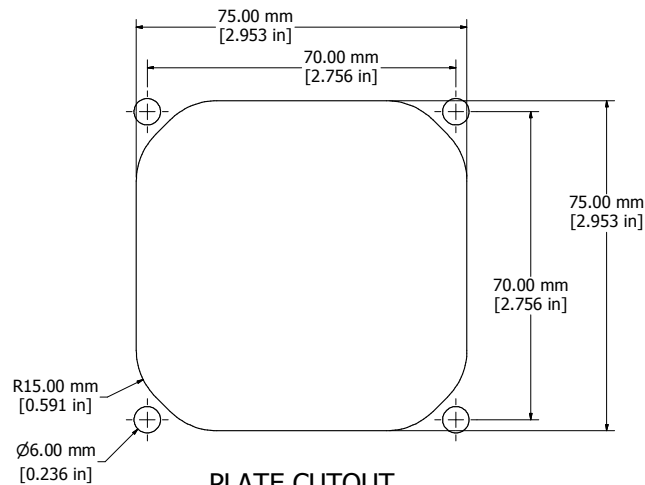

PLATE CUTOUT

<b>DNFF080**115</b>
Finish - Front Screen - ABS Plastic
- Back Panel - ABS Plastic
Rated - 115 VAC, 50/60 Hz, 0.09 Amps
Free Flow Air Delivery - 32 CFM
<b>Colours</b>
DNFF080BK115 - Black
DNFF080CG115 - Gray/Beige
DNFF080GY115 - Gray
DNFF080LG115 - Light Gray
<b>Hardware</b>
8 Screws - Panhead Self-tapping 10-32 x 1/2"
4 Speed Nuts

