

**General Description**

The DSC2210FL2-A0026 is a programmable, high performance LVCMOS oscillators utilizing Microchip's proven silicon MEMS technology to provide excellent jitter and stability while incorporating additional device functionality.

The DSC2210FL2-A0026 allows the user to easily modify the frequency using SPI interface. The user can also select from two pre-programmed default output frequencies using the frequency select pin.

**Applications**

- Consumer Electronics
- Storage Area Networks
  - SATA, SAS, Fibre Channel
- Passive Optical Networks
  - EPON, 10G-EPON, GPON, 10G-GPON
- Ethernet
  - 1G, 10GBASE-T/KR/LR/SR, and FCoE
- HD/SD/SDI Video & Surveillance
- PCI Express
- Automotive

**Features**

- Frequency and output formats:
  - LVCMOS
  - 75/25MHz
- Low RMS phase jitter: <1ps (typ)
- ±25ppm frequency stability
- -40°C to +105°C ext. industrial temperature range
- High supply noise rejection: -50dBc
- SPI programmable frequency and drive
- Excellent shock & vibration immunity
  - Qualified to MIL-STD-883
- High reliability
  - 20x better MTF than quartz oscillators
- Supply range of 2.25 to 3.6V
- 14-pin 3.2mm x 2.5mm QFN package

**Block Diagram**

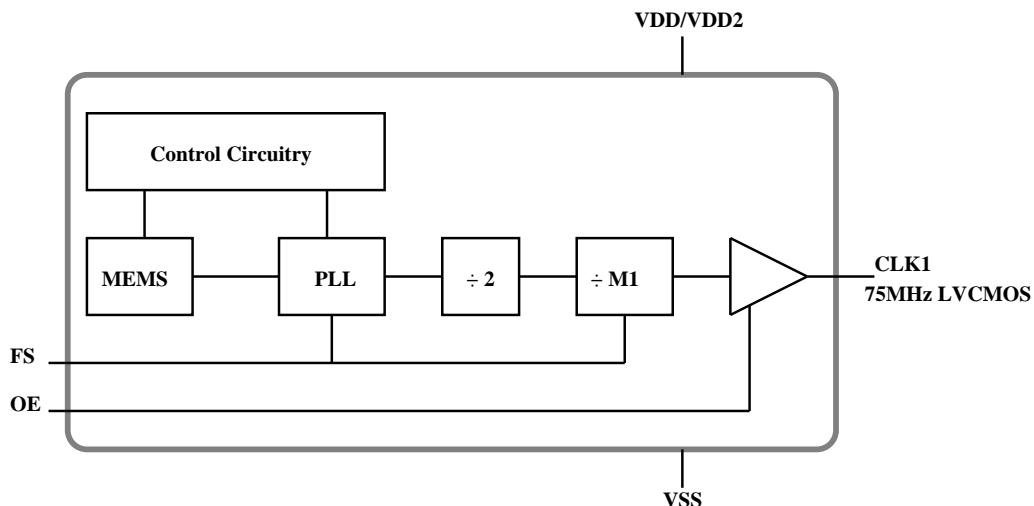

ClockWorks is a registered trademark of Microchip Technology Inc.

## Ordering Information

Ordering Part Number	Industrial Temperature Range	Shipping	Package
DSC2210FL2-A0026	-40°C to +105°C	Tube	14-pin 3.2mm x 2.5mm QFN
DSC2210FL2-A0026T	-40°C to +105°C	Tape and Reel	14-pin 3.2mm x 2.5mm QFN

Devices are Green and RoHS compliant. Sample material may have only a partial top mark.

## Pin Configuration

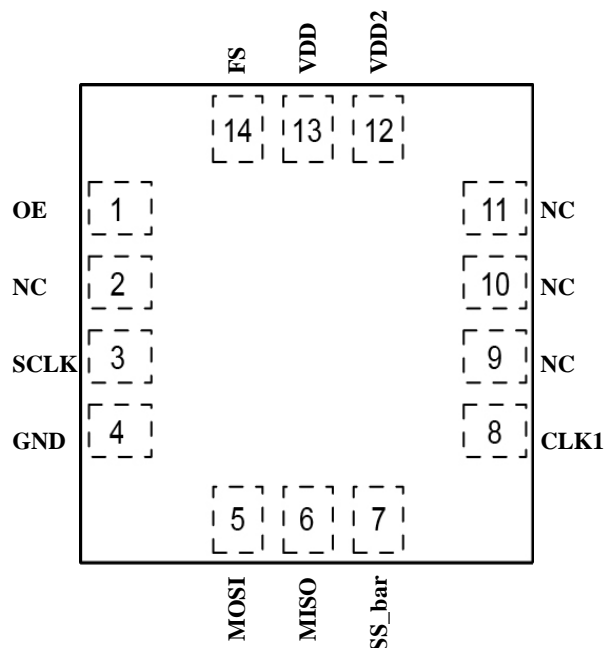

14-pin 3.2mm x 2.5mm QFN

## Pin Description

Pin Number	Pin Name	Pin Type	Pin Function
1	OE	I	Enables outputs when high and disables outputs when low
2	NC		Leave unconnected or connect to ground
3	SCLK	I	SPI serial clock from master to slave
4	GND	PWR	Ground
5	MOSI		SPI serial data from master to slave
6	MISO	O	SPI serial data from slave to master
7	SS_bar		SPI slave select (active low)
8	CLK1	O	LVC MOS output
9	NC		Leave unconnected or connect to ground
10	NC		Leave unconnected or connect to ground
11	NC		Leave unconnected or connect to ground
12, 13	VDD2, VDD	PWR	Power supply
14	FS	I	Frequency select pin, see Table 2 for details

## Operational Description

The DSC2210FL2-A0026 is a LVCMOS oscillator consisting of a MEMS resonator and a supporting PLL IC. The LVCMOS output is generated through independent 8-bit programmable dividers from the output of the internal PLL.

DSC2210FL2-A0026 allows for easy programming of the output frequencies using SPI interface. Upon power-up, the initial output frequency is controlled by an internal pre-programmed memory (OTP). This memory stores all coefficients required by the PLL for two different default frequencies. The control pin (FS) selects the initial frequency. Once the device is powered up, a new output frequency can be programmed. Programming details are provided in the Programming Guide.

When OE (pin 1) is floated or connected to VDD, the DSC2210FL2-A0026 is in operational mode. Driving OE to ground will disable both output drivers (hi-impedance mode).

DSC2210FL2-A0026 has programmable output drive strength, which can be controlled via SPI.

Table 1 displays typical rise / fall times for the output with a 15pF load capacitance as a function of these control bits at VDD = 3.3V and room temperature.

	Output Drive Strength Bits [OS2, OS1, OS0] - Default is [111]							
	000	001	010	011	100	101	110	<b>111</b>
tr (ns)	2.1	1.7	1.6	1.4	1.3	1.3	1.2	<b>1.1</b>
tf (ns)	2.5	2.4	2.4	2	1.8	1.6	1.3	<b>1.3</b>

Table 1. Rise/Fall Times for Drive Strengths

## Output Clock Frequencies

Frequency select bits are weakly tied high so if left unconnected the default setting will be [1] and the device will output the associated frequency highlighted in bold.

Freq (MHz)	Freq Select Bit [FS] - Default is [1]	
	0	<b>1</b>
CLK1	25	<b>75</b>

Table 2. Pin-Selectable Output Frequencies

## Absolute Maximum Ratings

Item	Min.	Max.	Units	Condition
Supply Voltage	-0.3	+4.0	V	
Input Voltage	-0.3	VDD + 0.3	V	
Junction Temp	-	+150	°C	
Storage Temp	-55	+150	°C	
Soldering Temp	-	+260	°C	40sec max.
ESD				
HBM		4000	V	
MM		400		
CDM		1500		

1000+ years of data retention on internal memory

**Specifications** (Unless specified otherwise: T = 25°C, max LVC MOS drive strength)

Parameter	Symbol	Condition	Min.	Typ.	Max.	Units
Supply Voltage <sup>1</sup>	VDD		2.25		3.6	V
Supply Current	IDD	OE pin low - output is disabled		21	23	mA
Frequency Stability	$\Delta F$	Includes frequency variation due to initial tolerance, temp. and power supply voltage			$\pm 25$	ppm
Aging	$\Delta F$	First year (@ 25°C)			$\pm 5$	ppm
Startup Time <sup>2</sup>	tSU	T = 25°C			5	ms
Input Logic Levels Input Logic High Input Logic Low	V <sub>IH</sub> V <sub>IL</sub>		0.75 x VDD -		- 0.25 x VDD	V
Output Disable Time <sup>3</sup>	tDA				5	ns
Output Enable Time <sup>3</sup>	tEN				20	ns
Pull-Up Resistor <sup>4</sup>		Pull-up exists on all digital IO		40		kOhms
<b>LVC MOS Output</b>						
Supply Current <sup>4</sup>	IDD	OE pin high - output is enabled CL = 15pF, F0 = 125MHz		31	35	mA
Output Logic Levels Output Logic High Output Logic Low	V <sub>OH</sub> V <sub>OL</sub>	I = $\pm 6$ mA	0.9 x VDD -		- 0.1 x VDD	V
Output Transition Time <sup>3</sup> Rise Time Fall Time	t <sub>R</sub> t <sub>F</sub>	20% to 80% CL = 15pF		1.1 1.3	2 2	ns
Frequency	CLK1	[FS] = [1]		75		MHz
Output Duty Cycle	SYM		45		55	%
Period Jitter	JPER	F0 = 125MHz		3		psRMS
Integrated Phase Noise	JPH	200kHz to 20MHz @ 125MHz 100kHz to 20MHz @ 125MHz 12kHz to 20MHz @ 125MHz		0.3 0.38 1.7	2	psRMS

**Notes:**

- Pin 12 VDD2, and pin 13 VDD should be filtered with 0.1uF capacitors.
- tSU is time to 100ppm stable output frequency after VDD is applied and outputs are enabled.
- Output Waveform and Test Circuit figures below define the parameters.
- Output is enabled if OE pin is floated or not connected.

**Nominal Performance Parameters** (Unless specified otherwise: T = 25°C, VDD = 3.3V)

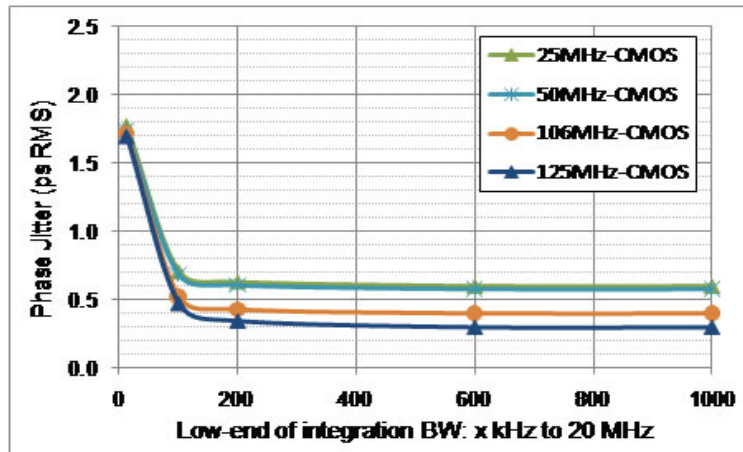

Figure 1. LVC MOS Phase Jitter (integrated phase noise)

**LVC MOS Output Waveform**

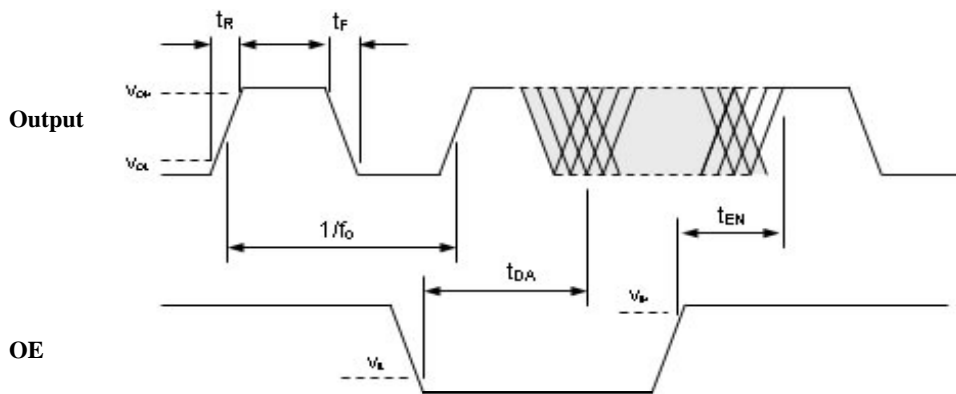

Figure 2. LVC MOS Output Waveform

MSL 1 @ 260°C refer to JSTD-020C	
Ramp-Up Rate (200°C to Peak Temp)	3°C/sec Max.
Preheat Time 150°C to 200°C	60 - 180 sec
Time maintained above 217°C	60 - 150 sec
Peak Temperature	255 - 260°C
Time within 5°C of actual Peak	20 - 40 sec
Ramp-Down Rate	6°C/sec Max.
Time 25°C to Peak Temperature	8 min Max.

## Solder Reflow Profile

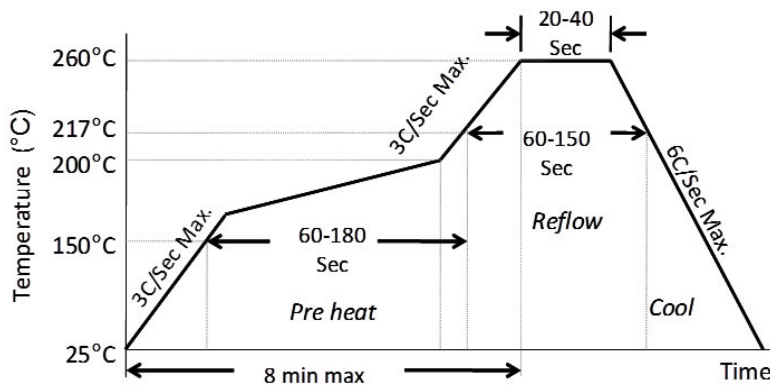
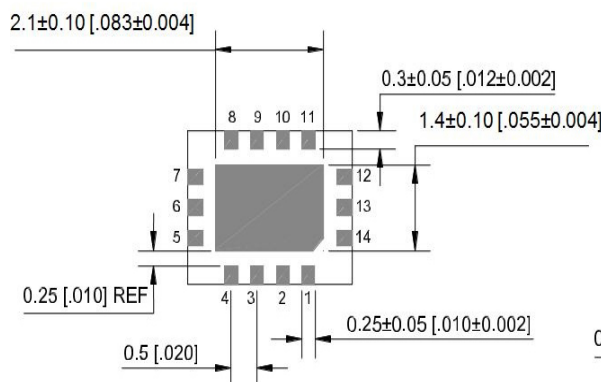
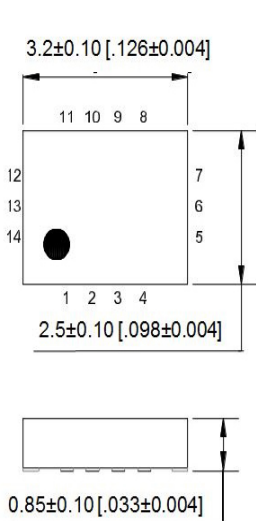

Figure 3. Solder Reflow Profile

## Package Information<sup>6</sup>

### External Dimensions

units: mm[inch]



### Recommended Solder Pad Layout

units: mm[inch]

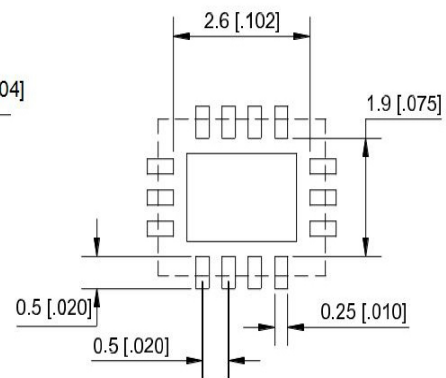

### 3.2mm x 2.5mm 14 Lead Plastic Package

#### Notes:

5. Connect the exposed die paddle to ground.
6. Package information is correct as of the publication date. For updates and most current information, go to [www.microchip.com](http://www.microchip.com).

Microchip makes no representations or warranties with respect to the accuracy or completeness of the information furnished in this data sheet. This information is not intended as a warranty and Microchip does not assume responsibility for its use. Microchip reserves the right to change circuitry, specifications and descriptions at any time without notice. No license, whether express, implied, arising by estoppel or otherwise, to any intellectual property rights is granted by this document. Except as provided in Microchip's terms and conditions of sale for such products, Microchip assumes no liability whatsoever, and Microchip disclaims any express or implied warranty relating to the sale and/or use of Microchip products including liability or warranties relating to fitness for a particular purpose, merchantability, or infringement of any patent, copyright or other intellectual property right.

Microchip products are not designed or authorized for use as components in life support appliances, devices or systems where malfunction of a product can reasonably be expected to result in personal injury. Life support devices or systems are devices or systems that (a) are intended for surgical implant into the body or (b) support or sustain life, and whose failure to perform can be reasonably expected to result in a significant injury to the user. A Purchaser's use or sale of Microchip Products for use in life support appliances, devices or systems is a Purchaser's own risk and Purchaser agrees to fully indemnify Microchip for any damages resulting from such use or sale.