

Base strip - MC 1.5/ 5-G-3.5-THT - 1937525

Please be informed that the data shown in this PDF Document is generated from our Online Catalog. Please find the complete data in the user's documentation. Our General Terms of Use for Downloads are valid (<http://download.phoenixcontact.com>)

Header, Nominal current: 8 A, Rated voltage (III/2): 160 V, Number of positions: 5, Pitch: 3.5 mm, Color: Black, Contact surface: Tin, Assembly: SMD/THT/THR, User information and design recommendations on through hole reflow technology can be found at: <http://www.combicon.com>



The figure shows a 10-position version of the product

Why buy this product

- Plug-in direction parallel to the PCB
- 3.5 mm pitch
- Low-profile THR headers with a compact pitch
- Delivery form: box packaging, in bulk for small series
- Delivery form: tape-on-reel packing according to IEC 60286-3 for automated mounting
- Use in SMT reflow processes



Key commercial data

Packing unit	1
Minimum order quantity	50
Catalog page	Page 196 (CC-2011)
GTIN	4 017918 895143
Custom tariff number	85366990
Country of origin	GERMANY

Technical data

Dimensions / positions

Length	9.2 mm
Pitch	3.5 mm
Dimension a	14 mm
Number of positions	5
Pin dimensions	0,8 x 0,8 mm
Hole diameter	1.4 mm

Technical data

Range of articles	MC 1,5/...G-THT
-------------------	-----------------

Base strip - MC 1.5/ 5-G-3.5-THT - 1937525

Technical data

Technical data

Insulating material group	IIIa
Rated surge voltage (III/3)	2.5 kV
Rated surge voltage (III/2)	2.5 kV
Rated surge voltage (II/2)	2.5 kV
Rated voltage (III/2)	160 V
Rated voltage (II/2)	250 V
Connection in acc. with standard	EN-VDE
Nominal current I _N	8 A
Nominal voltage U _N	160 V
Maximum load current	8 A (per position)
Insulating material	PA-GF
Inflammability class according to UL 94	V0
Color	Black
Nominal voltage, UL/CUL Use Group B	300 V
Nominal current, UL/CUL Use Group B	8 A
Nominal voltage, UL/CUL Use Group D	300 V
Nominal current, UL/CUL Use Group D	8 A

Classifications

eclass

eCl@ss 4.0	272607xx
eCl@ss 4.1	27260701
eCl@ss 5.0	27260701
eCl@ss 5.1	27260701
eCl@ss 6.0	27260704
eCl@ss 7.0	27440402

etim

ETIM 3.0	EC001121
ETIM 4.0	EC002637
ETIM 5.0	EC002637

unspsc

UNSPSC 6.01	30211810
UNSPSC 7.0901	39121409
UNSPSC 11	39121409
UNSPSC 12.01	39121409
UNSPSC 13.2	39121409

Approvals

Approvals

Base strip - MC 1.5/ 5-G-3.5-THT - 1937525

Approvals

Approvals

VDE report with production monitoring / GOST / IECCEB Scheme / UL Recognized / cUL Recognized / GOST / cULus Recognized

Ex Approvals

Approvals submitted

Approval details

VDE report with production monitoring 	
Nominal current I _N	8 A
Nominal voltage U _N	160 V

GOST 
--

IECCEB Scheme	
Nominal current I _N	8 A
Nominal voltage U _N	160 V

UL Recognized 		
	B	D
Nominal current I _N	8 A	8 A
Nominal voltage U _N	300 V	300 V

cUL Recognized 		
	B	D
Nominal current I _N	8 A	8 A
Nominal voltage U _N	300 V	300 V

Base strip - MC 1.5/ 5-G-3.5-THT - 1937525

Approvals

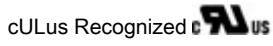

Drawings

Drilling diagram

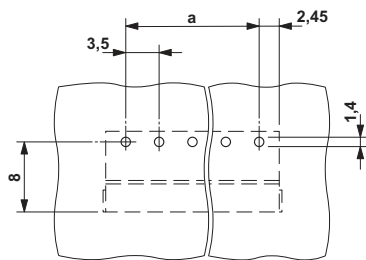

Dimensioned drawing

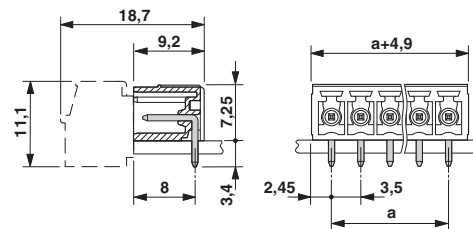

Dimensioned drawing

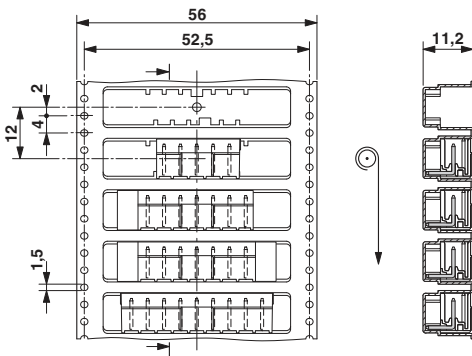

Base strip - MC 1.5/ 5-G-3.5-THT - 1937525

Dimensioned drawing

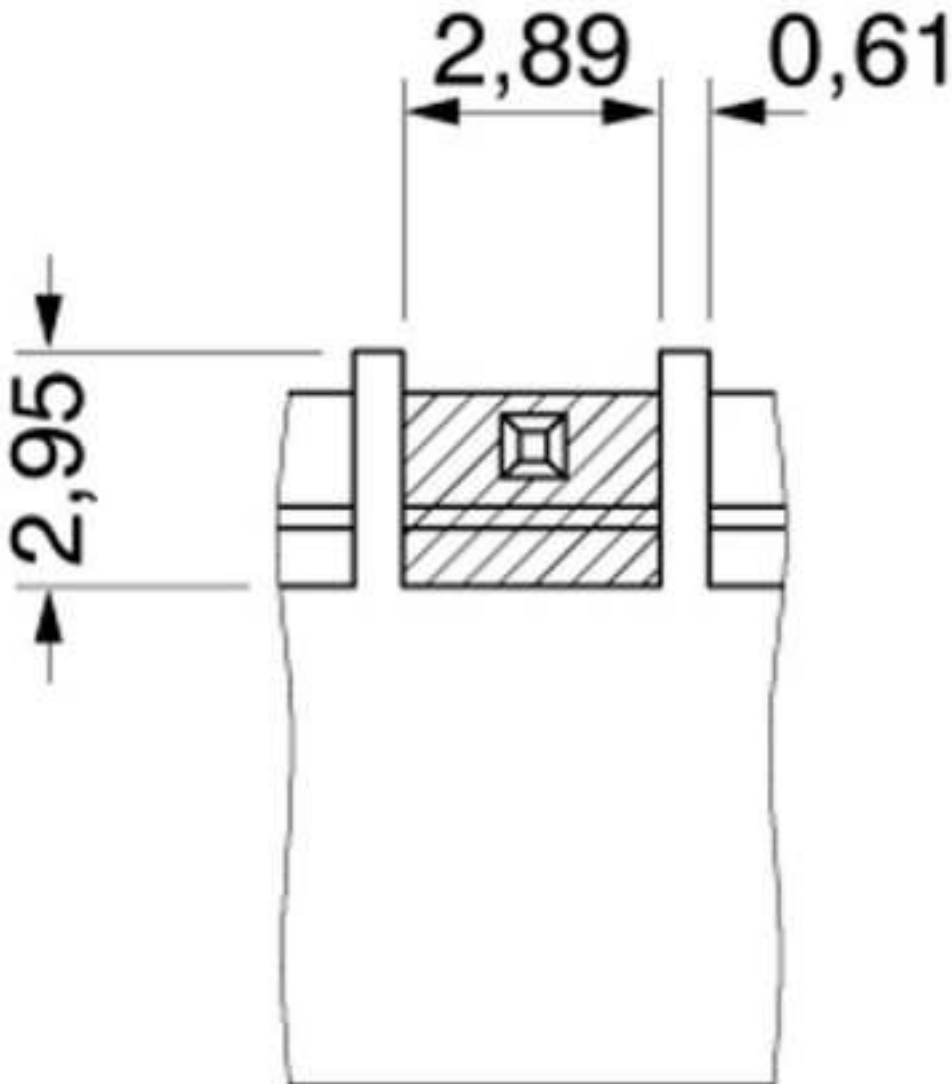

Bottom view, free space for solder paste, 0.3 mm deep