

TPS61040EVM-002

White Light LED Bias Supply Evaluation Module

User's Guide

IMPORTANT NOTICE

Texas Instruments Incorporated and its subsidiaries (TI) reserve the right to make corrections, modifications, enhancements, improvements, and other changes to its products and services at any time and to discontinue any product or service without notice. Customers should obtain the latest relevant information before placing orders and should verify that such information is current and complete. All products are sold subject to TI's terms and conditions of sale supplied at the time of order acknowledgment.

TI warrants performance of its hardware products to the specifications applicable at the time of sale in accordance with TI's standard warranty. Testing and other quality control techniques are used to the extent TI deems necessary to support this warranty. Except where mandated by government requirements, testing of all parameters of each product is not necessarily performed.

TI assumes no liability for applications assistance or customer product design. Customers are responsible for their products and applications using TI components. To minimize the risks associated with customer products and applications, customers should provide adequate design and operating safeguards.

TI does not warrant or represent that any license, either express or implied, is granted under any TI patent right, copyright, mask work right, or other TI intellectual property right relating to any combination, machine, or process in which TI products or services are used. Information published by TI regarding third-party products or services does not constitute a license from TI to use such products or services or a warranty or endorsement thereof. Use of such information may require a license from a third party under the patents or other intellectual property of the third party, or a license from TI under the patents or other intellectual property of TI.

Reproduction of information in TI data books or data sheets is permissible only if reproduction is without alteration and is accompanied by all associated warranties, conditions, limitations, and notices. Reproduction of this information with alteration is an unfair and deceptive business practice. TI is not responsible or liable for such altered documentation.

Resale of TI products or services with statements different from or beyond the parameters stated by TI for that product or service voids all express and any implied warranties for the associated TI product or service and is an unfair and deceptive business practice. TI is not responsible or liable for any such statements.

Following are URLs where you can obtain information on other Texas Instruments products and application solutions:

Products		Applications	
Amplifiers	amplifier.ti.com	Audio	www.ti.com/audio
Data Converters	dataconverter.ti.com	Automotive	www.ti.com/automotive
DSP	dsp.ti.com	Broadband	www.ti.com/broadband
Interface	interface.ti.com	Digital Control	www.ti.com/digitalcontrol
Logic	logic.ti.com	Military	www.ti.com/military
Power Mgmt	power.ti.com	Optical Networking	www.ti.com/opticalnetwork
Microcontrollers	microcontroller.ti.com	Security	www.ti.com/security
		Telephony	www.ti.com/telephony
		Video & Imaging	www.ti.com/video
		Wireless	www.ti.com/wireless

Mailing Address: Texas Instruments
Post Office Box 655303 Dallas, Texas 75265

EVM IMPORTANT NOTICE

Texas Instruments (TI) provides the enclosed product(s) under the following conditions:

This evaluation kit being sold by TI is intended for use for **ENGINEERING DEVELOPMENT OR EVALUATION PURPOSES ONLY** and is not considered by TI to be fit for commercial use. As such, the goods being provided may not be complete in terms of required design-, marketing-, and/or manufacturing-related protective considerations, including product safety measures typically found in the end product incorporating the goods. As a prototype, this product does not fall within the scope of the European Union directive on electromagnetic compatibility and therefore may not meet the technical requirements of the directive.

Should this evaluation kit not meet the specifications indicated in the EVM User's Guide, the kit may be returned within 30 days from the date of delivery for a full refund. **THE FOREGOING WARRANTY IS THE EXCLUSIVE WARRANTY MADE BY SELLER TO BUYER AND IS IN LIEU OF ALL OTHER WARRANTIES, EXPRESSED, IMPLIED, OR STATUTORY, INCLUDING ANY WARRANTY OF MERCHANTABILITY OR FITNESS FOR ANY PARTICULAR PURPOSE.**

The user assumes all responsibility and liability for proper and safe handling of the goods. Further, the user indemnifies TI from all claims arising from the handling or use of the goods. Please be aware that the products received may not be regulatory compliant or agency certified (FCC, UL, CE, etc.). Due to the open construction of the product, it is the user's responsibility to take any and all appropriate precautions with regard to electrostatic discharge.

EXCEPT TO THE EXTENT OF THE INDEMNITY SET FORTH ABOVE, NEITHER PARTY SHALL BE LIABLE TO THE OTHER FOR ANY INDIRECT, SPECIAL, INCIDENTAL, OR CONSEQUENTIAL DAMAGES.

TI currently deals with a variety of customers for products, and therefore our arrangement with the user **is not exclusive.**

TI assumes **no liability for applications assistance, customer product design, software performance, or infringement of patents or services described herein.**

Please read the EVM User's Guide and, specifically, the EVM Warnings and Restrictions notice in the EVM User's Guide prior to handling the product. This notice contains important safety information about temperatures and voltages. For further safety concerns, please contact the TI application engineer.

Persons handling the product must have electronics training and observe good laboratory practice standards.

No license is granted under any patent right or other intellectual property right of TI covering or relating to any machine, process, or combination in which such TI products or services might be or are used.

Mailing Address:

Texas Instruments
Post Office Box 655303
Dallas, Texas 75265

EVM WARNINGS AND RESTRICTIONS

It is important to operate this EVM within the specified input and output ranges described in the EVM User's Guide. This EVM is designed to operate over an input range of 1.8 V to 6 V and over a load range of 0.1 mA to 20 mA.

Exceeding the specified input range may cause unexpected operation and/or irreversible damage to the EVM. If there are questions concerning the input range, please contact a TI field representative prior to connecting the input power.

Applying loads outside of the specified output range may result in unintended operation and/or possible permanent damage to the EVM. Please consult the EVM User's Guide prior to connecting any load to the EVM output. If there is uncertainty as to the load specification, please contact a TI field representative.

During normal operation, some circuit components may have case temperatures greater than 60°C. The EVM is designed to operate properly with certain components above 60°C as long as the input and output ranges are maintained. These components include but are not limited to linear regulators, switching transistors, pass transistors, and current sense resistors. These types of devices can be identified using the EVM schematic located in the EVM User's Guide. When placing measurement probes near these devices during operation, please be aware that these devices may be very warm to the touch.

Mailing Address:

Texas Instruments
Post Office Box 655303
Dallas, Texas 75265

Read This First

About This Manual

This user's guide describes the characteristics, operation, and use of the TPS61040EVM-002 white light LED bias supply evaluation module (EVM). This EVM is a Texas Instruments high-efficiency boost converter configured to supply 20 mA of bias current to four white light LEDs, from a single-cell Li-ion battery. The user's guide includes a schematic diagram, bill of materials (BOM), and test data.

How to Use This Manual

This document contains the following chapters:

- Chapter 1 – Introduction
- Chapter 2 – Setup and Test Results
- Chapter 3 – Board Layout
- Chapter 4 – Schematic and Bill of Materials

Related Documentation From Texas Instruments

TPS61040/41 data sheet (literature number SLVS413)

FCC Warning

This equipment is intended for use in a laboratory test environment only. It generates, uses, and can radiate radio frequency energy and has not been tested for compliance with the limits of computing devices pursuant to subpart J of part 15 of FCC rules, which are designed to provide reasonable protection against radio frequency interference. Operation of this equipment in other environments may cause interference with radio communications, in which case the user at his own expense will be required to take whatever measures may be required to correct this interference.



This page intentionally left blank

Contents

1	Introduction	1-1
1.1	Background	1-2
1.2	Performance Specification Summary	1-2
2	Setup and Test Results	2-1
2.1	Input/Output Connections	2-2
2.2	EVM Operation	2-2
2.2.1	Analog Dimming With Analog Voltage	2-2
2.2.2	Analog Dimming With PWM Voltage	2-3
2.2.3	PWM Dimming Using Enable	2-4
2.2.4	PWM Dimming Using Injected Voltage on FB	2-4
2.3	Setup	2-4
2.4	Start-up	2-5
2.5	LED Ripple Current	2-6
2.6	Switching Waveforms	2-7
2.7	Efficiency	2-8
2.8	Analog Dimming With Analog Voltage Data	2-8
2.9	Analog Dimming With PWM Voltage Data	2-9
2.10	PWM Dimming Using Enable Data	2-10
2.11	PWM Dimming Using Injected Voltage on FB Data	2-12
3	Board Layout	3-1
3.1	Board Layout	3-2
4	Schematic and Bill of Materials	4-1
4.1	Schematic	4-2
4.2	Bill of Materials	4-2

Figures

2-1	Start-up Waveforms	2-5
2-2	Output Ripple Current	2-6
2-3	SW Waveform	2-7
2-4	Typical Efficiency	2-8
2-5	Output Current vs Control Voltage	2-8
2-6	PWM Control Converted to Analog Control Voltage	2-9
2-7	Input Current and Output Current With PWM Dimming Using Enable	2-10
2-8	Output Current vs Duty Cycle for PWM Dimming Using Enable	2-11
2-9	Control Voltage and Output Current	2-12
2-10	Output Current vs Duty Cycle	2-13
3-1	Assembly Layer	3-2
3-2	Top Layer Routing	3-2
3-3	Bottom Layer Routing	3-3

Tables

1-1	Performance Specification Summary	1-2
2-1	Input/Output Connections	2-2

Introduction

This chapter contains background information for the TPS61040 and support documentation for the TPS61040EVM-002 evaluation module.

Topic	Page
1.1 Background	1-2
1.2 Performance Specification Summary	1-2

1.1 Background

The TPS61040EVM uses the TPS61040 boost converter to provide 20 mA of bias current to a four-element white LED from a single-cell Li-ion battery (3 V to 4.2 V). The EVM operates over an input voltage range of 1.8 V to 6.0 V, but has been optimized over a 3-V to 4.2-V input range. Operation with an input voltage down to 1.8 V is possible, depending on the number of LEDs and the desired bias current. The EVM can also be configured for higher or lower output currents. For lower currents, the pin-for-pin compatible TPS61041 may replace the TPS61040. The EVM includes two adjust pins that allow the user to dim the LEDs using either an analog or a PWM dimming scheme. A third dimming method available to the user is to apply a PWM signal to the enable pin of the device. More information about output voltage and current ratings of TPS61040/41 devices can be found in the data sheet, literature number SLVS413.

1.2 Performance Specification Summary

Table 1–1 provides a summary of the TPS61040EVM–002 performance specifications. All specifications are given for an ambient temperature of 25°C. Although the EVM is designed for four LEDs, it may be modified to provide power for fewer or greater than four LEDs. See the TPS61040 data sheet for detailed specifications. The EVM may also be modified to operate at voltages down to 1.8 V and up to 6.0 V to match the TPS61040 data sheet specifications.

Table 1–1. Performance Specification Summary

Specification	Test Conditions	Min	Typ	Max	Units
Input voltage range	I _{out} = 20 mA	3.0		4.2	V
Load	I _{out} = 20 mA	Four white light LEDs			
Output current		0.1		20	mA
Efficiency	V _{in} = 4.2 V	86.5			%

Setup and Test Results

This chapter describes how to properly connect, set up, and use the TPS61040EVM-002. It also presents the test results for the EVM. All test results are measured with the EVM driving four white light LEDs.

Topic	Page
2.1 Input/Output Connections	2-2
2.2 EVM Operation	2-2
2.3 Setup	2-4
2.4 Start-up	2-5
2.5 LED Ripple Current	2-6
2.6 Switching Waveforms	2-7
2.7 Efficiency	2-8
2.8 Analog Dimming With Analog Voltage Data	2-8
2.9 Analog Dimming With PWM Voltage Data	2-9
2.10 PWM Dimming Using Enable Data	2-10
2.11 PWM Dimming Using Injected Voltage on FB Data	2-12

2.1 Input/Output Connections

The TPS61040EVM-002 PWB has several connections, which are described in Table 2-1.

Table 2-1. Input/Output Connections

Reference Designator	Name	Description
J1	Vin	This is the positive connection to the input power supply. Input supply leads (Vin and GND) should be a twisted pair and kept as short as possible.
J2	GND	This is the return connection for the input power supply.
J3	DIM1	Input for dimming adjust of LED current
J3	DIM2	Input for dimming adjust of LED current
J3	GND	Ground connection for the dimming adjust signal
J4	LED Anode	Output to anode of LED
J5	LED Cathode	Output to cathode of LED
J6	GND	Ground connection
JP1	Enable	Use this connector to enable and disable the power supply. Connect a jumper between the ON pin and the center pin to enable the supply. Connect a jumper between the OFF pin and the center pin to disable the supply. If this pin is left open, the EVM does not operate correctly. This pin is also used for PWM dimming control of the LED current.

2.2 EVM Operation

The EVM is configured as a constant current supply. Current regulation is accomplished by regulating the voltage across a current sense resistor. The EVM does not operate correctly unless a load is placed between J4 (LED Anode) and J5 (LED Cathode). With no load, the output voltage increases until clamped by the 27-V zener diode shown in the schematic.

The EVM provides the user with a place to add up to four LEDs (D2 through D6). More or fewer than four LEDs may be used, but the connections to the board must be made such that the load current flows from the LED anode connection to the LED cathode connection. If a resistive load is being substituted for LEDs, the load resistance must be small enough so that the resistance times the programmed load current is less than 27 V.

This EVM is designed to accommodate several LED-dimming techniques. Because of this flexibility, circuitry may be present on the EVM that is not needed for the particular dimming method you choose. Depending on the PWM dimming technique used, component values may need to be changed to provide the desired LED current level. Before using the EVM, determine the method of dimming. Descriptions of several dimming techniques follow.

2.2.1 Analog Dimming With Analog Voltage

One method for dimming the LEDs is to inject a voltage through a resistor into the FB pin of the TPS61040. The injected voltage artificially raises the voltage

seen at the FB pin, which lowers the LED current. If the resistor values are chosen correctly, the analog control voltage varies the output current between 0 mA and maximum programmed current. This dimming method is the default configuration of the EVM, and is accomplished by injecting an analog voltage into the DIM1 pin on J3. When using this method, R1 and C2 do not affect the operation of the EVM. The EVM is designed so that an analog voltage of 0 V to 3.3 V varies the LED current from 20 mA to 0 mA. Use the following equations to calculate the required resistor values.

Where:

- V_{REF} is the TPS61040 reference voltage = 1.233 V.
- V_{adj_min} is the minimum adjust voltage.
- V_{adj_max} is the maximum adjust voltage.
- I_{out_min} is the minimum output current.
- I_{out_max} is the maximum output current.
- R2 is a dimming resistor.
- Ref Des corresponds to the EVM schematic shown in Chapter 4.

$$R3 = V_{REF} \times \frac{(I_{o_min} \times R2 + V_{adj_max} - I_{o_max} \times R2 - V_{adj_min})}{(V_{FB} \times I_{o_max} - V_{adj_max} \times I_{o_max} - V_{FB} \times I_{o_min} + V_{adj_min} \times I_{o_min})}$$

$$R4 = \frac{V_{FB} \times R2 + V_{FB} \times R3 - V_{adj_max} \times R3}{I_{o_min} \times R2 - V_{FB} + V_{adj_max}}$$

For the EVM, $V_{REF} = 1.233$ V, $V_{adj_min} = 0$ V, $V_{adj_max} = 3.3$ V, $I_{out_min} = 0$ A, $I_{out_max} = 20$ mA, and $R2 = 249$ k Ω . Using these values, R3 is calculated to be 148.3 k Ω , and R4 is calculated to be 98.4 Ω .

2.2.2 Analog Dimming With PWM Voltage

The second method for dimming the LEDs is to inject a pulse width modulated (PWM) voltage for analog dimming. With this method, an RC filter is used to convert the PWM control voltage into an analog voltage. The component values of the RC filter depend on the frequency of the PWM voltage and the amount of allowable ripple on the converted analog signal. The converted analog voltage is then injected into the FB pin of the TPS61040 as in the *Analog Dimming With Analog Voltage* method. The output current decreases as the duty cycle increases. Inject the PWM control voltage into the DIM2 pin on J3. Assuming that the PWM control voltage amplitude varies between 0 V and 3.3 V, the resistor values calculated in the *Analog Dimming with Analog Voltage* method may still be used. The PWM control voltage is converted to its equivalent analog control voltage using the following equation.

$$V_{analog} = V_{pwm_pk} \times D + V_{min}$$

Where:

- V_{pwm_pk} is the peak-to-peak voltage of the injected PWM signal.
- D is the duty cycle of the injected PWM signal.
- V_{min} is the minimum voltage of the injected PWM signal.

2.2.3 PWM Dimming Using Enable

The third method for dimming the LEDs is to inject a PWM voltage into the EN pin of the TPS61040. When the EN pin is high, the supply turns on and the output current is at the programmed maximum current. When the EN pin is low, the supply turns off and the output current goes to 0 mA. If the frequency of the PWM voltage is greater than 100 Hz, the human eye can not detect the on and off state of the LED current. The human eye averages the on and off state of the LED and sees a dimmed diode rather than a pulsed brightness. This dimming method provides a controlled inrush current at turnon, but limits the maximum PWM frequency to about 200 Hz, due to the fact that the IC enters soft start during the first 1.5 ms of each pulse. A PWM duty cycle of 0% produces 0 mA of output current; a duty cycle of 100% produces the maximum programmed output current. For this dimming method, remove R2 and C2, short R3, and inject the PWM signal into the center pin of JP1. R4 is calculated by the following equation where V_{REF} is the reference voltage of the TPS61040 (1.233 V) and I_{max} is the maximum desired output current. The reference designators correspond to the EVM schematic shown in Chapter 4.

$$R4 = \frac{V_{REF}}{I_{max}}$$

For an output current of 20 mA, $R4 = 61.6 \Omega$.

2.2.4 PWM Dimming Using Injected Voltage on FB

The fourth method for dimming the LEDs is to inject a PWM control voltage into the FB pin of the TPS61040. When the control voltage is low, the output current is at its maximum programmed value. When the control voltage is high, the output current is 0 mA. As with the PWM dimming using the enable pin, the PWM frequency should be at least 100 Hz. Because the device does not enter soft start during each pulse cycle, the maximum PWM frequency can be increased to over 20 kHz. The equations for determining the resistor values are the same as for the *Analog Dimming With Analog Voltage* method. For this dimming method, remove R1 and C2, and inject the PWM signal into the DIM1 pin on J3.

2.3 Setup

After the EVM has been modified for the appropriate dimming method, connect an input supply between J1 and J2. Connect the LEDs between the LED anode and LED cathode connection points. The EVM operates between 1.8 V and 6.0 V. Ensure that the input voltage never exceeds the TPS61040 absolute maximum input voltage rating of 7.0 V. Move the *adjust* jumper from the *Off* position to the *On* position to enable the supply.

2.4 Start-up

When enabled, the EVM goes through its programmed three-stage soft-start sequence to reduce inrush current at turnon. Figure 2–1 shows the startup sequence of the EVM when powered from a 4.0-V Li-ion battery. The top oscilloscope trace is the input current and the bottom trace is the output current.

Figure 2–1. Start-up Waveforms

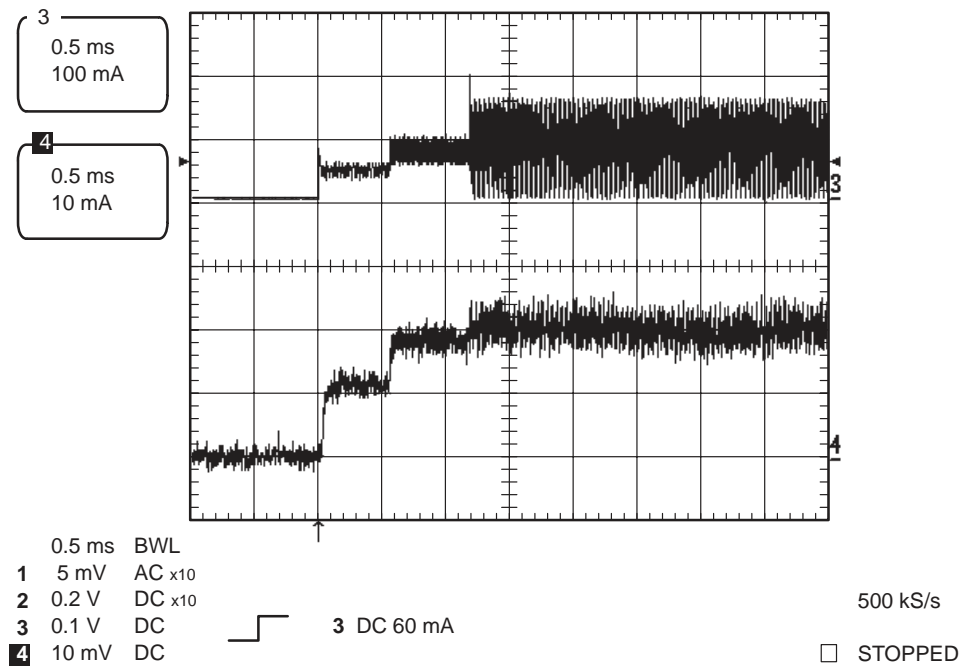

2.5 LED Ripple Current

Figure 2–2 shows the output ripple current with $I_{out} = 20\text{ mA}$. The top oscilloscope trace shows the ripple with 3.6-V input, and the bottom trace shows the ripple with a 4.2-V input. The difference in switching frequency between the two traces is expected and is explained in the data sheet.

Figure 2–2. Output Ripple Current

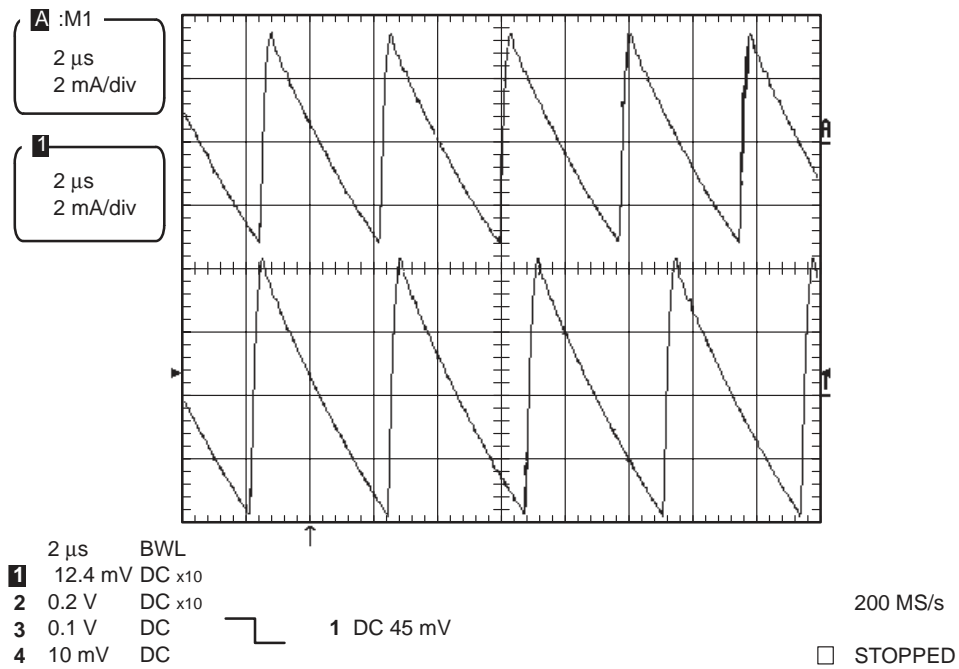

2.6 Switching Waveforms

Figure 2–3 shows the switching waveform at the SW pin of the TPS61040. When the internal FET turns on, the voltage at the SW pin is pulled to ground until the inductor current reaches 400 mA. When the inductor current reaches 400 mA, the FET turns off and the voltage at the SW pin rises to the output voltage plus the forward voltage drop of the diode. During this time, the inductor transfers its stored energy to the load and the output capacitor. When the inductor current decays to zero, the SW node rings at a frequency determined by the output inductor and the drain capacitance of the internal FET. This ringing indicates a discontinuous boost power supply topology, and confirms that the inductor current has gone discontinuous.

Figure 2–3. SW Waveform

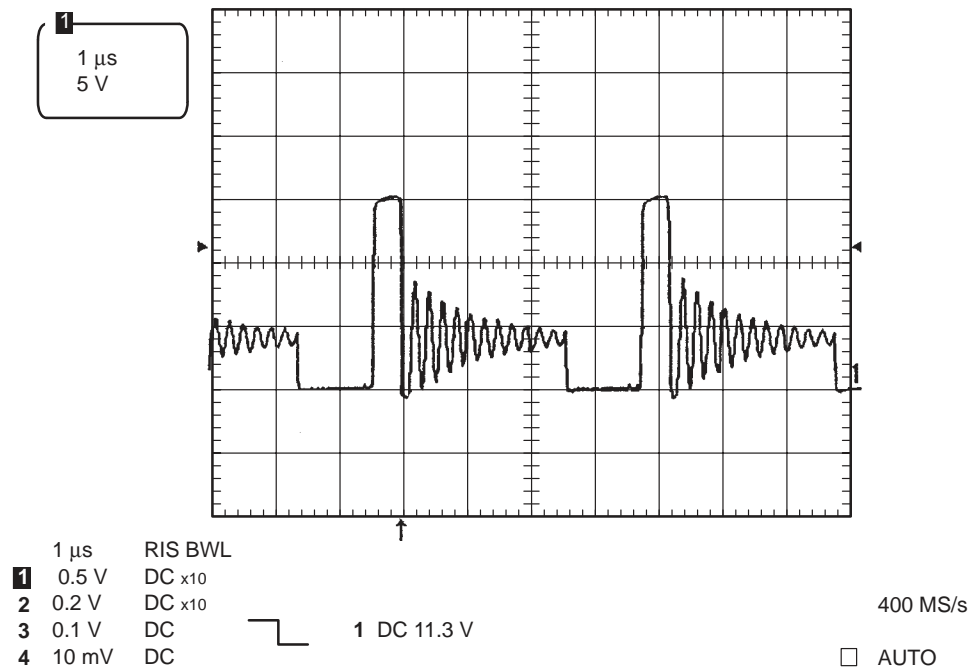

2.7 Efficiency

Figure 2–4 shows the measured efficiency of the TPS61040.

Figure 2–4. Typical Efficiency

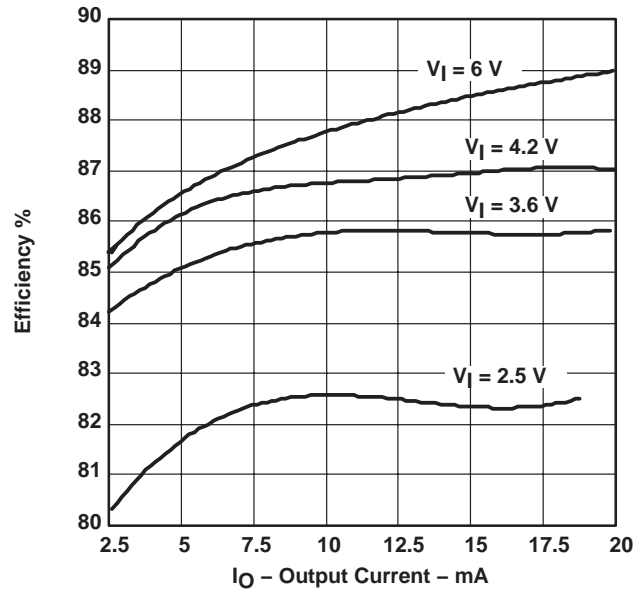

2.8 Analog Dimming With Analog Voltage Data

The EVM was modified to generate a 0 mA to 20 mA output when the control voltage is varied from 3.3 V to 0 V. The appropriate component values may be calculated using the equations provided in the *Analog Dimming with Analog Voltage* section. Using the closest standard values available, R2 = 249 kΩ, R3 = 147 kΩ, and R4 = 100 Ω. Figure 2–5 shows the linear relationship between the output current and the control voltage injected into DIM1.

Figure 2–5. Output Current vs Control Voltage

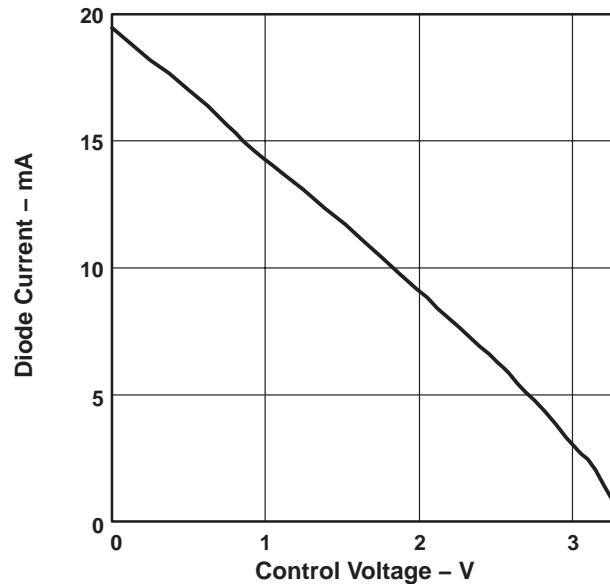

2.9 Analog Dimming With PWM Voltage Data

For the *Analog Dimming With PWM Voltage* method, the EVM is configured identically with the *Analog Dimming With Analog Voltage* method with the exception that the control voltage is injected into the DIM2 pin on J3. R1 and C2 are chosen to be 10 kΩ and 1 μF to adequately filter a 1-kHz control voltage. Figure 2–6 shows how the PWM control voltage at the DIM2 pin on J3 is converted into an equivalent analog voltage on the DIM1 pin on J3. The graph of the output current versus the control voltage is identical to Figure 2–5 after the PWM control voltage is converted into its average dc equivalent.

Figure 2–6. PWM Control Converted to Analog Control Voltage

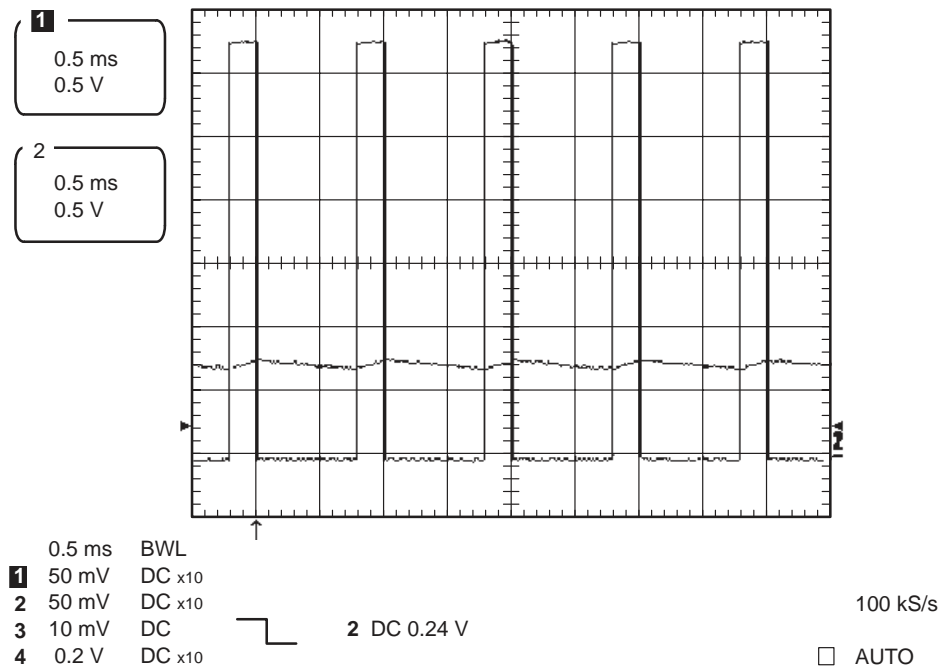

2.10 PWM Dimming Using Enable Data

For the *PWM Dimming Using Enable* method, the EVM is configured with R2= open and R3 = short. Setting R4 = 61.9 Ω programs the maximum output current to 20 mA. Figure 2–7 shows input current and output current with the PWM frequency set to 100 Hz and 50% duty cycle. The top oscilloscope trace is the output current and the bottom trace is the control voltage seen on the EN pin. Note the three-stage soft start during the first 1.5 ms of each cycle. Figure 2–8 shows the output current versus the duty cycle of the control voltage.

Figure 2–7. Input Current and Output Current With PWM Dimming Using Enable

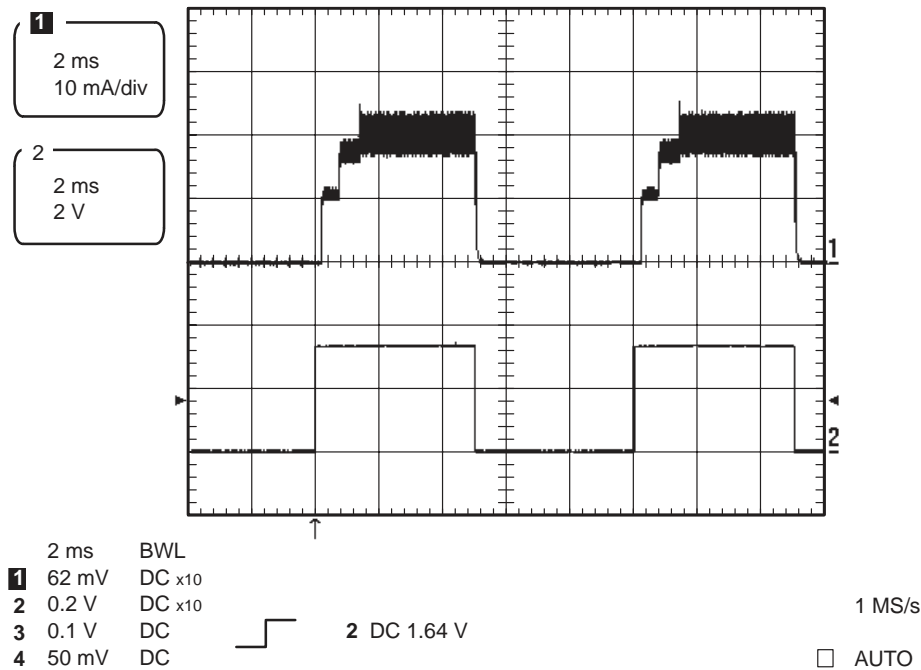
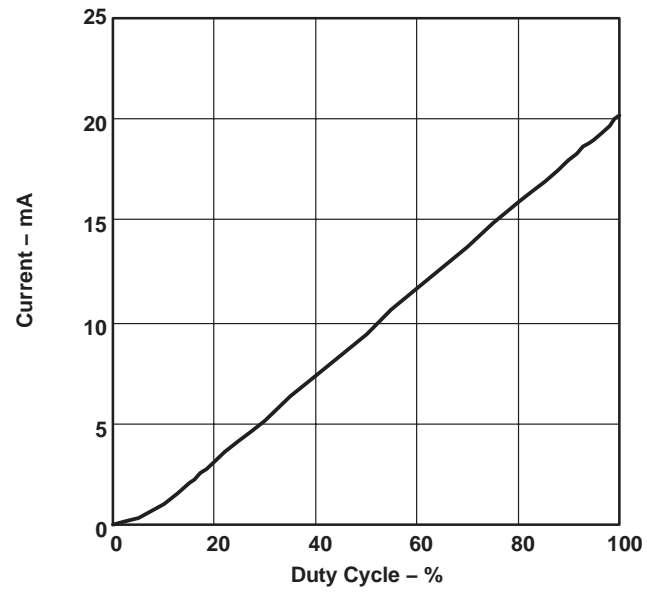

Figure 2-8. Output Current vs Duty Cycle for PWM Dimming Using Enable



2.11 PWM Dimming Using Injected Voltage on FB Data

For the *PWM Dimming Using Injected Voltage on FB* method, a 0-V to 3.3-V control voltage is used to program a maximum LED current of 20 mA. Use the equations found in the *Analog Dimming Using Analog Voltage* section to calculate the resistor values. The following component values are used: $R_2 = 249\text{ k}\Omega$, $R_3 = 147\text{ k}\Omega$, $R_4 = 100\ \Omega$. R_2 and C_2 are unpopulated (left open) for this configuration. The control voltage is injected into DIM1 on J3. Figure 2–9 shows the control voltage and the output current for a 5-kHz, 50% duty cycle control voltage waveform. The top oscilloscope trace is the output current and the bottom trace is the control voltage. Figure 2–10 shows the output current versus duty cycle for different PWM frequencies. The increased current at higher frequencies results from the fact that the discharge time of the output capacitor takes a larger percentage of the overall *off* time.

Figure 2–9. Control Voltage and Output Current

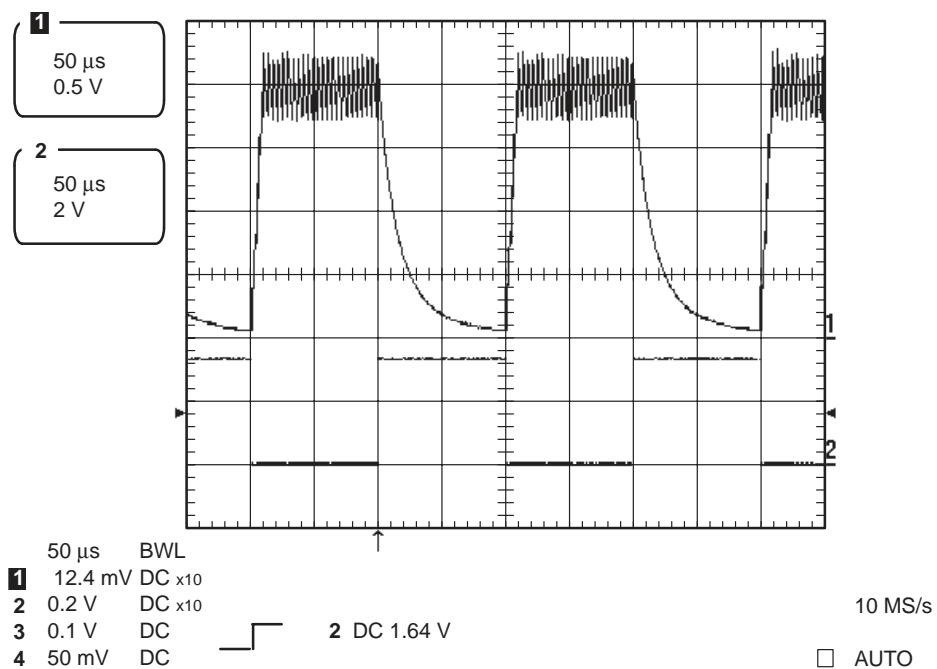
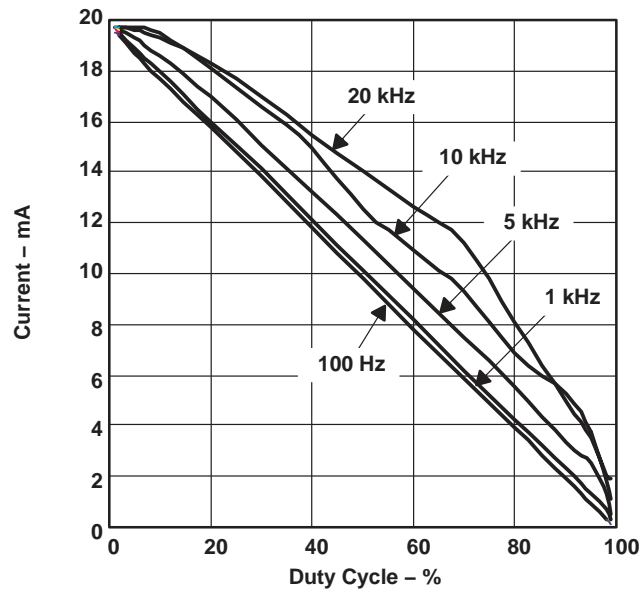

Figure 2-10. Output Current vs Duty Cycle





This page intentionally left blank

Board Layout

This chapter provides the TPS61040EVM-002 board layout and illustrations.

Topic	Page
3.1 Board Layout	3-2

3.1 Board Layout

Board layout is critical for all switch mode power supplies. Figures 3–1, 3–2, and 3–3 show the board layout for the TPS61040EVM–002 PWB. The nodes with a high switching frequency are short and are isolated from the noise-sensitive feedback circuitry. Careful attention is given to the routing of high-frequency current loops. See the data sheet for specific layout guidelines.

Figure 3–1. Assembly Layer

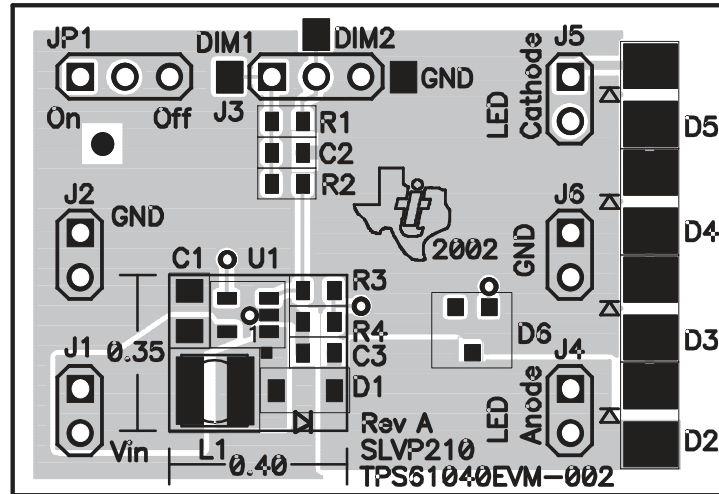

Figure 3–2. Top Layer Routing

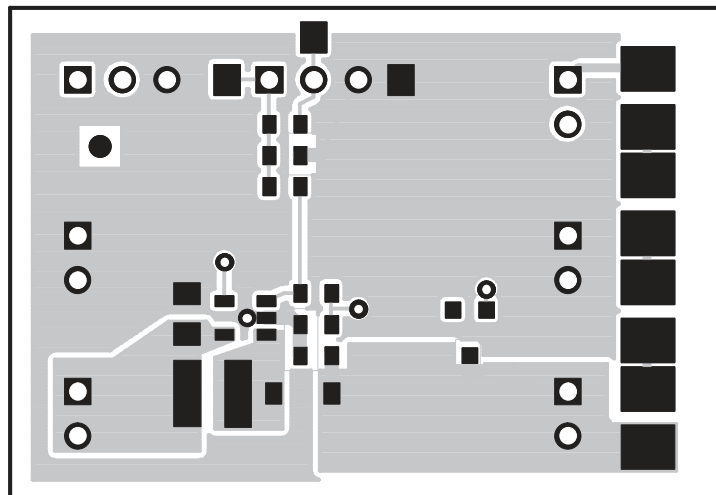
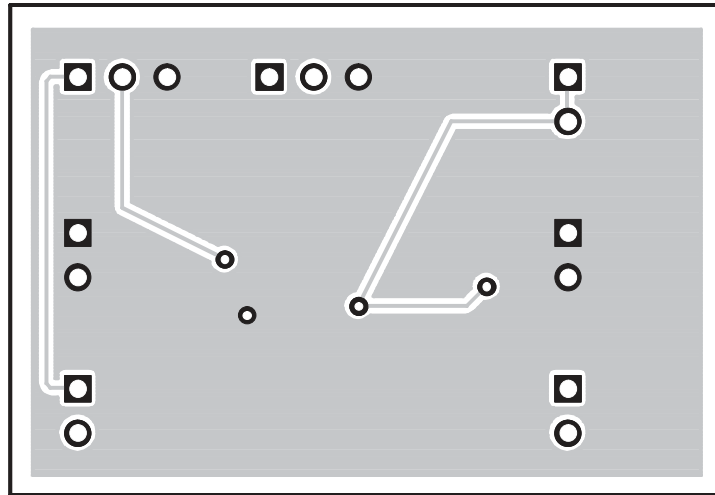

Figure 3-3. Bottom Layer Routing





This page intentionally left blank

Schematic and Bill of Materials

This chapter provides the TPS61040EVM-002 schematic and bill of materials.

Topic	Page
4.1 Schematic	4-2
4.2 Bill of Materials	4-2

4.1 Schematic

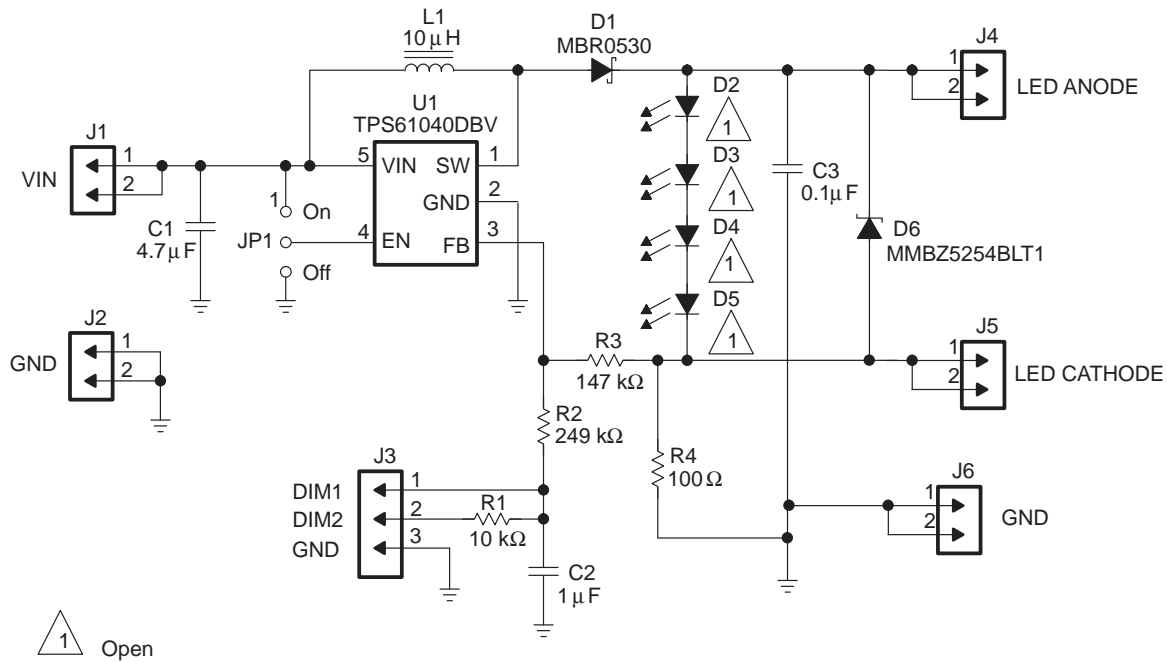

4.2 Bill of Materials

Qty	Reference Designator	Description	Size	MFR	Part Number
1	C2	Capacitor, ceramic, 1.0 µF, 6.3 V, X5R, 15%	603	Murata	GRM188R60J105KA01
1	C3	Capacitor, ceramic, 0.1 µF, 16 V, X7R, 10%	603	Murata	GRM188R71C104KA01
1	D1	Diode, Schottky, 350 mA, 40V	SOD-123	OnSemi	MBR0530T1
	D2, D3, D4, D5	Unpopulated (open)			
1	D6	Diode, Zener, 27 V, 94 mA, 225 mW, 5%	SOT23	Motorola	MMBZ5254BLT1
5	J1, J2, J4, J5, J6	Header, 2 pin, 100 -mil spacing, (36-pin strip)	0.100 x 2"	Sullins	PTC36SAAN
1	J3	Header, 3 pin, 100-mil spacing, (36-pin strip)	0.100 x 3"	Sullins	PTC36SAAN
1	JP1	Header, 3 pin, 100-mil spacing, (36-pin strip)	0.100 x 3"	Sullins	PTC36SAAN
1	L1	Inductor, SMT, 10 µH, 0.76 A, 0.23 mΩ	0.150 x 0.162	Sumida	CR32-100
1	R1	Resistor, chip, 10.0 kΩ, 1/16 W, 1%	603	Std	Std
1	R2	Resistor, chip, 249 kΩ, 1/16 W, 1%	603	Std	Std
1	R3	Resistor, chip, 147 kΩ, 1/16 W, 1%	603	Std	Std
1	R4	Resistor, chip, 100 Ω, 1/16 W, 1%	603	Std	Std
1	U1	IC, High-efficiency boost converter	SOT23-5 (DBV)	TI	TPS61040DBV
1	--	PCB, 1.6 In x 1.1 In x 0.062 In		Any	SLVP210
1	--	Shunt, 100 mil, black	0.100	3M	929950-00