



# STGD7NB60K STGP7NB60K

N-channel 600V - 7A - TO-220 / DPAK  
Short circuit rated PowerMESH™ IGBT

## General features

Type	V <sub>CES</sub>	V <sub>CE(sat)</sub> Max @25°C	I <sub>C</sub> @100°C
STGD7NB60K	600V	< 2.8V	7A
STGP7NB60K	600V	< 2.8V	7A

- High input impedance (voltage driven)
- Low on-voltage drop (V<sub>cesat</sub>)
- Low gate charge
- High current capability
- High frequency operation
- Short circuit rated

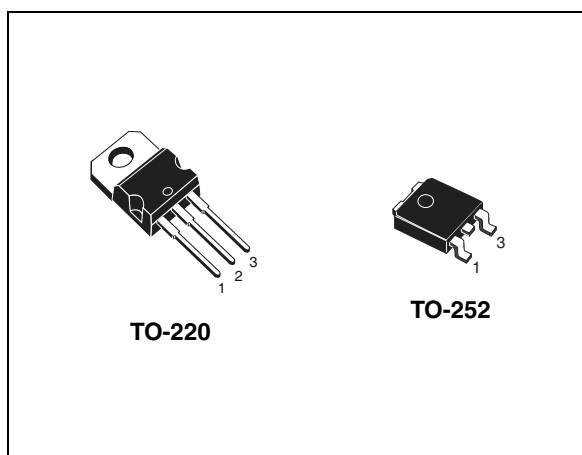

## Description

Using the latest high voltage technology based on a patented strip layout, STMicroelectronics has designed an advanced family of IGBTs, the PowerMESH™ IGBTs, with outstanding performances. The suffix “K” identifies a family optimized for high frequency motor control applications with short circuit withstand capability.

## Applications

- High frequency motor controls
- SMPS and PFC in both hard switching and resonant topologies

## Internal schematic diagram

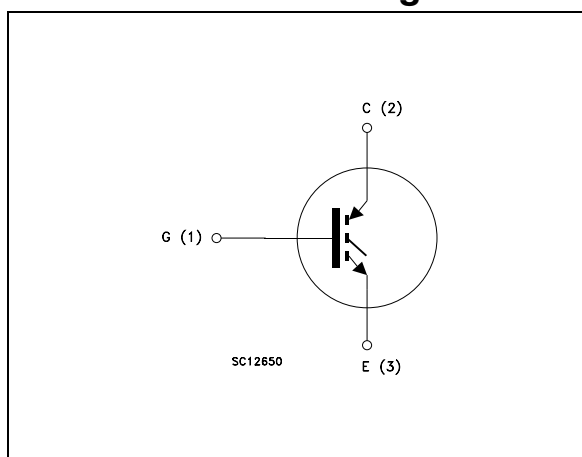

## Order codes

Part number	Marking	Package	Packaging
STGD7NB60KT4	GD7NB60K	DPAK	Tape & reel
STGP7NB60K	GP7NB60K	TO-220	Tube

# Contents

<b>1</b>	<b>Electrical ratings</b> .....	<b>3</b>
<b>2</b>	<b>Electrical characteristics</b> .....	<b>4</b>
	2.1 Electrical characteristics (curves) .....	6
<b>3</b>	<b>Test circuit</b> .....	<b>9</b>
<b>4</b>	<b>Package mechanical data</b> .....	<b>10</b>
<b>5</b>	<b>Packaging mechanical data</b> .....	<b>13</b>
<b>6</b>	<b>Revision history</b> .....	<b>14</b>

# 1 Electrical ratings

**Table 1. Absolute maximum ratings**

Symbol	Parameter	Value		Unit
		TO-220	DPAK	
V <sub>CES</sub>	Collector-emitter voltage (V <sub>GS</sub> = 0)	600		V
I <sub>C</sub> <sup>(1)</sup>	Collector current (continuous) at T <sub>C</sub> = 25°C	14		A
I <sub>C</sub> <sup>(1)</sup>	Collector current (continuous) at T <sub>C</sub> = 100°C	7		A
I <sub>CM</sub> <sup>(2)</sup>	Collector current (pulsed)	56		A
V <sub>GE</sub>	Gate-emitter voltage	±20		V
P <sub>TOT</sub>	Total dissipation at T <sub>C</sub> = 25°C	80	70	W
T <sub>SC</sub>	Short circuit withstand	0.64	0.56	µs
T <sub>stg</sub>	Storage temperature	- 65 to 150		°C
T <sub>j</sub>	Operating junction temperature	150		

1. Calculated according to the iterative formula::

$$I_C(T_C) = \frac{T_{JMAX} - T_C}{R_{THJ-C} \times V_{CESAT(MAX)}(T_C, I_C)}$$

2. Pulse width limited by max junction temperature

**Table 2. Thermal resistance**

Symbol	Parameter	TO-220	DPAK	Unit
R <sub>thj-case</sub>	Thermal resistance junction-case Max	1.56	1.4	°C/W
R <sub>thj-amb</sub>	Thermal resistance junction-ambient Max	62.5	100	°C/W

## 2 Electrical characteristics

( $T_{CASE}=25^{\circ}\text{C}$  unless otherwise specified)

**Table 3. Static**

Symbol	Parameter	Test conditions	Min.	Typ.	Max.	Unit
$V_{BR(CES)}$	Collector-emitter breakdown voltage	$I_C = 1\text{mA}, V_{GE} = 0$	600			V
$V_{CE(sat)}$	Collector-emitter saturation voltage	$V_{GE} = 15\text{V}, I_C = 7\text{A}$		2.3	2.8	V
		$V_{GE} = 15\text{V}, I_C = 7\text{A}, T_C = 125^{\circ}\text{C}$		1.9		V
$V_{GE(th)}$	Gate threshold voltage	$V_{CE} = V_{GE}, I_C = 250\ \mu\text{A}$	5		7	V
$I_{CES}$	Collector cut-off current ( $V_{GE} = 0$ )	$V_{CE} = \text{Max rating}, T_C = 25^{\circ}\text{C}$			50	$\mu\text{A}$
		$V_{CE} = \text{Max rating}, T_C = 125^{\circ}\text{C}$			500	$\mu\text{A}$
$I_{GES}$	Gate-emitter leakage current ( $V_{CE} = 0$ )	$V_{GE} = \pm 20\text{V}, V_{CE} = 0$			$\pm 100$	nA
$g_{fs}$	Forward transconductance	$V_{CE} = 15\text{V}, I_C = 7\text{A}$		3.7		S

**Table 4. Dynamic**

Symbol	Parameter	Test conditions	Min.	Typ.	Max.	Unit
$C_{ies}$ $C_{oes}$ $C_{res}$	Input capacitance	$V_{CE} = 25\text{V}, f = 1\text{MHz},$ $V_{GE} = 0$		495		pF
	Output capacitance			77		pF
	Reverse transfer capacitance			13		pF
$Q_g$ $Q_{ge}$ $Q_{gc}$	Total gate charge	$V_{CE} = 480\text{V}, I_C = 7\text{A},$ $V_{GE} = 15\text{V},$ <i>(see Figure 17)</i>		32.7	45	nC
	Gate-emitter charge			5.9		nC
	Gate-collector charge			18.3		nC
tscw	Short circuit withstand time	$V_{CE} = 0.5V V_{BR(CES)}, R_G = 10\ \Omega$ $V_{GE} = 15\text{V}, T_j = 125^{\circ}\text{C}$	10			$\mu\text{s}$

Table 5. Switching on/off (inductive load)

Symbol	Parameter	Test conditions	Min.	Typ.	Max.	Unit
$t_{d(on)}$ $t_r$	Turn-on delay time Current rise time	$V_{CC} = 480V, I_C = 7A$ $R_G = 10\Omega, V_{GE} = 15V,$ $T_J = 25^\circ C$ (see Figure 18)		15 6		ns ns
$(di/dt)_{on}$ $E_{on}^{(1)}$	Turn-on delay time Turn-on switching losses	$V_{CC} = 480V, I_C = 7A$ $R_G = 10\Omega, V_{GE} = 15V,$ $T_J = 125^\circ C$ (see Figure 18)		980 95		A/ $\mu s$ $\mu J$
$t_c$ $t_r(V_{off})$ $t_{d(off)}$ $t_f$ $E_{off}^{(2)}$ $E_{ts}$	Cross-over time Off voltage rise time Turn-off delay time Current fall time Turn-off switching losses Total switching losses	$V_{CC} = 480V, I_C = 7A,$ $R_{GE} = 10\Omega, V_{GE} = 15V,$ $T_J = 25^\circ C$ (see Figure 18)		105 30 50 100 140 200		ns ns ns ns $\mu J$ $\mu J$
$t_c$ $t_r(V_{off})$ $t_{d(off)}$ $t_f$ $E_{off}^{(1)}$ $E_{ts}$	Cross-over time Off voltage rise time Turn-off delay time Current fall time Turn-off switching losses Total switching losses	$V_{CC} = 480V, I_C = 7A,$ $R_{GE} = 10\Omega, V_{GE} = 15V,$ $T_J = 125^\circ C$ (see Figure 18)		227 68 52 150 300 395		ns ns ns ns $\mu J$ $\mu J$

1.  $E_{on}$  is the turn-on losses when a typical diode is used in the test circuit in figure 2. If the IGBT is offered in a package with a co-pack diode, the co-pack diode is used as external diode. IGBTs & Diode are at the same temperature (25°C and 125°C)

2. Turn-off losses include also the tail of the collector current

## 2.1 Electrical characteristics (curves)

Figure 1. Output characteristics

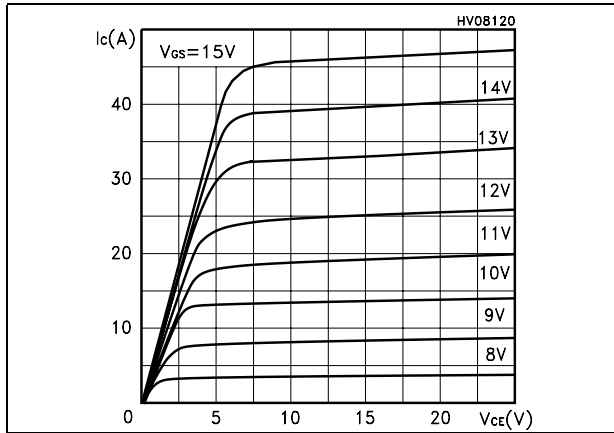

Figure 2. Transfer characteristics

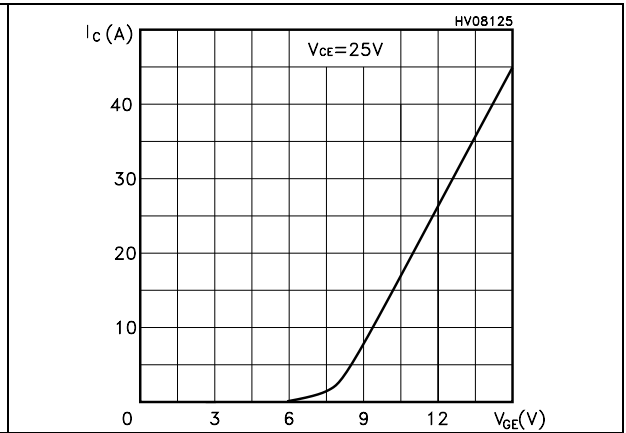

Figure 3. Transconductance

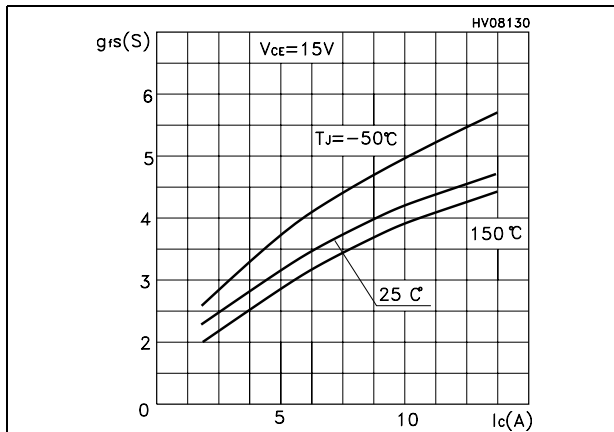

Figure 4. Normalized collector-emitter on voltage

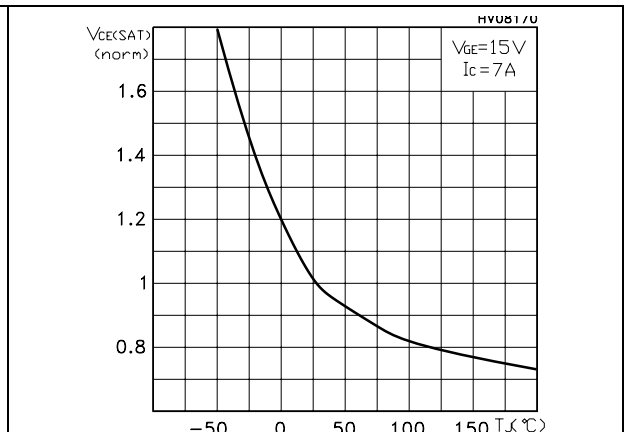

Figure 5. Gate charge vs gate-source voltage

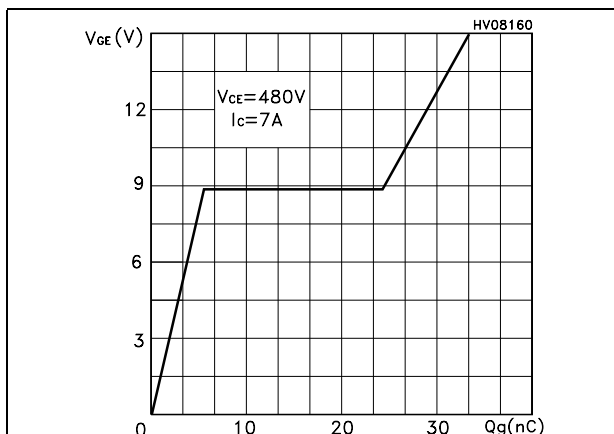

Figure 6. Capacitance variations

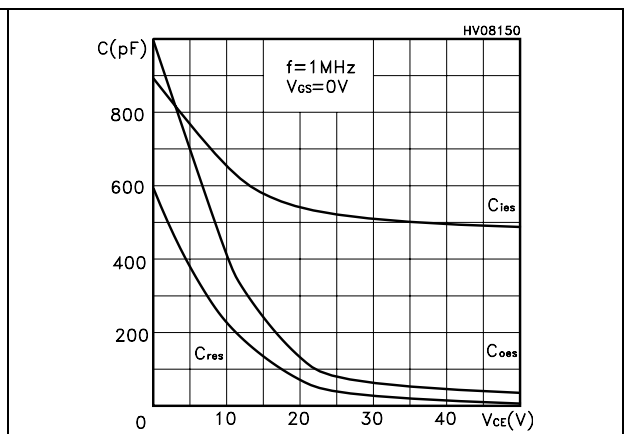

Figure 7. Normalized gate threshold voltage vs temperature

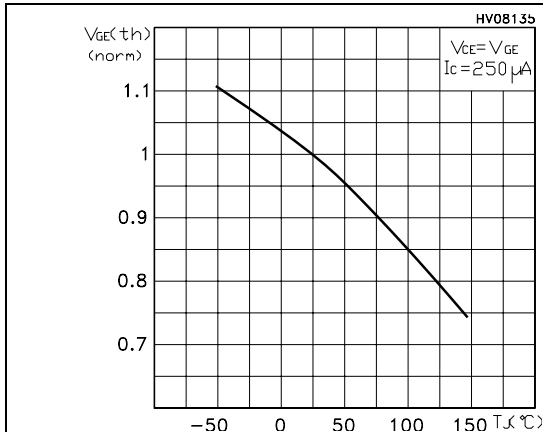

Figure 8. Collector-emitter on voltage vs collector current

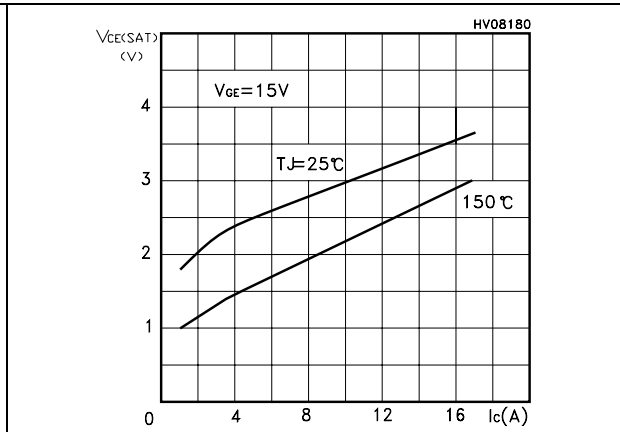

Figure 9. Normalized breakdown voltage vs temperature

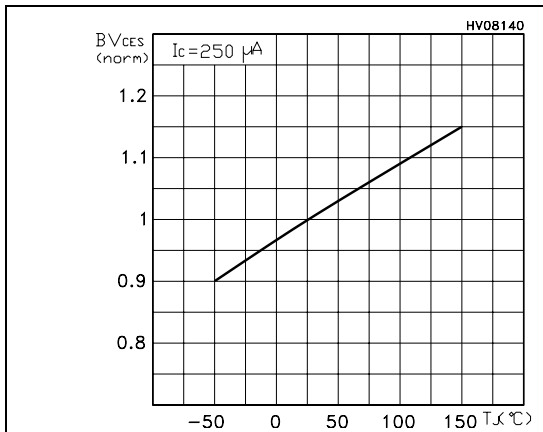

Figure 10. Switching losses vs temperature

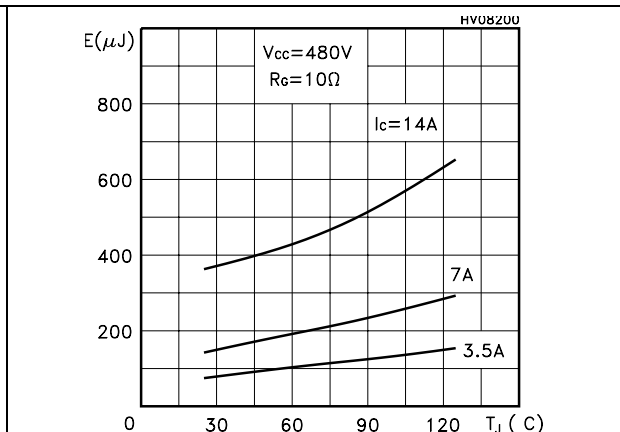

Figure 11. Switching losses vs gate resistance

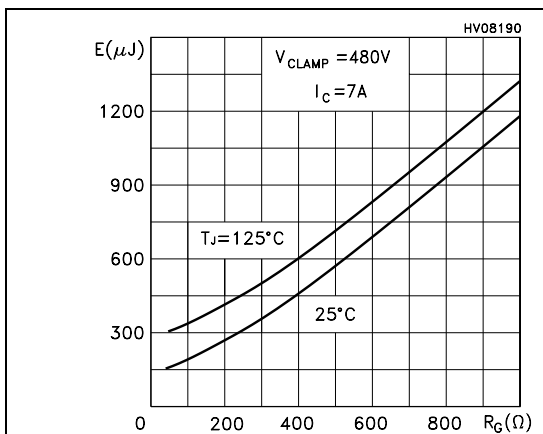

Figure 12. Switching losses vs collector current

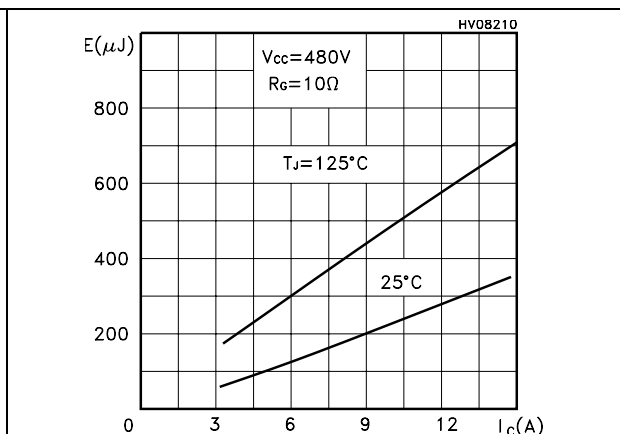

Figure 13. Thermal Impedance for DPAK

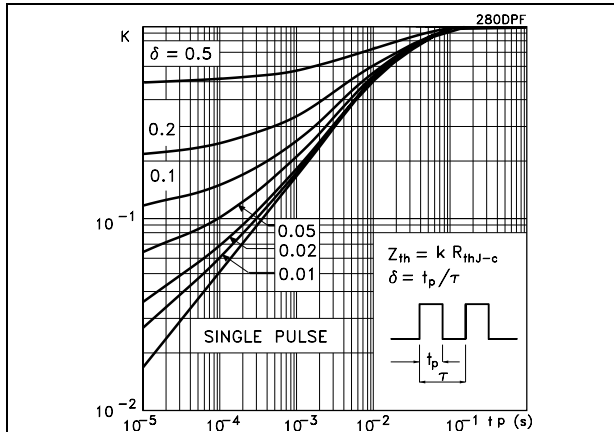

Figure 14. Thermal Impedance

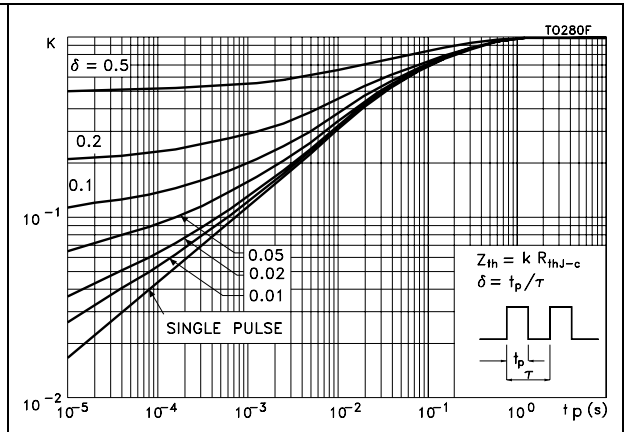
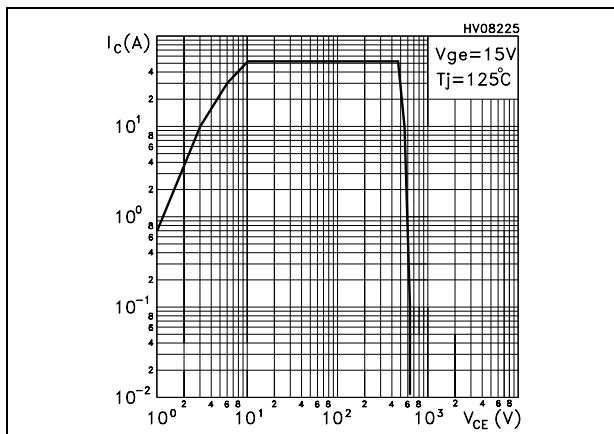

Figure 15. Turn-off SOA





### 3 Test circuit

Figure 16. Test circuit for inductive load switching

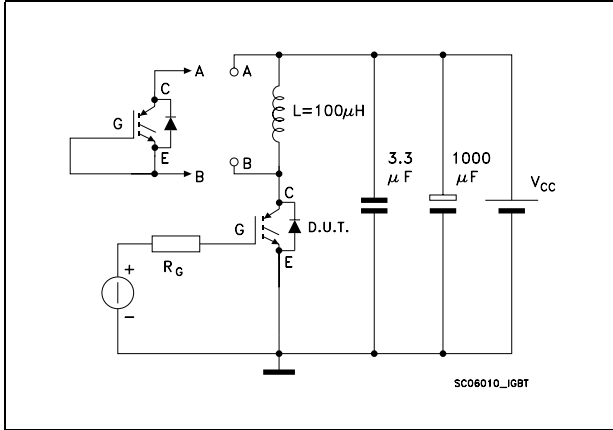

Figure 17. Gate charge test circuit

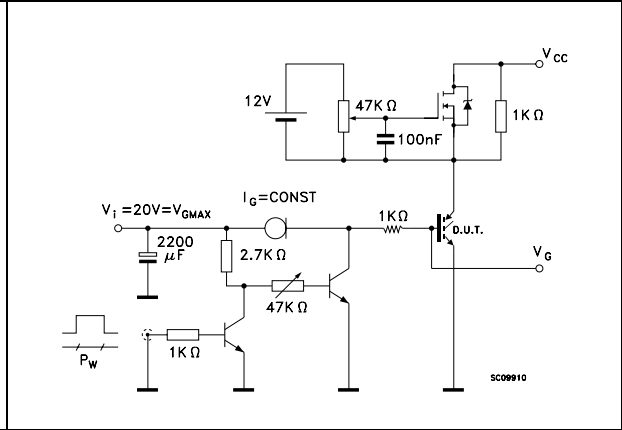

Figure 18. Switching waveform

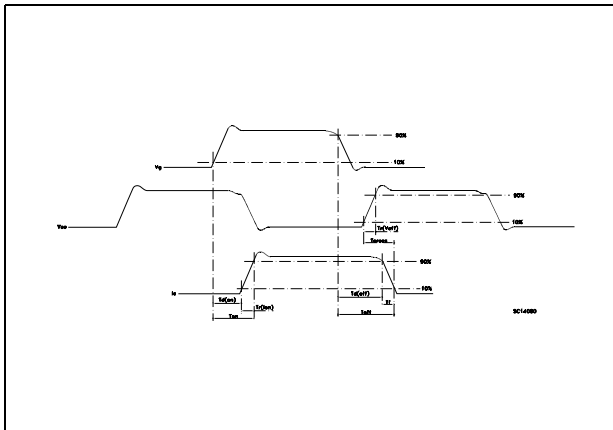
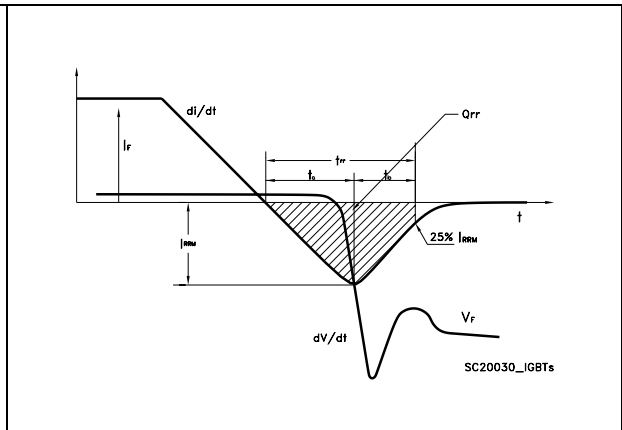

Figure 19. Diode recovery time waveform



## 4 Package mechanical data

In order to meet environmental requirements, ST offers these devices in ECOPACK® packages. These packages have a Lead-free second level interconnect. The category of second level interconnect is marked on the package and on the inner box label, in compliance with JEDEC Standard JESD97. The maximum ratings related to soldering conditions are also marked on the inner box label. ECOPACK is an ST trademark. ECOPACK specifications are available at: [www.st.com](http://www.st.com)

**TO-220 MECHANICAL DATA**

DIM.	mm.			inch		
	MIN.	TYP.	MAX.	MIN.	TYP.	MAX.
A	4.40		4.60	0.173		0.181
b	0.61		0.88	0.024		0.034
b1	1.15		1.70	0.045		0.066
c	0.49		0.70	0.019		0.027
D	15.25		15.75	0.60		0.620
E	10		10.40	0.393		0.409
e	2.40		2.70	0.094		0.106
e1	4.95		5.15	0.194		0.202
F	1.23		1.32	0.048		0.052
H1	6.20		6.60	0.244		0.256
J1	2.40		2.72	0.094		0.107
L	13		14	0.511		0.551
L1	3.50		3.93	0.137		0.154
L20		16.40			0.645	
L30		28.90			1.137	
øP	3.75		3.85	0.147		0.151
Q	2.65		2.95	0.104		0.116

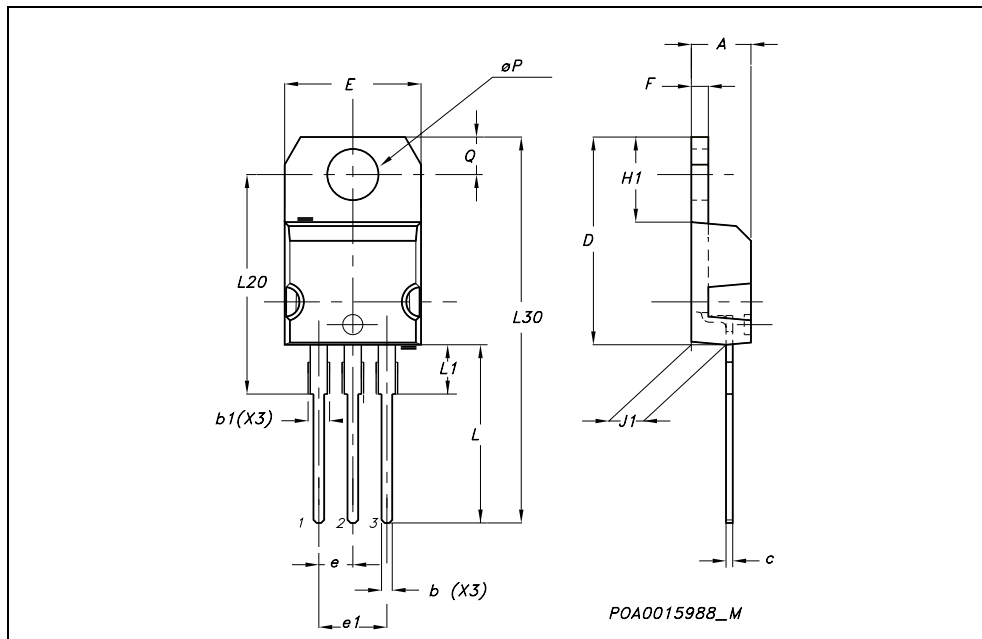

**DPAK MECHANICAL DATA**

DIM.	mm.			inch		
	MIN.	TYP.	MAX.	MIN.	TYP.	MAX.
A	2.2		2.4	0.086		0.094
A1	0.9		1.1	0.035		0.043
A2	0.03		0.23	0.001		0.009
B	0.64		0.9	0.025		0.035
b4	5.2		5.4	0.204		0.212
C	0.45		0.6	0.017		0.023
C2	0.48		0.6	0.019		0.023
D	6		6.2	0.236		0.244
D1		5.1			0.200	
E	6.4		6.6	0.252		0.260
E1		4.7			0.185	
e		2.28			0.090	
e1	4.4		4.6	0.173		0.181
H	9.35		10.1	0.368		0.397
L	1			0.039		
(L1)		2.8			0.110	
L2		0.8			0.031	
L4	0.6		1	0.023		0.039
R		0.2			0.008	
V2	0°		8°	0°		8°

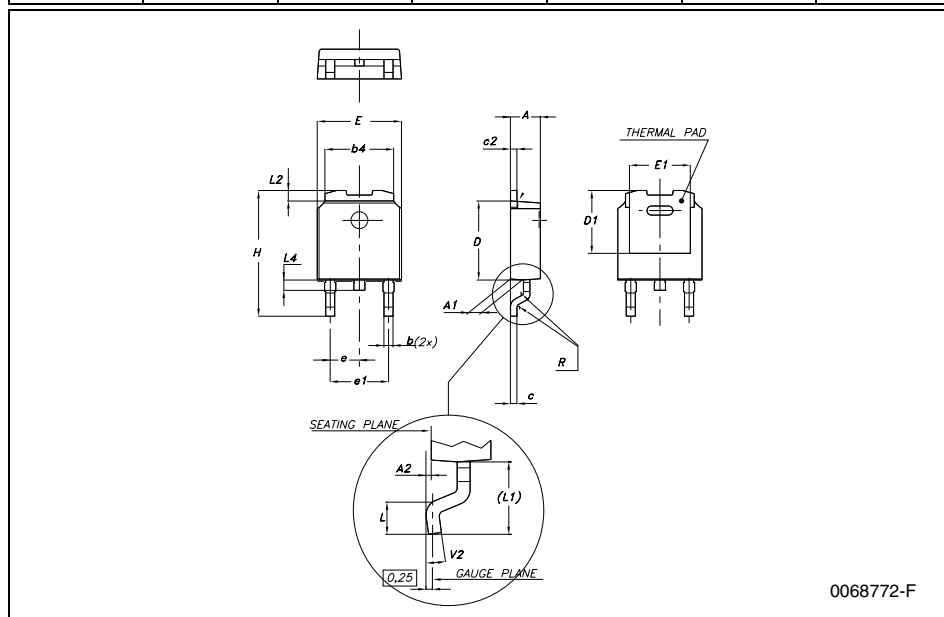

0068772-F

## 5 Packaging mechanical data

### DPAK FOOTPRINT

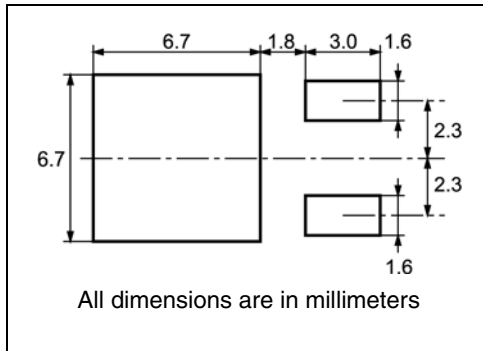

### TAPE AND REEL SHIPMENT

DIM.	mm		inch	
	MIN.	MAX.	MIN.	MAX.
A		330		12.992
B	1.5		0.059	
C	12.8	13.2	0.504	0.520
D	20.2		0.795	
G	16.4	18.4	0.645	0.724
N	50		1.968	
T		22.4		0.881

**TAPE MECHANICAL DATA**

DIM.	mm		inch	
	MIN.	MAX.	MIN.	MAX.
A0	6.8	7	0.267	0.275
B0	10.4	10.6	0.409	0.417
B1		12.1		0.476
D	1.5	1.6	0.059	0.063
D1	1.5		0.059	
E	1.65	1.85	0.065	0.073
F	7.4	7.6	0.291	0.299
K0	2.55	2.75	0.100	0.108
P0	3.9	4.1	0.153	0.161
P1	7.9	8.1	0.311	0.319
P2	1.9	2.1	0.075	0.082
R	40		1.574	
W	15.7	16.3	0.618	0.641

BASE QTY	BULK QTY
2500	2500

## 6 Revision history

**Table 6. Revision history**

<b>Date</b>	<b>Revision</b>	<b>Changes</b>
21-Mar-2005	1	First release
23-Jun-2006	2	The document has been reformatted
26-Jan-2007	3	Typing error

**Please Read Carefully:**

Information in this document is provided solely in connection with ST products. STMicroelectronics NV and its subsidiaries ("ST") reserve the right to make changes, corrections, modifications or improvements, to this document, and the products and services described herein at any time, without notice.

All ST products are sold pursuant to ST's terms and conditions of sale.

Purchasers are solely responsible for the choice, selection and use of the ST products and services described herein, and ST assumes no liability whatsoever relating to the choice, selection or use of the ST products and services described herein.

No license, express or implied, by estoppel or otherwise, to any intellectual property rights is granted under this document. If any part of this document refers to any third party products or services it shall not be deemed a license grant by ST for the use of such third party products or services, or any intellectual property contained therein or considered as a warranty covering the use in any manner whatsoever of such third party products or services or any intellectual property contained therein.

**UNLESS OTHERWISE SET FORTH IN ST'S TERMS AND CONDITIONS OF SALE ST DISCLAIMS ANY EXPRESS OR IMPLIED WARRANTY WITH RESPECT TO THE USE AND/OR SALE OF ST PRODUCTS INCLUDING WITHOUT LIMITATION IMPLIED WARRANTIES OF MERCHANTABILITY, FITNESS FOR A PARTICULAR PURPOSE (AND THEIR EQUIVALENTS UNDER THE LAWS OF ANY JURISDICTION), OR INFRINGEMENT OF ANY PATENT, COPYRIGHT OR OTHER INTELLECTUAL PROPERTY RIGHT.**

**UNLESS EXPRESSLY APPROVED IN WRITING BY AN AUTHORIZED REPRESENTATIVE OF ST, ST PRODUCTS ARE NOT DESIGNED, AUTHORIZED OR WARRANTED FOR USE IN MILITARY, AIR CRAFT, SPACE, LIFE SAVING, OR LIFE SUSTAINING APPLICATIONS, NOR IN PRODUCTS OR SYSTEMS, WHERE FAILURE OR MALFUNCTION MAY RESULT IN PERSONAL INJURY, DEATH, OR SEVERE PROPERTY OR ENVIRONMENTAL DAMAGE.**

Resale of ST products with provisions different from the statements and/or technical features set forth in this document shall immediately void any warranty granted by ST for the ST product or service described herein and shall not create or extend in any manner whatsoever, any liability of ST.

ST and the ST logo are trademarks or registered trademarks of ST in various countries.

Information in this document supersedes and replaces all information previously supplied.

The ST logo is a registered trademark of STMicroelectronics. All other names are the property of their respective owners.

© 2007 STMicroelectronics - All rights reserved

STMicroelectronics group of companies

Australia - Belgium - Brazil - Canada - China - Czech Republic - Finland - France - Germany - Hong Kong - India - Israel - Italy - Japan - Malaysia - Malta - Morocco - Singapore - Spain - Sweden - Switzerland - United Kingdom - United States of America

[www.st.com](http://www.st.com)

