

Shock-Safe Fuseholder, 5 x 20 mm, horizontal, Slotted Cap/Fingergrip, SMD, IEC 60335-1



Closed fuseholder 5 x 20 mm
 horizontal with slot
 black
 Slotted cap



Closed fuseholder 5 x 20 mm
 horizontal with finger grip
 black
 fingergrip

250 VAC · 2.5W / 10A (VDE) · 250VAC/DC · 16A (UL/CSA)

See below:
[Approvals and Compliances](#)

Description

- Surface Mount Device with stabilizing Posts
- Heading with fingergrip and slotted available
- Compact design

Applications

- Household appliances
- Medical Equipment

Weblinks

[pdf data sheet](#), [html datasheet](#), [General Product Information](#), [Distributor-Stock-Check](#), [Detailed request for product](#), [Microsite](#)

Technical Data

Shock-Safe Category	PC2
Fuse-Link	5 x 20 mm
Mounting	PCB
Terminal	Solder SMT
Rated Voltage	250VAC , 250VAC/DC (UL/CSA)
Rated current	10A (VDE), 16A (UL/CSA)
Rated Power Acceptance IEC	2.5W / 10A @ Ta 23 °C Admissible power acceptance at higher ambient temperature see derating curves
Degree of Protection	IP40
Protection Class	Suitable for appliances with protection class I acc. to IEC 61140
Admissible Ambient Air Temp.	-40 °C to 85 °C
Climatic Category	40/085/21 acc. to IEC 60068-1
Material: Socket	Thermoplastic, black, UL 94V-0
Material: Terminals	Copper alloy, tin-plated
Unit Weight	4.4 g
Storage Conditions	0 °C to 60 °C, max. 70% r.h.
Product Marking	Type, Power Acc./Current Rating, Certification marks

Soldering Methods	Reflow (lead-free) Soldering Profile
Solderability	260 °C / max. 30sec acc. to JEDEC J-STD-020E
Contact Resistance	≤ 10 mΩ at 100 mA acc. to IEC 60127-6
Dielectric Strength	> 3kV between live parts
Impulse Withstand Voltage	> 4kV between live parts
Insulation Resistance	≥ 10MΩ between live parts (500VDC: 1 min)
Overvoltage Category	II acc. to IEC 60664-1
Pollution Degree	2 acc. to IEC 60664-1
Resistance to Vibration	acc. to IEC 60068-2-6, test Fc

Approvals and Compliances

Detailed information on product approvals, code requirements, usage instructions and detailed test conditions can be looked up in [Details about Approvals](#)

SCHURTER products are designed for use in industrial environments. They have approvals from independent testing bodies according to national and international standards. Products with specific characteristics and requirements such as required in the automotive sector according to IATF 16949, medical technology according to ISO 13485 or in the aerospace industry can be offered exclusively with customer-specific, individual agreements by SCHURTER.

Approvals



The approval mark is used by the testing authorities to certify compliance with the safety requirements placed on electronic products.

Approval Reference Type: FPG7

Approval Logo	Certificates	Certification Body	Description
	VDE Approvals	VDE	VDE Certificate Number: 40044101
	UL Approvals	UL	UR File Number: E39328



Product standards

Product standards that are referenced

Organization	Design	Standard	Description
	Designed according to	IEC 60127-6	Miniature fuses. Part 6. Fuse-holders for miniature fuse-links
	Designed according to	UL 4248-1	Industrial Control Equipment
	Designed according to	CSA C22.2 no. 4248.1	Industrial Control Equipment







Application standards

Application standards where the product can be used

Organization	Design	Standard	Description
	Suitable for applications acc.	IEC/UL 62368-1	Audio/video, information and communication technology equipment - Part 1: Safety requirements
	Suitable for applications acc.	IEC 60335-1	Safety of electrical appliances for household and similar purposes. Meets the requirements for appliances in unattended use. This includes the enhanced requirements of glow wire tests acc. to IEC 60695-2-11 or -12 & -13.

Compliances

The product complies with following Guide Lines

Identification	Details	Initiator	Description
	CE declaration of conformity	SCHURTER AG	The CE marking declares that the product complies with the applicable requirements laid down in the harmonisation of Community legislation on its affixing in accordance with EU Regulation 765/2008.
	UKCA declaration of conformity	SCHURTER AG	The UKCA marking declares that the product complies with the applicable requirements laid down in the British Amendment of Regulation (EC) 765/2008.
	RoHS	SCHURTER AG	Directive RoHS 2011/65/EU, Amendment (EU) 2015/863
	China RoHS	SCHURTER AG	The law SJ / T 11363-2006 (China RoHS) has been in force since 1 March 2007. It is similar to the EU directive RoHS.
	REACH	SCHURTER AG	On 1 June 2007, Regulation (EC) No 1907/2006 on the Registration, Evaluation, Authorization and Restriction of Chemicals 1 (abbreviated as "REACH") entered into force.
	White Paper Glow wire test	SCHURTER AG	Meets the requirements of IEC 60335-1 for appliances in unattended use. This includes the enhanced requirements of glow wire tests acc. to IEC 60695-2-11 or -12 &-13.

Dimension [mm]

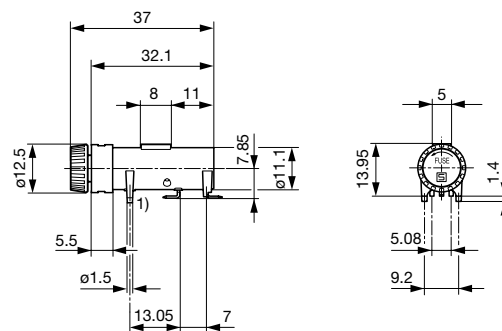
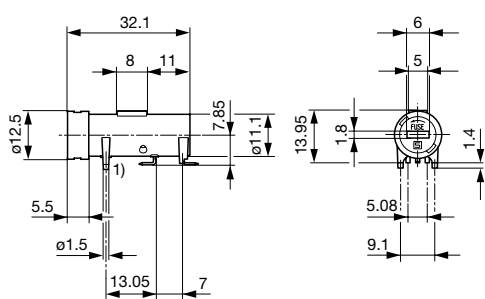

Variant 3101.0071
 1) Stabilizing posts

Variant 3101.0076
 1) Stabilizing posts

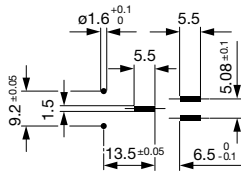

Soldering pads and mounting holes

Derating Curves

acc. to IEC

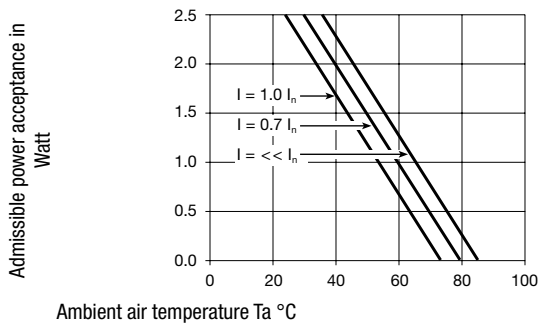

All Variants

Holder	Cap	Material	Reflow Condition	Remark	Order Number
●	slotted	Spec. Thermoplastic	acc. to JEDEC J-STD-020D, $T_p=260 \pm 5$ °C, $t_p = \max. 30$ s	-	3101.0071
●	Fingergrip	Spec. Thermoplastic	acc. to JEDEC J-STD-020D, $T_p=260 \pm 5$ °C, $t_p = \max. 30$ s	-	3101.0076

Availability for all products can be searched real-time: <https://www.schurter.com/en/Stock-Check/Stock-Check-SCHURTER>

Packaging Unit

xxxx.xxxx Bulk 186 x 91 x 91 mm (100 pcs.)
 xxxx.xxxx.D2 Blister Tape 38 cm Reel (250 pcs.)