

E60066

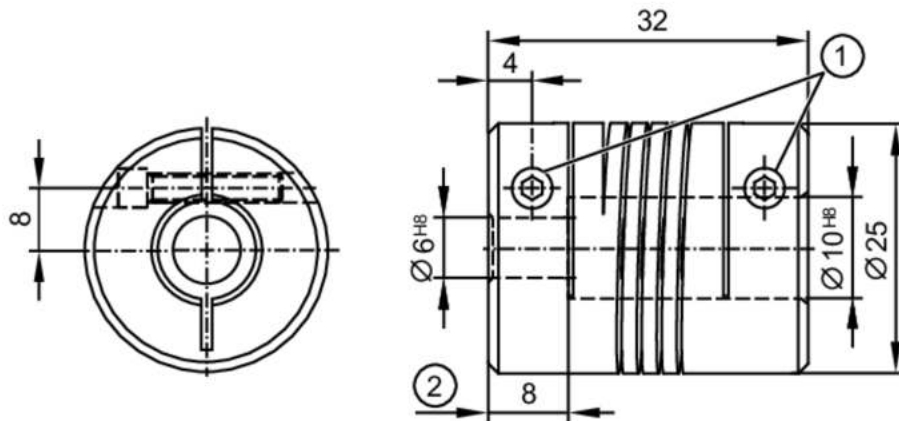

Flexible coupling for encoders

COUPLING 25-6-10-32-KV



- 1 M4 x 12 - ISO 4762 (2x)
2 Depth der Klemmnabe

Mechanical data

Weight	[g]	34.5
Dimensions	[mm]	Ø 25 / L = 32
Materials		aluminium
Tightening torque	[Nm]	tightening torque screws: 120 Ncm
External diameter D	[mm]	25
Inside diameter 1	[mm]	6
Inside diameter 2	[mm]	10
Depth of the clamping hub	[mm]	8
Clamping screw	[mm]	M4 x 12 - ISO 4762 (2x)
Length	[mm]	32
Max. revolution, mechanical	[U/min]	6000
Max. axial shaft misalignment	[mm]	± 0,5
Max. radial shaft misalignment	[mm]	± 0,35
Max. angular displacement	[°]	± 4,0

Remarks

Remarks	The data indicated apply to couplings with the above hub borings at an ambient temperature of 23 °C. The values of radial, angular and axial displacement are maximum values which must not reach their maximum simultaneously while in operation.
Pack quantity	1 pcs.