

●Pin Configuration (SSOP6)

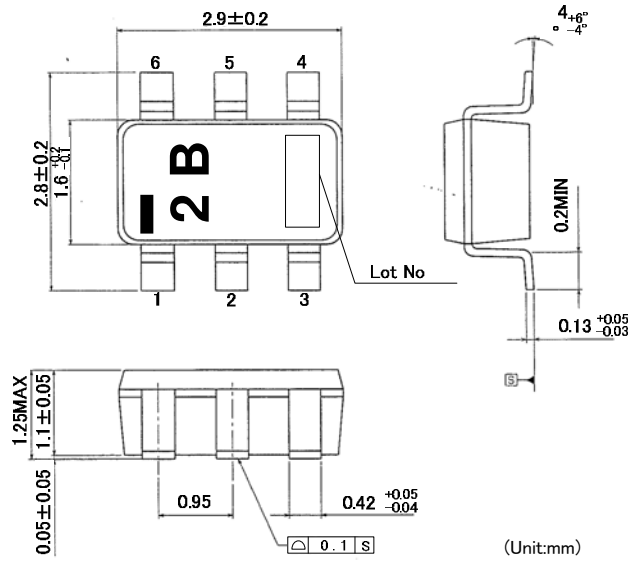

Figure 2, External Dimensions of SSOP6 Package

●Pin Description

Table 1. I/O PIN Functions

NO.	Pin Name	I/O	Function	ESD protection system	
				VCC	GND
1	GND	I/O	GND pin	○	-
2	FB	I	Feedback signal input pin	○	○
3	COMP	I	Comparator input pin	○	○
4	CS	I	Primary current sensor pin	○	○
5	VCC	I	Power supply input pin	-	○
6	OUT	O	External MOS drive pin	○	○

●I/O Equivalent Circuit

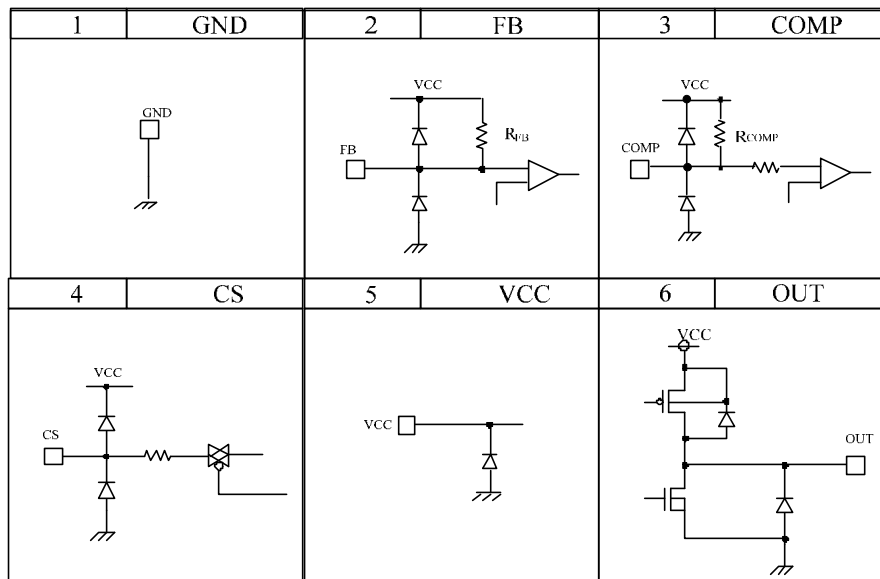

Figure 3. I/O Equivalent Circuit

●Description of Each Block

(1) Start Sequences (Soft Start Operation, Light Load Operation, and Overload Protection)

Start sequences are shown in Figure 5. This is also shown the operation of overload protection.

See the sections below for detailed descriptions

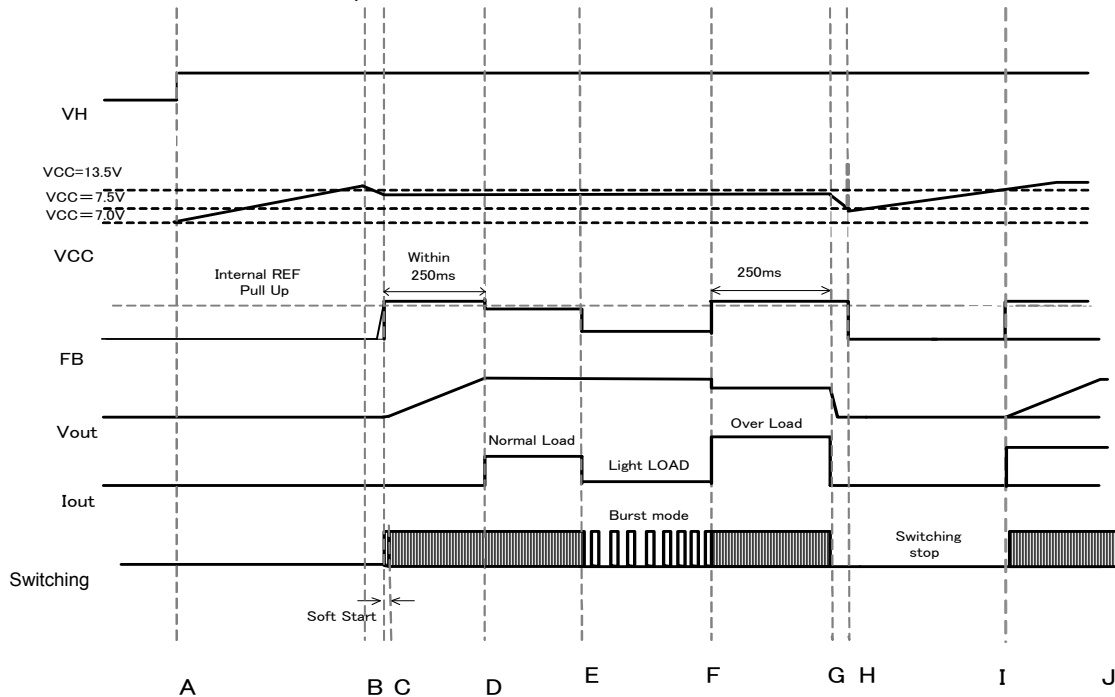

Figure 5. Start Sequence Timing Chart

- A: Input voltage V_H is applied
- B: V_{CC} pin voltage rises by being supplied from V_H line through start resistor "Rstart" and the IC starts operating when $V_{CC} > V_{UVLO1}$ (13.5V Typ). Switching operation starts when other protection functions are judged as normal. From startup to be stable output voltage, application should be set to stabilize output voltage during $V_{CC} > V_{UVLO2}$ (7.5V Typ) because the V_{CC} pin consumption current causes the V_{CC} voltage drop.
- C: Operated soft start function, maximum duty is restricted to 15% during a 1ms period to prevent any excessive rise in voltage or current. From 1ms to 8ms, maximum duty is restricted to 25%. Maximum duty is restricted to 75% after 8ms.
- D: V_{OUT} voltage rises when the switching operation starts. Once the output voltage starts, it is set to the rated voltage level within the T_{FOLP} period (250ms Typ). The output voltage is regulated within T_{FOLP} (=250ms Typ) from starting.
- E: During Light Load, when FB pin voltage $< V_{BST}$ (=0.3V Typ), Burst method is operated to keep power consumption down.
- F: Over Load condition occurs when FB pin voltage $> V_{FOLP1A}$ (=3.6V Typ).
- G: When FB pin voltage is at V_{FOLP1A} (= 3.6V Typ) for more than T_{FOLP} (250ms Typ), the overload protection function is triggered and switching is stopped. The IC's internal 250ms timer is reset during the T_{FOLP} period (250ms Typ) if $FB < V_{FOLP1B}$ even once.
- H: If the V_{CC} voltage drops to V_{UVLO2} (7.5V typ) or below, restart is executed.
- I: The IC's circuit current is reduced and the V_{CC} pin value rises. (Same as B).
- J: Same as D

In Figure 4, start resistor R_{start} is needed to start the application.

When the start resistor R_{start} value is reduced, standby power is increased and the startup time is shortened.

Conversely, when the start resistor R_{start} value is increased, standby power is reduced and the startup time is increased.

Standby current is less than 20uA at V_{CC} UVLO is disable, and it can calculate V_{CC} UVLO voltage from $V_{UVLO1}=14.5V$ (Max).

ex) Starting resistor R_{start} setting method;

$$R_{start} = (V_{Hmin} - V_{UVLO1} (\text{Max})) / I_{OFF} (\text{Max})$$

In the case of $V_{ac}=100V$ (-20% of a margin), R_{start} requirement can be found by the following formulas:

$$V_{Hmin} = 100 \times \sqrt{2} \times 0.8 = 113V$$

$$\text{Because of } V_{UVLO1} (\text{Max}) = 14.5V, R_{start} \leq (113V - 14.5V) / 20\mu A = 4.925M\Omega$$

Start-up time can be found by the following formulas:

$$T_{start} = -R_{start} \times C_{VCC} \times \ln(1 - V_{UVLO1}/V_{Hmin})$$

ex) $R_{start}=3.0M\Omega$

$$R_{start} \text{ resistor loss in this case is : } P_d (R_{start}) = (V_H - V_{CC})^2 / R_{start} = (141V - 14.5V)^2 / 3.0M = 5.33mW.$$

(2) VCC Pin Protection

BD7672BG includes UVLO (Under Voltage Locked Out) and OVP (Over Voltage Protection) functions to monitor VCC pin voltage (see Figure 6 for OVP latch operation).

The UVLO function prevents damage to MOSFET by stopping switching operations by latch protection when the VCC pin voltage drops to $V_{CC} < V_{UVLO2}$ ($= 7.5V$ Typ).

The VCC OVP function prevents damage to MOSFET by stopping switching operations when the VCC pin voltage exceeds V_{OVP1} ($= 27.5V$ Typ).

The latch release condition is when $V_{CC} < V_{LATCH}$ ($V_{UVLO2} - 0.5V$, Typ $= 7.0V$). A latch blanking time is used for protecting mal-function. This time is 100us.

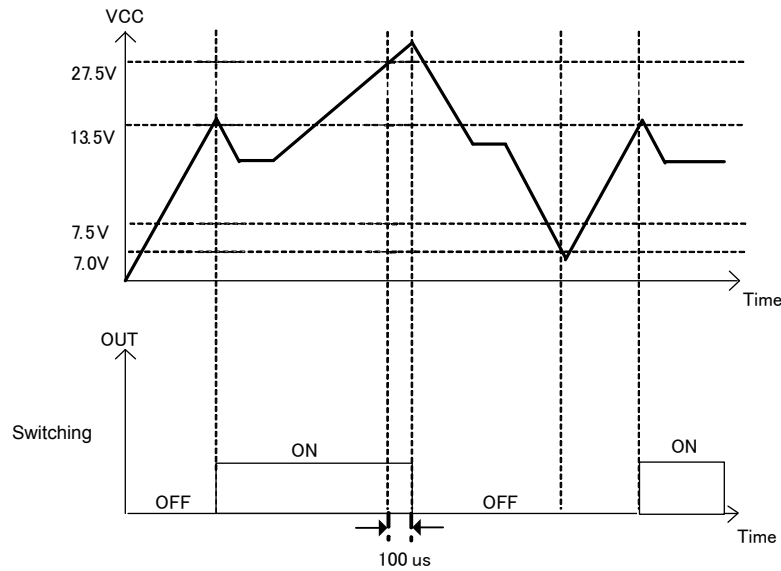

Figure 6. VCC UVLO/OVP Operation (Latch)

(3) DCDC Driver (PWM Comparator, Frequency Hopping, Slope Compensation, OSC, Burst)

BD7672BG uses current mode PWM control. In the internal generator, the average switching frequency is 65 kHz. Furthermore, switching frequency hopping function is built-in while the switching frequency fluctuation is shown as in Figure 7. Fluctuation cycle is 125Hz (=8ms).

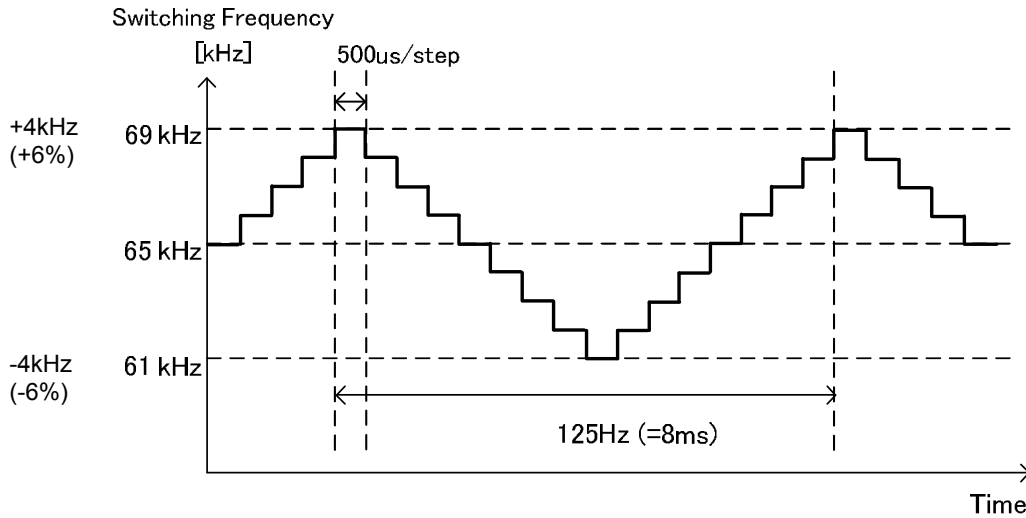

Figure 7. Frequency Hopping Function

The max-duty cycle is fix to 75% (Typ) at OUT pin and minimum pulse width is fix at 500ns (Typ). When the duty cycle exceeds 50% at Current Mode control, the sub-harmonic oscillation occurs. To prevent it, IC is built-in slope compensation function.

BD7672BG has burst mode function to attain less power consumption when load is light. This function monitors FB pin voltage and detects light load when FB voltage < V_{BST} (=0.3V Typ).

The secondary output voltage, the FB voltage and the DCDC function are shown in Figure 8.

FB pin is pulled up by R_{FB} (=20k Ω Typ). At light load, when the secondary output voltage rises, the FB pin voltage will drop and when this goes below V_{BST} (=0.3V Typ) burst function will follow to reduce the power consumption.

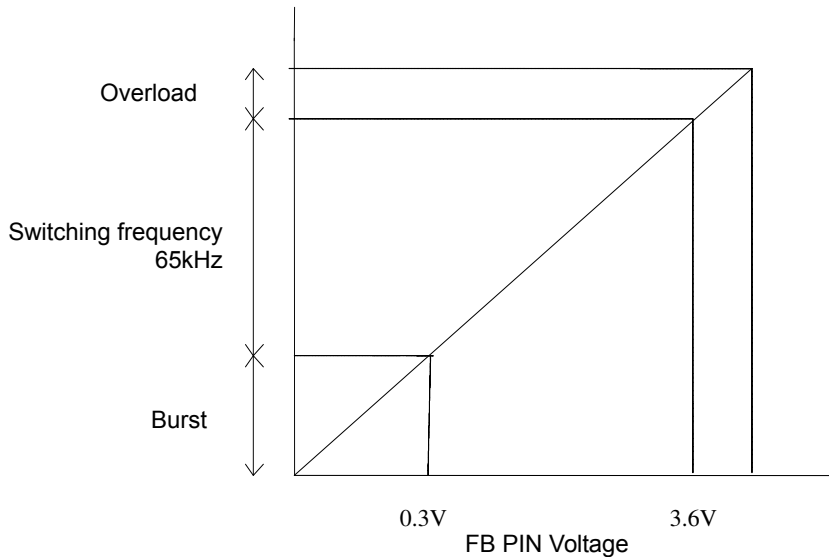

Figure 8. Switching Operation Status Changes by FB Pin Voltage

(4) Over Current Limiter and Leading Edge Blanking Period

BD7672BG has over current limiter for each switching cycle.

When the CS pin voltage exceeds the V_{CS} voltage ($=0.5V$ Typ), switching is turned OFF.

In addition, when the driver MOSFET is turned ON, surge current occurs at each capacitor component and drive current. Therefore, when the CS pin voltage rises temporarily, the detection errors may occur in the over current limiter circuit. To prevent detection errors, the OUT pin is switched from low to high and the CS signal is blanked for 250nsec by the LEB (Leading Edge Blanking) function. This blanking function enables a reduction of CS pin noise filtering in response to noise that occurs when the OUT pin is switched from low to high.

(5) Output Overload Protection Function (FB OLP Comparator)

Overload Protection Function monitors the load status of secondary output through FB pin and stops the switching of OUT pin during excessive load. In over load condition, there is no current in photo-coupler because output voltage decreases (drops) while FB pin voltage rises.

When FB pin voltage exceeds V_{FOLP1A} ($=3.6V$ Typ) at T_{FOLP} ($=250ms$ Typ) interval continuously, a load is excessive and OUT pin is fixed to L. The timer of overload protection is reset when FB pin drops further than V_{FOLP1B} ($=3.4V$ Typ) within T_{FOLP} ($=250ms$ Typ) after exceeding V_{FOLP1A} ($=3.6V$ Typ). Switching functions within this T_{FOLP} ($=250ms$ Typ).

FB voltage, which is pulled up in resistance to IC internal voltage operates from V_{FOLP1A} ($=3.6V$ Typ) or more at start-up. For this matter, set the start-up time of the secondary output voltage such that the FB voltage is always V_{FOLP1B} ($=3.4V$ Typ) or less within T_{FOLP} ($=250ms$ Typ) at start-up.

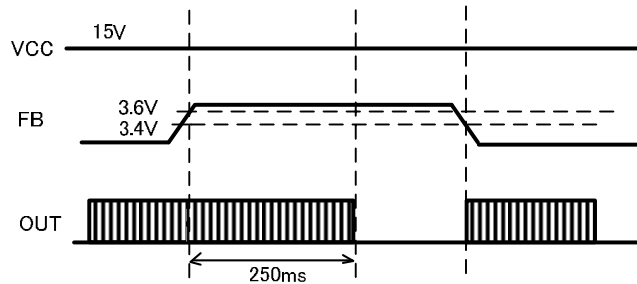

Figure 9. Overload Protection (Self-restart)

(6) COMP Pin External Latch Function

IC is latched when the COMP pin voltage goes below V_{COMP} (0.5V Typ). A latch timer for T_{LATCH} (100us Typ) added to prevent operation errors caused by noise. The COMP pin is pulled up by R_{COMP} (25.9k Ω Typ), and when R_T (3.7k Ω Typ) is pulled down at the COMP pin, latch protection is operated. Some application examples are shown in Figure 10, Figure 11, and Figure 12.

Overheating Protection by NTC Thermistor

A thermistor is attached to the COMP pin so that latching can be stopped when overheating occurs. In the case of this application, it should be designed so that the thermistor resistance becomes R_T (3.70k Ω Typ) when overheating is detected.

(Figure 10 and Figure 11 are application circuit examples in which latch operation occurs when $T_a = 110^{\circ}C$)

The variation in R_T (=3.70k Ω Typ) shown in an electrical property includes only IC. Please add the variation of external thermistor resistance to it and design.

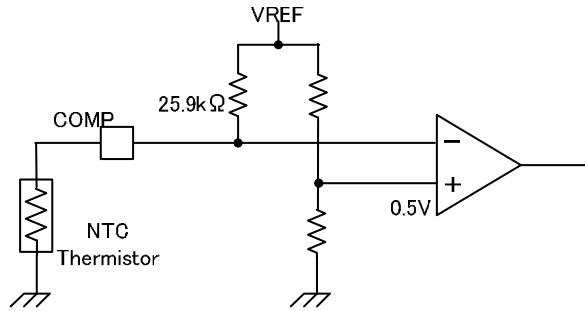

Figure 10. COMP Pin Overheating Protection Application

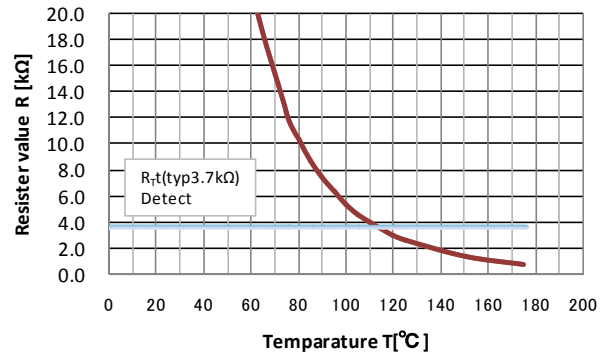

Figure 11. Temperature-Thermistor Resistance Value

Secondary Output Voltage Overvoltage Protection

A photo-coupler is attached to the COMP pin to perform detection of secondary output overvoltage.

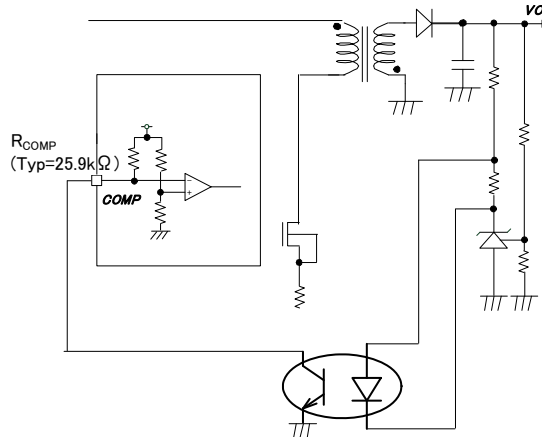

Figure 12. Output Overvoltage Protection Application

● Absolute Maximum Ratings (Ta=25°C)

Parameter	Symbol	Rating	Unit	Conditions
Maximum Applied Voltage 1	Vmax1	30	V	VCC, OUT
Maximum Applied Voltage 2	Vmax2	6.5	V	CS, FB, COMP
OUT pin output Peak Current	I _{OUT}	±1.0	A	
Allowable Dissipation	Pd	674.9 (Note1)	mW	When implemented
Operating Temperature Range	Topr	-40 to +105	°C	
Storage Temperature Range	Tstr	-55 to +150	°C	

(Note1) SSOP6: Derate by 5.399 mW/°C when operating above Ta=25°C (when mounted on 70 mm × 70 mm, 1.6 mm thick, glass epoxy on single-layer substrate).

● Recommended Operating Ratings (Ta=25°C)

Parameter	Symbol	Rating	Unit	Conditions
Power Supply Voltage Range	VCC	8.5 to 25.0	V	VCC pin voltage

● Electrical Characteristics (Unless otherwise noted, Ta = 25°C, VCC=12V)

Parameter	Symbol	Specifications			Unit	Conditions
		MIN	TYP	MAX		
[Circuit Current]						
Circuit Current (OFF)	I _{OFF}	-	12	20	μA	VCC = 12V (UVLO = Detection)
Circuit Current (ON) 1	I _{ON1}	-	600	1000	μA	FB = 2.0V COMP: 100kΩ (during pulse operation)
Circuit Current (ON) 2	I _{ON2}	-	400	650	μA	FB = 0.0V COMP: 100kΩ (during pulse operation when OFF)
[VCC Pin Protection Function]						
VCC UVLO Voltage 1	V _{UVLO1}	12.50	13.50	14.50	V	VCC rise
VCC UVLO Voltage 2	V _{UVLO2}	6.50	7.50	8.50	V	VCC drop
VCC UVLO Hysteresis	V _{UVLO3}	-	6.00	-	V	V _{UVLO3} = V _{UVLO1} - V _{UVLO2}
VCC OVP Voltage 1	V _{OVP1}	25.0	27.5	30.0	V	VCC rise

●Electrical Characteristics of control block (Unless otherwise noted, Ta = 25°C, VCC=12V)

Parameter	Symbol	Specifications			Unit	Conditions
		MIN	TYP	MAX		
[PWM Type DCDC Driver Block]						
Oscillation Frequency	F _{SW1}	60	65	70	KHz	FB=2.0V average frequency
Frequency Hopping Width 1	F _{DEL1}	-	4.0	-	KHz	FB=2.0V
Hopping Fluctuation Frequency	F _{CH}	93	125	157	Hz	
Minimum Pulse Width	T _{min}	-	500	-	ns	
Soft Start Time 1	T _{SS1}	0.75	1.00	1.25	ms	
Soft Start Time 2	T _{SS2}	6.00	8.00	10.00	ms	
Maximum Duty 1	D _{max}	68.0	75.0	82.0	%	During normal operation
Maximum Duty 2	D _{SS1}	5.0	15.0	25.0	%	During soft start 0[ms] to T _{SS1} [ms]
Maximum Duty 3	D _{SS2}	15.0	25.0	35.0	%	During soft start T _{SS1} [ms] to T _{SS2} [ms]
FB pin Pull-up Resistance	R _{FB}	15	20	25	kΩ	
∠FB / ∠CS Gain	Gain	-	5	-	V/V	
FB Burst Voltage	V _{BST}	0.20	0.30	0.40	V	During FB drop
FB OLP Voltage 1a	V _{FOLP1A}	3.3	3.6	3.9	V	When overload is detected (FB rise)
FB OLP Voltage 1b	V _{FOLP1B}	-	V _{FOLP1A} -0.2	-	V	When overload is detected (FB drop)
FB OLP Timer	T _{FOLP}	187	250	312	ms	
Latch Release Voltage (VCC pin voltage)	V _{LATCH}	-	V _{UVLO2} -0.5	-	V	Latch release voltage VCCUVLO2-0.5 [V]
Latch Mask Time	T _{LATCH}	50	100	200	us	VCCOVP, COMP Mask time
[Overcurrent Detection Block]						
Overcurrent Detection Voltage	V _{CS}	0.475	0.500	0.525	V	
Leading Edge Blanking Time	T _{LEB}	-	250	-	ns	
[Output Driver Block]						
OUT pin Pch MOS Ron	R _{POUT}	10	25	39	Ω	
OUT pin Nch MOS Ron	R _{NOUT}	3	7	12	Ω	
[External Latch Comparator Block]						
COMP pin Latch Detection Voltage	V _{COMP}	-	0.5	-	V	
COMP pin Pull-up Resistance	R _{COMP}	-	25.9	-	kΩ	
Thermistor Resistance Detection Value	R _T	3.30	3.70	4.10	kΩ	Thermistor connected to COMP pin

● Typical Performance Curves

(This is not a guarantee since this is the reference data. Figure 36 shows the measurement circuit diagram.)

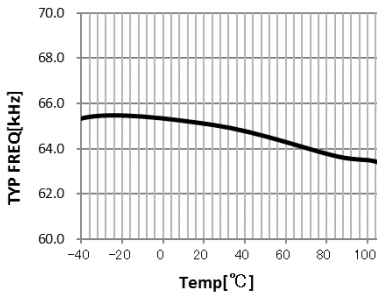

Figure 13, Typ Frequency Fsw1

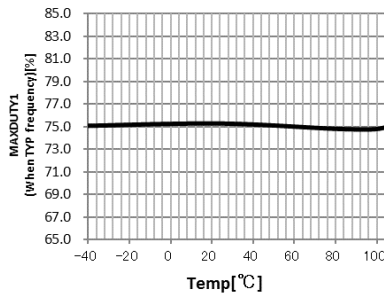

Figure 14, MAXDUTY1 (With Typ frequency)

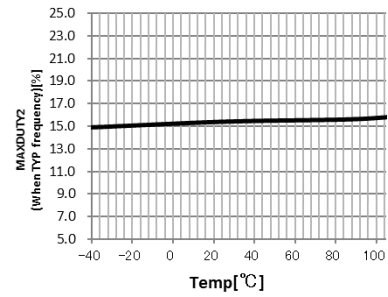

Figure 15, MAXDUTY2 (With Typ frequency)

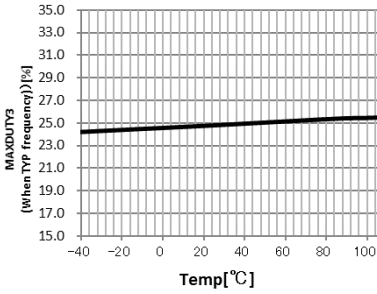

Figure 16, MAXDUTY3 (With Typ frequency)

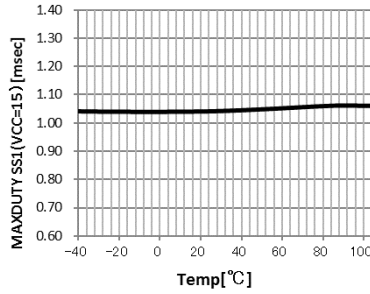

Figure 17, MAXDUTY SS1 (VCC=15)

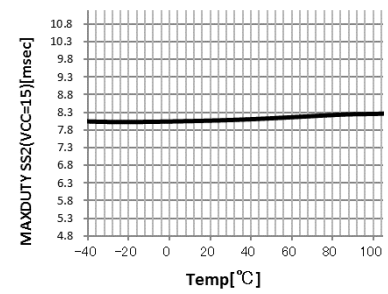

Figure 18, MAXDUTY SS2 (VCC=15)

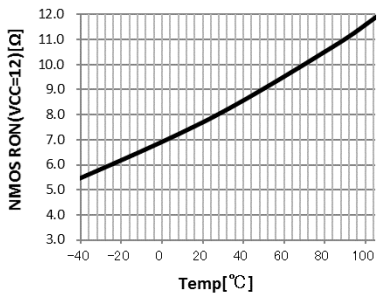

Figure 19, NMOS RON (VCC=12)

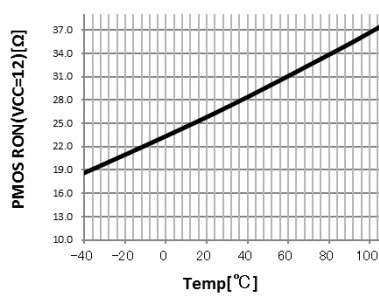

Figure 20, PMOS RON (VCC=12)

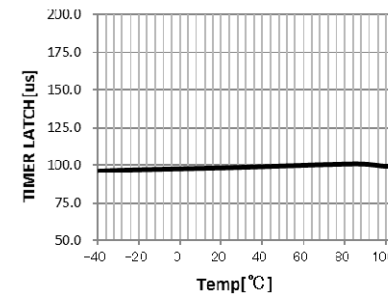

Figure 21, Timer Latch

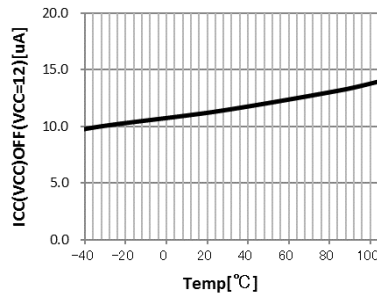

Figure 22, ICC (VCC) OFF (VCC=12)

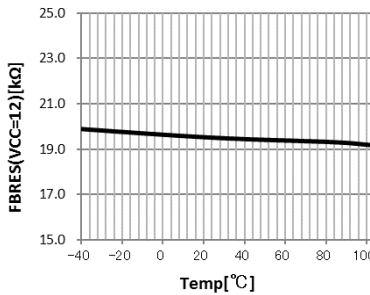

Figure 23, FBRES (VCC=12)

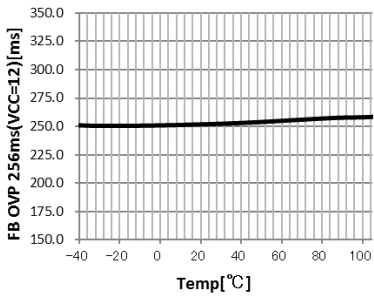

Figure 24, FB OVP 256ms(VCC=12)

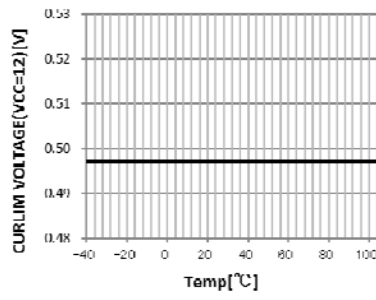

Figure 25, CURLIM Voltage (VCC=12)

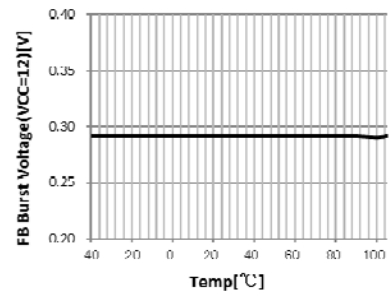

Figure 26, FB Burst Voltage (VCC=12)

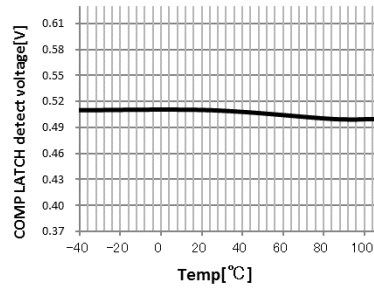

Figure 27, COMP Latch Detect Voltage

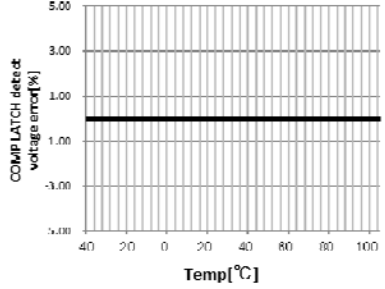

Figure 28, COMP Latch Detect Voltage Error

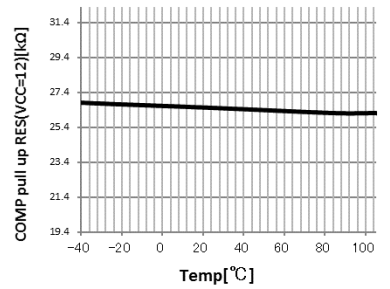

Figure 29, COMP Pull-up RES (VCC=12)

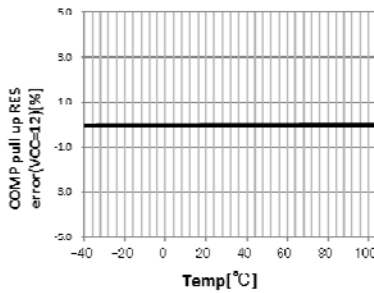

Figure 30, COMP Pull-up RES Error (VCC=12)

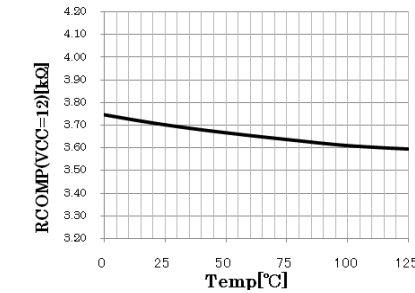

Figure 31, RCOMP (VCC=12)

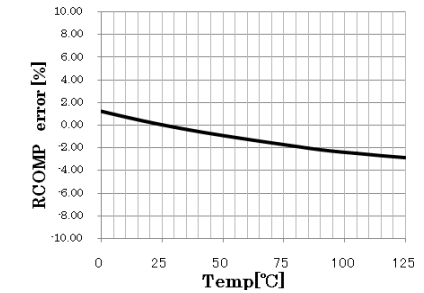

Figure 32, RCOMP Error

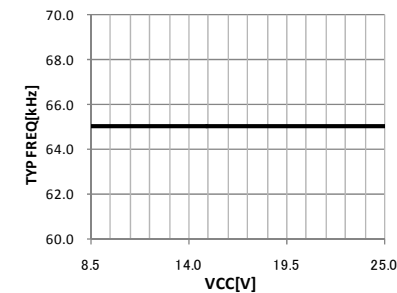

Figure 33, Typ Frequency Fsw1 (temp=25°C)

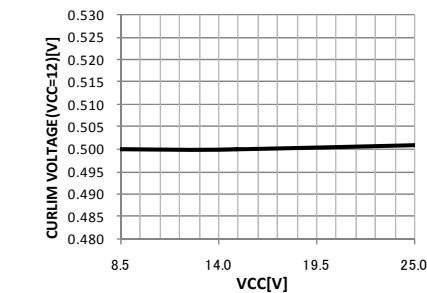

Figure 34, CURLIM Voltage (temp=25°C)

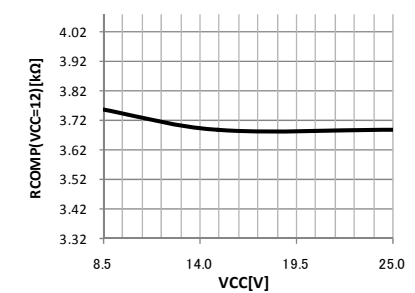

Figure 35, RCOMP (temp=25°C)

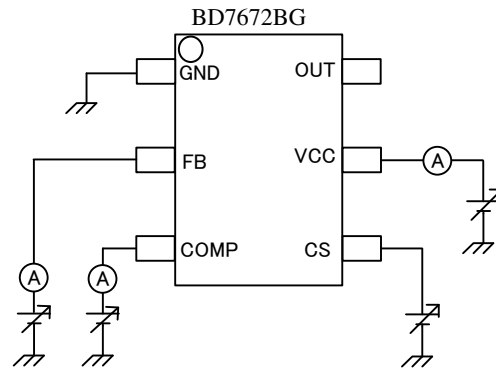

Figure 36, Measurement Circuit Diagram

●Power Dissipation

The thermal design should set the operation for the following conditions.
 (Since the temperature shown below is the guaranteed temperature, be sure to take margin into account.)

1. The ambient temperature T_a must be 105°C or less.
2. The IC's loss must be within the allowable dissipation P_d .

The thermal reduction characteristics are as follows.
 (PCB : 70mm×70mm×1.6mm mounted on glass epoxy single-layer substrate)

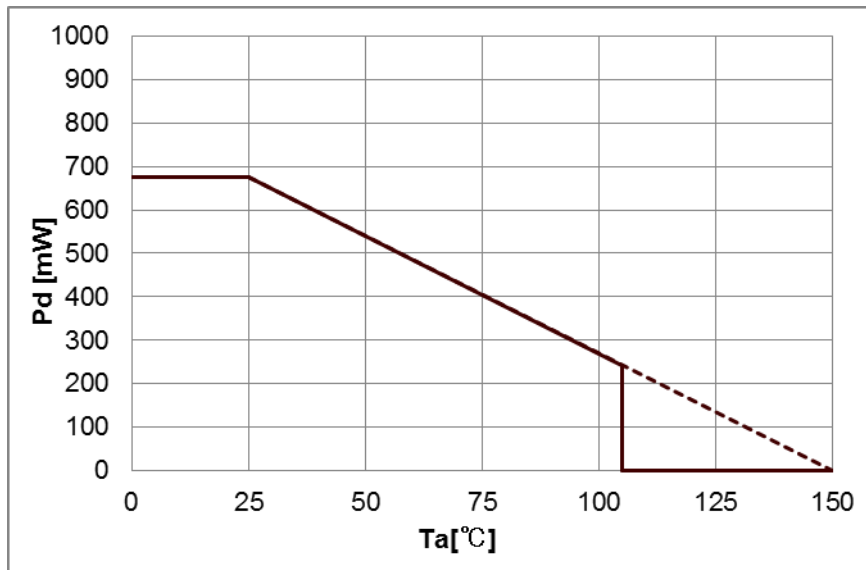

Figure 37, SSOP6 Thermal Reduction Characteristics

●Operational Notes

(2017) Absolute Maximum Ratings

Operating the IC over the absolute maximum ratings may damage the IC. In addition, it is impossible to predict all destructive situations such as short-circuit modes or open circuit modes. Therefore, it is important to consider circuit protection measures, like adding a fuse, in case the IC is expected to be operated in a special mode exceeding the absolute maximum ratings.

(2) Power Supply and Ground Lines

Design the PCB layout pattern to provide low impedance ground and supply lines. Separate the ground and supply lines of the digital and analog blocks to prevent noise in the ground and supply lines of the digital block from affecting the analog block. Furthermore, connect a capacitor to ground at all power supply pins. Consider the effect of temperature and aging on the capacitance value when using electrolytic capacitors.

(3) Ground Voltage

The voltage of the ground pin must be the lowest voltage of all pins of the IC at all operating conditions. Ensure that no pins are at a voltage below the ground pin at any time, even during transient condition.

(4) Short between pins and mounting errors

Be careful when mounting the IC on printed circuit boards. The IC may be damaged if it is mounted in a wrong orientation or if pins are shorted together. Short circuit may be caused by conductive particles caught between the pins.

(5) Operation under strong magnetic fields

Operating the IC in the presence of a strong electromagnetic field may cause the IC to malfunction.

(6) Regarding input pins of the IC

Parasitic diodes inevitably occur in the structure of the IC. The operation of parasitic diodes can result in mutual interference among circuits, operational faults, or physical damage. Therefore, conditions that causes these diodes to operate, such as applying a voltage lower than the GND voltage to an input pin (and thus to the P substrate) should be avoided. Also, do not apply voltage to an input pin when there is no power supply voltage being applied to the IC. In fact, even if a power supply voltage is being applied, the voltage applied to each input pin should be either below the power supply voltage or within the guaranteed values in the electrical characteristics.

(7) External capacitors

When using a ceramic capacitor, determine the dielectric constant considering the change of capacitance with temperature and the decrease in nominal capacitance due to DC bias and others.

(8) Thermal Consideration

Use a thermal design that allows for a sufficient margin by taking into account the permissible power dissipation (Pd) in actual operating conditions.

Also, use these products within ranges that do not put output Tr beyond the rated voltage and ASO.

(9) Rush current

In a CMOS IC, momentary rush current may flow if the internal logic is undefined when the power supply is turned ON, so caution is needed with regard to the power supply coupling capacitance, the width of power supply and GND pattern wires, and how they are laid out.

(10) Unused input terminals

Input terminals of an IC especially logic inputs are often connected to the gate of a CMOS transistor. The gate has extremely high impedance and extremely low capacitance. It can be easily charged by the electric field from the outside if left unconnected. The small charge acquired in this way is enough to produce a significant effect on the conduction through the transistor and cause unexpected operation of IC. So unless otherwise specified, input terminals not being used should be connected to the power supply or ground line.

(11) About this Document

Although the functional description and application notes given in this document are reliable, it does not mean that the particular application a user designs with this IC is guaranteed to work. It is the user's responsibility to check well the design application including other external devices used together with the IC.

● Ordering Information

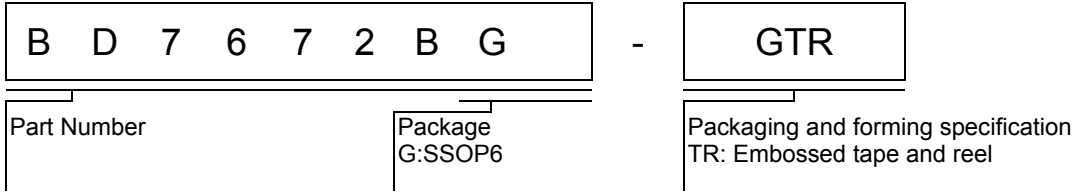

● Marking Diagram

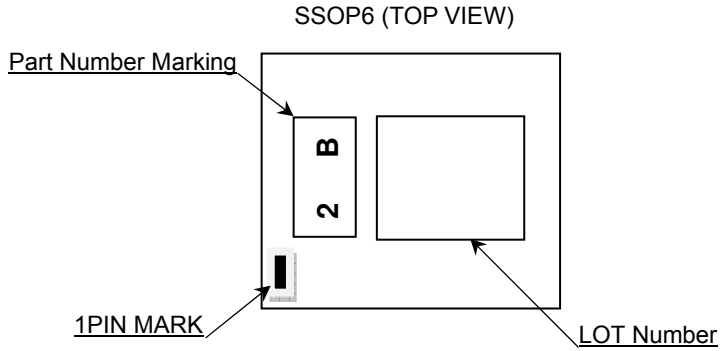

●Physical Dimension, Tape and Reel Information

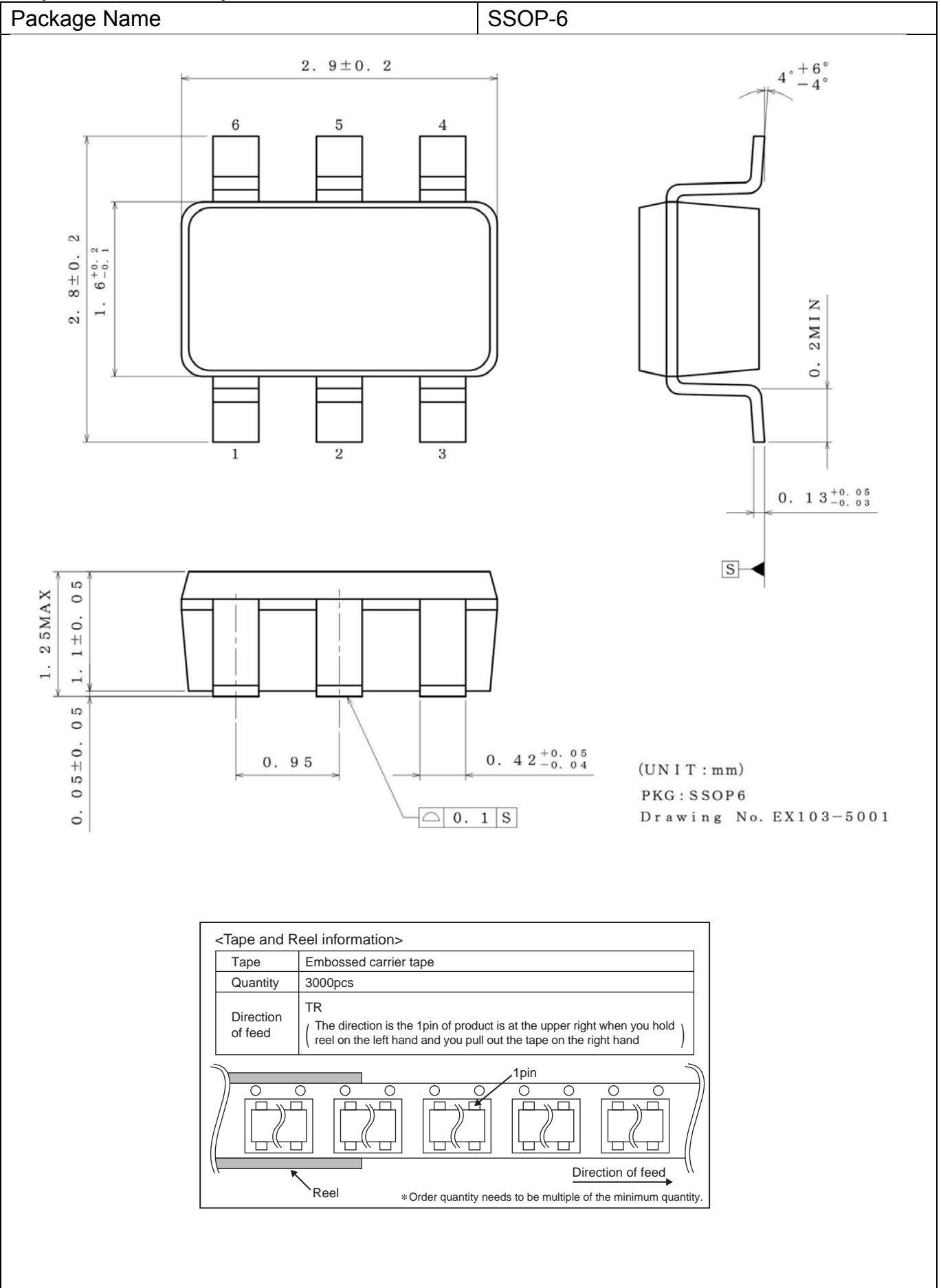

●Revision History

Date	Revision	Changes
2013.5.28	001	New preparation
2015.7.16	002	P1 Modify circuit Figure1 P4 Modify Figure4 P6 Modify written error P6 Modify circuit Figure6 P8 Modify written error P9 Modify written error P10 Modify t written error P13 Modify circuit Figure36 P13 Modify circuit Figure37 P16 Move Physical dimension page
2017.3.22	003	P7 Modify written error P8 Modify written error P9 Note of package power
2017.7.16	004	P1, P9 Change operating temperature range from 85 deg to 105 deg. P13 Figure37 Change thermal reduction characteristics
2017.7.16	005	P13 Change temperature from 85 to 105°C at 4-colum

Notice

Precaution on using ROHM Products

- Our Products are designed and manufactured for application in ordinary electronic equipments (such as AV equipment, OA equipment, telecommunication equipment, home electronic appliances, amusement equipment, etc.). If you intend to use our Products in devices requiring extremely high reliability (such as medical equipment ^(Note 1), transport equipment, traffic equipment, aircraft/spacecraft, nuclear power controllers, fuel controllers, car equipment including car accessories, safety devices, etc.) and whose malfunction or failure may cause loss of human life, bodily injury or serious damage to property ("Specific Applications"), please consult with the ROHM sales representative in advance. Unless otherwise agreed in writing by ROHM in advance, ROHM shall not be in any way responsible or liable for any damages, expenses or losses incurred by you or third parties arising from the use of any ROHM's Products for Specific Applications.

(Note1) Medical Equipment Classification of the Specific Applications

JAPAN	USA	EU	CHINA
CLASS III	CLASS III	CLASS II b	CLASS III
CLASS IV		CLASS III	

- ROHM designs and manufactures its Products subject to strict quality control system. However, semiconductor products can fail or malfunction at a certain rate. Please be sure to implement, at your own responsibilities, adequate safety measures including but not limited to fail-safe design against the physical injury, damage to any property, which a failure or malfunction of our Products may cause. The following are examples of safety measures:
 - Installation of protection circuits or other protective devices to improve system safety
 - Installation of redundant circuits to reduce the impact of single or multiple circuit failure
- Our Products are designed and manufactured for use under standard conditions and not under any special or extraordinary environments or conditions, as exemplified below. Accordingly, ROHM shall not be in any way responsible or liable for any damages, expenses or losses arising from the use of any ROHM's Products under any special or extraordinary environments or conditions. If you intend to use our Products under any special or extraordinary environments or conditions (as exemplified below), your independent verification and confirmation of product performance, reliability, etc. prior to use, must be necessary:
 - Use of our Products in any types of liquid, including water, oils, chemicals, and organic solvents
 - Use of our Products outdoors or in places where the Products are exposed to direct sunlight or dust
 - Use of our Products in places where the Products are exposed to sea wind or corrosive gases, including Cl₂, H₂S, NH₃, SO₂, and NO₂
 - Use of our Products in places where the Products are exposed to static electricity or electromagnetic waves
 - Use of our Products in proximity to heat-producing components, plastic cords, or other flammable items
 - Sealing or coating our Products with resin or other coating materials
 - Use of our Products without cleaning residue of flux (even if you use no-clean type fluxes, cleaning residue of flux is recommended); or Washing our Products by using water or water-soluble cleaning agents for cleaning residue after soldering
 - Use of the Products in places subject to dew condensation
- The Products are not subject to radiation-proof design.
- Please verify and confirm characteristics of the final or mounted products in using the Products.
- In particular, if a transient load (a large amount of load applied in a short period of time, such as pulse. is applied, confirmation of performance characteristics after on-board mounting is strongly recommended. Avoid applying power exceeding normal rated power; exceeding the power rating under steady-state loading condition may negatively affect product performance and reliability.
- De-rate Power Dissipation depending on ambient temperature. When used in sealed area, confirm that it is the use in the range that does not exceed the maximum junction temperature.
- Confirm that operation temperature is within the specified range described in the product specification.
- ROHM shall not be in any way responsible or liable for failure induced under deviant condition from what is defined in this document.

Precaution for Mounting / Circuit board design

- When a highly active halogenous (chlorine, bromine, etc.) flux is used, the residue of flux may negatively affect product performance and reliability.
- In principle, the reflow soldering method must be used on a surface-mount products, the flow soldering method must be used on a through hole mount products. If the flow soldering method is preferred on a surface-mount products, please consult with the ROHM representative in advance.

For details, please refer to ROHM Mounting specification

Precautions Regarding Application Examples and External Circuits

1. If change is made to the constant of an external circuit, please allow a sufficient margin considering variations of the characteristics of the Products and external components, including transient characteristics, as well as static characteristics.
2. You agree that application notes, reference designs, and associated data and information contained in this document are presented only as guidance for Products use. Therefore, in case you use such information, you are solely responsible for it and you must exercise your own independent verification and judgment in the use of such information contained in this document. ROHM shall not be in any way responsible or liable for any damages, expenses or losses incurred by you or third parties arising from the use of such information.

Precaution for Electrostatic

This Product is electrostatic sensitive product, which may be damaged due to electrostatic discharge. Please take proper caution in your manufacturing process and storage so that voltage exceeding the Products maximum rating will not be applied to Products. Please take special care under dry condition (e.g. Grounding of human body / equipment / solder iron, isolation from charged objects, setting of ionizer, friction prevention and temperature / humidity control).

Precaution for Storage / Transportation

1. Product performance and soldered connections may deteriorate if the Products are stored in the places where:
 - [a] the Products are exposed to sea winds or corrosive gases, including Cl₂, H₂S, NH₃, SO₂, and NO₂
 - [b] the temperature or humidity exceeds those recommended by ROHM
 - [c] the Products are exposed to direct sunshine or condensation
 - [d] the Products are exposed to high Electrostatic
2. Even under ROHM recommended storage condition, solderability of products out of recommended storage time period may be degraded. It is strongly recommended to confirm solderability before using Products of which storage time is exceeding the recommended storage time period.
3. Store / transport cartons in the correct direction, which is indicated on a carton with a symbol. Otherwise bent leads may occur due to excessive stress applied when dropping of a carton.
4. Use Products within the specified time after opening a humidity barrier bag. Baking is required before using Products of which storage time is exceeding the recommended storage time period.

Precaution for Product Label

A two-dimensional barcode printed on ROHM Products label is for ROHM's internal use only.

Precaution for Disposition

When disposing Products please dispose them properly using an authorized industry waste company.

Precaution for Foreign Exchange and Foreign Trade act

Since concerned goods might be fallen under listed items of export control prescribed by Foreign exchange and Foreign trade act, please consult with ROHM in case of export.

Precaution Regarding Intellectual Property Rights

1. All information and data including but not limited to application example contained in this document is for reference only. ROHM does not warrant that foregoing information or data will not infringe any intellectual property rights or any other rights of any third party regarding such information or data.
2. ROHM shall not have any obligations where the claims, actions or demands arising from the combination of the Products with other articles such as components, circuits, systems or external equipment (including software).
3. No license, expressly or implied, is granted hereby under any intellectual property rights or other rights of ROHM or any third parties with respect to the Products or the information contained in this document. Provided, however, that ROHM will not assert its intellectual property rights or other rights against you or your customers to the extent necessary to manufacture or sell products containing the Products, subject to the terms and conditions herein.

Other Precaution

1. This document may not be reprinted or reproduced, in whole or in part, without prior written consent of ROHM.
2. The Products may not be disassembled, converted, modified, reproduced or otherwise changed without prior written consent of ROHM.
3. In no event shall you use in any way whatsoever the Products and the related technical information contained in the Products or this document for any military purposes, including but not limited to, the development of mass-destruction weapons.
4. The proper names of companies or products described in this document are trademarks or registered trademarks of ROHM, its affiliated companies or third parties.

General Precaution

1. Before you use our Products, you are requested to carefully read this document and fully understand its contents. ROHM shall not be in any way responsible or liable for failure, malfunction or accident arising from the use of any ROHM's Products against warning, caution or note contained in this document.
2. All information contained in this document is current as of the issuing date and subject to change without any prior notice. Before purchasing or using ROHM's Products, please confirm the latest information with a ROHM sales representative.
3. The information contained in this document is provided on an "as is" basis and ROHM does not warrant that all information contained in this document is accurate and/or error-free. ROHM shall not be in any way responsible or liable for any damages, expenses or losses incurred by you or third parties resulting from inaccuracy or errors of or concerning such information.