

DATA SHEET

SKY65405-21: 2.4 GHz Low-Noise Amplifier

Applications

- 802.11b/g/n PC cards, NICs, and USB dongles
- 802.11b/g/n tablets
- 802.11b/g/n access points, routers, and gateways
- 2.4 GHz ISM radios

Features

- Ultra-low noise figure: 1.1 dB
- 2.4 to 2.5 GHz operation
- Enable/disable mode
- High IIP3: +9 dBm
- High gain: 15 dB
- 2.8 to 5.0 V single-supply operation
- DFN (6-pin, 1.5 x 1.5 mm) package (MSL1, 260 °C per JEDEC J-STD-020)



Skyworks Green™ products are compliant with all applicable legislation and are halogen-free. For additional information, refer to *Skyworks Definition of Green™*, document number SQ04-0074.

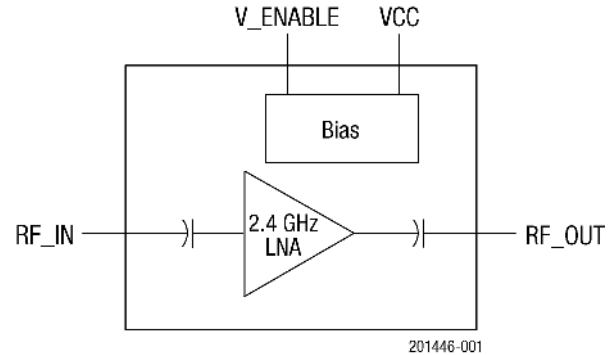

Figure 1. SKY65405-21 LNA Block Diagram

Description

The SKY65405-21 is an ultra-low-noise amplifier (LNA) intended for 2.4 GHz wireless receiver applications. Its industry-leading noise figure (NF), together with high linearity, makes it ideal as a first-stage LNA in 802.11b/g wireless local area network (WLAN) radios.

Operating with a single supply voltage, the SKY65405-21 consumes only 12 mA of current. The device includes a shutdown mode to save power when the receiver is inactive.

The tiny package footprint of the SKY65405-21, requiring only four external components, enables the industry’s smallest PCB area needed to implement a 2.4 GHz LNA.

A block diagram of the SKY65405-21 is shown in Figure 1. The device package and pinout for the 6-pin Dual Flat No-Lead (DFN) are shown in Figure 2. Signal pin assignments and functional pin descriptions are described in Table 1.

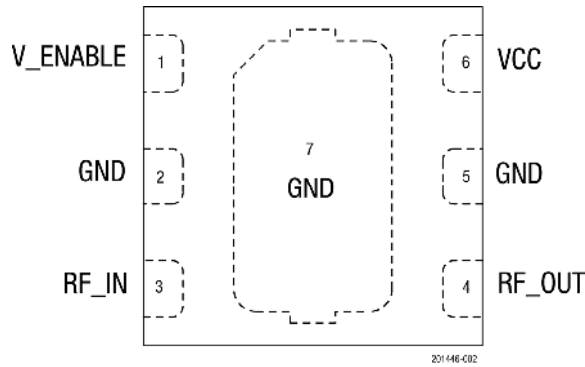

Figure 2. SKY65405-21 Pinout (Top View)

Table 1. SKY65405-21 Pin Assignments and Signal Descriptions

Pin	Name	Description
1	V_ENABLE	Enable control input
2	GND	RF ground, DC ground
3	RF_IN	LNA input
4	RF_OUT	LNA output
5	GND	RF ground, DC ground
6	VCC	Supply voltage for LNA
7	GND	Center pad: thermal ground, DC ground

Technical Description

The SKY65405-21 requires an external matching circuit on pin 3 (RF_IN) and a bypass circuit on pin 6 (VCC). An external resistor on the V_ENABLE signal (pin 1) allows a wide range of control voltages to be used. Shutdown mode is achieved by switching the V_ENABLE signal to 0 V. The GND pins (2 and 5) provide RF and DC grounds. The center pad (pin 7) provides DC ground as well as a path for thermal energy dissipation.

Electrical and Mechanical Specifications

The absolute maximum ratings of the SKY65405-21 are provided in Table 2. The recommended operating conditions are specified in Table 3, and electrical specifications are provided in Table 4. Table 5 provides the control logic for the SKY65405-21.

Performance characteristics for the SKY65405-21 are illustrated in Figures 3, 4, and 5.

Table 2. SKY65405-21 Absolute Maximum Ratings

Parameter	Symbol	Minimum	Maximum	Units
Supply voltage	VCC	0	5.5	V
DC voltage at control ports	V _{ENABLE}	0	5.0	V
Power into LNA inputs	P _{IN, LNA}		+2	dBm
Operating temperature	T _A	-40	+85	°C
Storage temperature	T _{STG}	-40	+125	°C

ESD HANDLING: Although this device is designed to be as robust as possible, electrostatic discharge (ESD) can damage this device. This device must be protected at all times from ESD when handling or transporting. Static charges may easily produce potentials of several kilovolts on the human body or equipment, which can discharge without detection. Industry-standard ESD handling precautions should be used at all times.

Table 3. SKY65405-21 Recommended Operating Conditions (@ +25 °C, V_{CC} = 3 V)

Parameter	Symbol	Min	Typ	Max	Units
Supply voltage	V _{CC}	2.8	3.3	5.0	V
Enable voltage: High	V _{EN}	2.5	3.3	3.5	V
Low		0	0	0.2	V
RF frequency range	f	2400		2500	MHz
Operating temperature range	T _A	-40	+25	+85	°C

Table 4. SKY65405-21 Electrical Characteristics (2400 to 2500 MHz)¹
(V_{CC} = 3 V, T_A = +25 °C, V_{ENABLE} = 3 V, Unless Otherwise Noted)

Parameter	Symbol	Test Conditions	Min	Typ	Max	Units
Enable Mode						
Gain	S ₂₁		13	15	17	dB
Noise figure	NF			1.1	1.5	dB
Third order input intercept point	IIP3		+7	+9		dBm
In-band 1 dB compression point at input	IP1dB		-2	0		dBm
Out-of-band 1 dB compression point at input	IP1dB		+12	+15		dBm
Input/output return loss	S ₁₁ , S ₂₂	Z _{s/L} = 50 Ω		-10	-6	dB
Reverse isolation	S ₁₂		18	22		dB
Current		V _{ENABLE} = 3 V		12	16	mA
		V _{ENABLE} = 0 V		<1	5	μA
V _{ENABLE} current	I _{EN_HIGH}	V _{ENABLE} = 3 V		2.3	3.0	mA
Rise time	t _{RISE}			175	280	ns
Fall time	t _{FALL}			145	250	ns
Disable Mode (Small Signal Input)						
Gain	S ₂₁		-17	-14	-11	dB
Input return loss	S ₁₁			-2	-1	dB
Output return loss	S ₂₂			-3	-2	dB
V _{ENABLE} current	I _{EN_LOW}	V _{ENABLE} = 0 V to 0.2 V		1.7	1.9	μA

¹ Performance is guaranteed only under the conditions listed in this table.

Table 5. SKY65405-21 Mode Control Logic

V _{ENABLE} Voltage (V)	Description
3	LNA is enabled
0	LNA is disabled

Typical Performance Characteristics

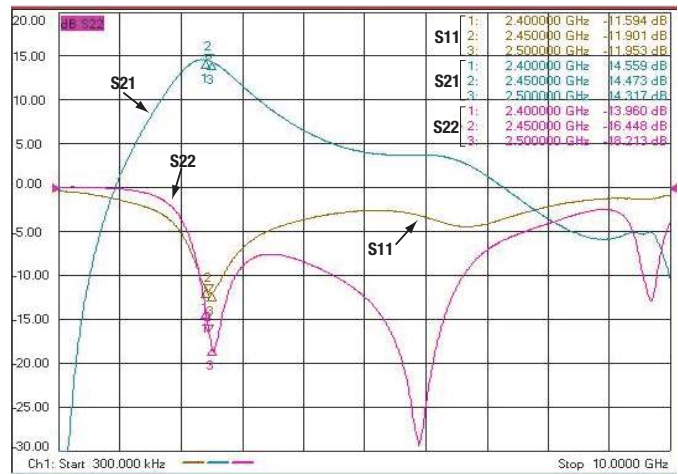

Figure 3. S-Parameter Data

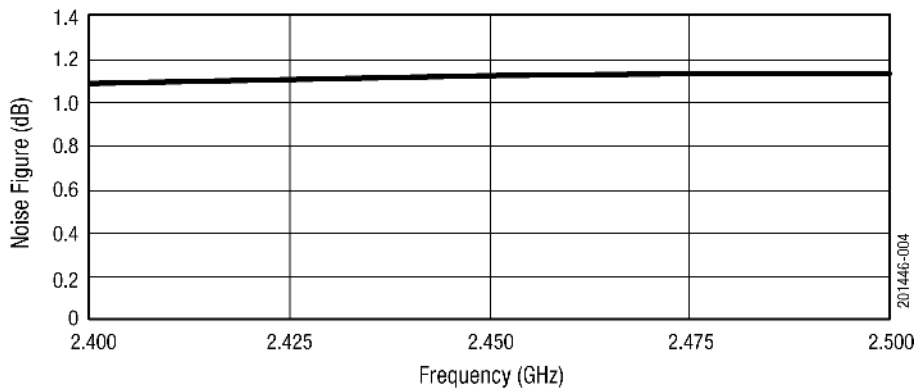

Figure 4. Noise Figure vs Frequency

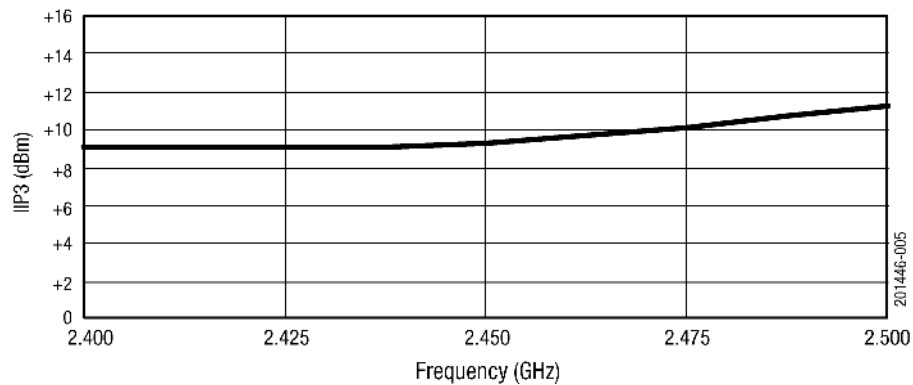

Figure 5. IIP3 vs Frequency

Evaluation Board Description

An application schematic diagram for the SKY65405-21 is shown in Figure 6.

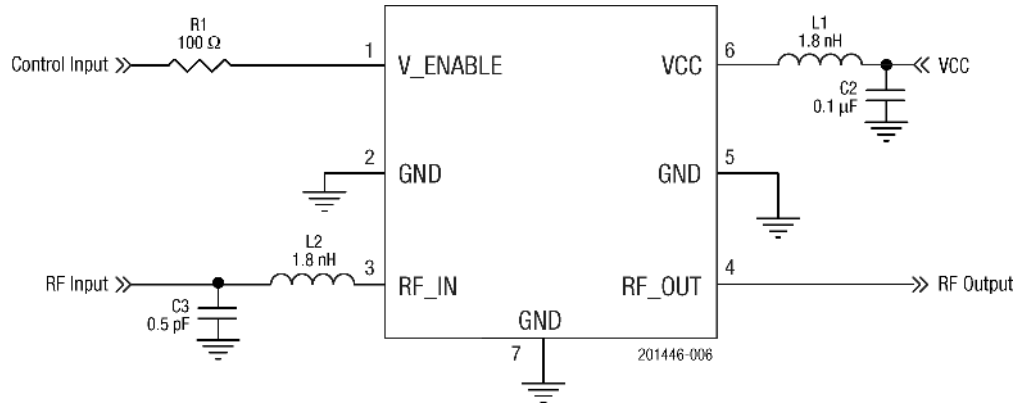

Figure 6. SKY65405-21 Application Schematic Diagram

Package Dimensions

The PCB layout footprint for the SKY65405-21 is provided in Figure 7. Typical part markings are shown in Figure 8. Package dimensions are shown in Figure 9, and tape and reel dimensions are provided in Figure 10.

Package and Handling Information

Instructions on the shipping container label regarding exposure to moisture after the container seal is broken must be followed. Otherwise, problems related to moisture absorption may occur when the part is subjected to high temperature during solder assembly.

The SKY65405-21 is rated to Moisture Sensitivity Level 1 (MSL1) at 260 °C. It can be used for lead or lead-free soldering. For additional information, refer to the Skyworks Application Note, *Solder Reflow Information*, document number 200164.

Care must be taken when attaching this product, whether it is done manually or in a production solder reflow environment. Production quantities of this product are shipped in a standard tape and reel format.

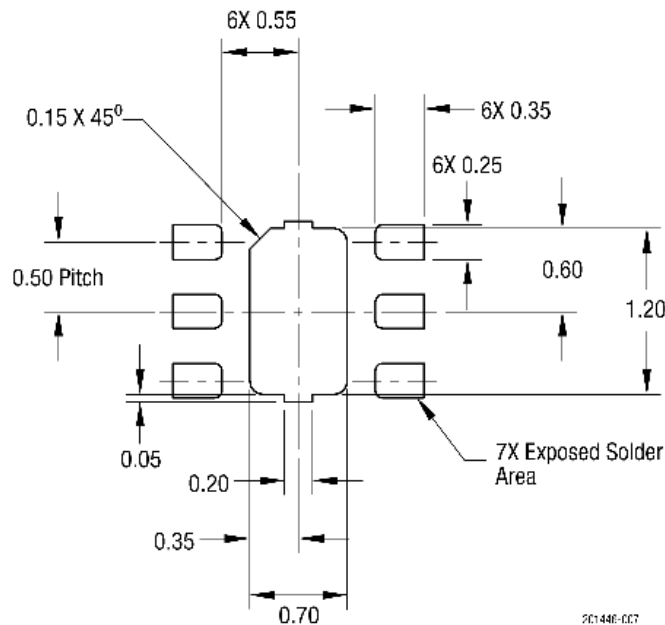

Figure 7. SKY65405-21 PCB Layout Footprint (Top View)

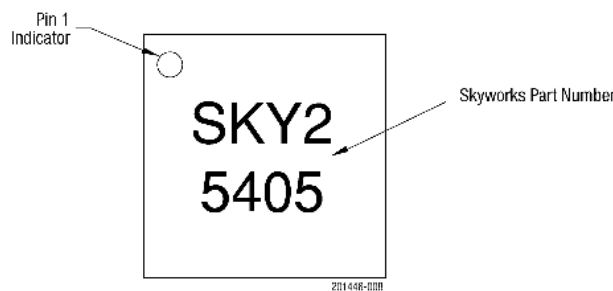

Figure 8. Typical Part Markings

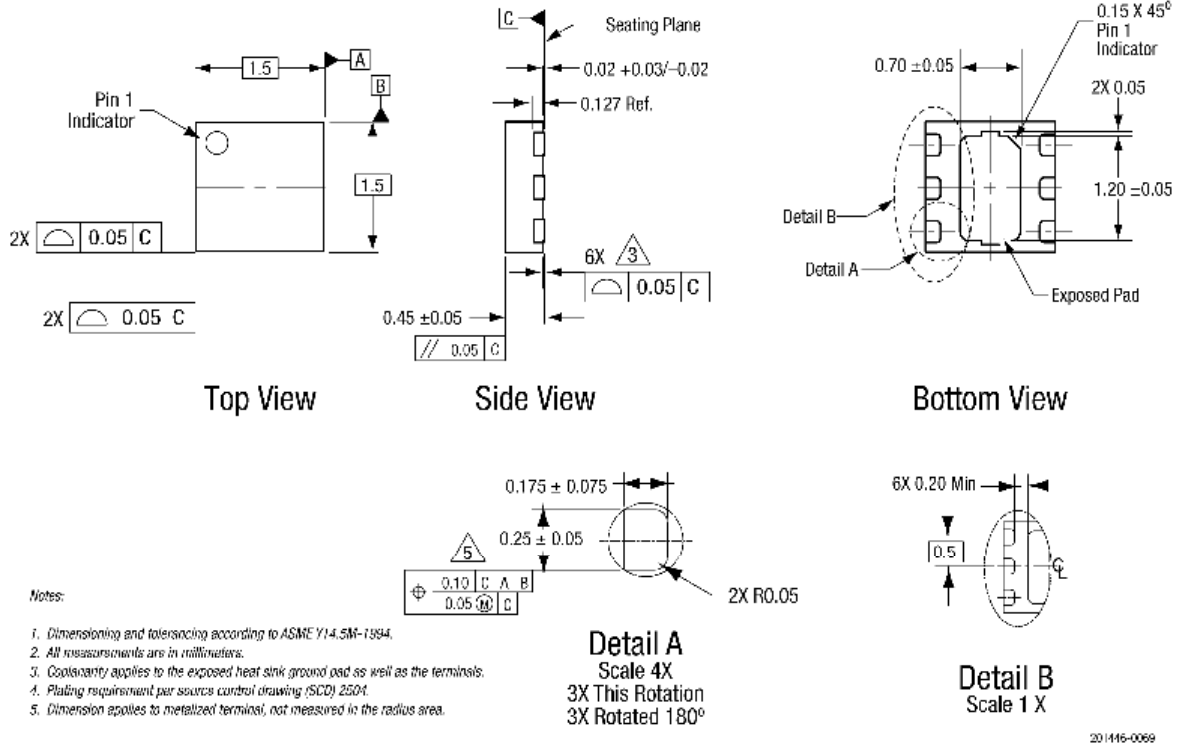

Figure 9. SKY65405-21 Package Dimensions

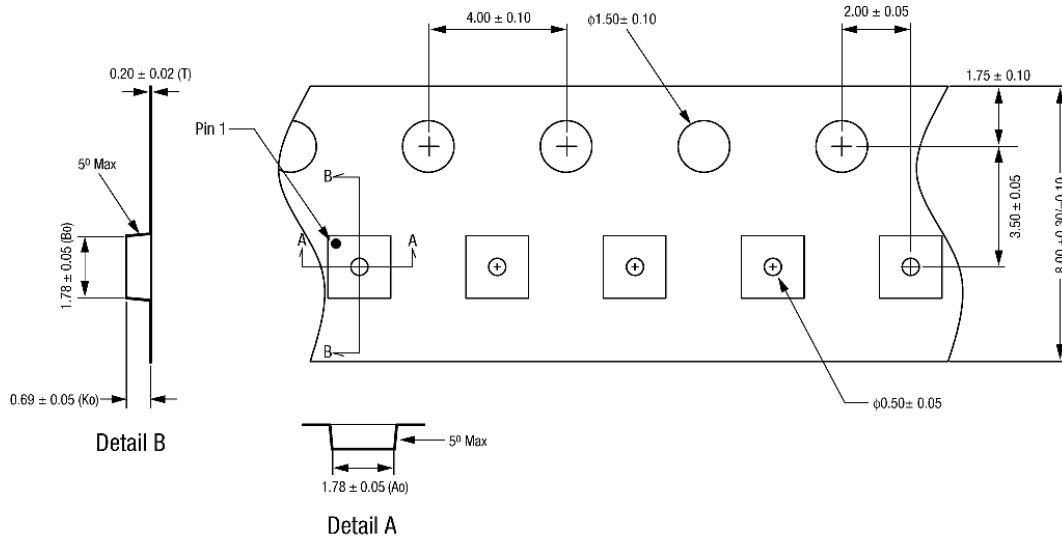

Figure 10. SKY65405-21 Tape and Reel Dimensions

Ordering Information

Part Number	Product Description	Evaluation Board Part Number
SKY65405-21	2.4 GHz Low-Noise Amplifier	SKY65405-21EK1

Copyright © 2010-2011, 2013, 2017-2019 Skyworks Solutions, Inc. All Rights Reserved.

Information in this document is provided in connection with Skyworks Solutions, Inc. (“Skyworks”) products or services. These materials, including the information contained herein, are provided by Skyworks as a service to its customers and may be used for informational purposes only by the customer. Skyworks assumes no responsibility for errors or omissions in these materials or the information contained herein. Skyworks may change its documentation, products, services, specifications or product descriptions at any time, without notice. Skyworks makes no commitment to update the materials or information and shall have no responsibility whatsoever for conflicts, incompatibilities, or other difficulties arising from any future changes.

No license, whether express, implied, by estoppel or otherwise, is granted to any intellectual property rights by this document. Skyworks assumes no liability for any materials, products or information provided hereunder, including the sale, distribution, reproduction or use of Skyworks products, information or materials, except as may be provided in Skyworks Terms and Conditions of Sale.

THE MATERIALS, PRODUCTS AND INFORMATION ARE PROVIDED “AS IS” WITHOUT WARRANTY OF ANY KIND, WHETHER EXPRESS, IMPLIED, STATUTORY, OR OTHERWISE, INCLUDING FITNESS FOR A PARTICULAR PURPOSE OR USE, MERCHANTABILITY, PERFORMANCE, QUALITY OR NON-INFRINGEMENT OF ANY INTELLECTUAL PROPERTY RIGHT; ALL SUCH WARRANTIES ARE HEREBY EXPRESSLY DISCLAIMED. SKYWORKS DOES NOT WARRANT THE ACCURACY OR COMPLETENESS OF THE INFORMATION, TEXT, GRAPHICS OR OTHER ITEMS CONTAINED WITHIN THESE MATERIALS. SKYWORKS SHALL NOT BE LIABLE FOR ANY DAMAGES, INCLUDING BUT NOT LIMITED TO ANY SPECIAL, INDIRECT, INCIDENTAL, STATUTORY, OR CONSEQUENTIAL DAMAGES, INCLUDING WITHOUT LIMITATION, LOST REVENUES OR LOST PROFITS THAT MAY RESULT FROM THE USE OF THE MATERIALS OR INFORMATION, WHETHER OR NOT THE RECIPIENT OF MATERIALS HAS BEEN ADVISED OF THE POSSIBILITY OF SUCH DAMAGE.

Skyworks products are not intended for use in medical, lifesaving or life-sustaining applications, or other equipment in which the failure of the Skyworks products could lead to personal injury, death, physical or environmental damage. Skyworks customers using or selling Skyworks products for use in such applications do so at their own risk and agree to fully indemnify Skyworks for any damages resulting from such improper use or sale.

Customers are responsible for their products and applications using Skyworks products, which may deviate from published specifications as a result of design defects, errors, or operation of products outside of published parameters or design specifications. Customers should include design and operating safeguards to minimize these and other risks. Skyworks assumes no liability for applications assistance, customer product design, or damage to any equipment resulting from the use of Skyworks products outside of stated published specifications or parameters.

Skyworks and the Skyworks symbol are trademarks or registered trademarks of Skyworks Solutions, Inc. or its subsidiaries in the United States and other countries. Third-party brands and names are for identification purposes only, and are the property of their respective owners. Additional information, including relevant terms and conditions, posted at www.skyworksinc.com, are incorporated by reference.