

C3M0120065D

Silicon Carbide Power MOSFET

C3M™ MOSFET Technology

N-Channel Enhancement Mode

Features

- 3rd Generation SiC MOSFET technology
- High blocking voltage with low on-resistance
- High speed switching with low capacitances
- Fast intrinsic diode with low reverse recovery (Qrr)
- Halogen free, RoHS compliant

Benefits

- Higher system efficiency
- Reduced cooling requirements
- Increased power density
- Increased system switching frequency
- Easy to parallel and simple to drive
- Enable new hard switching PFC topologies (Totem-Pole)

Applications

- Solar inverters
- DC/DC converters
- Switch Mode Power Supplies
- EV battery chargers
- UPS

V_{DS}	650 V
$I_D @ 25^\circ\text{C}$	22 A
$R_{DS(on)}$	120 mΩ

Package

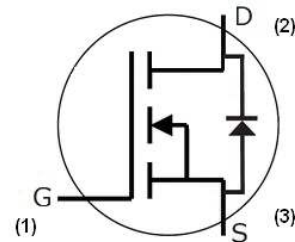
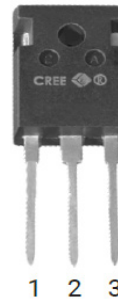

Part Number	Package	Marking
C3M0120065D	TO-247-3	C3M0120065D

Maximum Ratings

Symbol	Parameter	Value	Unit	Note
V_{DSS}	Drain - Source Voltage, $T_C = 25^\circ\text{C}$	650	V	
V_{GS}	Gate - Source voltage (Under transient events < 100 ns)	-8/+19	V	Fig. 29
I_D	Continuous Drain Current, $V_{GS} = 15\text{ V}$, $T_C = 25^\circ\text{C}$	22	A	Fig. 19
	Continuous Drain Current, $V_{GS} = 15\text{ V}$, $T_C = 100^\circ\text{C}$	16		
$I_{D(pulse)}$	Pulsed Drain Current, Pulse width t_p limited by T_{Jmax}	51	A	
P_D	Power Dissipation, $T_C = 25^\circ\text{C}$, $T_J = 175^\circ\text{C}$	98	W	Fig. 20
T_J, T_{stg}	Operating Junction and Storage Temperature	-40 to +175	$^\circ\text{C}$	
T_L	Solder Temperature, 1.6mm (0.063") from case for 10s	260	$^\circ\text{C}$	
M_d	Mounting Torque, (M3 or 6-32 screw)	1	Nm	
		8.8		

Symbol	Parameter	Min.	Typ.	Max.	Unit	Test Conditions	Note	
$V_{(BR)DSS}$	Drain-Source Breakdown Voltage	650			V	$V_{GS} = 0\text{ V}, I_D = 100\ \mu\text{A}$		
V_{GSon}	Gate-Source Recommended Turn-On Voltage		15		V	Static	Fig. 29	
V_{GSoff}	Gate-Source Recommended Turn-Off Voltage		-4		V			
$V_{GS(th)}$	Gate Threshold Voltage	1.8	2.3	3.6	V	$V_{DS} = V_{GS}, I_D = 1.86\ \text{mA}$	Fig. 11	
			1.9		V	$V_{DS} = V_{GS}, I_D = 1.86\ \text{mA}, T_J = 175^\circ\text{C}$		
I_{DSS}	Zero Gate Voltage Drain Current		1	50	μA	$V_{DS} = 650\ \text{V}, V_{GS} = 0\ \text{V}$		
I_{GSS}	Gate-Source Leakage Current		10	250	nA	$V_{GS} = 15\ \text{V}, V_{DS} = 0\ \text{V}$		
$R_{DS(on)}$	Drain-Source On-State Resistance		120	157	m Ω	$V_{GS} = 15\ \text{V}, I_D = 6.76\ \text{A}$	Fig. 4, 5, 6	
			168			$V_{GS} = 15\ \text{V}, I_D = 6.76\ \text{A}, T_J = 175^\circ\text{C}$		
g_{fs}	Transconductance		5.0		S	$V_{DS} = 20\ \text{V}, I_{DS} = 6.76\ \text{A}$	Fig. 7	
			4.9			$V_{DS} = 20\ \text{V}, I_{DS} = 6.76\ \text{A}, T_J = 175^\circ\text{C}$		
C_{iss}	Input Capacitance		640		pF	$V_{GS} = 0\ \text{V}, V_{DS} = 0\ \text{V to } 400\ \text{V}$ $F = 1\ \text{Mhz}$ $V_{AC} = 25\ \text{mV}$	Fig. 17, 18	
C_{oss}	Output Capacitance		45					
C_{rss}	Reverse Transfer Capacitance		2.3					
$C_{o(er)}$	Effective Output Capacitance (Energy Related)		57				$V_{GS} = 0\ \text{V}, V_{DS} = 0\ \text{V to } 400\ \text{V}$	Note: 1
$C_{o(tr)}$	Effective Output Capacitance (Time Related)		79					Note: 1
E_{oss}	C_{oss} Stored Energy		4.3		μJ	$V_{DS} = 400\ \text{V}, F = 1\ \text{Mhz}$	Fig. 16	
E_{ON}	Turn-On Switching Energy (Body Diode)		71		μJ	$V_{DS} = 400\ \text{V}, V_{GS} = -4\ \text{V}/15\ \text{V}, I_D = 6.76\ \text{A},$ $R_{G(ext)} = 10\ \Omega, L = 237\ \mu\text{H}, T_J = 175^\circ\text{C}$ FWD = Internal Body Diode of MOSFET	Fig. 25	
E_{OFF}	Turn Off Switching Energy (Body Diode)		8					
E_{ON}	Turn-On Switching Energy (External Diode)		57		μJ	$V_{DS} = 400\ \text{V}, V_{GS} = -4\ \text{V}/15\ \text{V}, I_D = 6.76\ \text{A},$ $R_{G(ext)} = 10\ \Omega, L = 237\ \mu\text{H}, T_J = 175^\circ\text{C}$ FWD = External SiC DIODE	Fig. 25	
E_{OFF}	Turn Off Switching Energy (External Diode)		7					
$t_{d(on)}$	Turn-On Delay Time		7		ns	$V_{DD} = 400\ \text{V}, V_{GS} = -4\ \text{V}/15\ \text{V}$ $I_D = 6.76\ \text{A}, R_{G(ext)} = 10\ \Omega$ Timing relative to V_{DS} Inductive load	Fig. 26	
t_r	Rise Time		17					
$t_{d(off)}$	Turn-Off Delay Time		13					
t_f	Fall Time		8					
$R_{G(int)}$	Internal Gate Resistance		6		Ω	$f = 1\ \text{MHz}, V_{AC} = 25\ \text{mV}$		
Q_{gs}	Gate to Source Charge		7		nC	$V_{DS} = 400\ \text{V}, V_{GS} = -4\ \text{V}/15\ \text{V}$ $I_D = 6.76\ \text{A}$ Per IEC60747-8-4 pg 21	Fig. 12	
Q_{gd}	Gate to Drain Charge		11					
Q_g	Total Gate Charge		28					

Note (1): $C_{o(er)}$, a lumped capacitance that gives same stored energy as C_{oss} while V_{ds} is rising from 0 to 400V
 $C_{o(tr)}$, a lumped capacitance that gives same charging time as C_{oss} while V_{ds} is rising from 0 to 400V

Reverse Diode Characteristics ($T_c = 25^\circ\text{C}$ unless otherwise specified)

Symbol	Parameter	Typ.	Max.	Unit	Test Conditions	Note
V_{SD}	Diode Forward Voltage	4.5		V	$V_{GS} = -4\text{ V}, I_{SD} = 3.4\text{ A}, T_J = 25^\circ\text{C}$	Fig. 8, 9, 10
		4.0		V	$V_{GS} = -4\text{ V}, I_{SD} = 3.4\text{ A}, T_J = 175^\circ\text{C}$	
I_S	Continuous Diode Forward Current		16	A	$V_{GS} = -4\text{ V}, T_c = 25^\circ\text{C}$	
$I_{S, pulse}$	Diode pulse Current		51	A	$V_{GS} = -4\text{ V}$, pulse width t_p limited by T_{jmax}	
t_{rr}	Reverse Recover time	18		ns	$V_{GS} = -4\text{ V}, I_{SD} = 6.76\text{ A}, V_R = 400\text{ V}$ $\text{dif}/\text{dt} = 2160\text{ A}/\mu\text{s}, T_J = 175^\circ\text{C}$	
Q_{rr}	Reverse Recovery Charge	81		nC		
I_{rrm}	Peak Reverse Recovery Current	7		A		
t_{rr}	Reverse Recover time	25		ns	$V_{GS} = -4\text{ V}, I_{SD} = 6.76\text{ A}, V_R = 400\text{ V}$ $\text{dif}/\text{dt} = 900\text{ A}/\mu\text{s}, T_J = 175^\circ\text{C}$	
Q_{rr}	Reverse Recovery Charge	76		nC		
I_{rrm}	Peak Reverse Recovery Current	4		A		

Thermal Characteristics

Symbol	Parameter	Typ.	Unit	Test Conditions	Note
$R_{\theta JC}$	Thermal Resistance from Junction to Case	1.53	$^\circ\text{C}/\text{W}$		Fig. 21
$R_{\theta JA}$	Thermal Resistance From Junction to Ambient	40			

Typical Performance

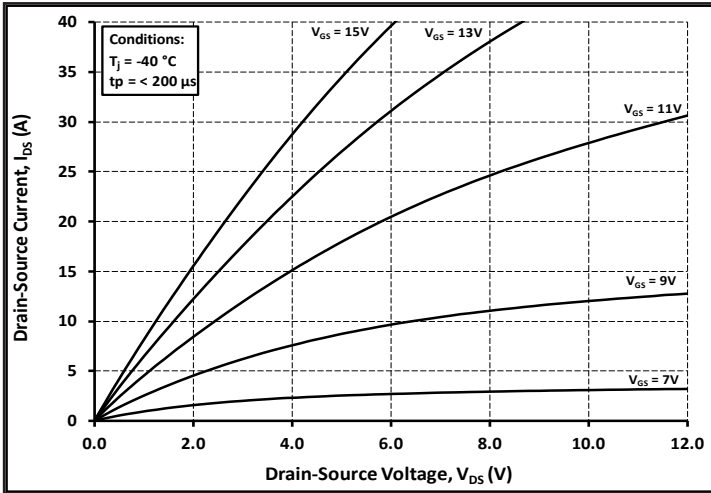

Figure 1. Output Characteristics $T_J = -40\text{ }^\circ\text{C}$

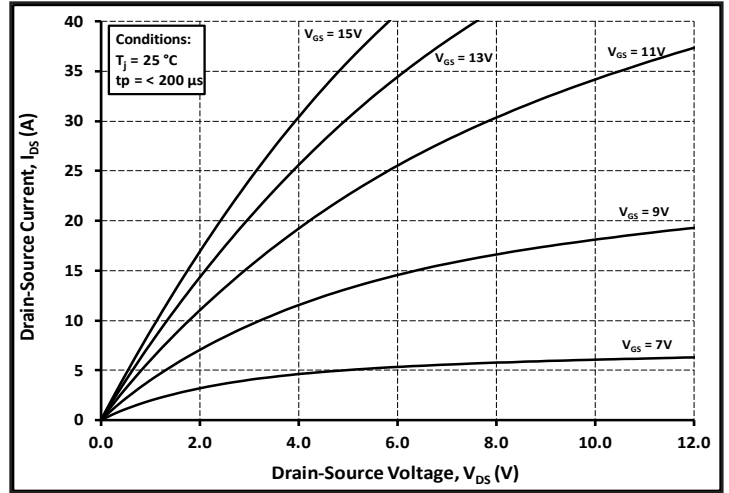

Figure 2. Output Characteristics $T_J = 25\text{ }^\circ\text{C}$

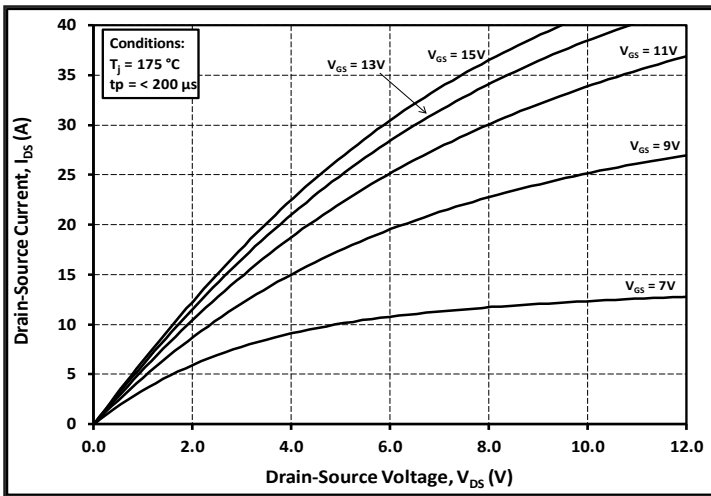

Figure 3. Output Characteristics $T_J = 175\text{ }^\circ\text{C}$

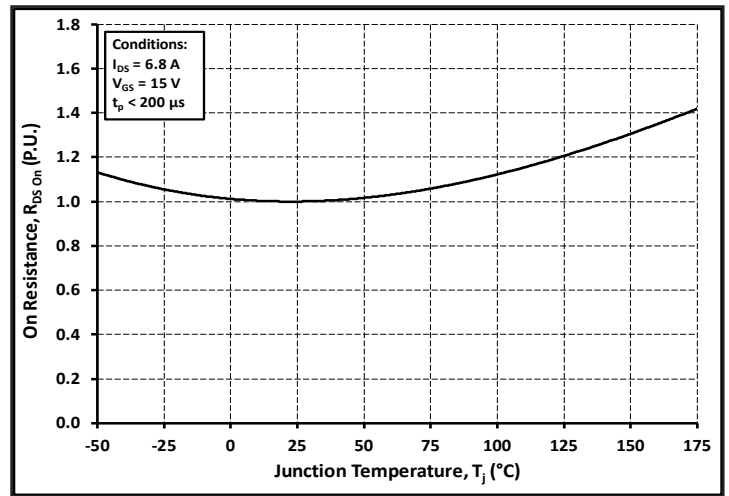

Figure 4. Normalized On-Resistance vs. Temperature

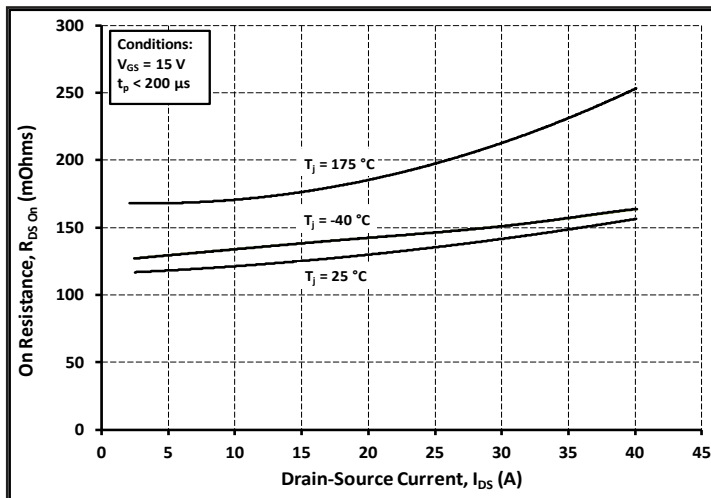

Figure 5. On-Resistance vs. Drain Current For Various Temperatures

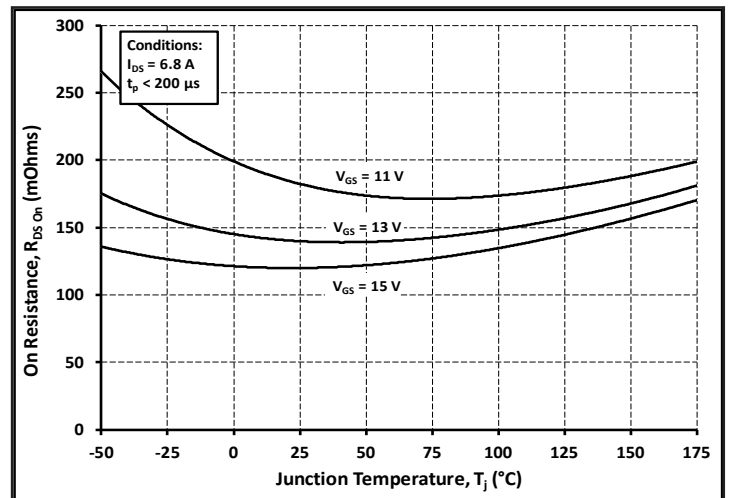

Figure 6. On-Resistance vs. Temperature For Various Gate Voltage

Typical Performance

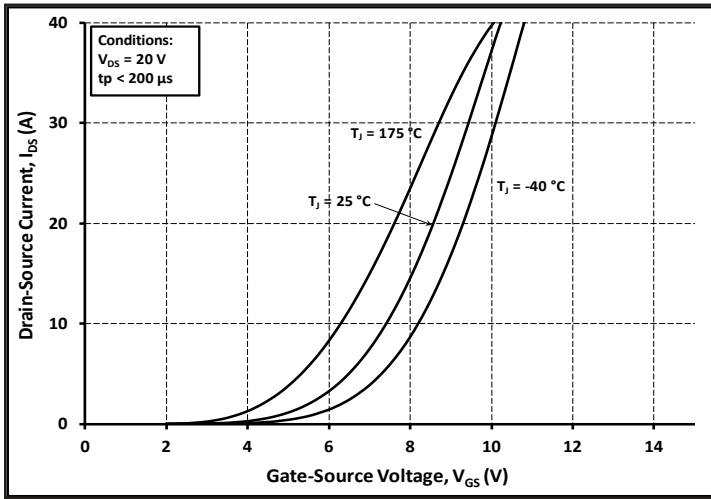

Figure 7. Transfer Characteristic for Various Junction Temperatures

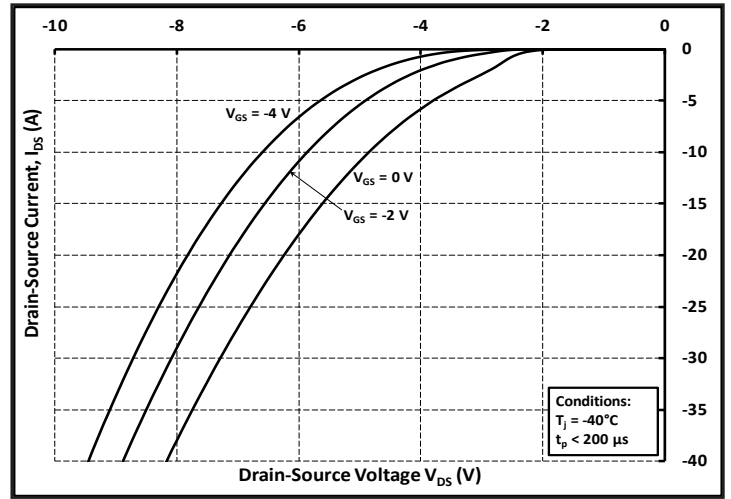

Figure 8. Body Diode Characteristic at -40 °C

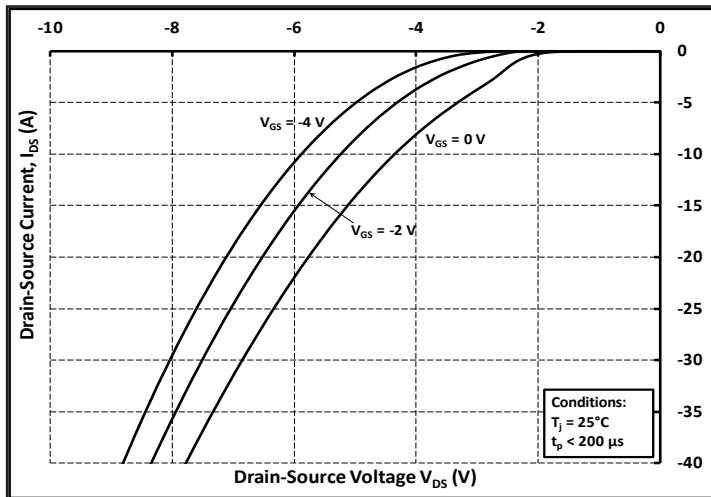

Figure 9. Body Diode Characteristic at 25 °C

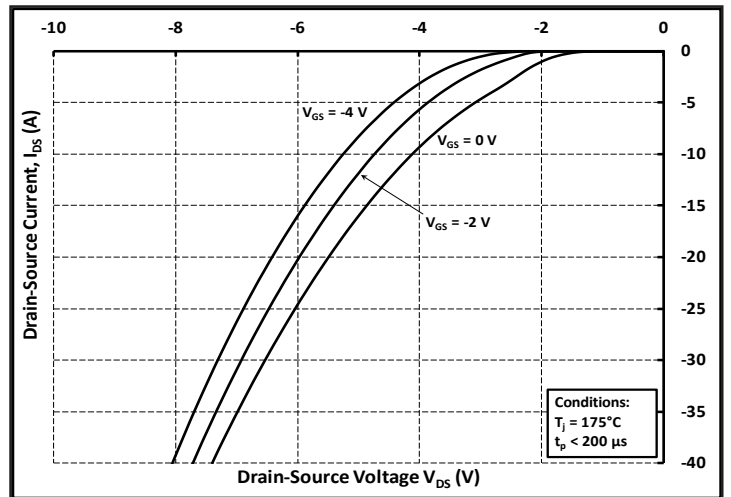

Figure 10. Body Diode Characteristic at 175 °C

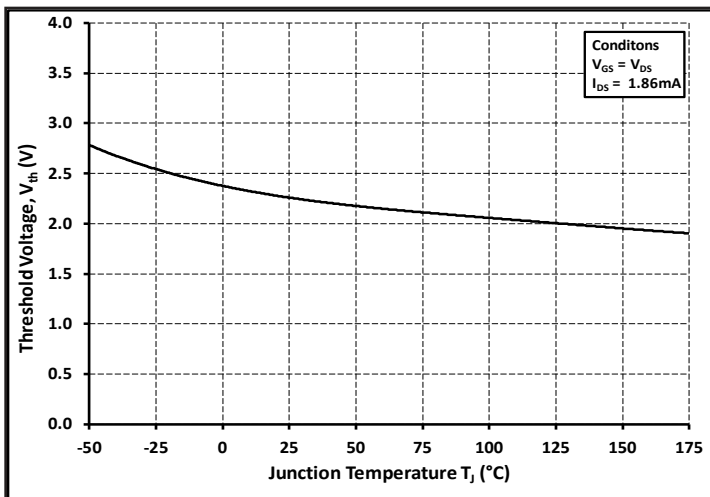

Figure 11. Threshold Voltage vs. Temperature

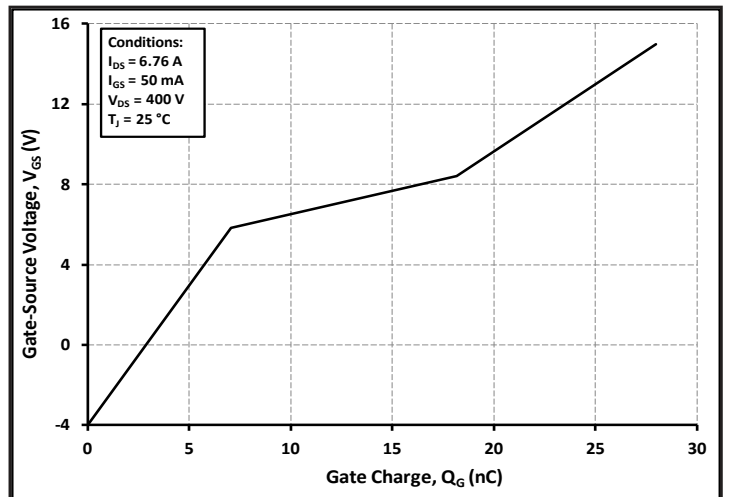

Figure 12. Gate Charge Characteristics

Typical Performance

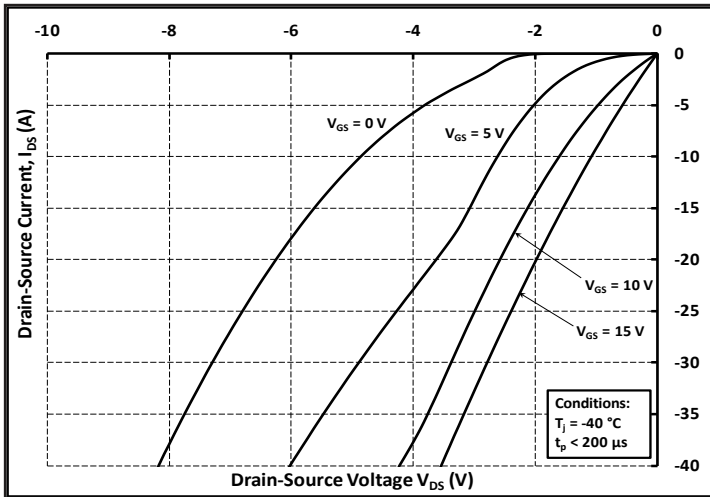

Figure 13. 3rd Quadrant Characteristic at -40 °C

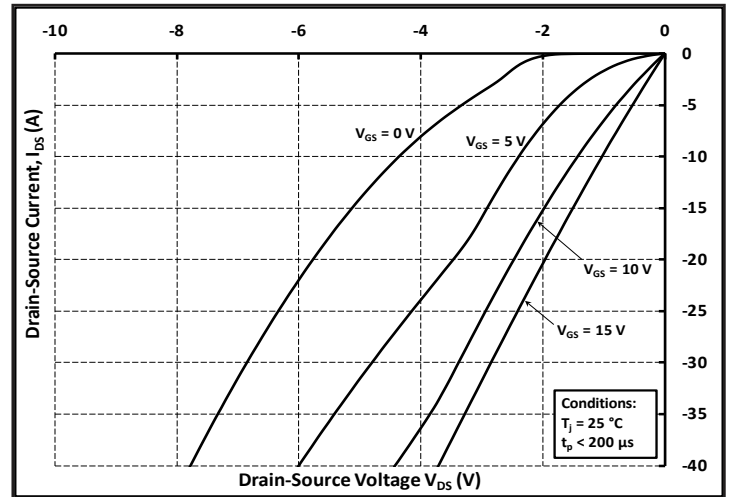

Figure 14. 3rd Quadrant Characteristic at 25 °C

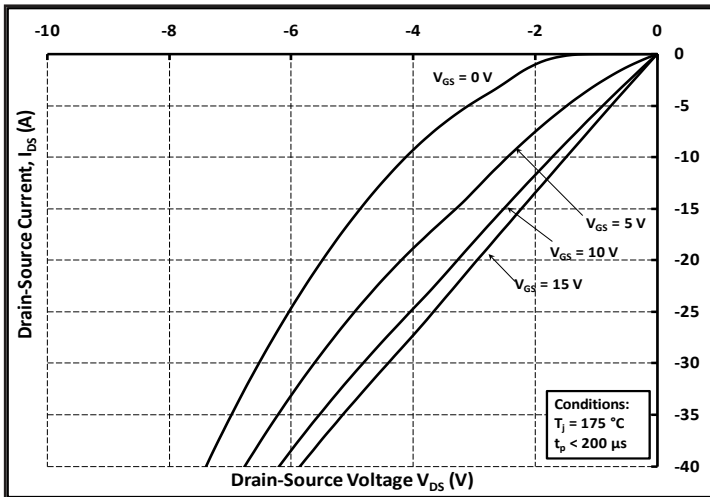

Figure 15. 3rd Quadrant Characteristic at 175 °C

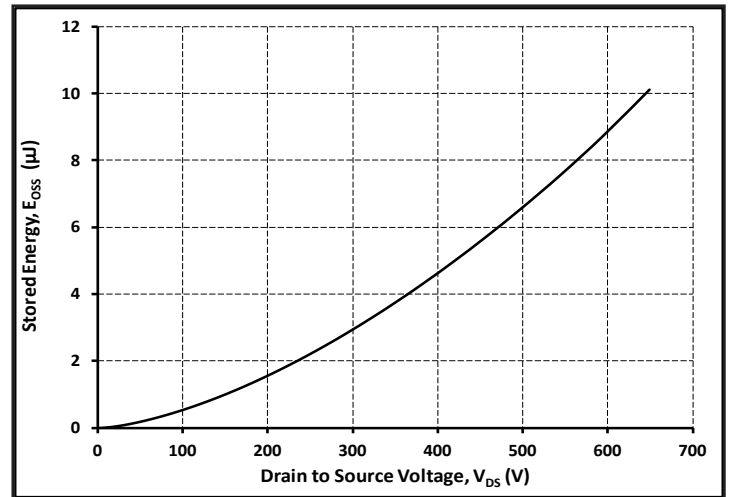

Figure 16. Output Capacitor Stored Energy

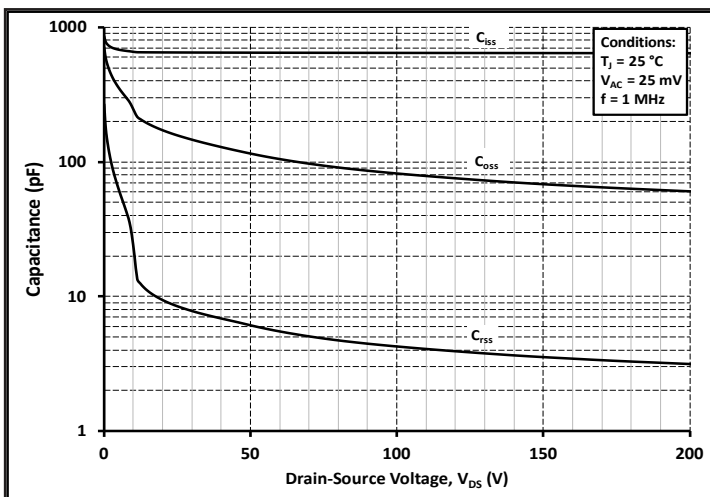

Figure 17. Capacitances vs. Drain-Source Voltage (0 - 200V)

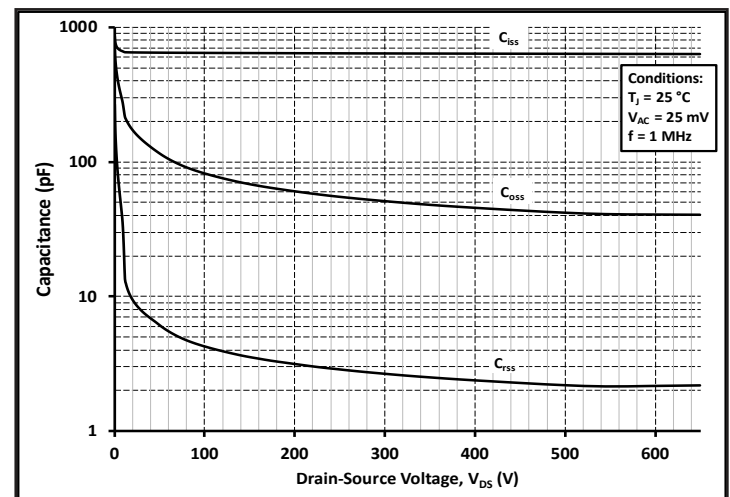

Figure 18. Capacitances vs. Drain-Source Voltage (0 - 650V)

Typical Performance

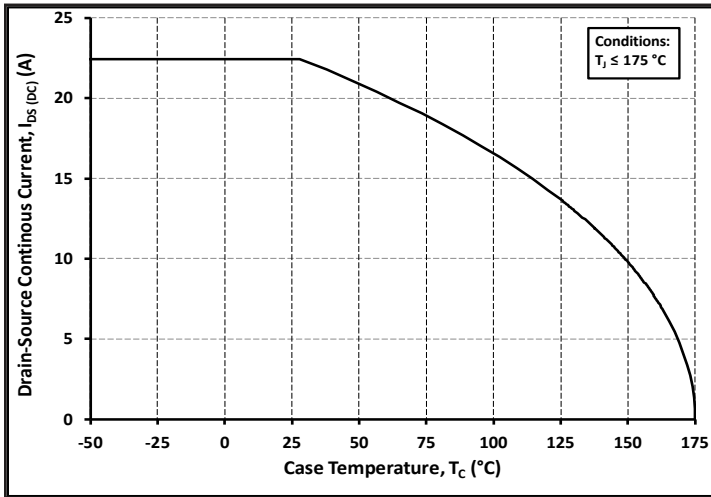

Figure 19. Continuous Drain Current Derating vs. Case Temperature

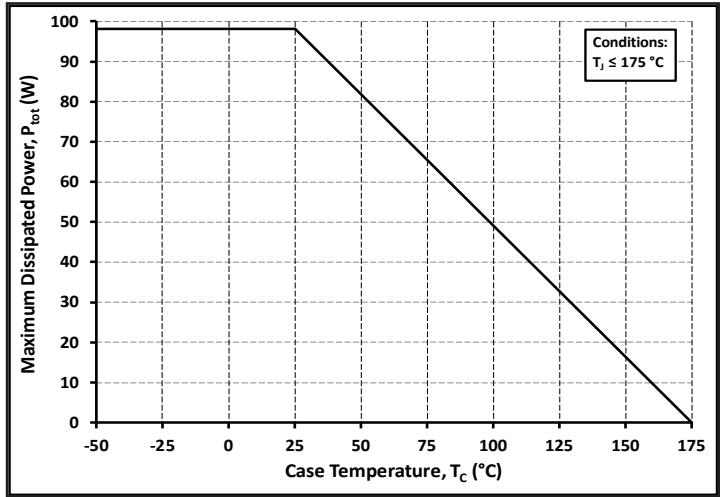

Figure 20. Maximum Power Dissipation Derating vs. Case Temperature

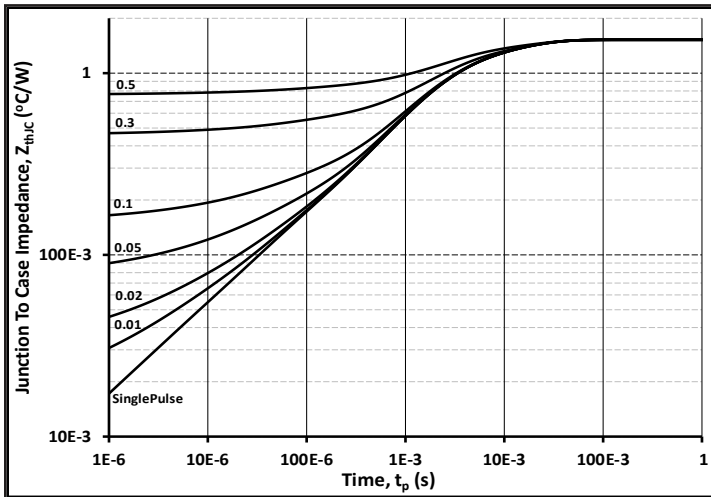

Figure 21. Transient Thermal Impedance (Junction - Case)

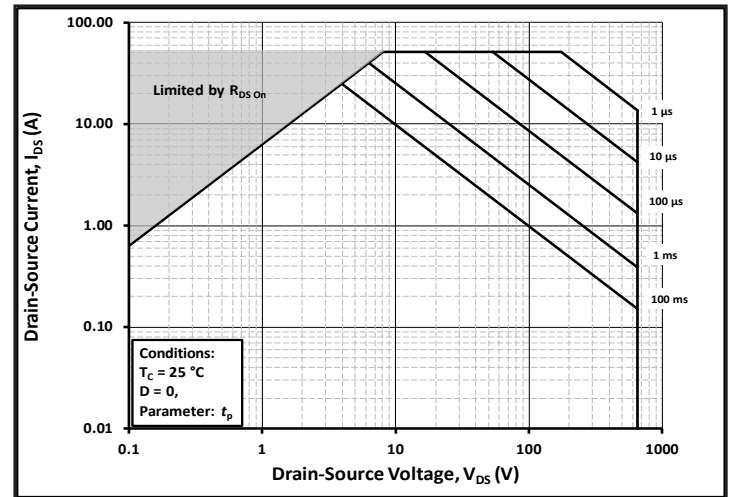

Figure 22. Safe Operating Area

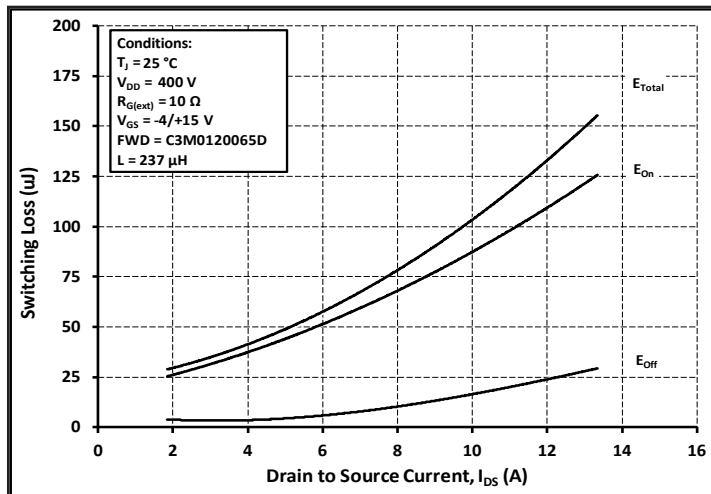

Figure 23. Clamped Inductive Switching Energy vs. Drain Current ($V_{DD} = 400V$)

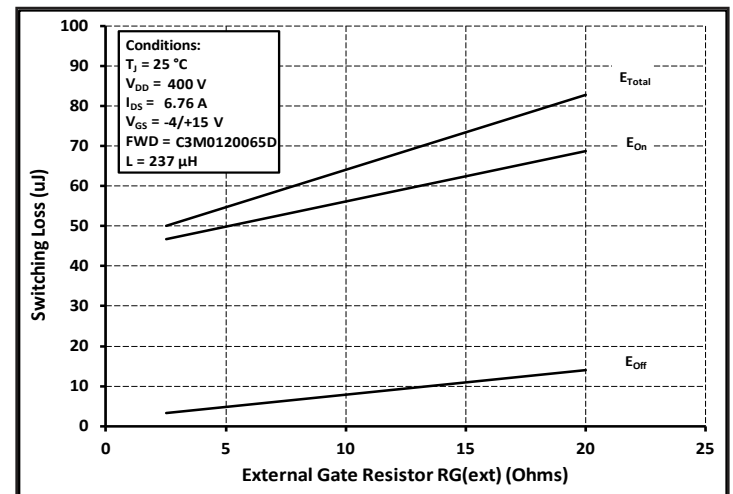

Figure 24. Clamped Inductive Switching Energy vs. $R_{G(ext)}$

Typical Performance

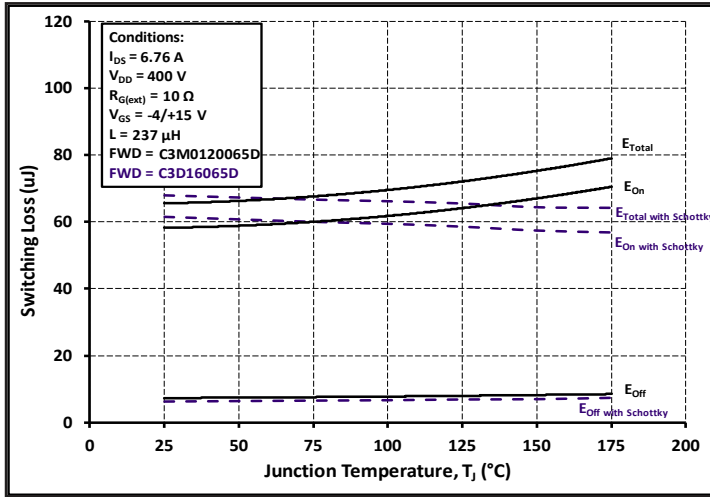

Figure 25. Clamped Inductive Switching Energy vs. Temperature

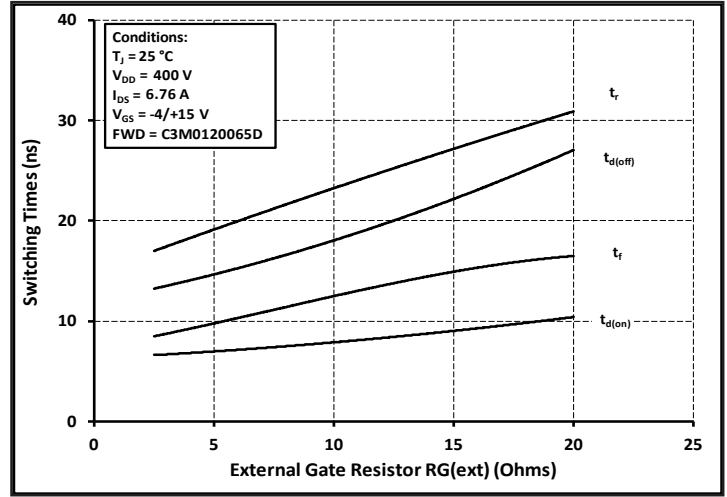

Figure 26. Switching Times vs. $R_{G(ext)}$

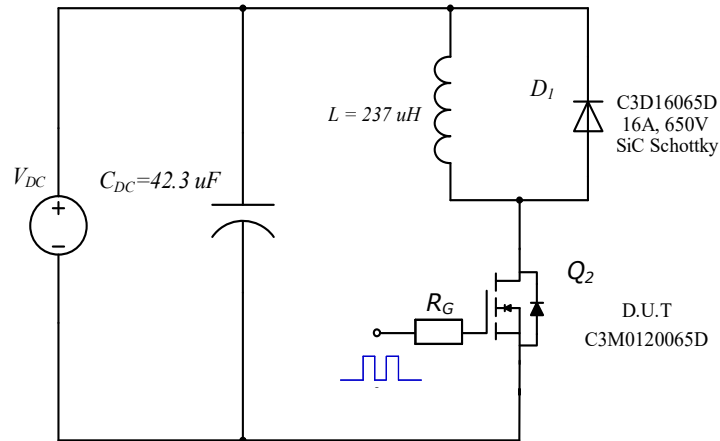

Figure 27. Clamped Inductive Switching Waveform Test Circuit

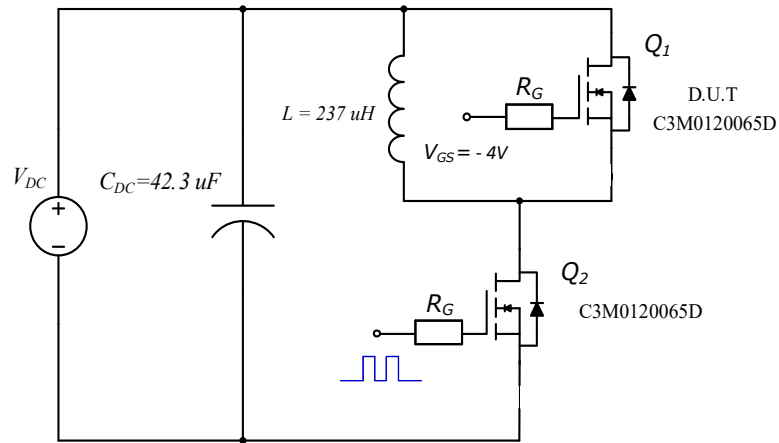

Figure 28. Body Diode Recovery Test Circuit

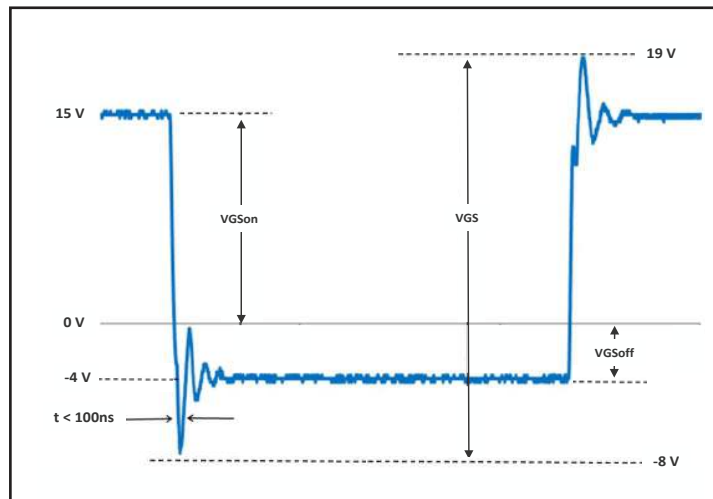
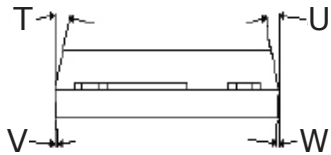
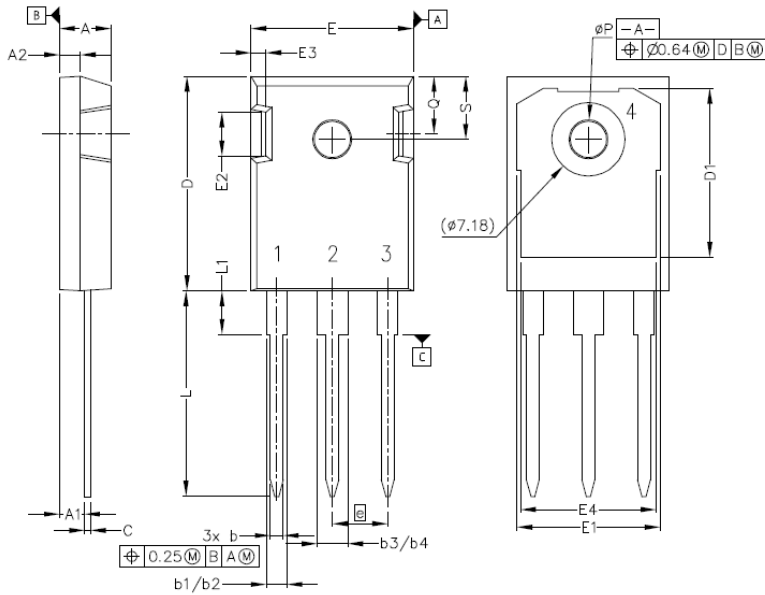

Figure 29. V_{GS} Waveform Example

Package Dimensions

Package TO-247-3



Pinout Information:

- Pin 1 = Gate
- Pin 2, 4 = Drain
- Pin 3 = Source

POS	Inches		Millimeters	
	Min	Max	Min	Max
A	.190	.205	4.83	5.21
A1	.090	.100	2.29	2.54
A2	.075	.085	1.91	2.16
b	.042	.052	1.07	1.33
b1	.075	.095	1.91	2.41
b2	.075	.085	1.91	2.16
b3	.113	.133	2.87	3.38
b4	.113	.123	2.87	3.13
c	.022	.027	0.55	0.68
D	.819	.831	20.80	21.10
D1	.640	.695	16.25	17.65
D2	.037	.049	0.95	1.25
E	.620	.635	15.75	16.13
E1	.516	.557	13.10	14.15
E2	.145	.201	3.68	5.10
E3	.039	.075	1.00	1.90
E4	.487	.529	12.38	13.43
e	.214 BSC		5.44 BSC	
N	3		3	
L	.780	.800	19.81	20.32
L1	.161	.173	4.10	4.40
ØP	.138	.144	3.51	3.65
Q	.216	.236	5.49	6.00
S	.238	.248	6.04	6.30
T	9°	11°	9°	11°
U	9°	11°	9°	11°
V	2°	8°	2°	8°
W	2°	8°	2°	8°

Recommended Solder Pad Layout

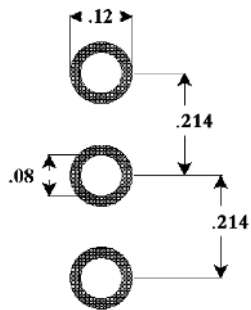

TO-247-3

Notes

- **RoHS Compliance**
The levels of RoHS restricted materials in this product are below the maximum concentration values (also referred to as the threshold limits) permitted for such substances, or are used in an exempted application, in accordance with EU Directive 2011/65/EC (RoHS2), as implemented January 2, 2013. RoHS Declarations for this product can be obtained from your Cree representative or from the Product Documentation sections of www.cree.com.
- **REACH Compliance**
REACH substances of high concern (SVHCs) information is available for this product. Since the European Chemical Agency (ECHA) has published notice of their intent to frequently revise the SVHC listing for the foreseeable future, please contact a Cree representative to insure you get the most up-to-date REACH SVHC Declaration. REACH banned substance information (REACH Article 67) is also available upon request.
- This product has not been designed or tested for use in, and is not intended for use in, applications implanted into the human body nor in applications in which failure of the product could lead to death, personal injury or property damage, including but not limited to equipment used in the operation of nuclear facilities, life-support machines, cardiac defibrillators or similar emergency medical equipment, aircraft navigation or communication or control systems, air traffic control systems.

Related Links

- **SPIICE Models:** <http://wolfspeed.com/power/tools-and-support>
- **SiC MOSFET Isolated Gate Driver reference design:** <http://wolfspeed.com/power/tools-and-support>
- **SiC MOSFET Evaluation Board:** <http://wolfspeed.com/power/tools-and-support>