



3dB 75ohm fixed attenuator BNC plug to BNC jack 4GHz rated 2 watt

RF Fixed Attenuators Technical Data Sheet

PE7438-3

Features

- DC to 4 GHz Frequency Range
- Attenuation 3 dB Typical
- Max Power 2 Watts (CW)
- VSWR < 1.35:1
- 75 Ohm Impedance

Applications

- Wireless
- Video Signal Transmission
- Radar Systems
- Test and Measurement
- Commercial and Military Communication
- Avionics

Description

Pasternack carries a wide range of fixed attenuators with a broad selection of attenuation levels, frequency ranges, and power dissipation ranges. RF microwave attenuators (also known as RF pads) lower the amplitude of a signal (attenuate) a known amount and can be used in a wide variety of applications. These attenuator pads are used when a signal needs to be reduced to protect measurement equipment or other circuitry, to extend the range of power meters and amplifiers, and to impedance match circuits by reducing the VSWR seen by adjacent components. RF attenuators can prevent signal overload in amplifiers, receivers and detectors, adjusting the signal level to a range that is optimal.

Few RF components are as commonly used as fixed coaxial attenuators, and Pasternack carries one of the largest in-stock varieties and ships them same day. The 3 dB Fixed Attenuator PE7438-3 is rated to 2 Watts and operates from DC to 4 GHz. The versatile coaxial package uses BNC male to BNC female connectors and is also REACH compliant.

Electrical Specifications

Description	Minimum	Typical	Maximum	Units
Frequency Range	DC		4	GHz
Impedance		75		Ohms
Nominal Attenuation		3		dB
Attenuation Accuracy		0.5		dB
VSWR			1.35:1	
Input Power, CW			2	Watts

Mechanical Specifications

Size

Length	2.087 in [53.01 mm]
Width/Diameter	0.571 in [14.5 mm]
Height	0.571 in [14.5 mm]
Weight	0.05 lbs [22.68 g]
Body Material and Plating	Brass, Tri-Metal

Click the following link (or enter part number in "SEARCH" on website) to obtain additional part information including price, inventory and certifications: [3dB 75ohm fixed attenuator BNC plug to BNC jack 4GHz rated 2 watt PE7438-3](#)



3dB 75ohm fixed attenuator BNC plug to
BNC jack 4GHz rated 2 watt

RF Fixed Attenuators Technical Data Sheet

PE7438-3

Configuration

Design Fixed

Connectors

Description	Connector 1	Connector 2
Type	BNC Male	BNC Female
Contact Material and Plating	Phosphor Bronze, Gold	Phosphor Bronze, Gold
Coupling Nut Material and Plating	Stainless Steel	
Body Material and Plating	Brass, Tri-Metal	Brass, Tri-Metal

Environmental Specifications

Temperature

Operating Range -55 to +125 deg C

Compliance Certifications (see [product page](#) for current document)

Plotted and Other Data

Notes:

3dB 75ohm fixed attenuator BNC plug to BNC jack 4GHz rated 2 watt from Pasternack Enterprises has same day shipment for domestic and International orders. Our RF, microwave and millimeter wave products maintain a 99.4% availability and are part of the broadest selection in the industry.

Click the following link (or enter part number in "SEARCH" on website) to obtain additional part information including price, inventory and certifications: [3dB 75ohm fixed attenuator BNC plug to BNC jack 4GHz rated 2 watt PE7438-3](#)

URL: <https://www.pasternack.com/3db-fixed-bnc-male-bnc-female-2-watts-attenuator-pe7438-3-p.aspx>

PE7438-3 CAD Drawing

3dB 75ohm fixed attenuator BNC plug to BNC jack 4GHz rated 2 watt

REVISIONS			
REV.	DESCRIPTION	DATE	APPROVED
A	INITIAL RELEASE	04/05/22	S. PONG

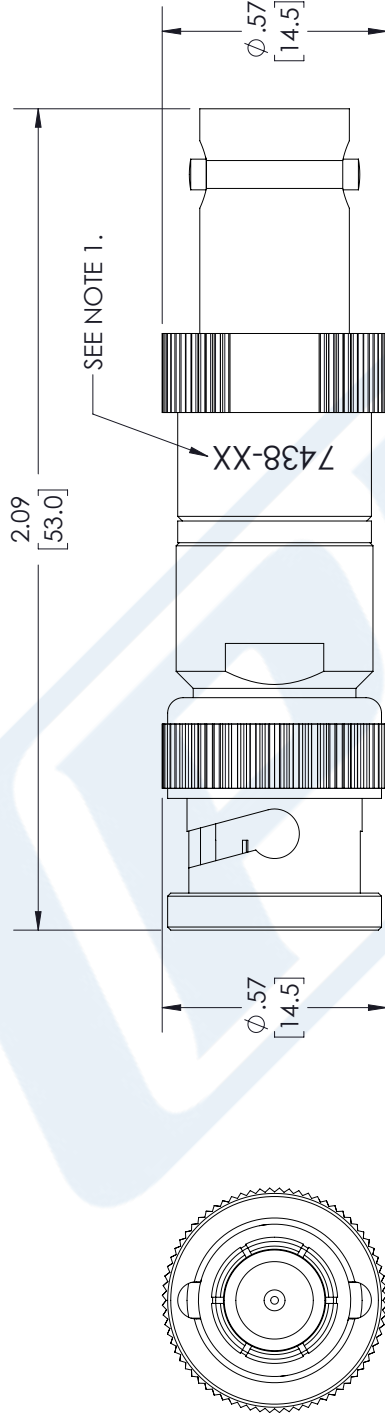

BNC PLUG

BNC JACK

NOTES:

- ITEM IS MARKED WITH PART NUMBER WHERE SHOWN.
 "-XX" DENOTES THE ATTENUATION VALUE,
 EXAMPLE: 7438-1 = 1dB, 7438-10 = 10dB, ETC.

THESE COMMODITIES, TECHNOLOGY OR SOFTWARE WERE EXPORTED FROM THE UNITED STATES IN ACCORDANCE WITH THE EXPORT ADMINISTRATION REGULATIONS. DIVERSION CONTRARY TO U.S. LAW PROHIBITED.

UNLESS OTHERWISE SPECIFIED LEADING DIMENSIONS ARE INCHES DIMENSIONS IN [] ARE MILLIMETERS

TOLERANCES:

.X = ±.2 [5.08]	FRACTIONS ± 1/32
.XX = ±.02 [.51]	ANGLES ± 1°
.XXX = ±.005 [.13]	

CABLE LENGTH (L) TOLERANCES:

L ≤ 12 [305]	±.1 [25] / -0
12 [305] < L ≤ 60 [1524]	±.2 [51] / -0
60 [1524] < L ≤ 120 [3048]	±.4 [102] / -0
120 [3048] < L ≤ 300 [7620]	±.6 [152] / -0
300 [7620] < L	±.5%L / -0

ALL DIMENSIONS SHOWN ARE FOR REFERENCE ONLY.

PE PASTERNAK
 an INFINITE brand

Pasternack Enterprises, Inc.
 P. O. Box 16759, Irvine, CA 92623.
 Phone: 1.949.261.1920 | 1.866.727.8376
 Fax: 1.949.261.7451
 Website: www.pasternack.com
 E-mail: sales@pasternack.com

ITEM NO. PE7438
 DRAWN BY AKRESOWSK
 CAGE CODE A 53919
 SCALE N/A
 SHEET 1 OF 1

THIRD-ANGLE PROJECTION

THE INFORMATION AND DESIGN IN THIS DOCUMENT IS THE PROPERTY OF PASTERNAK CORPORATION. ALL RIGHTS RESERVED.