

## POWER TRANSISTOR DRIVING BASE AMPLIFIER BUILT-IN TYPE OPTOCOUPLER

**PS9634  
PS9634L**

### FEATURES

- **HIGH INSTANTANEOUS COMMON MODE REJECTION VOLTAGE**  
CMH = -1000 V/μs MIN, CML = 1000 V/μs MIN
- **HIGH POWER SUPPLY VOLTAGE (Vcc)**  
Vcc = 18 V
- **HIGH RESPONSE SPEED**  
tPHL, tPLH = 5 μs MAX
- **HIGH OUTPUT CURRENT**  
Io1 = 0.5 A (DC), 1.0 A (pulse) MAX
- **CAN BE SOLDERED BY INFRARED REFLOW SOLDERING**

### DESCRIPTION

The PS9634 is an optical linkage device mounting a GaAs infrared LED on the light emitting side (input side), and a photodiode and a signal processing circuit on the light receiving side (output side) on one chip. The device can directly drive a power transistor of 15 A to 20 A class and may be used for an inverter control air conditioner or general purpose inverter. The PS9634L has formed leads for surface mounting.



ESD SENSITIVE

### ELECTRICAL CHARACTERISTICS (TA = -20 °C to +80 °C, unless otherwise specified)

PART NUMBER			PS9634, PS9634L		
SYMBOLS	PARAMETERS	UNITS	MIN	TYP	MAX
Input Characteristic	V <sub>F</sub>	Forward Voltage, I <sub>F</sub> = 5 mA, T <sub>A</sub> = 25 °C	V	1.1	1.4
	I <sub>R</sub>	Reverse Current, V <sub>R</sub> = 5 V, T <sub>A</sub> = 25 °C	μA		5
	C <sub>t</sub>	Capacitance Between Terminals V = 0, f = 1.0 MHz, T <sub>A</sub> = 25 °C	pF	30	
Output Characteristics	V <sub>cc</sub>	Supply Voltage	V	5.4	15
	V <sub>O1L</sub> *	Low Level Output Voltage (O1) V <sub>cc</sub> = 6 V, I <sub>O1</sub> = 0.4 A, R <sub>L2</sub> = 10 Ω, I <sub>F</sub> = 5 mA	V	0.25	0.4
	V <sub>O2H</sub> *	High Level Output Voltage (O2) V <sub>cc</sub> = 6 V, I <sub>O2</sub> = -0.4 A, I <sub>F</sub> = 5 mA	V	4.5	5.0
	V <sub>O2L</sub>	Low Level Output Voltage (O2) V <sub>cc</sub> = 6 V, I <sub>O2</sub> = 0.5 A, I <sub>F</sub> = 0	V	0.25	0.4
	I <sub>O1L</sub> *	Leak Current (O1), V <sub>cc</sub> = 13 V, I <sub>F</sub> = 0	μA		100
	I <sub>O2L</sub>	Leak Current (O2), V <sub>cc</sub> = 13 V, I <sub>F</sub> = 5 mA	μA		100
	I <sub>CC</sub> H	High Level Supply Current V <sub>cc</sub> = 6 V, I <sub>F</sub> = 5 mA, T <sub>A</sub> = 25 °C V <sub>cc</sub> = 6 V, I <sub>F</sub> = 5 mA	mA	8	12
			mA		16
	I <sub>CC</sub> L	Low Level Supply Current V <sub>cc</sub> = 6 V, I <sub>F</sub> = 0, T <sub>A</sub> = 25 °C V <sub>cc</sub> = 6 V, I <sub>F</sub> = 0	mA	15	18
mA				22	
I <sub>FLH</sub> *	Input ON Current, Low ♦ High V <sub>cc</sub> = 6 V, R <sub>L1</sub> = 5 Ω, R <sub>L2</sub> = 10 Ω, T <sub>A</sub> = 25 °C V <sub>cc</sub> = 6 V, R <sub>L1</sub> = 5 Ω, R <sub>L2</sub> = 10 Ω	mA	0.3	1.5	
		mA	0.2	5.0	
R <sub>I-O</sub>	Insulation Resistance, R <sub>H</sub> = 40% to 60%, T <sub>A</sub> = 25 °C	Ω	10 <sup>11</sup>		
t <sub>PLH</sub> *	Propagation Delay Time, Low ♦ High V <sub>cc</sub> = 6 V, I <sub>F</sub> = 5 mA, R <sub>L1</sub> = 5 Ω, R <sub>L2</sub> = 10 Ω, T <sub>A</sub> = 25 °C	μs	3	5	
t <sub>PHL</sub> *	Propagation Delay Time, High ♦ Low V <sub>cc</sub> = 6 V, I <sub>F</sub> = 5 mA, R <sub>L1</sub> = 5 Ω, R <sub>L2</sub> = 10 Ω, T <sub>A</sub> = 25 °C	μs	3	5	
CMH*	Instantaneous Common Mode Rejection Voltage (Output "High"), T <sub>A</sub> = 25°C, V <sub>CM</sub> = 600 V (peak), I <sub>F</sub> = 5 mA R <sub>L1</sub> = 470 Ω, R <sub>L2</sub> = 1 kΩ, ΔV <sub>O2H</sub> = 0.5 V	V/μs	-1000		
CML*	Instantaneous Common Mode Rejection Voltage (Output "Low"), T <sub>A</sub> = 25°C, V <sub>CM</sub> = 600 V (peak), I <sub>F</sub> = 0 mA R <sub>L1</sub> = 470 Ω, R <sub>L2</sub> = 1 kΩ, ΔV <sub>O2L</sub> = 0.5 V	V/μs	1000		

\*Note: See Figures 1-7 for test schematic.

**ABSOLUTE MAXIMUM RATINGS<sup>1</sup>** (T<sub>A</sub> = 25°C)

SYMBOLS	PARAMETERS	UNITS	RATINGS
Input			
V <sub>R</sub>	Reverse Voltage	V	6
I <sub>F</sub> /I <sub>FM</sub>	Forward Current <sup>2</sup>	mA/A	30/1
Output			
V <sub>CC</sub>	Power Voltage	V	18
I <sub>O1</sub>	Output Current (O1)	A	0.5
I <sub>O1P</sub>	Peak Output Current (O1)	A	1.0
I <sub>O2</sub>	Output Current (O2)	A	0.8
I <sub>O2P</sub>	Peak Output Current (O2)	A	2.0
V <sub>O1</sub>	Output Voltage (O1)	V	18
P <sub>O</sub>	Power Dissipation	mW	500
P <sub>T</sub>	Total Power Dissipation	mW	550
BV	Insulation Withstand Voltage <sup>3</sup>	V <sub>r.m.s.</sub>	5000
T <sub>OP</sub>	Operating Temperature	°C	-20 to +80
T <sub>STG</sub>	Storage Temperature	°C	-55 to +150

Notes:

1. Operation in excess of any one of these parameters may result in permanent damage.
2. Peak forward current I<sub>FM</sub>: Pulse width = 100 μs; Duty Ratio = 1%.
3. When all input pins are connected to all output pins at T<sub>A</sub> = 25 °C and RH = 60 %.

**RECOMMENDED OPERATING CONDITIONS** (T<sub>A</sub> = 25°C)

PART NUMBER			PS9634, PS9634L		
SYMBOLS	PARAMETERS	UNITS	MIN	TYP	MAX
I <sub>FLH</sub>	Input ON Current	mA	6	8	10
V <sub>CC</sub>	Supply Voltage	V	5.4		15
I <sub>O1</sub>	Output Current (O1)	A	0.1	0.2	0.3
I <sub>O2</sub>	Output Current (O2)	A	0.1	0.2	0.3
T <sub>OP</sub>	Operating Temperature	°C	0	25	50

**TRUTH TABLE**

	LED	
	ON	OFF
Tr. 1	ON	OFF
Tr. 2	OFF	ON

**OUTLINE DIMENSIONS** (Units in mm)

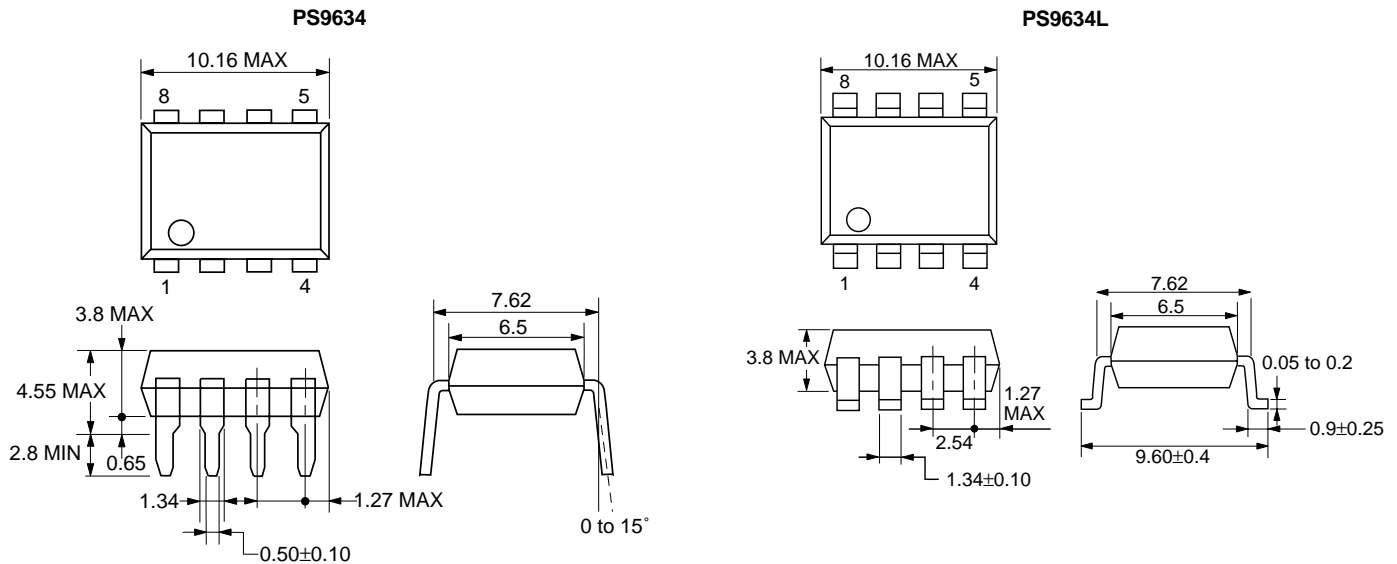

**PIN CONNECTION** (Top View)

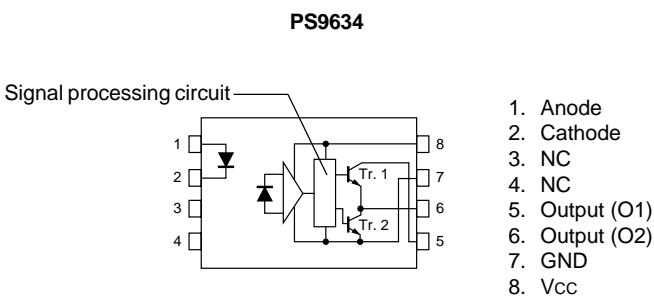

MEASUREMENT CIRCUITS FOR ELECTRICAL CHARACTERISTICS

FIG. 1 (Vo1L)

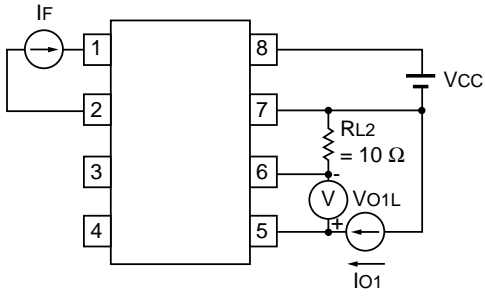

FIG. 2 (Vo2H)

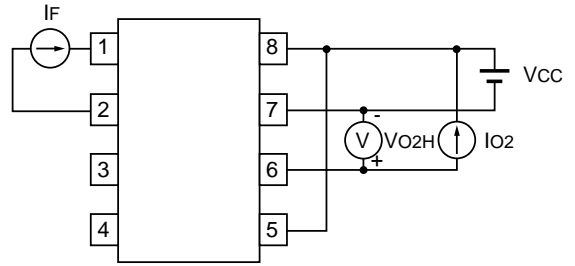

FIG. 3 (Io1L)

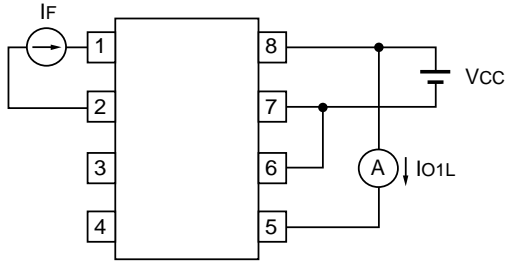

FIG. 4 (Io2L)

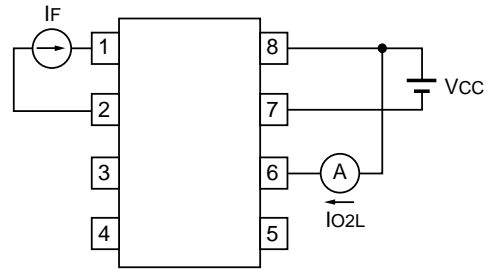

FIG. 5 (IFLH)

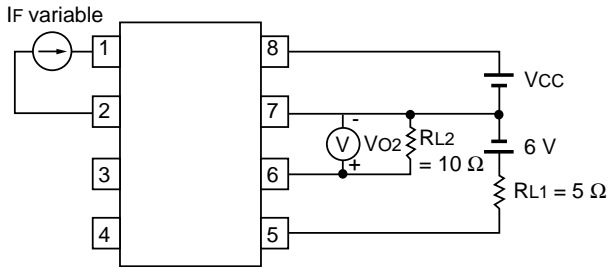

FIG. 6 (tPLH, tPHL)

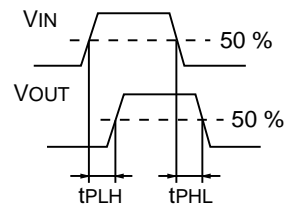
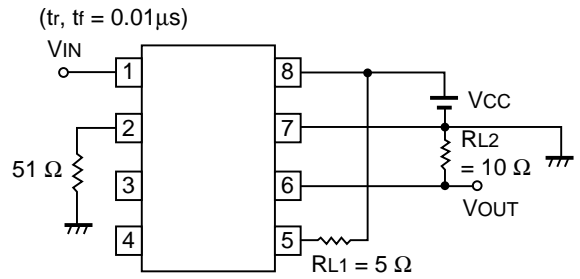
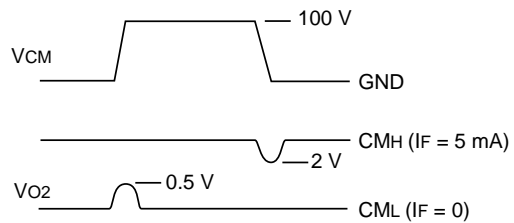
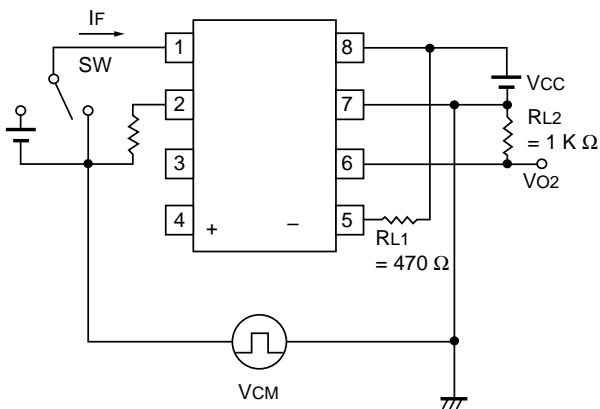
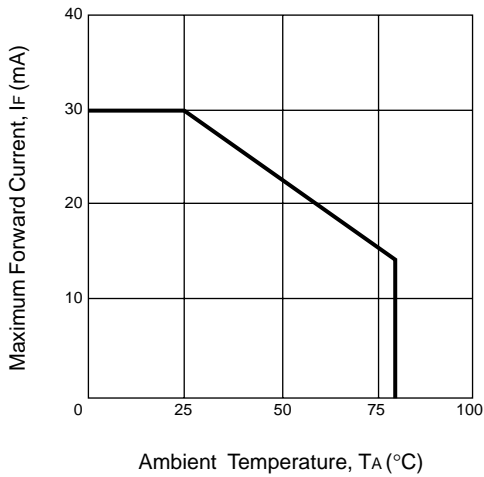

FIG. 7 (CMH, CML)



**TYPICAL PERFORMANCE CURVES** ( $T_A = 25\text{ }^\circ\text{C}$ )

**MAXIMUM FORWARD CURRENT vs. AMBIENT TEMPERATURE**



**POWER DISSIPATION vs. AMBIENT TEMPERATURE**

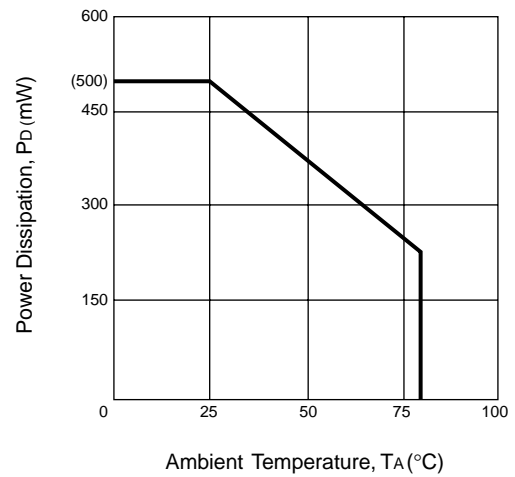

**TOTAL POWER DISSIPATION vs. AMBIENT TEMPERATURE**

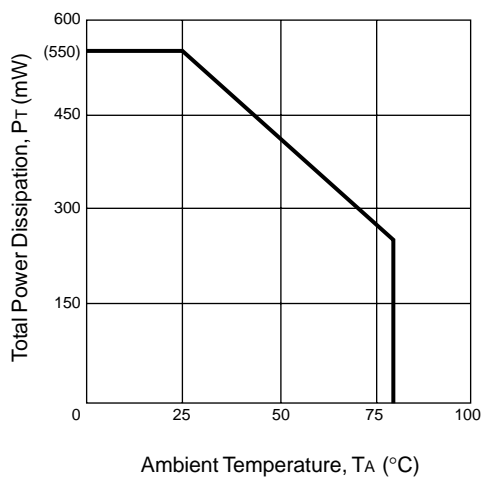

**FORWARD CURRENT vs. FORWARD VOLTAGE**

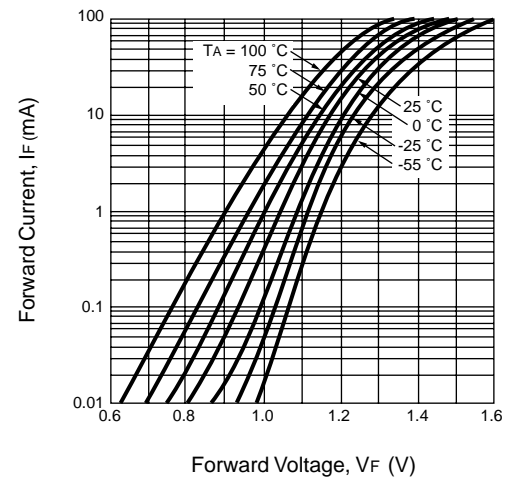

**NORMALIZED  $I_{FLH}$  vs. SUPPLY VOLTAGE**

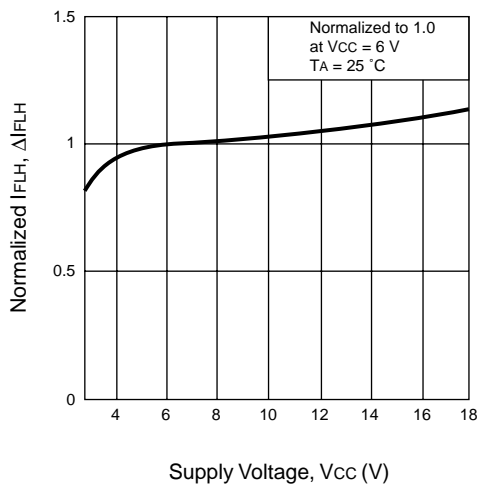

**NORMALIZED  $I_{FLH}$  vs. AMBIENT TEMPERATURE**

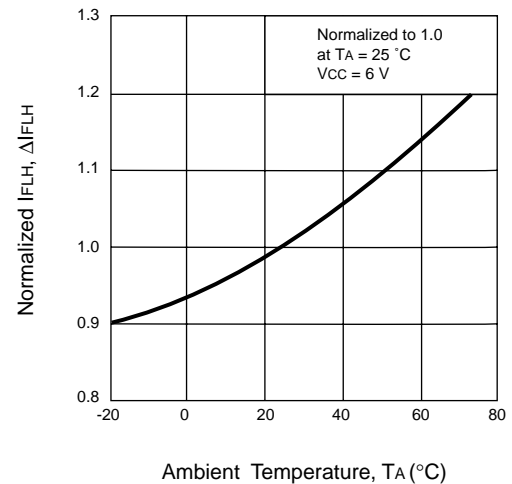

TYPICAL PERFORMANCE CURVES (T<sub>A</sub> = 25 °C)

HIGH LEVEL SUPPLY CURRENT vs. SUPPLY VOLTAGE

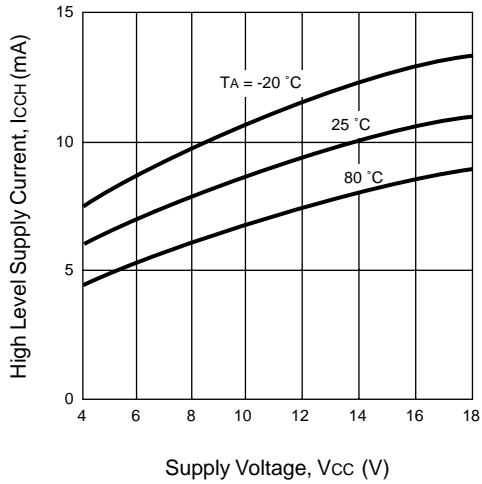

LOW LEVEL SUPPLY CURRENT vs. SUPPLY VOLTAGE

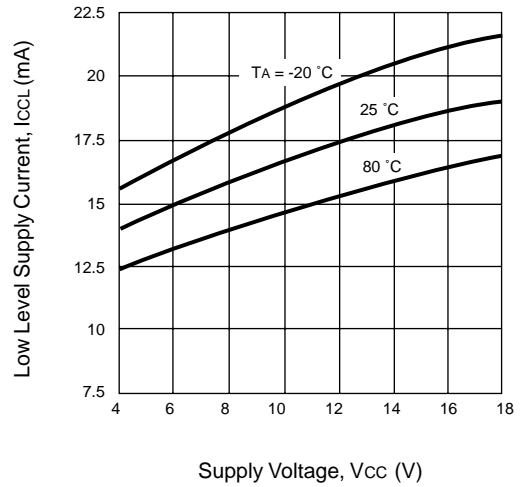

LOW LEVEL OUTPUT VOLTAGE vs. OUTPUT CURRENT

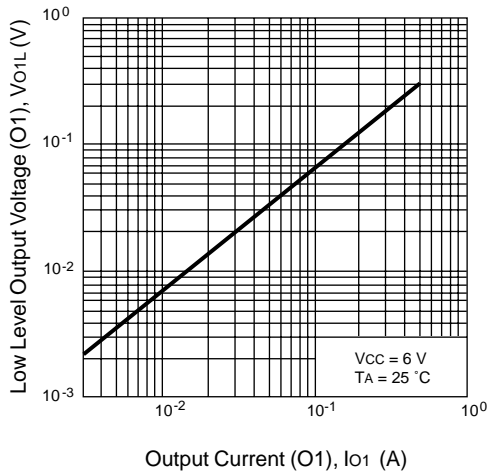

LOW LEVEL OUTPUT VOLTAGE vs. AMBIENT TEMPERATURE

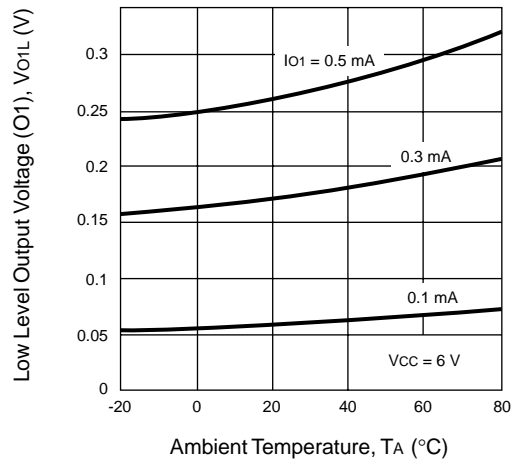

LOW LEVEL OUTPUT VOLTAGE vs. OUTPUT CURRENT

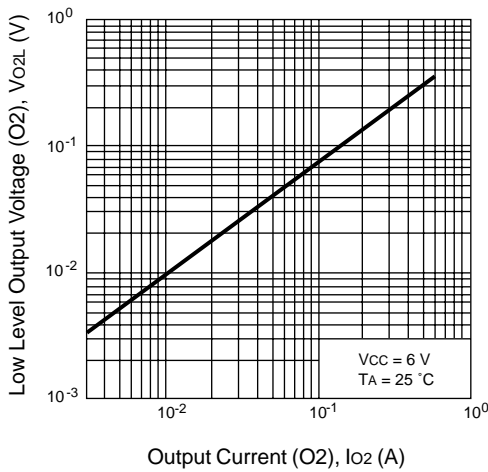

LOW LEVEL OUTPUT VOLTAGE vs. AMBIENT TEMPERATURE

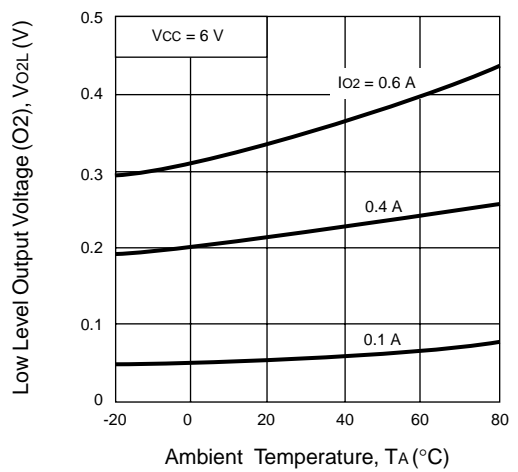

**TYPICAL PERFORMANCE CURVES** ( $T_A = 25\text{ }^\circ\text{C}$ )

**HIGH LEVEL OUTPUT VOLTAGE vs. OUTPUT CURRENT**

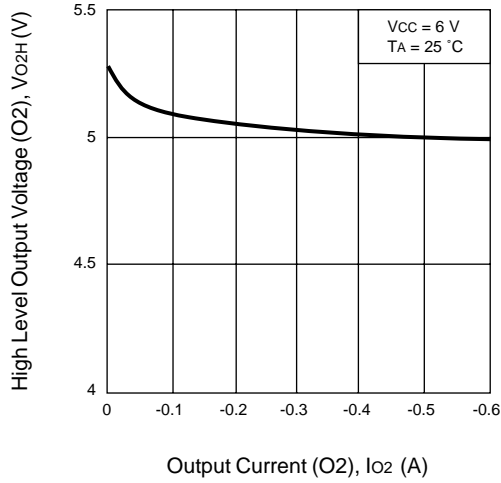

**HIGH LEVEL OUTPUT VOLTAGE vs. AMBIENT TEMPERATURE**

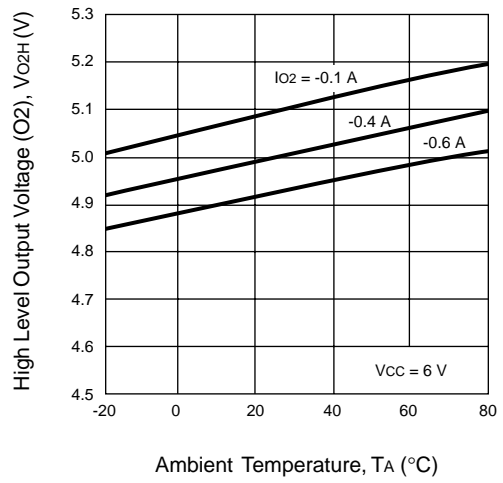

**PROPAGATION DELAY TIME vs. FORWARD CURRENT**

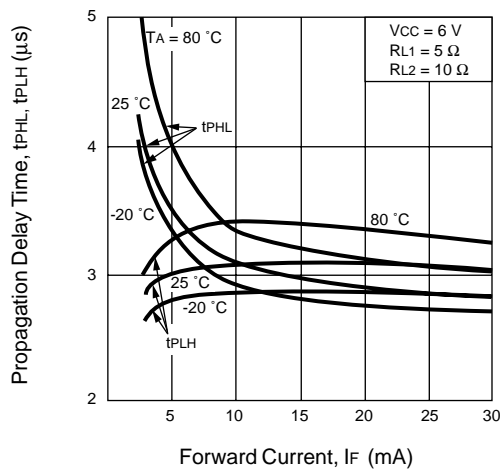

**PROPAGATION DELAY TIME vs. AMBIENT TEMPERATURE**

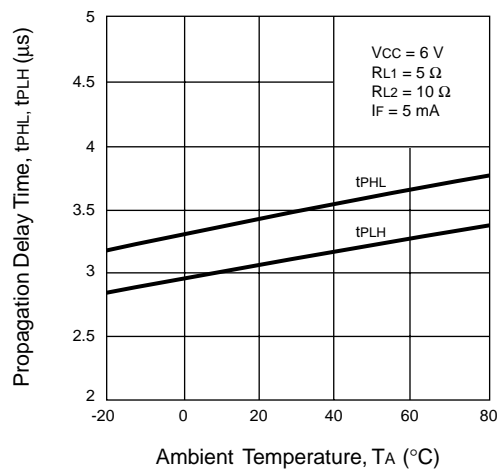

**SAFE OPERATING AREA (T<sub>r1</sub>)**

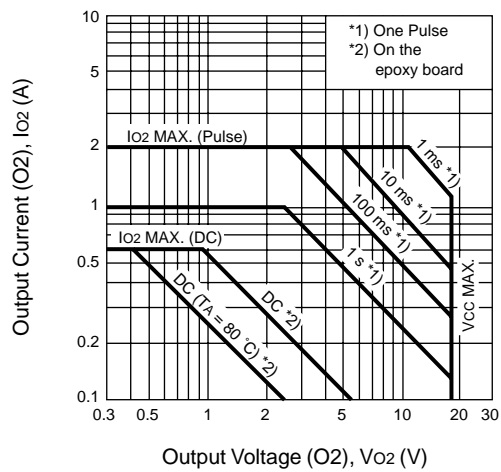

**TAPING SPECIFICATIONS** (Units in mm)

**Tape Outline and Dimensions**

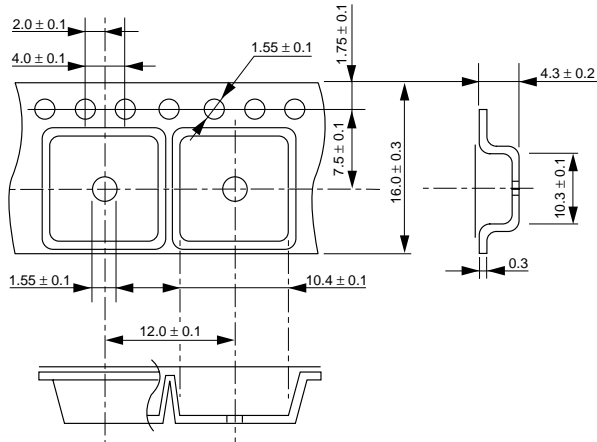

**Tape Direction**

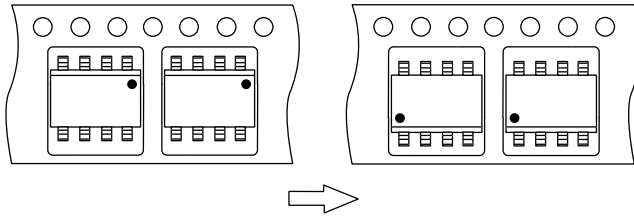

**Reel Outline and Dimensions**

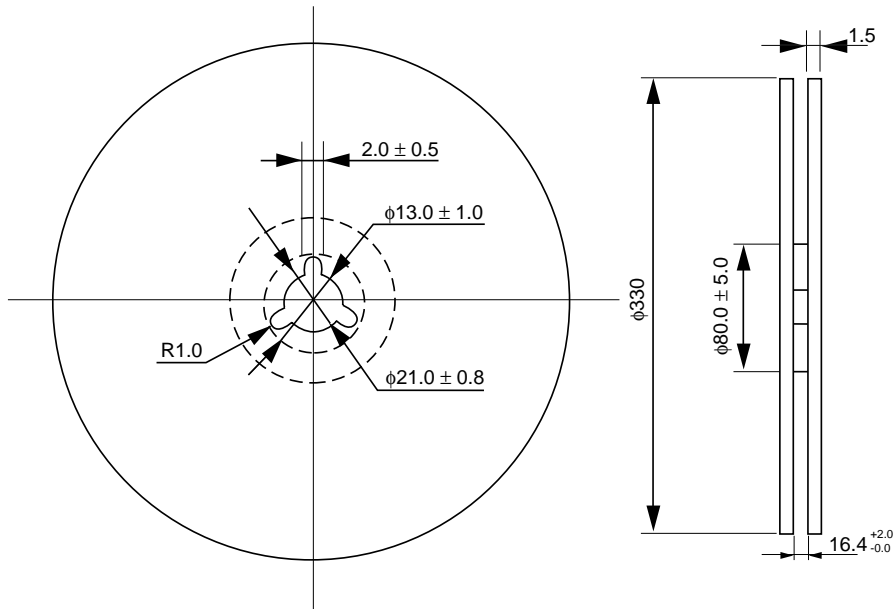

## RECOMMENDED SOLDERING CONDITIONS

### (1) Infrared reflow soldering

- Peak reflow temperature 235 °C or below (plastic surface)
- Time of temperature higher than 210 °C 30 seconds or less
- Number of reflows Three
- Flux Rosin flux containing a small amount of chlorine (The flux with a maximum chlorine content of 0.2 Wt % is recommended.)

Recommended Temperature Profile of Infrared Reflow

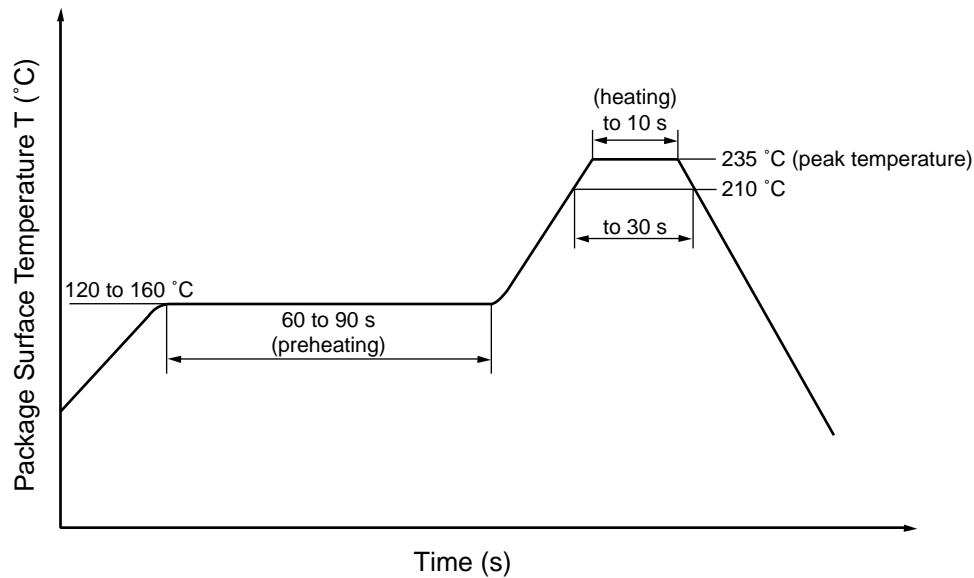

**CAUTION:** Avoid removing the residual flux with water after the first reflow process.

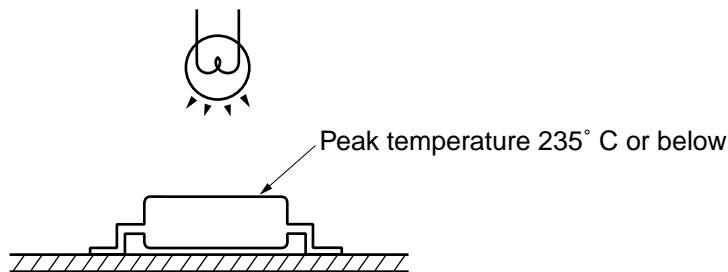

### (2) Dip soldering

- Temperature 260 °C or below (molten solder temperature)
- Time 10 seconds or less
- Number of times One
- Flux Rosin flux containing a small amount of chlorine (The flux with a maximum chlorine content of 0.2 Wt % is recommended.)

EXCLUSIVE NORTH AMERICAN AGENT FOR **NEC** RF, MICROWAVE & OPTOELECTRONIC SEMICONDUCTORS

**CEL** CALIFORNIA EASTERN LABORATORIES • Headquarters • 4590 Patrick Henry Drive • Santa Clara, CA 95054-1817 • (408) 988-3500 • Telex 34-6393 • FAX (408) 988-0279  
24-Hour Fax-On-Demand: 800-390-3232 (U.S. and Canada only) • Internet: <http://WWW.CEL.COM>

DATA SUBJECT TO CHANGE WITHOUT NOTICE

12/04/2001