

D52 ANT SoC Module Series



D52Q Models



D52M Models

Artwork not exactly as shown

Module Hardware

- Integrated printed antenna
- On-board 32MHz and 32.768 kHz crystal clocks
- 1.7V - 3.6V supply (D52QD2M4IA, D52MD2M8IA, D52QPMM4IA, D52MPMM8IA)
- 1.71V - 3.6V supply (D52QD2M4IA-A, D52QPMM4IA-A)
- Operating temperature: Industrial (-40°C to +85°C)
- Up to 30 GPIOs (D52QD2M4IA, D52QPMM4IA)
- Up to 24 GPIOs (D52QD2M4IA-A, D52MD2M8IA, D52QPMM4IA-A, D52MPMM8IA)
- Programmable output/channel from -20dBm to 4dBm
- Excellent receiver sensitivity
 - 93dBm (ANT mode)
 - 96dBm (BLE mode)
- 1dBm resolution RSSI
- Total 512kB flash, 64kB RAM
- SPI, I2C and UART interface
- ARM SWD interface
- Internal DC/DC converter supported
- 20 x 20mm module (D52Q models, M4 format)
- 14 x 9.8 x 2.0mm module (D52M models, M8 format)
- Onboard 3-axis MEMS accelerometer (D52QD2M4IA-A, D52QPMM4IA-A)
 - LIS2DH by ST Microelectronics
 - 2 programmable interrupt pins
- Layout compatible options with N5150M4CD, N550M4CC, N548M4CB, ANTAP281M4IB, ANTC782M4IB (for D52Q models)¹
- Layout compatible options with N5150M8CD, N550M8CC, N548M8CB (for D52M models)¹
- Radio regulatory approval for major markets
- BLUETOOTH SIG qualification
- RoHS compliant

Series Members:

- D52QD2M4IA, D52QD2M4IA-A (NRND), D52MD2M8IA, D52QD2M6IA-A (NRND), D52QPMM4IA (NRND), D52QPMM4IA-A (NRND), D52MPMM8IA (NRND), D52QSKM6IA-A (NRND)

All models are preloaded with ANT Network Processor application.

ANT® Operation (using the latest s212 or s332 SoftDevice)

- 79 selectable RF channels (2402 to 2480 MHz)
- Flexible network topologies: peer-to-peer, star, tree, high node count, mesh and more
- Broadcast, acknowledged, and burst data communication modes
- Built-in device search and pairing
- Built-in interference handling and radio coexistence management with application radio disable requests and application flash write/erase requests
- Enhanced ANT features:
 - Supports up to 15 logical channels each with configurable channel periods (5.2ms - 2s)
 - Advanced burst data transfer modes (up to 60kbps)
 - Optional channel encryption mode (aes-128)
 - Supports up to 8 public, private and/or managed networks
 - Advanced power management features to optimize application power consumption including Event Filtering and Selective Data Updates
 - Asynchronous transmit channel
 - Fast channel initiation
 - High duty search

Bluetooth® low energy operation (when loaded with the latest S132 or S332 SoftDevice)

- Bluetooth 5.3 compliant low energy protocol stack suitable for Bluetooth low energy products
 - Concurrent Central, Observer, Peripheral, and Advertiser roles with:
 - Multiple connections as a Central or Peripheral
 - Observer
 - Advertiser
 - Bluetooth Mesh
 - GATT and GAP APIs

¹ In certain configurations; see section 2.3 - Pin-outs – for complete details

Table of Contents

D52 ANT SoC Module Series.....	1
Table of Figures.....	4
List of Tables.....	5
Notices and Restricted Use Information.....	6
One Year Limited Warranty.....	7
1 D52 ANT SoC Module Series Overview.....	8
1.1 Nomenclature.....	9
1.2 Production Tracking Code.....	9
1.3 Models.....	10
1.4 D52 ANT SoC Module Starter Kit and Components.....	11
1.5 D52 ANT SoC Module Extender Kit and Components.....	12
2 Product Overview.....	13
2.1 D52Q Model Block Diagram.....	13
2.2 D52M Model Block Diagram.....	14
2.3 Pin-outs.....	14
2.3.1 (Optional) Accelerometer Specification.....	18
2.4 Preloaded Software.....	18
2.5 D52 Module Programming.....	19
2.5.1 Programming via SWD Interface.....	19
2.5.2 Initializing the SoftDevice.....	19
2.5.3 Configuring the DC/DC converter.....	19
2.6 Design Considerations.....	19
2.6.1 D52Q M6 module mounting.....	19
2.6.2 D52Q M4 Module Mounting.....	19
2.6.3 D52M M8 Module Mounting.....	22
2.7 Assembly Considerations.....	23
2.7.1 Moisture Control.....	23
2.7.2 D52Q M4 Module Solder Stencil.....	24
2.7.3 D52M M8 Module Solder Stencil.....	24
2.7.4 Cleaning Process.....	24
3 Regulatory Approvals and Compliance.....	25
3.1 United States.....	25
3.2 Canada.....	25
3.3 European Economic Area and Great Britain.....	26
3.4 Australia and New Zealand.....	27

3.5	Japan	27
3.6	Korea	27
3.7	Brazil	27
3.8	BLUETOOTH Qualification	28
4	Licensing & Conditions of Use.....	29
4.1	Conditions of Use.....	29
4.2	SoftDevice Licensing	29
5	Electrical Specifications	30
5.1	Recommended Operating Conditions.....	30
5.2	Absolute Maximum Ratings	30
5.3	Electrical Specifications.....	30
5.4	Radio Operation Specifications	30
6	Mechanical Drawings.....	33
7	Support	35
7.1	ANT Forum	35
7.2	Technical References	35
7.3	ANT Developer’s Zone	36
7.4	ANT and ANT+ Social Media	37
	Appendix A – Using the ANT Network Processor Configuration.....	38
	Pin Assignments in the ANT Network Processor Configuration.....	38
	Asynchronous Serial Mode	39
	Byte Synchronous Serial Mode.....	41
	DC/DC Configuration	42
	Appendix B – D52 Module Series Pre-Loaded Software Versions	42

Table of Figures

Figure 1: D52 Module Series Nomenclature	9
Figure 2: Production Tracking Code for D52M (left) and D52Q (right) modules	9
Figure 3: D52QD2M4IA-A, D52QPMM4IA-A Models (with accelerometer) Module Block Diagram	13
Figure 4: D52QD2M4IA, D52QPMM4IA Models (no accelerometer) Module Block Diagram	13
Figure 5: D52MD2M8IA, D52MPMM8IA Models Module Block Diagram.....	14
Figure 6: D52Q M4 (20mm x 20mm) Bottom View	15
Figure 7: D52M M8 (14.0mm x 9.8mm) Bottom View	15
Figure 8: D52Q M6 (Development Module) - Top View.....	16
Figure 9: D52Q M6 (Development Module) - Bottom View.....	16
Figure 10: Memory Map of the Preloaded Software	18
Figure 11: D52Q signal pads, component outline and keepout areas	20
Figure 12: D52Q Module Mounting	21
Figure 13: D52M Module Mounting	23
Figure 14: D52M signal pads, component outline and keepout areas	23
Figure 15: D52Q M4 Solder Stencil	24
Figure 16: D52M M8 Solder Stencil	24
Figure 17: D52Q M4 Module Typical Antenna Gain (dBi)	31
Figure 18: D52M M8 Module Typical Antenna Gain (dBi)	32
Figure 19: D52Q M4 Mechanical Drawing	33
Figure 20: D52M M8 Mechanical Drawing	34
Figure 21: Using ANT Network Processor	38
Figure 22: D52Q M4 ANT NP Configuration Async Serial Connection.....	40
Figure 23: D52Q M4 ANT NP Configuration Byte Sync Connection.....	41

List of Tables

Table 1: D52 ANT SoC Module Series Models.....	8
Table 2: D52 ANT SoC Module Series Models.....	10
Table 3: D52 ANT SoC Module Starter Kit.....	11
Table 4: D52 ANT SoC Module Extender Kit.....	12
Table 5: D52 Module Series Pin-Out	17
Table 6: Accelerometer Pin Assignment.....	18
Table 7: D52 Module Series Moisture Control Levels	23
Table 8: SoftDevice Licensing and Downloads.....	29
Table 9: Recommended Operating Conditions.....	30
Table 10: Absolute Maximum Ratings	30
Table 11: Current Consumption of Radio Operation	30
Table 12: Pin Assignments in ANT Network Processor Configuration on D52Q models.....	38
Table 13: Pin Assignments in ANT Network Processor Configuration on D52M models.....	39
Table 14: Asynchronous Serial Mode Baud Rate Select	39
Table 15: Byte-Sync Mode Speed Selection	41
Table 16: ANT DC/DC Configuration Command	42
Table 17: ANT DC/DC Configuration Response.....	42
Table 18: D52 Preloaded Software Versions.....	42

Notices and Restricted Use Information

Information contained in this document is provided only for your ("Customer" or "you") convenience and may be superseded by updates. It is your responsibility to ensure that your application meets with your specifications.

Garmin Canada Inc. ("GARMIN") makes no representations or warranties of any kind whether express or implied, written or oral, statutory or otherwise, related to the information, including but not limited to its condition, quality, performance, merchantability or fitness for purpose. GARMIN disclaims all liability arising from this information and its use.

GARMIN does not assume any responsibility for the use of the described ANT module ("the Module(s)"). GARMIN makes no representation with respect to the adequacy of the module in low-power wireless data communications applications or systems. Any Products using the Module must be designed so that a loss of communications due to radio interference or otherwise will not endanger either people or property, and will not cause the loss of valuable data. GARMIN assumes no liability for the performance of products which are designed or created using the Modules.

The Modules are not designed, intended, or authorized for use as components in systems intended for surgical implant into the body, or other applications intended to support or sustain life, or for any other application in which the failure of the Module could create a situation where personal injury or death may occur. If you use the Modules for such unintended and unauthorized applications, you do so at your own risk and you shall indemnify and hold GARMIN and its officers, employees, subsidiaries, affiliates, and distributors harmless against all claims, costs, damages, and expenses, and reasonable attorney fees arising out of, directly or indirectly, any claim of personal injury or death associated with such unintended or unauthorized use, even if such claim alleges that GARMIN was negligent regarding the design or manufacture of the Product.

D52 Modules have been designed to operate in typical operating environments² up to 30m.

The information disclosed herein is the exclusive property of GARMIN, and is not to be reproduced and/or distributed without the written consent of GARMIN. No part of this publication may be reproduced or transmitted in any form or by any means including electronic storage, reproduction, execution or transmission without the prior written consent of GARMIN. The recipient of this document by its retention and use agrees to respect the security status of the information contained herein.

GARMIN believes the information contained herein is correct and accurate at the time of its release. However, the information contained in this document is subject to change without notice and should not be construed as a commitment by GARMIN unless such commitment is expressly given in a covering document.

The D52 Series of modules have been designed to support the ANT and/or *Bluetooth*[®] low energy Protocols and are certified for use in many geographic regions around the globe. However, a product incorporating the D52 series module may carry the certification IDs of the module only if it complies with the restrictions and terms, including use of GARMIN - approved software, provided in the conditions of use available at:

https://www.thisisant.com/developer/components/d52/#879_tab

² Typical operating environment: commercial IoT use case, less than 5% message packet loss rate.

One Year Limited Warranty

This D52 Module is warranted to be free from defects in materials or workmanship for 1 year from the date of purchase by the end customer. Within this period, Garmin will, at its sole option, replace any D52 Modules that fail in normal use. Replaced D52 Modules have a 1 year warranty. Garmin retains the exclusive right to replace (with a new or newly-overhauled replacement product) the D52 Module or offer a full refund of the purchase price at its sole discretion. SUCH REMEDY SHALL BE THE SOLE AND EXCLUSIVE REMEDY FOR ANY BREACH OF WARRANTY. Such replacement will be made at no charge to LICENSEE, provided LICENSEE shall be responsible for any transportation cost. This warranty does not apply to: (i) cosmetic damage, such as scratches, nicks and dents; (ii) damage caused by accident, abuse, misuse, water, flood, fire, or other acts of nature or external causes; (iii) damage caused by service performed by anyone who is not an authorized service provider of Garmin or (iv) damage to a D52 Module that has been modified or altered without the written permission of Garmin. In addition, Garmin reserves the right to refuse warranty claims against D52 Modules used in contravention of the laws of any country.

THE WARRANTIES AND REMEDIES CONTAINED HEREIN ARE EXCLUSIVE AND IN LIEU OF ALL OTHER WARRANTIES EXPRESS, IMPLIED, OR STATUTORY, INCLUDING ANY LIABILITY ARISING UNDER ANY WARRANTY OF MERCHANTABILITY OR FITNESS FOR A PARTICULAR PURPOSE, STATUTORY OR OTHERWISE.

IN NO EVENT SHALL D GARMIN BE LIABLE FOR ANY INCIDENTAL, SPECIAL, INDIRECT, OR CONSEQUENTIAL DAMAGES, WHETHER RESULTING FROM THE USE, MISUSE, OR INABILITY TO USE THIS PRODUCT OR FROM DEFECTS IN THE PRODUCT.

To obtain warranty service, LICENSEE shall contact Garmin for shipping instructions and obtain a return material authorization (RMA) tracking number. LICENSEE shall securely pack the D52 Modules and enclose a copy of the original sales receipt, which is required as the proof of purchase for a warranty claim, and write the tracking number clearly on the outside of the package. LICENSEE agrees to send the D52 Modules, freight charges prepaid, to the Garmin address provided in the Module Distribution Agreement (see https://www.thisisant.com/developer/components/d52/#879_tab).

©2018 Garmin Canada Inc., All Rights Reserved.

1 D52 ANT SoC Module Series Overview

Garmin offers the [D52 series of ANT SoC Modules](#), based on Nordic Semiconductor's nRF52832 SoC supporting ANT, *Bluetooth*[®] low energy technology and extended features such as NFC. This expands Garmin portfolio of multi-protocol ultra-low power wireless modules, including the [N5 series](#). Features of the D52 series include:

- Nordic Semiconductor's nRF52832 chip with 64kB RAM, 512kB Flash and a 32-bit ARM Cortex M4F CPU
- Concurrent ANT and Bluetooth protocol operation using supported SoftDevices (pre-compiled protocol stack solutions for the nRF52 SoCs):
 - S212 – ANT only SoftDevice from Garmin
 - S332 – concurrent ANT and Bluetooth low energy SoftDevice from Garmin
 - S132 – Bluetooth low energy only SoftDevice from Nordic Semiconductor
- Certification of compliance with regulation standards in major markets including North America, Australia / New Zealand, Japan and Korea. Declared conformity with radio regulations and requirements for Europe³.
- Qualification by the Bluetooth SIG
- Onboard 32MHz and 32.768kHz crystal clocks
- The preloaded Network Processor application provides a standard ANT serial interface that can be connected to an existing external application controller without reprogramming the module. The application uses the S212 SoftDevice (scalable ANT protocol stack with 15 channel support).
- Easy reprogramming via the onboard SWD interface pins using off-the-shelf ARM programming tools
- D52Q models support drop-in compatibility with Garmin (Dynastream) ANTC782M4IB, ANTAP281M4IB, N5150M4CD, N550M4CC and N548M4CB modules (in certain configurations)⁴
- D52M models support drop-in compatibility with Garmin (Dynastream) N5150M8CD, N550M8CC, N548M8CB modules (in certain configurations)⁵

The D52 ANT SoC module series includes the following models, all covered in this data sheet:

Part no.	ANT Libraries Support	Description
D52QD2M4IA	SoftDevice only	20 x 20mm module with up to 30GPIOs and 8 analog inputs
D52QPMM4IA	High Node Count libraries	
D52QD2M4IA-A	SoftDevice only	20 x 20mm module with up to 24GPIOs and 5 analog inputs; onboard 3-axis MEMS accelerometer
D52QPMM4IA-A	High Node Count libraries	
D52MD2M8IA	SoftDevice only	14.0 x 9.8 x 2.0mm module with up to 24GPIOs and 8 analog inputs
D52MPMM8IA	High Node Count libraries	
D52QD2M6IA-A	SoftDevice only	A D52 M4 form factor module with accelerometer mounted on a carrier board for development use
D52QSKM6IA-A	High Node Count, G.FIT ⁶ development	

Table 1: D52 ANT SoC Module Series Models

³ Please see section 3 of this data sheet for details about leveraging D52 certification.

⁴ Layouts are compatible with D52Q when using the `reset` pin only; the nRF52832 supports separate reset and SWDIO lines rather than the single shared line from previous Nordic SoCs. See section 2.3 for more information.

⁵ Layouts are compatible with D52M when using the `SWDIO` pin only; the nRF52832 supports separate reset and SWDIO lines rather than the single shared line from previous Nordic SoCs. See section 2.3 for more information.

⁶ For more information about G.FIT Fitness Equipment Modules, visit <https://www.thisisant.com/developer/components/gfit/>

The [D52 series development kit](#) (D52DK2) contains everything necessary to evaluate and begin development with D52 series modules, with support for the Nordic nRF5 SDK. An additional extension kit (D52EXT1) is also available and is useful for high node count network exploration and development.

1.1 Nomenclature

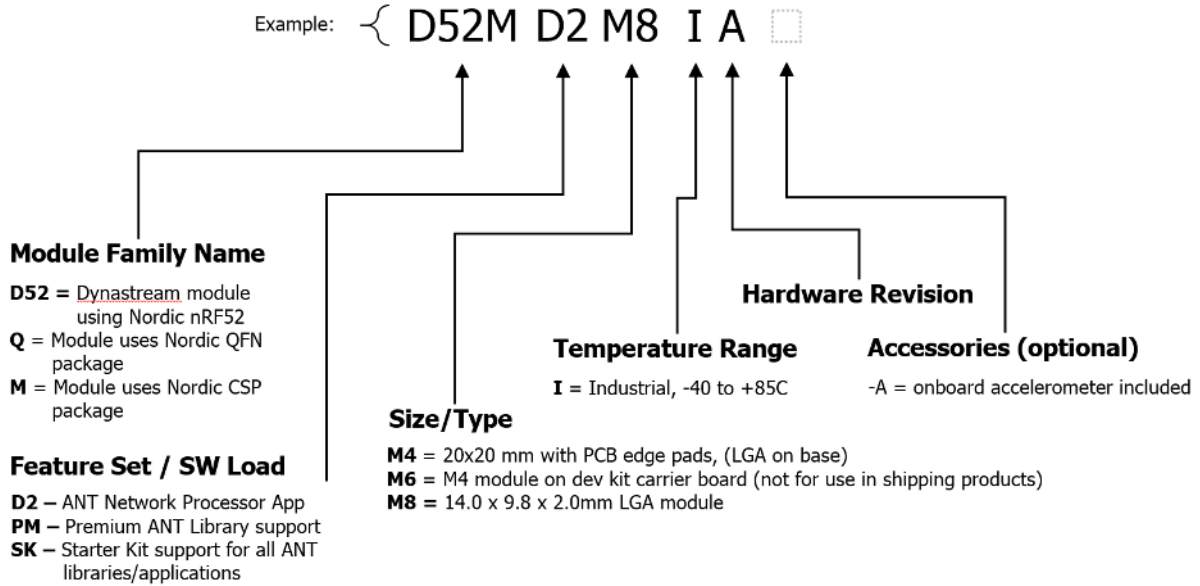

Figure 1: D52 Module Series Nomenclature

1.2 Production Tracking Code

For technical support and customer service purposes, a production code of three characters of the format “YWR” is laser marked on the RF shield as illustrated below. In the code, YW (“6V” and “6K” in Figure 2, below) denotes production date code and R (“B” and “2” in Figure 2, below) denotes module version.

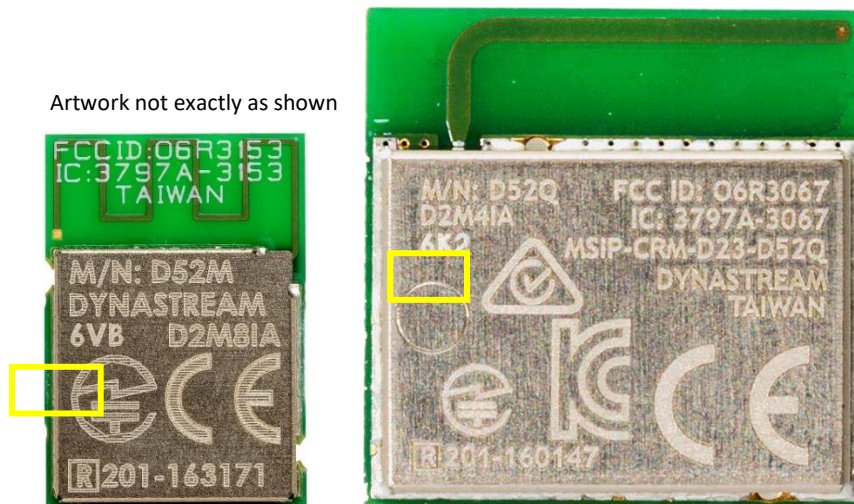

Figure 2: Production Tracking Code for D52M (left) and D52Q (right) modules

Please refer to Appendix B – D52 Module Series Pre-Loaded Software Versions for differences and important notes of each version.

1.3 Models

This section details some basic information about orderable SKUs for models in the D52 ANT SoC Module Series.



Module	Part No.	Description	Ordering/Package Information	Part Status*
	D52QD2M4IA-A	20 x 20mm module with up to 24GPIOs and 5 analog inputs; onboard 3-axis MEMS accelerometer	<ul style="list-style-type: none"> D52QD2M4IA-A-TRAY: 20pc in 4x5 tray D52QD2M4IA-A-REEL: 800pc on 13" tape and reel 	Active
	D52QPMM4IA-A	Additional support for advanced ANT libraries (e.g., High Node Count networks)	<ul style="list-style-type: none"> D52QPMM4IA-A-TRAY: 20pc in 4x5 tray D52QPMM4IA-A-REEL: 800pc on 13" tape and reel 	Active
	D52QD2M4IA	20 x 20mm module with up to 30GPIOs and 8 analog inputs	<ul style="list-style-type: none"> D52QD2M4IA-TRAY: 20pc in 4x5 tray D52QD2M4IA-REEL: 800pc on 13" tape and reel 	Active
	D52QPMM4IA	Additional support for advanced ANT libraries (e.g., High Node Count networks)	<ul style="list-style-type: none"> D52QPMM4IA-TRAY: 20pc in 4x5 tray D52QPMM4IA-REEL: 800pc on 13" tape and reel 	Active
	D52MD2M8IA	14.0 x 9.8 x 2.0mm module with up to 24GPIOs and 8 analog inputs	<ul style="list-style-type: none"> D52MD2M8IA-TRAY: 40pc in 8x5 tray D52MD2M8IA-REEL: 1500pc on 13" tape and reel 	Active
	D52MPMM8IA	Additional support for advanced ANT libraries (e.g., High Node Count networks)	<ul style="list-style-type: none"> D52MPMM8IA-TRAY: 40pc in 8x5 tray D52MPMM8IA-REEL: 1500pc on 13" tape and reel 	Active
	D52QD2M6IA-A	D52QD2M4IA-A mounted on a carrier board for starter kit and development use	D52QD2M6IA-A-TRAY: 10 pc on 150x165mm tray	Active
	D52SKM6IA-A	Supports development on ALL ANT applications (including High Node Count Networks and G.FIT ⁷)	D52QSKM6IA-A-TRAY: 10 pc on 150x165mm tray	Active

Table 2: D52 ANT SoC Module Series Models

* ACTIVE: Device, tool, or software recommended for new designs.

Artwork not exactly as shown

⁷ For more information about G.FIT Fitness Equipment Modules, visit <https://www.thisisant.com/developer/components/gfit/>

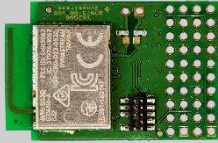
1.4 D52 ANT SoC Module Starter Kit and Components

The D52 starter kit (D52DK2) contains all the hardware necessary to get developing with ANT, including advanced ANT libraries (e.g., ANT BLAZE™) and G.FIT™. The downloadable ANT SoC Module Starter Kit User Manual describes using the kit with reference examples and the nRF5 SDK from Nordic Semiconductor. The kit is outlined in Table 3, below:





D52 Starter Kit		Part No: D52DK2	
Part No.	Description	Quantity	Picture
D52QSKM6IA-A	M4 module on carrier board with 20-pin Molex connector, NFC connections available, SWD programming header, additional through-hole connections for I/O pins	2	
ANTBAT2	Battery board with a Molex socket, a reset button and a five-position dip switch	2	
ANTI01	I/O board with a Molex connector, a Molex socket, 4 LEDs and 4 buttons	2	
ANTUIF1	USB interface board with a Molex socket	1	
ANTUSB-m	ANT USB dongle	1	
	Segger J-Link Lite Programmer	1	

Table 3: D52 ANT SoC Module Starter Kit

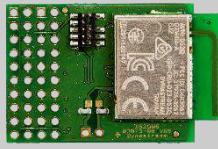

1.5 D52 ANT SoC Module Extender Kit and Components

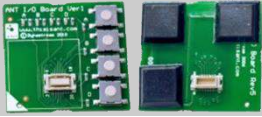
The D52 extender kit (D52EXT1) builds on the D52 starter kit to provide extra nodes and more power for IoT developers and platforms, including ANT BLAZE™. This kit also includes the ANTBAT3 combination I/O and battery board. Powered by 2 AA batteries, the development board enables longer testing and development and includes buttons and LEDs for testing input and interaction. A D52 starter kit (D52DK2) is recommended for use with the extender kit, as the starter kit includes the tools necessary to program and monitor development nodes.

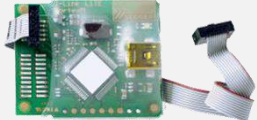
D52 Extender Kit		Part No: D52EXT1	
Part No.	Description	Quantity	Picture
D52QSKM6IA-A	M4 module on carrier board with 20-pin Molex connector, NFC connections available, SWD programming header, additional through-hole connections for I/O pins	4	
ANTBAT3	Combined battery and I/O board with a Molex socket, a reset button, I/O buttons, LEDs and dip switches, powered by two AA batteries	4	

Table 4: D52 ANT SoC Module Extender Kit



2 Product Overview

2.1 D52Q Model Block Diagrams

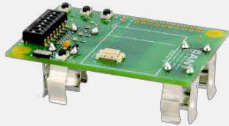
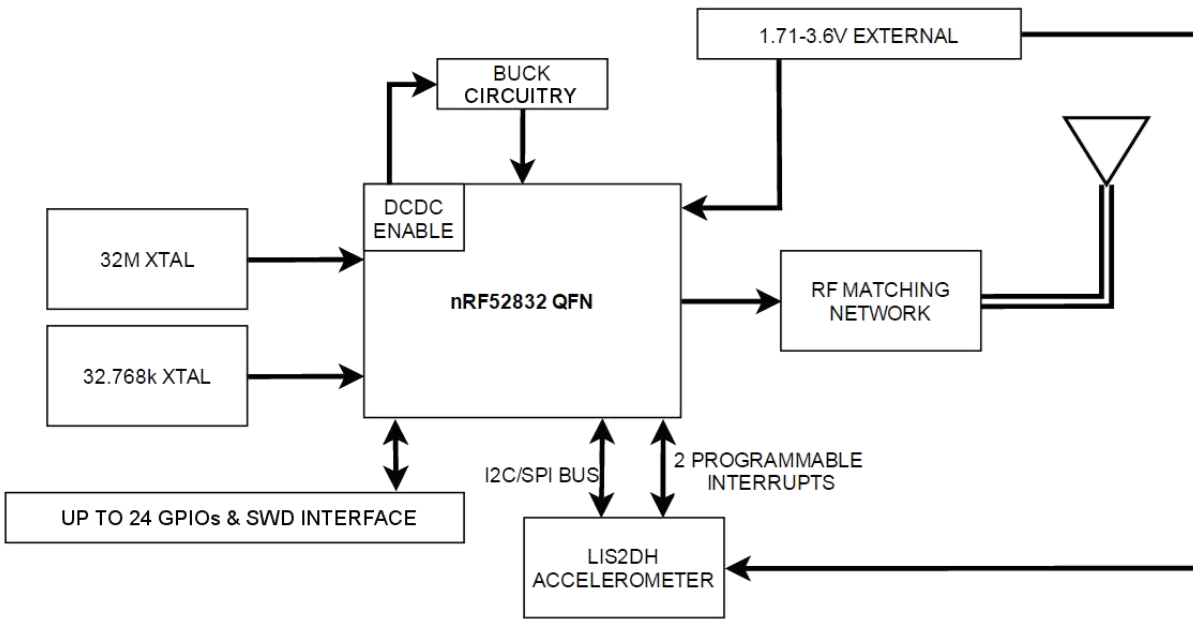

Figure 3: D52QD2M4IA-A, D52QPMM4IA-A Models (with accelerometer) Module Block Diagram

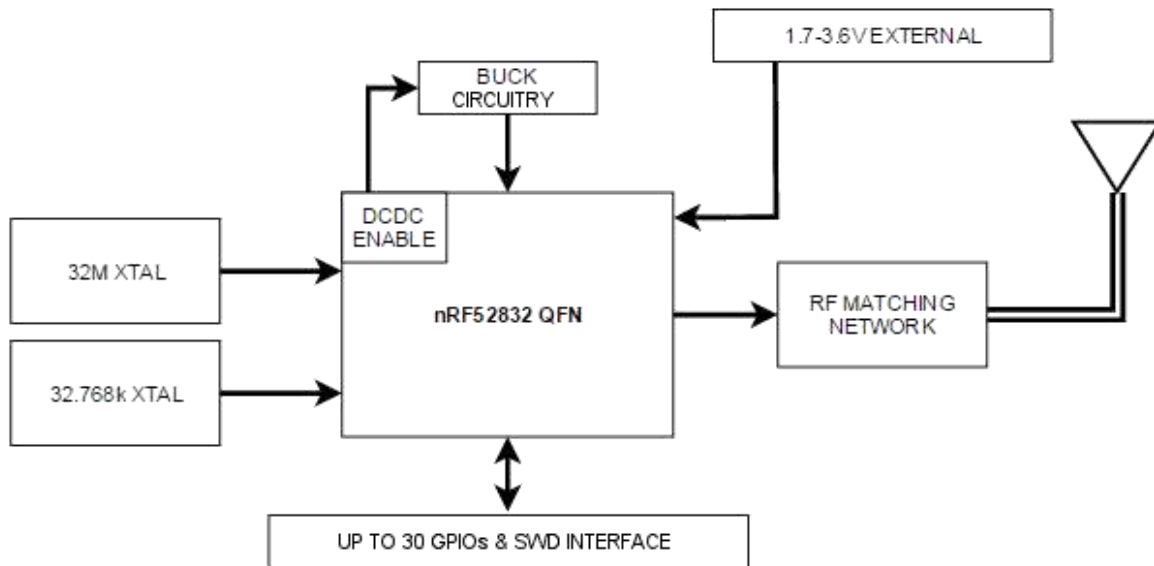

Figure 4: D52QD2M4IA, D52QPMM4IA Models (no accelerometer) Module Block Diagram

2.2 D52M Model Block Diagram

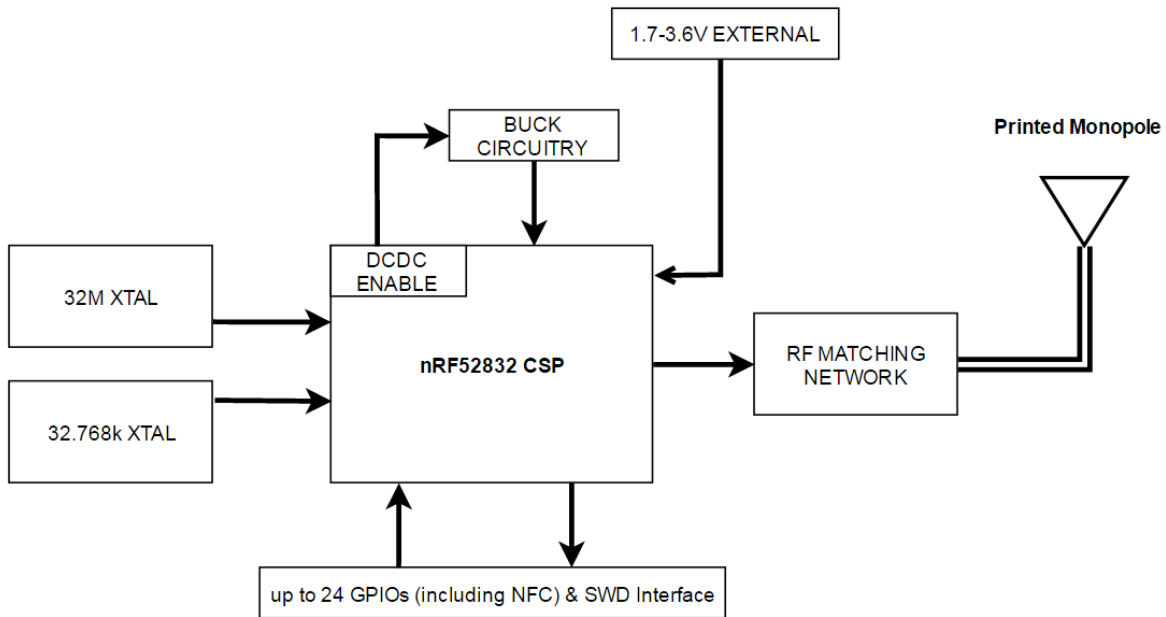

Figure 5: D52MD2M8IA, D52MPMM8IA Models Module Block Diagram

2.3 Pin-outs

A note on backwards drop-in compatibility with D52Q: D52Q M4 modules support drop-in compatibility with ANTAP281M4IB, ANTC782M4IB, N5150M4CD, N550M4CC and N548M4CB modules from Garmin (formerly Dynastream) under certain configurations. For drop-in compatibility, existing designs must use only the reset capability of the reset/SWDIO pin on previous modules. See pin H202, below. In addition, there must be nothing on existing designs that would contact the new-to-layout LGA pads in the middle of the D52Q modules.

A note on backwards drop-in compatibility: the D52M modules support drop-in compatibility with the following N5 M8 module models from Garmin (formerly Dynastream) in certain configurations: N5150M8CD, N550M8CC, N548M8CB. For drop-in compatibility, existing designs must use only the SWDIO capability of the reset/SWDIO pad on previous modules. If needed, the reset function can be configured on another pad; see Table 5 below for more information.

A note on the preloaded Network Processor application: Please refer to Appendix A – Using the ANT Network Processor Configuration for ANT Serial Line specification.

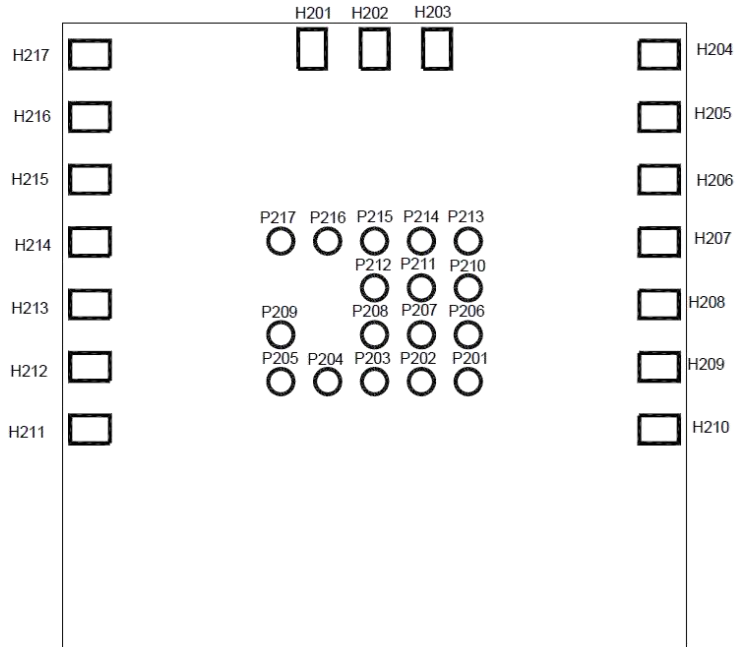

Figure 6: D52Q M4 (20mm x 20mm) Bottom View

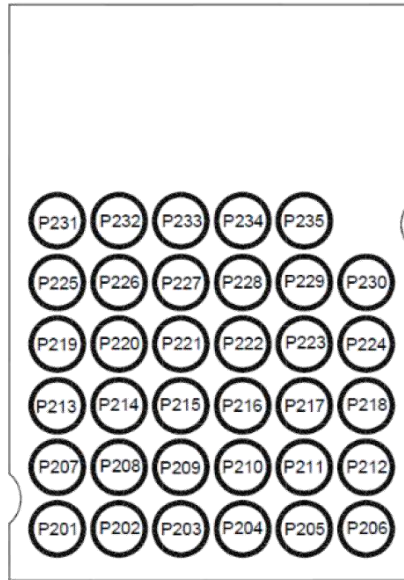

Figure 7: D52M M8 (14.0mm x 9.8mm) Bottom View

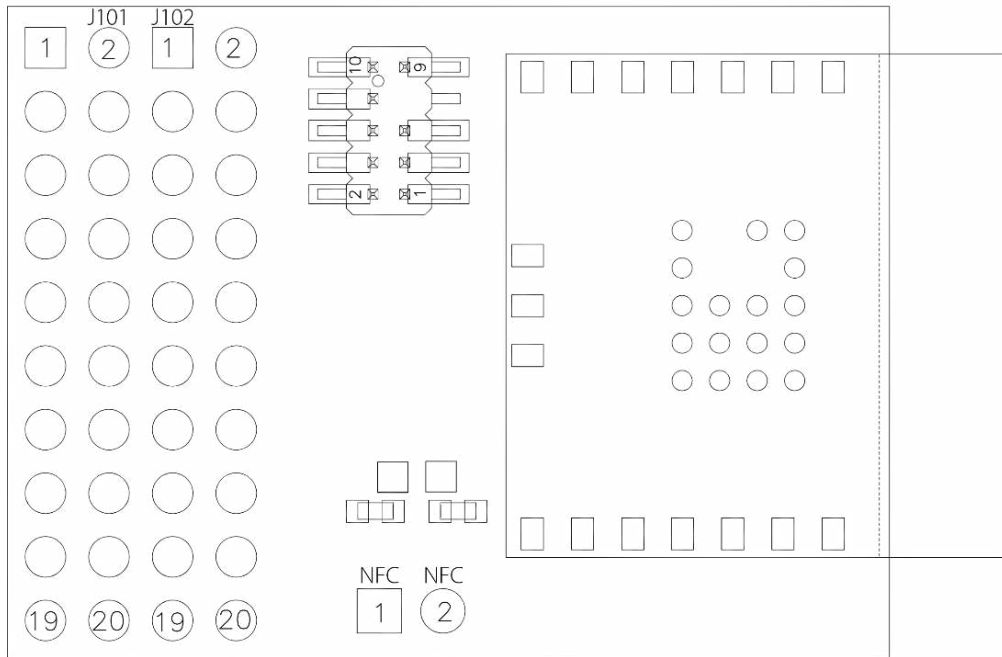

Figure 8: D52Q M6 (Development Module) - Top View

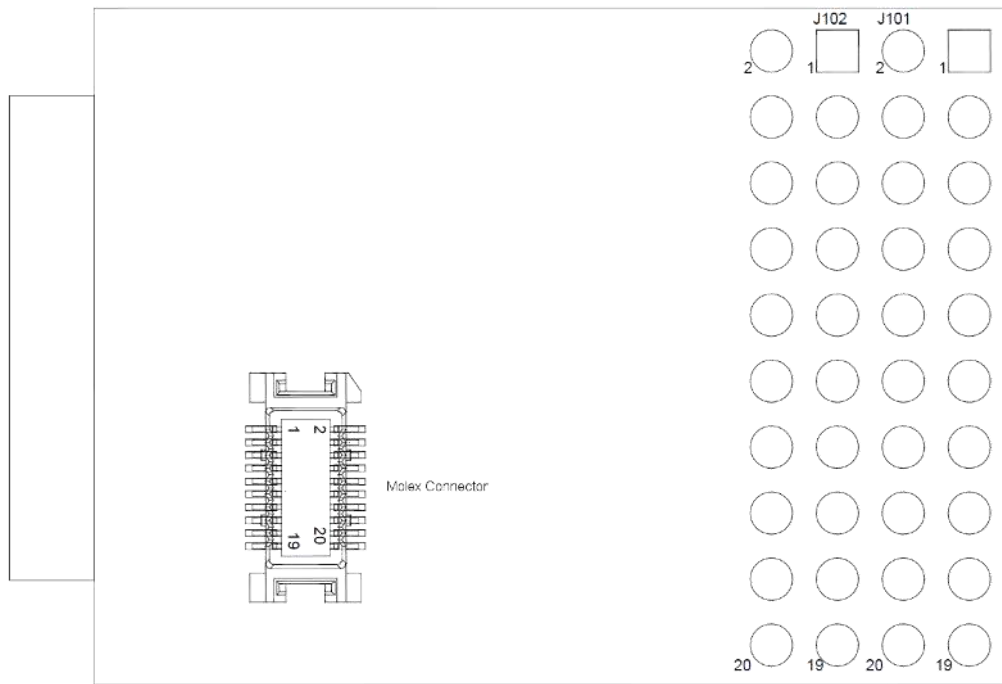

Figure 9: D52Q M6 (Development Module) - Bottom View

D52Q M4 Pin ⁸	D52M M8 Pin	D52Q M6		nRF52832 Pin Name	Description
		Molex Connector	Dev Board Pin		
H201	P230	16	J102.19	SWDIO	Serial Wire Debug I/O for debug and programming
H202	P207	10	J101.06	P021/RESET	General Purpose I/O / System Reset pin
H203	P225, P226, P219, P220	1	J101.01	VCC	Power Supply Pin
H204	P231, P232, P233, P234, P235	19	J101.02, J101.08, J102.20	VSS	Ground
H205	P224	6	J101.07	SWDCLK	Serial Wire Debug clock input for debug and programming
H206	P212	17	J101.09	P006	General Purpose I/O
H207	-	15	J101.10	P007	General Purpose I/O
H208	P208	-	J102.01	P002/AIN0	General Purpose I/O / Analog SAADC/COMP/LPCOMP input
H209	P218	11	J101.17	P008	General Purpose I/O
H210	P201	7	J101.19	P011	General Purpose I/O
H211	-	4	J101.04, J101.15	P017	General Purpose I/O
H212	P221	3	J101.03, J101.11	P016	General Purpose I/O
H213	P228	5	J101.18	P015	General Purpose I/O
H214	P217	9	J101.20	P014	General Purpose I/O
H215	P216	-	J102.17	P013	General Purpose I/O
H216	P205	8	J102.15	P031/AIN7	General Purpose I/O / Analog SAADC/COMP/LPCOMP input
H217	P229	2	J101.05	P012	General Purpose I/O
P201	P222	-	NFC.2	NFC2/P010	NFC antenna connection / General Purpose I/O
P202	-	14	J102.04	P019	General Purpose I/O
P203	P227	13	J102.06	P020	General Purpose I/O
P204	P215	18	J102.08	P022	General Purpose I/O
P205	-	20	J102.10	P023	General Purpose I/O
P206	P223	-	NFC.1	NFC1/P009	NFC antenna connection / General Purpose I/O
P207	P211	-	J102.07	P005/AIN3	General Purpose I/O / Analog SAADC/COMP/LPCOMP input
P208	P214	-	J102.02	P018	General Purpose I/O
P209	P213	12	J102.12	P024	General Purpose I/O
P210	P209	-	J102.05	P004/AIN2	General Purpose I/O / Analog SAADC/COMP/LPCOMP input
P211	P210	-	J102.03	P003/AIN1	General Purpose I/O / Analog SAADC/COMP/LPCOMP input
P212 ⁸	-	-	J102.16	P026	General Purpose I/O
P213 ⁸	P203	-	J102.11	P029/AIN5	General Purpose I/O / Analog SAADC/COMP/LPCOMP input
P214 ⁸	P204	-	J102.13	P030/AIN6	General Purpose I/O / Analog SAADC/COMP/LPCOMP input
P215 ⁸	P202	-	J102.09	P028/AIN4	General Purpose I/O / Analog SAADC/COMP/LPCOMP input
P216 ⁸	-	-	J102.18	P027	General Purpose I/O
P217 ⁸	P206	-	J102.14	P025	General Purpose I/O

Table 5: D52 Module Series Pin-Out

⁸ See section 2.3.1 for onboard accelerometer pin usage (optional; D52Q models with -A suffix only).

2.3.1 (Optional) Accelerometer Specification

The D52 module series includes an accelerometer accessory on the D52QD2M4IA-A, D52QPMM4IA-A models, only. The accelerometer is the LIS2DH by STMicroelectronics. To make use of the accelerometer, the following pins are consumed:

D52QD2M4IA-A Pin	nRF52832 Pin	LIS2DH Pin
P212	P026	INT2
P213	P029/AIN5	SDA/SDI/SDO
P214	P030/AIN6	SCL/SPC
P215	P028/AIN4	SDO/SA0
P216	P027	CS
P217	P025	INT1

Table 6: Accelerometer Pin Assignment

SPI or I²C can be used to communicate with the accelerometer. To use I²C, pull-up resistors will need to be added to the appropriate pads.

For more information about D52Q pin assignments, refer to **Table 5: D52 Module Series Pin-Out**.

For more information about this component including data sheet and errata, please refer to the STMicroelectronics website:

- http://www.st.com/web/en/catalog/sense_power/FM89/SC444/PF252928.

2.4 Preloaded Software

D52 series modules are preloaded with the S212 ANT SoftDevice and the ANT Network Processor (NP) application as illustrated below. Depending on the module revision, the preloaded code may vary. Please refer to Appendix B – D52 Module Series Pre-Loaded Software Versions for further details. Licensing terms for the preloaded software are described in the Module Distribution Agreement, which is referenced in section 4 - Licensing & Conditions of Use.

- **S212 SoftDevice** – Refer to the S212 nRF52832 SoftDevice Specification.
- **ANT Network Processor Application** – Refer to Appendix A – Using the ANT Network Processor Configuration

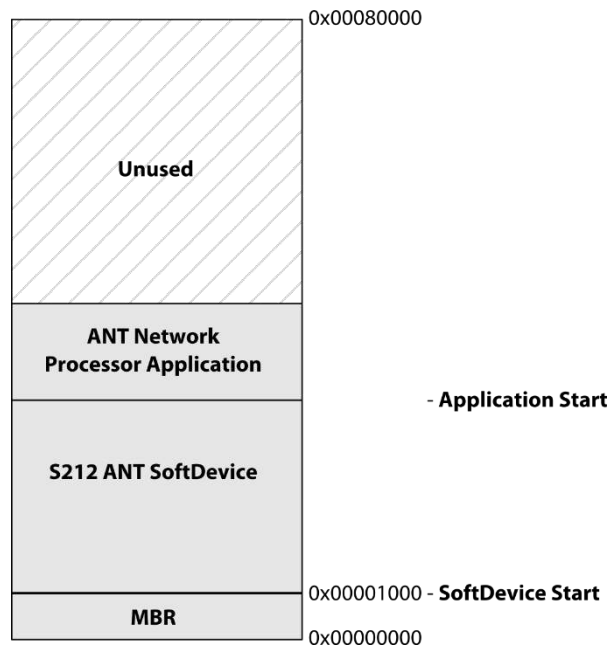

Figure 10: Memory Map of the Preloaded Software

2.5 D52 Module Programming

The D52 ANT SoC module series supports programming by standard Serial Wire Debug (SWD) interface. The two software components (the SoftDevice and the application code) must be version compatible to operate properly. To ensure proper operation after reprogramming, it is recommended that the module undergoes a full erasure (e.g. using the erase-all option in nrfjprog.exe/nRFgo Studio) and all desired software components be explicitly programmed onto the module.

2.5.1 Programming via SWD Interface

The D52 ANT SoC Module series supports the Serial Wire Debug (SWD) interface, SWDCLK and SWDIO (refer to Table 5: D52 Module Series Pin-Out). Programming and debugging of the module only require commonly available tools, such as the Keil software development environment and the Segger J-Link programmer.

Please refer to "ANT SoC Module Starter Kit User Manual" from Garmin (formerly Dynastream Innovations) for reference software setup and use with ANT using the Keil software and a J-Link programmer.

2.5.2 Initializing the SoftDevice

D52 series modules come with 20ppm onboard 32 kHz crystals. When initializing the SoftDevice, it is important to set the crystal accuracy to be 20ppm. This clock source is selected when enabling the SoftDevice via the `sd_softdevice_enable` command.

2.5.3 Configuring the DC/DC converter

D52 series modules can make use of the DC/DC Converter on nRF52832 chips. This can improve power consumption under certain conditions.

2.6 Design Considerations

RF performance is always affected by the environment. Good design makes a product less susceptible to adverse conditions. The recommendations in this section are guidelines only; you should thoroughly test your products in the intended use case environments and make necessary modifications and trade-offs.

For assistance in design, a STEP model package and Altium library are available from Garmin (formerly Dynastream Innovations) for all D52 module series models.

2.6.1 D52Q M6 module mounting

The mating socket is Molex 52991-0208.

2.6.2 D52Q M4 Module Mounting

Figure 11 shows D52Q component outline and keepout areas in pink. There should not be any exposed copper or routing in the keepout areas, on any layer. The component body is crosshatched pink, and signal pads are red. Please reference the D52Q Altium Footprint for more accurate keepout dimensions and positioning. Figure 12, on the next page, describes mating PCB characteristics.

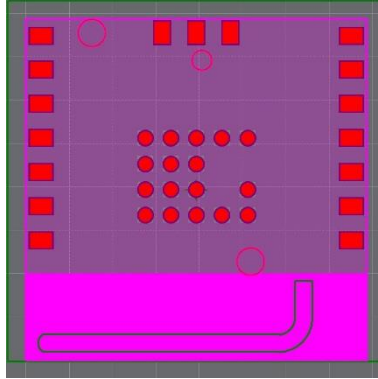

Figure 11: D52Q signal pads, component outline and keepout areas

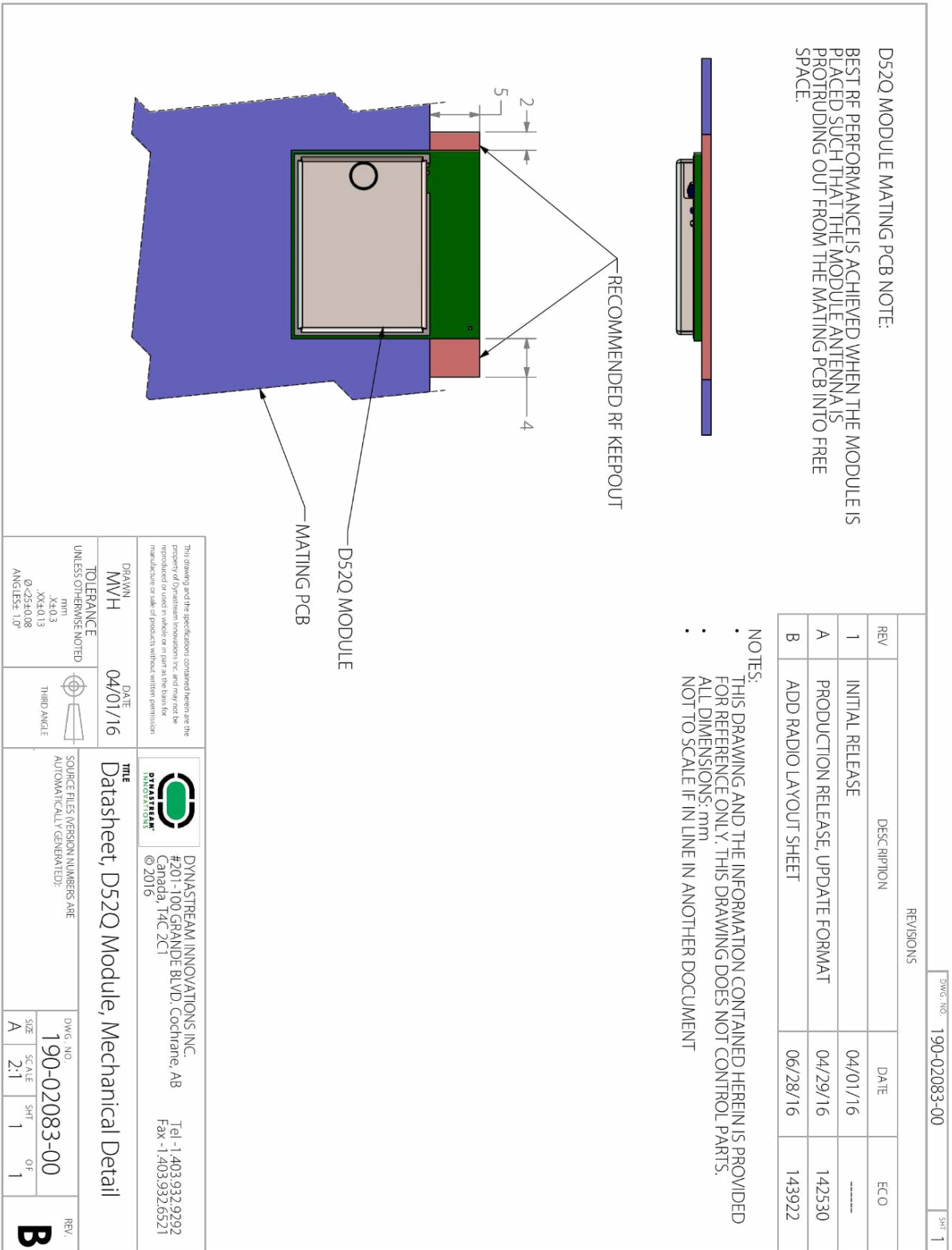
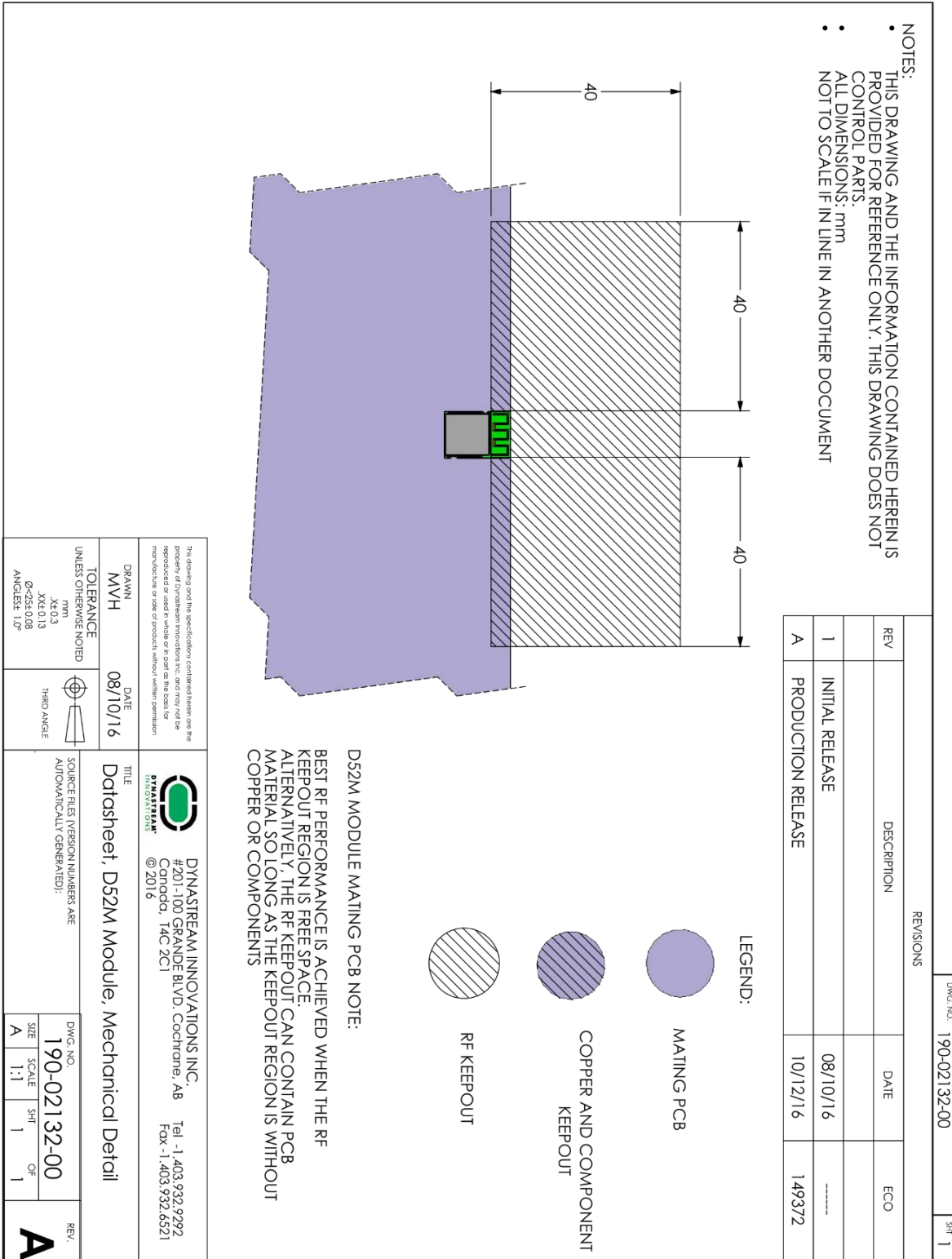

Figure 12: D52Q Module Mounting

2.6.3 D52M M8 Module Mounting



PDM4.4

Figure 13: D52M Module Mounting

Figure 14, below, shows D52M component outline and keepout areas in pink. There should not be any exposed copper or routing in the keepout areas, on any layer. The component body is crosshatched pink, and signal pads are shown in red. Please reference the D52M Altium Footprint for more accurate keepout dimensions and positioning. Figure 13, on the previous page, describes mating PCB characteristics.

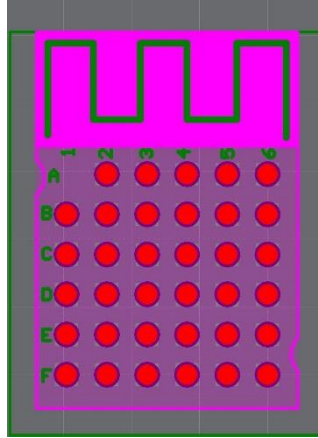

Figure 14: D52M signal pads, component outline and keepout areas

2.7 Assembly Considerations

2.7.1 Moisture Control

D52 series modules are rated at different levels as defined by IPC/JEDEC J-STD-020:

D52 Model	Moisture Control Level
D52QD2M4IA-A, D52QPMM4IA-A	3
D52QD2M4IA, D52QPMM4IA	2
D52MD2M8IA, D52MPMM8IA	1

Table 7: D52 Module Series Moisture Control Levels

To ensure good solderability of the PCB pads, it is highly recommended to always have the modules intended for reflow well sealed when in storage.

2.7.2 D52Q M4 Module Solder Stencil

The following reference example is used to create the D52QD2M6IA-A development modules:

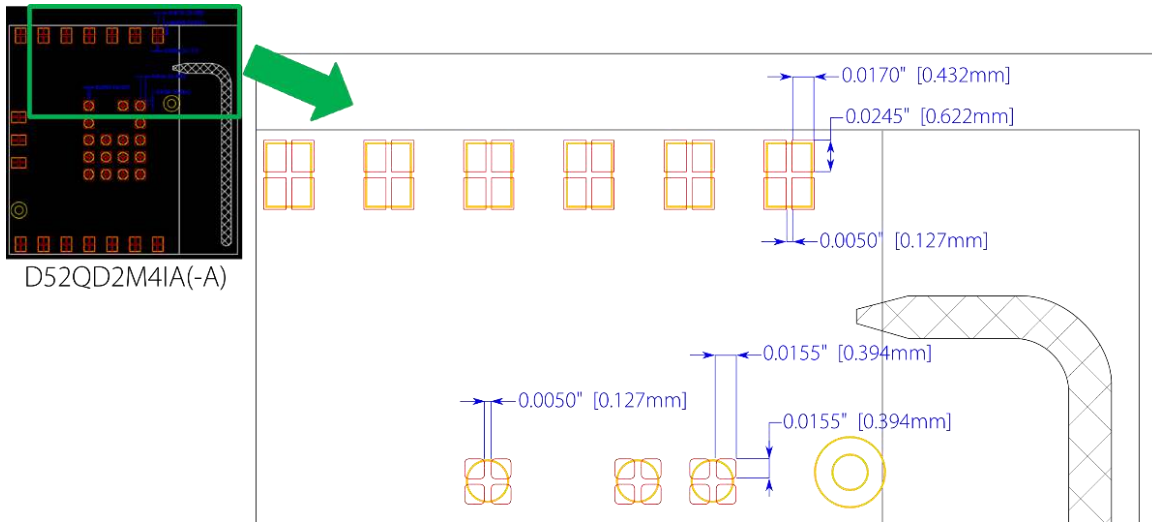

Figure 15: D52Q M4 Solder Stencil

2.7.3 D52M M8 Module Solder Stencil

Below is a diagram describing a solder stencil for Garmin (formerly Dynastream) M8 modules, including the D52M:

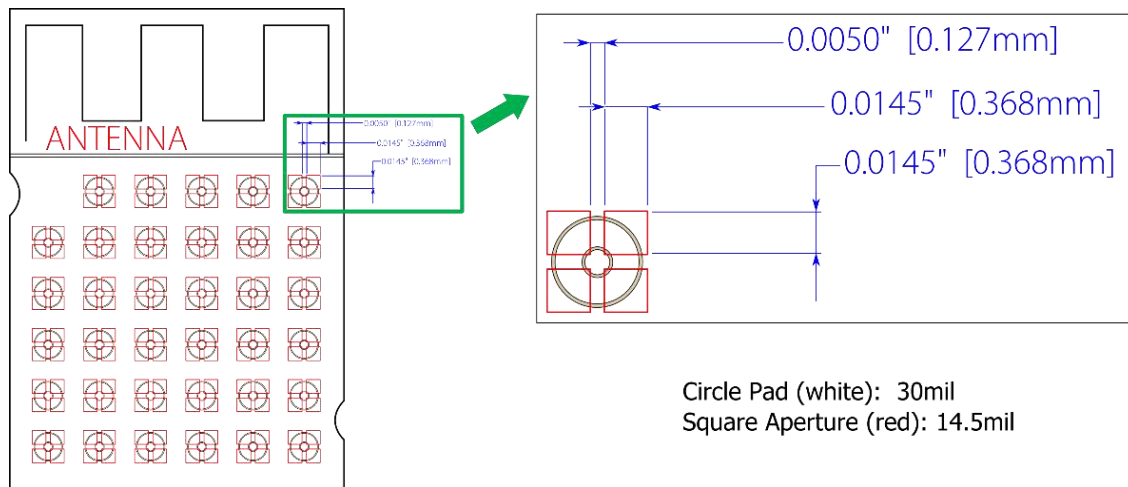

Figure 16: D52M M8 Solder Stencil

2.7.4 Cleaning Process

D52 series modules are made using no-clean solder paste. No-clean process is recommended.

3 Regulatory Approvals and Compliance

Modules in the D52 ANT SoC Module Series, when loaded with an ANT and/or BLUETOOTH low energy stack⁹, have received regulatory approvals in the United States (FCC) and Canada (IC), and have been verified to conform to the appropriate regulations in Europe, Great Britain, Australia and New Zealand, Japan and South Korea. The modules have been qualified by BLUETOOTH SIG. Such approvals and qualification allow the user to place the module inside a finished product and, in most cases, not require regulatory testing for an intentional radiator, provided no changes or modifications are made to the module circuitry. This does not preclude the possibility that some other form of authorization or testing may be required for the finished product.

Changes or modifications could void the user's authority to operate the equipment. The end user must comply with all of the instructions provided by the Grantee, which indicate installation and/or operating conditions necessary for compliance.

3.1 United States

This device complies with part 15 of the FCC Rules. Operation is subject to the following two conditions: (1) This device may not cause harmful interference, and (2) this device must accept any interference received, including interference that may cause undesired operation.

A host product manufacturer is responsible for ensuring compliance with the module(s) installed and fully operational. For example, if a host product was previously authorized as an unintentional radiator under the Declaration of Conformity procedure without containing a certified transmitter module, then a module is added, the host manufacturer is responsible for ensuring that the host continues to be compliant with the Part 15 subpart B unintentional radiator requirements after the module is installed and operational. Because this may depend on the details of how the module is integrated within the host, the module grantee (the party responsible for the module grant) shall provide guidance to the host manufacturer for ensuring compliance with the Part 15 Subpart B requirements.

This module is limited to OEM installation ONLY. The OEM Integrator is responsible for ensuring that the end-user has no manual instructions to remove or install the module. Changes or modifications not expressly approved by Garmin could void the user's authority to operate the equipment.

If (1) the module's FCC ID is not visible when installed in the host, or (2) if the host is marketed so that end users do not have straightforward commonly used methods for access to remove the module so that the FCC ID of the module is visible; then an additional permanent label referring to the enclosed module must be used:

- For **D52Q** modules: "Contains Transmitter Module FCC ID: 06R3067" or "Contains FCC ID: 06R3067"
- For **D52M** modules: "Contains Transmitter Module FCC ID: 06R3153" or "Contains FCC ID: 06R3153"

The host OEM user manual must also contain clear instructions on how end users can find and/or access the module and the FCC ID.

3.2 Canada

This device complies with Industry Canada's license-exempt RSSs. Operation is subject to the following two conditions:

- (1) This device may not cause interference; and
- (2) This device must accept any interference, including interference that may cause undesired operation of the device.

Le présent appareil est conforme aux CNR d'Industrie Canada applicables aux appareils radio exempts de licence. L'exploitation est autorisée aux deux conditions suivantes : (1) l'appareil ne doit pas produire de brouillage, et (2) l'utilisateur de l'appareil doit accepter tout brouillage radioélectrique subi, même si le brouillage est susceptible d'en compromettre le fonctionnement.

⁹ Refer to section 4

To comply with Industry Canada regulations, it is required that products containing the D52 module series display a label referring to the enclosed module. This exterior label can use wording similar to the following:

- For **D52Q** modules: "Contains IC: 3797A-3067"
- For **D52M** modules: "Contains IC: 3797A-3153"

This information shall be affixed in such a manner as not to be removable except by destruction or defacement. The size of the lettering shall be legible without the aid of magnification but is not required to be larger than 8-point font size. If the device is too small to meet this condition, the information can be included in the user manual upon agreement with Industry Canada.

3.3 European Economic Area and Great Britain

D52 series modules are declared to be in conformance with the essential requirements and other relevant provisions of Directive 2014/53/EU and 2011/65/EU, as a low-powered unlicensed transmitter:



IEC 60950-1:2005(2 nd Edition) + A1:2009 + A2:2013 EN 60950-1: 2006 + A11:2009 + A1:2010 + A12:2011 + A2:2013	Information technology equipment – Safety – Part 1: General requirements
EN 62479:2010	Assessment of the compliance of low power electronic and electrical equipment with the basic restrictions related to human exposure to electromagnetic fields (10 MHz to 300 GHz)
EN 300 328 v2.2.2 2019-07	Wideband transmission systems; Data transmission equipment operating in the 2,4 GHz ISM band and using wide band modulation techniques
EN 300 440 v2.1.1 2017-03	Short Range Devices (SRD); Radio equipment to be used in the 1 GHz to 40 GHz frequency range
EN 301 489-1 v2.1.1 2017-02	ElectroMagnetic Compatibility (EMC) standard for radio equipment and services; Part 1: Common technical requirements; Part 3: Specific conditions for Short-Range Devices (SRD) operating on frequencies between 9 kHz and 246 GHz; Part 17: Specific conditions for Broadband Data Transmission Systems
EN 301 489-3 v2.1.1 2017-03	
EN 301 489-17 v3.1.1 2017-02	

EU Postal Address: Garmin Würzburg GmbH, Beethovenstrasse 1a, 97080, Würzburg, Germany

Great Britain Address: Garmin (Europe) Ltd., Liberty House, Hounslow Business Park, Southampton, S040 9LR, UK

3.4 Australia and New Zealand

The D52 ANT SoC module series has been tested and found to comply with:



ACMA Radiocommunications (Short Range Devices) Standards 2014; 2400 and 5700 MHz bands only EN 60950-1: (2nd Edition) Information technology equipment. Safety. General requirements
AS/NZS CISPR 22:2009 Information technology equipment. Radio disturbance characteristics. Limits and methods of measurement AS/NZS 4268:2012 – Radio equipment and systems – Short Range Devices – Limits and methods of measurement
EN 301 489-1/-3/-17 Electromagnetic compatibility and Radio spectrum Matters (ERM); ElectroMagnetic Compatibility (EMC) standard for radio equipment and services; Part 1: Common technical requirements ; Part 3: Specific conditions for Short-Range Devices (SRD); Part 17: Specific conditions for Broadband Data Transmission systems
EN 300 440 Electromagnetic compatibility and Radio spectrum Matters (ERM); Short range devices; Radio equipment to be used in the 1 GHz to 40 GHz frequency range EN 300 328 Electromagnetic compatibility and Radio spectrum Matters (ERM); Wideband transmission systems

The ACMA supplier code number is N20233

3.5 Japan

D52Q and D52M models have been granted type certificate (mark numbers below). Standard applied: 2.4GHz band wide-band low-power data communication system (item 19 of Article 2 paragraph 1).

- For **D52Q** models: mark number R201-160147
- For **D52M** models: mark number R201-163171

3.6 Korea

The D52Q and D52M modules have been certificated under the Clause 2, Article 58-2 of Radio Wave Act by Ministry of Science, ICT and future Planning, Republic of Korea. The certification No's. are:

- For **D52Q** models: MSIP-CRM-D23-D52Q
- For **D52M** models: MSIP-CRM-D23-D52M



3.7 Brazil

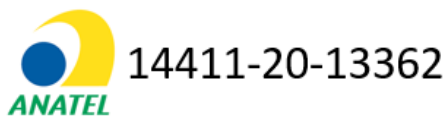

Garmin Canada Inc is the entity that supplies the modules and that provided permission to Blue Cycle Distribuidora S/A in Brazil for Anatel to process the certification of the D52MD2M8IA module for use in products manufactured and supplied by Elite.

Este equipamento não tem direito à proteção contra interferência prejudicial e não pode causar interferência em sistemas devidamente autorizados.

3.8 BLUETOOTH Qualification

D52Q and D52M modules are listed as Bluetooth components (tested) on the Bluetooth SIG Qualified Design List:

- For **D52Q** models: Qualified Design ID 83227; Declaration ID is D030904
- For **D52M** models: Qualified Design ID 89214; Declaration ID is D032894

Further use of this design to create subsequent BLUETOOTH implementations can be achieved without further qualification provided that the resulting implementation has no negative material impact on the BLUETOOTH performance or functionality of the design.

4 Licensing & Conditions of Use

Products incorporating D52 series modules wishing to make use of the certifications outlined in section 3 must guarantee that they are using an approved ANT and or Bluetooth low energy SoftDevice and have entered into a D52 Series Module Distribution Agreement with Garmin Canada. Section 4.1 outlines the conditions of use for D52 modules (which includes the D52 Series Module Distribution Agreement), and Section 4.2 outlines where to obtain licenses for the approved SoftDevices.

4.1 Conditions of Use

The D52 Series of modules have been designed to support the ANT and/or Bluetooth low energy Protocols and are certified for use in many geographic regions around the globe. However, a product incorporating the D52 series module may carry the certification IDs of the module only if it complies with the restrictions and terms, including use of Garmin -approved software, provided in the conditions of use available at:

https://www.thisisant.com/developer/components/d52/#798_tab?components/d52/conditions-of-use

4.2 SoftDevice Licensing

ANT and Bluetooth low energy SoftDevices approved for use on the D52 Module series as referenced in section 4.1 – Conditions of Use – are licensed separately from Garmin and Nordic Semiconductor:

SoftDevice	Protocol(s)	Licensor	Link
S212	ANT	Garmin	Garmin SoftDevices
S332	ANT and Bluetooth low energy	Garmin	Garmin SoftDevices
S132	Bluetooth low energy	Nordic Semiconductor	Nordic Downloads

Table 8: SoftDevice Licensing and Downloads

5 Electrical Specifications

5.1 Recommended Operating Conditions

Parameter	Min	Max	Unit
Operating ambient temperature range, T_A	-40	+85	°C
Operating supply voltage	1.71 with accelerometer; 1.7 without	3.6	V

Table 9: Recommended Operating Conditions

5.2 Absolute Maximum Ratings

Parameter	Test Conditions	Min	Max	Unit
Supply Voltage (VCC)		-0.3	3.9	V
$V_{I/O}$, VCC ≤ 3.6V		-0.3	VCC+0.3	V
$V_{I/O}$, VCC > 3.6V		-0.3	3.9	V
Storage temperature range		-40	85	°C
ESD	All pads, according to human-body model, JEDEC STD 22, method A114		4 (D52Q) 2 (D52M)	kV
	According to charged-device model, JEDEC STD 22, method C101		1000 (D52Q) 500 (D52M)	V

Table 10: Absolute Maximum Ratings

Stresses beyond those listed under Absolute Maximum Ratings may cause permanent damage to the device. These are stress ratings only and functional operation of the device at these or any other conditions beyond those indicated under Recommended Operating Conditions are not implied. Exposure to absolute-maximum-rated conditions for extended periods may affect device reliability.

5.3 Electrical Specifications

Please refer to the nRF52832 Product Specification by Nordic Semiconductor.

5.4 Radio Operation Specifications

nRF52832 Output Setting (dBm)	Typical Peak Radio Current (mA)*
0 (DCDC, 3V)	5.3
0 (LDO, 3V)	11.6
+4 (DCDC, 3V)	7.5
+4 (LDO, 3V)	16.6

Table 11: Current Consumption of Radio Operation

* For additional information regarding radio current please refer to the nRF52832 product specification from Nordic Semiconductor

The following typical radiation pattern for D52Q (M4) models was recorded in an anechoic chamber at 2440MHz and 0dBm output following the recommended mounting guide.

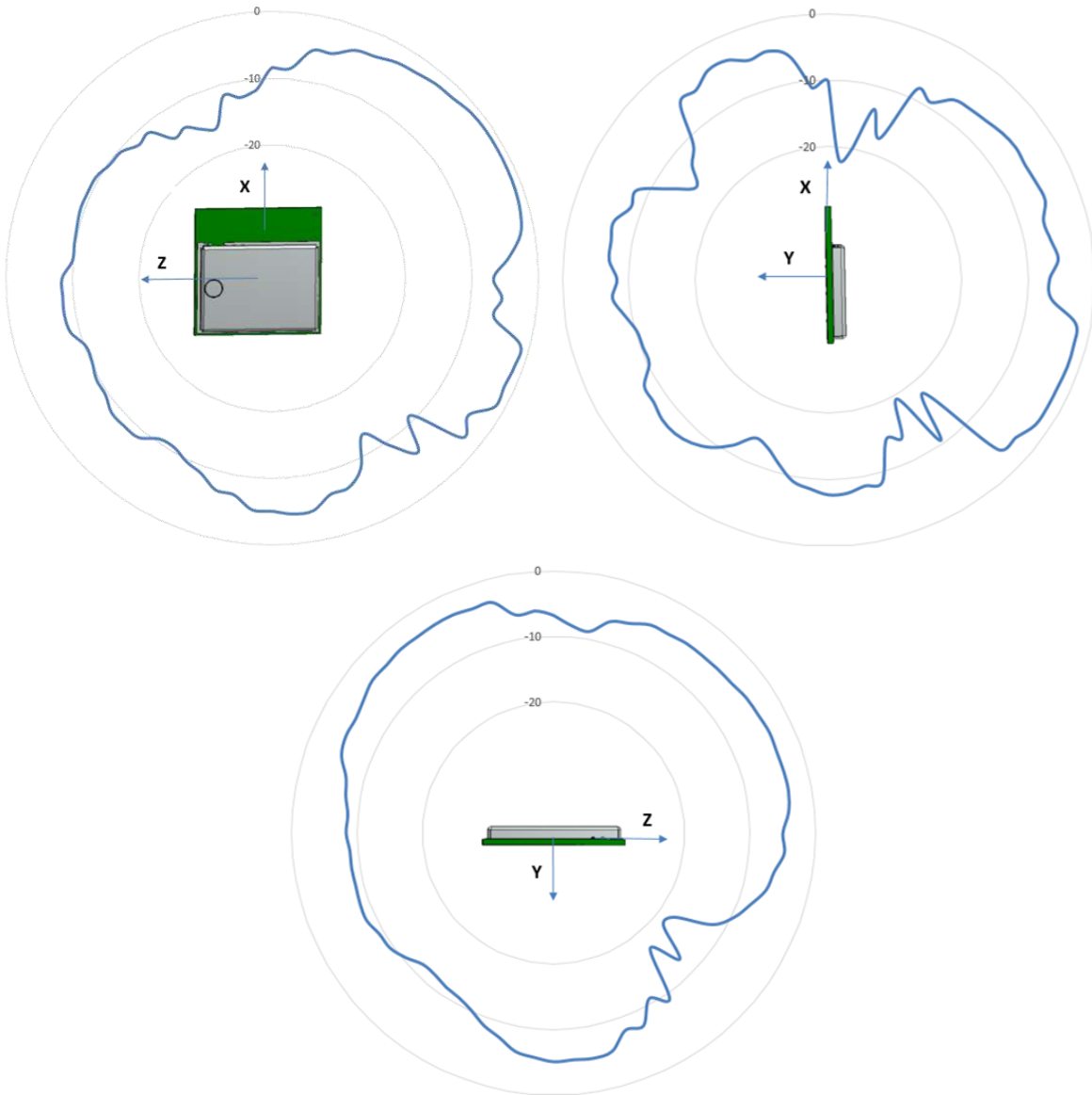

Figure 17: D52Q M4 Module Typical Antenna Gain (dBi)

To understand and properly use the radiation pattern for your design, please refer to the application note: Interpreting RF Radiation Patterns.

The following typical radiation pattern for D52Q (M4) models was recorded in an anechoic chamber at 2440MHz and 0dBm output following the recommended mounting guide.

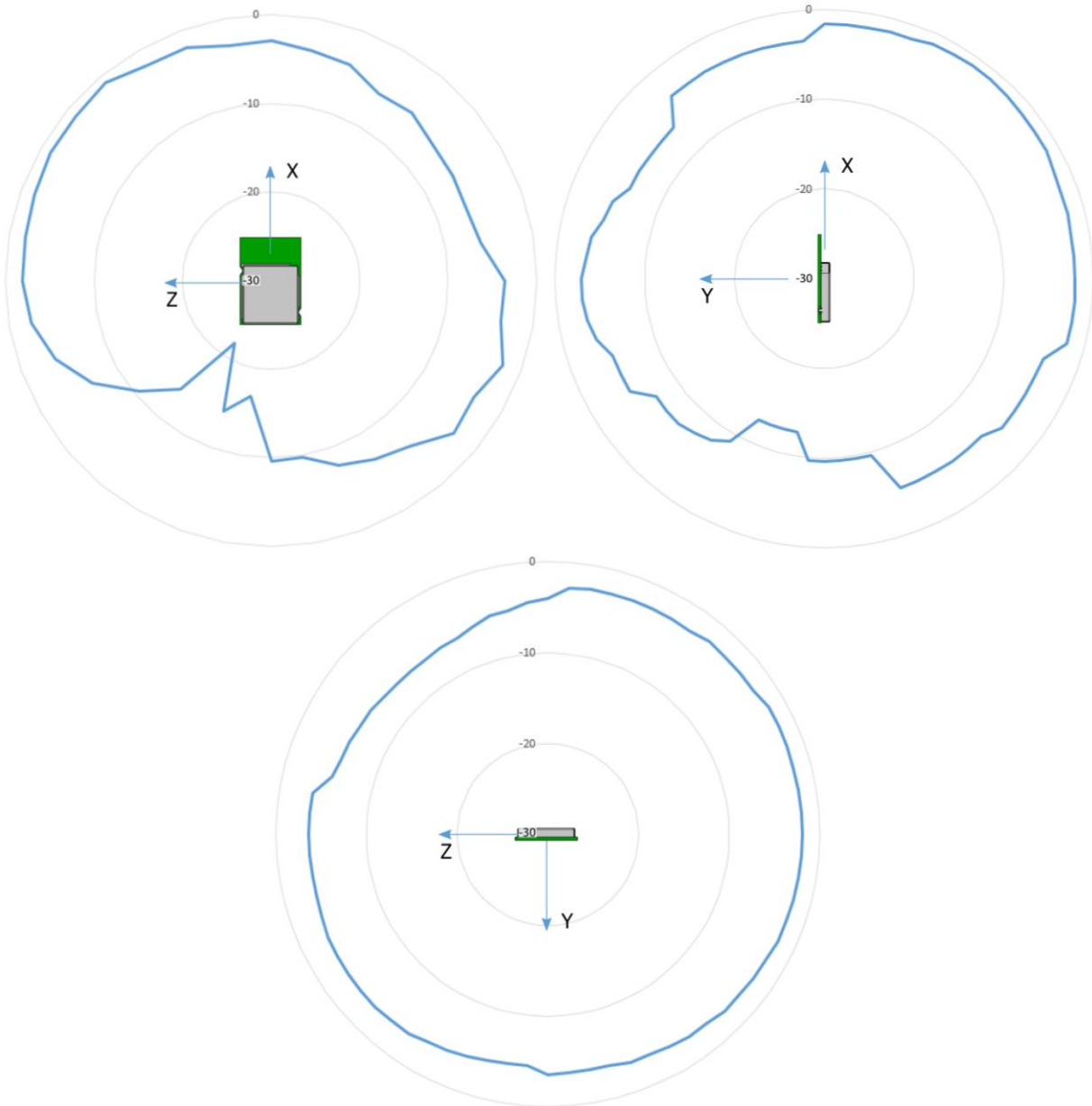

Figure 18: D52M M8 Module Typical Antenna Gain (dBi)

6 Mechanical Drawings

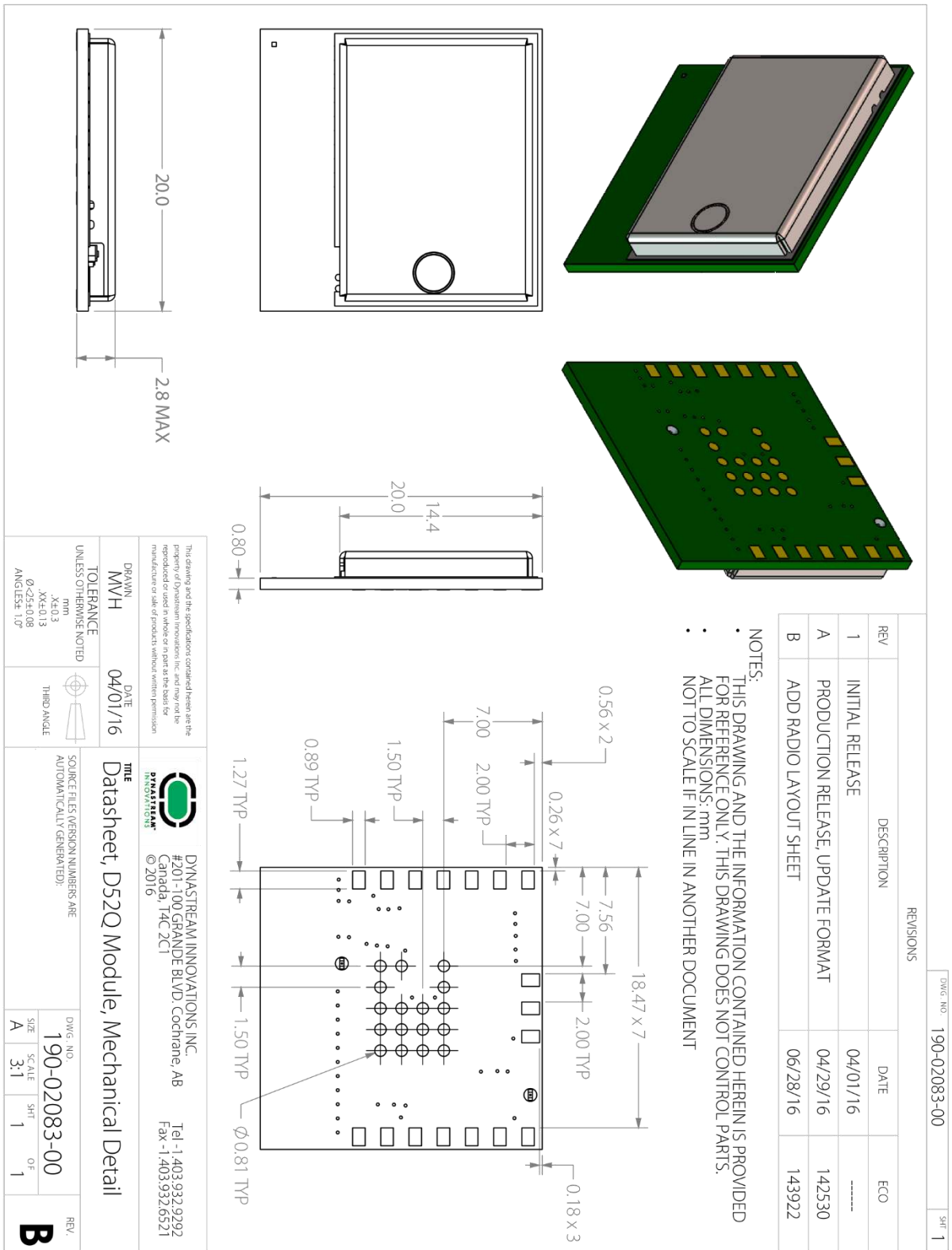

Figure 19: D52Q M4 Mechanical Drawing

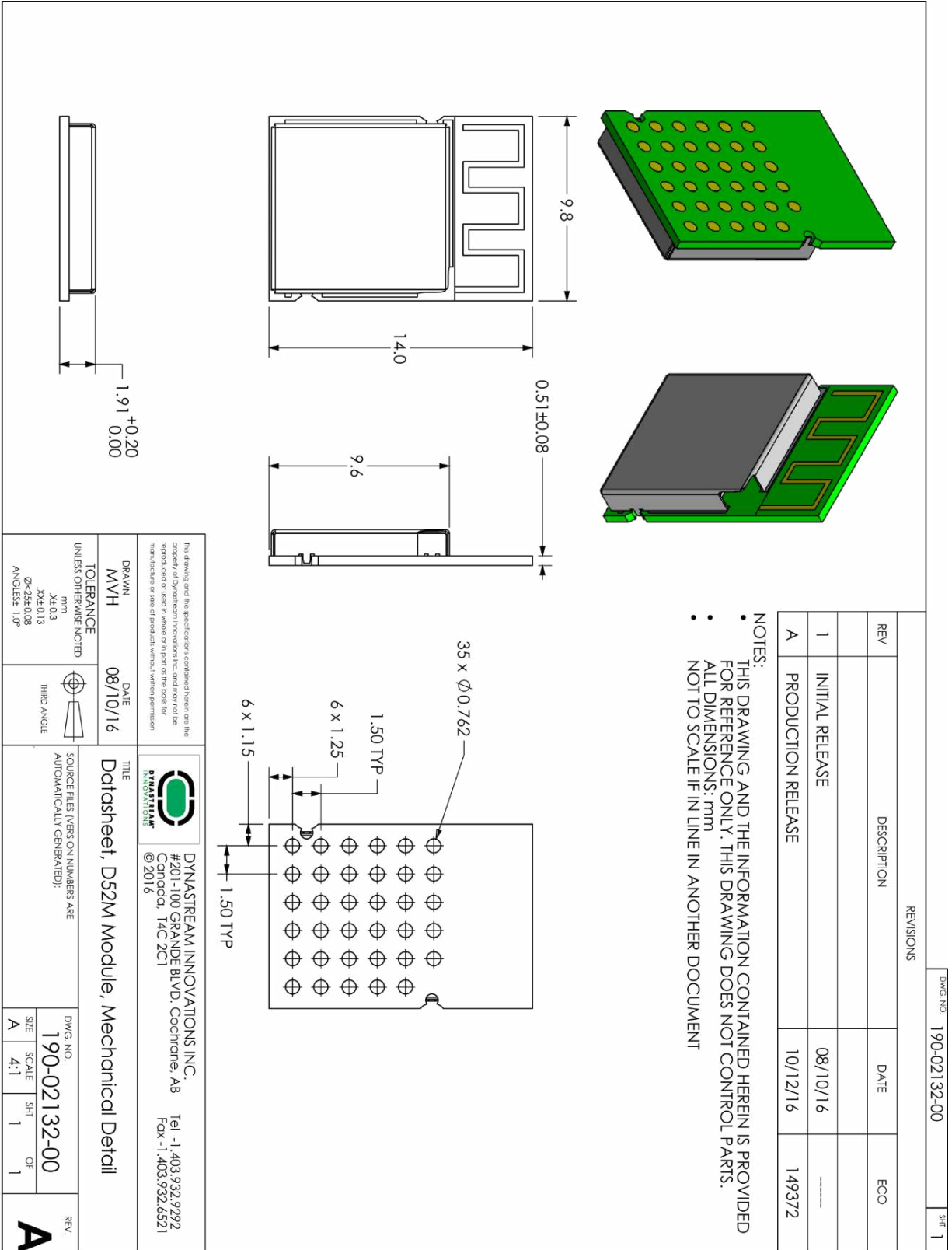

Figure 20: D52M M8 Mechanical Drawing

7 Support

The D52 ANT SoC module series uses nRF52832 from Nordic Semiconductor. You can seek technical support from Nordic Semiconductor, www.nordicsemi.com. Application support can be sought from Garmin, via www.thisisant.com.

7.1 ANT Forum

Customers are encouraged to participate in the ANT forum moderated by the application engineering team of Garmin Canada for any engineering discussions. Joining the ANT forum is free and open at <http://www.thisisant.com/forum>.

7.2 Technical References

Documents

1. nRF52832 Product Specification, Nordic Semiconductor
2. nRF52 Series Compatibility Matrix, Nordic Semiconductor Infocenter
3. nRF52832 Objective Product Specification, Nordic Semiconductor
4. nRF52832 S212 SoftDevice Specification, Dynastream Innovations
5. nRF52832 S332 SoftDevice Specification, Dynastream Innovations
6. nRF52832 S132 SoftDevice Specification, Nordic Semiconductor
7. nRF52 Development Kit Documentation, Nordic Semiconductor Infocenter
8. ANT SoC Module Starter Kit User Manual, Dynastream Innovations
9. ANT Message Protocol and Usage, Dynastream Innovations
10. Interfacing with ANT General Purpose Chipsets and Modules, Dynastream Innovations
11. ANT Technical Note – Migrating an ANT nRF51 Project to nRF52
12. Application Note: Interpreting RF Radiation Patterns, Dynastream Innovations

Software

1. S212 nRF52832 SoftDevice, Dynastream Innovations
2. S332 nRF52832 SoftDevice, Dynastream Innovations
3. S132 nRF52832 SoftDevice, Nordic Semiconductor
4. nRF5 SDK, Nordic Semiconductor
5. ANT Network Processor Application Code
6. ANTwareII – a system testing and debugging tool, Dynastream Innovations
7. ObservANT – an ANT debugging tool, Dynastream Innovations

Design models

1. D52Q Altium library, Dynastream Innovations
2. D52Q module STEP model, Dynastream Innovations
3. D52M Altium library, Dynastream Innovations
4. D52M module STEP model, Dynastream Innovations

The above documents and software are available at www.thisisant.com and/or [www.nordicsemi.com / infocenter.nordicsemi.com](http://www.nordicsemi.com/infocenter.nordicsemi.com). User registration may be required.

7.3 ANT Developer's Zone

ANT development software tools, application notes, reference designs and other public resources are found in the ANT Developer's Zone at <http://www.thisisant.com/developer>.

To begin development with the ANT+ interoperability, please become an ANT+ Adopter or ANT+ Alliance member to obtain the access to the ANT+ Adopter Zone. ANT+ documents and design tools contained in the ANT+ Adopter zone include the ANT+ Device Profiles, ANT-FS specification, ANT software (PC/Mac) libraries with source code, simulator tools (SimulANT+), ObservANT, embedded reference designs with source code, and more.

7.4 ANT and ANT+ Social Media

Further information, resources and news about ANT can be found in social media:

- YouTube: <http://www.youtube.com/user/ANTAlliance>
- Twitter: <http://twitter.com/ANTPlus>
- Facebook: <https://www.facebook.com/thisisant>
- LinkedIn: <http://www.linkedin.com/groups?gid=1379137>

Appendix A – Using the ANT Network Processor Configuration

D52 modules are preloaded with a default ANT network processor reference code image in the application code space of the nRF52832. Using this configuration is similar to ANT legacy ICs or modules, as illustrated in the diagram below. This reference code is available upon request.

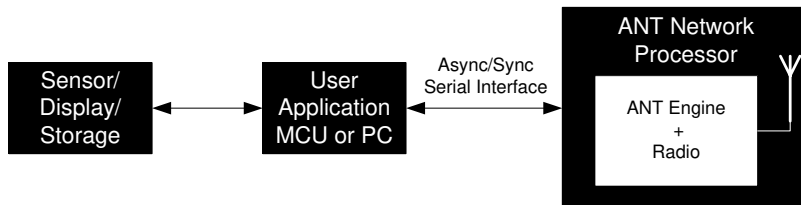

Figure 21: Using ANT Network Processor

With this configuration, the D52Q M4 model is basically drop-in compatible with ANT11TS33M4/5IB, ANTAP281M4/5IB, ANTC782M4/5IB modules, N5150M4CD, N550M4CC and N548M4CB modules (see 2.3: Pin-outs for complete details). Please note that C7 and AP2 modules supported bit synchronous, while the D52 Module Series do not. Byte synchronous and asynchronous are supported by the D52 Module Series network processor application.

For information regarding ANT network processor serial interfaces, please refer to document “Interfacing with ANT General Purpose Chipsets and Modules”.

Pin Assignments in the ANT Network Processor Configuration

In the pre-loaded ANT network processor configuration, specific functions are assigned to module pins. Details are summarized below (Table 12 for D52Q pin assignments, Table 13 for D52M pin assignments). **Note:** For the D52Q Network Processor configuration, pins P201 – P217 are not used (no connection):

D52Q M4 Pin	D52Q M6 Molex Connector	nRF52832 Pin Name	ANT Network Processor Pin Assignments			
			Pin Name	Async Mode	Sync Mode	Function
H202	10	P021/nRESET	nRST	nRST	nRST	Reset the device
H203	1	VCC	VCC	VCC	VCC	Power supply source
H204	19	VSS	GND	GND	GND	Power supply ground
H206	17	P006	nSUSPEND / nSRDY	nSUSPEND	nSRDY	Async → Suspend control Sync → Serial port ready
H207	15	P007	SLEEP / nMRDY	SLEEP	nMRDY	Async → Sleep mode enable Sync → Message ready indication
H209	11	P008	PORTSEL	Tie to GND	Tie to VCC	Asynchronous or synchronous port select
H210	7	P011	BR2/SCLK	BR2	SCLK	Async → Baud rate selection Sync → Clock output signal
H211	4	P017	TXD0 / SOUT	TXD0	SOUT	Async → Transmit data signal Sync → Data output
H212	3	P016	RXD0 / SIN	RXD0	SIN	Async → Receive data signal Sync → Data input
H213	5	P015	BR1	BR1	Unused	Async → Baud rate selection Sync → Not used
H214	9	P014	BR3 / SPD_SEL	BR3	SPD_SEL	Async → Baud rate selection Sync → Clock speed Selection
H217	2	P012	RTS/SEN	RTS	SEN	Async → Request to send Sync → Serial enable signal

Table 12: Pin Assignments in ANT Network Processor Configuration on D52Q models

D52M M8 Pin	nRF52832 Pin Name	ANT Network Processor Pin Assignments			
		Pin Name	Async Mode	Sync Mode	Function
P207	P021/nRESET	nRST	nRST	nRST	Reset the device
P225, P226, P219, P220	VCC	VCC	VCC	VCC	Power supply source
P231, P232, P233, P234, P235	VSS	GND	GND	GND	Power supply ground
P215	P022	nSUSPEND / nSRDY	nSUSPEND	nSRDY	Async → Suspend control Sync → Serial port ready
P202	P028	SLEEP / nMRDY	SLEEP	nMRDY	Async → Sleep mode enable Sync → Message ready indication
P208	P002	PORTSEL	Tie to GND	Tie to VCC	Asynchronous or synchronous port select
P213	P024	BR2/SCLK	BR2	SCLK	Async → Baud rate selection Sync → Clock output signal
P217	P014	TXD0 / SOUT	TXD0	SOUT	Async → Transmit data signal Sync → Data output
P218	P008	RXD0 / SIN	RXD0	SIN	Async → Receive data signal Sync → Data input
P210	P003	BR1	BR1	Unused	Async → Baud rate selection Sync → Not used
P212	P006	BR3 / SPD_SEL	BR3	SPD_SEL	Async → Baud rate selection Sync → Clock speed Selection
P205	P031	RTS/SEN	RTS	SEN	Async → Request to send Sync → Serial enable signal

Table 13: Pin Assignments in ANT Network Processor Configuration on D52M models

Asynchronous Serial Mode

The baud rate of the asynchronous communication is controlled by the speed select signals BR1, BR2 and BR3. Please refer to the table below.

BR3	BR2	BR1	Baud Rate
1	1	0	2400
0	0	0	4800
1	0	1	9600
0	1	0	19200
0	0	1	38400
0	1	1	57600
1	1	1	57600
1	0	0	115200

Table 14: Asynchronous Serial Mode Baud Rate Select

Byte Synchronous Serial Mode

The clock speed of the byte-Sync mode can be set to either 500KHz or 4MHz by setting BR3. Please refer to the table below.

SPD-SEL	Byte-Sync Speed
0	500KHz
1	4MHz

Table 15: Byte-Sync Mode Speed Selection

Byte Synchronous Mode Connection Example

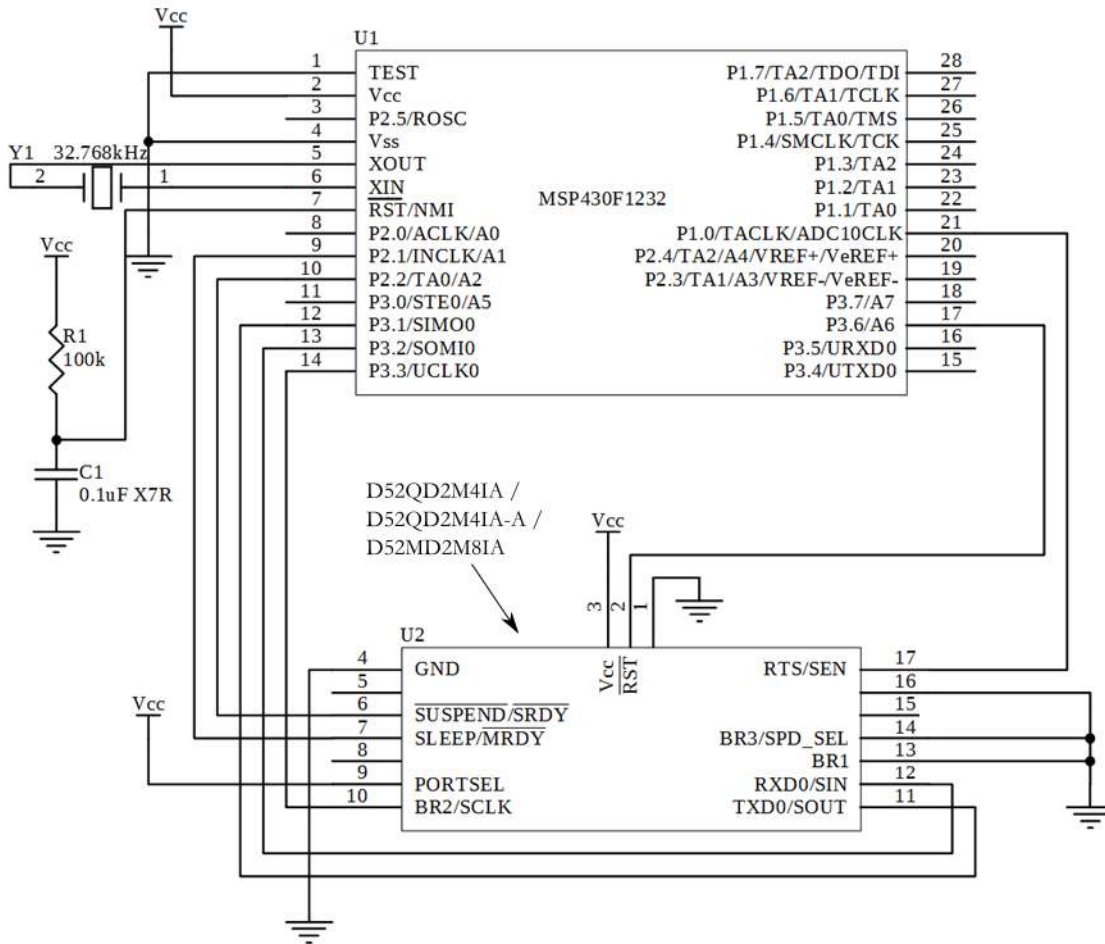

Figure 23: D52Q M4 ANT NP Configuration Byte Sync Connection

Notes:

- Module SOUT, SIN, and SCLK connected directly to hardware USART of microcontroller.
- SEN needs to be on an interrupt capable I/O pin on the microcontroller. (Interrupt pins located on Port 1&2 on the MSP430F1232)

DC/DC Configuration

The pre-programmed ANT Network Processor Application provides a method of configuring the DC/DC converter on the module via Serial Command. This allows modules featuring compatible ICs to use the DC/DC features of the nRF52832. Please refer to the nRF52832 Product Specification for details on the DC/DC. DC/DC should only be used on appropriate modules.

The following serial command message has been defined in the ANT network processor code. A host microcontroller can issue this command to the ANT network processor application to configure the DC/DC operation on the D52Q module.

Sync	Length	MsgID		Payload	Chksum
	0x02	0xE4	0x01	0x00 – DC/DC Disable 0x01 – DC/DC Enable	

Table 16: ANT DC/DC Configuration Command

After issuing the command, the following response is generated.

Sync	Length	MsgID				Response	Chksum
	0x04	0xE0	0x00	0xE4	0x01	0x00	

Table 17: ANT DC/DC Configuration Response

Note: Sync and Chksum values are defined in the document “Interfacing with ANT General Purpose Chipsets and Modules”.

A response of 0x00 indicates successful configuration of the DC/DC.

Appendix B – D52 Module Series Pre-Loaded Software Versions

D52 Series Model	Tracking Code ¹⁰	S212 ANT SoftDevice version from Garmin	ANT Network Processor Application Version
D52Q D2 M4IA, D52Q D2 M4IA-A	YW 2 , YWA	V 1.0.2	D52Q V 1.0.0
D52Q D2 M4IA, D52Q D2 M4IA-A	YW B	V 2.0.0	D52Q V 2.0.0
D52M D2 M8IA	YW 4 , YWB, YWC	V 2.0.0	D52M V 1.0.0
D52Q PMM 4IA, D52Q PMM 4IA-A	YWA	V 4.0.5	D52Q V 2.0.0
D52M PMM 8IA	YWA	V 4.0.5	D52M V 1.0.0
D52Q D2 M4IA, D52Q D2 M4IA-A	YWC	V 5.0.0	D52Q V 3.0.0
D52M D2 M8IA	YWD	V 5.0.0	D52M V 2.0.0
D52Q PMM 4IA, D52Q PMM 4IA-A	YWB	V 5.0.0	D52Q V 3.0.0
D52M PMM 8IA	YWB	V 5.0.0	D52M V 2.0.0

Table 18: D52 Preloaded Software Versions

¹⁰ YW refers to the year and week of manufacture, the third character represents the revision. See section 1.2 - Production Tracking Code for more information.