

Base strip - GMSTB 2,5/ 5-G - 1766042

Please be informed that the data shown in this PDF Document is generated from our Online Catalog. Please find the complete data in the user's documentation. Our General Terms of Use for Downloads are valid (<http://phoenixcontact.com/download>)

Header, Nominal current: 12 A, Rated voltage (III/2): 630 V, Number of positions: 5, Pitch: 7.5 mm, Color: green, Contact surface: Tin, Assembly: Soldering



The figure shows a 10-position version of the product

Product Features

- Versions with threaded flange and 7.62 mm pitch
- Plug-in direction parallel to the PCB
- Headers with angled solder pins for 630 V applications (III/2)



Key commercial data

Packing unit	1 pc
GTIN	 4 017918 032067
Weight per Piece (excluding packing)	2.92 GRM
Custom tariff number	85366990
Country of origin	Germany

Technical data

Dimensions

Length	12 mm
Pitch	7.5 mm
Dimension a	30 mm
Pin dimensions	1 x 1 mm
Hole diameter	1.4 mm

General

Range of articles	GMSTB 2,5/..-G
-------------------	----------------

Base strip - GMSTB 2,5/ 5-G - 1766042

Technical data

General

Insulating material group	I
Rated surge voltage (III/3)	6 kV
Rated surge voltage (III/2)	6 kV
Rated surge voltage (II/2)	6 kV
Rated voltage (III/3)	400 V
Rated voltage (III/2)	630 V
Rated voltage (II/2)	630 V
Connection in acc. with standard	EN-VDE
Nominal current I _N	12 A
Maximum load current	12 A
Insulating material	PA
Inflammability class according to UL 94	V0
Color	green
Number of positions	5

Classifications

eCl@ss

eCl@ss 4.0	272607xx
eCl@ss 4.1	27260701
eCl@ss 5.0	27260701
eCl@ss 5.1	27260701
eCl@ss 6.0	27260704
eCl@ss 7.0	27440402
eCl@ss 8.0	27440402

ETIM

ETIM 3.0	EC001121
ETIM 4.0	EC002637
ETIM 5.0	EC002637

UNSPSC

UNSPSC 6.01	30211810
UNSPSC 7.0901	39121409
UNSPSC 11	39121409
UNSPSC 12.01	39121409
UNSPSC 13.2	39121409

Base strip - GMSTB 2,5/ 5-G - 1766042

Approvals

Approvals

Approvals

CSA / UL Recognized / VDE Gutachten mit Fertigungsüberwachung / cUL Recognized / GOST / IECCEB Scheme / GOST / CCA / cULus Recognized

Ex Approvals

Approvals submitted

Approval details

CSA 		
	B	D
Nominal current I _N	10 A	10 A
Nominal voltage U _N	300 V	300 V

UL Recognized 		
	B	D
Nominal current I _N	15 A	10 A
Nominal voltage U _N	300 V	300 V

VDE Gutachten mit Fertigungsüberwachung 		
Nominal current I _N	12 A	
Nominal voltage U _N	400 V	

Base strip - GMSTB 2,5/ 5-G - 1766042

Approvals

cUL Recognized		
	B	D
Nominal current I _N	15 A	10 A
Nominal voltage U _N	300 V	300 V

GOST	
------	--

IECEE CB Scheme	
Nominal current I _N	12 A
Nominal voltage U _N	400 V

GOST	
------	--

CCA	
Nominal current I _N	12 A
Nominal voltage U _N	400 V

cULus Recognized	
------------------	--

Drawings

Base strip - GMSTB 2,5/ 5-G - 1766042

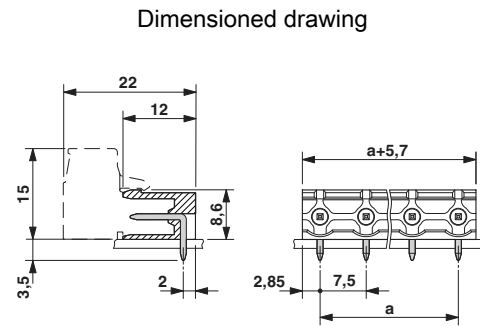
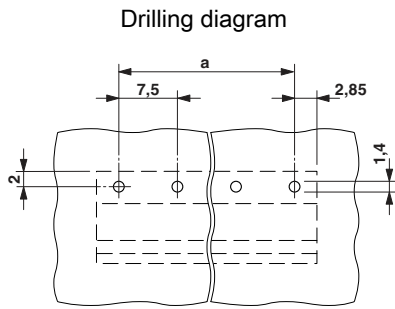

Diagram

Plug:
Header:

FRONT-GMSTB 2,5/5-ST(F)-7,62
GMSTB(A) 2,5/5-G(F)-(7,62)

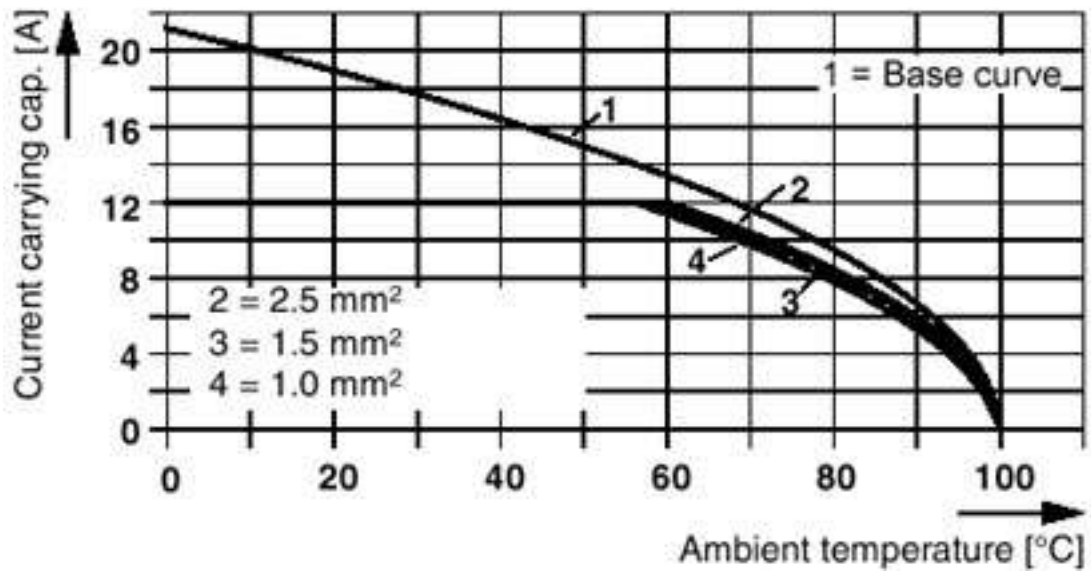

Base strip - GMSTB 2,5/ 5-G - 1766042

Diagram

Plug: GMSTBVR(W) 2,5/5-ST(F)(-7,62)
Header: GMSTB(A) 2,5/5-G(F)-(7,62)

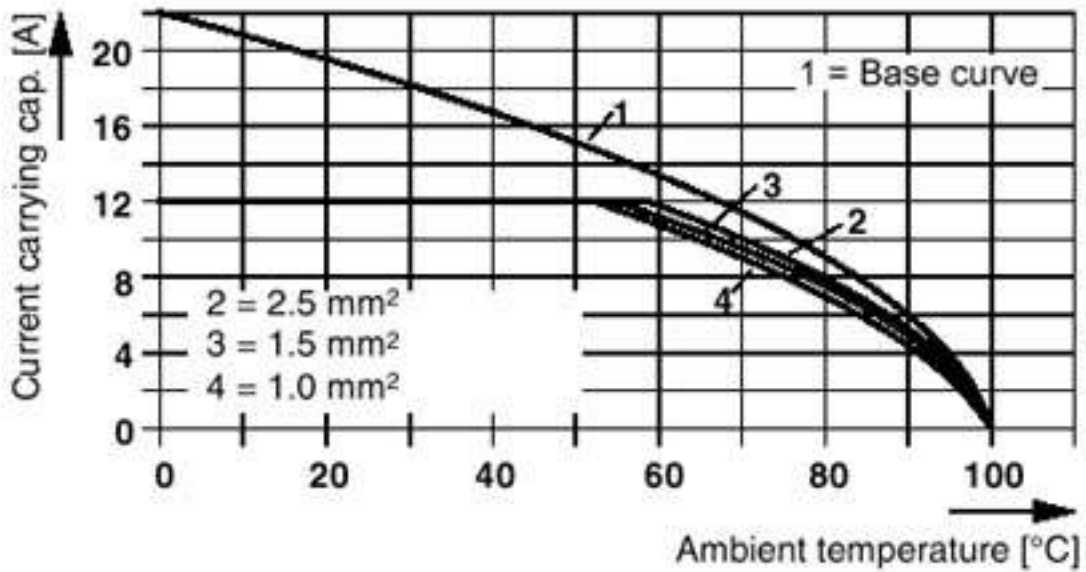

Diagram

Plug: GFKC 2,5/5-ST(F)(-7,62)
Header: GMSTB(A) 2,5/5-G(F)-(7,62)

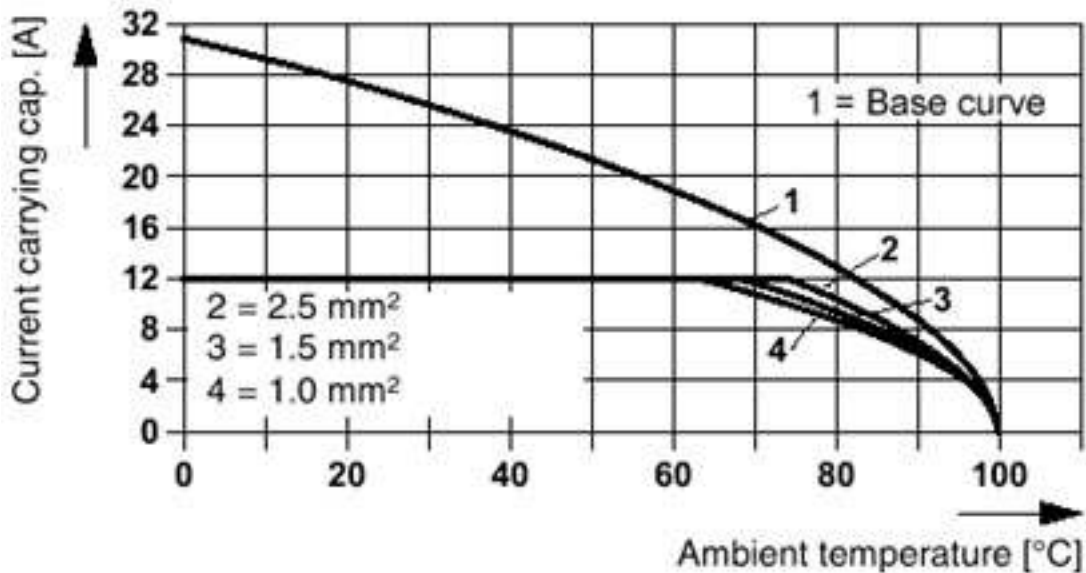

Base strip - GMSTB 2,5/ 5-G - 1766042

Diagram

Plug: GMSTB 2,5/5-ST(F)-(-7,62)
Header: GMSTB(A) 2,5/5-G(F)-(-7,62)

