

CRD5463PM Power Monitor Reference Design and Software

Features

- Easy Plug-and-play Design
- USB Communication with PC
- Real-time Measurements:
 - Line Voltage
 - Load Current
 - Active Power
 - Reactive Power
 - Apparent Power
 - Power Factor
 - Line Frequency
 - Temperature
- Operational Voltage: 90 ~ 260 VAC
- Maximum Load Current: 15 A RMS
- Active Power Measurement Accuracy:
 - 0.2%, 3 ~ 3900 W
- Lab Windows™/CVI™ GUI Software
- Factory Calibrated, Re-calibration Capable

General Description

The CRD5463PM demonstrates the CS5463 power measurement IC. It has an integrated AC-DC power supply, voltage and current sensors, and isolated UART/USB interface. Working with the GUI software, it provides accurate real-time measurements of line voltage, load current, line frequency, active power, reactive power, apparent power, power factor, and temperature.

The CRD5463PM includes two power cords, a USB cable, and a plug adaptor. When used with a PC, the CRD5463PM immediately becomes a high-precision power meter. The UART interface communication protocol, GUI, and MCU software source codes are also available from Cirrus Logic. The CRD5463PM is a useful design reference and evaluation tool for customers to develop power metering/monitoring systems that use the CS5463 IC.

ORDERING INFORMATION

CRD5463PM Power Monitor Reference Design

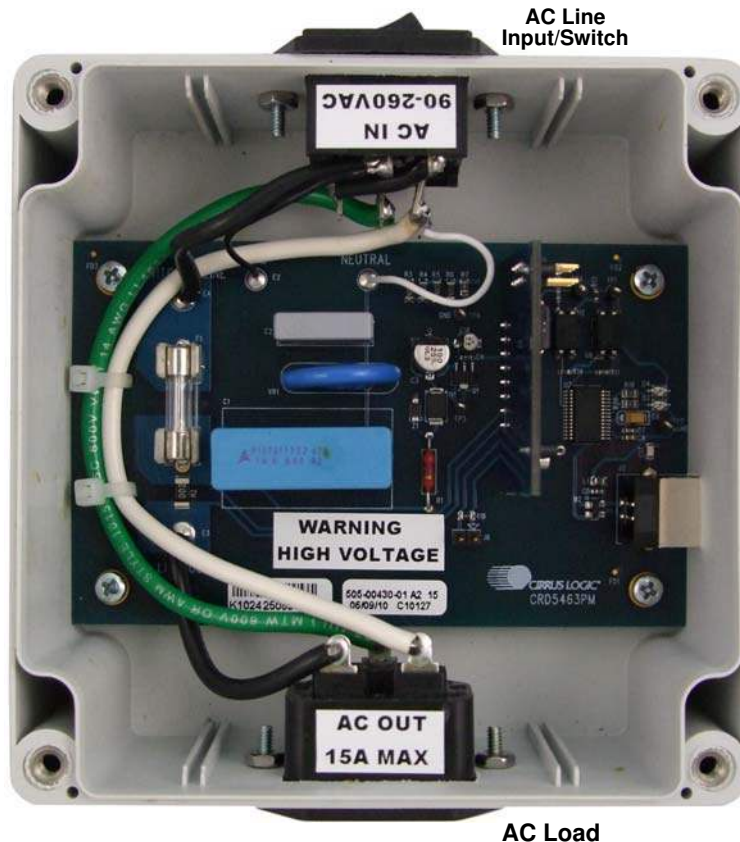

Actual Size:
120mm x 120mm x 60mm

1. CHARACTERISTICS AND SPECIFICATIONS

1.1 Recommended Operating Conditions

Parameter	Symbol	Min	Typ	Max	Unit
Voltage Range	V_{AC}	90	-	260	V
Current Range					
RMS Current	I_{rms}	-	-	15	A
Peak Current	I_{peak}	-	-	22	A
Frequency Range	Freq	5		2000	Hz
Operating Temperature	T_A	-40	-	+85	°C

1.2 Electrical Characteristics

Parameter	Symbol	Min	Typ	Max	Unit
Power Consumption (Note 1)					
Current Consumption	I_{AC}	-	79	-	mA
Power Consumption	P_{AC}	-	2.3	-	W
Accuracy (Note 2)					
RMS Voltage Measurement (90 ~ 260 VAC)	V_{accu}	-	±0.1	-	%
RMS Current Measurement (30 mA ~ 15 A)	I_{accu}	-	±0.2	-	%
Active Power Measurement (3 W ~ 3900 W)	P_{accu}	-	±0.2	-	%
Measurement Bandwidth	BW	-	-	2	kHz

NOTES:

1. Measured at $V_{AC} = 240\text{ V}$ and $T_A = 25^\circ\text{ C}$.
2. Measured at $T_A = 25^\circ\text{ C}$ and $PF=1$.



WARNING High Voltage Hazard



**When the CRD5463PM is connected to AC lines, high voltage is present inside the box.
DO NOT REMOVE THE PROTECTIVE COVER FROM THE CRD5463PM WHEN POWER IS CONNECTED.**

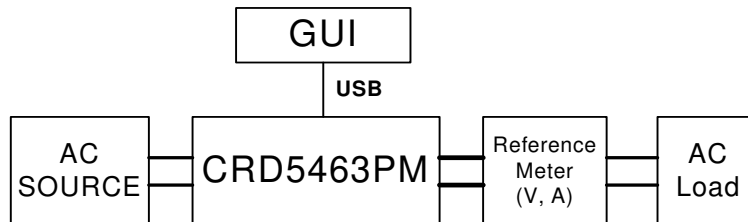

Figure 1. Calibration and Test Connection Diagram

NOTES:

1. Voltage drop and power loss in the cable connecting the CRD5463PM and the reference meter may introduce additional error.
2. The measurement bandwidth of the CS5463 is 2 kHz. At low power factor, the CRD5463PM may measure lower current and higher power factor than the reference meter if the reference meter has a measurement bandwidth greater than 2 kHz.
3. When testing at low power factor, the peak load current shall never exceed 22 A.

2. SYSTEM OVERVIEW

As illustrated in Figure 1, the CRD5463PM is composed of voltage and current sensors, a CS5463 power measurement device, an ATtiny2313 microcontroller, opto-coupler isolation, and UART-USB converter.

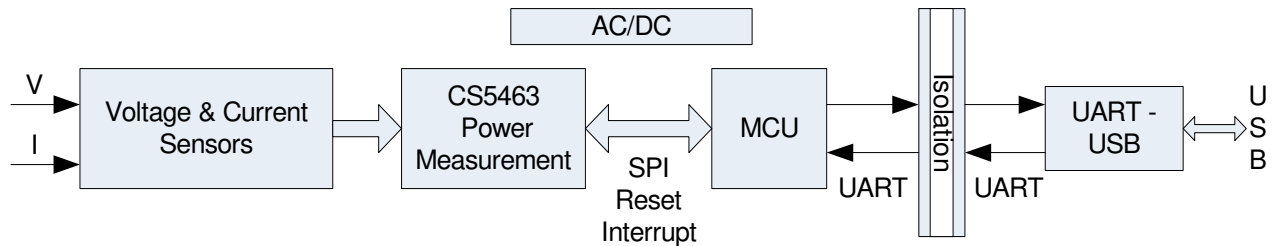

Figure 2. CRD5463PM Simplified Block Diagram

2.1 DC Power Supplies

There are two isolated +5V DC power domains in the CRD. One is converted from AC power lines through capacitor-dropper AC/DC power supply and provides +5VDC supply to the CS5463 and MCU. The other is directly from PC through USB interface and provides +5VDC to the UART-USB converter.

This capacitor type of DC power supply is very low-cost but not efficient. Total power consumption drew from the AC line is 2.3 Watt and 79mA (tested with 240 VAC input).

2.2 Voltage Sensor

The high AC line voltage must be converted to small voltage signal before being applied onto the CS5463 voltage channel inputs ($V_{IN\pm}$). The CRD5463PM uses resistor voltage divider as the voltage sensor.

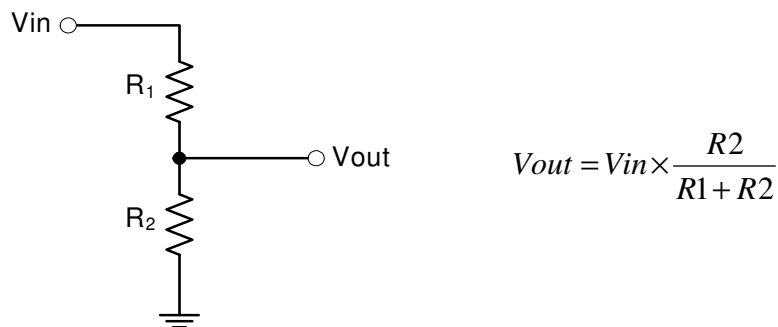

Figure 3. CRD5463PM Resistive Divider Voltage Sensor

The divider ratio is determined by the maximum V_{in} and the maximum input range of the CS5463 voltage channel. The maximum input range of the CS5463 voltage channel is 176 mV RMS. The division ratio shall be chosen to satisfy the equation:

$$V_{in \max} \times \frac{R2}{R1 + R2} < 176 \text{ mVrms}$$

To leave some margin, the V_{out} is normally set around 150 mVrms with the maximum V_{in} . In the CRD5463PM, $R2$ is 1 k Ω . $R1$ is composed of four 422 k Ω resistors to increase the total voltage rating of the voltage sensor.

When $V_{in} = 260 \text{ V RMS}$, $V_{out} = 260 \text{ V} \times 1 / [1 + (4 \times 422)] = 154 \text{ mV RMS}$.

2.3 Current Sensor

The AC load current must be converted into a low-level voltage signal before being applied to the CS5463. A shunt resistor is a very common choice for current sensing in power monitoring applications because it is inexpensive, small, linear, and normally doesn't introduce phase shift.

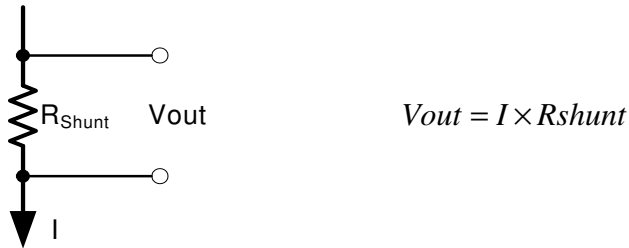

Figure 4. CRD5463PM Shunt Resistor Current Sensor

Benefiting from its 50x gain amplifier and the low noise level on the current channel, the CS5463 can accommodate the ultra low-value shunt to achieve both low power dissipation at high current and high accuracy at low current.

The shunt resistance is determined by the maximum peak load current (I_{peak}) and the CS5463 current channel's maximum input range. With the 50x PGA setting, the maximum input range of the CS5463's current channel is 50 mVp. Therefore, the Rshunt is chosen to satisfy the equation:

$$I_{peak} \times R_{shunt} < 50 \text{ mVp}$$

The power rating of the shunt should be at least twice the actual power dissipation of the shunt with the maximum continuous load current.

To measure the maximum of 15 A RMS and 23 A peak load current, the CRD5463PM uses a 2 mΩ, 1.5 W shunt resistor as the current sensor.

2.4 CS5463 Power Measurement IC

The power measurement device CS5463 is on the daughter board. The CS5463 is an integrated power measurement device which combines two $\Delta\Sigma$ analog-to-digital converter, power calculation engine and a serial interface on a single chip. The sensed line voltage and load current are first converted into 24-bit instantaneous values. The powerful on-chip DSP calculates voltage and current RMS values, active power, reactive power, apparent power, power factor, etc.

All these measurement values are available in specifically addressed 24-bit registers which can be accessed through SPI interface.

For more detailed information of the CS5463, please refer to the CS5463 datasheet.

http://www.cirrus.com/en/pubs/proDatasheet/CS5463_F2.pdf

2.5 ATtiny2313 Microcontroller

In addition to the CS5463 on the daughter board, an Atmel™ ATtiny2313 microcontroller is used to initialize the CS5463, convert the SPI into UART, and provide nonvolatile memory for the calibrations.

The ATtiny2313 is an MCU with SPI and UART interfaces, 2 kB Flash program memory and 128 bytes EEPROM data memory. The MCU acts as a communication bridge between the CS5463's SPI interface and the UART of the UART-to-USB converter. The EEPROM data memory is used to store calibration information.

The hardware connections between the ATtiny2313 and the CS5463 are $\overline{\text{RESET}}$, $\overline{\text{SCLK}}$, $\overline{\text{CS}}$, SDI, SDO, $\overline{\text{INT}}$ (interrupt), and connection-configurable clock signals. Through the population of the 0 ohms resistor R15 or R16, the clock source can be shared between the CS5463 and the ATtiny2313. In the current version of the CRD5463PM, the CS5463 and ATtiny2313 are configured to use their own clock sources. The CS5463 uses a 4.096 MHz crystal and the ATtiny2313 uses its internal 8 MHz R-C oscillator.

On the daughter board, connector J4 is provided for programming and debugging the ATtiny2313 MCU.



WARNING High Voltage Hazard



The signal ground for the daughter board is the power line.

DO NOT CONNECT ANY DEBUGGING OR PROGRAMMING TOOLS TO THE J4 CONNECTOR WHEN AC LINE POWER IS CONNECTED.

Please consult with Cirrus Logic engineering if re-programming the MCU is desired.

For more detailed information of ATtiny 2313, please refer to the ATtiny2313 datasheet.

2.6 Isolated UART

Because the CRD5463PM uses non-isolated components as the current and voltage sensors, the signal ground of the CS5463 and MCU is the live connection to the main power. However, the signal ground of the PC USB port is normally chassis ground or earth ground. The electrical isolation must be fulfilled on the UART communication interface to allow the CRD5463PM to be connected to a PC through a USB cable without short-circuit and safety problems. The CRD5463PM uses 2 opto-couplers to isolate the UART interface. The isolation rating is 5300 V RMS.

2.7 UART-USB Interface- FT232R

A USB-to-UART interface IC, FT232R, is used on the main board to interface the CRD to a PC as a virtual COM port through the USB connection.

3. SOFTWARE CONTROL

The CRD5463PM comes with GUI software and a USB cable to link the CRD to a PC. The GUI was developed with Lab Windows™/CVI™, a software development package from National Instruments Corporation. The GUI software is available for download on the Cirrus Logic web site at:

<http://www.cirrus.com/industrialsoftware>

The software was designed to run under Windows 2000™ or Windows XP® operating system.

4. INSTALLATION PROCEDURE

4.1 Software Installation Procedure

FTDI drivers must be installed before the GUI software is launched. Please refer to the following document for details of how to install the drivers.

4.1.1 GUI Installation

- 1) Go to Cirrus Industrial Software download website (<http://www.cirrus.com/industrialsoftware>).
- 2) Click the link for the GUI desired.
- 3) Download the file onto the PC and unzip it. A new folder will be created.
- 4) Open the new folder and run the *setup.exe* file.
- 5) Follow the instructions presented by the installation wizard.
- 6) To Run the GUI, navigate to:
Start > All Programs > Cirrus Power Monitoring Reference (CRD5463PM) > CRD5463PM

4.1.2 Driver Installation

Important: FTDI drivers must be installed before the GUI software is launched. Please refer to the following document for details of how to install the drivers.

[http://www.ftdichip.com/Documents/AppNotes/AN_104_FTDI_Drivers_Installation_Guide_for_WindowsXP\(FT_000093\).pdf](http://www.ftdichip.com/Documents/AppNotes/AN_104_FTDI_Drivers_Installation_Guide_for_WindowsXP(FT_000093).pdf)

4.2 Using the Software

Before launching the software, connect the CRD to an open USB port on the PC using the provided cable. Connect the CRD to the main power and the load using provided power cord and plug adaptor. Once the power has been switched on, the software program can be launched.

4.3 Main Window

When the software is launched, the Main window will appear. This window contains information concerning the software's title, revision number, copyright date, etc.

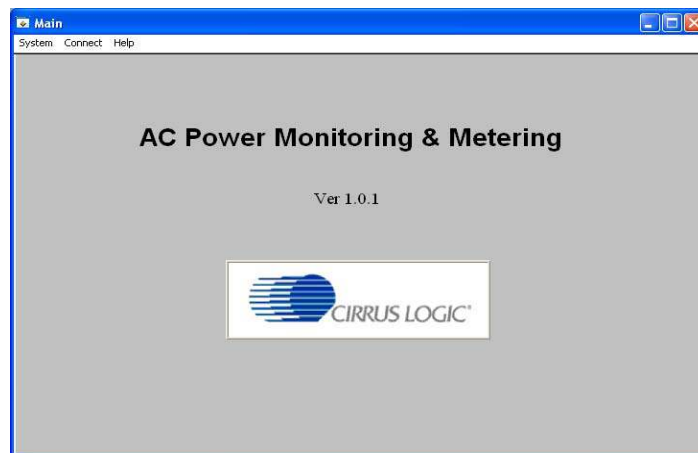

Figure 5. CRD5463PM GUI Main Window

At the top of the screen is a menu bar which displays user options. The menu bar has three items: *System*, *Connect*, and *Help*.

4.3.1 Connect Menu

The *Connect* menu allows user to establish a serial communication connection with CRD5463PM.

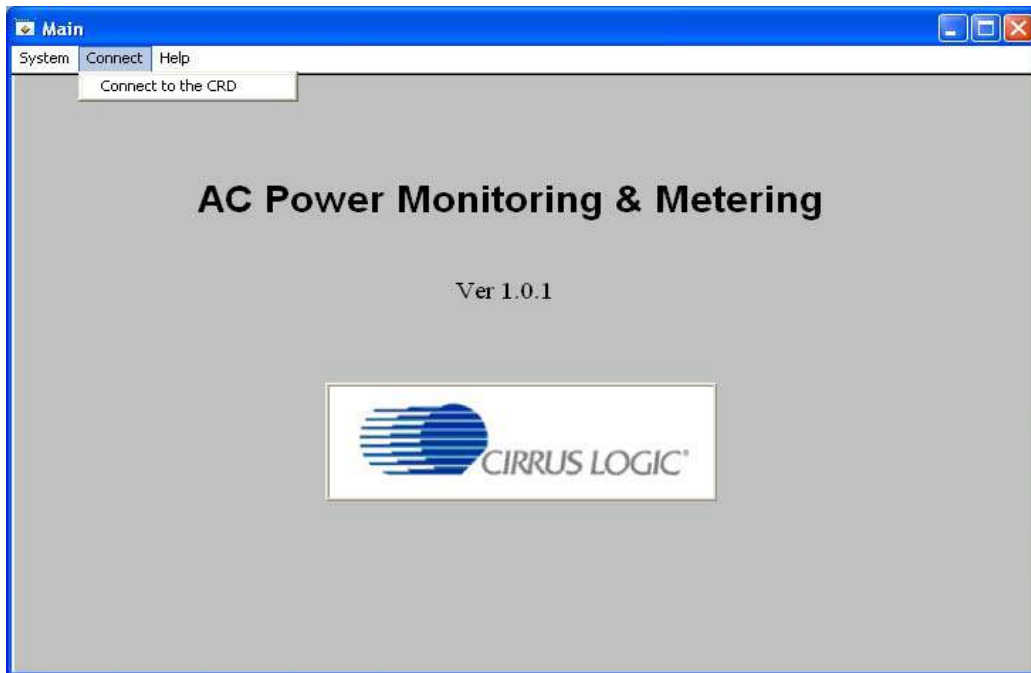

Figure 6. CRD5463PM GUI *Connect* Menu

4.3.2 System Menu

The *System* menu allows user to operate the power monitoring and re-calibrate the CRD when necessary.

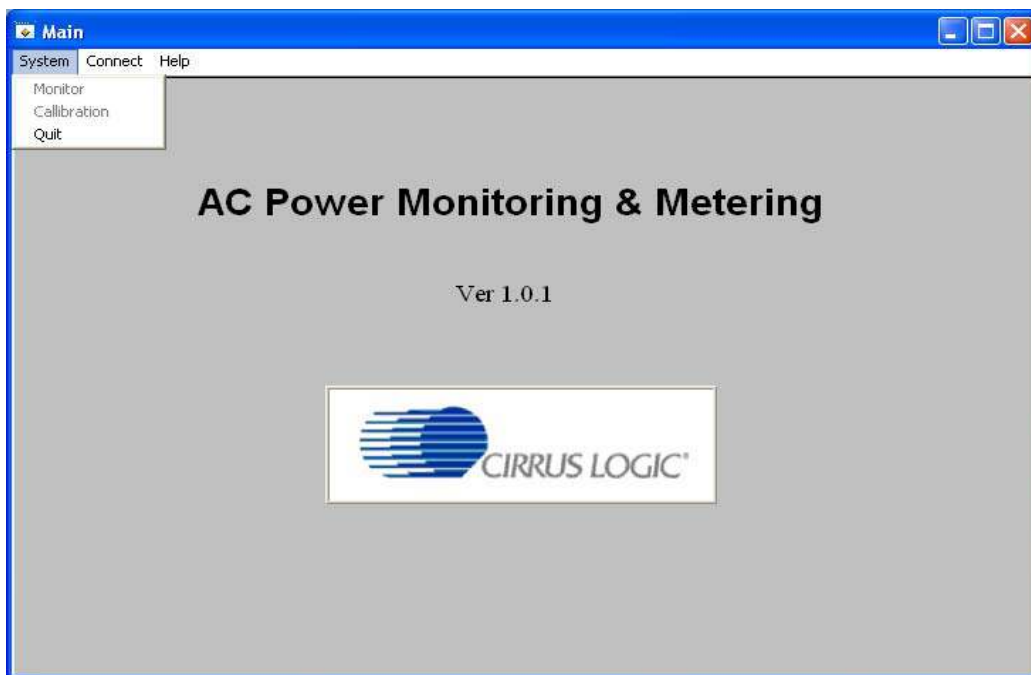

Figure 7. CRD5463PM GUI *System* Menu

Quit allows the user to exit the evaluation software. Upon selecting *Quit*, a message windows appears and queries if exiting the evaluation software is desired.

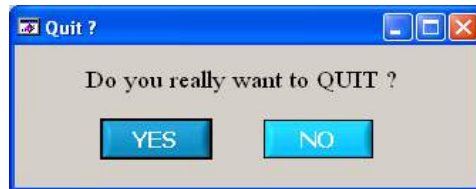

Figure 8. CRD5463PM GUI *Quit* Dialog

4.4 Connect

After *Connect to the CRD* is selected under this menu, a sub-window will appear.

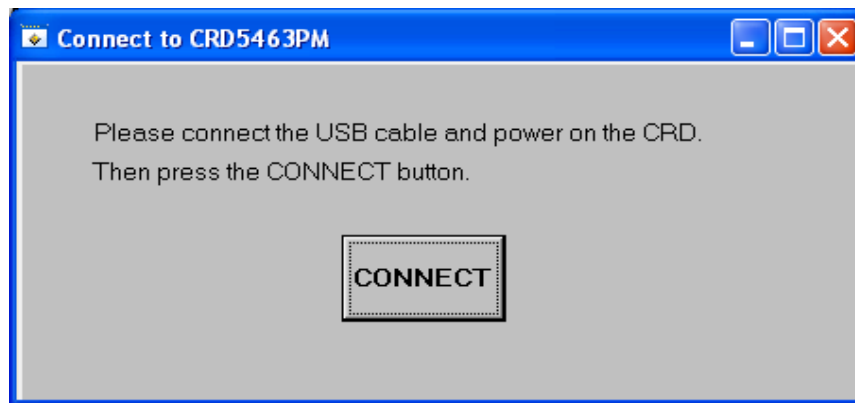

Figure 9. CRD5463PM GUI *Connect to CRD5463PM* Window

Follow the instructions on the *Connect to CRD5463PM* window and the *The CRD is connected.* message will pop up if the connection has been established correctly.



Figure 10. CRD5463PM GUI *Successful Connection* Message

Otherwise a error message will appear, indicating that the initial communication has failed.

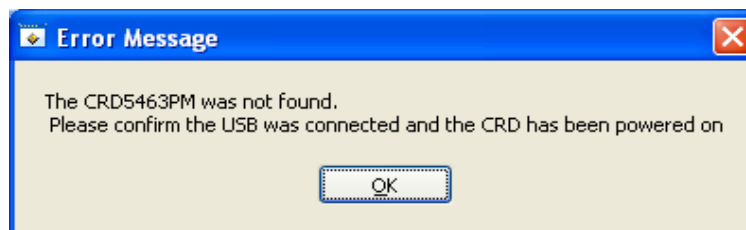

Figure 11. CRD5463PM GUI *Connection Error* Message

Check to verify that the USB cable and power cord are connected properly and the power switch is at the *ON* position.

4.5 Power Monitoring Window

After Monitor is selected under the System menu, the Power Monitoring window will appear. The Power Monitoring window provides the real time measurements.



Figure 12. CRD5463PM GUI *Power Monitoring* Window

4.5.1 START and STOP Buttons

To start power monitoring, click the green *START* button in the window. The CRD will start continuous analog-to-digital conversion, compute the power parameters every N samples, and send calculation results to the GUI. The GUI software receives the data block from the CRD through the connected USB port (virtual COM port), convert the raw register values into true power values based on the calibration information read from the MCU internal EEPROM, and display the final measurement results in the window.



Figure 13. *Power Monitoring* Window, Results Displayed

4.5.2 Define Fundamental Frequency

During initialization, the CS5463 is configured to measure the fundamental frequency automatically – the AFC bit of the Mode register is set by the MCU. The *Define Fundamental Frequency* selection box enables the user to disable the automatic frequency calculation function and define the specific line frequency by changing the Epsilon register value..



Figure 14. *Power Monitoring Window, Define Fundamental Frequency Menu*

4.5.3 Change Measurement Period

The power measurement period or register refreshing rate depends on the CS5463 sample rate and the configuration of the CS5463 CycleCount (N) register. By default, N is 4000 and the measurement period is 1 second. The Measurement Period selection box is used to change the CS5463 CycleCount register value (N) and therefore, change the measurement period.

Cycle Count (N)	Measurement Period (Seconds)	Refresh Rate (Hz)
8000	2	0.5
4000	1	1
2000	0.5	2
800	0.2	5
400	0.1	10



Figure 15. *Power Monitoring Window, Measurement Period Menu*

4.6 Calibration Window

When *Calibration* is selected from the *System* menu in the main window, the *Calibration* window will appear. The *Calibration* window is used to re-calibrate the CRD.

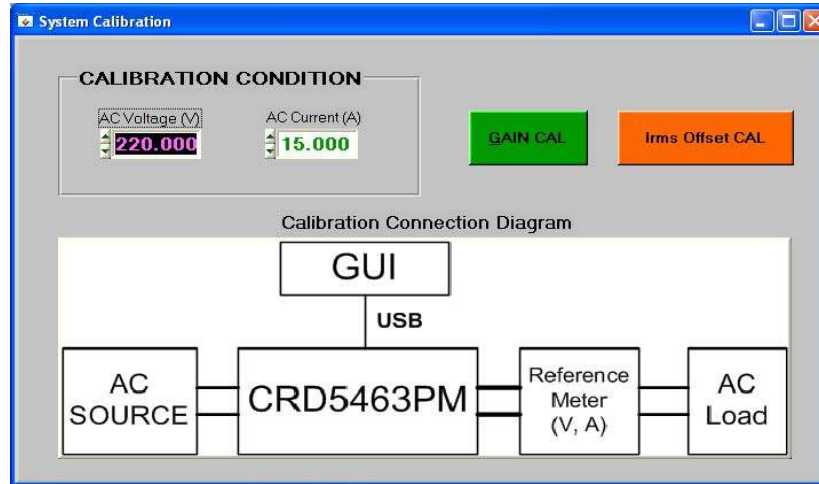

Figure 16. System Calibration Window

4.6.1 Calibration Connections

A stable AC source, an accurate reference power meter, and a stable AC load are needed for calibration. Follow the connection diagram in the *System Calibration* window to connect the equipment and CRD. To minimize calibration error introduced by the voltage drop on the connection wires, the power cable between the CRD and the reference meter should be as short and as large gauge as possible.

4.6.2 Irms Offset Calibration

The CRD5463PM Irms offset calibration is to detect and save the residual value in the Irms register when the load is zero. This value represents the current channel noise level of the CRD. In normal power monitoring operation, this offset will be removed from the Irms register readings. The GUI also forces all the power measurements to be zero if the Irms register value is smaller than the offset. Follow the procedure below to operate the Irms offset calibration.

- 1) Turn on the power source and adjust the voltage to the nominal operation voltage.
- 2) Switch on the CRD5463PM.
- 3) Launch the GUI.
- 4) Open the *System Calibration* window
- 5) Turn off or remove the AC load.
- 6) Click the *Irms Offset CAL* button, the GUI will prompt the following message to confirm the load has been removed from the system.

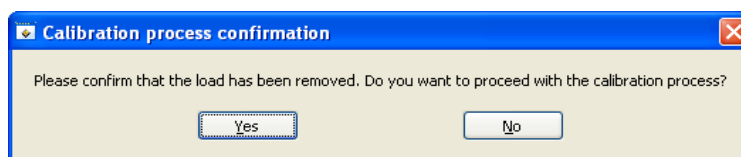

Figure 17. Calibration Process Confirmation Dialog

- 7) Click the *Yes* button to proceed with the calibration process.
- 8) Wait for the completion of the process. The Irms Offset calibration takes about 4 seconds.

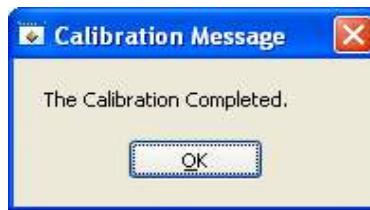

Figure 18. *Calibration Completed Dialog*

4.6.3 Gain Calibration

The CRD5463PM gain calibration process is to detect and save the Vrms and Irms register values and associated true voltage and current values. In normal power monitoring operation, the GUI will use these values to convert the raw register data into true measurement results. The CRD needs gain calibration under one voltage and load condition only. Follow the procedure below to operate the gain calibration.

- 1) Turn on the AC source and adjust the voltage to the nominal operation voltage.
- 2) Switch on the CRD5463PM.
- 3) Launch the GUI.
- 4) Open the *System Calibration* window.
- 5) Turn on the load. The power factor of the load should be 1 and the load level should be in the range of your accuracy interest.
- 6) Enter the calibration condition, AC voltage and AC current with the voltage and current measurements from the reference meter.
- 7) Click the *GAIN CAL* button. The following message will pop up.

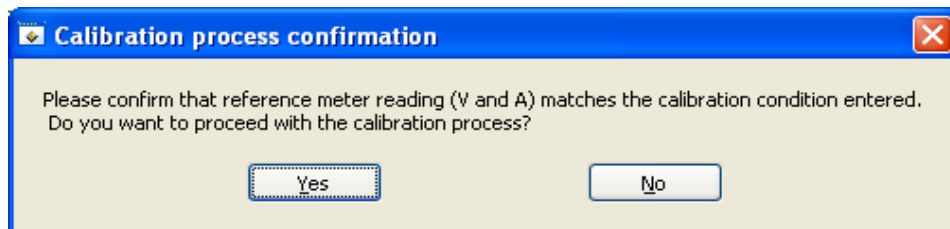

Figure 19. *Calibration Process Confirmation Dialog*

- 8) Wait for the completion of the process. The gain calibration takes about 5 seconds.

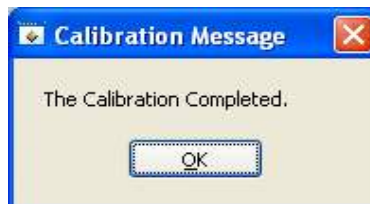
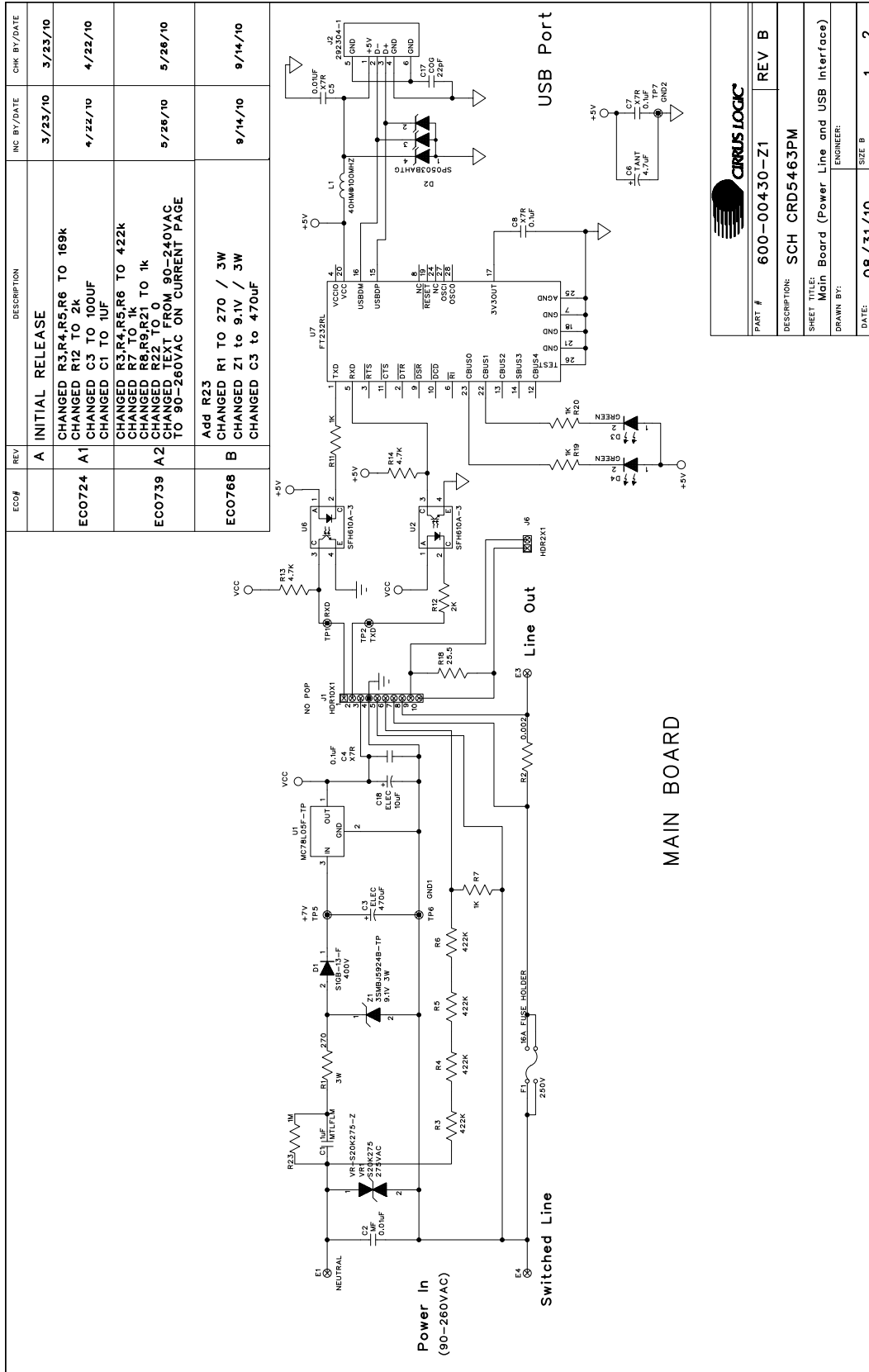

Figure 20. *Calibration Completed Dialog*

5. SCHEMATIC

Figure 21. Schematic (Page 1 of 2)

6. BILL OF MATERIALS
BILL OF MATERIAL

 CIRRUS LOGIC
 CRD5463PM-Z_REV_B

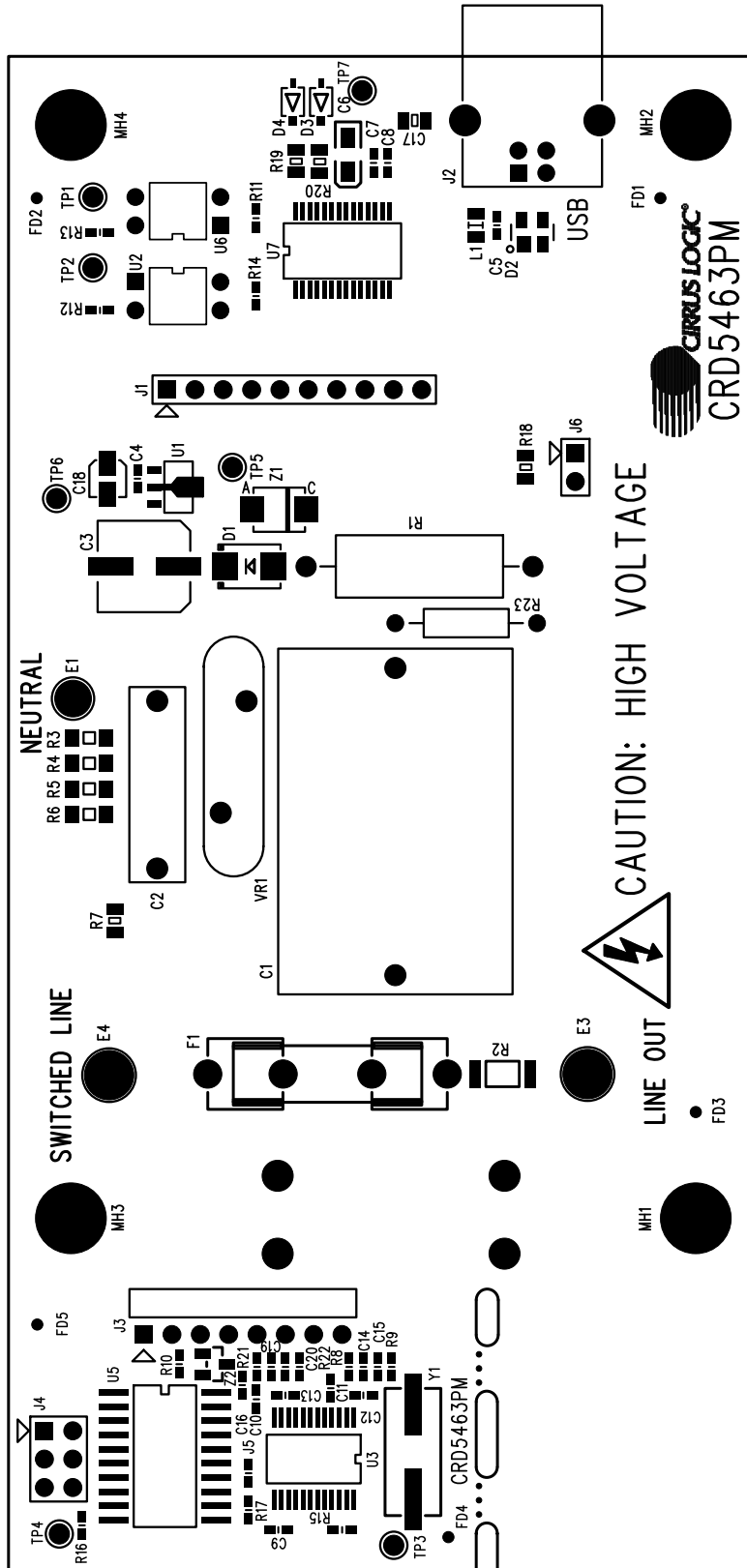
Item	Cirrus P/N	Rev	Description	Qty	Reference Designator	MFG	MFG P/N	Notes	Status
1	011-00052-21	A	CAP 1uF ±20% 440V MTL FLM NPb TH	1	C1	VISHAY	BFC233814105		P
2	011-00051-21	A	CAP 10nF ±20% 440V MTL FLM NPb TH	1	C2	VISHAY	EEE1CA471UP		A
3	012-00150-21	A	CAP 470uF ±20% 16V XTR NPb CASE F	7	C3	PANASONIC	EEE1CA471UP	ECO/768	A
4	001-00189-21	A	CAP 0.1uF ±10% 16V XTR NPb 0603	7	C4	KEMET	C0603C104K3RAC		A
5	001-00197-21	A	CAP 0.01uF ±10% 25V XTR NPb 0603	1	C5	KEMET	C0603C103K3RAC		A
6	004-00155-21	A	CAP 4.7uF ±10% 16V TANT NPb CASE A	1	C6	KEMET	T491AA75K016AS		A
7	001-00268-21	A	CAP 0.022uF ±10% 50V XTR NPb 0603	2	C12 C13	KEMET	C0603C223K5RAC		A
8	001-00268-21	A	CAP 0.022uF ±10% 50V XTR NPb 0603	4	C14 C15 C19 C20	KEMET	C0603C221K5RAC		A
9	001-00278-21	A	CAP 22pF ±10% 50V COG NPb 0805	1	C17	KEMET	C0805C220K5GAC		A
10	012-00012-21	A	CAP 10uF ±20% 16V ELEC NPb CASE A	1	C18	PANASONIC	EEE1CS100SR		P
11	070-00173-21	A	DIODE RECT 1A 400V NPb SMB	1	D1	DIODES INC	S1GB-13-F		A
12	070-00055-21	A	DIODE ARRAY 5V (TVS) ESD NPb SOT143	1	D2	LITTELFUSE	SP0503BAHTG		A
13	165-00005-21	A	LED CLR GRN 2.1V 1ma .16MCD NPb SMD	2	D3 D4	CHICAGO MINIATURE LAMP	CMD28-21VGC/TR8/T1		A
14	303-00008-21	A	FUSE CLIP PC MOUNT 5MM NPb	1	F1	KEYSTONE	3517	NEED 2 CLIPS PER FUSE	A
15	115-00010-21	A	HDR 10x1 ML 1°C TR S NPb GLD	0	J1	SAMTEC	TSW-110-07-G-S	DO NOT POPULATE	A
16	110-00041-21	A	CON RA USB BLK NPb TH	1	J2	AMP	292304-1		A
17	115-00011-21	A	HDR 8x1 ML 1°C TR 062 S GLD NPb	1	J3	SAMTEC	TSW-108-08-G-S-RA		A
18	115-00016-21	A	HDR 3x2 ML 1°C TR 062 S GLD NPb	1	J4	SAMTEC	TSW-103-07-G-D		A
19	020-00673-21	A	RES 0 OHM 1/10W ±5% NPb 0603 FILM	3	J5 R16 R22	DALE	CRCW0603000Z0EA		A
20	145-00044-21	A	HDR 2x1 ML 1" 062BD ST GLD NPb TH	1	J6	SAMTEC	TSW-102-07-G-S		A
21	145-00044-21	A	FE 1.5A 80 ohm@100MHz NPb 0805	1	L1	LAIRD	MI9805K400R-10		A
22	031-00054-21	A	SPCR STANDOFF 4.40 THR .500" L NPb	0	M1	KEYSTONE	2203	DO NOT POPULATE	A
24	020-06350-21	A	RES 270 OHM 3W ±5% MTL FLM NPb AXL	1	R1	PANASONIC	ERG3S4Z71		A
25	020-06350-21	A	RES 0.002 OHM 1.5W ±1% NPb 2010	1	R2	STACKPOLE	CSNL-1.0.002-1%-R		A
26	020-06352-21	A	RES 422k OHM 1/4W ±1% NPb 1206	4	R3 R4 R5 R6	DALE	CRCW1206422K4FKEA		A
27	020-01816-21	A	RES 1k OHM 1/8W ±1% NPb 0805 FILM	1	R7	DALE	CRCW08051K00FKEA		A
28	020-00788-21	A	RES 1k OHM 1/10W ±1% NPb 0603 FILM	3	R8 R9 R21	DALE	CRCW06031K00FKEA		A
29	021-00242-21	A	RES 1k OHM 1/10W ±1% NPb 0603 FILM	1	R10	DALE	CRCW06031K00FKEA		A
30	021-00249-21	A	RES 1k OHM 1/10W ±5% NPb 0603 FILM	1	R11	DALE	CRCW06031K00JNEA		A
31	021-00258-21	A	RES 2k OHM 1/10W ±5% NPb 0603 FILM	2	R12	DALE	CRCW06032K00JNEA		A
32	020-00673-21	A	RES 0 OHM 1/10W ±5% NPb 0603 FILM	0	R15	DALE	CRCW0603000Z0EA	DO NOT POPULATE	A
33	021-00278-21	A	RES 33k OHM 1/10W ±5% NPb 0603 FILM	1	R17	DALE	CRCW060333K0JNEA		A
34	020-01632-21	A	RES 25.5 OHM 1/8W ±1% NPb 0805 FILM	1	R18	DALE	CRCW080525R5FKEA		A
35	021-00411-21	A	RES 1k OHM 1/2W ±5% CARL NPb AXL	2	R19 R20	DALE	CRCW08051K00JNEA		A
37	110-00045-21	A	CON TEST PT 1°C TR T IN PLAT NPb BLK	7	R23	PANASONIC	ERD-S1TJ105V	ECO/768	A
38	060-00536-21	A	IC LNR 3TERM .1A POS VREG NPb SOT189	1	U1	MCC	MC78L05F-TP		A
39	175-00030-21	A	OPT COUPLER PHOTOTRANS NPb DIP4	2	U2 U6	VISHAY	SFH610A-3		A
40	065-00162-21	D	IC CRUS PWR/ENERGY MON NPb SSOP24	1	U3	CIRRUS LOGIC	CS5463-ISZD		A
41	062-00222-21	A	IC PGM MCU 8bit 2K FLASH NPb SOIC20	1	U7	ANALOG DEVICES	ATTINY2313-20SU		A
42	061-00368-21	A	IC USB SER UART 15ma NPb SSOP28	1	U7	FTDI	FT232RL		A
43	038-00014-21	A	VARIATOR 275V RMS 20MM NPb RAD	1	VR1	EPCOS	SZ0K275		A
44	100-00132-21	A	XTL 4.096MHz 30ppm 18pf NPb SMD	1	Z1	ABRACON	ABLS2-4.096MHZ-D4V-T		A
45	070-00185-21	A	DIODE ZEN 9.1V 3W NPb SMB	1	Z1	MCC	3SMEL5924B-TP	ECO/768	A
46	070-00171-21	A	DIODE TVS 6.1V 300V ESD NPb SOT123	1	Z2	MCC	ESD46V1L	ECO/768	A
47	240-00430-21	B	PCB CRD5463PM-Z NPb	1	REF	CIRRUS LOGIC	240-00430-Z1	ECO/768	A
48	600-00430-21	B	ASSEM DWG CRD5463PM	1	REF	CIRRUS LOGIC	600-00430-Z1	ECO/768	A
49	600-00430-21	B	SCHEM CRD5463PM	1	REF	CIRRUS LOGIC	600-00430-Z1	ECO/768	A
50	422-00013-01	B	LBL SUBASSY PRODUCT ID AND REV	1	REF	CIRRUS LOGIC	422-00013-01	ECO/768	A
51	180-00024-21	A	FUSE 16A 250V TLAG NPb 5x20MM	1	XF1	SCHURTER	0034-3129		A

7. BOARD LAYOUT

Figure 23. Component Placement (Top Silkscreen)

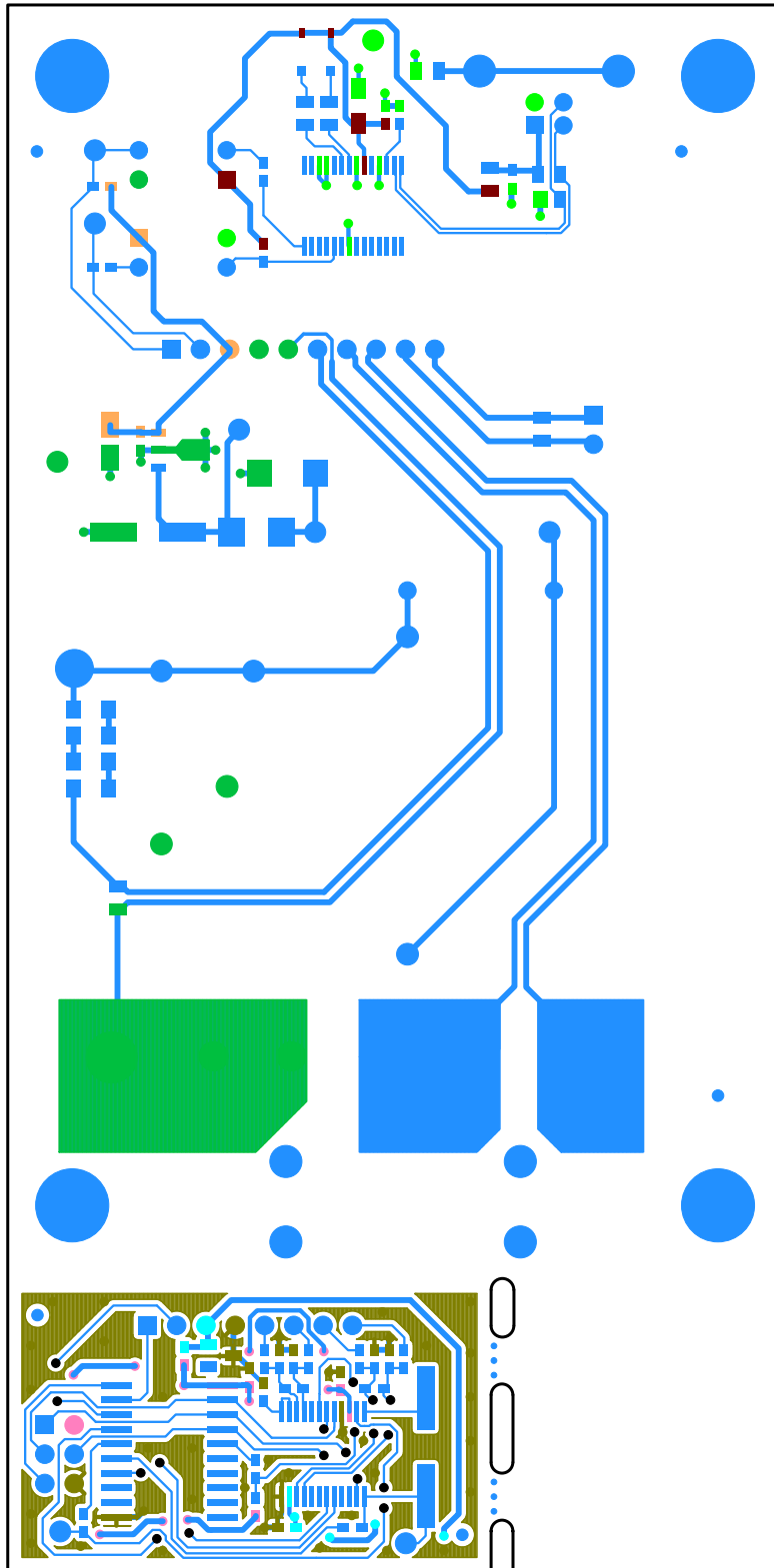

Figure 24. Top Routing

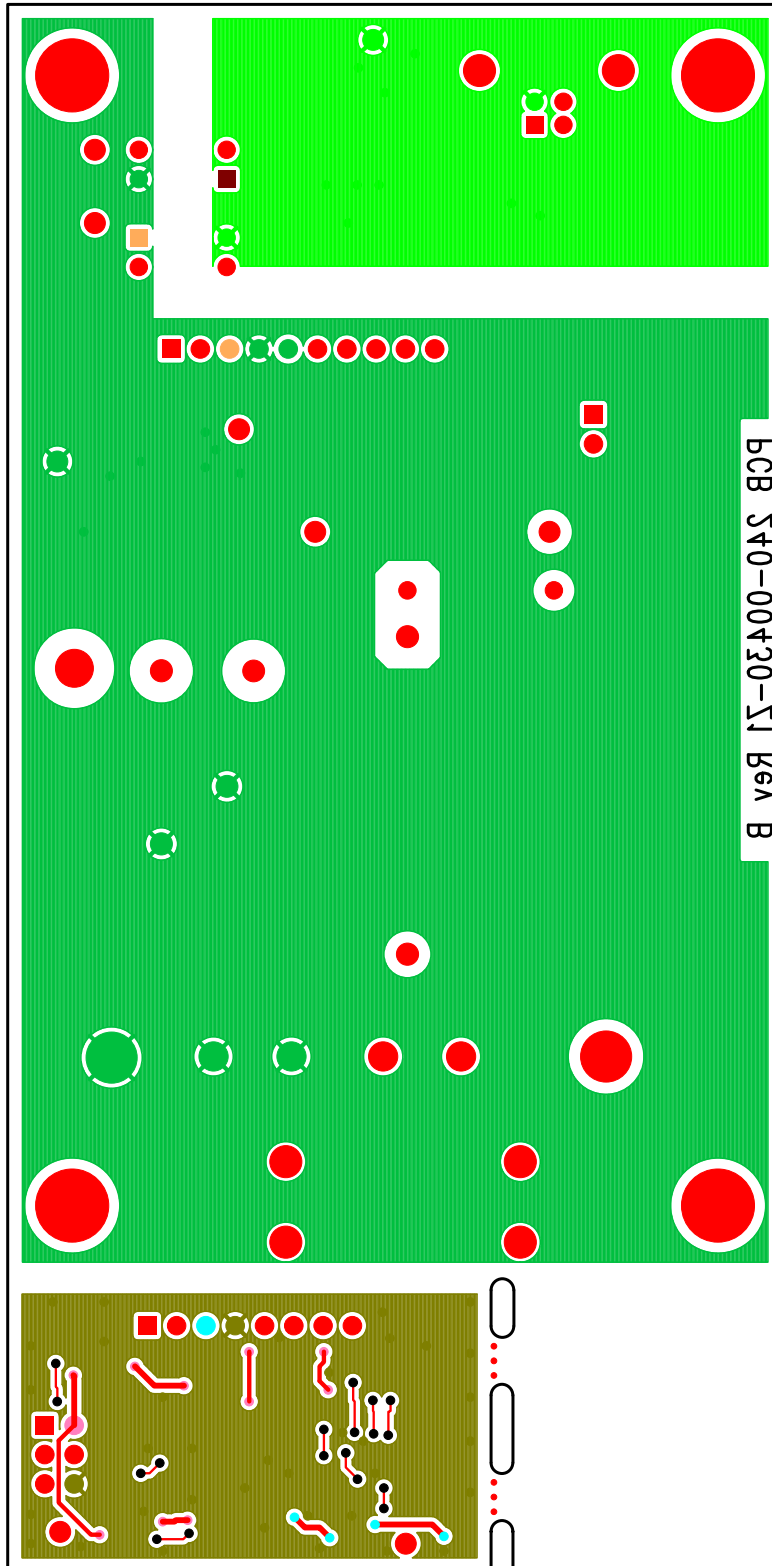

Figure 25. Bottom Routing

8. REVISION HISTORY

Revision	Date	Changes
RD1	JUL 2010	Initial Release.
RD2	OCT 2010	Updated BOM, schematic, and layer plots to rev B.

Contacting Cirrus Logic Support

For all product questions and inquiries contact a Cirrus Logic Sales Representative. To find the one nearest to you go to www.cirrus.com

IMPORTANT NOTICE

Cirrus Logic, Inc. and its subsidiaries ("Cirrus") believe that the information contained in this document is accurate and reliable. However, the information is subject to change without notice and is provided "AS IS" without warranty of any kind (express or implied). Customers are advised to obtain the latest version of relevant information to verify, before placing orders, that information being relied on is current and complete. All products are sold subject to the terms and conditions of sale supplied at the time of order acknowledgment, including those pertaining to warranty, indemnification, and limitation of liability. No responsibility is assumed by Cirrus for the use of this information, including use of this information as the basis for manufacture or sale of any items, or for infringement of patents or other rights of third parties. This document is the property of Cirrus and by furnishing this information, Cirrus grants no license, express or implied under any patents, mask work rights, copyrights, trademarks, trade secrets or other intellectual property rights. Cirrus owns the copyrights associated with the information contained herein and gives consent for copies to be made of the information only for use within your organization with respect to Cirrus integrated circuits or other products of Cirrus. This consent does not extend to other copying such as copying for general distribution, advertising or promotional purposes, or for creating any work for resale.

CERTAIN APPLICATIONS USING SEMICONDUCTOR PRODUCTS MAY INVOLVE POTENTIAL RISKS OF DEATH, PERSONAL INJURY, OR SEVERE PROPERTY OR ENVIRONMENTAL DAMAGE ("CRITICAL APPLICATIONS"). CIRRUS PRODUCTS ARE NOT DESIGNED, AUTHORIZED OR WARRANTED FOR USE IN PRODUCTS SURGICALLY IMPLANTED INTO THE BODY, AUTOMOTIVE SAFETY OR SECURITY DEVICES, LIFE SUPPORT PRODUCTS OR OTHER CRITICAL APPLICATIONS. INCLUSION OF CIRRUS PRODUCTS IN SUCH APPLICATIONS IS UNDERSTOOD TO BE FULLY AT THE CUSTOMER'S RISK AND CIRRUS DISCLAIMS AND MAKES NO WARRANTY, EXPRESS, STATUTORY OR IMPLIED, INCLUDING THE IMPLIED WARRANTIES OF MERCHANTABILITY AND FITNESS FOR PARTICULAR PURPOSE, WITH REGARD TO ANY CIRRUS PRODUCT THAT IS USED IN SUCH A MANNER. IF THE CUSTOMER OR CUSTOMER'S CUSTOMER USES OR PERMITS THE USE OF CIRRUS PRODUCTS IN CRITICAL APPLICATIONS, CUSTOMER AGREES, BY SUCH USE, TO FULLY INDEMNIFY CIRRUS, ITS OFFICERS, DIRECTORS, EMPLOYEES, DISTRIBUTORS AND OTHER AGENTS FROM ANY AND ALL LIABILITY, INCLUDING ATTORNEYS' FEES AND COSTS, THAT MAY RESULT FROM OR ARISE IN CONNECTION WITH THESE USES.

Cirrus Logic, Cirrus, and the Cirrus Logic logo designs are trademarks of Cirrus Logic, Inc. All other brand and product names in this document may be trademarks or service marks of their respective owners.

Lab Windows and CVI are trademarks of National Instruments Corporation.

Windows 2000 and Windows XP are either trademarks or registered trademarks of Microsoft Corporation.

Atmel is a registered trademark or trademark of Atmel Corporation or its subsidiaries.