

IRF7350PbF

HEXFET® Power MOSFET

- Ultra Low On-Resistance
- Dual N and P Channel MOSFET
- Surface Mount
- Available in Tape and Reel
- Lead-Free

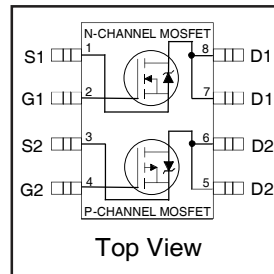

	N-Ch	P-Ch
V_{DS}	100V	-100V
$R_{DS(on)}$	0.21 Ω	0.48 Ω

Description

These dual N and P channel HEXFET® power MOSFETs from International Rectifier utilize advanced processing techniques to achieve extremely low on-resistance per silicon area. This benefit, combined with the fast switching speed and ruggedized device design that HEXFET® power MOSFETs are well known for, provides the designer with an extremely efficient and reliable device for use in DC motor drives and load management applications.

The SO-8 has been modified through a customized leadframe for enhanced thermal characteristics and multiple-die capability making it ideal in a variety of power applications. With these improvements, multiple devices can be used in an application with dramatically reduced board space. The package is designed for vapor phase, infra red, or wave soldering techniques.

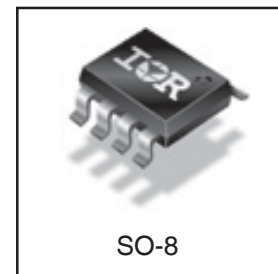

Absolute Maximum Ratings

	Parameter	Max.		Units
		N-Channel	P-Channel	
V_{DS}	Drain-to-Source Voltage	100	-100	A
$I_D @ T_A = 25^\circ\text{C}$	Continuous Drain Current, $V_{GS} @ 10\text{V}$	2.1	-1.5	
$I_D @ T_A = 70^\circ\text{C}$	Continuous Drain Current, $V_{GS} @ 10\text{V}$	1.7	-1.2	
I_{DM}	Pulsed Drain Current ①	8.4	-6.0	
$P_D @ T_A = 25^\circ\text{C}$	Power Dissipation	2.0		W
	Linear Derating Factor	0.016		W/°C
E_{AS}	Single Pulse Avalanche Energy④	35	51	mJ
V_{GS}	Gate-to-Source Voltage	± 20	± 20	V
dv/dt	Peak Diode Recovery dv/dt ②	4.0	4.3	V/ns
T_J, T_{STG}	Junction and Storage Temperature Range	-55 to + 150		°C

Thermal Resistance

Symbol	Parameter	Typ.	Max.	Units
$R_{\theta JL}$	Junction-to-Drain Lead	—	20	°C/W
$R_{\theta JA}$	Junction-to-Ambient ③	—	62.5	

IRF7350PbF

International
IR Rectifier

Electrical Characteristics @ T_J = 25°C (unless otherwise specified)

	Parameter		Min.	Typ.	Max.	Units	Conditions	
V _{(BR)DSS}	Drain-to-Source Breakdown Voltage	N-Ch	100	—	—	V	V _{GS} = 0V, I _D = 250μA	
		P-Ch	-100	—	—		V _{GS} = 0V, I _D = -250μA	
ΔV _{(BR)DSS} /ΔT _J	Breakdown Voltage Temp. Coefficient	N-Ch	—	0.12	—	V/°C	Reference to 25°C, I _D = 1mA	
		P-Ch	—	-0.11	—		Reference to 25°C, I _D = -1mA	
R _{DS(ON)}	Static Drain-to-Source On-Resistance	N-Ch	—	—	0.21	Ω	V _{GS} = 10V, I _D = 2.1A ②	
		P-Ch	—	—	0.48		V _{GS} = -10V, I _D = -1.5A ②	
V _{GS(th)}	Gate Threshold Voltage	N-Ch	2.0	—	4.0	V	V _{DS} = V _{GS} , I _D = 250μA	
		P-Ch	-2.0	—	-4.0		V _{DS} = V _{GS} , I _D = -250μA	
g _{fs}	Forward Transconductance	N-Ch	2.4	—	—	S	V _{DS} = 50V, I _D = 2.1A	
		P-Ch	1.1	—	—		V _{DS} = -50V, I _D = -1.5A	
I _{DSS}	Drain-to-Source Leakage Current	N-Ch	—	—	25	μA	V _{DS} = 100V, V _{GS} = 0V ②	
		P-Ch	—	—	-25		V _{DS} = -100V, V _{GS} = 0V ②	
		N-Ch	—	—	250		V _{DS} = 80V, V _{GS} = 0V, T _J = 70°C	
		P-Ch	—	—	-250		V _{DS} = -80V, V _{GS} = 0V, T _J = 70°C	
I _{GSS}	Gate-to-Source Forward Leakage	N-P	—	—	±100		V _{GS} = ± 20V	
Q _g	Total Gate Charge	N-Ch	—	19	28	nC	N-Channel I _D = 2.1A, V _{DS} = 80V, V _{GS} = 10V	
		P-Ch	—	21	31		P-Channel I _D = -1.5A, V _{DS} = -80V, V _{GS} = -10V	
Q _{gs}	Gate-to-Source Charge	N-Ch	—	3.0	4.5	nC		
		P-Ch	—	3.4	5.1			
Q _{gd}	Gate-to-Drain ("Miller") Charge	N-Ch	—	8.8	13	nC		
		P-Ch	—	10	16			
t _{d(on)}	Turn-On Delay Time	N-Ch	—	6.7	—	ns	N-Channel V _{DD} = 50V, I _D = 1.0A, R _G = 22Ω, R _D = 50Ω, V _{GS} = 10V	
t _r	Rise Time	N-Ch	—	11	—			
t _{d(off)}	Turn-Off Delay Time	P-Ch	—	13	—	ns		
		N-Ch	—	35	—		P-Channel V _{DD} = -50V, I _D = -1.0A, R _G = 22Ω, R _D = 50Ω, V _{GS} = -10V	
t _f	Fall Time	P-Ch	—	30	—	ns		
		N-Ch	—	20	—			
C _{iss}	Input Capacitance	P-Ch	—	40	—	pF		
		N-Ch	—	380	—		N-Channel V _{GS} = 0V, V _{DS} = 25V, f = 1.0MHz	
C _{oss}	Output Capacitance	P-Ch	—	360	—	pF		
		N-Ch	—	100	—		P-Channel V _{GS} = 0V, V _{DS} = -25V, f = 1.0MHz	
C _{rss}	Reverse Transfer Capacitance	P-Ch	—	110	—	pF		
		N-Ch	—	54	—			
C _{rss}	Reverse Transfer Capacitance	P-Ch	—	65	—	pF		
		N-Ch	—	65	—			

Source-Drain Ratings and Characteristics

	Parameter		Min.	Typ.	Max.	Units	Conditions	
I _S	Continuous Source Current (Body Diode)	N-Ch	—	—	1.8	A		
		P-Ch	—	—	-1.4			
I _{SM}	Pulsed Source Current (Body Diode) ①	N-Ch	—	—	8.4	A		
		P-Ch	—	—	-6.0			
V _{SD}	Diode Forward Voltage	N-Ch	—	—	1.3	V	T _J = 25°C, I _S = 1.8A, V _{GS} = 0V ②	
		P-Ch	—	—	-1.6		T _J = 25°C, I _S = -1.4A, V _{GS} = 0V ②	
t _{rr}	Reverse Recovery Time	N-Ch	—	72	110	ns	N-Channel T _J = 25°C, I _F = 1.8A, di/dt = 100A/μs	
		P-Ch	—	77	120		P-Channel ②	
Q _{rr}	Reverse Recovery Charge	N-Ch	—	205	310	nC		
		P-Ch	—	240	360		T _J = 25°C, I _F = -1.4A, di/dt = -100A/μs	

Notes:

- ① Repetitive rating; pulse width limited by max. junction temperature.
- ② Pulse width ≤ 400μs; duty cycle ≤ 2%.
- ③ Surface mounted on 1 in square Cu board

- ④ N channel: Starting T_J = 25°C, L = 4.0mH, R_G = 25Ω, I_{AS} = 4.2A
P channel: Starting T_J = 25°C, L = 11mH, R_G = 25Ω, I_{AS} = -3.0A

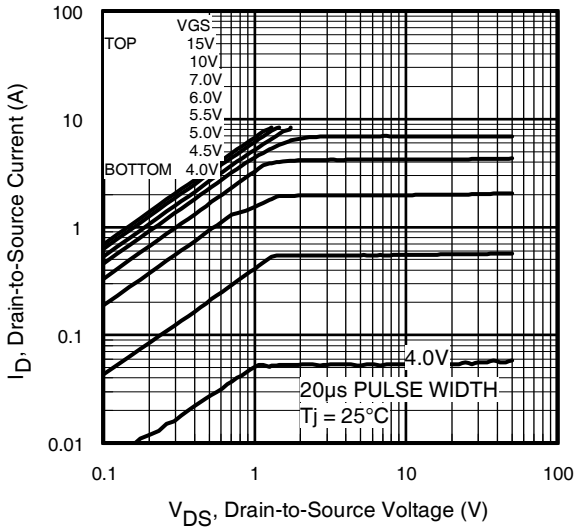

Fig 1. Typical Output Characteristics

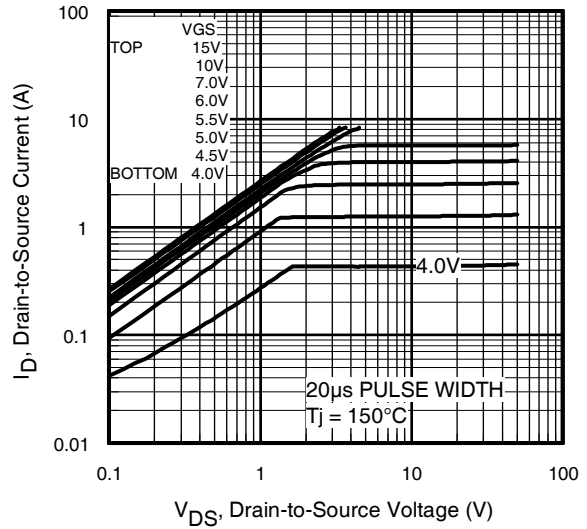

Fig 2. Typical Output Characteristics

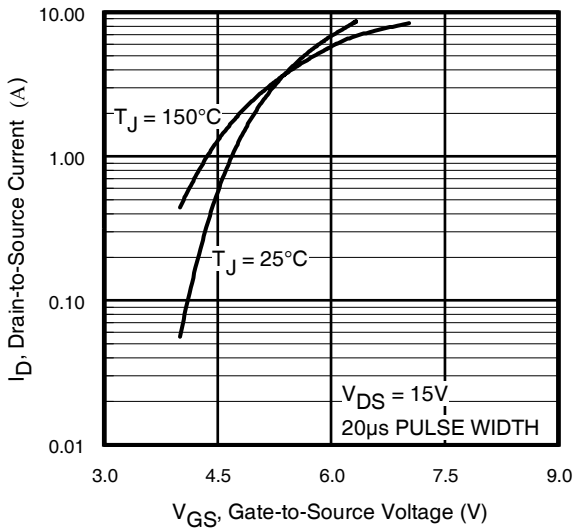

Fig 3. Typical Transfer Characteristics

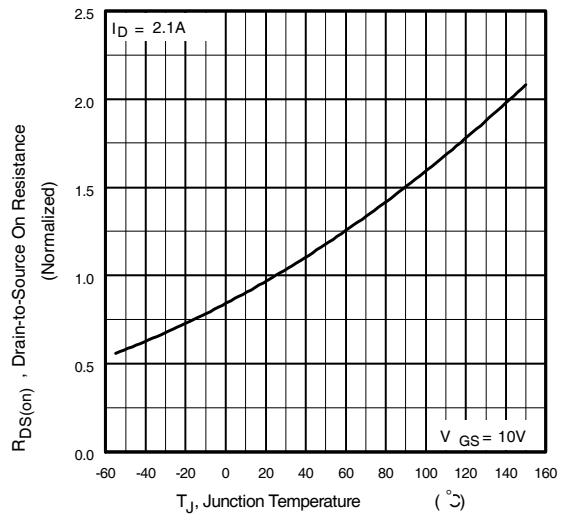

Fig 4. Normalized On-Resistance Vs. Temperature

IRF7350PbF

N-CHANNEL

International
IR Rectifier

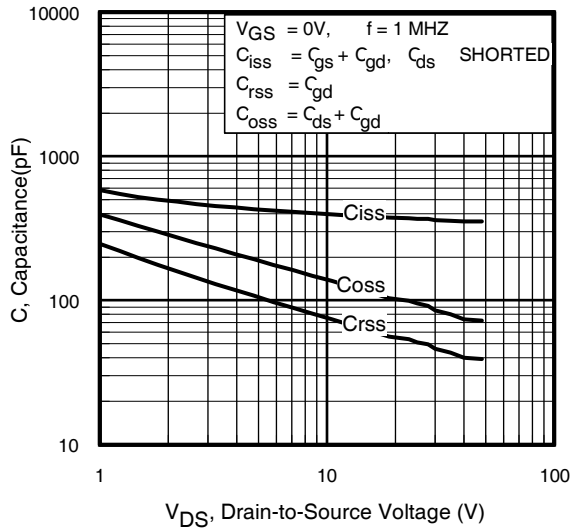

Fig 5. Typical Capacitance Vs. Drain-to-Source Voltage

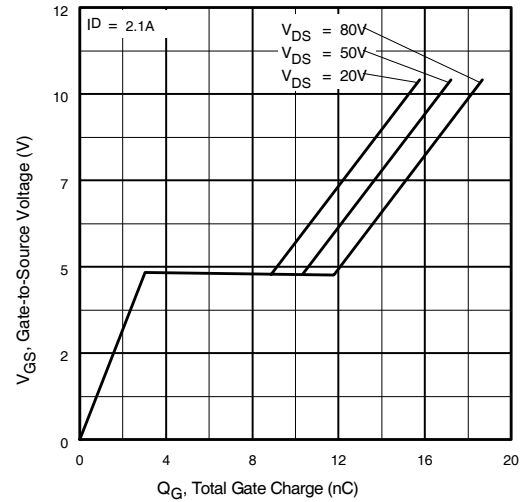

Fig 6. Typical Gate Charge Vs. Gate-to-Source Voltage

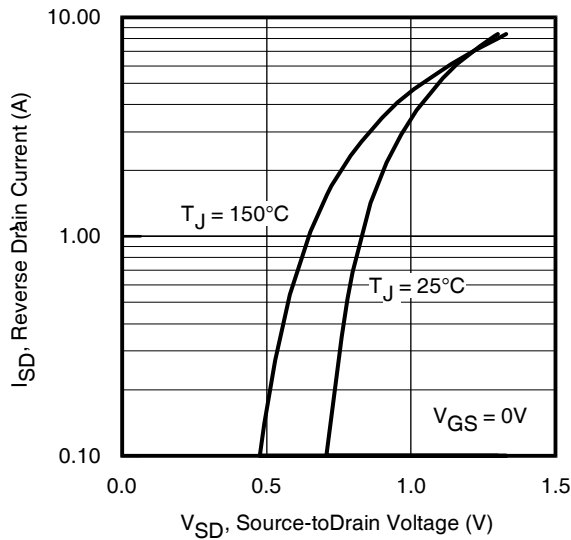

Fig 7. Typical Source-Drain Diode Forward Voltage

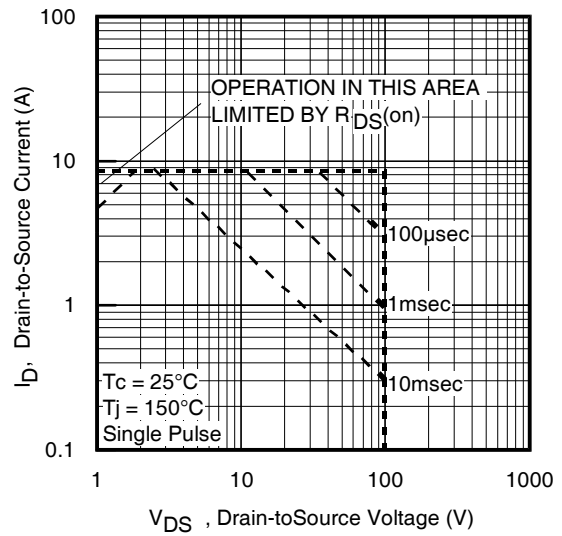

Fig 8. Maximum Safe Operating Area

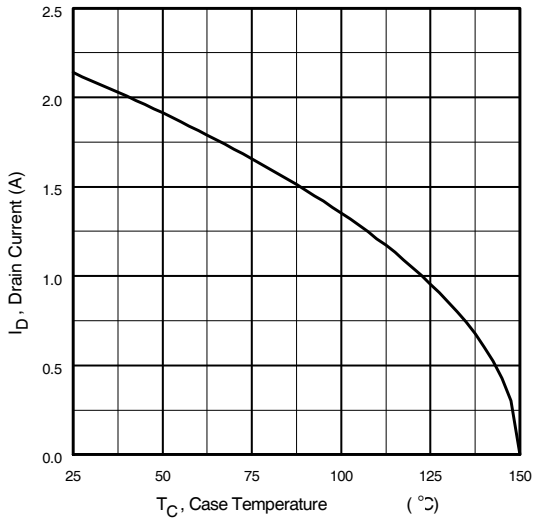

Fig 9. Maximum Drain Current Vs. Case Temperature

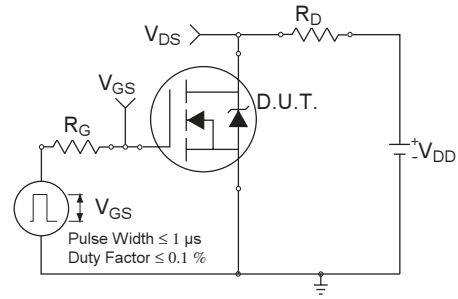

Fig 10a. Switching Time Test Circuit

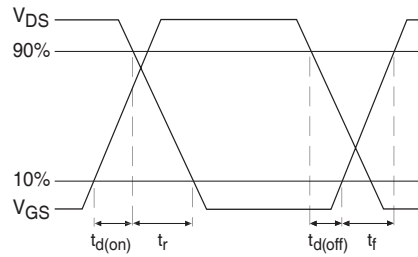

Fig 10b. Switching Time Waveforms

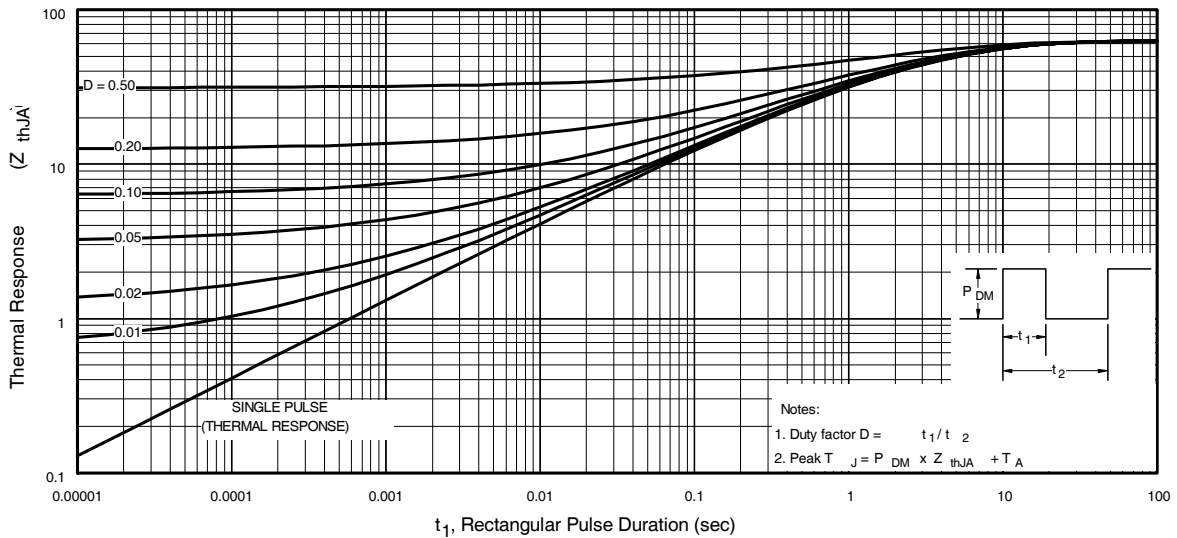

Fig 11. Typical Effective Transient Thermal Impedance, Junction-to-Ambient

IRF7350PbF

N-CHANNEL

International
IR Rectifier

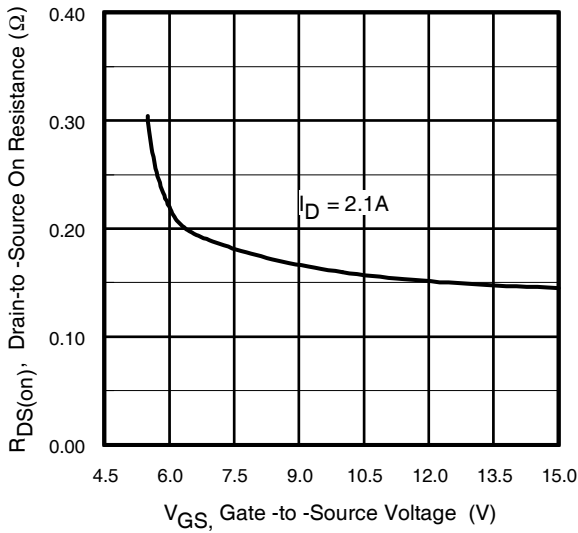

Fig 12. Typical On-Resistance Vs. Gate Voltage

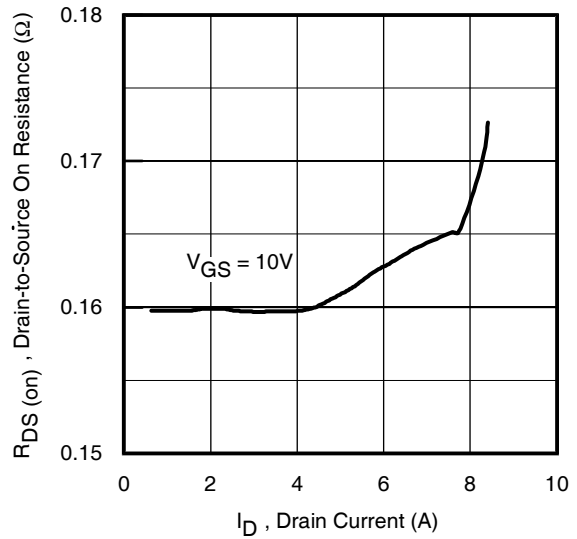

Fig 13. Typical On-Resistance Vs. Drain Current

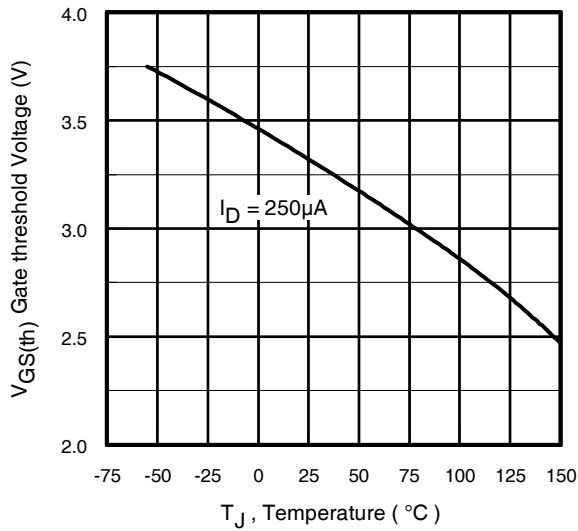

Fig 14. Typical Threshold Voltage Vs. Junction Temperature

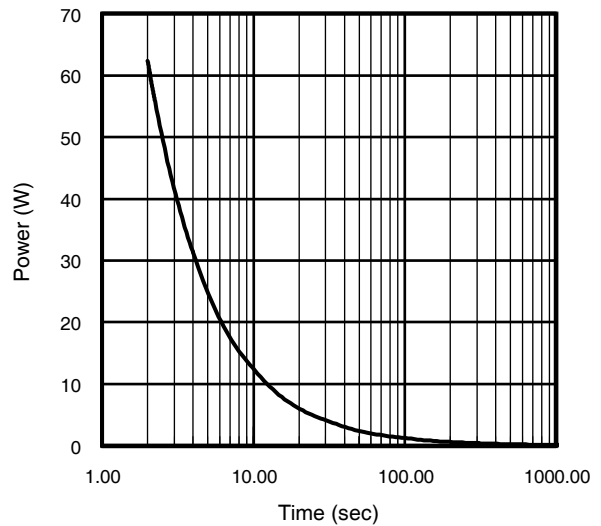

Fig 15. Typical Power Vs. Time

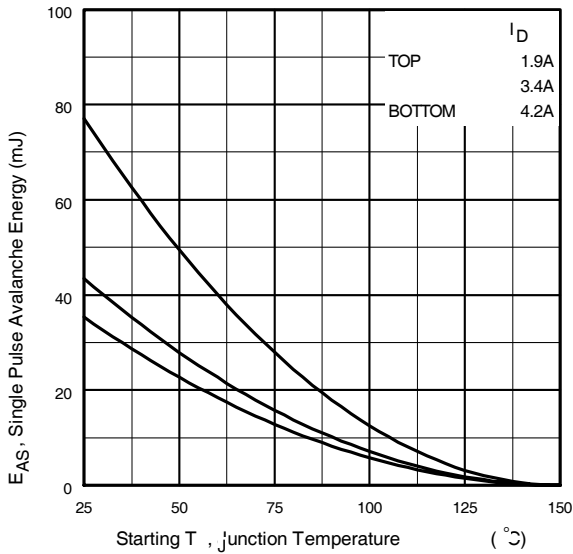

Fig 16a. Maximum Avalanche Energy Vs. Drain Current

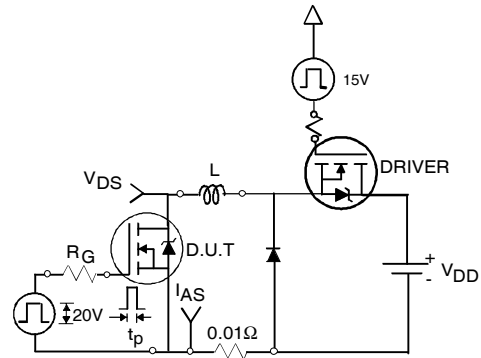

Fig 16c. Unclamped Inductive Test Circuit

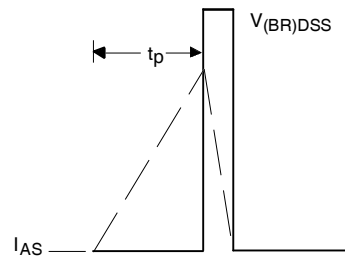

Fig 16d. Unclamped Inductive Waveforms

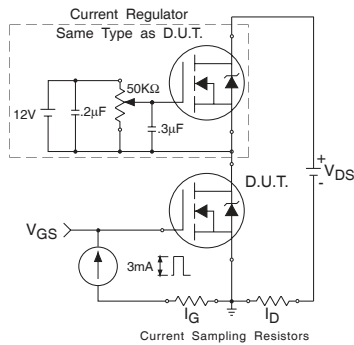

Fig 17. Gate Charge Test Circuit

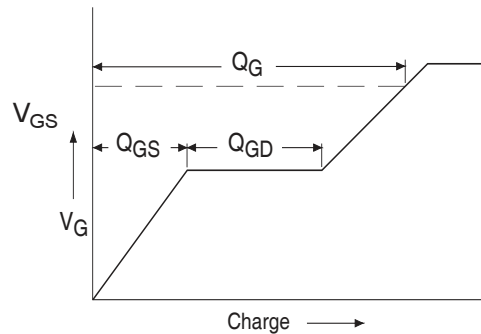

Fig 18. Basic Gate Charge Waveform

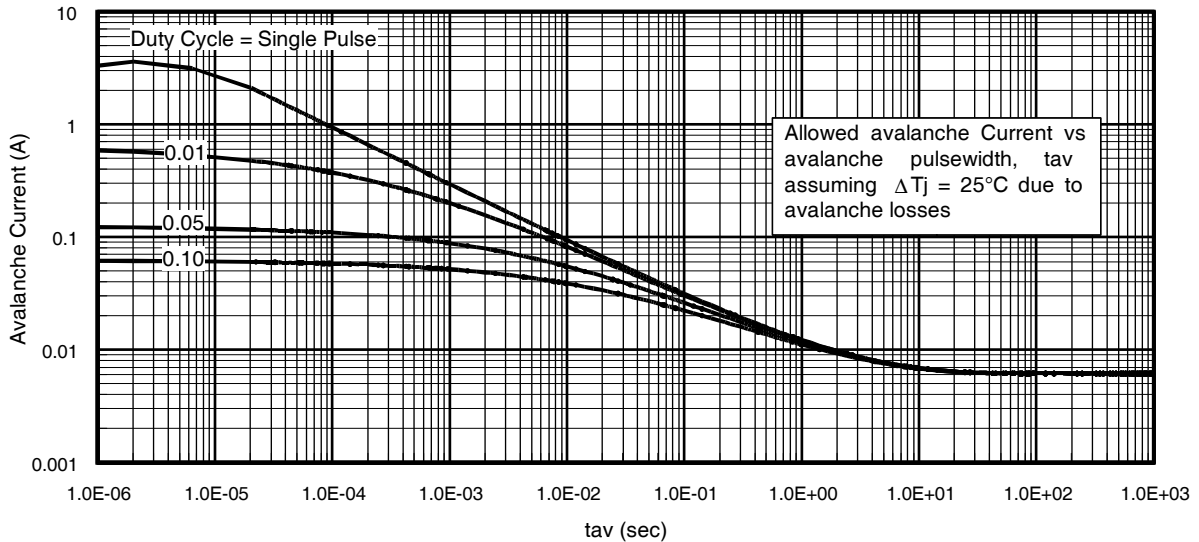

Fig 19. Typical Avalanche Current Vs.Pulsewidth

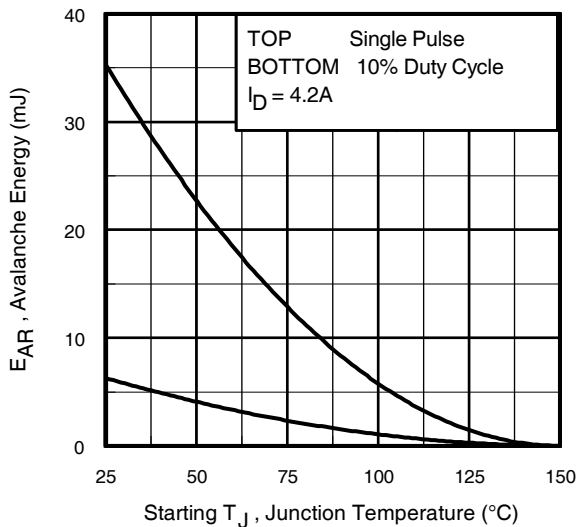

Fig 20. Maximum Avalanche Energy Vs. Temperature

Notes on Repetitive Avalanche Curves , Figures 15, 16:
(For further info, see AN-1005 at www.irf.com)

1. Avalanche failures assumption:
Purely a thermal phenomenon and failure occurs at a temperature far in excess of T_{jmax} . This is validated for every part type.
2. Safe operation in Avalanche is allowed as long as T_{jmax} is not exceeded.
3. Equation below based on circuit and waveforms shown in Figures 12a, 12b.
4. $P_{D(ave)}$ = Average power dissipation per single avalanche pulse.
5. BV = Rated breakdown voltage (1.3 factor accounts for voltage increase during avalanche).
6. I_{av} = Allowable avalanche current.
7. ΔT = Allowable rise in junction temperature, not to exceed T_{jmax} (assumed as 25°C in Figure 15, 16).
 t_{av} = Average time in avalanche.
 D = Duty cycle in avalanche = $t_{av} \cdot f$
 $Z_{thJC}(D, t_{av})$ = Transient thermal resistance, see figure 11)

$$P_{D(ave)} = 1/2 (1.3 \cdot BV \cdot I_{av}) = \Delta T / Z_{thJC}$$

$$I_{av} = 2\Delta T / [1.3 \cdot BV \cdot Z_{th}]$$

$$E_{AS(AR)} = P_{D(ave)} \cdot t_{av}$$

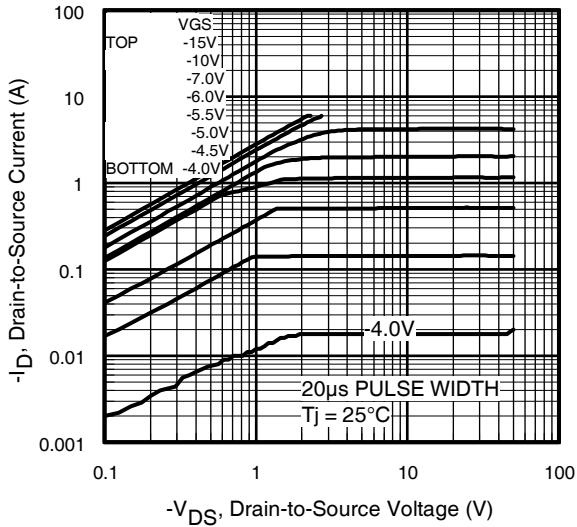

Fig 21. Typical Output Characteristics

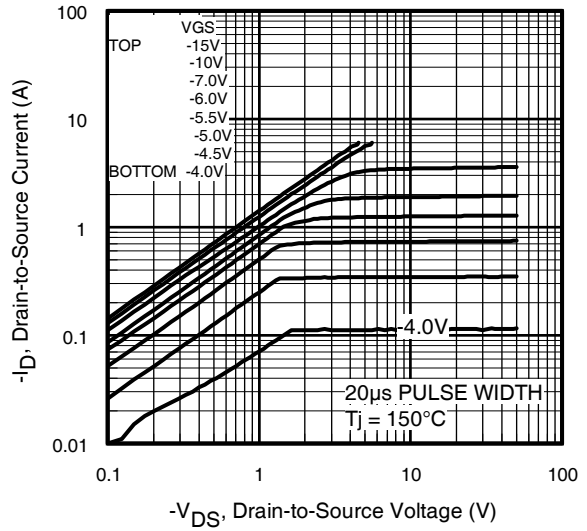

Fig 22. Typical Output Characteristics

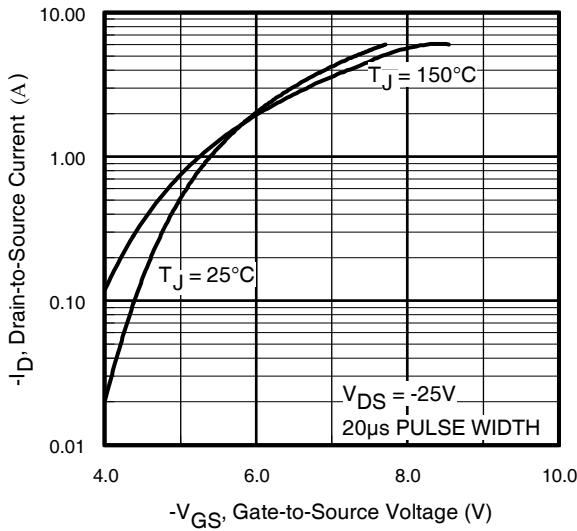

Fig 23. Typical Transfer Characteristics

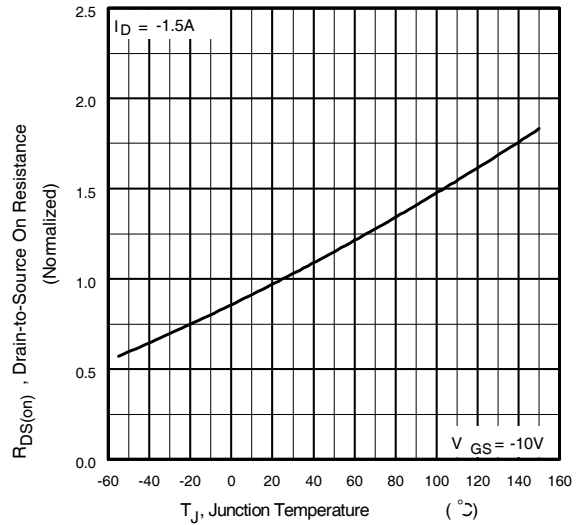

Fig 24. Normalized On-Resistance Vs. Temperature

IRF7350PbF

P-CHANNEL

International
IR Rectifier

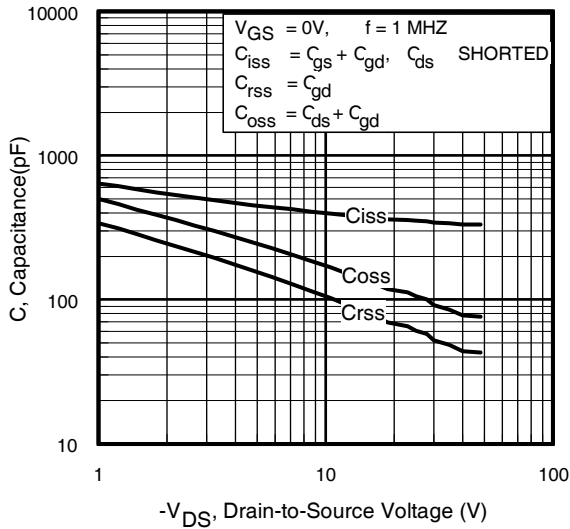

Fig 25. Typical Capacitance Vs. Drain-to-Source Voltage

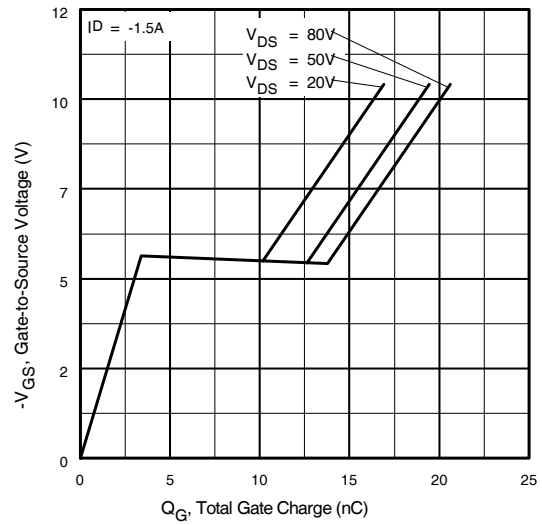

Fig 26. Typical Gate Charge Vs. Gate-to-Source Voltage

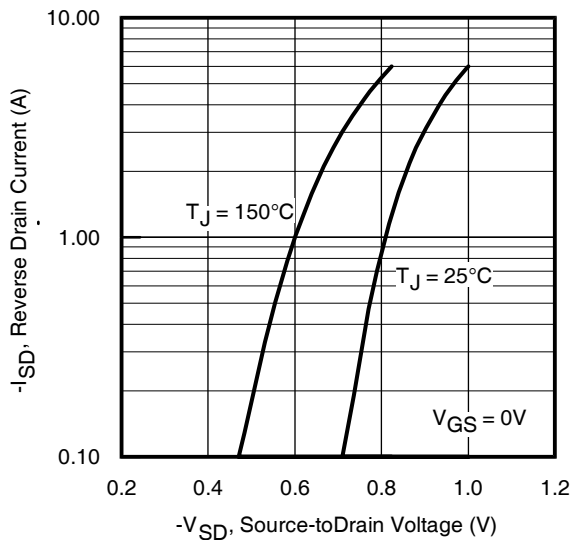

Fig 27. Typical Source-Drain Diode Forward Voltage

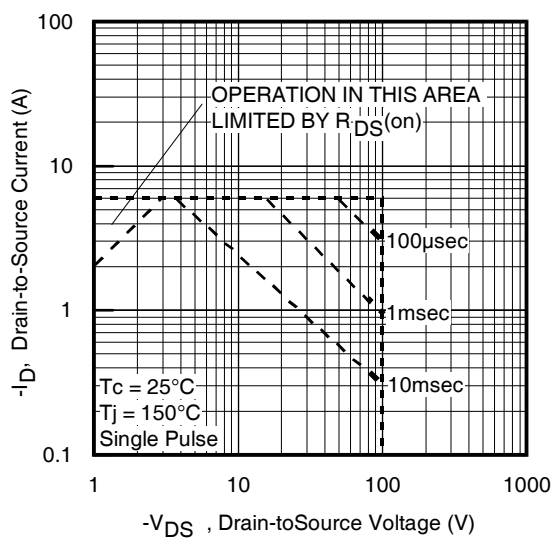

Fig 28. Maximum Safe Operating Area

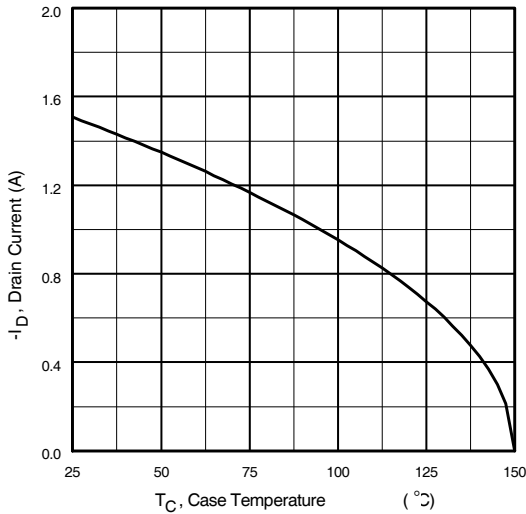

Fig 29. Maximum Drain Current Vs. Case Temperature

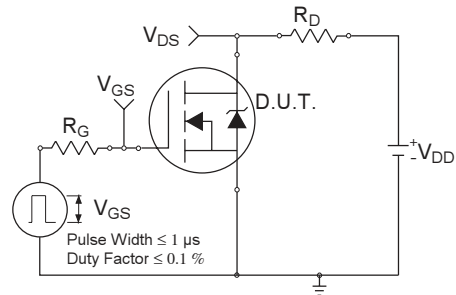

Fig 10a. Switching Time Test Circuit

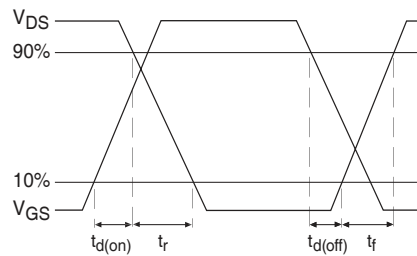

Fig 10b. Switching Time Waveforms

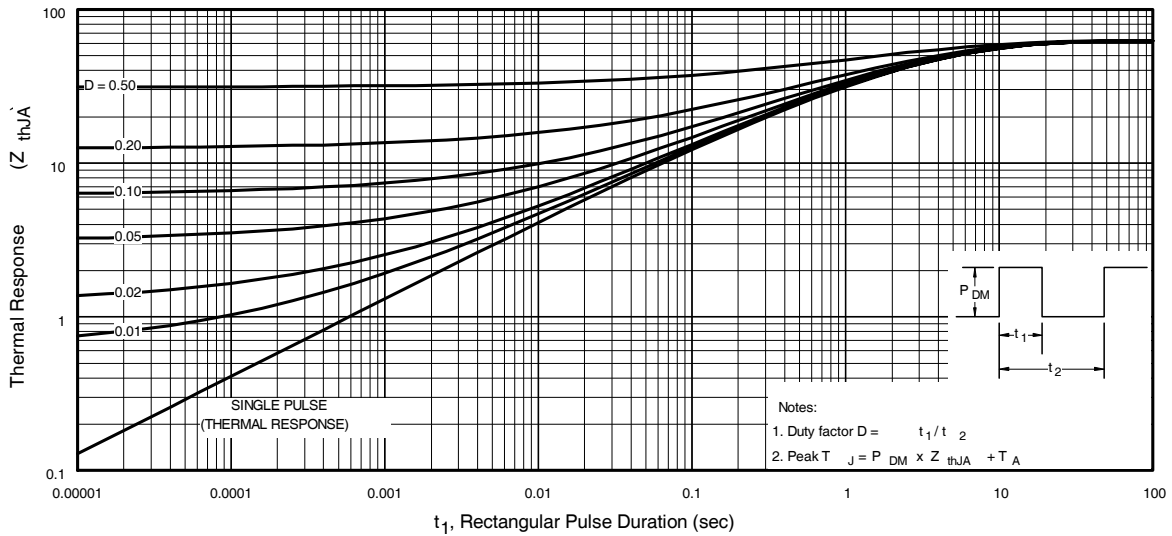

Fig 30. Typical Effective Transient Thermal Impedance, Junction-to-Ambient

IRF7350PbF

P-CHANNEL

International
IR Rectifier

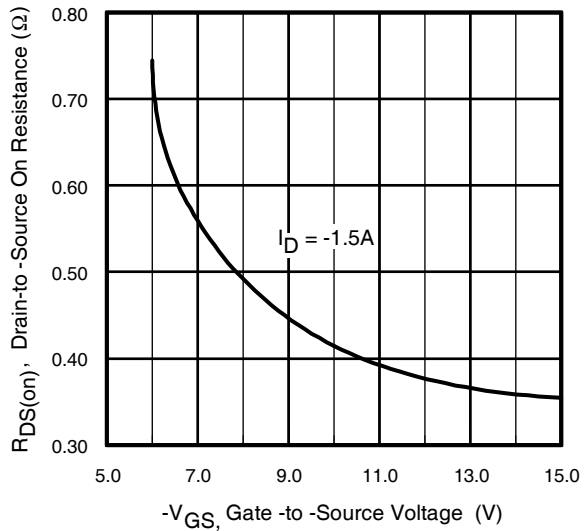

Fig 31. Typical On-Resistance Vs. Gate Voltage

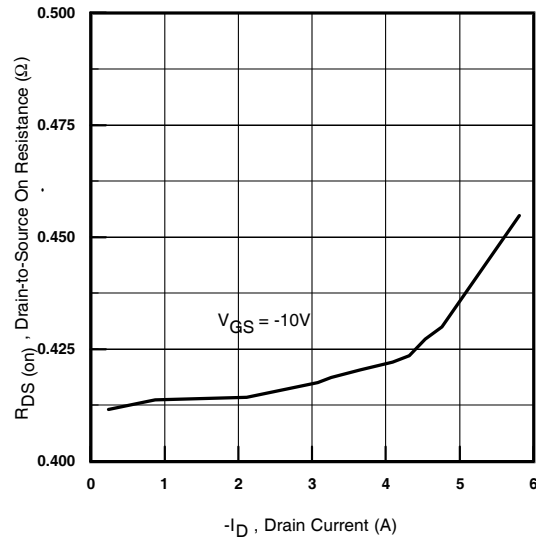

Fig 32. Typical On-Resistance Vs. Drain Current

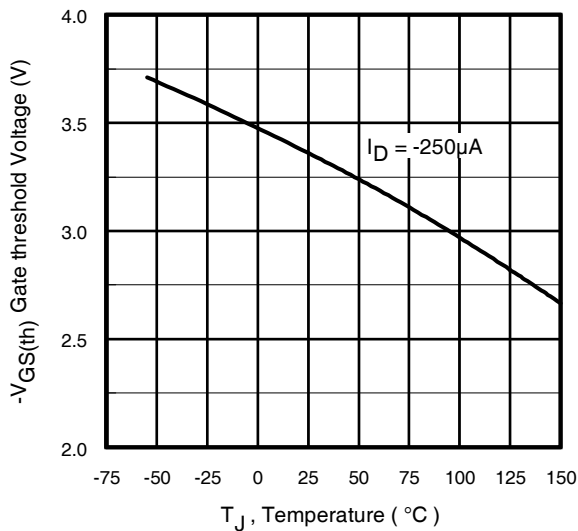

Fig 33. Typical Threshold Voltage Vs. Junction Temperature

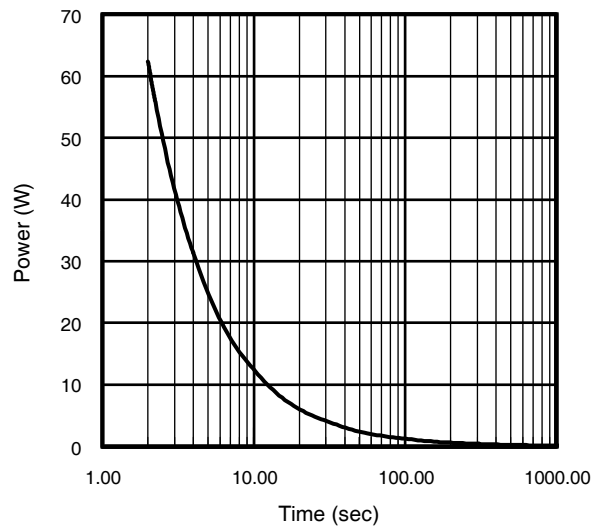

Fig 34. Typical Power Vs. Time

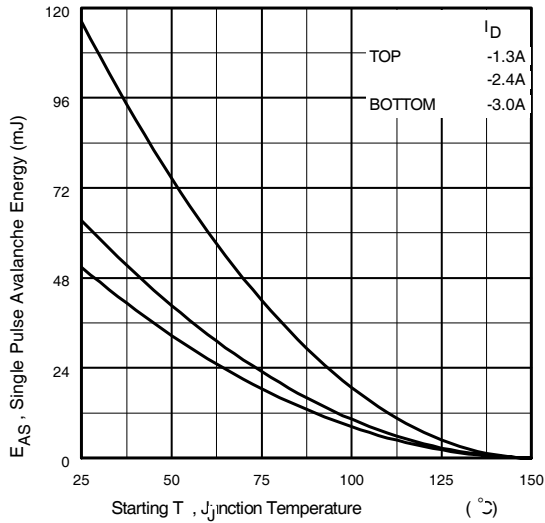

Fig 35a. Maximum Avalanche Energy Vs. Drain Current

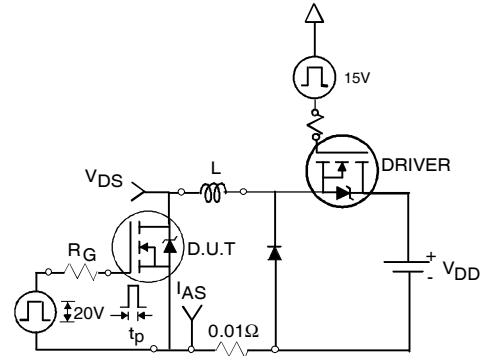

Fig 35c. Unclamped Inductive Test Circuit

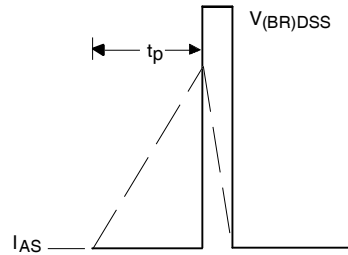

Fig 35d. Unclamped Inductive Waveforms

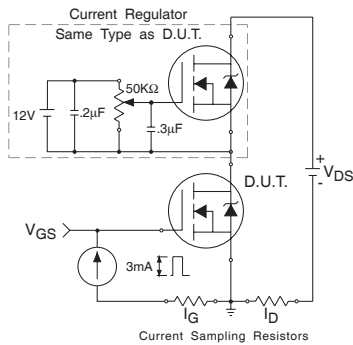

Fig 36. Gate Charge Test Circuit

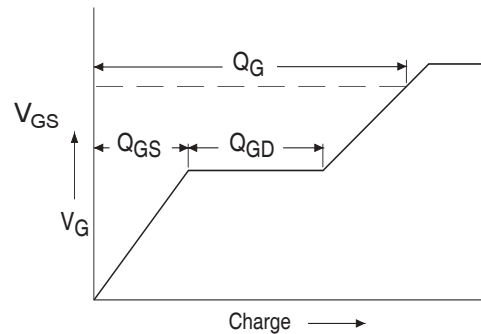

Fig 37. Basic Gate Charge Waveform

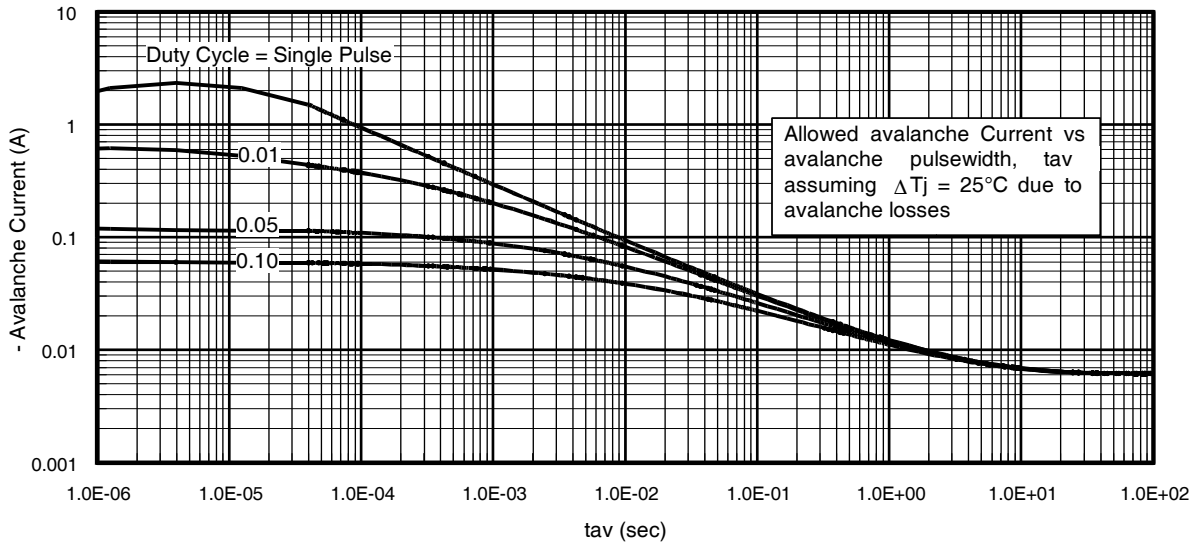

Fig 38. Typical Avalanche Current Vs.Pulsewidth

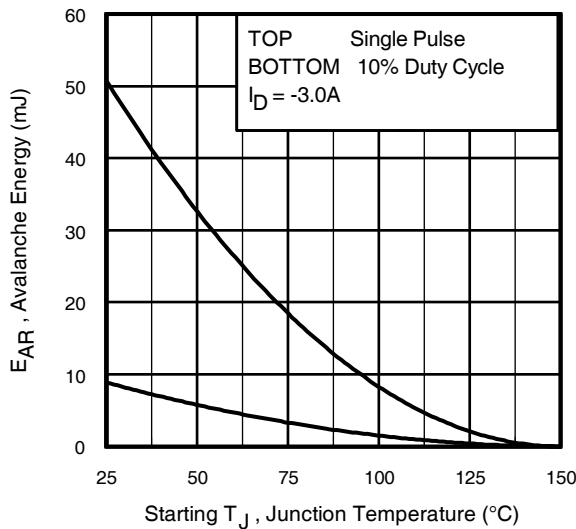

Fig 39. Maximum Avalanche Energy Vs. Temperature

**Notes on Repetitive Avalanche Curves , Figures 15, 16:
(For further info, see AN-1005 at www.irf.com)**

1. Avalanche failures assumption:
Purely a thermal phenomenon and failure occurs at a temperature far in excess of T_{jmax} . This is validated for every part type.
2. Safe operation in Avalanche is allowed as long as T_{jmax} is not exceeded.
3. Equation below based on circuit and waveforms shown in Figures 12a, 12b.
4. $P_{D(ave)}$ = Average power dissipation per single avalanche pulse.
5. BV = Rated breakdown voltage (1.3 factor accounts for voltage increase during avalanche).
6. I_{av} = Allowable avalanche current.
7. ΔT = Allowable rise in junction temperature, not to exceed T_{jmax} (assumed as 25°C in Figure 15, 16).
 t_{av} = Average time in avalanche.
 D = Duty cycle in avalanche = $t_{av} \cdot f$
 $Z_{thJC}(D, t_{av})$ = Transient thermal resistance, see figure 11)

$$P_{D(ave)} = 1/2 (1.3 \cdot BV \cdot I_{av}) = \Delta T / Z_{thJC}$$

$$I_{av} = 2\Delta T / [1.3 \cdot BV \cdot Z_{th}]$$

$$E_{AS(AR)} = P_{D(ave)} \cdot t_{av}$$

SO-8 Package Outline

Dimensions are shown in millimeters (inches)

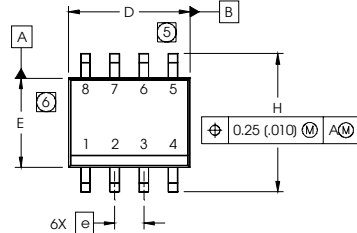

DIM	INCHES		MILLIMETERS	
	MIN	MAX	MIN	MAX
A	.0532	.0688	1.35	1.75
AI	.0040	.0098	0.10	0.25
b	.013	.020	0.33	0.51
c	.0075	.0098	0.19	0.25
D	.189	.1968	4.80	5.00
E	.1497	.1574	3.80	4.00
e	.050 BASIC		1.27 BASIC	
e1	.025 BASIC		0.635 BASIC	
H	.2284	.2440	5.80	6.20
K	.0099	.0196	0.25	0.50
L	.016	.050	0.40	1.27
y	0°	8°	0°	8°

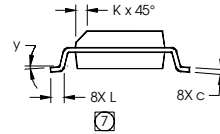
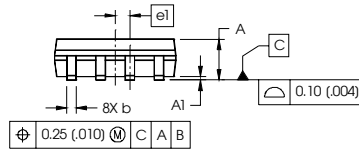

- NOTES:
1. DIMENSIONING & TOLERANCING PER ASME Y14.5M-1994.
 2. CONTROLLING DIMENSION: MILLIMETER
 3. DIMENSIONS ARE SHOWN IN MILLIMETERS (INCHES).
 4. OUTLINE CONFORMS TO JEDEC OUTLINE MS-012AA.
 - ⑤ DIMENSION DOES NOT INCLUDE MOLD PROTRUSIONS. MOLD PROTRUSIONS NOT TO EXCEED 0.15 (.006).
 - ⑥ DIMENSION DOES NOT INCLUDE MOLD PROTRUSIONS. MOLD PROTRUSIONS NOT TO EXCEED 0.25 (.010).
 - ⑦ DIMENSION IS THE LENGTH OF LEAD FOR SOLDERING TO A SUBSTRATE.

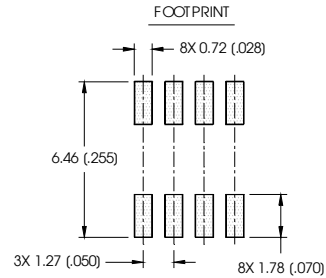

SO-8 Part Marking Information (Lead-Free)

EXAMPLE: THIS IS AN IRF7101 (MOSFET)

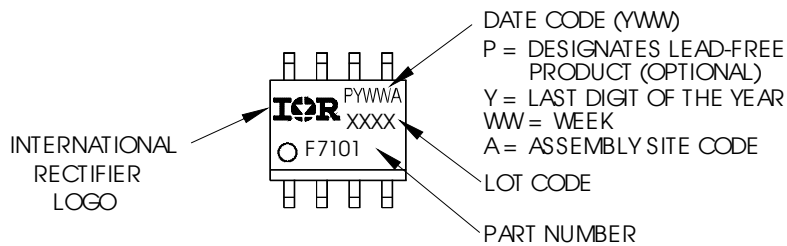

SO-8 Tape and Reel

Dimensions are shown in millimeters (inches)

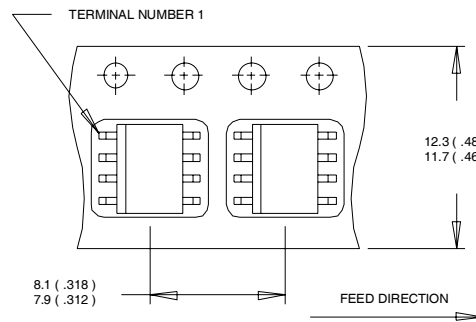

- NOTES:
1. CONTROLLING DIMENSION : MILLIMETER.
 2. ALL DIMENSIONS ARE SHOWN IN MILLIMETERS(INCHES).
 3. OUTLINE CONFORMS TO EIA-481 & EIA-541.

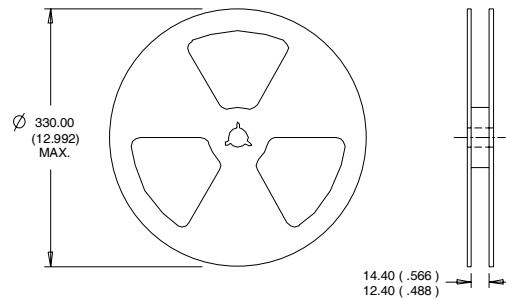

- NOTES :
1. CONTROLLING DIMENSION : MILLIMETER.
 2. OUTLINE CONFORMS TO EIA-481 & EIA-541.

Data and specifications subject to change without notice.
This product has been designed and qualified for the Consumer market.
Qualification Standards can be found on IR's Web site.

International
IR Rectifier

IR WORLD HEADQUARTERS: 233 Kansas St., El Segundo, California 90245, USA Tel: (310) 252-7105
TAC Fax: (310) 252-7903

Visit us at www.irf.com for sales contact information.06/04

www.irf.com