

**General information**

Part number	S11MOC-P09MCCO-3920
Termination	solder
Size	1
Locking principle	push
Coding	0_key
Cable Diameter	cable_medi_39
Cable outlet	standard

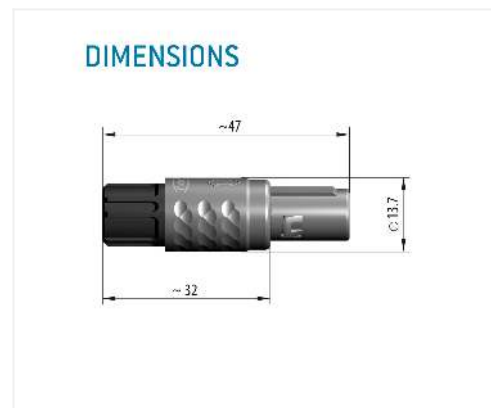

**Contact insert description**

Number of contacts	9
Contact type	pins
Contact diameter	05mm
Insulator material	peek
Wire cross section	28_awg
Termination	solder
Termination diameter	045mm

reverse\_gender\_on\_request

**Technical information**

Max. creepage and air clearance distance	065_mm	
Nominal current single contact	04_a	iec_60512_5_2
Nominal current insert	2,6 A	vde_0298_4
Test voltage	135_kv_dc	sae_13441

safety\_text

## Mechanical and environmental data

Degree of protection*	ip50
-----------------------	------

Operating temperature	50_120_c
-----------------------	----------

Mating cycles	2000
---------------	------

mated\_unmated

## Material and surface treatments

Housing	m_chrome
---------	----------

Color option	red
--------------	-----

Contact	cu_alloy_gold
---------	---------------

safety\_text\_2

ul\_text

illustrative\_text