

# MSTB 2,5/ 3-ST-5,08 BUBDWH:+-S - PCB connector



1161197

<https://www.phoenixcontact.com/us/products/1161197>

Please be informed that the data shown in this PDF document is generated from our online catalog. Please find the complete data in the user documentation. Our general terms of use for downloads are valid.



PCB connector, nominal cross section: 2.5 mm<sup>2</sup>, color: blue, nominal current: 12 A, rated voltage (III/2): 320 V, contact surface: Tin, contact connection type: Socket, number of rows: 1, number of positions: 3, product range: MSTB 2,5/..-ST, pitch: 5.08 mm, connection method: Screw connection with tension sleeve, screw head form: L Slotted, conductor/PCB connection direction: 0 °, locking clip: - Locking clip, plug-in system: COMBICON MSTB 2,5, locking: without, mounting: without, type of packaging: packed in cardboard, Satisfies the requirements of the "APL Port Profile Specification"

## Your advantages

- Well-known connection principle allows worldwide use
- Low temperature rise, thanks to maximum contact force
- Allows connection of two conductors

## Commercial data

|                                      |                                |
|--------------------------------------|--------------------------------|
| Item number                          | 1161197                        |
| Packing unit                         | 1 pc                           |
| Minimum order quantity               | 100 pc                         |
| Note                                 | Made to order (non-returnable) |
| Sales key                            | AA03                           |
| Product key                          | AACAGC                         |
| GTIN                                 | 4063151170202                  |
| Weight per piece (including packing) | 5.63 g                         |
| Weight per piece (excluding packing) | 5.153 g                        |
| Customs tariff number                | 85366990                       |
| Country of origin                    | DE                             |

1161197

<https://www.phoenixcontact.com/us/products/1161197>

## Technical data

### Product properties

|                     |                       |
|---------------------|-----------------------|
| Product line        | COMBICON Connectors M |
| Product type        | PCB connector         |
| Product family      | MSTB 2,5/...-ST       |
| Number of positions | 3                     |
| Pitch               | 5.08 mm               |
| Number of rows      | 1                     |

### Electrical properties

|                             |        |
|-----------------------------|--------|
| Nominal current $I_N$       | 12 A   |
| Nominal voltage $U_N$       | 320 V  |
| Degree of pollution         | 3      |
| Contact resistance          | 1.3 mΩ |
| Rated voltage (III/3)       | 250 V  |
| Rated surge voltage (III/3) | 4 kV   |
| Rated voltage (III/2)       | 320 V  |
| Rated surge voltage (III/2) | 4 kV   |
| Rated voltage (II/2)        | 630 V  |
| Rated surge voltage (II/2)  | 4 kV   |

### Connection data

#### Connection technology

|                         |                     |
|-------------------------|---------------------|
| Type                    | Standard            |
| Connector system        | COMBICON MSTB 2,5   |
| Nominal cross section   | 2.5 mm <sup>2</sup> |
| Contact connection type | Socket              |

#### Interlock

|                 |         |
|-----------------|---------|
| Locking type    | without |
| Mounting flange | without |

#### Conductor connection

|   |  |
|---|--|
| Connection method   | Screw connection with tension sleeve         |
| Conductor/PCB connection direction                                    | 0 °  |
| Conductor cross section rigid   | 0.2 mm <sup>2</sup> ... 2.5 mm <sup>2</sup>  |
| Conductor cross section flexible                                      | 0.2 mm <sup>2</sup> ... 2.5 mm <sup>2</sup>  |
| Conductor cross section AWG   | 24 ... 12                                    |
| Conductor cross section flexible, with ferrule without plastic sleeve | 0.25 mm <sup>2</sup> ... 2.5 mm <sup>2</sup> |
| Conductor cross section, flexible, with ferrule, with plastic sleeve  | 0.25 mm <sup>2</sup> ... 2.5 mm <sup>2</sup> |
| 2 conductors with same cross section, solid                           | 0.2 mm <sup>2</sup> ... 1 mm <sup>2</sup>    |
| 2 conductors with same cross section, flexible                        | 0.2 mm <sup>2</sup> ... 1.5 mm <sup>2</sup>  |

# MSTB 2,5/ 3-ST-5,08 BUBDWH:+-S - PCB connector



1161197

<https://www.phoenixcontact.com/us/products/1161197>

|   |   |
|---|---|
| 2 conductors with same cross section, flexible, with ferrule without plastic sleeve       | 0.25 mm <sup>2</sup> ... 1 mm <sup>2</sup>  |
| 2 conductors with the same cross section, flexible, with TWIN ferrule with plastic sleeve | 0.5 mm <sup>2</sup> ... 1.5 mm <sup>2</sup> |
| Cylindrical gauge a x b / diameter  | 2.8 mm x 2.0 mm / 2.4 mm                    |
| Stripping length  | 7 mm  |
| Tightening torque   | 0.5 Nm ... 0.6 Nm                           |

## Material specifications

### Material data - contact

|  |  |
|--|--|
| Note                                     | WEEE/RoHS-compliant, free of whiskers according to IEC 60068-2-82/JEDEC JESD 201 |
| Contact material                         | Cu alloy   |
| Surface characteristics                  | hot-dip tin-plated   |
| Metal surface terminal point (top layer) | Tin (5 - 7 µm Sn)  |
| Metal surface contact area (top layer)   | Tin (5 - 7 µm Sn)  |

### Material data - housing

|   |             |
|---|-------------|
| Color (Housing)   | blue (5015) |
| Insulating material   | PA          |
| Insulating material group   | I           |
| CTI according to IEC 60112  | 600         |
| Flammability rating according to UL 94                            | V0          |
| Glow wire flammability index GWFI according to EN 60695-2-12      | 850         |
| Glow wire ignition temperature GWIT according to EN 60695-2-13    | 775         |
| Temperature for the ball pressure test according to EN 60695-10-2 | 125 °C      |

## Dimensions

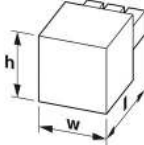
|                     |  |
|---------------------|--|
| Dimensional drawing |  |
| Pitch               | 5.08 mm  |
| Width [w]           | 15.24 mm   |
| Height [h]          | 15 mm  |
| Length [l]          | 18.3 mm  |

## Mounting

|                       |                                      |
|-----------------------|--------------------------------------|
| Drive form screw head | Slotted (L)                          |
| Connection method     | Screw connection with tension sleeve |
| Drive form screw head | Slotted (L)                          |

## Notes

|                    |  |
|--------------------|--|
| Notes on operation | In accordance with IEC 61984, COMBICON connectors have no switching power (COC). During designated use, they must not be plugged in or disconnected when carrying voltage or under load. |
|--------------------|--|

## Mechanical tests

## Test for conductor damage and slackening

|               |                     |
|---------------|---------------------|
| Specification | IEC 60999-1:1999-11 |
| Result        | Test passed         |

## Pull-out test

|   |   |
|---|---|
| Specification   | IEC 60999-1:1999-11                     |
| Conductor cross section/conductor type/tractive force setpoint/actual value | 0.2 mm <sup>2</sup> / solid / > 10 N    |
|   | 0.2 mm <sup>2</sup> / flexible / > 10 N |
|   | 2.5 mm <sup>2</sup> / solid / > 50 N    |
|   | 2.5 mm <sup>2</sup> / flexible / > 50 N |

## Insertion and withdrawal forces

|                                     |             |
|-------------------------------------|-------------|
| Result                              | Test passed |
| No. of cycles                       | 25          |
| Insertion strength per pos. approx. | 8 N         |
| Withdraw strength per pos. approx.  | 6 N         |

## Torque test

|               |                     |
|---------------|---------------------|
| Specification | IEC 60999-1:1999-11 |
|---------------|---------------------|

## Resistance of inscriptions

|               |                        |
|---------------|------------------------|
| Specification | IEC 60068-2-70:1995-12 |
| Result        | Test passed            |

## Polarization and coding

|               |                        |
|---------------|------------------------|
| Specification | IEC 60512-13-5:2006-02 |
| Result        | Test passed            |

## Visual inspection

|               |                       |
|---------------|-----------------------|
| Specification | IEC 60512-1-1:2002-02 |
| Result        | Test passed           |

## Dimension check

|               |                       |
|---------------|-----------------------|
| Specification | IEC 60512-1-2:2002-02 |
| Result        | Test passed           |

## Environmental and real-life conditions

## Vibration test

|               |                       |
|---------------|-----------------------|
| Specification | IEC 60068-2-6:2007-12 |
| Frequency     | 10 - 150 - 10 Hz      |

# MSTB 2,5/ 3-ST-5,08 BUBDWH:+-S - PCB connector



1161197

<https://www.phoenixcontact.com/us/products/1161197>

|                        |                             |
|------------------------|-----------------------------|
| Sweep speed            | 1 octave/min                |
| Amplitude              | 0.35 mm (10 Hz ... 60.1 Hz) |
| Sweep speed            | 5g (60.1 Hz ... 150 Hz)     |
| Test duration per axis | 2.5 h                       |

## Durability test

|  |                       |
|--|-----------------------|
| Specification                          | IEC 60512-9-1:2010-03 |
| Impulse withstand voltage at sea level | 4.8 kV                |
| Contact resistance R <sub>1</sub>      | 1.3 mΩ                |
| Contact resistance R <sub>2</sub>      | 1.4 mΩ                |
| Insertion/withdrawal cycles            | 25                    |

## Climatic test

|                                   |   |
|-----------------------------------|---|
| Specification                     | ISO 6988:1985-02  |
| Corrosive stress                  | 0.2 dm <sup>3</sup> SO <sub>2</sub> on 300 dm <sup>3</sup> /40 °C/1 cycle |
| Thermal stress                    | 100 °C/168 h  |
| Power-frequency withstand voltage | 2.21 kV   |

## Ambient conditions

|   |   |
|---|---|
| Ambient temperature (operation)         | -40 °C ... 100 °C (dependent on the derating curve) |
| Ambient temperature (storage/transport) | -40 °C ... 70 °C                                    |
| Relative humidity (storage/transport)   | 30 % ... 70 %                                       |
| Ambient temperature (assembly)          | -5 °C ... 100 °C                                    |

## Electrical tests

### Thermal test | Test group C

|                            |                       |
|----------------------------|-----------------------|
| Specification              | IEC 60512-5-1:2002-02 |
| Tested number of positions | 12                    |

### Insulation resistance

|  |                       |
|--|-----------------------|
| Specification                                | IEC 60512-3-1:2002-02 |
| Insulation resistance, neighboring positions | > 5 MΩ                |

### Air clearances and creepage distances |

|  |                     |
|--|---------------------|
| Specification  | IEC 60664-1:2007-04 |
| Insulating material group                              | I                   |
| Comparative tracking index (IEC 60112)                 | CTI 600             |
| Rated insulation voltage (III/3)                       | 250 V               |
| Rated surge voltage (III/3)                            | 4 kV                |
| minimum clearance value - non-homogenous field (III/3) | 3 mm                |
| minimum creepage distance (III/3)                      | 3.2 mm              |
| Rated insulation voltage (III/2)                       | 320 V               |
| Rated surge voltage (III/2)                            | 4 kV                |
| minimum clearance value - non-homogenous field (III/2) | 3 mm                |
| minimum creepage distance (III/2)                      | 3 mm                |
| Rated insulation voltage (II/2)                        | 630 V               |

# MSTB 2,5/ 3-ST-5,08 BUBDWH:+-S - PCB connector



1161197

<https://www.phoenixcontact.com/us/products/1161197>

|   |        |
|---|--------|
| Rated surge voltage (II/2)                            | 4 kV   |
| minimum clearance value - non-homogenous field (II/2) | 3 mm   |
| minimum creepage distance (II/2)                      | 3.2 mm |

## Packaging specifications

|                   |                     |
|-------------------|---------------------|
| Type of packaging | packed in cardboard |
|-------------------|---------------------|

Drawings

Diagram

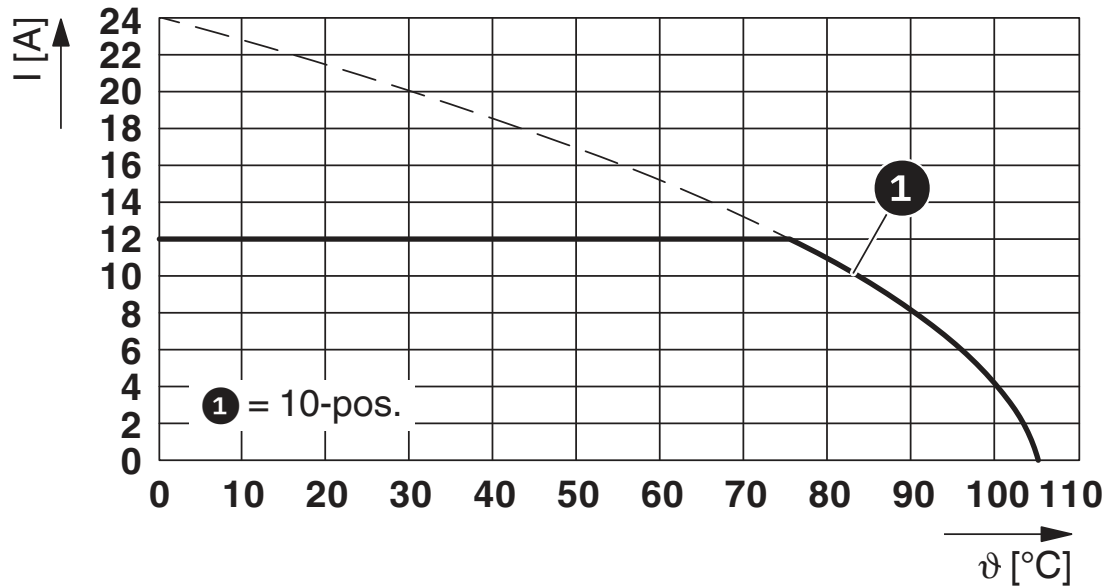

Type: MSTB 2,5/...-ST-5,08 with MSTBHK 2,5/...-G-5,08

Diagram

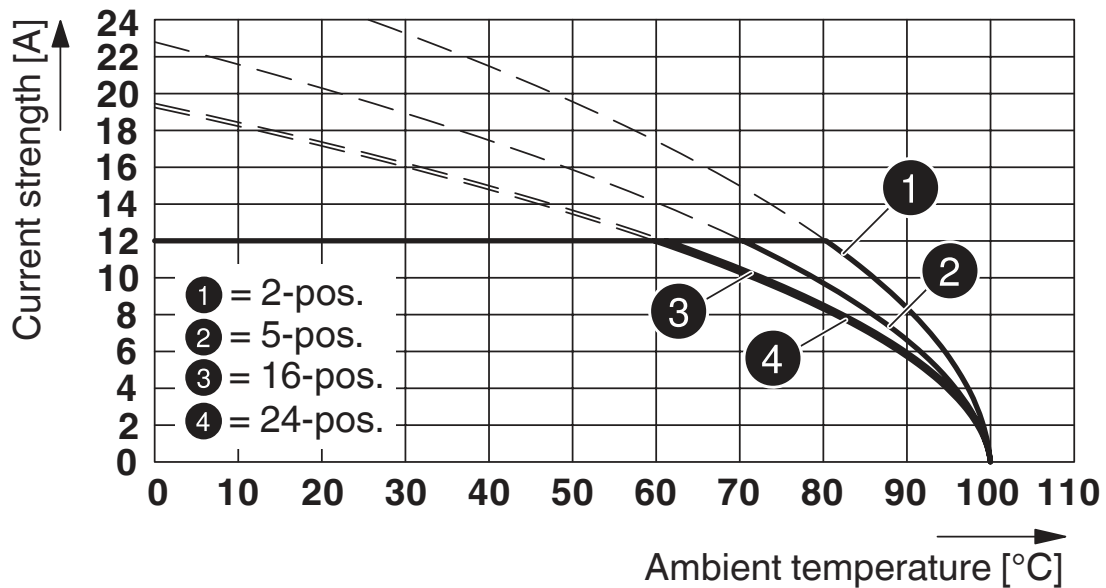

Type: MSTB 2,5/...-ST-5,08 with MSTBW 2,5/...-G-5,08

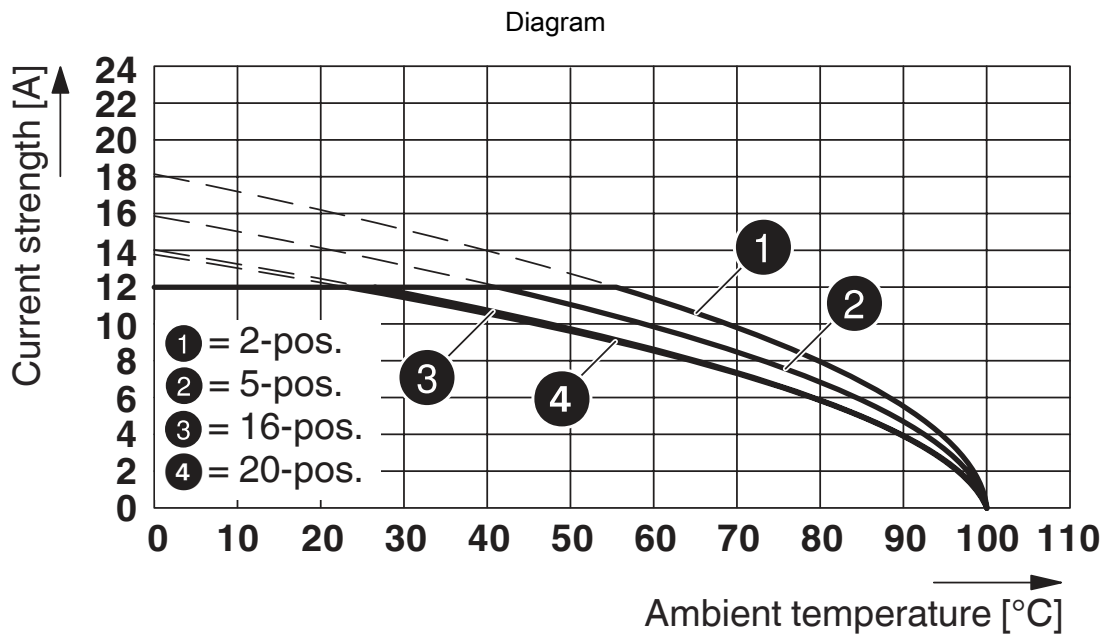

Type: MSTB 2,5/...-ST-5,08 with MSTBV 2,5/...-G-5,08

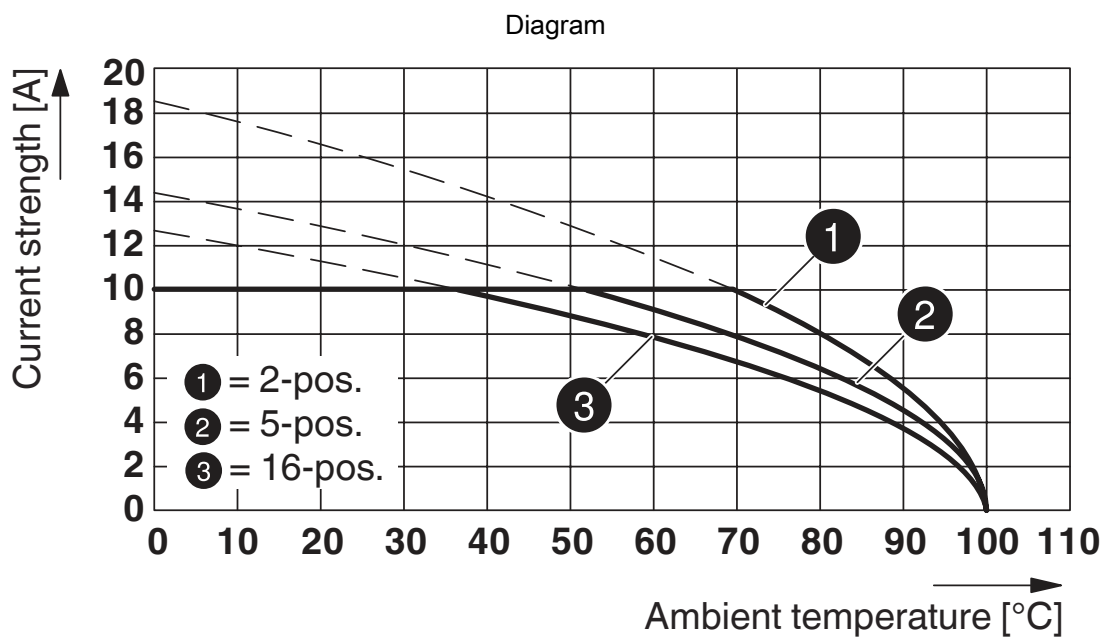

Type: MSTB 2,5/...-ST-5,08 with MDSTBVA 2,5/...-G-5,08



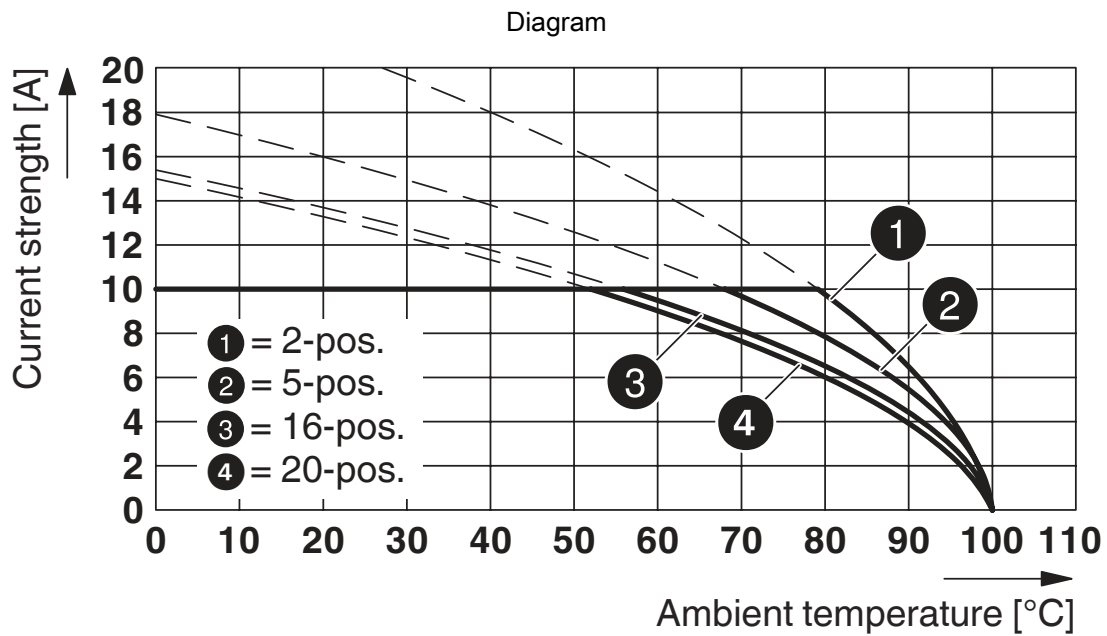

Type: MSTB 2,5/...-ST-5,08 with MDSTB 2,5/...-G1-5,08

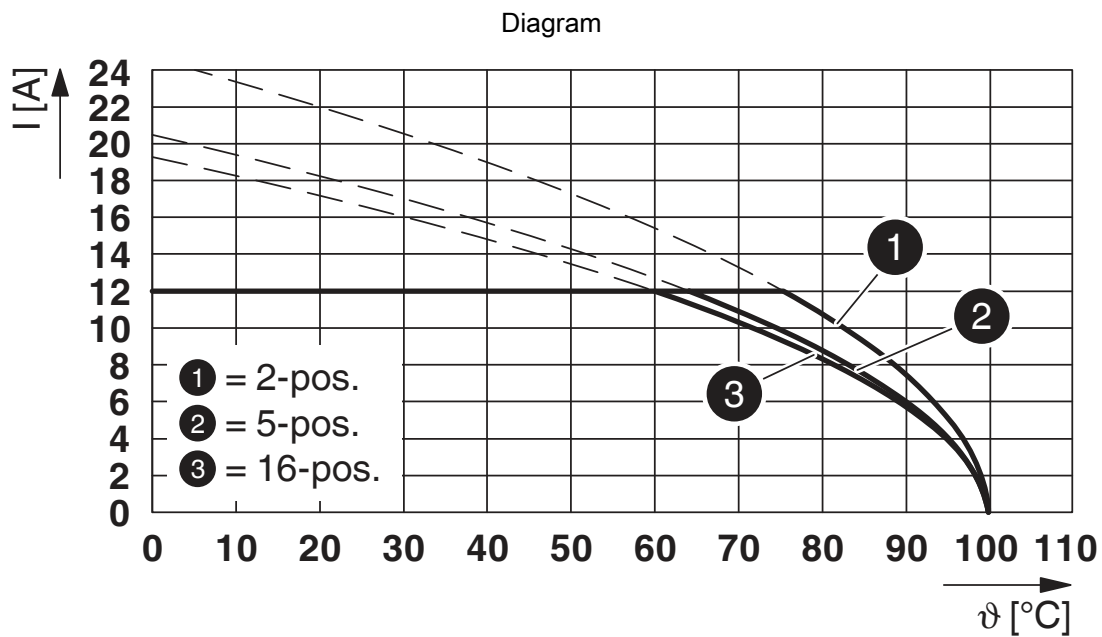

Type: MSTB 2,5/...-ST-5,08 with DFK-MSTBA 2,5/...-G-5,08

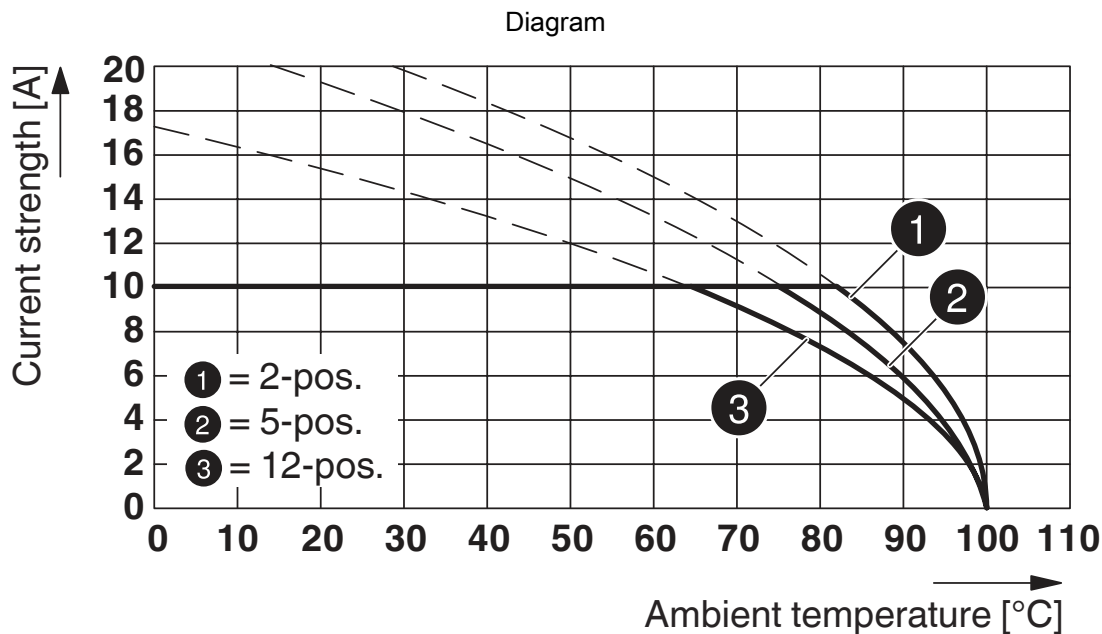

Type: MSTB 2,5/...-ST-5,08 with MDSTBW 2,5/...-G-5,08

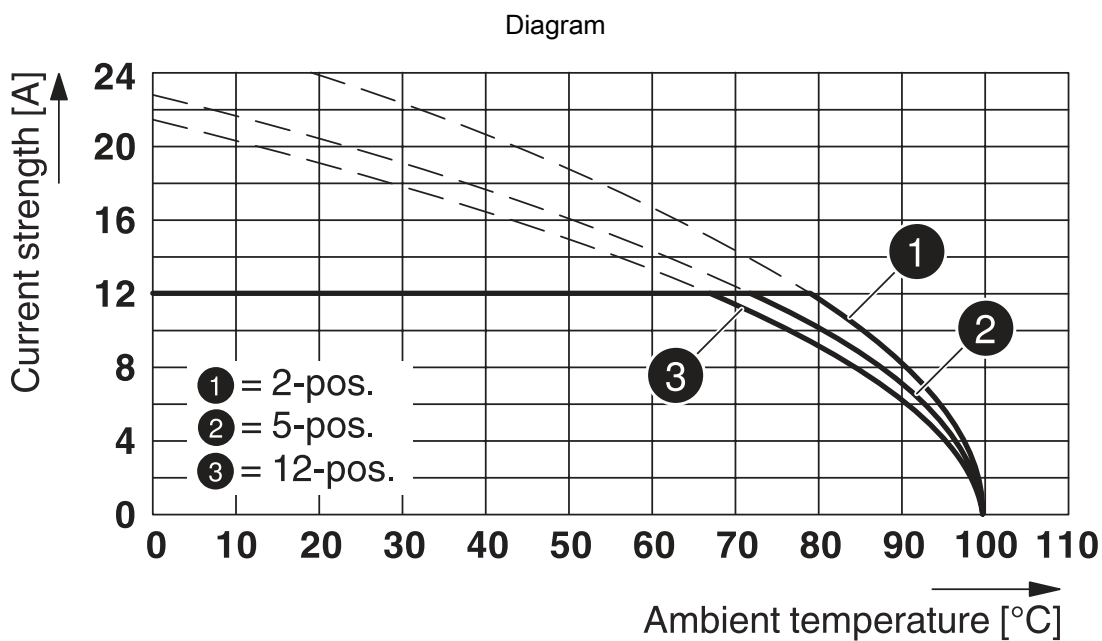

Type: MSTB 2,5/...-ST-5,08 with CCV 2,5/...-G-5,08 P26THR

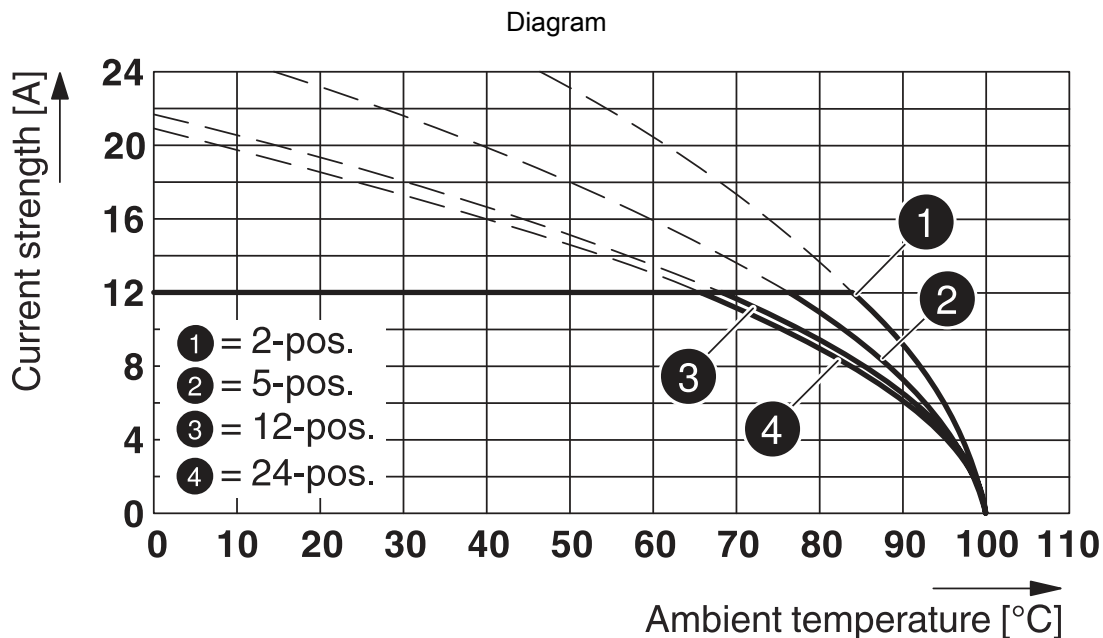

Type: MSTB 2,5/...-ST-5,08 with CCVA 2,5/...-G-5,08 P26THR

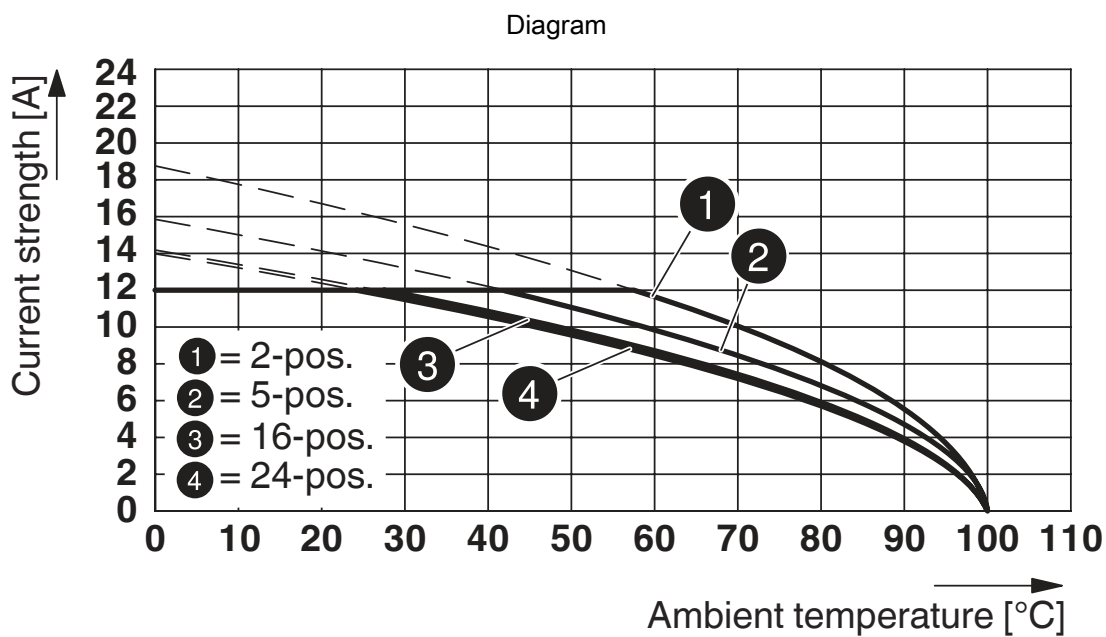

Type: MSTB 2,5/...-ST-5,08 with MSTBVA 2,5/...-G-5,08

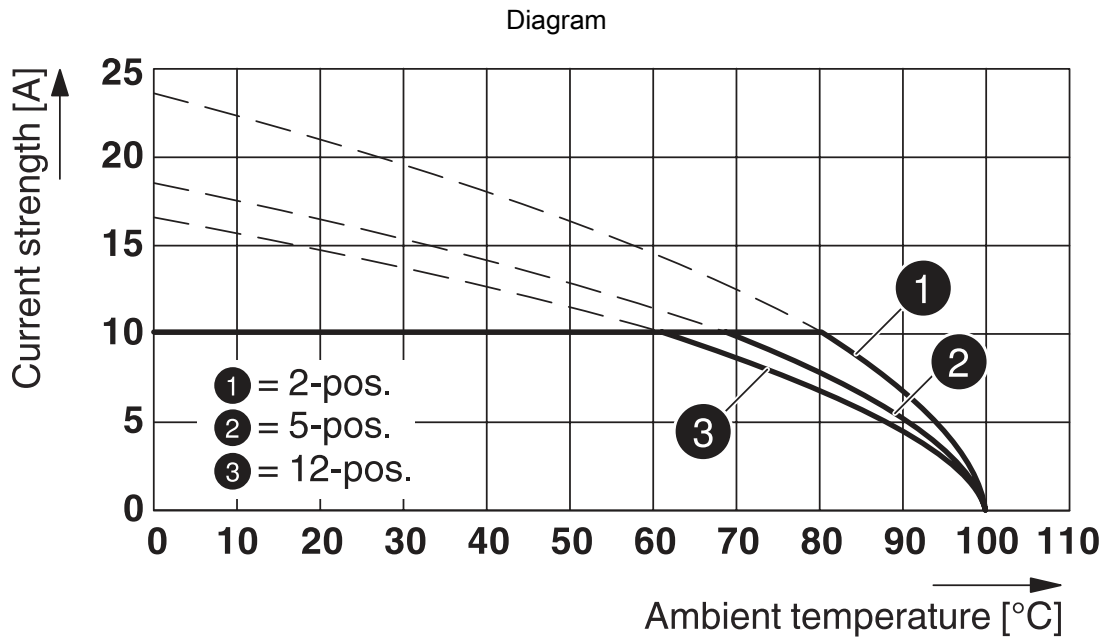

Type: MSTB 2,5/...-ST-5,08 with MDSTB 2,5/...-G-5,08

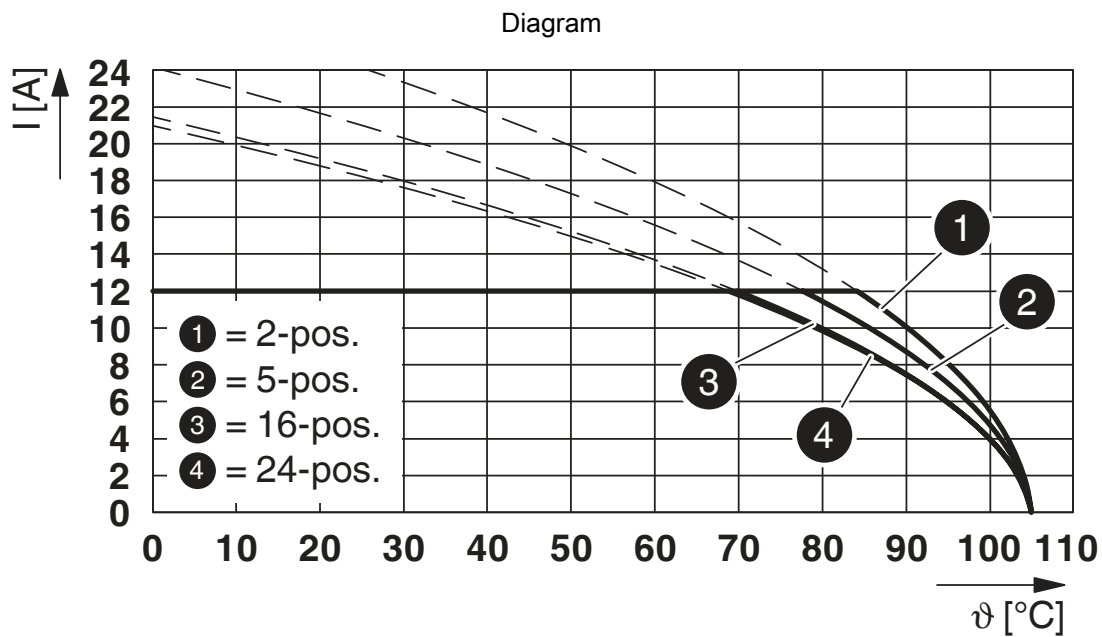

Type: MSTB 2,5/...-ST-5,08 with MSTBA 2,5/...-G-5,08

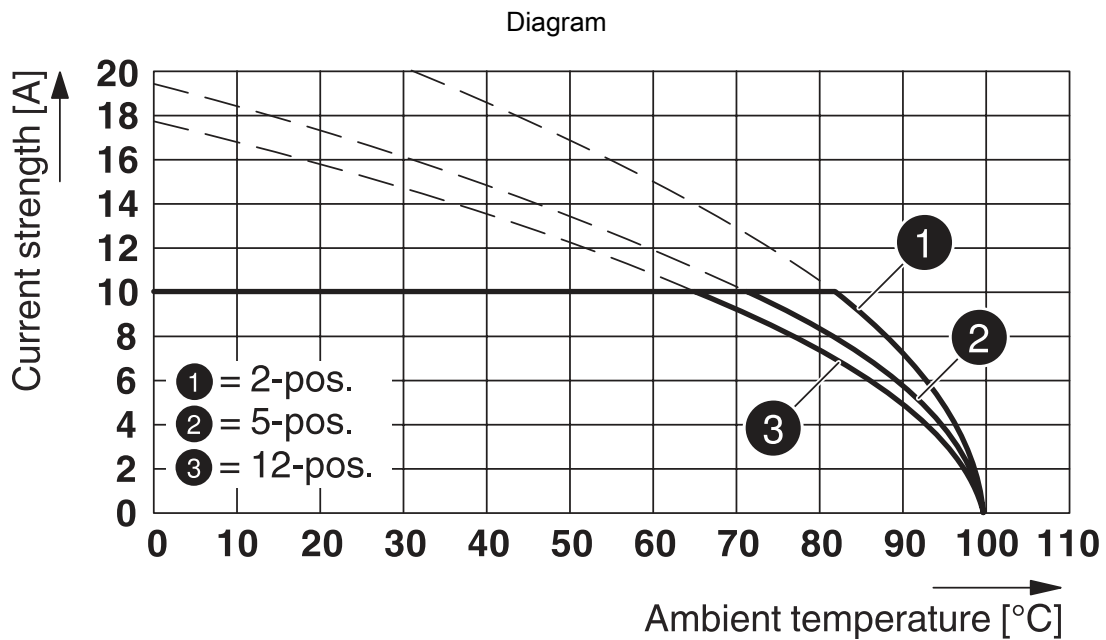

Type: MSTB 2,5/...-ST-5,08 with MDSTBA 2,5/...-G-5,08

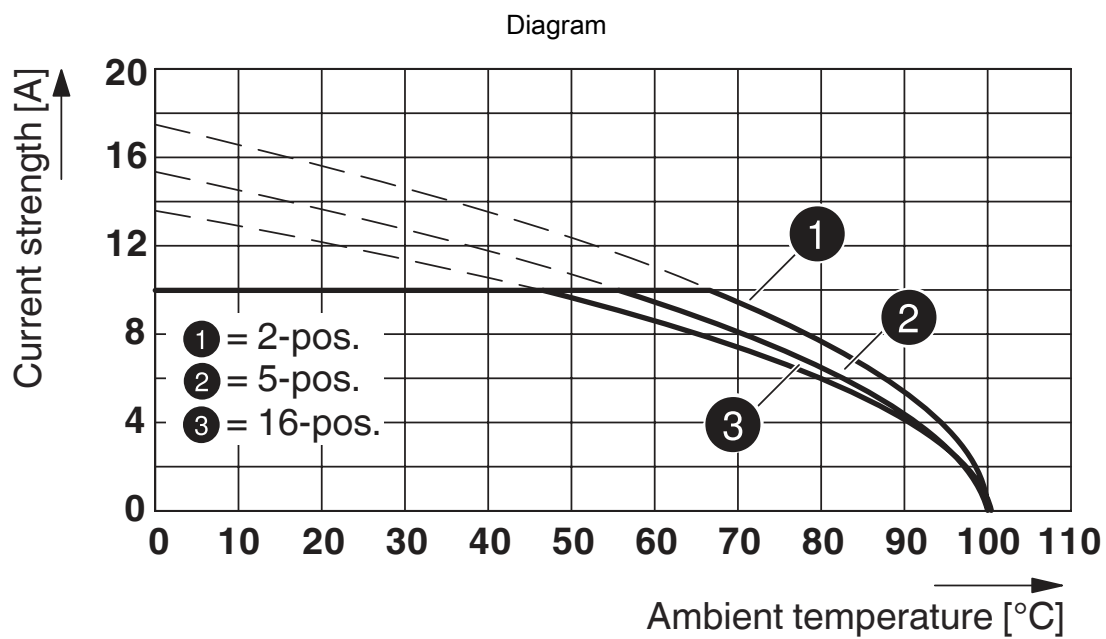

Type: MSTB 2,5/...-ST-5,08 with MDSTBV 2,5/...-G-5,08

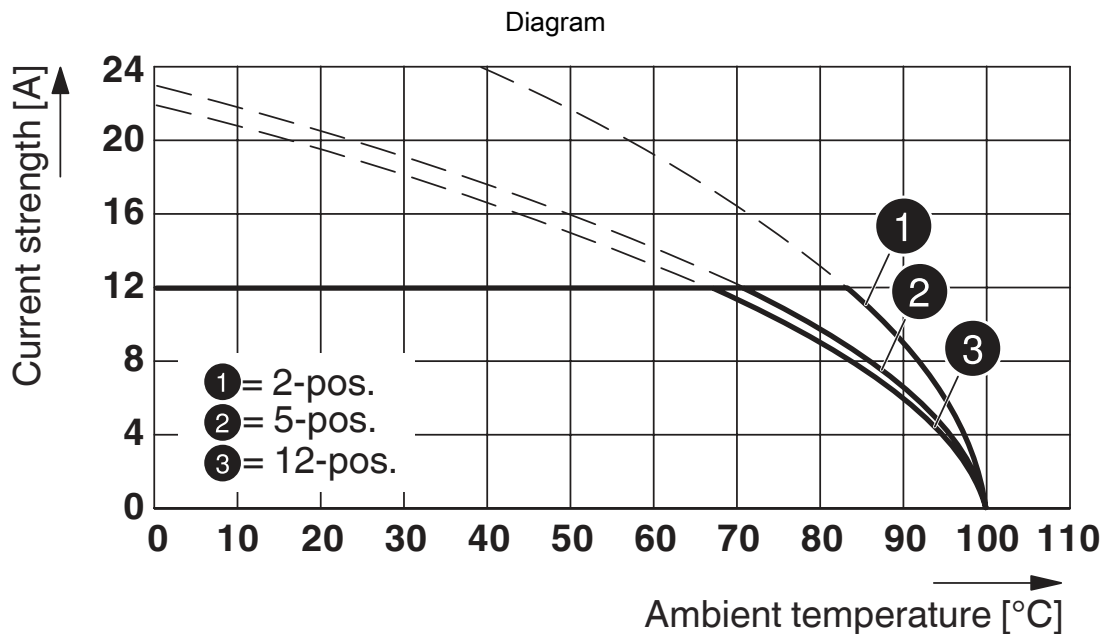

Type: MSTB 2,5/...-ST-5,08 with CC 2,5/...-G-5,08 P26THR

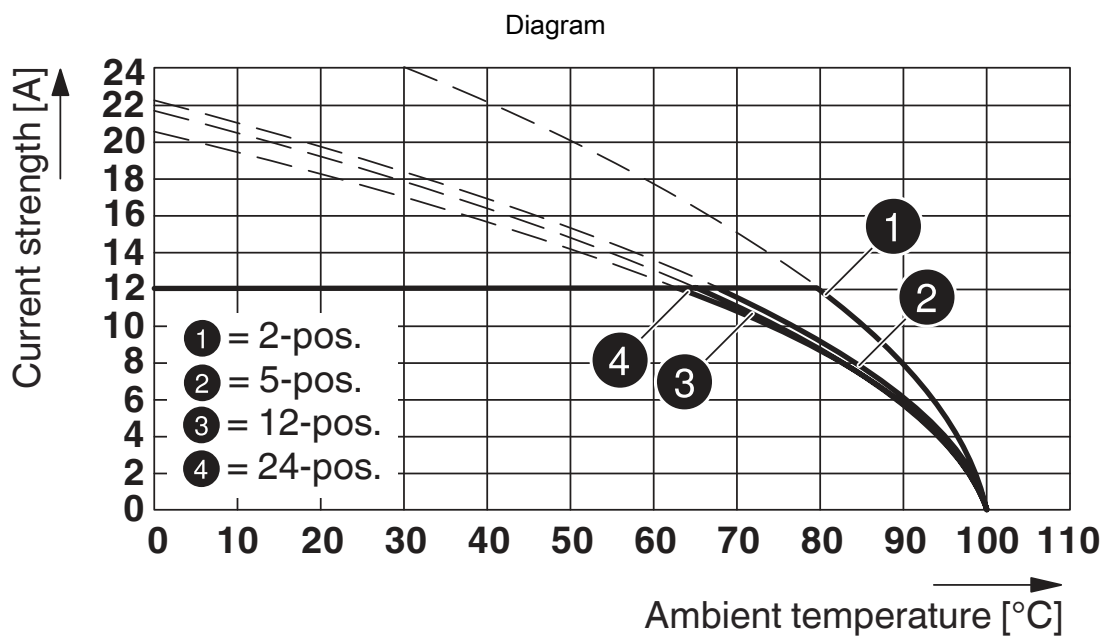

Type: MSTB 2,5/...-ST-5,08 with MSTB 2,5/...-G-5,08

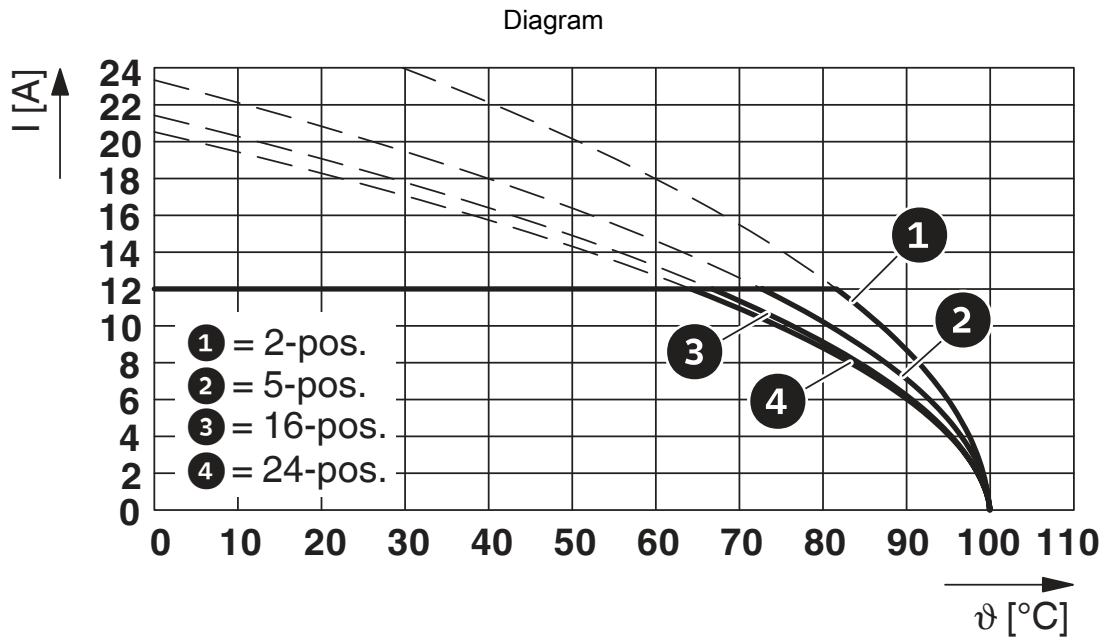

Type: MSTB 2,5/...-ST-5,08 with SMSTBA 2,5/...-G-5,08

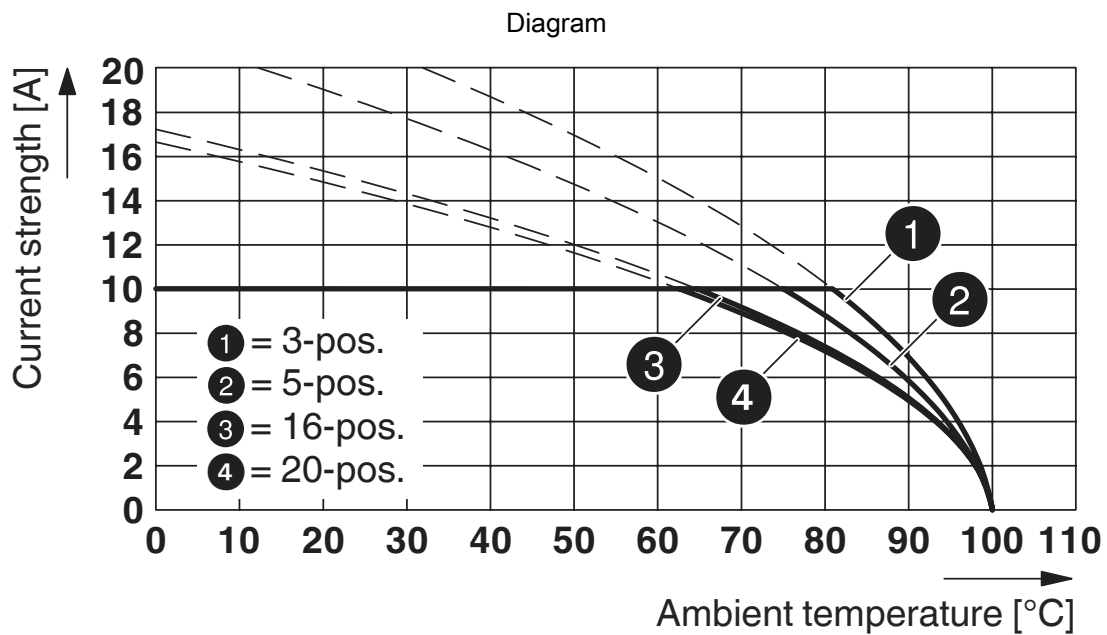

Type: MSTB 2,5/...-ST-5,08 with MDSTBV 2,5/...-G1-5,08

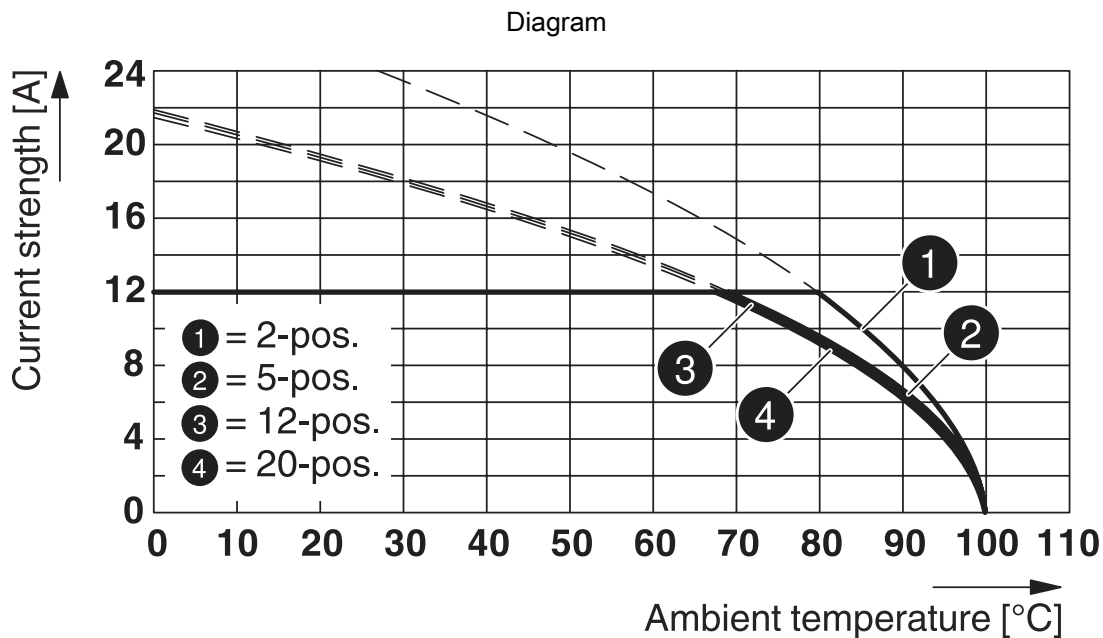

Type: MSTB 2,5/...-ST-5,08 with MVSTBU 2,5/...-GB-5,08

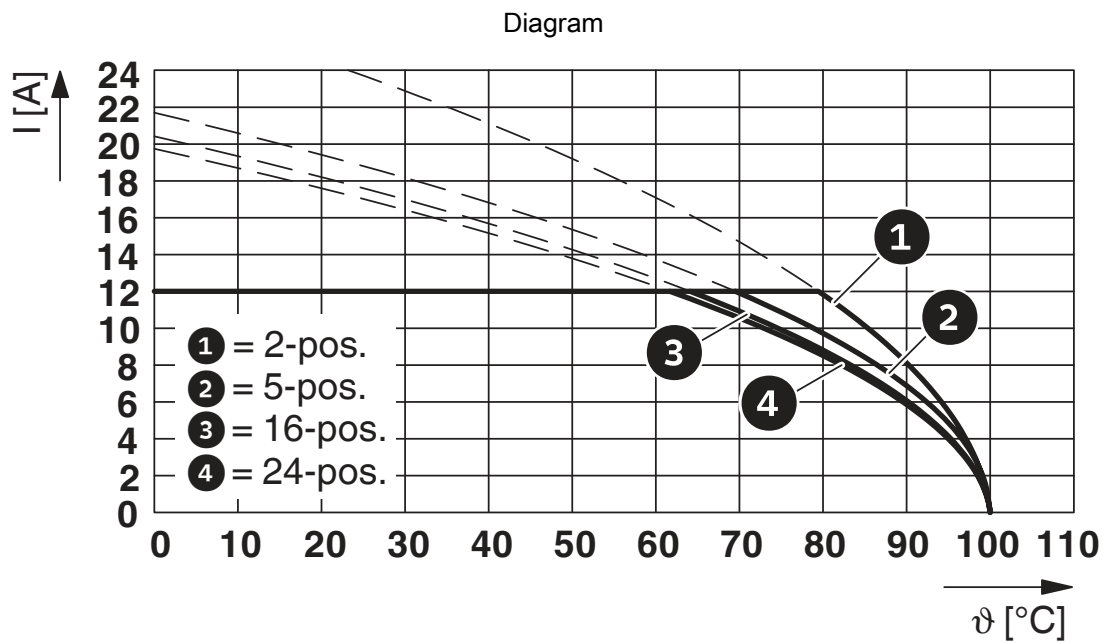

Type: MSTB 2,5/...-ST-5,08 with SMSTB 2,5/...-G-5,08



# MSTB 2,5/ 3-ST-5,08 BUBDWH:+-S - PCB connector





1161197

<https://www.phoenixcontact.com/us/products/1161197>

## Approvals

To download certificates, visit the product detail page: <https://www.phoenixcontact.com/us/products/1161197>

|  <b>CSA</b><br>Approval ID: 13631 |                       |                       |                   |                             |
|--|-----------------------|-----------------------|-------------------|-----------------------------|
|  | Nominal voltage $U_N$ | Nominal current $I_N$ | Cross section AWG | Cross section $\text{mm}^2$ |
| Use group B  | 300 V                 | 15 A                  | 28 - 12           | -                           |
| Use group D  | 300 V                 | 10 A                  | 28 - 12           | -                           |

|  <b>EAC</b><br>Approval ID: B.01687 |  |  |  |  |
|--|--|--|--|--|
|--|--|--|--|--|

|  <b>cULus Recognized</b><br>Approval ID: E60425-19931011 |                       |                       |                   |                             |
|---|-----------------------|-----------------------|-------------------|-----------------------------|
|   | Nominal voltage $U_N$ | Nominal current $I_N$ | Cross section AWG | Cross section $\text{mm}^2$ |
| Use group B   | 300 V                 | 15 A                  | 30 - 12           | -                           |
| Use group D   | 300 V                 | 10 A                  | 30 - 12           | -                           |

|  <b>VDE Zeichengenehmigung</b><br>Approval ID: 40050694 |                       |                       |                   |                             |
|--|-----------------------|-----------------------|-------------------|-----------------------------|
|  | Nominal voltage $U_N$ | Nominal current $I_N$ | Cross section AWG | Cross section $\text{mm}^2$ |
|  | 250 V                 | 12 A                  | -                 | 0.2 - 2.5                   |

# MSTB 2,5/ 3-ST-5,08 BUBDWH:+-S - PCB connector



1161197

<https://www.phoenixcontact.com/us/products/1161197>

## Classifications

### ECLASS

|             |          |
|-------------|----------|
| ECLASS-11.0 | 27460202 |
| ECLASS-12.0 | 27460202 |
| ECLASS-13.0 | 27460202 |

### ETIM

|          |          |
|----------|----------|
| ETIM 8.0 | EC002638 |
|----------|----------|

### UNSPSC

|             |          |
|-------------|----------|
| UNSPSC 21.0 | 39121400 |
|-------------|----------|

# MSTB 2,5/ 3-ST-5,08 BUBDWH:+-S - PCB connector



1161197

<https://www.phoenixcontact.com/us/products/1161197>

## Environmental product compliance

|            |   |
|------------|---|
| China RoHS | Environmentally friendly use period: unlimited = EFUP-e |
|            | No hazardous substances above threshold values          |

# MSTB 2,5/ 3-ST-5,08 BUBDWH:+-S - PCB connector



1161197

<https://www.phoenixcontact.com/us/products/1161197>

## Accessories

**i** Note: Applying some accessories below might limit this product.

### EBP 2- 5 - Insertion bridge

1733169

<https://www.phoenixcontact.com/us/products/1733169>

Insertion bridge for connectors with 5.0 mm or 5.08 mm pitch



**i** Max. current carrying capacity: 12 A

### EBP 3- 5 - Insertion bridge

1733172

<https://www.phoenixcontact.com/us/products/1733172>

Insertion bridge for connectors with 5.0 mm or 5.08 mm pitch



**i** Max. current carrying capacity: 12 A

# MSTB 2,5/ 3-ST-5,08 BUBDWH:+-S - PCB connector



1161197

<https://www.phoenixcontact.com/us/products/1161197>

## SZS 0,6X3,5 - Screwdriver

1205053

<https://www.phoenixcontact.com/us/products/1205053>



Actuation tool, for ST terminal blocks, insulated, also suitable for use as a bladed screwdriver, size: 0.6 x 3.5 x 100 mm, 2-component grip, with non-slip grip

---

## KGG-MSTB 2,5/ 3 - Cable housing

1803947

<https://www.phoenixcontact.com/us/products/1803947>



Cable housing, pitch: 0 mm, number of positions: 3, color: green

# MSTB 2,5/ 3-ST-5,08 BUBDWH:+-S - PCB connector



1161197

<https://www.phoenixcontact.com/us/products/1161197>

## CP-MSTB - Coding profile

1734634

<https://www.phoenixcontact.com/us/products/1734634>

Coding profile, is inserted into the slot on the plug or inverted header, red insulating material



---

## ME-SAS MINI - Shield connection clamp

2200456

<https://www.phoenixcontact.com/us/products/2200456>

Shield connection clamp for terminal points starting from 1.5 mm<sup>2</sup>



## MSTB 2,5/ 3-ST-5,08 BUBDWH:+-S - PCB connector



1161197

<https://www.phoenixcontact.com/us/products/1161197>

### ME-SAS - Shield connection clamp

2853899

<https://www.phoenixcontact.com/us/products/2853899>

Shield connection clamp for terminal points starting from 2.5 mm<sup>2</sup>



### MSTBW 2,5/ 3-G-5,08 - PCB header

1735879

<https://www.phoenixcontact.com/us/products/1735879>



PCB headers, nominal cross section: 2.5 mm<sup>2</sup>, color: green, nominal current: 12 A, rated voltage (III/2): 320 V, contact surface: Tin, contact connection type: Pin, number of potentials: 3, number of rows: 1, number of positions: 3, number of connections: 3, product range: MSTBW 2,5/...-G, pitch: 5.08 mm, mounting: Wave soldering, pin layout: Linear pinning, solder pin [P]: 3.5 mm, number of solder pins per potential: 1, plug-in system: COMBICON MSTB 2,5, Pin connector pattern alignment: Standard, locking: without, mounting: without, type of packaging: packed in cardboard

# MSTB 2,5/ 3-ST-5,08 BUBDWH:+-S - PCB connector



1161197

<https://www.phoenixcontact.com/us/products/1161197>

## MSTBVA 2,5/ 3-G-5,08 - PCB header

1755749

<https://www.phoenixcontact.com/us/products/1755749>

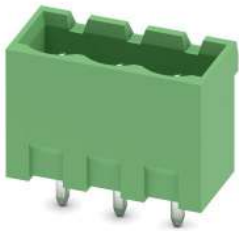

PCB headers, nominal cross section: 2.5 mm<sup>2</sup>, color: green, nominal current: 12 A, rated voltage (III/2): 320 V, contact surface: Tin, contact connection type: Pin, number of potentials: 3, number of rows: 1, number of positions: 3, number of connections: 3, product range: MSTBVA 2,5/..-G, pitch: 5.08 mm, mounting: Wave soldering, pin layout: Linear pinning, solder pin [P]: 3.9 mm, number of solder pins per potential: 1, plug-in system: COMBICON MSTB 2,5, Pin connector pattern alignment: Standard, locking: without, mounting: without, type of packaging: packed in cardboard

## MSTB 2,5/ 3-G-5,08 - PCB header

1759020

<https://www.phoenixcontact.com/us/products/1759020>



PCB headers, nominal cross section: 2.5 mm<sup>2</sup>, color: green, nominal current: 12 A, rated voltage (III/2): 320 V, contact surface: Tin, contact connection type: Pin, number of potentials: 3, number of rows: 1, number of positions: 3, number of connections: 3, product range: MSTB 2,5/..-G, pitch: 5.08 mm, mounting: Wave soldering, pin layout: Linear pinning, solder pin [P]: 3.5 mm, number of solder pins per potential: 1, plug-in system: COMBICON MSTB 2,5, Pin connector pattern alignment: Standard, locking: without, mounting: without, type of packaging: packed in cardboard



# MSTB 2,5/ 3-ST-5,08 BUBDWH:+-S - PCB connector



1161197

<https://www.phoenixcontact.com/us/products/1161197>

## SMSTBA 2,5/ 3-G-5,08 - PCB header

1767384

<https://www.phoenixcontact.com/us/products/1767384>



PCB headers, nominal cross section: 2.5 mm<sup>2</sup>, color: green, nominal current: 12 A, rated voltage (III/2): 320 V, contact surface: Tin, contact connection type: Pin, number of potentials: 3, number of rows: 1, number of positions: 3, number of connections: 3, product range: SMSTBA 2,5/..-G, pitch: 5.08 mm, mounting: Wave soldering, pin layout: Linear pinning, solder pin [P]: 3.5 mm, number of solder pins per potential: 1, plug-in system: COMBICON MSTB 2,5, Pin connector pattern alignment: Standard, locking: without, mounting: without, type of packaging: packed in cardboard

## SMSTB 2,5/ 3-G-5,08 - PCB header

1769476

<https://www.phoenixcontact.com/us/products/1769476>



PCB headers, nominal cross section: 2.5 mm<sup>2</sup>, color: green, nominal current: 12 A, rated voltage (III/2): 320 V, contact surface: Tin, contact connection type: Pin, number of potentials: 3, number of rows: 1, number of positions: 3, number of connections: 3, product range: SMSTB 2,5/..-G, pitch: 5.08 mm, mounting: Wave soldering, pin layout: Linear pinning, solder pin [P]: 3.5 mm, number of solder pins per potential: 1, plug-in system: COMBICON MSTB 2,5, Pin connector pattern alignment: Standard, locking: without, mounting: without, type of packaging: packed in cardboard

# MSTB 2,5/ 3-ST-5,08 BUBDWH:+-S - PCB connector



1161197

<https://www.phoenixcontact.com/us/products/1161197>

## MSTBO 2,5/ 3-GL-5,08 - PCB header

1850440

<https://www.phoenixcontact.com/us/products/1850440>



PCB headers, nominal cross section: 2.5 mm<sup>2</sup>, color: green, nominal current: 8 A, rated voltage (III/2): 320 V, contact surface: Tin, contact connection type: Pin, number of potentials: 3, number of rows: 1, number of positions: 3, number of connections: 3, product range: MSTBO 2,5/...-GL, pitch: 5.08 mm, mounting: Wave soldering, pin layout: Linear pinning, solder pin [P]: 3.2 mm, number of solder pins per potential: 1, plug-in system: COMBICON MSTB 2,5, locking: without, mounting: without, type of packaging: packed in cardboard

## DFK-MSTBA 2,5/ 3-G-5,08 - Feed-through header

1898842

<https://www.phoenixcontact.com/us/products/1898842>



Feed-through header, nominal cross section: 2.5 mm<sup>2</sup>, color: green, nominal current: 12 A, rated voltage (III/2): 320 V, contact surface: Tin, contact connection type: Pin, number of potentials: 3, number of rows: 1, number of positions: 3, number of connections: 3, product range: DFK-MSTBA 2,5/...-G, pitch: 5.08 mm, mounting: Wave soldering, pin layout: Linear pinning, solder pin [P]: 3.2 mm, number of solder pins per potential: 1, plug-in system: COMBICON MSTB 2,5, Pin connector pattern alignment: Standard, locking: without, mounting: without, type of packaging: packed in cardboard

# MSTB 2,5/ 3-ST-5,08 BUBDWH:+-S - PCB connector



1161197

<https://www.phoenixcontact.com/us/products/1161197>

## DFK-MSTBVA 2,5/ 3-G-5,08 - Feed-through header

1899142

<https://www.phoenixcontact.com/us/products/1899142>



Feed-through header, nominal cross section: 2.5 mm<sup>2</sup>, color: green, nominal current: 12 A, rated voltage (III/2): 320 V, contact surface: Tin, contact connection type: Pin, number of potentials: 3, number of rows: 1, number of positions: 3, number of connections: 3, product range: DFK-MSTBVA 2,5/..-G, pitch: 5.08 mm, mounting: Wave soldering, pin layout: Linear pinning, solder pin [P]: 3.9 mm, number of solder pins per potential: 1, plug-in system: COMBICON MSTB 2,5, Pin connector pattern alignment: Standard, locking: without, mounting: without, type of packaging: packed in cardboard

## CC 2,5/ 3-G-5,08 P26THR - PCB header

1954391

<https://www.phoenixcontact.com/us/products/1954391>



PCB headers, nominal cross section: 2.5 mm<sup>2</sup>, color: black, nominal current: 12 A, rated voltage (III/2): 320 V, contact surface: Tin, contact connection type: Pin, number of potentials: 3, number of rows: 1, number of positions: 3, number of connections: 3, product range: CC 2,5/..-G, pitch: 5.08 mm, mounting: THR soldering, pin layout: Linear pinning, solder pin [P]: 2.6 mm, number of solder pins per potential: 1, plug-in system: COMBICON MSTB 2,5, Pin connector pattern alignment: Standard, locking: without, mounting: without, type of packaging: packed in cardboard, For user information and design recommendations for through-hole reflow technology, go to: Downloads

# MSTB 2,5/ 3-ST-5,08 BUBDWH:+-S - PCB connector



1161197

<https://www.phoenixcontact.com/us/products/1161197>

## CC 2,5/ 3-G-5,08 P26THRR32 - PCB header

1954595

<https://www.phoenixcontact.com/us/products/1954595>



PCB headers, nominal cross section: 2.5 mm<sup>2</sup>, color: black, nominal current: 12 A, rated voltage (III/2): 320 V, contact surface: Tin, contact connection type: Pin, number of potentials: 3, number of rows: 1, number of positions: 3, number of connections: 3, product range: CC 2,5/..-G, pitch: 5.08 mm, mounting: THR soldering, pin layout: Linear pinning, solder pin [P]: 2.6 mm, number of solder pins per potential: 1, plug-in system: COMBICON MSTB 2,5, Pin connector pattern alignment: Standard, locking: without, mounting: without, type of packaging: 32 mm wide tape, For user information and design recommendations for through-hole reflow technology, go to: Downloads

## CCA 2,5/ 3-G-5,08 P26THR - PCB header

1954922

<https://www.phoenixcontact.com/us/products/1954922>



PCB headers, nominal cross section: 2.5 mm<sup>2</sup>, color: black, nominal current: 12 A, rated voltage (III/2): 320 V, contact surface: Tin, contact connection type: Pin, number of potentials: 3, number of rows: 1, number of positions: 3, number of connections: 3, product range: CCA 2,5/..-G, pitch: 5.08 mm, connection method: Plug-in connection, mounting: THR soldering, pin layout: Linear pinning, solder pin [P]: 2.6 mm, number of solder pins per potential: 1, plug-in system: COMBICON MSTB 2,5, Pin connector pattern alignment: Standard, locking: without, mounting: without, type of packaging: packed in cardboard, For user information and design recommendations for through-hole reflow technology, go to: Downloads

# MSTB 2,5/ 3-ST-5,08 BUBDWH:+-S - PCB connector



1161197

<https://www.phoenixcontact.com/us/products/1161197>

## CCA 2,5/ 3-G-5,08 P26THRR32 - PCB header

1955044

<https://www.phoenixcontact.com/us/products/1955044>



PCB headers, nominal cross section: 2.5 mm<sup>2</sup>, color: black, nominal current: 12 A, rated voltage (III/2): 320 V, contact surface: Tin, contact connection type: Pin, number of potentials: 3, number of rows: 1, number of positions: 3, number of connections: 3, product range: CCA 2,5/..-G, pitch: 5.08 mm, connection method: Plug-in connection, mounting: THR soldering, pin layout: Linear pinning, solder pin [P]: 2.6 mm, number of solder pins per potential: 1, plug-in system: COMBICON MSTB 2,5, Pin connector pattern alignment: Standard, locking: without, mounting: without, type of packaging: 32 mm wide tape, For user information and design recommendations for through-hole reflow technology, go to: Downloads

## CCV 2,5/ 3-G-5,08 P26THR - PCB header

1955390

<https://www.phoenixcontact.com/us/products/1955390>



PCB headers, nominal cross section: 2.5 mm<sup>2</sup>, color: black, nominal current: 12 A, rated voltage (III/2): 320 V, contact surface: Tin, contact connection type: Pin, number of potentials: 3, number of rows: 1, number of positions: 3, number of connections: 3, product range: CCV 2,5/..-G, pitch: 5.08 mm, mounting: THR soldering, pin layout: Linear pinning, solder pin [P]: 2.6 mm, number of solder pins per potential: 1, plug-in system: COMBICON MSTB 2,5, Pin connector pattern alignment: Standard, locking: without, mounting: without, type of packaging: packed in cardboard, For user information and design recommendations for through-hole reflow technology, go to: Downloads

# MSTB 2,5/ 3-ST-5,08 BUBDWH:+-S - PCB connector



1161197

<https://www.phoenixcontact.com/us/products/1161197>

## CCV 2,5/ 3-G-5,08 P26THRR32 - PCB header

1955536

<https://www.phoenixcontact.com/us/products/1955536>



PCB headers, nominal cross section: 2.5 mm<sup>2</sup>, color: black, nominal current: 12 A, rated voltage (III/2): 320 V, contact surface: Tin, contact connection type: Pin, number of potentials: 3, number of rows: 1, number of positions: 3, number of connections: 3, product range: CCV 2,5/...-G, pitch: 5.08 mm, mounting: THR soldering, pin layout: Linear pinning, solder pin [P]: 2.6 mm, number of solder pins per potential: 1, plug-in system: COMBICON MSTB 2,5, Pin connector pattern alignment: Standard, locking: without, mounting: without, type of packaging: 32 mm wide tape, For user information and design recommendations for through-hole reflow technology, go to: Downloads

## CCVA 2,5/ 3-G-5,08 P26THR - PCB header

1955866

<https://www.phoenixcontact.com/us/products/1955866>



PCB headers, nominal cross section: 2.5 mm<sup>2</sup>, color: black, nominal current: 12 A, rated voltage (III/2): 320 V, contact surface: Tin, contact connection type: Pin, number of potentials: 3, number of rows: 1, number of positions: 3, number of connections: 3, product range: CCVA 2,5/...-G, pitch: 5.08 mm, mounting: THR soldering, pin layout: Linear pinning, solder pin [P]: 2.6 mm, number of solder pins per potential: 1, plug-in system: COMBICON MSTB 2,5, Pin connector pattern alignment: Standard, locking: without, mounting: without, type of packaging: packed in cardboard, For user information and design recommendations for through-hole reflow technology, go to: Downloads

# MSTB 2,5/ 3-ST-5,08 BUBDWH:+-S - PCB connector



1161197

<https://www.phoenixcontact.com/us/products/1161197>

## CCVA 2,5/ 3-G-5,08 P26THRR32 - PCB header

1955976

<https://www.phoenixcontact.com/us/products/1955976>



PCB headers, nominal cross section: 2.5 mm<sup>2</sup>, color: black, nominal current: 12 A, rated voltage (III/2): 320 V, contact surface: Tin, contact connection type: Pin, number of potentials: 3, number of rows: 1, number of positions: 3, number of connections: 3, product range: CCVA 2,5/...-G, pitch: 5.08 mm, mounting: THR soldering, pin layout: Linear pinning, solder pin [P]: 2.6 mm, number of solder pins per potential: 1, plug-in system: COMBICON MSTB 2,5, Pin connector pattern alignment: Standard, locking: without, mounting: without, type of packaging: 32 mm wide tape, For user information and design recommendations for through-hole reflow technology, go to: Downloads

---

Phoenix Contact 2023 © - all rights reserved

<https://www.phoenixcontact.com>

Phoenix Contact USA  
586 Fulling Mill Road  
Middletown, PA 17057, United States  
(+717) 944-1300  
[info@phoenixcon.com](mailto:info@phoenixcon.com)