



Energy Harvesting: Eliminating Battery Replacements for IoT Nodes With 196 HVC ENYCAP™

By Tassilo Gernandt and Gerald Tatschl

MAL219699005E3

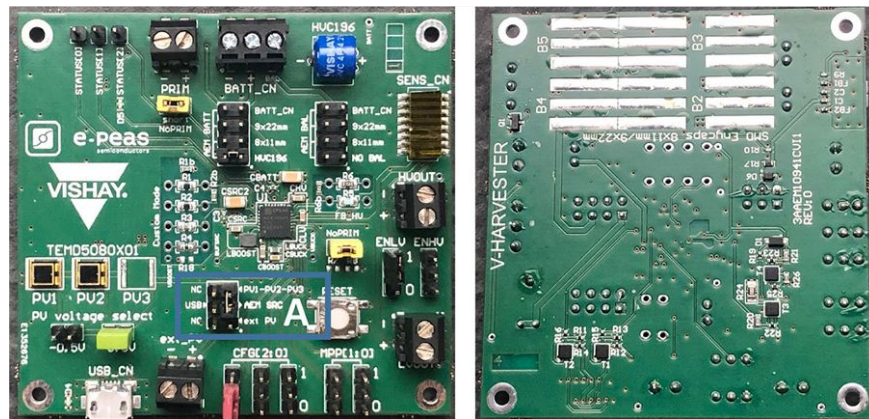
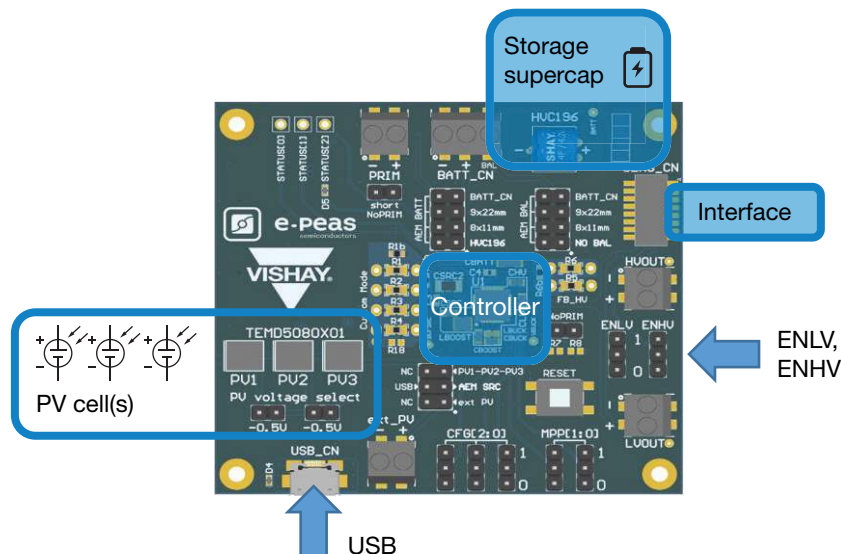

Fig. 1 - V-harvester board

DESCRIPTION

The V-harvester board is a photovoltaic (PV) harvesting backup demonstration circuit. It is a sophisticated stand-alone board charged using TEMD5080X01 micro PV cells or with micro USB. The input power goes into an e-peas low power AEM10941 controller, where it is stepped up to the supercapacitor voltage of 4.2 V. Upon power demands at the interface or ENLV, ENHV settings, the controller converts the supply voltage to the target voltages using low dropout regulators (LDO).



TECHNICAL NOTE

The DNA of tech.™

Energy Harvesting: Eliminating Battery Replacements for IoT Nodes With 196 HVC ENYCAP™

These target voltages are set to 1.8 V (low voltage) and 2.5 V (high voltage) on this board by a high ohmic resistor network. The board is equipped with a 4 F / 4.2 V 196 HVC ENYCAP™ hybrid energy storage capacitor, and has options to jumper to other storage capacitors on the backside (or a BATT_CN = battery connector).

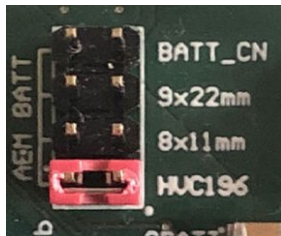

Fig. 2 - Jumper AEM_BATT set to 196 HVC ENYCAP™ (by default populated as 4.2 V / 4 F)

If faster charging is needed, an external PV cell can be connected (and jumpered). If no light harvesting is available, jumper A can be set to USB.

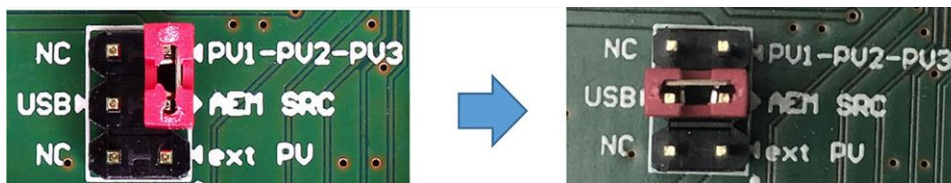

Fig. 3 - AEM SRC set to PV1-3, or AEM SRC set to USB

Upon connection of a 5 V micro USB cable, the red LED close to the USB port turns on and the “Status 2” green LED will flash once every ~ 5 seconds.

LIFE WORKING SIGNAL

The green Status 2 LED indicator is available to view as a periodic life signal. This indicator is active - even if AEM SRC is jumpered to sources other than USB - to visualize operation. However, as described in the last section, only if USB is connected. This means the power to flash this indicator is drawn from USB only and will not consume power otherwise. Status 2 is the MPPT signal by the controller and is always active, even in very dark conditions. If the indicator does not flash periodically, then the PV cell boost circuit was shut down by a PV input voltage below 50 mV. To reactivate it, an initial trigger of at least 400 mV PV voltage or a kick-start by a USB input source - including jumper USB to AEM ARC - is required.

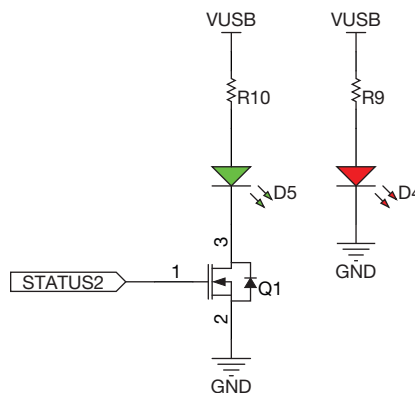
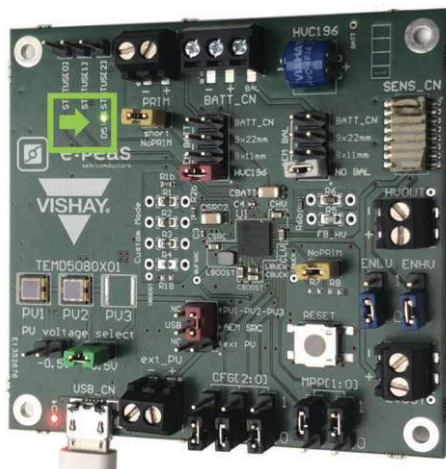

Fig. 4 - Status 2 green LED indicator (actually flashing) + RED LED to indicate USB port power

The DNA of tech.™

Energy Harvesting: Eliminating Battery Replacements for IoT Nodes With 196 HVC ENYCAP™

MINIMAL JUMPER SETTINGS

1. Yellow jumpers “PRIM / NoPrim” for no primary cell attached
2. Green jumper “-0.5 V” for PV setting, as described in the next paragraph (pictured is one possibility)
3. AEM Batt setting to any of the sources (here, an upper red jumper to the 196 HVC)
4. AEM SRC setting either to PV or USB (here, the lower red jumper to PV1 - PV3)
5. CFG2 [CFG[2:0] left] set to zero to define the 1.8 V and 2.5 V default settings (custom voltage defined by resistors) (black jumper)

The minimum for activating the low voltage 1.8 V output is setting the ENLV jumper to 1 (blue jumper).

The minimum for activating the high voltage 2.5 V output is setting the ENHV jumper to 1 (blue jumper).

The ENHV can be controlled from the SENS_CN interface too.

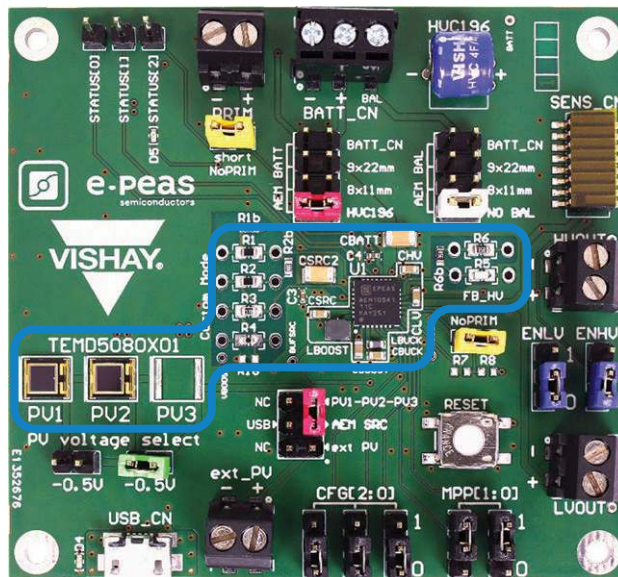

PHOTOVOLTAIC HARVESTING ELEMENTS

The board is equipped by default with two PV cells, and the target input should be jumpered with the green jumper JP4 shown above to bypass PV3.

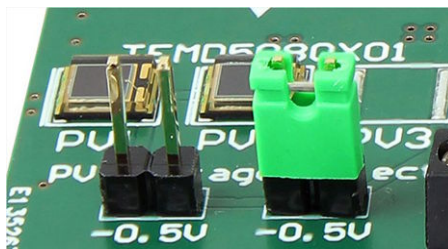

The schematic for the configuration is:

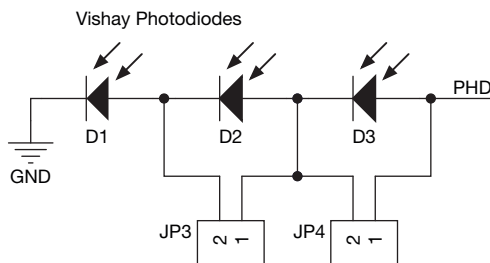

The term “-0.5 V” refers to the possibility of subtracting 0.5 V in direct sunlight if operation with fewer PV cells than populated is tested. The right jumper is required if two PV cells are populated.

The DNA of tech.™

Energy Harvesting: Eliminating Battery Replacements for IoT Nodes With 196 HVC ENYCAP™

PV RESPONSE OF THE TEMD5080X01

The silicon PIN photodiode is a blue enhanced version of many other Vishay PIN photodiodes of the same size. It has an effective sensitive area of 7.7 mm² and can deliver up to 2 mA at direct sunlight and 1.5 AM.

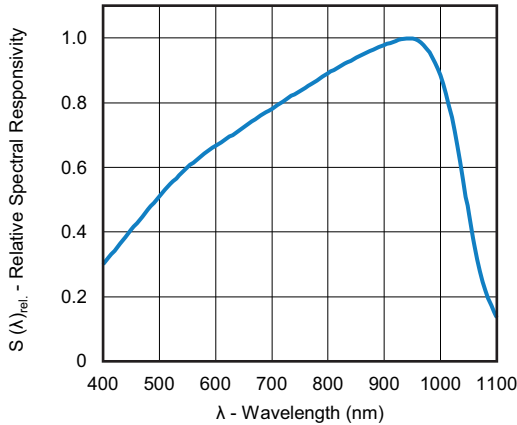
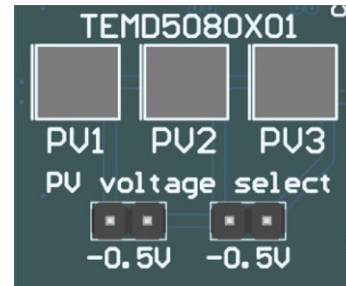

Fig. 5 - Relative spectral sensitivity vs. wavelength



Measurements were carried out with a 100 W incandescent light bulb and a dimmable office LED bulb to replicate cloudy / sunny weather.

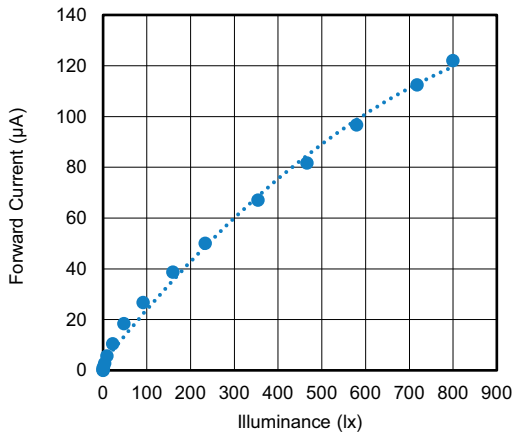

Fig. 6 - 100 W incandescent light bulb (max. 120 µA at 800 lx)

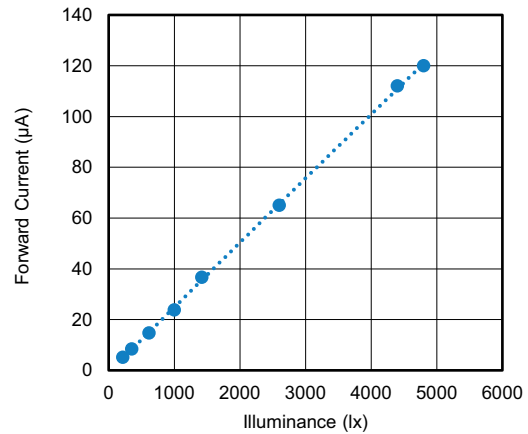

Fig. 7 - LED - 2700 K 45 mA dimmable (max. 120 µA at 4800 lx)

The DNA of tech.™

Energy Harvesting: Eliminating Battery Replacements for IoT Nodes With 196 HVC ENYCAP™

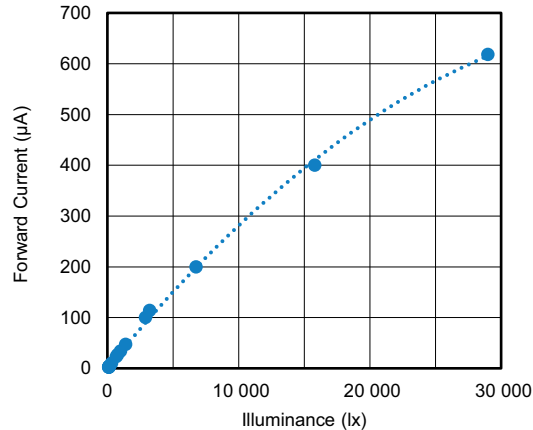

Fig. 8 - PV response at direct sunlight

VOLTAGE SETTINGS

The high ohmic voltage divider is composed of resistors, which in total do not consume more than 0.1 µA of power.

This includes the following resistors:

- RCWP040220M0FKEC - 0402 1 % thick film 20 MΩ - industrial / high reliability
- MCT06030C1005FP500 - 0603 ± 1 % thin film 10 MΩ, professional thin film chip resistors

The voltage divider is optimized for long lasting IoT operational life.

In the following designators:

- R1 is made of series R1 and R1b
- R2 is made of series R2 and R2b
- R6 is made of series R6 and R6b to accomplish the target values

CALCULATION OF TARGET OHMIC VALUES AND TRUE VOLTAGE OUTCOMES					
CUSTOM MODE CONFIGURATION (AVAILABLE FOR: AEM10941 TO AEM30940)					Vovch 4.31 V
STEP 1	Vovdis (V)	2.8	Define the overdischarge level for the battery		2.8
	Vchrdy (V)	2.9	Define the enable level of the LDO's		2.9
	Vovch (V)	4.29	Define the overcharge level for the battery		4.29
	Vhv (V)	2.5	Define the output voltage of the HVOOUT		2.5
STEP 2	RT (MΩ)	31.1	Choose a value between 1 MΩ and 100 MΩ	31.1	
	RV (MΩ)	25.0	Choose a value between 1 MΩ and 40 MΩ	25.0	
RESULTS	R1 (MΩ)	7.25		7.25	
	R2 (MΩ)	3.48		3.48	
	R3 (MΩ)	0.38		0.38	
	R4 (MΩ)	20.0		20.0	
	R5 (MΩ)	10.0		10.0	
	R6 (MΩ)	15.0		15.0	



The DNA of tech.™

Energy Harvesting: Eliminating Battery Replacements for IoT Nodes With 196 HVC ENYCAP™

This table shows the ideal values in column 3 and the used values in the last column to accomplish the following voltages:

- Minimum voltage for the storage capacitor = 2.8 V
- Enable voltage level for the HV LDO = 2.9 V (HV is generated by tge LDO from the storage capacitor voltage)
- Maximum voltage for the storage capacitor = 4.29 V
- High voltage output level = 2.5 V

The results are R1 to R6, which are in total 55 MΩ attached to the Vboost regulator output.

The LV 1.8 V output is the default (see next table).

OTHER VOLTAGE SETTINGS

Other voltages than the resistor network defined are possible with the CFG0 to CFG2 jumpers.

CONFIGURATION PINS			STORAGE ELEMENT THRESHOLD VOLTAGES			LODS OUTPUT VOLTAGES		TYPICAL USE
CFG (2)	CFG (1)	CFG (0)	Vovch	Vchrdy	Vovdis	Vhv	Vlv	
1	1	1	4.12 V	3.67 V	3.60 V	3.3 V	1.8 V	Li-on battery
1	1	0	4.12 V	4.04 V	3.60 V	3.3 V	1.8 V	Solid state battery
1	0	1	4.12 V	3.67 V	3.01 V	2.5 V	1.8 V	Li-on / NiMH battery
1	0	0	2.70 V	2.30 V	2.20 V	1.8 V	1.2 V	Single-cell supercapacitor
0	1	1	4.50 V	3.67 V	2.80 V	2.5 V	1.8 V	Dual-cell supercapacitor
0	1	0	4.50 V	3.92 V	3.60 V	3.3 V	1.8 V	Dual-cell supercapacitor
0	0	1	3.63 V	3.10 V	2.80 V	2.5 V	1.8 V	LiFePO4 battery
0	0	0	Custom mode - programmable through R1 to R6				1.8 V	

The custom mode Voch means V = 4.29 V as a cut-off charge voltage, as defined in the 196 HVC ENYCAP™ datasheet. Do not jumper CFG1 to one unless jumpered to a source other than the 196 HVC ENYCAP™ at AEM BATT!

Vchrdy means that from this voltage on, the LDOs will work on this board by resistors defined to V = 2.9 V (assuming a dropout of the HV LDO has enough margin to power up to 80 mA at 2.5 V).

Vovdis means a discharge cutoff voltage of the controller (entering shutdown), but on this board by resistors defined to V = 2.8 V. Assuming no LDO is being used, the 196 HVC is not to be used below this voltage level and is therefore waiting to be reset or kick-started by a USB port charge or other source current trigger. The RESET button on the board is only required if CFG jumpers are modified and the resistor network is modified, e.g., to open or other values. By default, resistors are present and define and hold all voltages.

LOW VOLTAGE AND SHUT DOWN PROCEDURES

There is an operation in place below the 2.8 V ENYCAP™ voltage, down to 1.9 V, for PV charging and MPPT. The operation of this can be tracked by attaching a USB source, but keeping the AEM SRC jumper to PV1-3. Then the green Status 2 LED would still blink (if the system came from deep sleep or zero, a PV voltage of at least 400 mV is required to start again).

Below the ENYCAP™ voltage of 1.9 V, the device enters a deep sleep state, waiting for a current source trigger or a bright enough light condition for the PV cell to start the controller again. This is typically at around a 400 mV PV input voltage. More details on this can be found in the datasheet of the AEM10941 from e-peas.

INTERFACE CONNECTOR SENS_CN

The interface connector on the board was routed to the best of many possibilities, with the aim of fitting the SensorXplorer™ boards provided by Vishay.

The DNA of tech.™

Energy Harvesting: Eliminating Battery Replacements for IoT Nodes With 196 HVC ENYCAP™

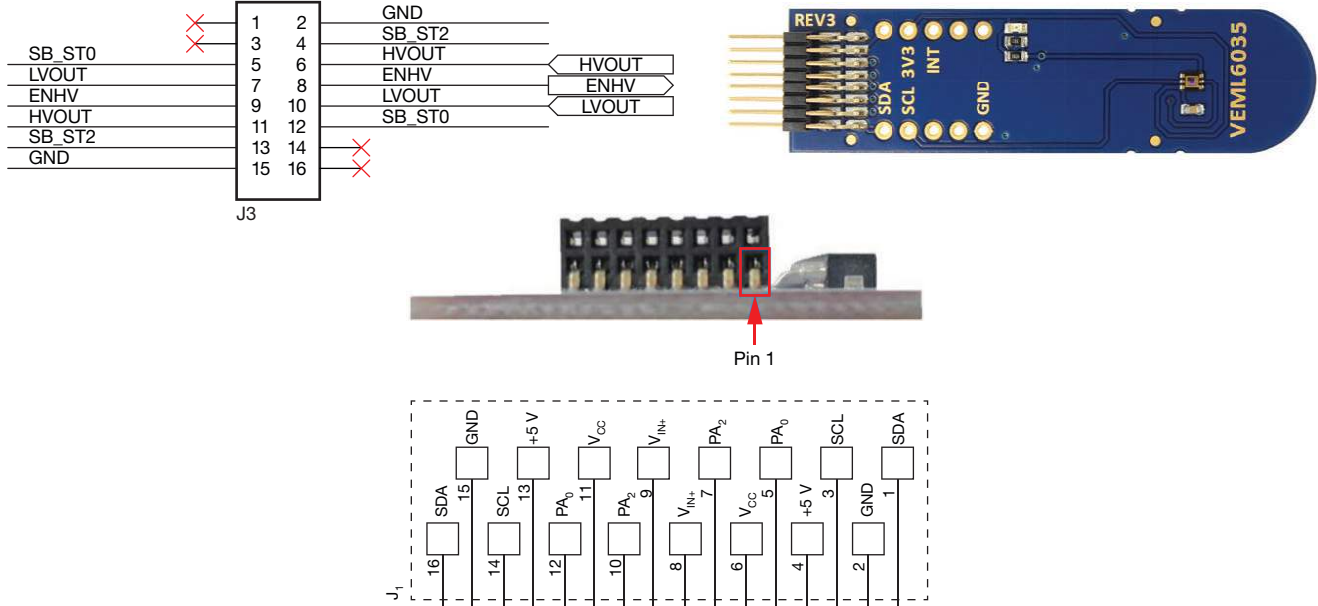

Pin 1, pin 16 (SDA)	I ² C data line
Pin 2, pin 15 (GND)	Ground
Pin 3, pin 14 (SCL)	I ² C clock line
Pin 4, pin 13 (+5 V)	5 V
Pin 5, pin 12 (PA ₀)	DIO7
Pin 6, pin 11 (V _{CC})	3.3 V
Pin 7, pin 10 (PA ₂)	DIO2
Pin 8, pin 9 (V _{IN+})	Sensor interrupt / ADC input (if placed)

Possible Implementation Guide

Since most sensors from Vishay will fit voltages of 1.7 V and 2.5 V in the future, the following backwards compatibility was chosen as a best fit (also because on most current daughter boards only the following pins are connected: GND, V_{CC}, SCL, and SDA). The VEML6035 low power, high sensitivity I²C ambient light sensor, for example, is a board that requires minimum operating voltage 1.7 V only. Others require 2.5 V at a minimum.

AMBIENT LIGHT SENSORS						
PART NUMBER	PACKAGE DIMENSIONS L x W x H (mm)	AMBIENT LIGHT RESOLUTION (lx)	OPERATING VOLTAGE (V)	OPERATING TEMPERATURE RANGE (°C)	OUTPUT CODE	AEC-Q101 QUALIFIED
VEML3235	2 x 2 x 0.87	0.0021	2.6 to 3.6	-40 to +85	16 bit, I ² C	-
VEML3235SL	2.95 x 1.5 x 1.5	0.0021	2.6 to 3.6	-40 to +85	16 bit, I ² C	-
VEML6030	2 x 2 x 0.87	0.0036	2.5 to 3.6	-25 to +85	16 bit, I ² C	-
VEML6035	2 x 2 x 0.4	0.0004	1.7 to 3.6	-25 to +85	16 bit, I ² C	-
VEML7700	6.8 x 2.35 x 3	0.0036	2.5 to 3.6	-25 to +85	16 bit, I ² C	-

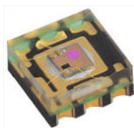

VEML3235

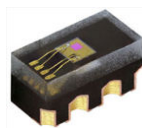

VEML3235SL

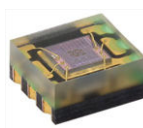

VEML6030

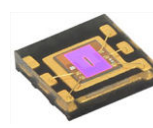

VEML6035



VEML7700

The DNA of tech.™

Energy Harvesting: Eliminating Battery Replacements for IoT Nodes With 196 HVC ENYCAP™

Pin 7 / pin 10 is an input on the SensorXplorer mainboard (which does not interfere with providing 1.7 V here) and is not used / connected on any sensor daughter board pin.

Pin 8 / pin 9 is an input on the SensorXplorer mainboard (which does not interfere with a logic switching ON the 2.5 V high voltage). It can be demanded by a future sensor daughter board with a low voltage microcontroller permanently running and switching ON its sensor component, which normally requires a higher voltage than 1.8 V upon sampling, e.g., for infrared emitters, humidity sensors, proximity sensors, or RF transceivers.

Pin 4 / pin 13 is a 5 V input line to some sensor daughter boards and does not interfere with providing a periodic Status 2 signal. For future implementations, this is a periodic life or trigger signal (once every 2 s to 3 s) from the V-harvester board. Then a running RTC on a future daughter board is not required to wake up periodically. Instead, the Status 2 port trigger wake-up can be used.

Pin 6 / pin 11 are the main 2.5 V output (similar to the main $V_{CC} = 3.3 V$ on the daughter boards), which can be enabled manually from the V-Harvester board.

SIZE OF A MINIMAL IMPLEMENTATION

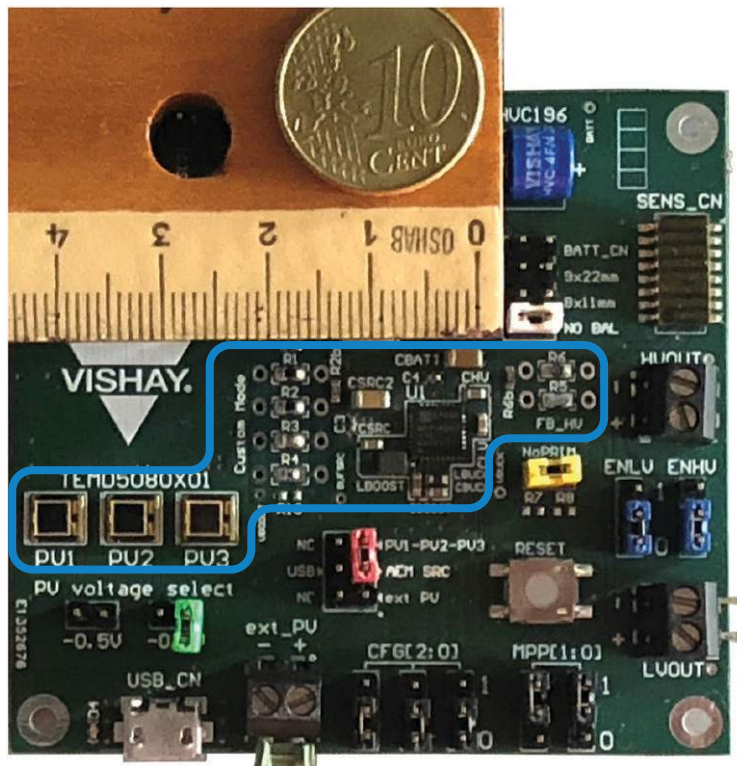

Fig. 9 - Visualization of component sizes

The total minimal size of an IoT sensor can be built with a base circuit around the controller chip totaling $12 \text{ mm} \times 12 \text{ mm} = \sim 150 \text{ mm}^2$. It is recommended to use at least two PV cells with $2 \times 5 \text{ mm} \times 4 \text{ mm} = 40 \text{ mm}^2$. The 196 HVC ENYCAP™ has outer dimensions of $7.5 \text{ mm} \times 7.5 \text{ mm} = \sim 60 \text{ mm}^2$.

With 10 % margin and spacing around, the total size of a circuit can be as small as $250 \text{ mm}^2 \times 1.1 = 275 \text{ mm}^2$.

The implementation would then have 13.8 Ws of storage energy and could harvest 2 mW average in direct sunlight. Output power can be as high as 2.5 V at 80 mA = 200 mW peak pulse power, and 25 mA as the maximum continuous current presented by the 196 HVC ENYCAP™ 4 F, 4.2 V capacitor.



The DNA of tech.™

Energy Harvesting: Eliminating Battery Replacements for IoT Nodes With 196 HVC ENYCAP™

MEASUREMENT

With a PV cell as the input power - but with several tracking, maximizing effects (e.g. MPPT), and monitoring tasks triggered periodically and sometimes at the same time - input and output power are dynamic. Therefore, it is difficult to calculate efficiencies at a specific point in time.

The follow measurements were done with an external PV input.

Case 1: Equilibrium

3 x PV (3 x 0.4 V); the only equilibrium setup found ⁽¹⁾

INPUT	
V	1.27 V
A	1.43 mA
Pin	1.82 mW
OUTPUT	
V	1.82 V
A	0.58 mA
Pout	1.05 mW
Efficiency	57.7 %
Voltage at ENYCAP™ 2 mm x 8 mm x 11 mm ⁽²⁾	3.46 V

Notes

- ⁽¹⁾ Equilibrium state means a stable condition with a constant ENYCAP™ voltage
- ⁽²⁾ This ENYCAP™ is under development, but was chosen because its capacitance of 0.2 F shows whether the voltage is rising or decaying much better

The following three measurements (case 2 to 4) include an ENYCAP™ voltage rising or falling, and therefore the input / output is added / subtracted to / from the energy balance and calculation.

Case 2

Voltage at supercapacitor used as additional input; 1 x PV cell

INPUT		
V	0.27 V	Similar to 1 x PV cell
A	2.16 mA	(Like direct sunlight)
Pin	0.58 mW	
OUTPUT		
V	1.82 V	
A	0.58 mA	
Pout	1.05 mW	
Add input power	3.1 V	At T0
Voltage at supercapacitor falling	3.07 V	After 10 s
	3.03 V	After 20 s
Equals current input 2 (current from ENYCAP™)	0.68 mA	With $Q = I \times t = C \times U$
Equals pin 2 (power from ENYCAP™)	2.09 mW	
Efficiency	39.3 %	
Voltage at ENYCAP™ 2 mm x 8 mm x 11 mm	3.07 V	

TECHNICAL NOTE



The DNA of tech.™

Energy Harvesting: Eliminating Battery Replacements for IoT Nodes With 196 HVC ENYCAP™

Case 3

Voltage at supercapacitor used as additional input (power); like 2 x PV cell

INPUT		
V	0.73 V	Similar to 2 x PV cell
A	0.58 mA	
Pin	0.42 mW	
OUTPUT		
V	1.82 V	
A	0.58 mA	
Pout	1.05 mW	
Add input power	3.52 V	At T0
Voltage at supercapacitor falling	3.49 V	After 10 s
	3.46 V	After 20 s
Equals current input 2 (current from ENYCAP™)	0.6 mA	With $Q = I \times t = C \times U$
Equals pin 2 (power from ENYCAP™)	2.1 mW	
Efficiency	41.7 %	
Voltage at ENYCAP™ 2 mm x 8 mm x 11 mm	3.49 V	

Case 4

Voltage at supercapacitor used as additional output (output means power is used to charge the supercapacitor).

INPUT		
V	0.423 V	1 x stronger PV cell
A	5.7 mA	
Pin	2.41 mW	
OUTPUT		
V	1.82 V	
A	0.58 mA	
Pout	1.05 mW	
Add input power	3.0 V	At T0
Voltage at supercapacitor rising	3.01 V	After 10 s
	3.02 V	After 20 s
Equals current input 2 (current from ENYCAP™)	-0.23 mA	With $Q = I \times t = C \times U$
Equals pin 2 (power from ENYCAP™)	-0.69 mW	
Efficiency	61.0 %	
Voltage at ENYCAP™ 2 mm x 8 mm x 11 mm	3.01 V	

The conversion efficiency is always calculated as the ratio: input PV to LDO output 1.7 V.



The DNA of tech.™

Energy Harvesting: Eliminating Battery Replacements for IoT Nodes With 196 HVC ENYCAP™

BILL OF MATERIAL			
QUANTITY	DESIGNATOR	DESCRIPTION	VISHAY P/N
1	B1	196 HVC ENYCAP™ 4 F / 4.2 V, stacked horizontal	MAL219691113E3
4	B2, B3, B4, B5	SMD ENYCAP™, 2.1 V each, (8 mm x 11 mm, 9 mm x 22 mm)	Not populated
1	LBUCK	Monolithic chip inductors	ILSB0603ER100K
1	C1	Ceramic capacitor: 100 nF, 10 V, 10 %, X7R, 0402	VJ0402V104ZXQPW1BC
1	C2	Ceramic capacitor: 1 nF, 50 V, 5 %, X8R, 0402	VL0402H102JxAPxxx
1	C3	Ceramic capacitor: 10 nF, 10 V, 10 %, X7R, 0402	
1	C4	Ceramic capacitor: 1 µF, 25 V, 20 %, X5R, 0402	
1	CBOOST	Ceramic capacitor: 22 µF, 10 V, 20 %, X5R, 0603	
1	CSRC	Ceramic capacitor: 10 µF, 10 V, 20 %, X5R, 0603	
2	CBATT, CSRC2	150 µF, ± 20 %, 6.3 V ceramic capacitor X5R, 1206 (3216 metric)	
3	CBUCK, CHV, CLV	Ceramic capacitor: 10 µF, 10 V, 20 %, X5R	
1	D1	Schottky BAT54 300 mA, 40 V	BAS16D-E3
1	D4	LED 0402 red	alternative: VLMS1500-GS08
1	D5	LED 0402 green	alternative: VLMG1500-GS08
1	D6	Zener 5.1 V, 300 mW, 2-pin SOD-323	BZX384C5V1-E3
1	LBOOST	Low profile, high current, shielded inductor	IFSC1008ABER100M01
1	P1	Header, 3-pin, dual row	
1	Q1	N-channel 60 V MOSFET: SOT23, 0.35 A, 60 V, 1.8 Ω	2N7002K-T1-E3
1	R1	Thick film resistor: 7.15 MΩ, 0603, ± 1 %, AEC-Q200	CRCW06037M15FKEA
1	R1b	Thin film resistor: 100 kΩ, 0603, ± 0.1 %	MCT06030C1003FP500
1	R2	Thick film resistor: 3.48 MΩ, 0603, ± 1 %, AEC-Q200	MCT06030C3834FP500
1	R2_b	Resistor: 0 Ω - 0603, resistor 0 Ω - 0603 solder bridge	CRCW06030000Z0EA0C
1	R3	Thick film resistor: 383 kΩ, 0402, ± 1 %	CRCW0603383KFKEA
1	R4	Thick film resistor: 20 MΩ, 1 %, 0.05 W, ± 100 ppm/°C, sulfur-resistant	RCWP040220M0FKED
1	R5	Professional thin film chip resistor: 10 MΩ, 0603, ± 1 %	MCT06030C1005FP500
1	R17	Pulse withstanding thick film resistor: 39 Ω, 0603, 75 V, anti-surge, ± 1 %, AEC-Q200	RCS060339R0FKEA
1	R19	Thick film resistor: 1 kΩ, 0402, ± 1 %	CRCW04021K00JNED
2	R20, R21	Resistor: 0 Ω - 0603, resistor 0R - 0603 solder bridge	CRCW06030000Z0EA0C
1	R24	Thick film resistor: 100 Ω, 0603, 500 mW, ± 1 %, AEC-Q200	CRCW0603100RFKEA
1	R25	Thick film resistor: 1 MΩ, 0402, ± 0.5 %	CRCW04021M00DKEDP
1	R26	Thick film resistor: 1 kΩ, 0603, ± 1 %	CRCW06031K00FKEA
2	R6, R6b	Thick film resistor: 7.5 MΩ, 0603, ± 1 %	CRCW06037M50FKEA
2	R9, R10	Professional thin film chip resistor: 2 kΩ, 0402, ± 1 %, 0.1 W	MCS04020C2001FE000
2	R11, R13	Thick film, high voltage resistor: 20 MΩ, 0402, ± 5 %	RCWP040220M0FKED/D
2	R12, R14	Thick film resistor: 10 kΩ, 0402, ± 1 %	CRCW040210K0FKED
2	R15, R16	Thick film resistor: 100 kΩ, 0402, ± 1 %	CRCW0402100RFKED
2	R22, R23	Thick film resistor: 100 kΩ, 0402, 1 %	CRCW0402100KFKEA
3	HVOUT, LVOUT, PRIM	Bornier wire to board, 2P	
3	JP0, JP1, JP2	Header: 1-pin	
4	JP3, JP4, JP6, JP7	Header: 2-pin, 2.54 mm	
7	SW1, SW2, SW3, SW4, SW5, SW6, SW7	Header: 3-pin	
1	BATT_CN	Bornier wire to board, 3P	
1	ext_PV	Bornier wire to board, 2P	
3	PV1, PV2, PV3	Photodiodes: blue enhanced, 40 ns, 130°, 2 SMD, no lead	TEMD5080X01
4	T1, T2, T3, T4	Dual n- and p-channel MOSFET: 12 V, 4.5 A, 6.5 W, surface-mount PowerPAK® SC-70-6	SiA517DJ-T1-GE3
1	SENS_CN	Header: 8-pin, dual row	
1	U1	AEM10941 - symbol QFN28	
1	SW8	Reset switch	
1	USB_CN	Micro USB-B	
2	FB1, FB2	Ferrite bead: 10 Ω at 100 MHz, 1 A, 0402	ILBB0402ER600V
2	J1, J2	Header: 4-pin, dual row, AEM BATT, AEM BAL	

TECHNICAL NOTE



The DNA of tech.™

Energy Harvesting: Eliminating Battery Replacements for IoT Nodes With 196 HVC ENYCAP™

PRECAUTIONS

ABSOLUTE MAXIMUM RATINGS

Any input pin	5.5 V
Operating temperature	-20 °C to +85 °C
Storage temperature	-40 °C to +85 °C

Primary cell input should be between 0.6 V and 5 V.

Do not connect the jumper “**short** no PRIM” if a primary cell is attached. This short circuits the header PRIM.

Do not jumper CFG1 to one unless jumpered to a source other than the 196 HVC ENYCAP™ at AEM BATT!

External PV

An external PV cell can be of any voltage up to 5 V max. Dark periods will not discharge the storage element.

INCLUDED MATERIALS

V-Harvester Board

1. Board: 64 mm x 69 mm
2. Set of jumpers
3. This document link to the product specification:
www.vishay.com/doc?28496
4. 196 HVC ENYCAP™ product specification:
www.vishay.com/doc?28409

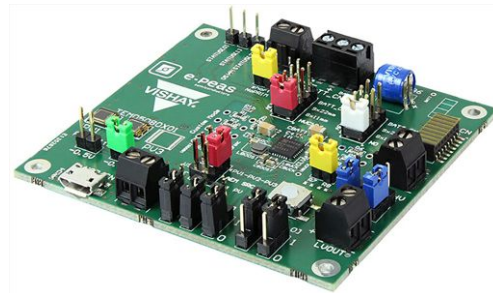

LINKS

- Batteryless IoT Sensor Telecommunications Applications | Vishay
origin-www.vishay.com/applications/telecommunications/batteryless_iotsensor/
- Vishay - Engineer's Toolbox
origin-www.vishay.com/landingpage/et4/et3te_iot1.html
- SensorXplorer™
www.vishay.com/landingpage/SensorXplorer/

CONTACTS

- If you need further information about storage capacitors, please contact: hybridstorage@vishay.com
- If you need further information about photo PIN diodes, SensorXplorer boards, ambient light sensors, and proximity sensors, please contact: sensorstechsupport@vishay.com
- If you need further information about this reference design and circuit design support, please contact: iot.sensors@vishay.com

Thank you for using and buying the V-harvester board!