

MD CONNECTOR

Miniature circular connectors

The extremely compact MD miniature circular connector has an outside diameter roughly half that of conventional circular DIN connectors. The connector's contact exclusively designed by JST dramatically reduces assembly time while improving contact reliability. The MD connector's shielding is superb. All you need to do is crimp the connector ground clip over the cable's braided shielding wire. Simple and reliable, JST's MD connector is well suited for the production of high-density office automation equipments as well as audio and video products.

- Crimp contact with integral construction for improved reliability
- Easy assembly without using special tools
- Simple braid-to-connector assembly and effective EMI protection

Standards

- Recognized E60389
- Certified LR20812

Shielding effect

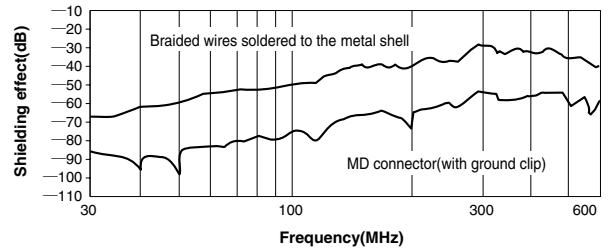

• The shielding effect differs depending on the wire specifications.

- * Compliant with RoHS.
- * Refer to "General Instruction and Notice when using Terminals and Connectors" at the end of this catalog.
- * Contact JST for details.

PC board layout

Layout Circuits	Mating section layout	PC board layout (viewed from component side)	
		Standard and Type B	Front shielding type
4			
5			
6			

MD CONNECTOR

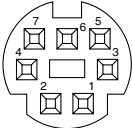
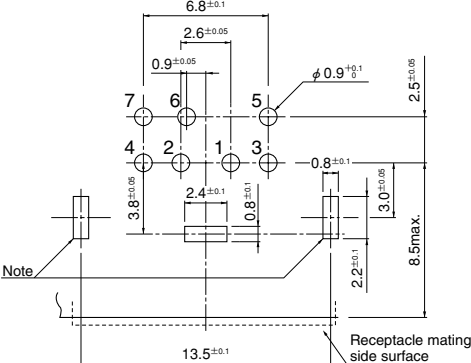
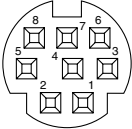
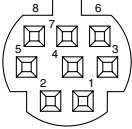
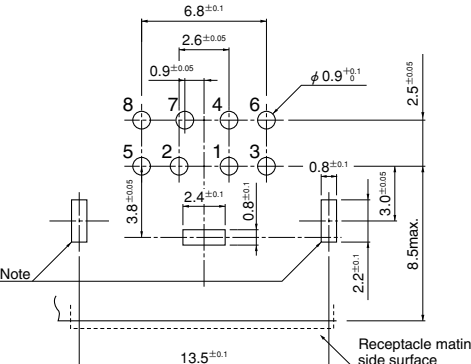
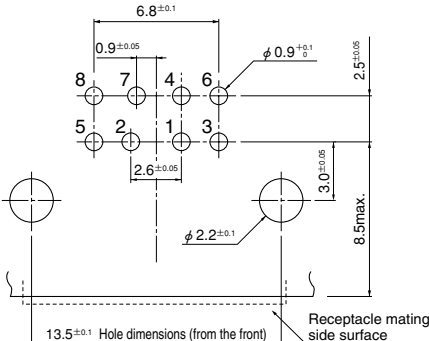
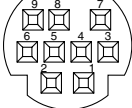
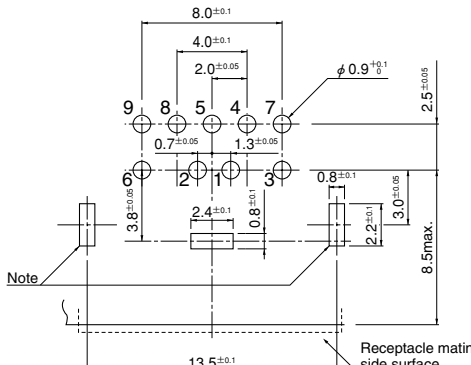
Layout Circuits	Mating section layout	PC board layout (viewed from component side)	
		Standard and Type B	Front shielding type
7			
8	 (Type B) 		
9			

Note: 1. The two holes are necessary when installing a shielding cover.

2. Tolerances are non-cumulative: $\pm 0.05\text{mm}$ for all centers.

3. Hole dimensions differ depending on the kind of PC board and piercing method. The dimensions above should serve as a guideline.

For details, contact JST.

4. The layout drawing is viewed from the receptacle mounting side.

5. When using a receptacle with shielding cover or with flange shielding cover, the pattern should be designed to connect the shielding cover and the shielding tube, if necessary. (No need for the front shielding cover.)

Assembly layout

Receptacle	Plug	Straight type	Side entry type
<p>Standard type Type B</p> <p>With shielding cover</p>			
<p>Standard type Type B</p> <p>With flange shielding cover</p>			
<p>Front shielding type</p>			

MD CONNECTOR

Plug

Straight type plug

Contact

JST's exclusive one-piece contact is formed and cold worked by stamping presses to ensure the highest reliability.

Housing B

Metal Shell

Three shell types (standard, A and B) are available.

Solder tail

Assembled product

Molded product



Molded product



Housing A

Housing A is designed to keep the contacts firmly in place while protecting them from damage.

Ground clip

If used, the ground clip is crimped to cover the cable braid.

Side entry type plug

Contact

Metal Shell

One piece including ground clip

Assembled product



Molded product



Housing A

Housing B

Specifications

Materials

Part name	Material and Finish
Contact	Phosphor bronze, nickel-undercoated, Mating part, gold-plated Crimping part, tin-plated (reflow treatment) Phosphor bronze, tin-plated (reflow treatment) Phosphor bronze, nickel-undercoated silver-plated
Housing A, B	PBT, UL94V-0, black
Metal shell	Steel, nickel-plated
Ground clip	Brass, nickel-plated

Characteristics

Current rating	1.0A, AC, DC (AWG#26)
Voltage rating	50V, AC, DC
Temperature range	-25°C ~ +85°C (including temperature rise in applying electrical current)
Contact resistance	Initial value: 100mΩ max. After environmental testing: 300mΩ max.
Insulation resistance	50MΩ min.
Withstanding voltage	500V AC/minute
Applicable wire	AWG #30~#24

Plug contact

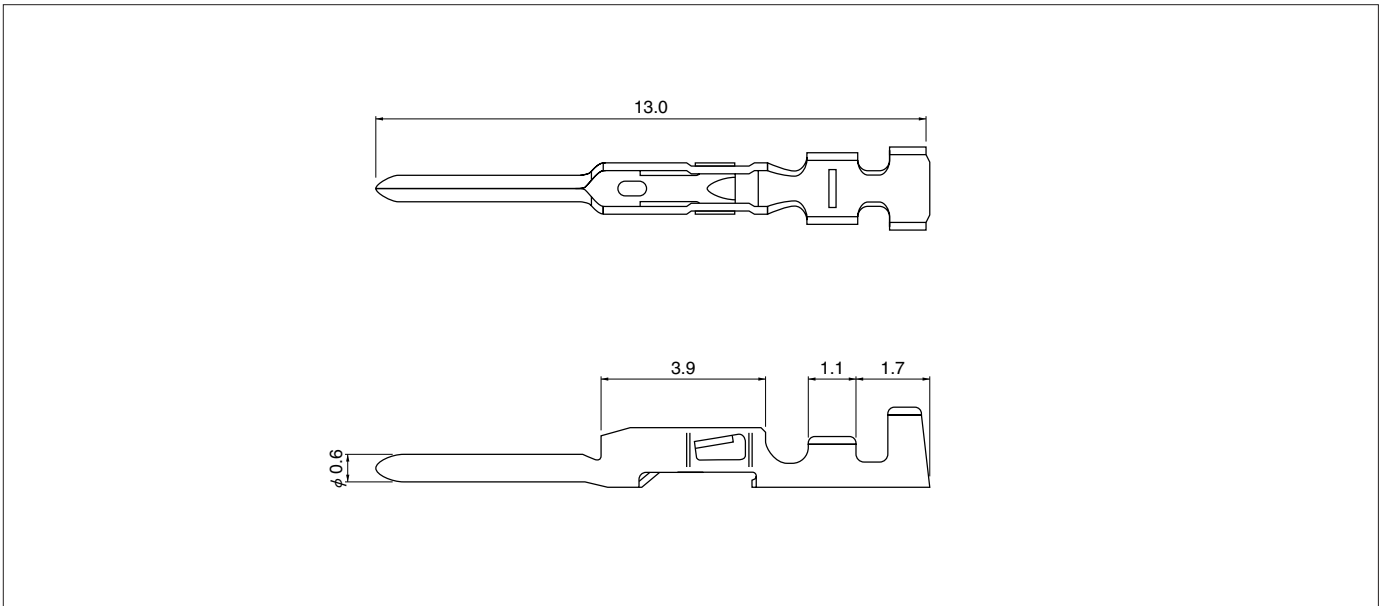

Model No.			Applicable wire			Q'ty / reel
Gold-plated (flash)	Silver-plated	Tin-plated	mm ²	AWG #	Insulation O.D. (mm)	
MD-SP2240	MD-SP2270	MD-SP2290	0.06~0.13	30~26	0.7~1.1	10,000
MD-SP1240	MD-SP1270	MD-SP1290	0.13~0.2	26~24	1.0~1.2	10,000

RoHS compliance Gold-plated products display (LF)(SN) on a label.

Model number identification

	MD	-	S	P	2	2	40
• Series name	_____						
• Product from: S ... Chain, B ... Loose piece	_____						
• Type of contact: P ... Plug contact	_____						
• Applicable wire: 1 ... AWG #26 ~ #24 2 ... AWG #30 ~ #26	_____						
• Material: 2 ... Phosphor bronze	_____						
• Finish 40 ... Gold-plated (flash) 44 ... 0.76 micron gold-plated 45 ... 1.3 micron gold-plated 70 ... Silver-plated 90 ... Tin-plated (reflow treatment)	_____						

*Contact JST for details.

MD CONNECTOR

Housing

Housing A

(With 4 to 8 circuits)

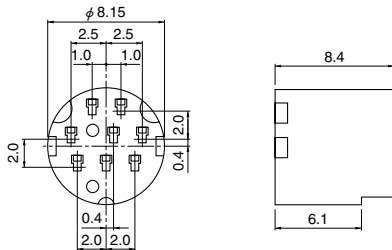

(With 9 circuits)

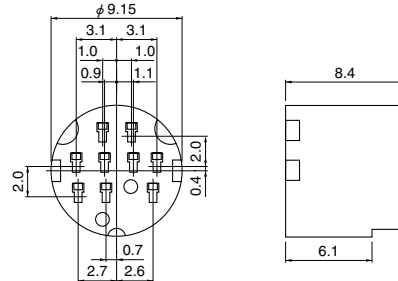

Housing B

(With 4 circuits)

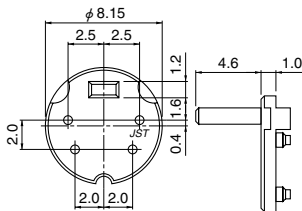

(With 5 circuits)

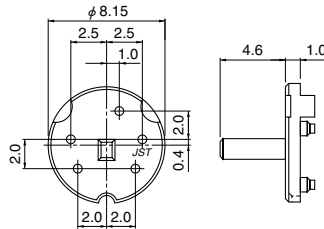

(With 6 circuits)

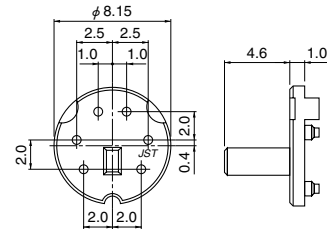

(With 8 circuits)

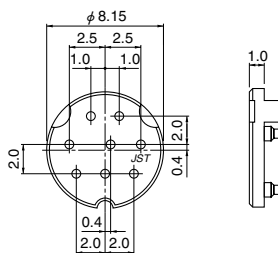

(With 9 circuits)

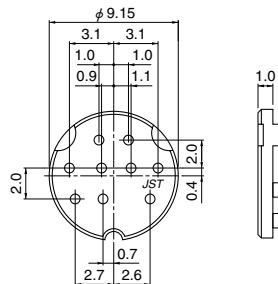

Combined housings A and B

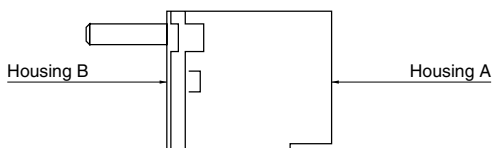

Housing A is used with housing B. Housing B must have the same number of orifices as there will be contacts in the connector. However, housing A can have a greater number of cavities (but never less). Thus in applications in which a user may require MD connectors with different pin counts, only one kind of "A" housing needs to be inventoried - the one with the highest pin count. For more details regarding such combinations, contact JST.

Circuits	Model No.		Q'ty / box
	Housing A	Housing B	
4	MD-PI 4A	MD-PI 4B	1,000
5	—	MD-PI 5B	1,000
6	MD-PI 6A	MD-PI 6B	1,000
8	MD-PI 8A	MD-PI 8B	1,000
9	MD-PI 9A	MD-PI 9B	1,000

RoHS compliance

Note: MD-PI5B is not CSA certified.

Metal shell (straight type)

Standard type

(With 4 to 8 circuits)

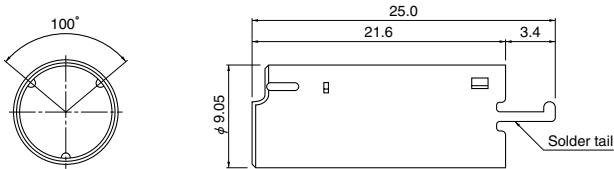

(With 9 circuits)

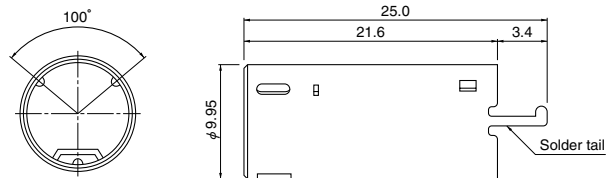

Type A

(features polarizing keys, usable with S-VHS connector)

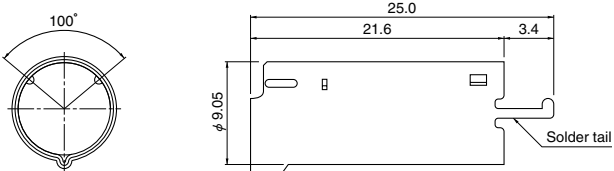

Type B

(features 4 polarizing keys, usable with having 8 circuits)

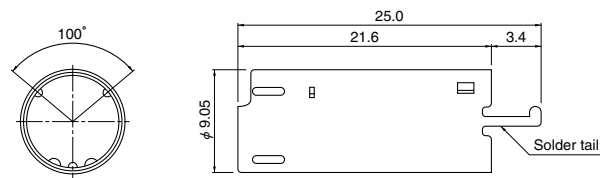

Circuits	Model No.						Q'ty / box
	Standard		Type A (features three polarizing keys)		Type B (features 4 polarizing keys...8 circuits only)		
	With solder tail	Without solder tail	With solder tail	Without solder tail	With solder tail	Without solder tail	
4~8	MD-PS8T	*MD-PS8T1	*MD-PS8AT	*MD-PS8AT1	*MD-PS8BT	*MD-PS8BT1	750
9	MD-PS9T	*MD-PS9T1	—	—	—	—	750

RoHS compliance

*Marked products are not CSA certified.

Ground clip

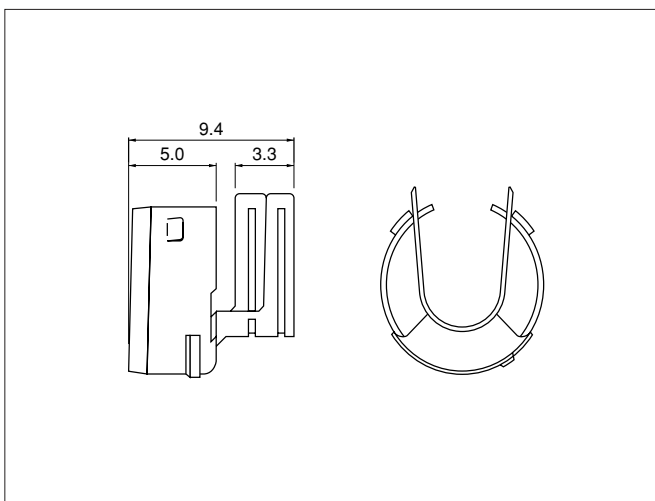

Circuits	Model No.	Applicable cable O.D.(mm)	Q'ty / reel
4~8	MD-PCC8T-S1	2.7~3.8	1,000
	MD-PCC8T-S2	4.3~5.5	1,000
9	MD-PCC9T-S3	3.6~4.8	1,000

RoHS compliance

MD CONNECTOR

Metal shell (side entry type)

Standard type

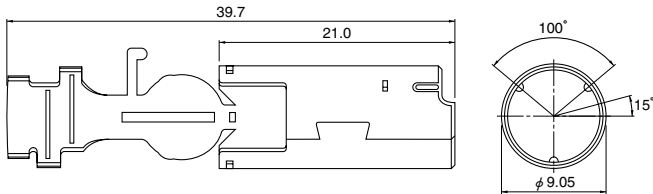

Type A

(features polarizing keys, usable with S-VHS connector)

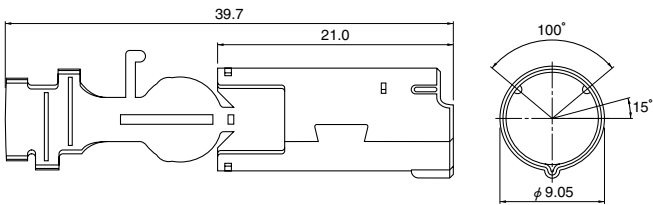

Type B

(features 4 polarizing keys, usable with housing having 8 circuits)

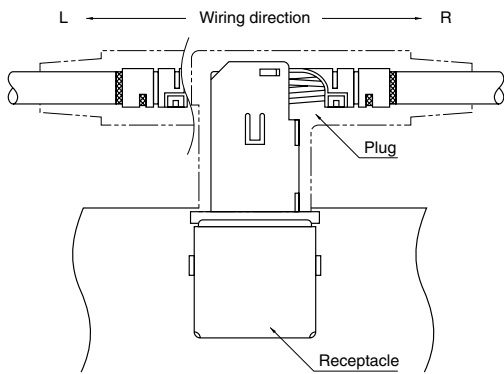
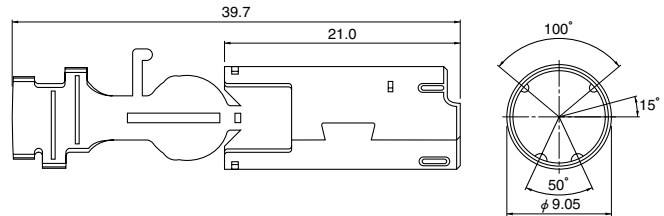

Viewing from the receptacle mounting side

Type	Circuits	Model number		Q'ty / box
		R	L	
Standard	4~8	MD-PS8SR	MD-PS8SL	500
A	4~8	MD-PS8ASR	—	500
B	8	MD-PS8BSR	—	500

RoHS compliance

Crimping machine, Applicator

Contact	Crimping machine	Applicator		
		Crimp applicator	Dies	Crimp applicator with dies
MD-PCC8T-S1	AP-K2N	MKS-L	MK/MD-PCC8T-S1	APLMK MD-PCC8T-S1
		*MKS-SC	—	—
MD-PCC8T-S2		MKS-L	MK/MD-PCC8T-S2	APLMK MD-PCC8T-S2
		*MKS-SC	—	—
MD-PCC8T-S3		MKS-L	MK/MD-PCC8T-S3	APLMK MD-PCC8T-S3
		*MKS-SC	—	—
MD-PS8SL		MKS-L-RG	MK/MD-PS8SR	APLMK MD-PS8SR
		*MKS-SC	—	—
MD-PS8ASR		MKS-L-RG	MK/MD-PS8SR	APLMK MD-PS8SR
		*MKS-SC	—	—

Contact	Crimping machine	Applicator		
		Crimp applicator	Dies	Crimp applicator with dies
MD-PS8BSR	AP-K2N	MKS-L-RG	MK/MD-PS8SR	APLMK MD-PS8SR
		*MKS-SC	—	—
MD-PS8SR		MKS-L-RG	MK/MD-PS8SR	APLMK MD-PS8SR
		*MKS-SC	—	—
MD-SP12**		MKS-L	MK/MD-SP12	APLMK MD-SP12
		*MKS-SC	SC/MD-SP12	APLSC MD-SP12
MD-SP22**		MKS-L	MK/MD-SP22	APLMK MD-SP22
		*MKS-SC	SC/MD-SP22	APLSC MD-SP22

Note: *Strip-crimp applicator

Receptacle (through-hole type)

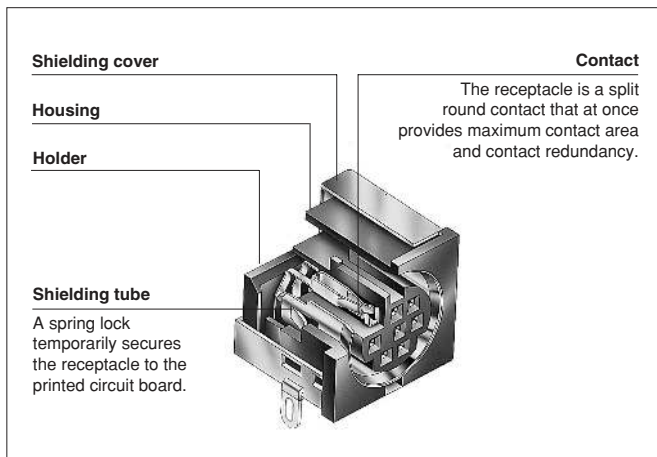

• Split round contact provides maximum contact area and contact redundancy

The receptacle contact is split to insure redundant connection and is cylindrically shaped to provide maximum contact mating area. The result is a highly reliable connection to the mating pin. This superb contact performance is maintained even after many mating and unmating cycles.

• Flange construction

The flange construction allows the receptacle to be secured on the equipment chassis with screws, ensuring more reliable electrical connection.



Standard type with flange shielding cover

(Standard type/Type B)

• Compact, high-density design

This receptacle has a low profile with a mounting height of just 12.8mm and width of 14.0mm. It takes up little space on the printed circuit board, allowing high-density product design.

• Spring locks make it easy to temporarily secure receptacles to printed circuit boards for soldering

The shielding tubes are equipped with spring locks which can be used to temporarily secure the receptacles to printed circuit boards. This prevents the receptacles from moving and ensures reliable soldering.

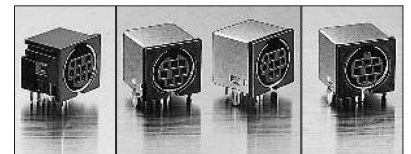

Standard type without shielding cover (left)
Standard type with shielding cover (center)
Type B (applicable to Type B plug) (right)

(Front shielding type)

• Front shielding construction

A metal shielding cover integrating the connection part which connects to the plug's shell is used. Because there is no gap between the receptacle and the plug, this construction prevents the entry of space conductive noise.

• Effective shielding

With the front shielding construction and the flange construction, the shielding effect is improved by about 15 dB over the conventional models.



Front shielding type receptacle

Specifications

Materials

Part name	Material and Finish
Contact	Phosphor bronze, nickel-undercoated, Mating part: gold-plated Solder tail; tin-plated (reflow treatment) Phosphor bronze, nickel-undercoated silver-plated Phosphor bronze, tin-plated (reflow treatment)
Housing / Holder	PBT, UL94V-0

Characteristics

Current rating	1.0A, AC, DC
Voltage rating	50V, AC, DC
Temperature range	-25°C ~ +85°C (including temperature rise in applying electrical current)
Contact resistance	Initial value: 100mΩ max. After environmental testing: 300mΩ max.
Withstanding voltage	500V AC/minute
Applicable PC board thickness	1.6mm

[Standard type/Type B]

Shielding tube	Brass, nickel-plated (*note)
Shielding cover	Brass, nickel-undercoatd, tin/copper alloy-plated

[Front shielding Type]

Shielding cover	Brass, nickel-plated (*note)
-----------------	------------------------------

Note: Use soldering flux that is suitable for nickel-plating. Tin plated version is also available.

Model number identification

	MD	-	S	8	0	00	B	-	10
• Series name									
• Product name: S ... Receptacle									
• Circuits: 4, 5, 6, 7, 8, 9									
• Shielding cover: 0 ... Without shielding cover 1 ... With shielding cover 3 ... With front shielding cover									
• Flange: 00 ... Without flange 30 ... With flange 50 ... With top flange with nuts									
• Type B indication B ... Type B (Applicable to Type B plug) Blank...Standard type (Applicable to Standard and Type A plugs) ...Front shielding type (Applicable to Standard and Type plugs)									
• Finish 10 ... Gold-plated (flash) 13 ... 0.4micron gold-plated 14 ... 0.76micron gold-plated 70 ... Silver-plated 90 ... Tin-plated (reflow treatment)									

Note: Contact JST for special plating requirements.

MD CONNECTOR

Standard type / Type B

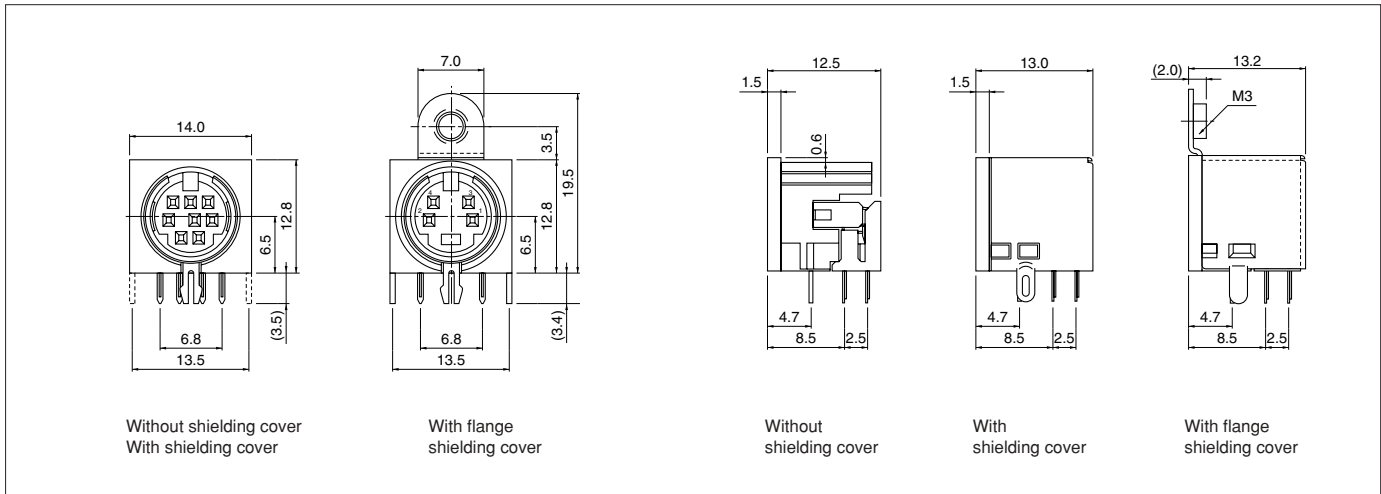

• Standard type: Without shielding cover

Cir- cuits	Model No.			Q'ty / box
	Gold-plated(flash)receptacle	Silver-plated receptacle	Tin-plated receptacle	
4	MD-S4000-10	MD-S4000-70	MD-S4000-90	200
5	MD-S5000-10	MD-S5000-70	MD-S5000-90	200
6	MD-S6000-10	MD-S6000-70	MD-S6000-90	200
7	MD-S7000-10	MD-S7000-70	MD-S7000-90	200
8	MD-S8000-10	MD-S8000-70	MD-S8000-90	200
9	MD-S9000-10	MD-S9000-70	MD-S9000-90	200

RoHS compliance Gold-plated products display (LF)(SN) on a label.

• Standard type: With shielding cover

Cir- cuits	Model No.			Q'ty / box
	Gold-plated(flash)receptacle	Silver-plated receptacle	Tin-plated receptacle	
4	MD-S4100-10	MD-S4100-70	MD-S4100-90	200
5	MD-S5100-10	MD-S5100-70	MD-S5100-90	200
6	MD-S6100-10	MD-S6100-70	MD-S6100-90	200
7	MD-S7100-10	MD-S7100-70	MD-S7100-90	200
8	MD-S8100-10	MD-S8100-70	MD-S8100-90	200
9	MD-S9100-10	MD-S9100-70	MD-S9100-90	200

RoHS compliance Gold-plated products display (LF)(SN) on a label.
Silver-plated/Tin-plated products display (LF) on a label.

• Standard type: With flange shielding cover

Cir- cuits	Model No.			Q'ty / box
	Gold-plated(flash)receptacle	Silver-plated receptacle	Tin-plated receptacle	
4	MD-S4130-10	MD-S4130-70	MD-S4130-90	200
5	MD-S5130-10	MD-S5130-70	MD-S5130-90	200
6	MD-S6130-10	MD-S6130-70	MD-S6130-90	200
7	MD-S7130-10	MD-S7130-70	MD-S7130-90	200
8	MD-S8130-10	MD-S8130-70	MD-S8130-90	200

RoHS compliance Gold-plated products display (LF)(SN) on a label.
Silver-plated/Tin-plated products display (LF) on a label.

• Type B: Without shielding cover

Cir- cuits	Model No.			Q'ty / box
	Gold-plated(flash)receptacle	Silver-plated receptacle	Tin-plated receptacle	
8	MD-S8000B-10	MD-S8000B-70	MD-S8000B-90	200

RoHS compliance Gold-plated products display (LF)(SN) on a label.

• Type B: With shielding cover

Cir- cuits	Model No.			Q'ty / box
	Gold-plated(flash)receptacle	Silver-plated receptacle	Tin-plated receptacle	
8	MD-S8100B-10	MD-S8100B-70	MD-S8100B-90	200

RoHS compliance Gold-plated products display (LF)(SN) on a label.
Silver-plated/Tin-plated products display (LF) on a label.

• Type B: With flange shielding cover

Cir- cuits	Model No.			Q'ty / box
	Gold-plated(flash)receptacle	Silver-plated receptacle	Tin-plated receptacle	
8	MD-S8130B-10	MD-S8130B-70	MD-S8130B-90	200

RoHS compliance Gold-plated products display (LF)(SN) on a label.
Silver-plated/Tin-plated products display (LF) on a label.

• Front shielding type

Cir- cuits	Model No.			Q'ty / box
	Gold-plated(flash)receptacle	Silver-plated receptacle	Tin-plated receptacle	
4	MD-S4350-10	MD-S4350-70	MD-S4350-90	200
5	MD-S5350-10	MD-S5350-70	MD-S5350-90	200
6	MD-S6350-10	MD-S6350-70	MD-S6350-90	200
8	MD-S8350-10	MD-S8350-70	MD-S8350-90	200

RoHS compliance Gold-plated products display (LF)(SN) A on a label.
Silver-plated/Tin-plated products display ↪ A on a label.
(↪ shows space.)

