

**NEWNEX PROPRIETARY**

THIS DOCUMENT AND THE DATA DISCLOSED HEREIN OR WITHIN IS NOT TO BE REPRODUCED, USED, OR DISCLOSED IN WHOLE OR PART TO ANYONE WITHOUT THE WRITTEN PERMISSION OF NEWNEX

**COMPANY NAME**

**CUSTOMER SIGNATURE**

**DATE**

**COMMENTS:**

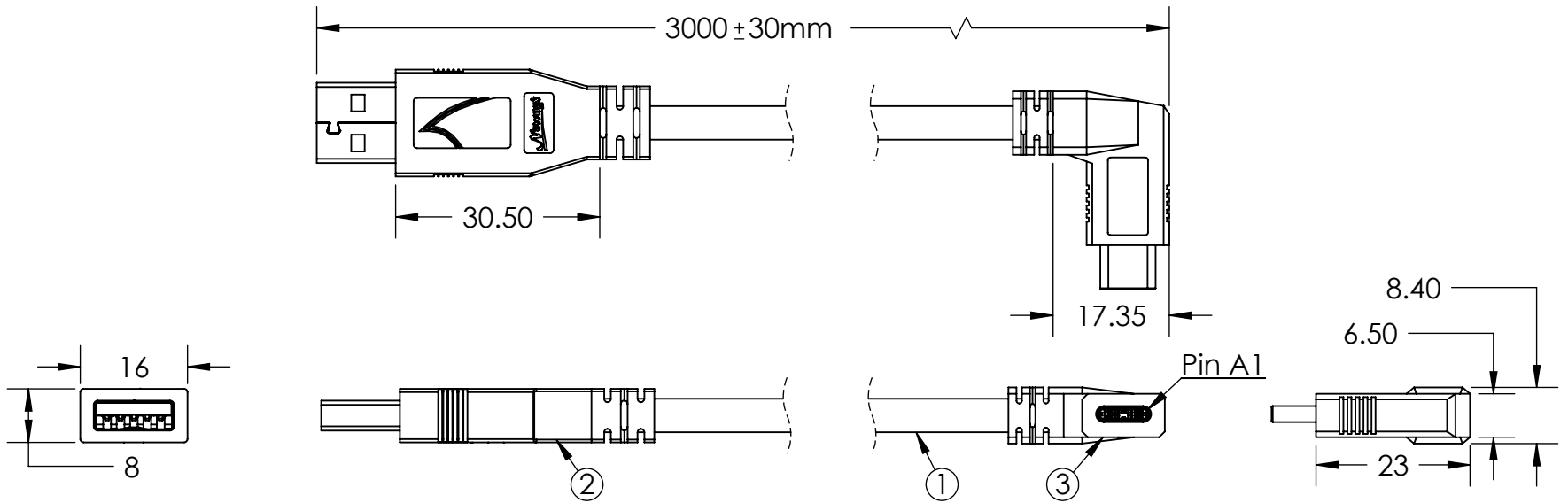

Wiring Structure			
USB 3.0 A Plug	Wire		USB Typ-C Plug
	SIGNAL	COLOR	
1	Vcc	Red	A4,B4,A9,B9
	CC		A5
2	UTP-Dn	White	A7
3	UTP-Dp	Green	A6
4+7	GND	Black+D	A1,B1,A12,B12
5	SDPn1	Blue	A3
6	SDPp1	Yellow	A2
8	SDPn2	Purple	B10
9	SDPp2	Orange	B11
SHELL	Outer Braid		SHELL

Rp=56K

**Notes:**

1. Cable: USB 3.1 Black PVC Jacket
2. Connector: USB 3.1 A Male.
3. Connector: USB 3.1 Type-C Right Angle Male With 56K Rp
4. Packaging: 1 Piece + PE bag.

Newnex Technology Corp.



UNLESS OTHERWISE SPECIFIED DIMENSIONS ARE IN MILLIMETERS TOLERANCES ARE:

FRACTIONS DECIMALS ANGLES  
 • NA XX ± 0.5  
 XX ± 0.25  
 XXX ± 0.125

PROJ: TITLE:

SCALE: 1:1 REV: A

DATE: 7/3/2018

USB 3.1 A Male to C Right Angle, 3M, Black

DRAWN BY: XW

APPROVED BY: ZL

PART NUMBER: U3S1A01C15-030

CHECKED BY: SHEET 1 OF 1

REVISION COMMENTS: Drawing generated