

## Headphone Amplifiers

# Standard Headphone Amplifiers

**BH3544F, BH3547F, BH3548F**

No.15102EDT02

**●Description**

BH3544F, BH3547F, BH3548F are headphone amplifiers suitable for portable products. BH3544F, BH3547F, BH3548F has a fixed gain of 6 dB. External resistors for gain setting are not needed. Package of BH3544F, BH3547F, BH3548F is pin-to-pin compatible (SOP8), enable to replace each other easily.

BH3544F, BH3547F, BH3548F also has mute functions that make it easy to prevent pop noise when power supply turns on/off. Moreover, thermal shutdown function is built-in. BH3544F, BH3547F can drive 16/32Ω load, BH3548F can drive 8/16/32Ω. So, BH3548F is suitable for 8Ω receiver.

**●Features**

- 1) Built-in mute function for preventing pop noise when power supply turns on/off
- 2) Built-in thermal shutdown function
- 3) BH3544F, BH3547F, BH3548F are pin-to-pin compatible
- 4) SOP8 small package

**●Applications**

TV, Desktop PC, Notebook PC, Camcorder and other equipment having headphone output

**●Line up**

Part No.	BH3544F	BH3547F	BH3548F	Unit
Supply voltage	+2.8 ~ +6.5	+4.5 ~ +6.5	+4.0 ~ +5.5	V
Quiescent current	7.0	3.7	6.5	mA
Amplifier gain	6			dB
Output [RL=16Ω]	62	77	62	mW
load impedance	16 / 32		8/16/32	Ω
Operating temperature range	-25 ~ +75		-40 ~ +85	°C

**●Absolute maximum ratings(Ta=25°C)**

Parameter	Symbol	Ratings	Unit
		BH3544F, BH3547F, BH3548F	
Applied voltage	VCC	7.0	V
Power dissipation	Pd	550 <sup>*1</sup>	mW
Storage temperature	Tstg	-55~+125	°C

\*1 Derating is done at 5.5mW/°C above Ta=25°C. (When mounted on a 70mm×70mm×1.6mm PCB board, FR4)

**●Operating conditions (Ta=25°C)**

Parameter	Symbol	Limits			Unit
		BH3544F	BH3547F	BH3548F	
Supply voltage	VCC	+2.8 ~ +6.5	+4.5 ~ +6.5	+4.0 ~ +5.5	V
Temperature Range	Topr	-25~+75		-40 ~ +85	°C

\* These product are not designed for protection against radioactive rays.

●Electrical characteristics (Unless otherwise noted, Ta=25°C, VCC=5V, RL=32Ω, f=1kHz, BW=400~30kHz, VIN = -6dBV)

Parameter	Symbol	Limits(TYP.)			Unit	Conditions
		BH3544F	BH3547F	BH3548F		
Quiescent current	I <sub>Q</sub>	7	3.7	6.5	mA	V <sub>IN</sub> =0Vrms
Mute pin control voltage H	V <sub>TMH</sub>	1.6<			V	Mute OFF
Mute pin control voltage L	V <sub>TML</sub>	<0.3			V	Mute ON
Gain	G <sub>VC</sub>	6			dB	-
Gain difference between channels	ΔG <sub>VC</sub>	0			dB	-
Total harmonic distortion	THD	0.02	0.05	0.02	%	BW=20~20kHz
Rated output 1	P <sub>O1</sub>	31	46	31	mW	RL=32Ω, THD<0.1% (BH3541F, BH3544F, BH3548F) RL=32Ω, THD<0.3% (BH3547F)
Rated output 2	P <sub>O2</sub>	62	77	62	mW	RL=16Ω, THD<0.1% (BH3541F, BH3544F, BH3548F) RL=16Ω, THD<0.5% (BH3547F)
Rated output 3	P <sub>O3</sub>	-		120	mW	RL=8Ω, THD<0.25% (BH3548F)
Output noise voltage	V <sub>NO</sub>	-93			dBV	BW=20~20kHz, R <sub>g</sub> =0Ω
Channel separation	CS	-90	-87	-90	dB	R <sub>g</sub> =0Ω
Mute attenuation	ATT	-80			dB	R <sub>g</sub> =0Ω
Ripple rejection	RR	-57			dB	f <sub>RR</sub> =100Hz, V <sub>RR</sub> =-20dBV
Input resistance	R <sub>IN</sub>	90			kΩ	-

●Reference data

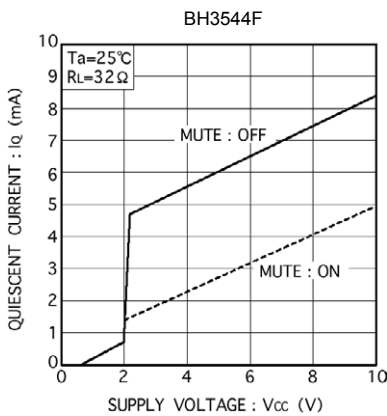

Fig. 1 Quiescent current vs. power supply voltage

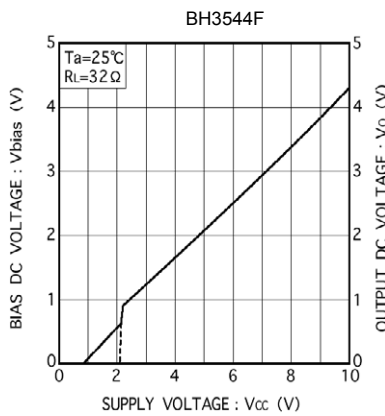

Fig. 2 in DC current vs. power supply voltage

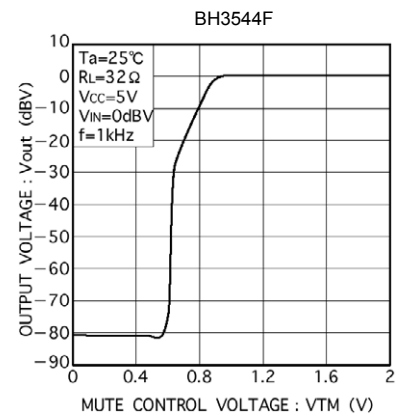

Fig. 3 Output voltage vs. Mute control voltage

●Reference data (Continued)

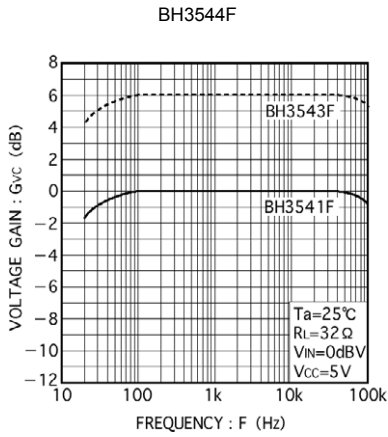

Fig. 4 Voltage gain vs. frequency

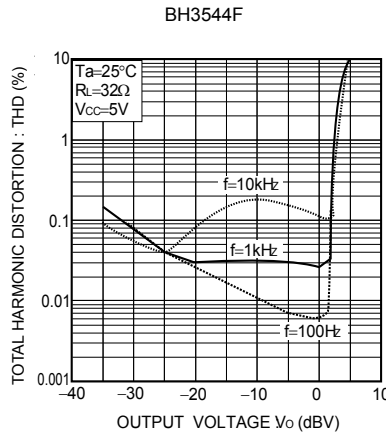

Fig. 5 Total harmonic distortion vs. output voltage (1)

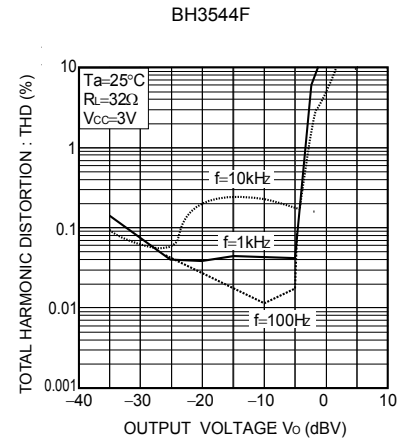

Fig. 6 Total harmonic distortion vs. output voltage (2)

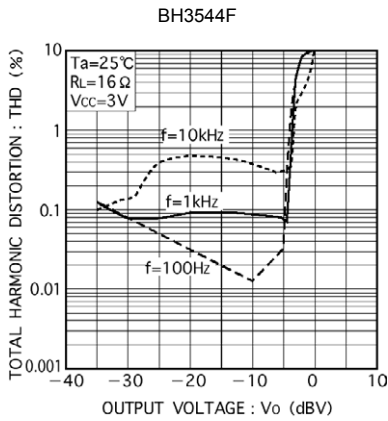

Fig. 7 Total harmonic distortion vs. output voltage (3)

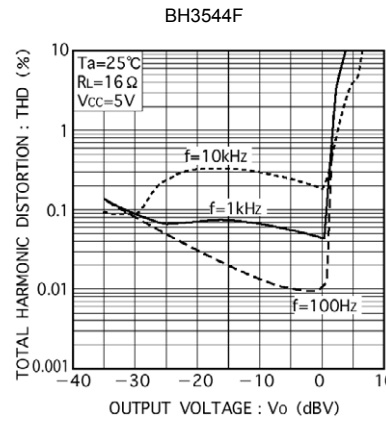

Fig. 8 Total harmonic distortion vs. output voltage (4)

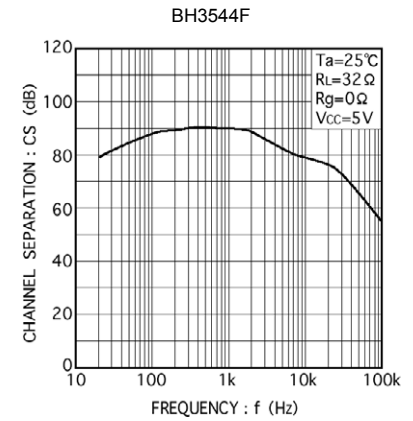

Fig. 9 Channel separation vs. frequency

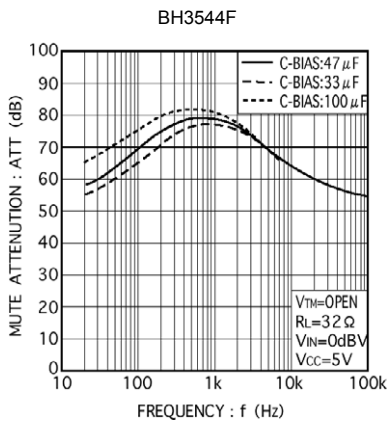

Fig. 10 MUTE attenuation vs. frequency

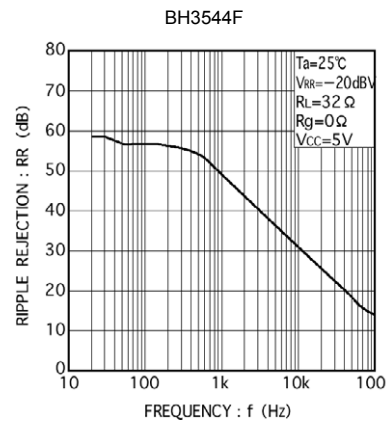

Fig. 11 Ripple rejection vs. frequency

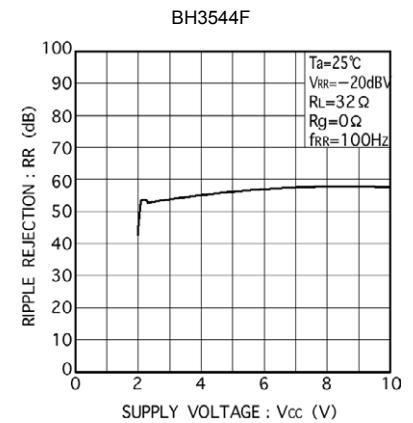
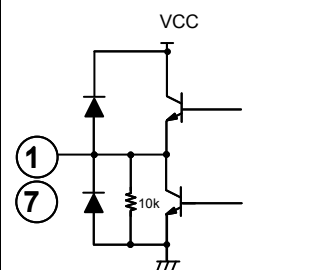
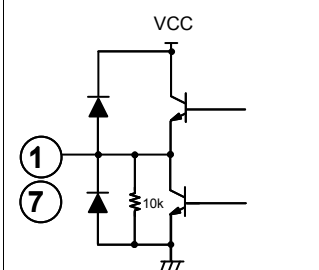
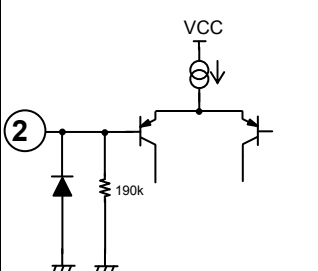
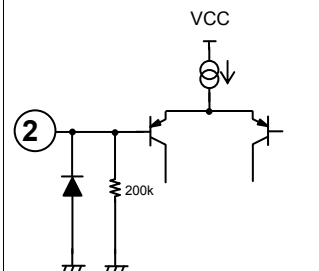
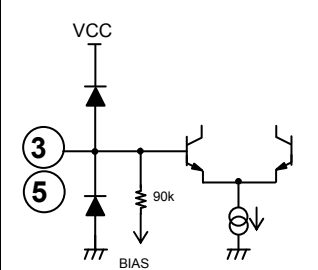
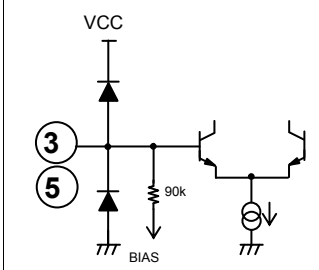
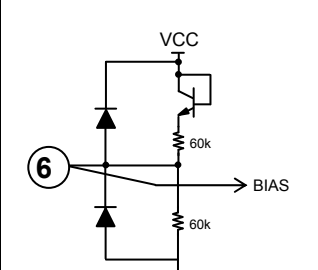
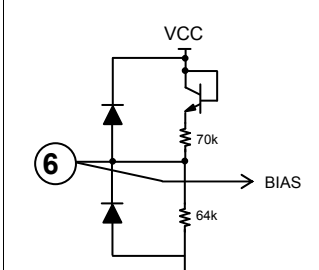

Fig. 12 Ripple rejection vs. power supply voltage



•Terminal Equivalent Circuit / Description

Pin No.	Pin Name	I/O	Pin voltage	Equivalent circuit		Function
				BH3544F, BH3548F	BH3547F	
1 7	OUT1 OUT2	O	2.1V (VCC=5V)			Output pin
2	MUTE	I	0.1V (When open)			Mute control pin Active:Hi Mute:Lo (open)
3 5	IN1 IN2	I	2.1V (VCC=5V)			Input pin
6	BIAS	I/O	2.1V (VCC=5V)			Bias pin  (Since the 47 μF externally attached capacitor also serves as the time constant for pop noise countermeasures, evaluate adequately when changing it.)
4	GND	I	-	-	-	GND pin
8	VCC	I	-	-	-	Power supply pin

※The figure in the pin explanation and input/output equivalent circuit is reference value, it doesn't guarantee the value.

### ● Application circuit

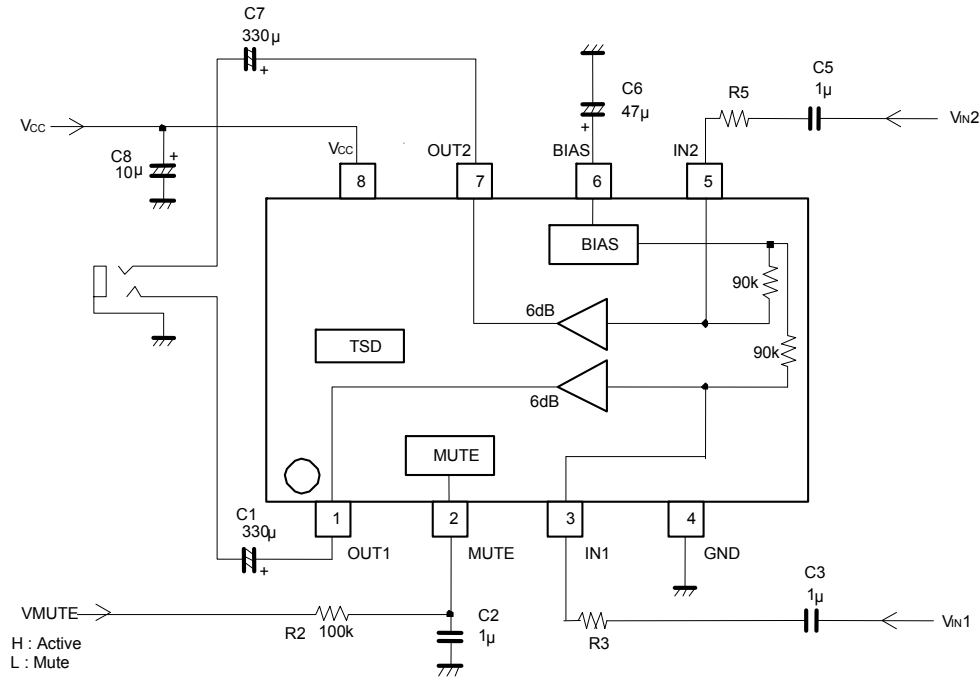

Fig. 15

### ● Description of external components

#### 1) Input coupling capacitors (C3, C5)

These are determined according to the lower cutoff frequency  $f_c$ . Moreover, since lowering the capacitance can cause the occurrence of pop noise, when changing this, determine it after adequate checking.

Since the input impedance is  $90\text{k}\Omega$ , these are found by the expressions below, although drift, temperature characteristics, and other considerations are necessary. (Layered ceramic capacitors are recommended.)

$$C3(C5) = 1 / (2\pi \times 90\text{k}\Omega \times f_c)$$

#### 2) Bias capacitor (C6)

When  $V_{CC}=5\text{V}$ ,  $47\mu\text{F}$  is recommended. Since lowering the capacitance too much can cause worsening of electrical characteristics or the occurrence of pop noise, when changing this, determine it after checking this adequately.

#### 3) Mute pin pop noise countermeasures (R2, C2)

Since BH3544F, BH3548F have an impedance of  $190\text{k}\Omega$  against GND and the BH3547F has  $200\text{k}\Omega$ , it may be impossible to cancel mute mode if R2 is made too large.

#### 4) Output coupling capacitors (C1, C7)

These are determined by the lower cutoff frequency. If  $R_L$  is the output load resistance (assuming a resistance  $R_x$  is put in for output protection or current restriction), these are found by the expression below.

$$C1(C7) = 1 / (2\pi \times (R_L + R_x) \times f_c)$$

#### 5) Input gain adjustment resistances (R3, R5)

Externally attached resistances (R3, R5) make input gain adjustment possible. The gain found by the expression below can be set.

$$G_{VC} = 6 + 20 \log(90\text{k}\Omega / (90\text{k}\Omega + R3[R5])) \text{ [dB]}$$

When input gain is not accommodated, these resistors have no use.

● Notes for use

- 1) Numbers and data in entries are representative design values and are not guaranteed values of the items.
- 2) Although we are confident in recommending the sample application circuits, carefully check their characteristics further when using them. When modifying externally attached component constants before use, determine them so that they have sufficient margins by taking into account variations in externally attached components and the Rohm LSI, not only for static characteristics but also including transient characteristics.
- 3) Absolute maximum ratings  
If applied voltage, operating temperature range, or other absolute maximum ratings are exceeded, the LSI may be damaged. Do not apply voltages or temperatures that exceed the absolute maximum ratings. If you think of a case in which absolute maximum ratings are exceeded, enforce fuses or other physical safety measures and investigate how not to apply the conditions under which absolute maximum ratings are exceeded to the LSI.
- 4) GND potential  
Make the GND pin voltage such that it is the lowest voltage even when operating below it. Actually confirm that the voltage of each pin does not become a lower voltage than the GND pin, including transient phenomena.
- 5) Thermal design  
Perform thermal design in which there are adequate margins by taking into account the allowable power dissipation in actual states of use.
- 6) Shorts between pins and misinstallation  
When mounting the LSI on a board, pay adequate attention to orientation and placement discrepancies of the LSI. If it is misinstalled and the power is turned on, the LSI may be damaged. It also may be damaged if it is shorted by a foreign substance coming between pins of the LSI or between a pin and a power supply or a pin and a GND.
- 7) Operation in strong magnetic fields  
Adequately evaluate use in a strong magnetic field, since there is a possibility of malfunction.
- 8) Pop noise countermeasures  
In order to prevent the pop noise that occurs when the power supply turns ON or OFF, make the rise and fall with reference to the timing diagram shown below.

1)BH3544F/ BH3548F

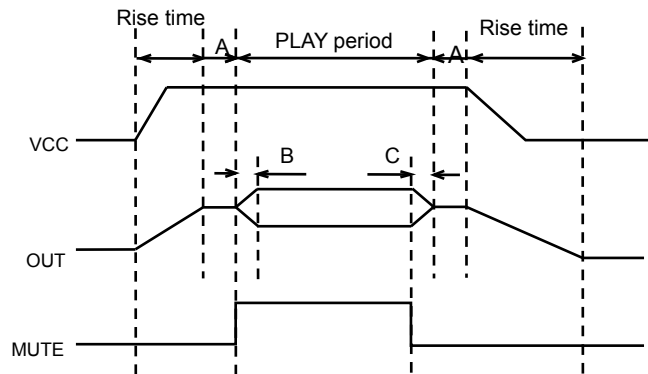

Fig. 16

- (A):Mute period (Use as pop noise countermeasure when power supply turns ON/OFF by making VMUTE=Lo.)
- (B):Mute cancellation period (This has a time constant because it is used by the externally attached C2 and R2 as a pop noise countermeasure on mute cancellation, so be careful of the timing.)
- (C):Mute start time (As on cancellation, this has a time constant.)

2)BH3547F

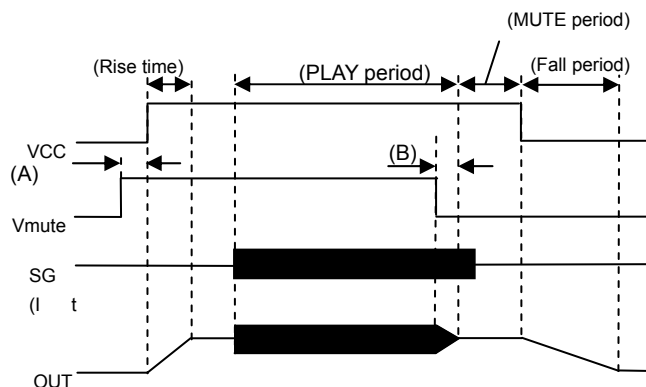

Fig. 17

- (A):Before VCC rise (or at the same time as VCC) make mute cancelled (VMUTE=Hi).
- (B):Soft mute period (This time can be set by externally attached R2 and C2)

● Ordering part number

B	H
---	---

Part No.

3	5	4	4
---	---	---	---

Part No.

3544  
3547  
3548

F
---

Package  
F: SOP8

-

E	2
---	---

Packaging and forming specification  
E2: Embossed tape and reel

SOP8

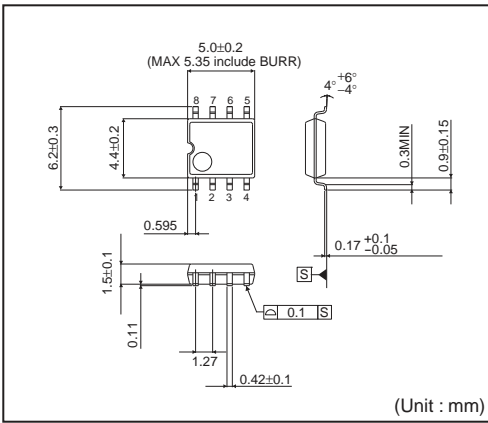

<Tape and Reel information>

Tape	Embossed carrier tape
Quantity	2500pcs
Direction of feed	E2 (The direction is the 1pin of product is at the upper left when you hold reel on the left hand and you pull out the tape on the right hand )

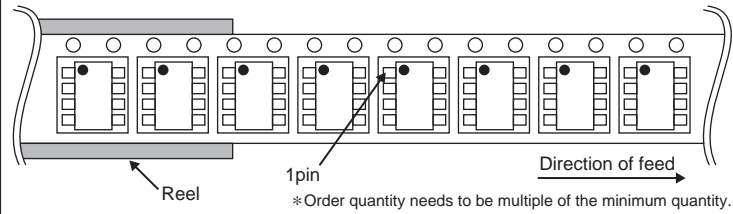



# Notice

## Precaution on using ROHM Products

- Our Products are designed and manufactured for application in ordinary electronic equipments (such as AV equipment, OA equipment, telecommunication equipment, home electronic appliances, amusement equipment, etc.). If you intend to use our Products in devices requiring extremely high reliability (such as medical equipment <sup>(Note 1)</sup>, transport equipment, traffic equipment, aircraft/spacecraft, nuclear power controllers, fuel controllers, car equipment including car accessories, safety devices, etc.) and whose malfunction or failure may cause loss of human life, bodily injury or serious damage to property ("Specific Applications"), please consult with the ROHM sales representative in advance. Unless otherwise agreed in writing by ROHM in advance, ROHM shall not be in any way responsible or liable for any damages, expenses or losses incurred by you or third parties arising from the use of any ROHM's Products for Specific Applications.

(Note1) Medical Equipment Classification of the Specific Applications

JAPAN	USA	EU	CHINA
CLASS III	CLASS III	CLASS II b	CLASS III
CLASS IV		CLASS III	

- ROHM designs and manufactures its Products subject to strict quality control system. However, semiconductor products can fail or malfunction at a certain rate. Please be sure to implement, at your own responsibilities, adequate safety measures including but not limited to fail-safe design against the physical injury, damage to any property, which a failure or malfunction of our Products may cause. The following are examples of safety measures:
  - Installation of protection circuits or other protective devices to improve system safety
  - Installation of redundant circuits to reduce the impact of single or multiple circuit failure
- Our Products are designed and manufactured for use under standard conditions and not under any special or extraordinary environments or conditions, as exemplified below. Accordingly, ROHM shall not be in any way responsible or liable for any damages, expenses or losses arising from the use of any ROHM's Products under any special or extraordinary environments or conditions. If you intend to use our Products under any special or extraordinary environments or conditions (as exemplified below), your independent verification and confirmation of product performance, reliability, etc. prior to use, must be necessary:
  - Use of our Products in any types of liquid, including water, oils, chemicals, and organic solvents
  - Use of our Products outdoors or in places where the Products are exposed to direct sunlight or dust
  - Use of our Products in places where the Products are exposed to sea wind or corrosive gases, including Cl<sub>2</sub>, H<sub>2</sub>S, NH<sub>3</sub>, SO<sub>2</sub>, and NO<sub>2</sub>
  - Use of our Products in places where the Products are exposed to static electricity or electromagnetic waves
  - Use of our Products in proximity to heat-producing components, plastic cords, or other flammable items
  - Sealing or coating our Products with resin or other coating materials
  - Use of our Products without cleaning residue of flux (even if you use no-clean type fluxes, cleaning residue of flux is recommended); or Washing our Products by using water or water-soluble cleaning agents for cleaning residue after soldering
  - Use of the Products in places subject to dew condensation
- The Products are not subject to radiation-proof design.
- Please verify and confirm characteristics of the final or mounted products in using the Products.
- In particular, if a transient load (a large amount of load applied in a short period of time, such as pulse. is applied, confirmation of performance characteristics after on-board mounting is strongly recommended. Avoid applying power exceeding normal rated power; exceeding the power rating under steady-state loading condition may negatively affect product performance and reliability.
- De-rate Power Dissipation (Pd) depending on Ambient temperature (Ta). When used in sealed area, confirm the actual ambient temperature.
- Confirm that operation temperature is within the specified range described in the product specification.
- ROHM shall not be in any way responsible or liable for failure induced under deviant condition from what is defined in this document.

## Precaution for Mounting / Circuit board design

- When a highly active halogenous (chlorine, bromine, etc.) flux is used, the residue of flux may negatively affect product performance and reliability.
- In principle, the reflow soldering method must be used on a surface-mount products, the flow soldering method must be used on a through hole mount products. If the flow soldering method is preferred on a surface-mount products, please consult with the ROHM representative in advance.

For details, please refer to ROHM Mounting specification

**Precautions Regarding Application Examples and External Circuits**

1. If change is made to the constant of an external circuit, please allow a sufficient margin considering variations of the characteristics of the Products and external components, including transient characteristics, as well as static characteristics.
2. You agree that application notes, reference designs, and associated data and information contained in this document are presented only as guidance for Products use. Therefore, in case you use such information, you are solely responsible for it and you must exercise your own independent verification and judgment in the use of such information contained in this document. ROHM shall not be in any way responsible or liable for any damages, expenses or losses incurred by you or third parties arising from the use of such information.

**Precaution for Electrostatic**

This Product is electrostatic sensitive product, which may be damaged due to electrostatic discharge. Please take proper caution in your manufacturing process and storage so that voltage exceeding the Products maximum rating will not be applied to Products. Please take special care under dry condition (e.g. Grounding of human body / equipment / solder iron, isolation from charged objects, setting of ionizer, friction prevention and temperature / humidity control).

**Precaution for Storage / Transportation**

1. Product performance and soldered connections may deteriorate if the Products are stored in the places where:
  - [a] the Products are exposed to sea winds or corrosive gases, including Cl<sub>2</sub>, H<sub>2</sub>S, NH<sub>3</sub>, SO<sub>2</sub>, and NO<sub>2</sub>
  - [b] the temperature or humidity exceeds those recommended by ROHM
  - [c] the Products are exposed to direct sunshine or condensation
  - [d] the Products are exposed to high Electrostatic
2. Even under ROHM recommended storage condition, solderability of products out of recommended storage time period may be degraded. It is strongly recommended to confirm solderability before using Products of which storage time is exceeding the recommended storage time period.
3. Store / transport cartons in the correct direction, which is indicated on a carton with a symbol. Otherwise bent leads may occur due to excessive stress applied when dropping of a carton.
4. Use Products within the specified time after opening a humidity barrier bag. Baking is required before using Products of which storage time is exceeding the recommended storage time period.

**Precaution for Product Label**

QR code printed on ROHM Products label is for ROHM's internal use only.

**Precaution for Disposition**

When disposing Products please dispose them properly using an authorized industry waste company.

**Precaution for Foreign Exchange and Foreign Trade act**

Since concerned goods might be fallen under listed items of export control prescribed by Foreign exchange and Foreign trade act, please consult with ROHM in case of export.

**Precaution Regarding Intellectual Property Rights**

1. All information and data including but not limited to application example contained in this document is for reference only. ROHM does not warrant that foregoing information or data will not infringe any intellectual property rights or any other rights of any third party regarding such information or data.
2. ROHM shall not have any obligations where the claims, actions or demands arising from the combination of the Products with other articles such as components, circuits, systems or external equipment (including software).
3. No license, expressly or implied, is granted hereby under any intellectual property rights or other rights of ROHM or any third parties with respect to the Products or the information contained in this document. Provided, however, that ROHM will not assert its intellectual property rights or other rights against you or your customers to the extent necessary to manufacture or sell products containing the Products, subject to the terms and conditions herein.

**Other Precaution**

1. This document may not be reprinted or reproduced, in whole or in part, without prior written consent of ROHM.
2. The Products may not be disassembled, converted, modified, reproduced or otherwise changed without prior written consent of ROHM.
3. In no event shall you use in any way whatsoever the Products and the related technical information contained in the Products or this document for any military purposes, including but not limited to, the development of mass-destruction weapons.
4. The proper names of companies or products described in this document are trademarks or registered trademarks of ROHM, its affiliated companies or third parties.

### General Precaution

1. Before you use our Products, you are requested to carefully read this document and fully understand its contents. ROHM shall not be in any way responsible or liable for failure, malfunction or accident arising from the use of any ROHM's Products against warning, caution or note contained in this document.
2. All information contained in this document is current as of the issuing date and subject to change without any prior notice. Before purchasing or using ROHM's Products, please confirm the latest information with a ROHM sales representative.
3. The information contained in this document is provided on an "as is" basis and ROHM does not warrant that all information contained in this document is accurate and/or error-free. ROHM shall not be in any way responsible or liable for any damages, expenses or losses incurred by you or third parties resulting from inaccuracy or errors of or concerning such information.