

# DS Series Interlock Snap Switches

## Features/Benefits

- Snap-in mounting
- Reliable snap action mechanism
- Latch or momentary
- RoHS compliant
- Halogen free material

## Typical Applications

- Interlock switch
- Detection switch
- Circuit interrupt



## Specifications

FUNCTION: Single pole double throw / Double pole double throw  
MOUNTING TYPE: Snap in style

## Electrical

ELECTRICAL LIFE: see ratings chart below  
DIELECTRIC STRENGTH: 1500 V (50-60 Hz @ sea level)  
INSULATION RESISTANCE: 100 M  $\Omega$  min.  
INITIAL CONTACT RESISTANCE: 30 milli-ohms

## Materials

HOUSING, COVER, ACTUATOR, KNOB: PA 66/6 halogen free, UL94V-0  
NO & NC FIXED TERMINALS: Copper alloy  
COMMON TERMINALS: Copper alloy, silver plate  
CONTACTS: Silver alloy / F5 rating gold plated over silver alloy  
RETURN SPRINGS: Stainless steel

## Operating Environment

OPERATING TEMPERATURE: -40°C to +85°C

**NOTE:** Specifications and materials listed above are for switches with standard options. For information on specific and custom switches, please contact Customer Service.

## Build-A-Switch

To order, simply select desired option from each category and place in the appropriate box.

D

S

**Designation**  
**DS** DS Series

**Number of Poles**  
**1** SPDT  
**2** DPDT

**Rating**

**F5** 0.1 (0.5)A @ 125/250 V AC 50/60 Hz 50E3  
0.1A G.P. @ 125/250 V AC 50/60 Hz 50E3

**F7** 0.1 (0.5)A @ 125/250 V AC 50/60 Hz 10E4  
0.1A G.P. @ 125/250 V AC 50/60 Hz 10E4

**D6** 10 (4)A @125/250 V AC 50/60 Hz 50E3  
10A G.P. @ 125 / 250 V AC 1/3HP @ 125/250 V AC 50/60 Hz 10E3

**D7\*** 16A G.P. @125/250 V AC 3/4HP 125/250 V AC 50/60 Hz 10E3  
16 (6) A @125/250 V AC 50/60 Hz 10E3  
\* Note - 16A version has Q3 terminals only

**Housing Color**  
**NONE** White  
**B** Black

**Terminals**  
**Q1** 4.8 x 0.5  
**Q2** 4.8 x 0.8  
**Q3** 6.3 x 0.8

**Actuator Style**  
**A** Momentary, Short button  
**B** Momentary, Long button  
**C** Momentary/Pulled out button (not available on D7 rating)

### International Rating Symbols

10E3	Cycles 10,000
10E4	Cycles 100,000
50E3	Cycles 50,000
10(4)	Current rating: First number represents resistive rating. Second number represents inductive (motor) rating
GP	General purpose rating UL1054



# DS Series Interlock Snap Switches

## NUMBER OF POLES

1 SPDT

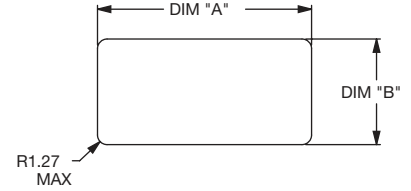
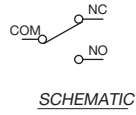
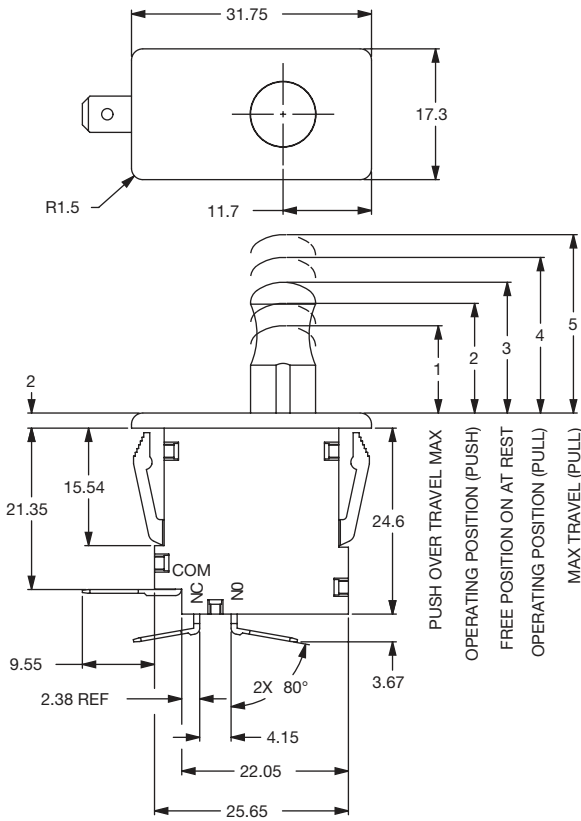

PANEL MOUNTING		
PANEL THICKNESS	DIM "A" mm	DIM "B" mm
1.14	28.32	13.97
2.54	28.58	13.97

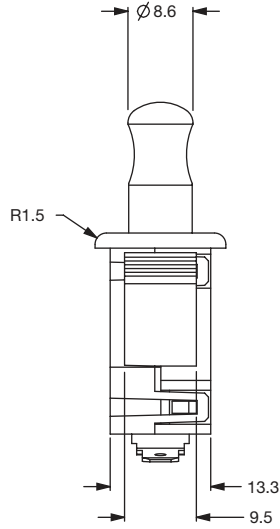

Snap-acting

2 DPDT

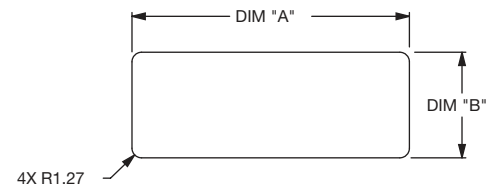
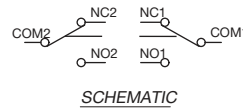
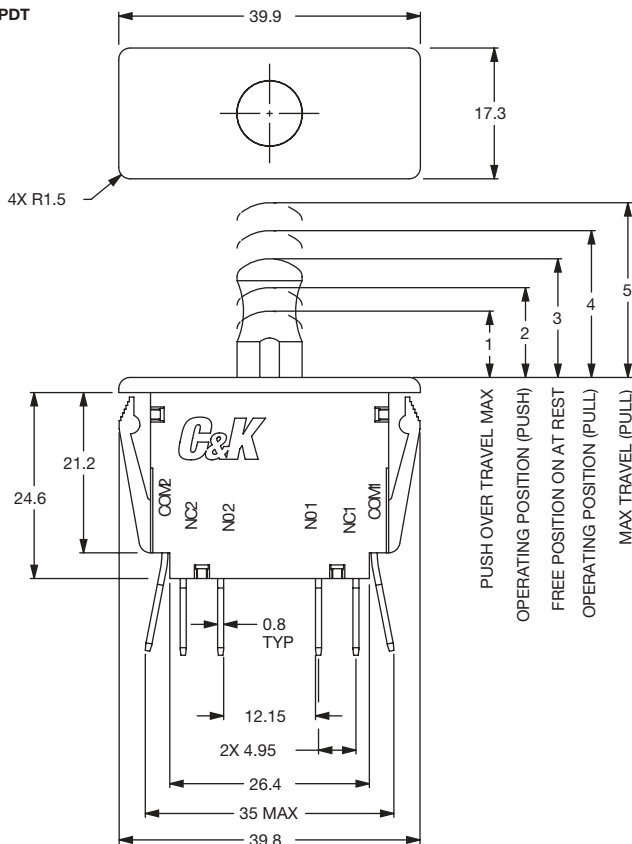

PANEL MOUNTING		
PANEL THICKNESS	DIM "A" mm	DIM "B" mm
1.14	36.70	13.97
2.54	36.96	13.97

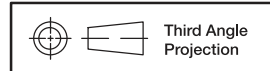
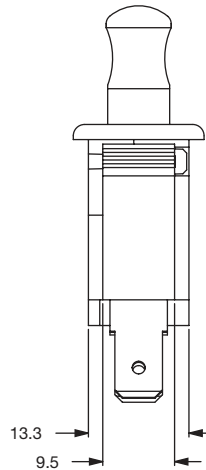

Dimensions are shown: mm  
Specifications and dimensions subject to change



31 oct 16

# DS Series Interlock Snap Switches

## ACTUATOR STYLE / SPECIFICATIONS

**A** SHORT BUTTON

**B** LONG BUTTON

**C** MOMENTARY/PULLED OUT

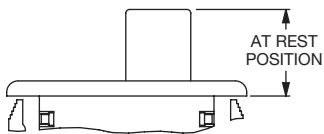

SHORT BUTTON

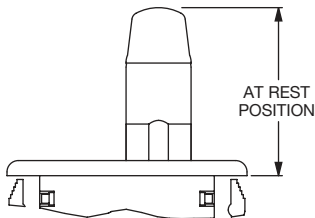

LONG BUTTON

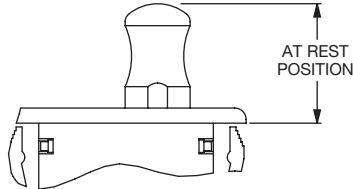

FREE POSITION

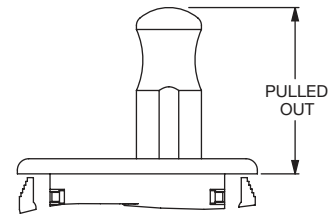

PULLED OUT POSITION

**SPDT Specification**

BUTTON STYLE	OVER TRAVEL POSITION PUSH MAX	OVER TRAVEL POSITION PULL MAX	OPERATING POSITION PUSH	OPERATING POSITION PULL	FREE POSITION AT REST	OPERATING FORCE	
A	3.20	NA	8.90 ± 1.25	NA	11.45 ± 0.75	425 gf	
B	10.15	NA	19.55 ± 1.25	NA	22.25 ± 0.75	425 gf	
C	13.20	24.90	16.75 ± 1.25	21.60 ± 1.25	19.30 ± 0.75	PUSH 385gf	PULL 475gf

**DPDT Specification**

BUTTON STYLE	OVER TRAVEL POSITION PUSH MAX	OVER TRAVEL POSITION PULL MAX	OPERATING POSITION PUSH	OPERATING POSITION PULL	FREE POSITION AT REST	OPERATING FORCE	
A	3.20	NA	8.90 ± 1.25	NA	11.45 ± 0.75	680 gf	
B	10.15	NA	19.55 ± 1.25	NA	22.25 ± 0.75	680gf	
C	13.20	24.90	16.75 ± 1.25	21.60 ± 1.25	19.30 ± 0.75	PUSH 560gf	PULL 750gf



Snap-acting

## TERMINALS

**Q1** 4.8 x 0.5  
**Q2** 4.8 x 0.8

**Q3** 6.3 x 0.8

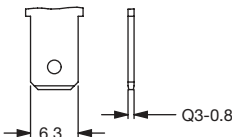
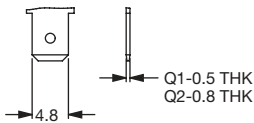

Third Angle Projection  
Dimensions are shown: mm  
Specifications and dimensions subject to change



31 oct 16