

PCB Connection Technology and Electronics Housing 2013/2014

1

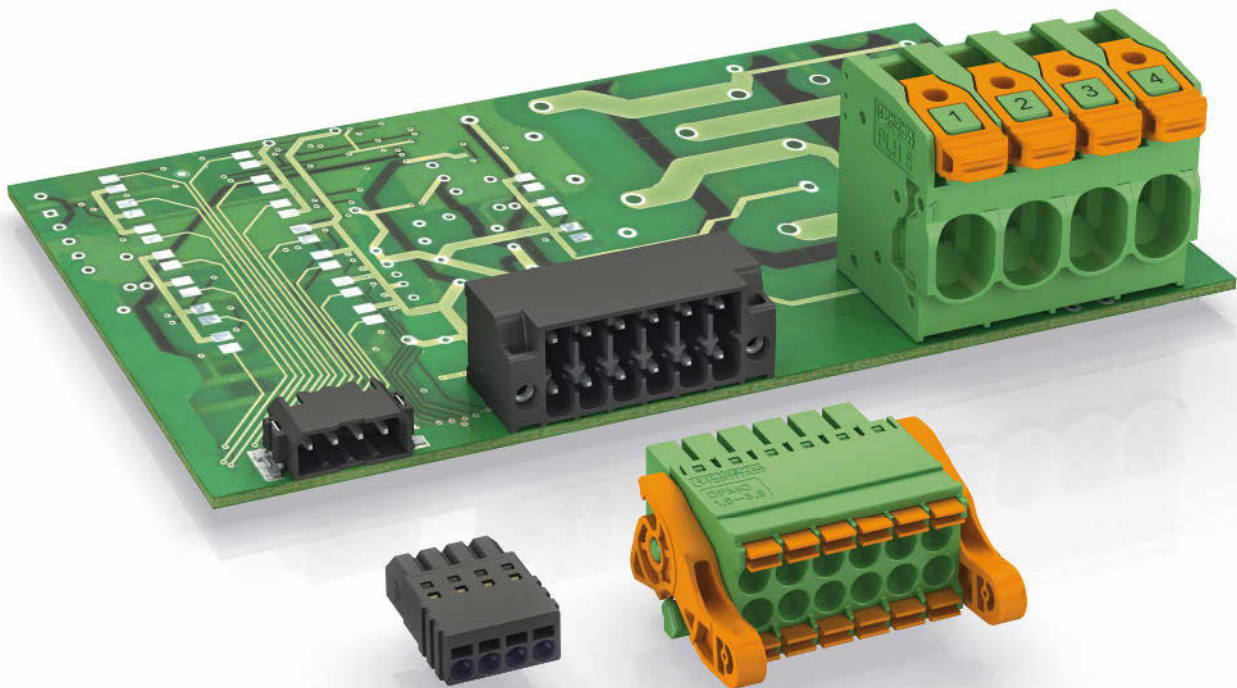



PCB connection technology and electronics housing



Connection technology for field devices

- Plug-in connectors
- Cables and connectors



Modular terminal blocks

- Modular terminal blocks



Sensor/actuator cabling and industrial plug-in connectors

- Sensor/actuator cabling
- Cables and connectors
- Plug-in connectors



Marking systems, tools, and mounting material

- Marking and labeling
- Tools
- Installation and mounting material



Surge protection and power supply units

- Lightning monitoring system
- Surge protection and interference filters
- Power supply units and UPS
- Protective devices



Interface technology and switching devices

- Electronic switching devices and motor control
- Measurement and control technology • Monitoring
- Relay modules • System cabling for controllers



Control technology, I/O systems and automation infrastructure

- Ethernet networks • Functional safety • HMIs and industrial PCs • I/O systems
- Industrial lighting and signaling • Industrial communication technology
- Fieldbus components and systems • Wireless data communication
- Process infrastructure • Software • Controllers

Table of contents

Device connection technology for signals, data, and power from Phoenix Contact			2
High density PCB terminal blocks and plug-in connectors	COMBICON HD		45
PCB terminal blocks with 2.54 to 7.62 mm pitch	COMBICON control		71
Plug-in connector systems with 2.0/2.5 and 2.54 mm pitch	COMBICON control		167
Plug-in connector systems with 3.5/3.81 and 5.08 mm pitch	COMBICON control		181
Plug-in connector systems with 5.0 to 7.62 mm pitch	COMBICON control		255
Connection technology for building and LED applications	COMBICON compact		385
PCB terminal blocks for power electronics with 5.0 to 15.0 mm pitch	COMBICON power		439
Plug-in connector systems for power electronics with 5.0 to 15.0 mm pitch	COMBICON power		481
Feed-through terminal blocks for high-current applications	COMBICON power		597
Electronics housing for industrial electronics and semi-industrial applications	HOUSING		647
Plug-in card blocks and socket strips according to DIN 41617 and IEC 60603-2/DIN 41612	COMBICON control 19 inch		773
Accessories, technical information, and index			793

COMBICON control

Connection technology for measurement and control technology and I/O modules: PCB terminal blocks and plug-in connectors with 2.54 to 7.62 mm pitch, screw, spring-cage, and insulation displacement connection, wave soldering.
From page 71



COMBICON high density & data

Plug-in connectors in miniature format - fast insulation displacement, spring, and pierce connection technology, T-branches for easy bus connections.

From page 45

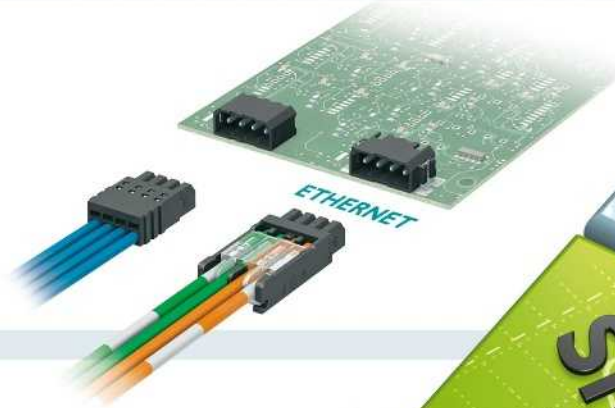

COMBICON power

Connection technology for power electronics: PCB terminal blocks and plug-in connectors for currents up to 125 A, screw and spring-cage connection, panel feed-throughs.

From page 439



COMBICON compact

Device connections for building technology and LED applications: PCB terminal blocks and plug-in connectors with 2.5 to 7.5 mm pitch, screw and spring-cage connection as well as pin strips.

From page 385

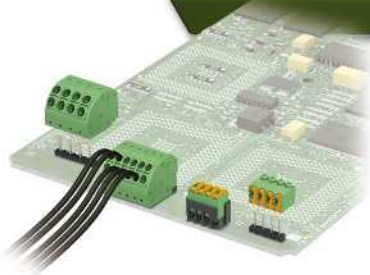

Housing

Plastic and aluminum electronics housing: component housing and panel mounting bases for industrial electronics, component housing for building installation, innovative bus connections between housing.

From page 647

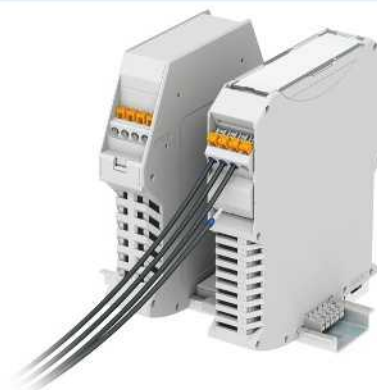



PLUSCON data

Plug-in connectors, panel feed-throughs, and cables for fieldbuses and networks.

See Catalog 2



PLUSCON circular

Flush-type plugs, plug-in connectors for assembly, and cables from M5 to M58 for signals, data, and power.

See Catalog 2



PLUSCON power

Plug-in charging systems for electromobility up to 400 A and plug-in connectors for power electronics up to 150 A.

See Catalog 2



PLUSCON device

Rectangular plug-in connectors with modular contact system for signals, power, and fiber optics with IP67 protection and available in various sizes.

See Catalog 2



PLUSCON solar

AC and DC connection systems for photovoltaic modules, inverters, and micro inverters.

See Catalog 2

Individual connection solutions for your application



Customer-specific adaptation of standard products

Found a product in our catalogs that meets your technical requirements, but you'd prefer a tailored solution? No problem – our Solution Center will be happy to provide you with support in implementing your requirements. Whether it's individual colors, special printing, a specific number of contacts or complete cable assembly – just let us know what you want.



New customer-specific product developments

Phoenix Contact has been producing high-quality products for worldwide use for over 85 years.

Benefit from our extensive development, manufacturing, and process expertise for your individual solution. Together with you, we can transform great ideas into innovative products.

Intelligent solutions in housing and connection technology increasingly require custom concepts.

As a manufacturer, you can develop products with us that meet the requirements of today's markets, such as high quality, individual design, and great customer benefits at a reasonable price.

You will have the entire expertise of the Phoenix Contact Group at your disposal. From our own tool shop and machine building through plastic injection molding and metal production to expertise in electronics production, we offer a depth of manufacturing that enables us to implement even demanding projects and complex products within a short development period.

Our own laboratory carries out testing throughout the process, handles the necessary qualifications and, of course, international approvals.

As a manufacturer, you can focus on your core competencies and benefit from our expertise as specialists in connection and housing technology.

Great products need great ideas and experience. Together with the expertise of Phoenix Contact, you can implement your individual solution - right from the initial idea to cost-effective series production.

Our products and services range from customer-specific PCB connection technology with screw, spring or IDC fast connection, in all conceivable designs and colors...

...through corresponding electronics housing in special designs in the color and size of your choice, together with the appropriate connection technology...

...individual field cabling, with plug-in connectors with shielding for high data transmission speeds, splash-proof housing for harsh industrial environments...

...to complete solutions consisting, for example, of splash-proof housing including the appropriate connection technology for signal, data, and power transmission, plus the ideal PCB connection.



Our service – added value for you

Phoenix Contact doesn't just offer the right products, it also provides a professional service for all aspects of device development. Wherever you are in the world, Phoenix Contact's global network means that you can rely on our service. Being at home all over the world and speaking the language of the user is what we understand by customer proximity. Proximity that ensures the best service for our partners. We live up to this with more than 40 customer-oriented subsidiaries and around 30 representatives in other countries.



Personal consultation and support

As our customer, you are always the focus of attention at Phoenix Contact, whether during consultation or as part of after sales support. Expert and personal consultation forms the basis of this approach. Even though we live in the age of the Internet, personal interaction with our customers is of great importance to us.

Our team of highly motivated staff are available to you at locations around the world.



Reliable delivery service

It goes without saying that our products are delivered reliably and on time. In addition to our optimized delivery service, we offer numerous options for making the purchasing process more efficient and transparent.

With warehouses in key industrial locations throughout the world, we ensure that you receive your products from Phoenix Contact cost-effectively and within the required delivery time.

Online catalog

The online catalog provides comprehensive, up-to-date information in 7 languages for more than 22,000 products from Phoenix Contact. Here you can find product-specific information such as technical data, notes on approvals, dimensional drawings, 3D data, etc.. At the click of the mouse, you can easily generate a product data sheet in PDF format.

In over 15 countries, e-shop functions complete the online catalog. Following successful registration, you can access your prices and delivery schedules at any time and you also have the option of placing orders directly online.

www.phoenixcontact.net/products

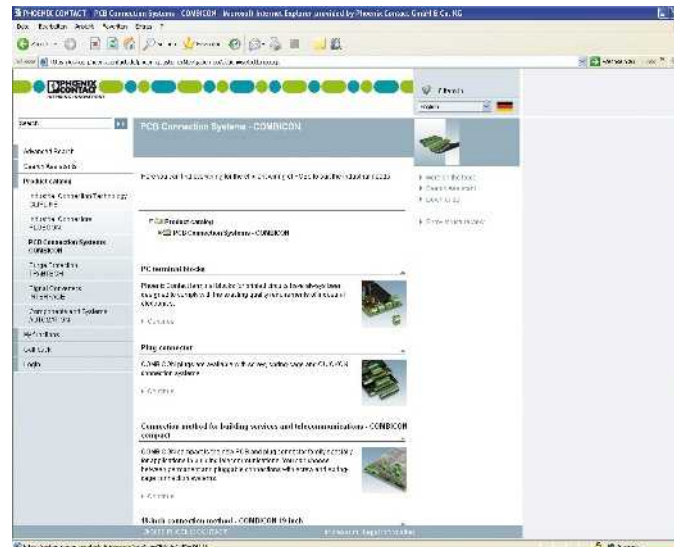

Find product-specific information quickly in the online catalog

Online search assistants

Online search assistants help you to search systematically and quickly for products from our extensive range of plug-in connectors. By selecting electrical values and other product properties, you are taken directly to the products that meet your requirements.

- COMBICON select
PCB connection and electronics housing
- PLUSCON field select
Flush-type plugs for sensor/actuator applications
- PLUSCON data select
Device plug-in connectors for fieldbuses and networks
- PLUSCON circular select
M17 to M58 device plug-in connectors

www.phoenixcontact.net/products

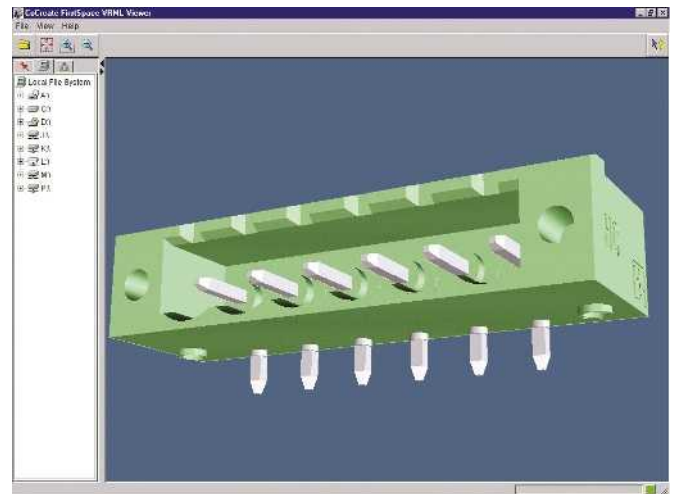

Easy download of 3D data

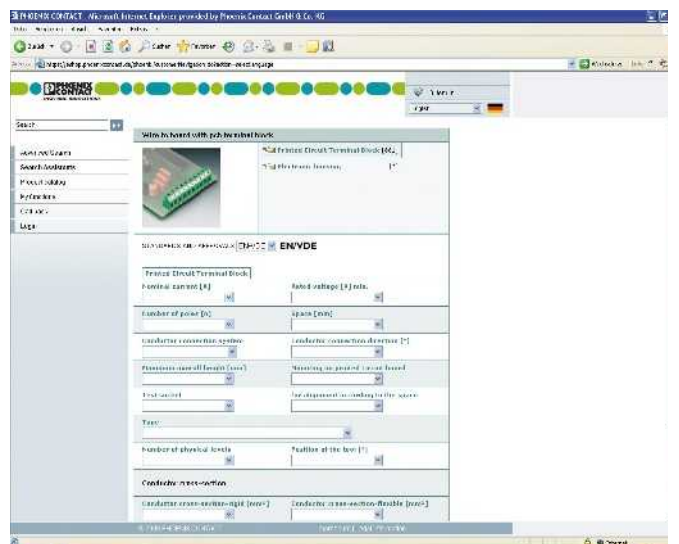

User-friendly product search with COMBICON select

Device connection technology for signals, data, and power from Phoenix Contact

Product range overview

COMBICON HD - miniature PCB terminal blocks and plug-in connectors with high contact density

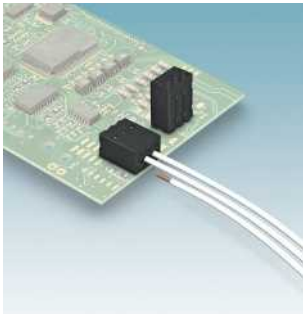

Miniature THR/SMD PCB terminal blocks and plug-in connectors with 2.5 mm pitch
PTSM 0,5...THR Page 51
PTSM 0,5...SMD Page 53

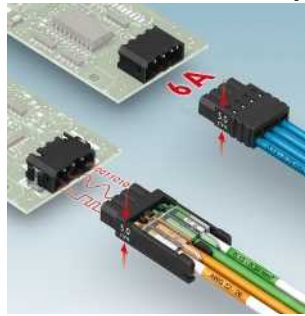

Miniature plugs and headers with 2.5 mm pitch
PTSM 0,5... Page 55
PTPM Page 55



Miniature PCB terminal block with displacement connection with 2.5 mm pitch
PTQ 0,3...THR Page 63



Plug-in connectors with displacement connection and headers with 2.0 mm pitch
CIOC...(M)(F) Page 65
CIOC...F(V)(H) Page 67

COMBICON control – multi-position and multi-level PCB terminal blocks

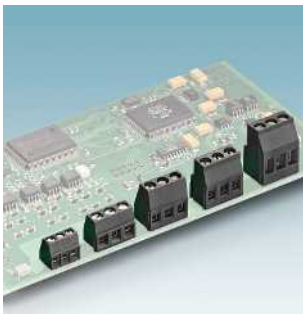

Through hole reflow applications with screw connection
 3.5/3.81/5.0/5.08 mm pitch
MKDS Page 75

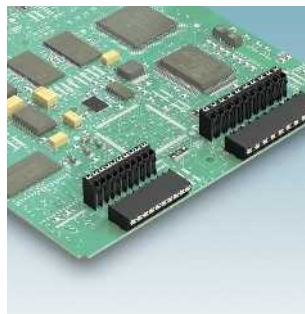

Through hole reflow applications with push-in spring connection
 3.5/3.81/5.0/5.08 mm pitch
SPT-THR 1,5 Page 78

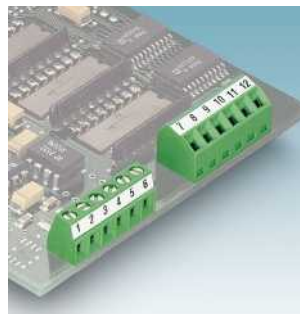

Multi-position PCB terminal blocks
 2.54/3.5/3.81 mm pitch
MPT 0,5; 0,5 mm² Page 83
SMKDS 1; 1,5 mm² Page 85

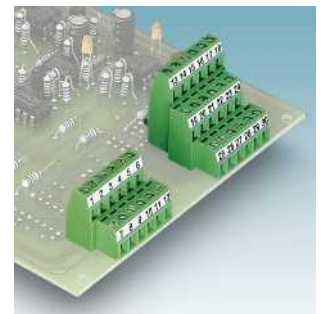

Double and three-level PCB terminal blocks with 3.5/3.81 mm pitch
MKDS 1/... Page 85
MK3DS 1/... Page 87

Multi-position and multi-level PCB terminal blocks with screw connection

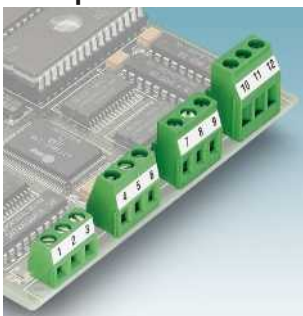

MKDSN 1,5; 1,5 mm² Page 91
MKDS 1,5; 1,5 mm² Page 95
MKDSN 2,5; 2,5 mm² Page 103

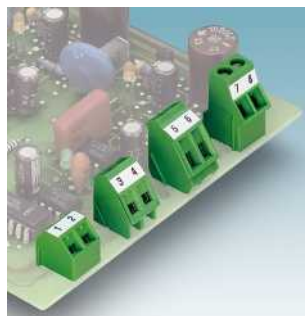

SMKDSN 1,5; 1,5 mm² Page 91
SMKDS 1,5; 1,5 mm² Page 87
SMKDS 2,5; 2,5 mm² Page 103

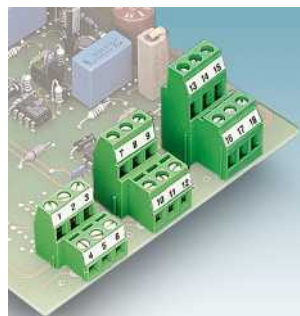

Double-level PCB terminal blocks
MKKDSN 1,5; 1,5 mm² Page 93
MKKDS 1,5; 1,5 mm² Page 97
MKKDS 3; 2,5 mm² Page 109

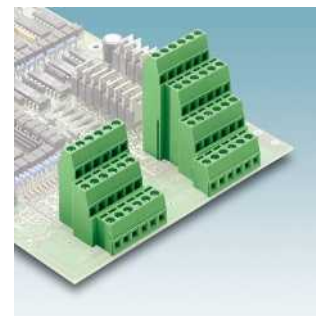

Multi-level PCB terminal blocks
MK3DS 1,5/...-5,08 Page 99
MK4DS 1,5/...-5,08 Page 101
MK3DS 3/...-5,08 Page 111

High, flat, and multi-position PCB terminal blocks with screw connection

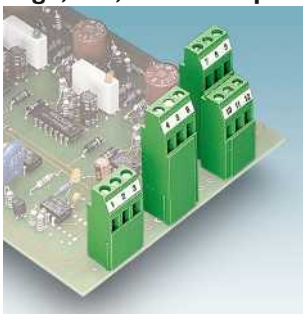

High PCB terminal blocks with 5.0/5.08 mm pitch
MKKDSNH 1,5/...-5,08 Page 93
MK3DS 1,5/...-5,08-BC Page 99

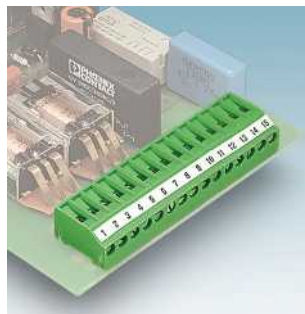

Horizontal design with 3.5/5.0 mm pitch
MKDSFW 1,5/...-3,5 Page 87
MKDSFW 3/... Page 107

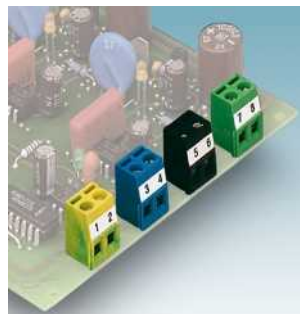

With internal bridging
MKDS 1,5-B; 1,5 mm² Page 97
MKDS 3-B; 2,5 mm² Page 105



Orthogonal PCB terminal blocks
MKDSO 1,5/...-3,5 Page 89
MKDSO 2,5/...-5,0 Page 113
MKDSO 2,5 HV/...-7,5 Page 125

COMBICON control – multi-position PCB terminal blocks with screw connection

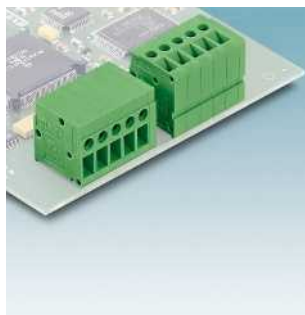

Horizontal and vertical PCB terminal blocks with front connection with 5.0 mm pitch, 2.5 mm² connection cross section
FRONT 2,5/... Page 114

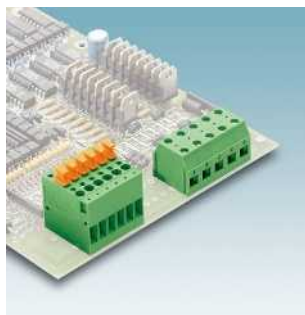

KDS (2,5) Page 117
KDS 3-PMT Page 168
KDS 3-MT Page 117
KDS(P) 4 Page 127

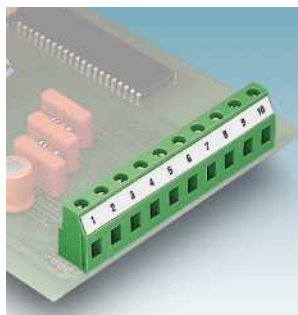

7.5/7.62 mm pitch
GMKDSN 1,5; 1.5 mm² Page 119
GMKDS 1,5; 1.5 mm² Page 121

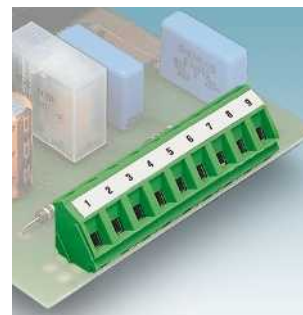

7.5/7.62 mm pitch
GSMKDSN 1,5; 1.5 mm² Page 119
GSMKDSP 1,5; 1.5 mm² Page 121
GSMKDS 3; 2.5 mm² Page 123

PCB terminal blocks with spring-cage connection or push-in spring connection

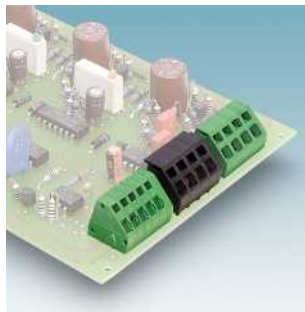

Angled PCB terminal blocks with spring-cage connection
ZFKDS 1-3,81 Page 129
ZFKDS 2,5-5,08 Page 135

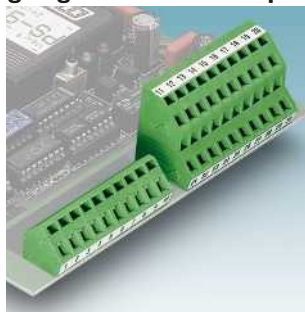

Compact design, 5.0 mm pitch, 1.5 mm² connection cross section
ZFKDS 1,5C-5,0 Page 131

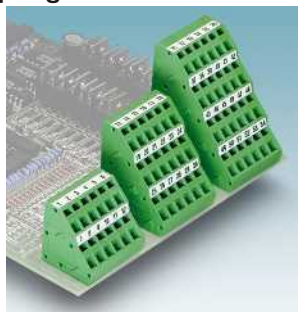

Two, three, and four-level PCB terminal blocks with 5.08 mm pitch, 2.5 mm² connection cross section Page 133

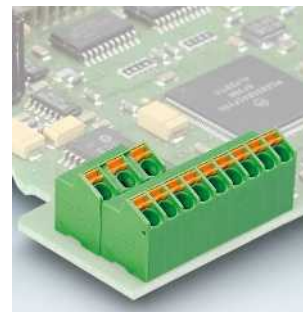

Angled PCB terminal blocks with push-in spring connection
SPTA 1/... Page 137
SPTA 1,5/... Page 139

PCB terminal blocks with push-in spring connection or displacement connection

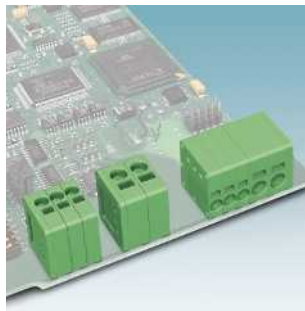

Horizontal and vertical push-in spring connection, 3.5/5.0 mm pitch
SPT 1,5/...-3,5 Page 141
SPT 2,5/...-5,0 Page 143

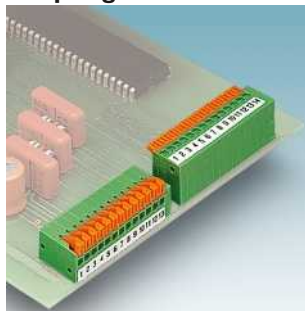

Horizontal and vertical push-in spring connection, 2.54/3.81/5.08/7.62 mm pitch
FFKDS(A)... Page 145



Orthogonal push-in spring connection
FKDSO... Page 153

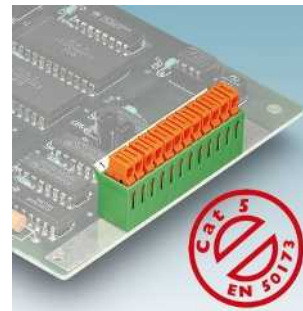

Displacement connection with 3.81 mm pitch, 0.5 mm² connection cross section
IDC 0,3/...-3,81 Page 154

PCB terminal blocks with screw connection or spring connection for the Ex area

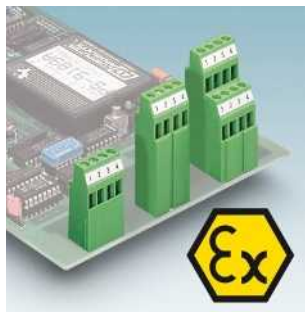

High PCB terminal blocks with 5.0/5.08 mm pitch
MKKDSH 3/...-EX Page 157
MK3DSH 3/...-5,08-EX Page 157
MK3DSMH 3/...-5,08-EX Page 157

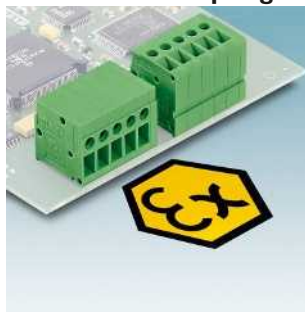

Horizontal and vertical PCB terminal blocks with front connection with 5.0 mm pitch, 2.5 mm² connection cross section
FRONT 2,5/...-EX Page 158

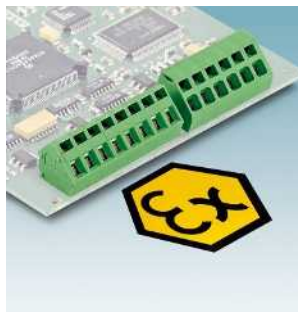

Spring-cage connection with 5.0/5.08 mm pitch
ZFKDS 1,5C-5,0-EX Page 161
ZFKDS 2,5-5,08-EX Page 161

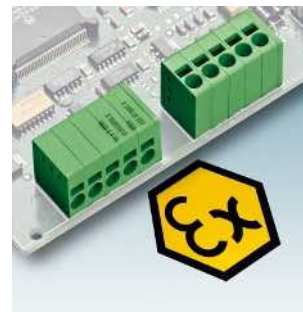

Horizontal and vertical push-in spring connection with 3.5/5.0 mm pitch
SPT 2,5/...-5,0-EX Page 163

Product range overview

COMBICON control - plug-in connector systems with 2.5/2.54/3.5/3.81 mm pitch



Plugs and headers, 2.5 mm pitch
FK-MC 0,5/...-ST-2,5 Page 168
MC(V) 0,5/...-G-2,5(THT) Page 172



Push-in plugs and headers for THR and SMD processes with 2.54 mm pitch
FMC 0,5; 0,5 mm² Page 174



Double-row plug-in connector with push-in spring connection, 3.5 mm pitch
DFMC 1,5/...-ST(F)-3,5(-LR) Page 184

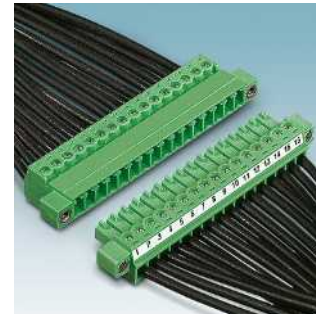

Inverted plugs with screw connection, 3.81 mm pitch
MC 1,5/...-ST(F)-... Page 190
IMC 1,5/...-ST(F)-3,81 Page 196

Plug-in connectors with 3.5/3.81 mm pitch with screw or push-in spring connection

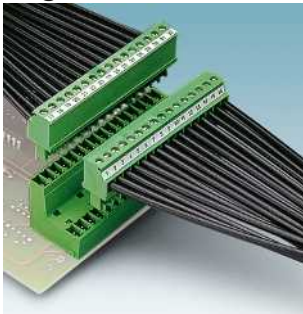

Plugs with 3.5/3.81 mm pitch, plug-in direction vertical to the conductor axis
MCVR(W) 1,5/...-ST(F)-... Page 192



Plugs with front connection, 3.81 mm pitch
FRONT-MC 1,5/...-ST(F)-... Page 194

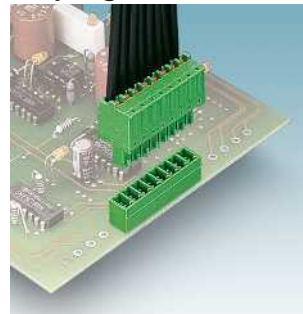

Plugs with push-in spring connection, 3.5/3.81 mm pitch
FK-MCP 1,5/...-ST(F)-... Page 198



Plugs with push-in spring connection, 3.5/3.81 mm pitch, flat, compact design
FMC 1,5/...-ST(F)-... Page 200

Plug-in connectors with 3.5/3.81 mm pitch and headers for reflow and wave soldering processes

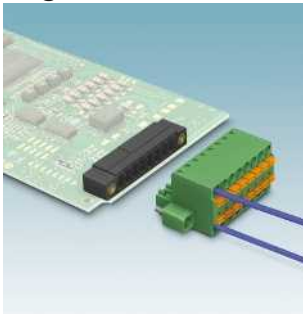

TWIN plugs with push-in spring-cage connection, 3.5/3.81 mm pitch, for potential distribution
TFMC 1,5/...-ST(F)-... Page 202

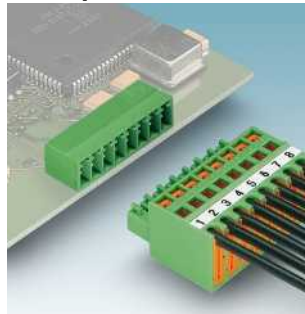

Plugs with IDC displacement connection, 3.81 mm pitch, connection cross section 0.5 mm²
QC 0,5/...-ST(F)-3,81 Page 204



Plugs with crimp connection, 3.81 mm pitch, 1.0 mm² connection cross section
MCC 1/...-STZ(F)-3,81 Page 206

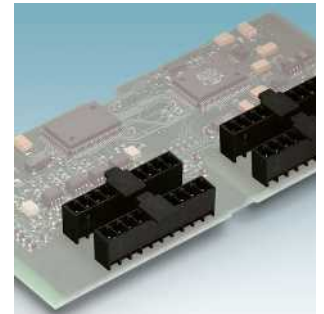

Reflow solderable headers, 3.5/3.81 mm pitch, horizontal and vertical plug-in direction
 Page 208

Headers with 3.5/3.81 mm pitch for press-in technology and wave soldering processes

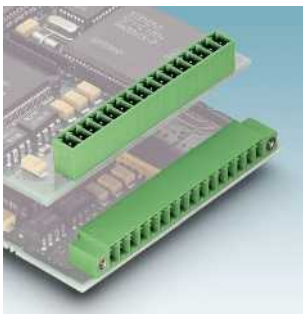

Headers for press-in technology, 3.5/3.81 mm pitch, horizontal and vertical plug-in direction
EMC(V) 1,5/...-G(F)-... Page 222

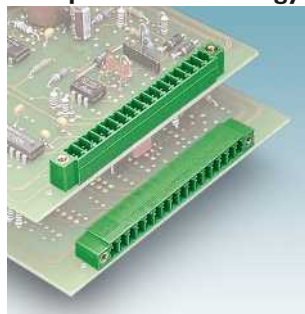

Headers for wave soldering process, 3.5/3.81 mm pitch, horizontal and vertical plug-in direction
MC(V) 1,5/...-G(F)-... Page 224

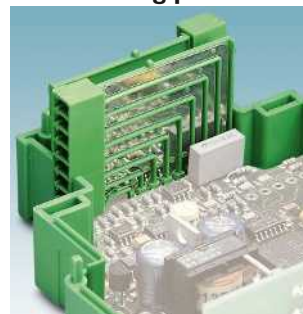

Headers with 3.81 mm pitch with orthogonal plug-in direction
MCO 1,5/...-G-3,81 Page 231



Headers with 3.5 mm pitch with orthogonal plug-in direction
MCO 1,5/...-G1...-3,5 Page 232

COMBICON control - headers with 3.81 mm pitch

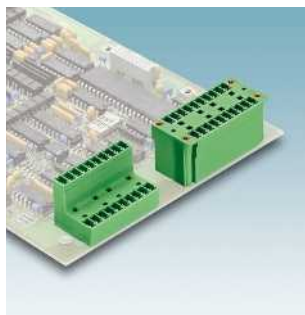

Double-level headers, 3.81 mm pitch, horizontal and vertical plug-in direction
MCD(V) 1,5/...-G(F)-3,81 Page 234

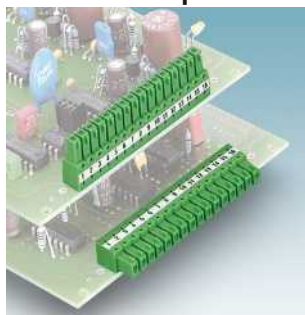

Inverted headers, 3.81 mm pitch, horizontal and vertical plug-in direction
IMC(V) 1,5/...-G(F)-3,81 Page 238



Feed-through headers, 3.81 mm pitch, with spade connection
DFK-MC 1,5/...-G(F)-3,81 Page 240



Cable housing for screw plugs, 2- to 16-pos., 3.81 mm pitch
KGK-MC 1,5/...-G(F)-3,81 Page 242
MCVR 1,5/...-ST(F)... Page 192

Plug-in connectors with 5.0/5.08 mm pitch with screw connection

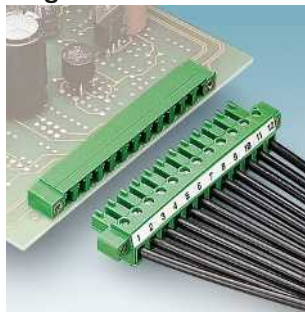

Plugs with screw connection and headers, 5.08 mm pitch
MC 1,5/...-ST(F)-5,08 Page 246

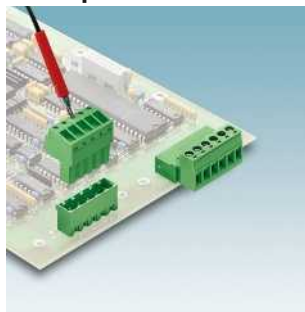

Plugs with screw connection, 5.0/5.08 mm pitch, with/without test connection
MSTB 2,5/...-ST(F)... Page 262

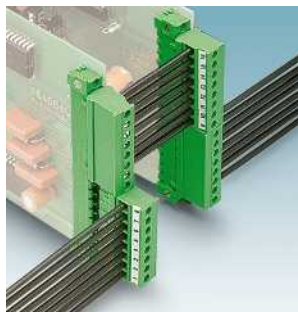

Plugs with screw connection, 5.0/5.08 mm pitch, plug-in direction 90° to the conductor axis
MVSTBR(W) 2,5/...-ST(F)... Page 266



Plugs with front screw connection, 5.0/5.08 mm pitch
FRONT-MSTB 2,5/...-ST(F)... Page 269

Plug-in connectors with 5.0/5.08 mm pitch with screw and push-in spring connection

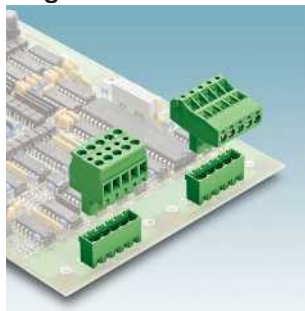

TWIN plugs, 5.08 mm pitch, for potential distribution
TMSTBP 2,5/...-ST(F)-5,08 Page 270

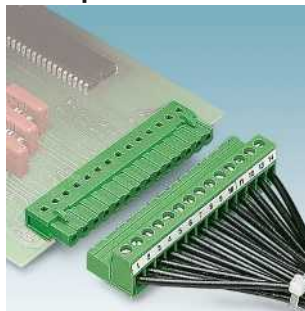

Inverted plug with screw connection, 5.08 mm pitch
IC 2,5/...-ST(F)-5,08 Page 272

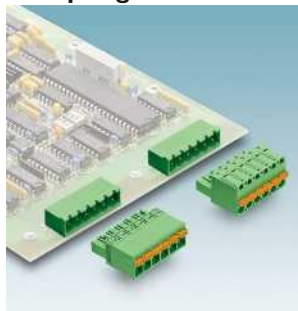

Plugs with push-in spring connection, 5.0/5.08 mm pitch
FKC(T) 2,5/...-ST(F)... Page 274

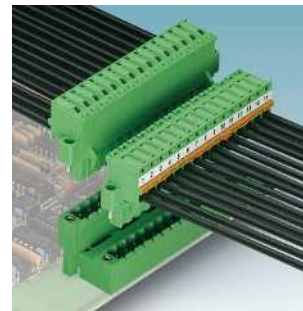

Plugs with push-in spring connection, 5.0/5.08 mm pitch, plug-in direction 90° to the conductor axis
FKCVR(W) 2,5/...-ST(F)... Page 280

Plug-in connectors with 5.0/5.08 mm pitch with push-in spring or insulation displacement connection



TWIN plugs with push-in spring connection, 5.0 mm pitch, for potential distribution
TVFKC 1,5/...-ST-5,0 Page 282



TWIN plugs with push-in spring connection, 5.08 mm pitch, for potential distribution
TFKC 2,5/...-ST-5,08 Page 284

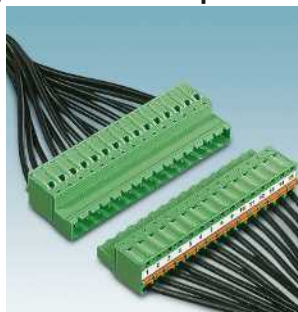

Inverted plug with push-in spring connection, 5.0/5.08 mm pitch
FKIC 2,5/...-ST(F)... Page 286

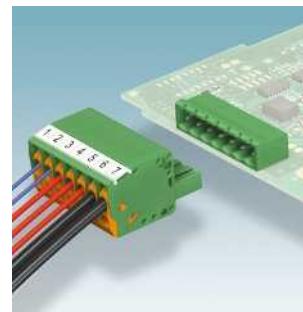

Plugs with IDC displacement connection, 5.0/5.08 mm pitch
QC 1,0/...-ST(F)-5,08 Page 290
QC 1,5/...-ST(F) Page 292

Device connection technology for signals, data, and power from Phoenix Contact

Product range overview

COMBICON control – plug-in connectors with 5.0/5.08 mm pitch with crimp connection and header

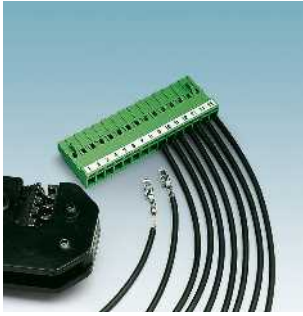

Plugs with crimp connection, 5.08 mm pitch
MSTBC 2,5/...-ST(Z)(F)-5,08 Page 294

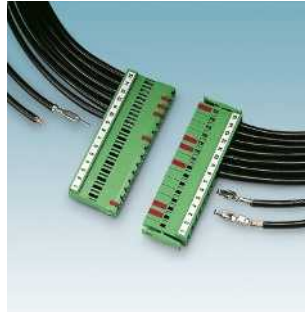

Inverted plugs with crimp connection, 5.08 mm pitch
ICC 2,5/...-STZ(F)-5,08 Page 296

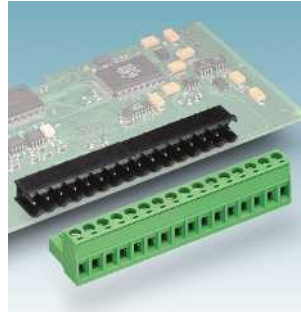

Reflow solderable headers, 5.0/5.08 mm pitch, horizontal and vertical plug-in direction
CCA(V) 2,5/...-G(F)-... THR Page 298



Reflow solderable headers, 5.0 mm pitch, with orthogonal plug-in direction
MSTBO 2,5/...-G1-5,0 THR Page 308

Headers with 5.0/5.08 mm pitch for press-in technology and wave soldering processes

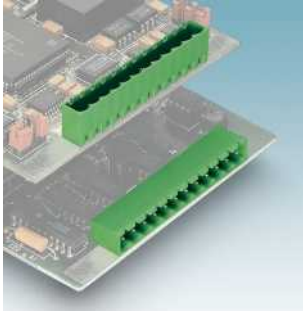

Headers for press-in technology, 5.0/5.08 mm pitch, horizontal and vertical plug-in direction
EMSTB(V) 2,5/...-G(F)-... Page 310

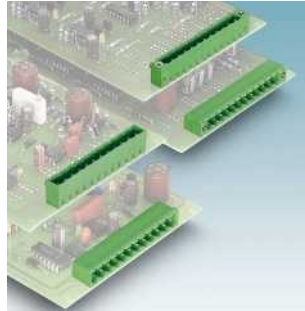

Headers for wave soldering processes, 5.0/5.08 mm pitch, horizontal and vertical plug-in direction
MSTB(V) 2,5/...-G(F)-... Page 312

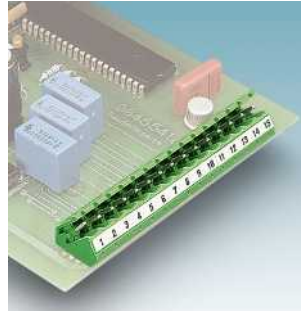

Headers with 5.0/5.08 mm pitch, angled plug-in direction, with/without side panel
SMSTB(A) 2,5/...-G(F)-... Page 318

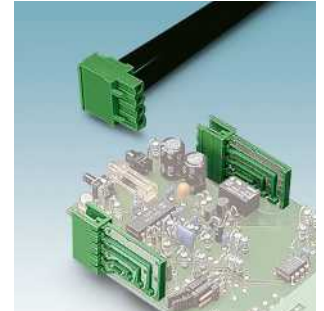

Headers with 5.08 mm pitch orthogonal plug-in direction
MSTBO 2,5/...-G1-5,08 Page 320

Headers with 5.0/5.08 mm pitch



Headers with 5.0 mm pitch orthogonal plug-in direction, wave/reflow soldering processes
MSTBO 2,5/...-G1...-5,0 Page 322

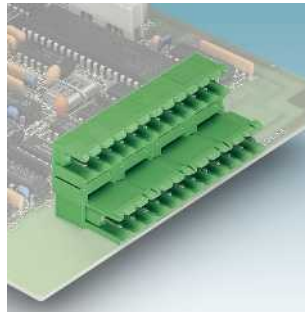

Double-level headers, 5.0/5.08 mm pitch, horizontal and vertical plug-in direction, with level offset
MDSTB(V) 2,5/...-G(F)-... Page 326

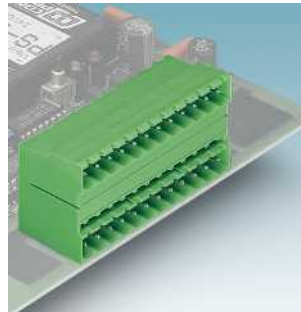

Double-level headers, 5.0/5.08 mm pitch, horizontal and vertical plug-in direction, without level offset
MDSTB(V) 2,5/...-G1(F)-... Page 329

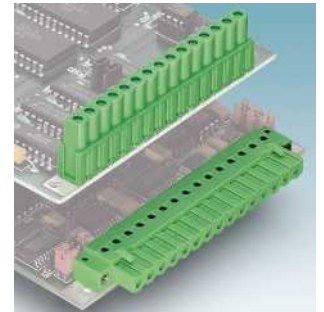

Inverted headers, 5.08 mm pitch, horizontal and vertical plug-in direction
IC(V) 2,5/...-G(F)-5,08 Page 332

Plug-in connectors with 7.5/7.62 mm pitch with screw and push-in spring connection

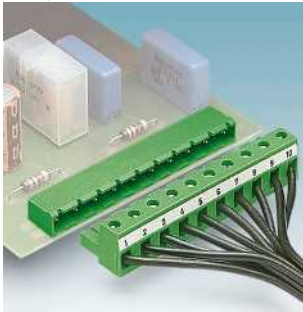

Plugs with screw connection, 7.5/7.62 mm pitch, plug-in direction parallel to the conductor axis
GMSTB 2,5/...-ST(F)-... Page 334

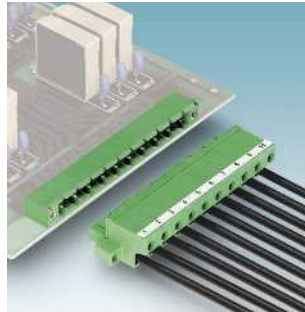

Plugs with front screw connection, 7.5/7.62 mm pitch
FRONT-GMSTB 2,5/...-ST(F)-... Page 335

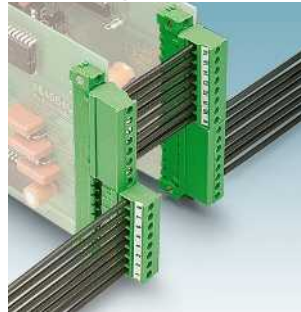

Plugs with screw connection, 7.5/7.62 mm pitch, plug-in direction 90° to the conductor axis
GMVSTBR(W) 2,5/...-ST(F)-... Page 336

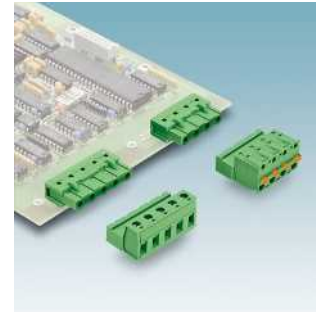

Inverted plug with screw and spring connection, 7.62 mm pitch
GIC 2,5/...-ST(GF)-7,62 Page 338
GFKIC 2,5/...-ST-7,62 Page 341

Plug-in connectors with 7.5/7.62 mm pitch with push-in spring-cage connection and headers with 7.5/7.62 mm pitch

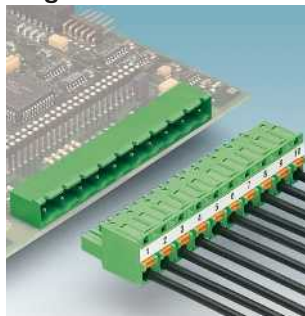

Plugs with push-in spring connection, 7.5/7.62 mm pitch, plug-in direction parallel to the conductor axis
GFKC 2,5/...-ST(F)-... Page 340

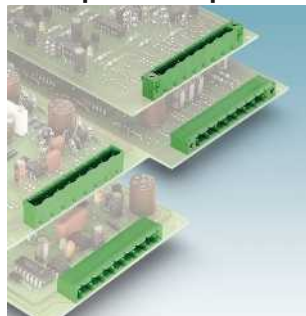

Headers with 7.5/7.62 mm pitch, horizontal and vertical plug-in direction
GMSTB(V) 2,5/...-G(F)-... Page 342

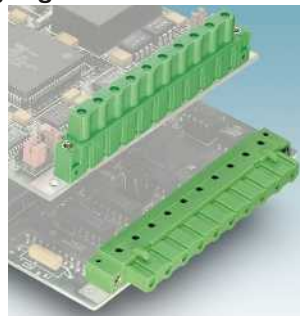

Inverted headers with 7.5/7.62 mm pitch, horizontal and vertical plug-in direction
GIC(V) 2,5/...-G(F)-... Page 346



Cable housing for plugs with screw connection, 2- to 24-pos., 5.0/5.08/7.5/7.62 mm pitch
Page 348

Plug-in connectors for panel feed-throughs and for direct mounting



Feed-through assembly frames for inverted plug-in connectors, 5.08 mm pitch, with/without threaded flange
IC-DFR-... Page 350



Headers for panel feed-through, 5.0/5.08 mm pitch, with spade connection
DFK-MSTB 2,5/...-G(F)-... Page 352



Headers for panel feed-through, 5.08 mm pitch, with spade connection
DFK-MSTB(A) 2,5/...-G(F)-... Page 354

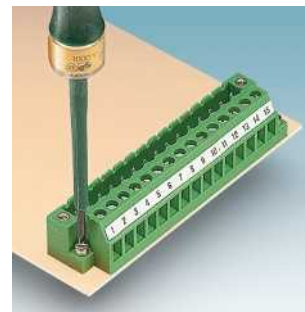

Plugs/headers with screw connection and screw flange for direct mounting
MSTBU 2,5/... Page 356

Plug-in connectors for DIN rail mounting, for direct contacting with PCBs and special designs

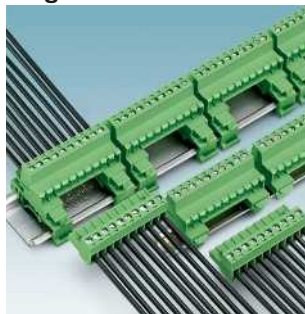

Inverted plugs for mounting on DIN rails, 5.0/5.08 mm pitch
Page 358



Plugs and headers for mounting on DIN rails, 5.08 mm pitch
Page 360

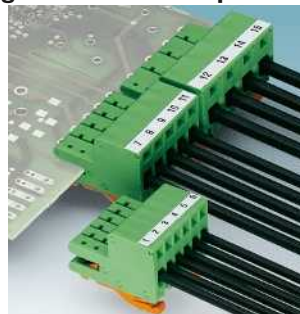

Direct plug-in connectors with spring-cage connection
ZEC 1,0/...-ST-3,5 Page 365
ZEC 1,5/...-ST-5,0 Page 365

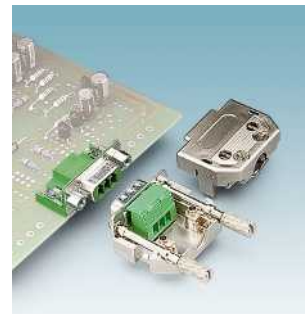

Plugs with screw connection, for D-SUB panel feed-throughs and headers
PSC 1,5/... Page 251

Plug-in connectors for the Ex area and plug-in card blocks

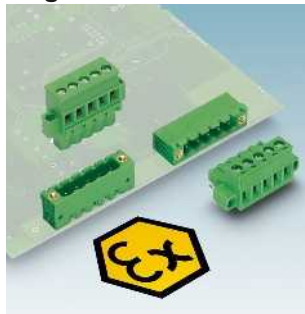

Plugs with screw connection and headers for the Ex area
Page 368

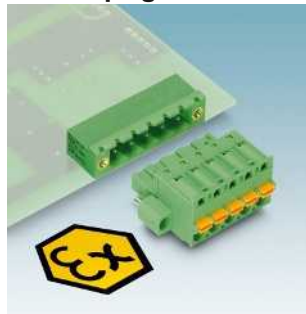

Plugs with push-in spring connection for the Ex area, 5.08/7.62 mm pitch
FKC 2,5/...STF5,08 EX Page 371
GFKC 2,5/ 2-STF-7,62 EX Page 381



Plug-in card blocks for European-format cards with indirect connection
Page 776

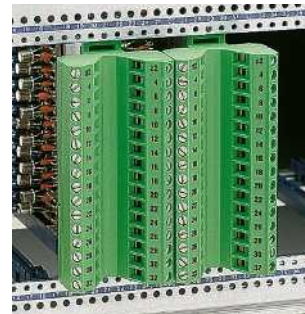

Socket strips with screw and spring-cage connection
Page 788

Product range overview

COMBICON compact - connection technology for buildings and LED applications



Miniature PCB terminal blocks and plugs
PTSM 0,5...THR Page 391
PTSM 0,5...SMD Page 53

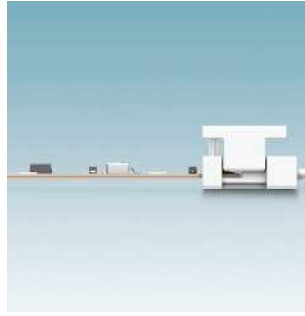

Plug-in connectors for flexible PCBs
PTF 0,3... Page 401
PTPM Page 55

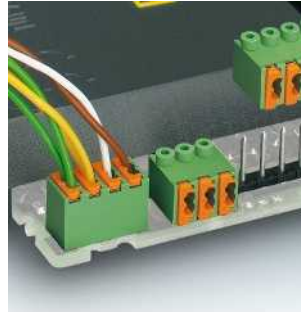

PCB terminal blocks and plugs with spring-cage double connection up to $2 \times 0,5 \text{ mm}^2$
FK-MPT 0,5-3,5 series Page 403

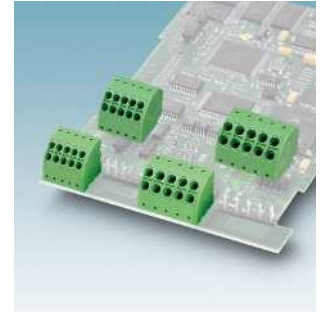

Angled pin strip plugs with spring-cage connection of $2 \times 1,5 \text{ mm}^2$ and $2 \times 2,5 \text{ mm}^2$
PTDA series Page 407

PCB terminal blocks and plug-in connectors with spring/screw connection



Angled PCB terminal block with spring-cage connection, $1,5 \text{ mm}^2$
PTSA series Page 413

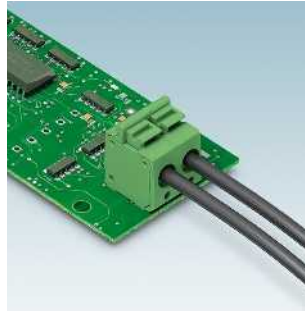

PCB terminal block with horizontal spring-cage connection
PTS series Page 415

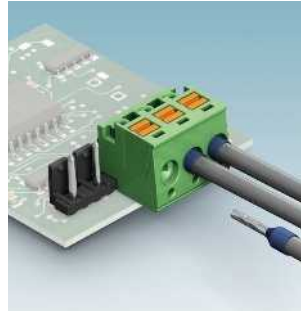

Pin-strip plugs with spring connection
PTS 1,5/...-PH-5,0 Page 417

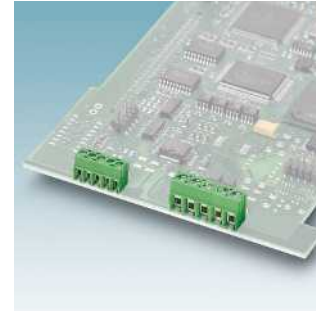

PCB terminal blocks with horizontal screw connection and conductor protection, $1,5$ or $2,5 \text{ mm}^2$
PT 1,5 series Page 419

PCB terminal blocks and plug-in connectors with screw connection

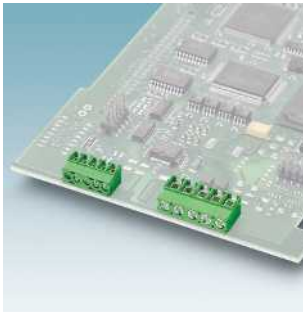

PCB terminal blocks with vertical screw connection and conductor protection, $3,5 \text{ mm}$ pitch
PT 1,5 series Page 419

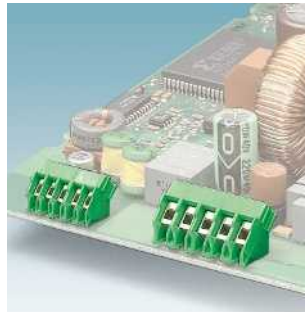

PCB terminal blocks with angled screw connection and conductor protection, $5,0 \text{ mm}$ pitch
PTA 1,5 series Page 419

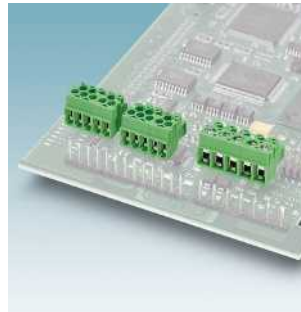

Pin strip plugs with screw connection and conductor protection clips, $1,5$ or $2,5 \text{ mm}^2$
PT 1,5/-PVH/PH series Page 423

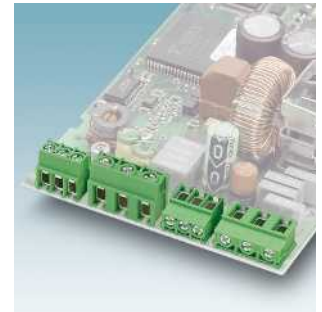

PCB terminal blocks with screw connection and conductor protection clips, 4 mm^2
PT 2,5 series Page 427

Plug-in connectors and pin strips

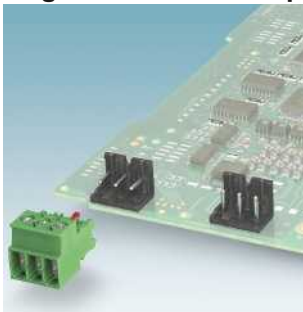

Multi-plug-in system with screw connection and base strips, up to 4 mm^2
PT 2,5/...-PVH series Page 431

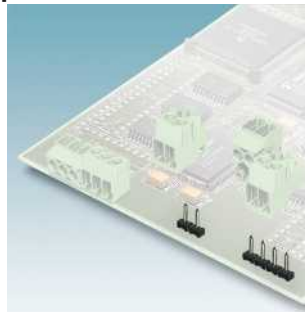

Vertical and horizontal pin strips for COMBICON compact plugs, reflow solderable
PST family Page 432



Reflow solderable pin strips in machine-capable tape-on-reel packing
PST tape-on-reel packing Page 433

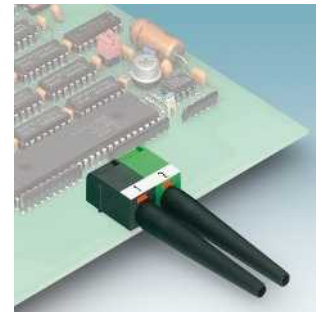

FO fast connection PCB terminal blocks for polymer fibers
FOPT 2,2-T/R Page 436

COMBICON power - PCB terminal blocks up to 16 mm² with screw connection



MKDS 5 series: screw connection, up to 32 A, 6.35/7.62/9.52 mm pitch
MKDS 5... Page 443

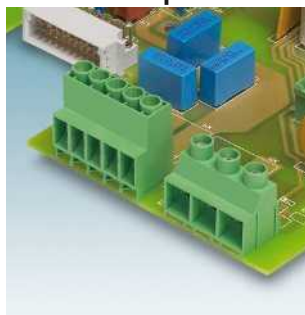

MKDS 5 HV series: screw connection, up to 41 A, 6.35 mm/9.52 mm pitch for 600 V UL
MKDS 5 HV... Page 445

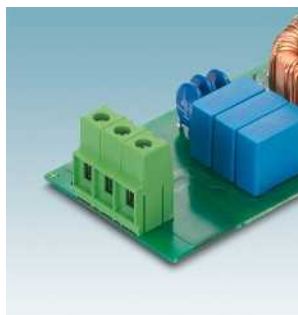

MKDSP 10 series: screw connection, up to 76 A, 10.16/12.7 mm pitch with test connection
MKDSP 10... Page 451



MKDS 10 HV series: screw connection, up to 76 A, 10.16 mm pitch for 600 V UL
MKDS 10... Page 451

PCB terminal blocks up to 35 mm² with screw connection

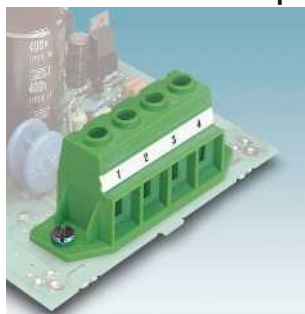

MKDSP 25 series: screw connection, up to 125 A, 15 mm pitch
MKDSP 25... Page 455

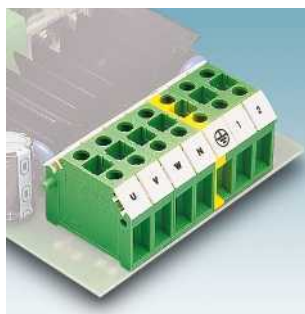

KDS 10 series: feed-through terminal block with screw connection, up to 76 A, 10 mm pitch
KDS 10/... Page 457

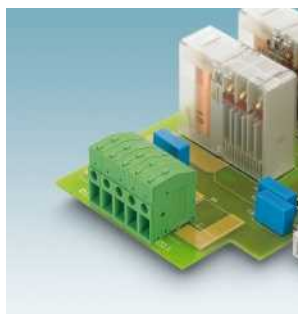

FRONT 4 series: front screw connection, up to 32 A, connection: horizontal, 6.35/7.62 mm pitch
FRONT 4 H... Page 459

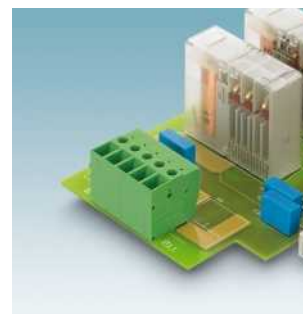

FRONT 4 series: front screw connection, up to 32 A, connection: vertical, 6.35/7.62 mm pitch
FRONT 4 V... Page 459

PCB terminal blocks up to 16 mm² with push-in spring connection

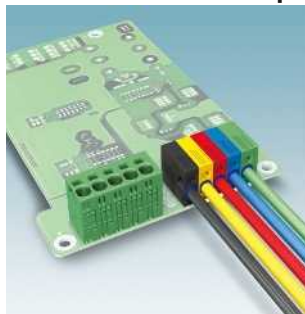

SPT 5 series: push-in spring connection, up to 41 A, connection: vertical and horizontal, 7.5 mm pitch
SPT 5... Page 463



PTSPL 6 series: push-lock spring connection, up to 41 A, without insulating body
PTSPL 6... Page 475

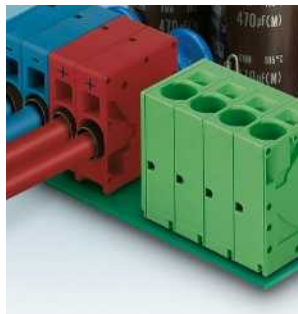

SPT 16 series: push-in spring connection, up to 76 A, connection: vertical and horizontal
SPT 16... Page 467

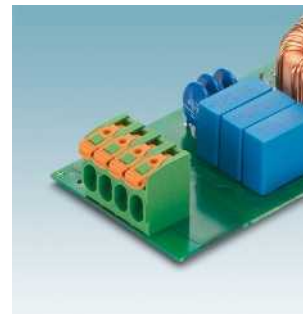

PLH-5 series: push-lock spring connection, pitch 7.5 mm, up to 41 A connection: horizontal
PLH 5... Page 470

PCB terminal blocks up to 16 mm² with push-lock spring connection and spring-cage connection



PLH 5 series: push-lock spring connection, 7.5 mm pitch, up to 41 A, connection: 30° to PCB
PLH/A 5... Page 470

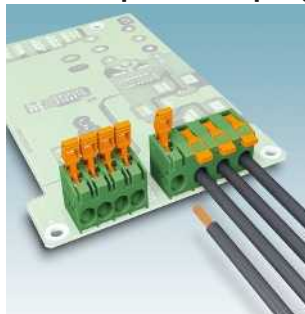

PLH 16 series: push-lock spring connection, 10/15 mm pitch, up to 76 A, connection: horizontal
PLH 16... Page 473



ZFKDS 4 series: spring-cage connection, up to 32 A, 7.5/10 mm pitch
ZFKDS 4... Page 477

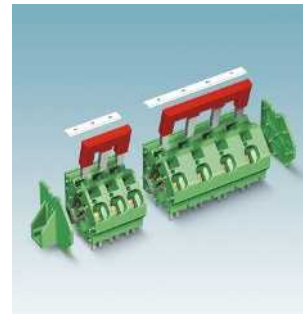

ZFKDS 10 series: spring-cage connection, up to 76 A, 10/15 mm pitch
ZFKDS 10... Page 479

Product range overview

COMBICON power - plug-in connectors up to 2.5 mm² with screw and spring connection

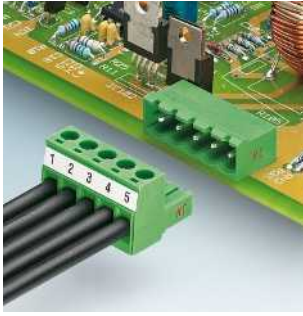

HC series: screw connection, up to 16 A, 5/5.08 mm pitch
MSTB 2,5 HC... Page 490

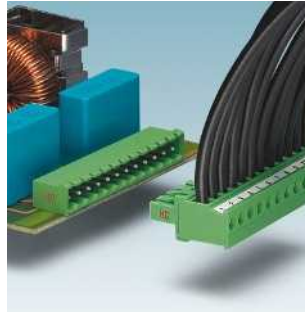

HC series: screw connection, vertical connection direction, up to 16 A, 5/5.08 mm pitch
MVSTBR(W) 2,5 HC... Page 492

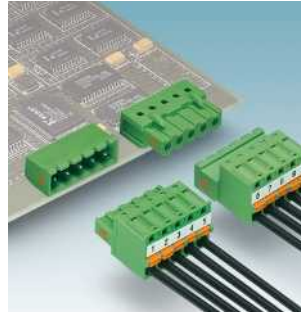

HC series: spring connection, up to 16 A, 5/5.08 mm pitch
FKC 2,5 HC... Page 494

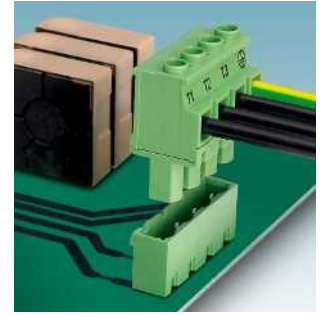

HV series: vertical connection direction, screw connection, up to 16 A, 7.62 mm pitch, 600 V UL
GMVSTBR/W 2,5 HV... Page 500

Plug-in connectors up to 2.5 mm² with screw and spring connection

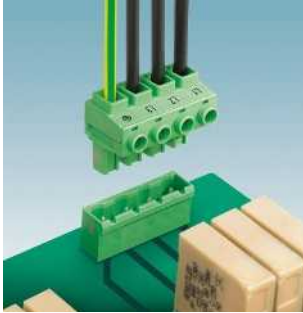

HC series: screw connection, up to 16 A, 7.62 mm pitch, 600 V UL
GMSTB 2,5 HCV... Page 502



HC series: screw connection, up to 16 A, 7.62 mm pitch, 600 V UL
GIC 2,5 HCV... Page 503

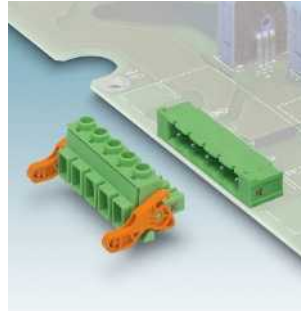

HC series: screw connection, up to 16 A, 7.62 mm pitch, 600 V UL
GMSTB 2,5 HCV L&R... Page 503



HC series: screw connection, up to 16 A, housing terminal, 600 V UL
GMSTBT 2,5 HV... Page 508

Plug-in connectors up to 4 mm² with screw and crimp connection

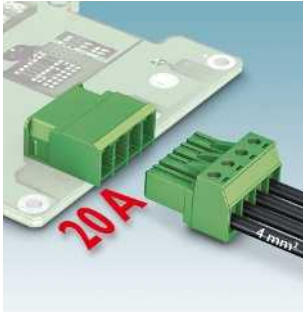

PC 4 series: plugs/headers, screw connection, up to 20 A, 7.62 mm pitch
PC 4 ... Page 512

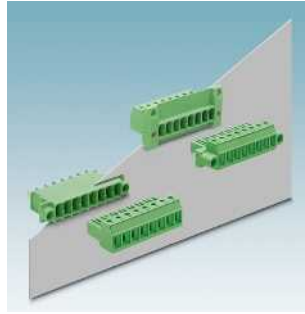

PC 4 series: feed-through plug screw or solder connection, up to 20 A, 7.62 mm pitch
DFK-PC 4... Page 518



PC 4 series: plugs, crimp connection, up to 20 A
PCC 4... Page 514



PC 4 series: cable housing for PC 4 plugs
KGG-PC 4/KGS-PC 4... Page 522

Plug-in connectors up to 6 mm² with screw and spring connection

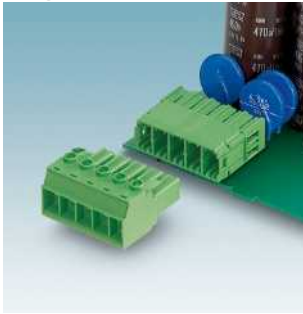

PC 5 series: plugs/headers, screw connection, up to 41 A, 7.62 mm pitch, also Click & Lock
PC 5 Page 524

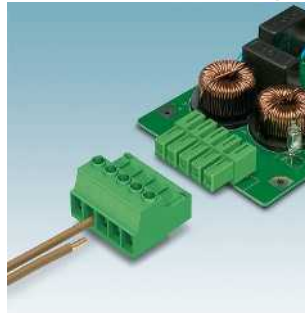

PC 5 series: inverted plugs/headers screw connection, up to 41 A, 7.62 mm pitch
IPC 5/... Page 526

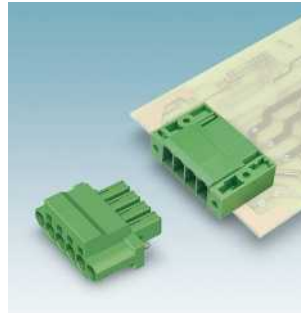

PC 5 series: plugs/headers, spring connection, up to 41 A, 7.62 mm pitch
SPC 5/... Page 530



PC 5 series: inverted plugs/headers, spring connection, up to 41 A, 7.62 mm pitch
ISPC 5/... Page 544

COMBICON power - plug-in connectors up to 6 mm² with screw and spring-cage connection

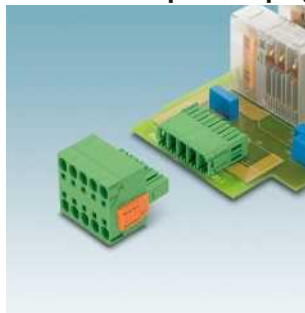

PC 5 series: plugs with double spring connection, up to 41 A, 7.62 mm pitch
TSPC 5... Page 532



PC 5 series: plugs/headers with EMC shield connection, up to 41 A
PC 5...SH... Page 525

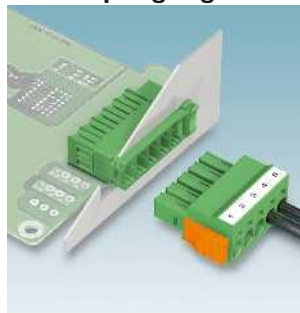

PC 5 series: feed-through headers, solder connection, up to 41 A
DFK-PC 5... Page 544

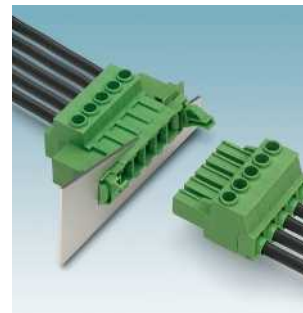

PC 5 series: feed-through headers, screw connection, up to 41 A
DFK-PC 5 Page 544

Plug-in connectors up to 16 mm² screw connection



PC 6 series: plugs/headers screw connection, up to 41 A, 10.16 mm pitch
PC 6/... Page 550



PC 6 series: plugs for direct mounting, screw connection, up to 41 A, 10.16 mm pitch
PCU 6/... Page 552

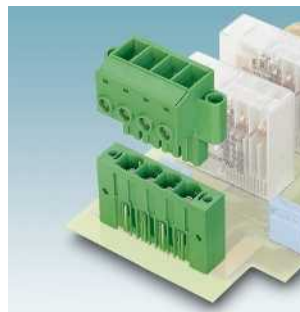

PC 16 series: plugs/headers screw connection, up to 76 A, 10.16 mm pitch
PC 16/... Page 554

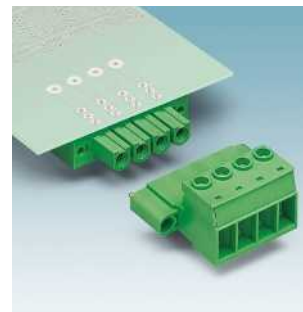

PC 16 series: inverted plugs/headers with screw connection, up to 76 A, pitch 10.16 mm
IPC 16/... Page 558

Plug-in connectors up to 16 mm² with screw and spring connection

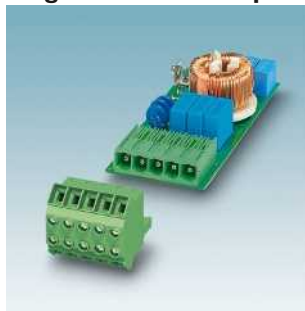

PC 16 series: plugs with double screw connection, up to 76 A, 10.16 mm pitch
TPC 16... Page 556

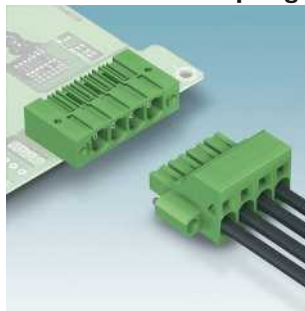

PC 16 series: plugs/headers with spring connection, up to 76 A, 10.16 mm pitch
SPC 16... Page 562

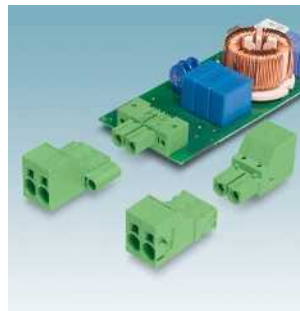

PC 16 series: inverted plugs/headers with spring connection, up to 76 A, 10.16 mm pitch
ISPC 16... Page 564

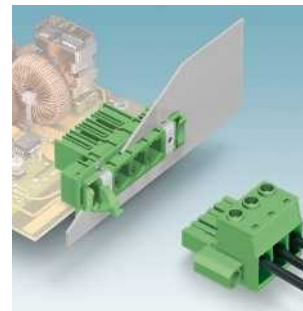

PC 16 series: feed-through headers, solder and screw connection, up to 76 A, 10.16 mm pitch
DFK-PC 16... Page 574

Plug-in connectors up to 35 mm² screw connection

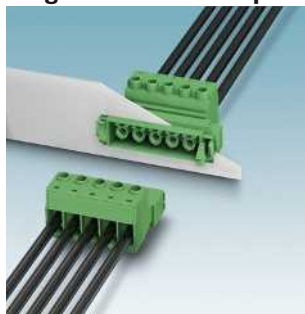

PC 16 series: inverted feed-through headers, solder and screw connection, up to 76 A, 10.16 mm pitch
DFK-IPC 16... Page 578

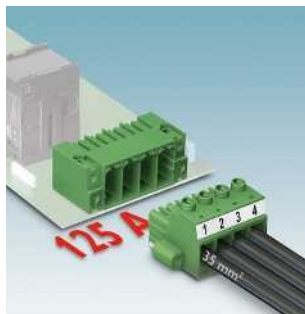

PC 35 series: plugs/headers screw connection, up to 125 A
PC 35... Page 586

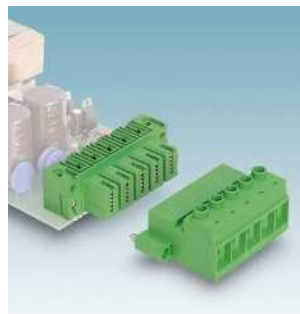

PC 35 series: inverted plugs/headers screw connection, up to 125 A
IPC 35... Page 588



PC 35 series: feed-through headers, solder connection, up to 125 A
DFK-PC 35... Page 593

Product range overview

COMBICON power - feed-through terminal blocks up to 16 mm² with fast connection technology



PW 4-POT series: push-in connection, up to 32 A with orange latch
PW 4-POT... Page 601



PWO 4-POT series: push-in connection, up to 32 A, without orange latch
PWO 4-POT... Page 603



PWO 16-POT series: push-in connection, up to 76 A, without orange latch
PWO 16-POT... Page 604



PLW 16 series: push-lock spring connection, up to 76 A outside lever, inside push-in spring
PLW 16... Page 605

Feed-through terminal blocks up to 35 mm² with screw connection



UW 4 series: screw connection, up to 41 A, connection: vertical and horizontal
UW 4... Page 607



UW 10 series: screw connection, up to 76 A, connection: vertical and horizontal
UW 10... Page 610

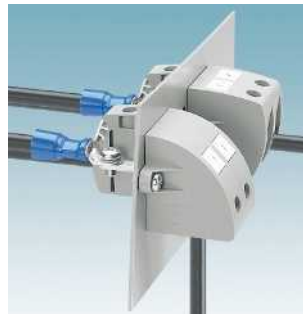

UW 16 series: screw connection, up to 101 A, connection: vertical and horizontal
UW 16... Page 612



UW 25 series: screw connection, up to 125 A, connection: vertical and horizontal
UW 25... Page 614

Feed-through terminal blocks up to 95 mm² with screw connection



HDFK 50 series: screw connection, up to 150 A, connection: vertical and horizontal
HDFK 50... Page 617

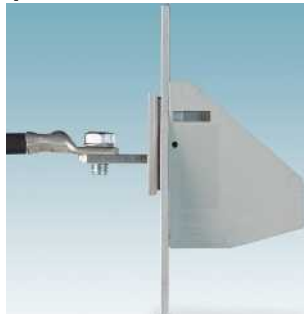

HDFK 50-VP/HDFK 95-VP series: screw connection, up to 232 A, molded terminal blocks
HDFK 50...VP... Page 619



HDFK 95 series: screw connection, up to 232 A, connection: vertical and horizontal
HDFK 95... Page 619



HDFK...TWIN series: screw connection, up to 125 A, two conductors - one potential
HDFK...TWIN Page 623

High-current feed-through terminal blocks up to 150 mm² with bolt connection



RW 5 series: bolt connection, up to 76 A, connection: vertical and horizontal
RW 5... Page 624

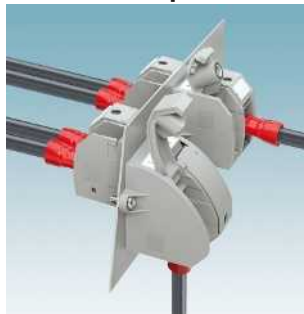

RW 8 series: bolt connection, up to 125 A, connection: vertical and horizontal
RW 8... Page 626

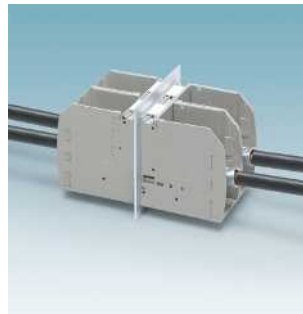

RWO 10 series: bolt connection, up to 150 A, terminal open
RWO 10... Page 636



RWO 10-TC series: bolt connection, up to 150 A, terminal transparent cover
RWO 10-TC... Page 637

Housing



Customer-specific housing solutions including connection technology Page 648

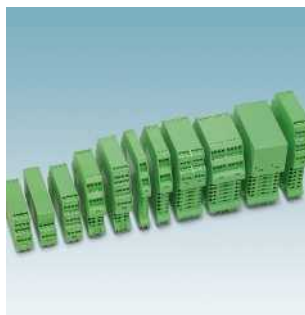

ME... component housings
Space-saving design with many additional functions Page 652

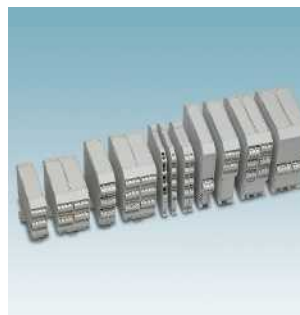

ME MAX... component housings
Large PCB surface yet compact dimensions Page 678



BC... installation component housings
Housings for installation distributors according to DIN 43880 Page 694

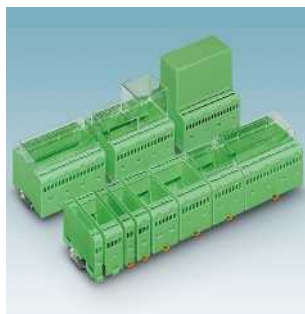

EMG... component housings
DIN rail-mountable housings in fine type scaling Page 708



EG... component housings
Receptacle housings for multiple PCB arrangements Page 718

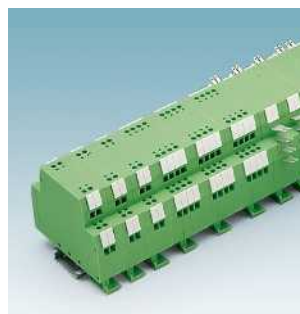

UEG... component housings
Shell housing with variable connection technologies Page 722



UEGM... component housings
Shell housing with variable connection technologies Page 724

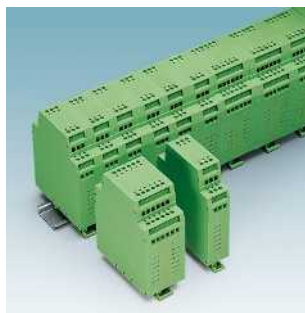

UEGH... component housings
Shell housings with two levels and variable connection technologies Page 726



ME PLC... component housings
Multifunctional housings for intelligent electronics Page 732



CM... component housings
Rugged housing range for rail-mountable power electronics Page 736



EFG 45 component housings
Half-shell housing with front plates for complex electronics Page 738



UM-ALU... panel mounting bases
Rugged profile housings for the control cabinet Page 742



UM-PRO... panel mounting bases
Profile housings for flexible electronics development Page 748



UM... panel mounting bases
Profile housings for individual PCB dimensions Page 754



HC-ALU...
Dust-tight and watertight handheld housings Page 766

Connection versatility with Phoenix Contact

Connection of your choice

Whether you choose screw, spring or insulation displacement connection technology, Phoenix Contact always provides the highest level of quality.

You can choose the worldwide standard: the versatile screw connection. This connection technology combines a large contact surface with high contact force and is a completely maintenance-free, easy, and gentle conductor connection.

Alternatively, you can also choose modern spring connection technology. Whether spring-cage or leg spring, both concepts ensure a high level of clamping reliability. In particular, leg spring systems with their short wiring times enable quick and easy connection without additional tools based on the push-in principle.

Looking for even faster wiring? Then choose the insulation displacement connection (IDC) method. The sophisticated insulation displacement or pierce connection technology ensures optimum and durable contacting.

Irrespective of whether you require a connection for signal, data or power cables, the COMBICON range offers the right terminal block for every application.

Furthermore, Phoenix Contact clamping parts are designed so that all Class 5 copper conductor types can be clamped without pretreatment.

The following pages provide an overview of the existing connection technologies and their advantages.

Screw connection with tension sleeve

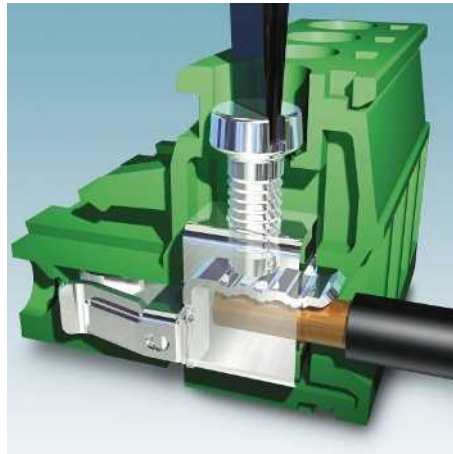

Screw connection with tension sleeve technology is the most widely used connection technology. Maximum contact force per contact surface can be achieved irrespective of the conductor cross section. Long-term stable connections can be achieved using special high-grade copper alloys, even under difficult conditions (e.g., in aggressive atmospheres). This ensures a gas-tight contact point and permanently low contact resistance. The integrated screw locking system (Reakdyn principle) prevents the loosening of the connection.

Customer benefits:

- The flat clamping part base ensures that even the thinnest connecting conductors are safely clamped (zero clamping)
- Transverse grooves in the current bar ensure that oxide film on the conductor is broken, and they provide a wrench-proof connection, which ensures good contact condition.

Areas of application:

- Applications that require high contact reliability in industrial environments

Push-in connection



The leg spring enables quick, tool-free connection of conductors. The solid conductor or a fine-strand conductor with ferrule is simply inserted into the push-in terminal point and pressed against the current bar by the leg spring.

It is only when fine-strand conductors without ferrules are connected and when this connection is released that it is necessary to actuate the opening lever, which is a feature of these terminal blocks.

Customer benefits:

- Fast connection by means of direct plug-in technology - "push-in"
- Easy operation, thanks to color-coded actuating lever
- No tools required
- Compact design

Areas of application:

- Fast wiring in the field where intuitive operation is an advantage

Spring-cage connection



Spring-cage technology enables easy connection without the need for special tools and conductor pretreatment. This spring is opened via the actuation shaft using a screwdriver and the conductor is inserted into the spring-cage via the separate conductor shaft. When the tool is removed, the spring then pulls the conductor against the power rail. This connection can be released in the same way.

Customer benefits:

- No conductor pretreatment required
- High level of contact reliability for industrial applications
- Universally used connection technology
- Time savings compared to screw connection

Areas of application:

- Fast connection technology for electronic devices

Push-in spring connection



The push-in spring combines the advantages of the leg spring with those of spring-cage technology, thereby enabling conductor connection without additional tools by means of direct plug-in technology. In addition, the fixed, predefined cage of the combined springs prevents the conductor from slipping sideways.

Therefore, the push-in spring enables, in particular, the tool-free connection of large conductor cross sections with moderate force.

Customer benefits:

- Fast connection by means of tool-free direct plug-in technology - "push-in"
- User-friendly, thanks to the protection against operating errors
- Large conductor cross sections can be connected with moderate force

Areas of application:

- Compact device connection of large conductor cross sections for fast wiring in the field.

Push-lock spring connection



The push-lock spring enables easy and tool-free conductor connection with or without ferrules by means of the "one-hand tilting lever principle".

Simply insert the solid or stranded conductor in the open terminal point and connect it reliably by actuating the tilting lever via the push-lock spring. Alternatively, conductors can also be inserted directly when the lever is closed by means of the push-in method.

Customer benefits:

- Quick and easy connection by means of the "one-hand tilting lever principle" or direct plug-in technology - "push-in"
- No conductor pretreatment required
- Intuitive operation, thanks to color-coded actuating lever
- Tool-free

Areas of application:

- Fast, easy-maintenance connection technology for the internal wiring of electronic devices and in the field.

Connection versatility with Phoenix Contact

Front screw connection



COMBICON front screw connection with pressure clip technology is a space-saving connection system from Phoenix Contact.

In the case of the COMBICON front connection, cable routing and actuation of the terminal block screw are on the same level.

Reliable clamping of the conductor is ensured by the force-increasing swiveling movement of the angled pressure plate, which is supported in the robust clamping part pocket such that it can swing freely and presses the conductor against the power rail.

Customer benefits:

- Cable routing and actuation of the terminal block screw are on the same level
- Flush cover for installation on the front of devices

Areas of application:

- Particularly suitable for PCB racks and narrow device fronts

Screw connection with wire protector



COMBICON compact with wire protector technology is the PCB terminal block and plug-in connector range from Phoenix Contact for semi-industrial applications. Therefore, the same quality requirements are placed on the COMBICON compact product range as those for the industrial COMBICON product range.

However, the PCB connection technology of COMBICON compact has been greatly simplified in some areas and adapted to the conditions of building technology.

Customer benefits:

- Highly flexible wire protector
- Large rectangular clamping spaces
- Suitable for terminal connections up to a conductor cross section of 4 mm²

Areas of application:

Building technology, safety technology, telecommunications, etc.

Insulation displacement connection (IDC)



Reliable contacting using IDC (insulation displacement connection) connection technology is achieved by inserting the conductor into the specially designed cutting metal.

This method centers the conductor and cuts open the insulation in the cutting zone, thereby creating a reliable connection between the conductor and cutting metal. This connection technology is suitable for cables with PVC and PE insulation.

Eliminating cable preparation, such as stripping and the fitting of splicing protection, results in significant time savings of up to 60% compared to conventional connection technologies.

Customer benefits:

- Particularly time-saving connection technology
- Stripping and the fitting of splicing protection is not required
- No special tools required

Areas of application:

- Installation applications where a variety of conductors with similar cross sections must be connected in a short amount of time
- Field installation, since only minimal tools are needed for connection and conductor pretreatment is not required

Crimp connection



The crimp connection technology enables fast, cost-effective connection for cables that have to be assembled in large volumes.

The wire/crimp contact connection is established using crimping pliers or a crimping machine.

Taped crimp contacts are available for fully automated processing.

The crimp plugs in the various plug-in connector series can be used in combination with virtually all headers.

Customer benefits:

- Variable production run startup, thanks to fully or semi-automatic machine
- High tensile strength for the connection
- Low contact resistance
- Easy production monitoring
- High resistance to ambient conditions, vibration, and shock

Areas of application:

- Crimp connections are the ideal connection system for harsh ambient conditions, such as extreme temperature change, vibration and shock, and aggressive atmospheres

Pierce connection

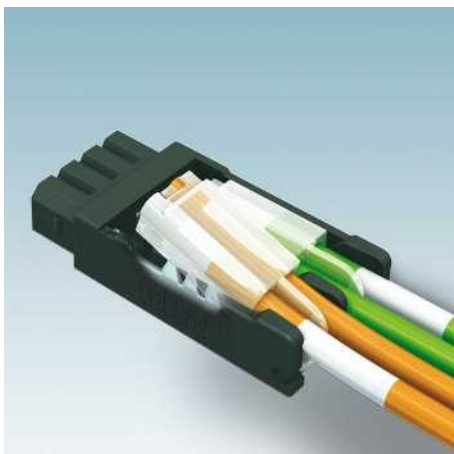

Pierce connection is a reliable connection technology that does not require conductor pretreatment. Contact is made by inserting the conductors in the corresponding guide in the transparent cover of the plug-in connector. When the cover is closed, the pierce contacts pierce through the conductor insulation and so ensure a durable conductor connection.

Customer benefits:

- Time-saving connection technology
- Stripping and the fitting of ferrules is not required
- No special tools required
- Conductors can be easily released by opening the cover

Areas of application:

- Easy field installation, since conductor pretreatment and special tools are not required

Bolt connection

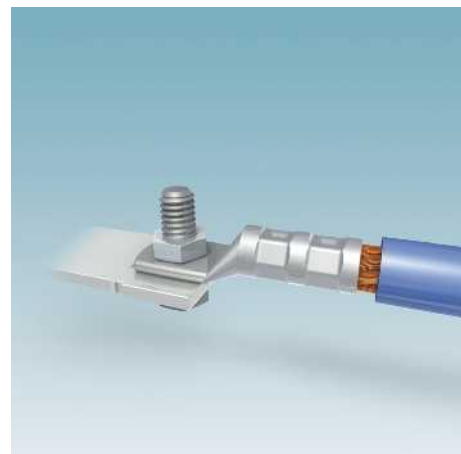

Bolt connection technology has been developed with a robust design and for the convenient wiring of ring cable lugs.

The ring cable lug is simply placed on the bolt and secured in place with the nut. The captive nut is connected to a hinged cover flap. This means that ring cable lugs can be connected quickly and easily.

The integrated screw locking in the form of a spring retainer guarantees safe use, even in applications which are subject to shock and vibration.

Customer benefits:

- Quick and easy ring cable lug wiring
- Conductors up to 150 mm² can be wired securely and with long-term stability
- Easy multi-conductor connection, up to four cable lugs can be connected per bolt

Areas of application:

- Applications which require ring cable lugs to be connected quickly and easily

COMBICON contact technology

Corrosion-resistant metal parts

We believe that high-quality terminal blocks must be designed to enable the consistent use of corrosion-resistant materials and surface systems. Naturally, Phoenix Contact uses high-grade corrosion-resistant copper alloys and high-grade Cr(VI)-free processed steel parts as standard for its PCB terminal blocks and plug-in connectors. This eliminates the possibility of electrolytic corrosion due to humidity and the risk of rusting and its consequences, i.e., unreliable electrical contacts and/or jammed screws.

Metallic contact surfaces are used to protect components against corrosion and environmental influences and to ensure their mechanical and electrical function. In order to achieve this, the layers must comply with the RoHS and WEEE EC Directives.

The selection of the contact system surface must balance the technical requirements, such as the current carrying capacity, contact resistance, resistance to environmental influences, with the cost-effectiveness of the solution.

Tin-plated contact system



Tin layers are the most commonly used surfaces in contact systems for PCB connections from Phoenix Contact. They are used for the soldering and/or contact surface. For plug-in contacts, reliable

contacting can be achieved at higher voltages and currents ($> 20 \text{ mV}$; $> 100 \text{ mA}$).

Tin-plated plug-in connections have a slightly higher contact force than gold-plated contact systems. This results in gas-tight contact zones with low contact resistance in combination with the relatively soft tin.

With regard to solder contacts, tin surfaces are particularly suitable for soldering applications due to the relatively low melting point of tin and its compatibility with tin-based solders. Phoenix Contact uses a nickel resistive layer to prevent the normal tendency of tin to initiate an intermetallic reaction with base materials such as brass or bronze. This ensures the long-term quality of the surface (soldering capability after storage) and also prevents whisker growth in the long term.

Silver-plated contact system



Due to their very high level of conductivity even at higher currents, silver layers are particularly suitable for use as contact surfaces. Phoenix Contact uses this surface system accordingly in plug-in

connectors, e.g., for high-current applications (COMBICON power). Silver-plated surfaces are also characterized by their low contact force and high insertion/withdrawal cycles.

Gold-plated contact system



Due to their noble electrochemical characteristics, gold layers are especially resistant to corrosion from a wide range of aggressive substances. This means that gold surfaces are not affected by oxidization, which allows low contact-normal forces to be applied to ensure electrical function. With these characteristics, gold surfaces are ideal for low voltages and currents ($< 3 \text{ mA}$; $< 20 \text{ mV}$) and durable surfaces with > 100 insertion/withdrawal cycles.

COMBICON direct plug-in technology

Plug-in contact directly with the PCB

Direct plug-in connectors in the ZEC 1, ZEC 1,5, and ZEC LPV product ranges make contact directly on the PCB without the need for additional pin strips. The plug-in connectors are simply inserted in the contact pads located on the edge of the 1.6 mm thick PCB. The pads have been integrated into the top and bottom of the PCB in the layout.

Direct plug-in connectors have a modular design. The plug-in connectors are therefore coded by adding corresponding segments with a fixed side panel at any position. A slot is created in the PCB according to this position. This reliably prevents mismatching and polarity reversal of the plug.

Two spring-loaded engagement catches lock the plug-in connectors in place on the PCB. The interlocks engage in the correspondingly positioned holes on the PCB. Direct plug-in connectors are divided into two types:

Conductor/PCB connection

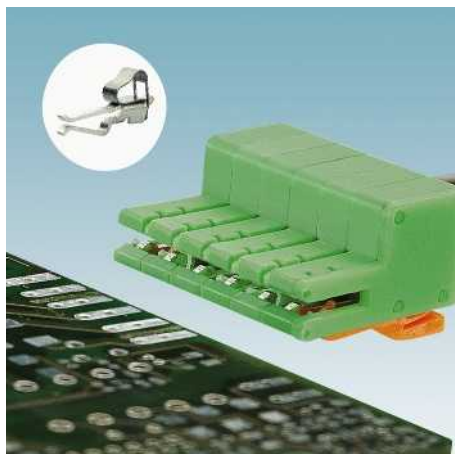

The plug-in connectors in this product range are available with 3.5 mm, 5 mm, and 7.5 mm pitch (see page 365) for nominal voltages up to 400 V. Currents of up to 10 A can be transmitted via the solid contact springs.

The conductor connection uses spring-cage technology and is operated from the front by means of a screwdriver. The clamping space supports solid and stranded conductors up to 1.5 mm² (1 mm² with 3.5 mm pitch) with or without ferrules. The plugs are marked using SK 3,5/2,8, SK 5/3,8, and SK 7,5/3,8 self-adhesive marker cards (see page 796).

PCB/PCB connection

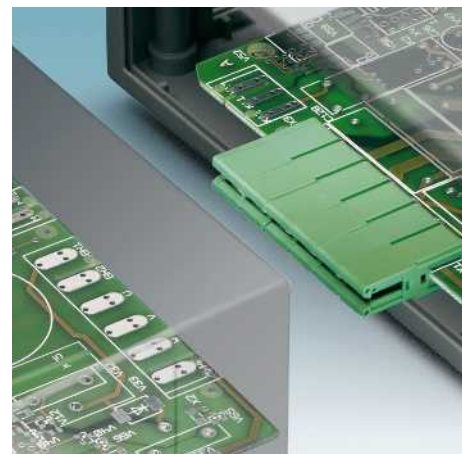

These plug-in connectors enable the direct connection of two PCBs. For example, if you want to connect a motor filter to a frequency converter, you just insert it. The external connection - the ZEC direct plug - then changes over to the add-on device. The device housing design must ensure that mechanical forces are absorbed.

Like the conductor/PCB connectors, PCB/PCB connectors are also available with 3.5 mm, 5 mm, and 7.5 mm pitch (see page 365) for nominal voltages up to 400 V and for currents up to 10 A. A modular housing structure combined with direct plug-in technology provides maximum flexibility.

Mounting types

Wave soldering

Wave soldering is the traditional mounting method for all push-through components on the PCB.

The method is described in detail in standards; for lead-free processes, the process requirements have since been redefined.

The user therefore has the task of harmonizing their process with the varied requirements of the respective assembly and bringing it in line with standards.

Standards

The qualification profiles described in the standards refer to limit profiles. These limit profiles are used to qualify the component; the requirements specified here are therefore always more demanding than the real conditions experienced in practice. PCB connection elements must usually be processed in accordance with: DIN EN 61760-1: surface mounting technology

Standard method for the specification of surface mounting components (SMDs)
International version:
IEC 61760-1: SURFACE MOUNTING TECHNOLOGY

Standard method for the specification of surface mounting components (SMDs)

According to the profile, the maximum load on a solder pin is 260°C for 10 s in a double wave arrangement, however, it does not go into further detail regarding the geometrical conditions of the assembly. The heat input on the test object at a bath temperature of 260°C and 10 s depends on various factors, such as the thickness of the PCB, the number of layers, and the Cu content of the layers.

The area of application of the standards relates to SMD components; “push-through components” can therefore only be specified in accordance with these standards. However, the main advantage of these standards is that an adequate description of a wave soldering profile is provided, as used in standard modern soldering machines. This can also be used as a basis. In addition, PCB connection components must be soldered to SMD components, so that compliance with the requirements can be transferred.

Practical implementation and recommendations

In practice, one would always try to solder at the lower limit of thermal loads. Solder bath temperatures are usually set to 265°C, however, for 95% of applications the maximum contact temperature and solder time are far below the values specified in the maximum profile above.

Below are two recommendations for practical profiles, which are used to qualify PCB connection elements from Phoenix Contact:

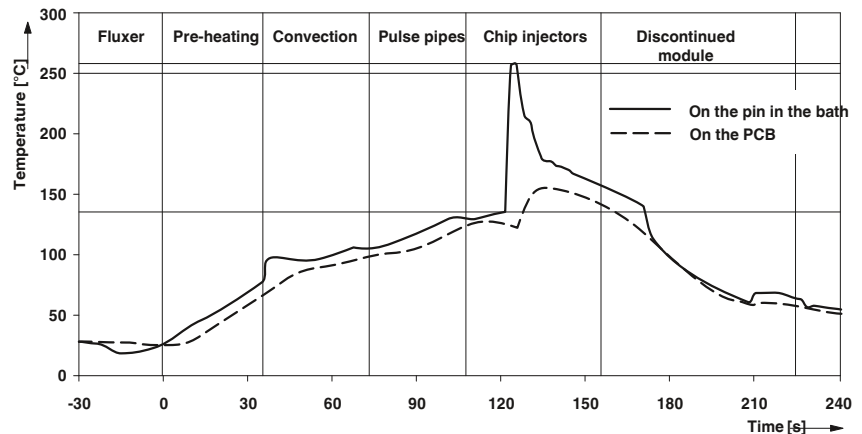

This profile is limited to a laminar wave at temperatures > 250°C for 3 seconds.

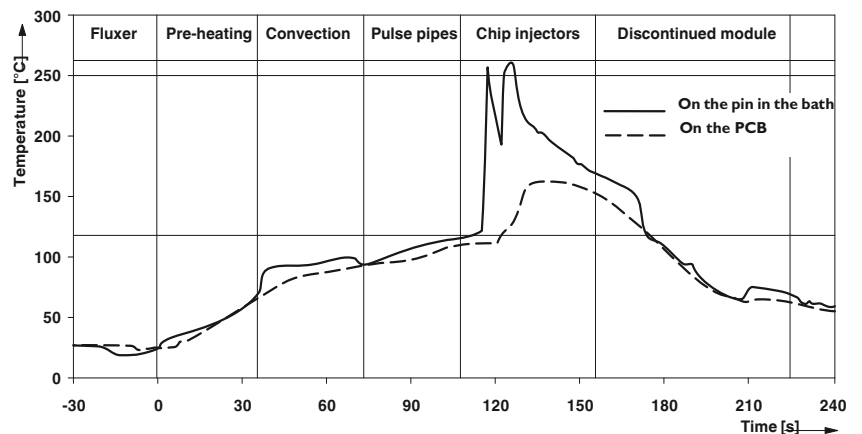

For this double wave, the maximum loads for both waves are > 250°C for 5 seconds in total.

The processability of lead-free wave-solderable components can be confirmed in accordance with the latest versions of standards DIN EN 61760-1 and IEC 61760-1. According to the profile, maximum soldering temperatures of

260°C for a maximum of 10 seconds apply. In exceptional cases, restricted temperatures and soldering times apply in the maximum peak range.

Through hole reflow soldering

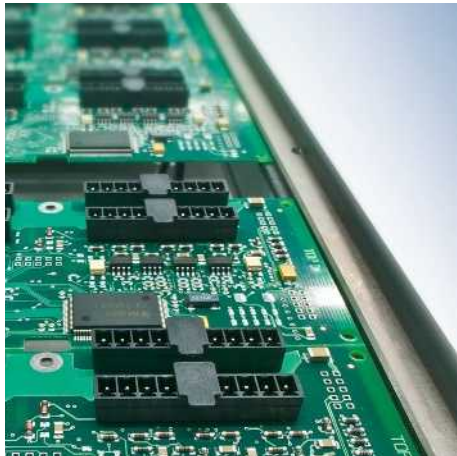

The trend toward SMD components (surface mount devices) has continued in recent years.

Thanks to the use of cost-effective, fully automated processes with regard to solder paste printing, mounting components, and soldering, production on SMT lines represents a cost-effective and fast production process. This has directly resulted in a growing desire to integrate as many of the remaining wired components as possible into this production process.

This trend-setting technology is known as through hole reflow (THR) technology and describes a method for mounting wired components on the PCB. It involves the through hole mounting of components within the mounting process in conjunction with the reflow soldering process. This is a technology developed for fully automated processes in SMT production.

The aim of this technology is to integrate through hole components into the SMT process. Both SMD and THR components should be processed using the same process equipment, the same method, under the same conditions.

The “pin-in-paste” method

The “pin-in-paste” method takes the typical steps of an SMT production process and applies them to a PCB with through-contacted holes. The functional principle of this procedure is now considered an acknowledged method. With the right component geometry, soldering material, and process parameters the results that can be achieved are very favorable.

Basic method of operation: sequence of the “pin-in-paste” method.

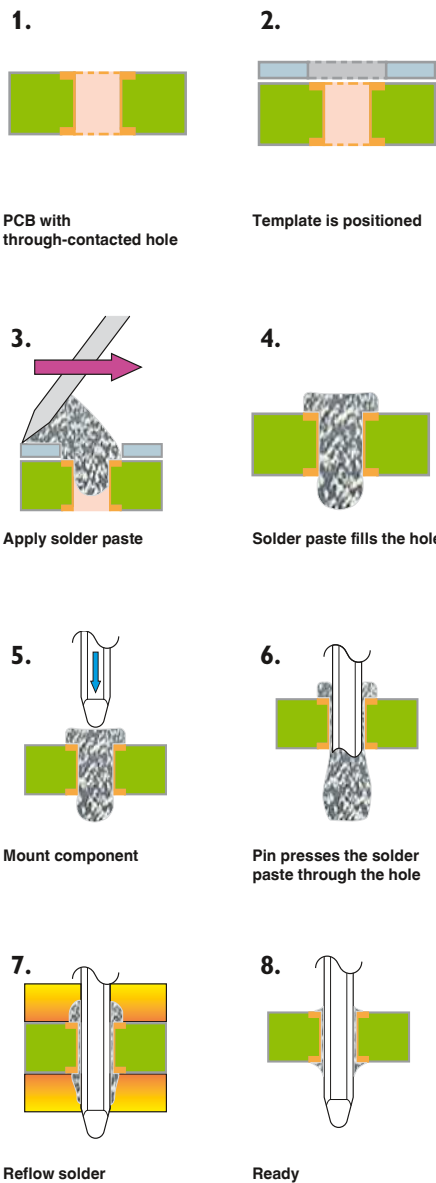

Requirements for THR components

The integration of THR components in the SMT process requires the appropriate selection of materials (plastics as well as metal parts/surfaces) as well as adaptation of the geometry (e.g., suction surfaces, clearance around the soldering spot). In addition, machine-capable packaging (tape/tray) is required. The key requirements are described below:

It should be possible for THR components to be picked up by the mounting head of a machine without the use of any special grippers or special pipettes.



Component on the mounting head

Smooth and even suction areas are required for this. If these are not present or are too small, the component must be fitted with special pick-and-place pads.

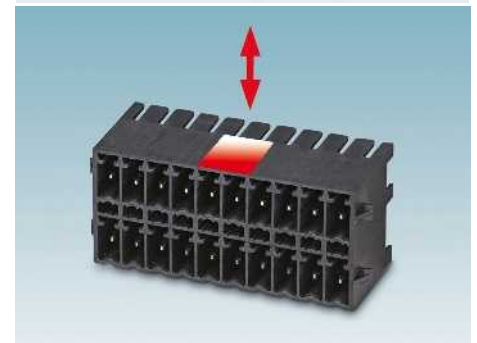
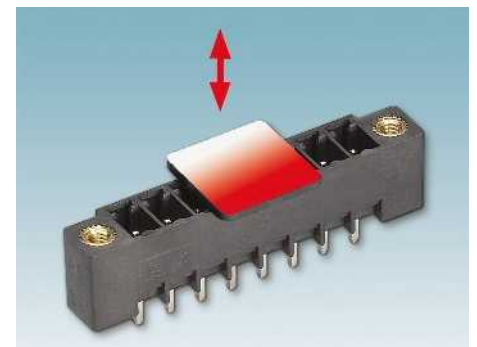

Suction areas

Mounting types

Requirements for THR components

THR components must have sufficient clearance around the solder pins on the bottom of the component. In addition, stand-offs must be used.







These ensure that contact is prevented in the soldering process with the solder paste prior to soldering as well as between the solder meniscus and housing parts. In addition, the heat supply is not impeded during soldering.



Clearance around pins

The soldering method and the type of soldering process should also be taken into consideration when selecting the right solder pin lengths. In general, shorter pins are recommended in lead-free processes and especially in the vapor phase process due to the significant change in solder paste parameters. Paste loss is thereby prevented.

This means that pins that protrude only slightly from the base of the PCB must be used. Alternatively, very short pins should be used that no longer fully penetrate the PCB.

Pin length (standards)	THR convection/ THR vapor phase
1.4 mm	 <p>Optimum soldering. No projecting pin on 1.6 mm PCBs. Limited inspection.</p> 
2.0 mm	 <p>Optimum soldering. 0.4 mm projecting pin on 1.6 mm PCB.</p> 
2.6 mm	 <p>Optimum soldering. 1 mm projecting pin on 1.6 mm PCB.</p> 

Qualification of THR components according to J-STD-020

The focus of qualification standard IPC/JEDEC J-STD-020 (Moisture/Reflow Sensitivity Classification for Non-Hermetic Solid State Surface Mount Devices) is the basic moisture absorption in plastics, which under the influence of the temperature of the reflow process can ultimately destroy the component through blistering, delamination or deformation.

Levels are defined which determine the type of packaging (e.g., dry bag) and processing in atmospheres typical for SMT processes depending on the component geometry and indirectly on the plastic selected.

The aim of this testing is to determine a moisture sensitive level (MSL) for each component, which is linked to corresponding specifications for processing in the SMT process.

For lead-free reflow solderable components, Phoenix Contact confirms processability in accordance with IPC/JEDEC J-STD 020 with specification of the relevant moisture sensitive levels for the product range.



Components in standard bag - MSL 1



Components in dry bag - MSL 3

PCB layout

The use of THR technology requires modifications to the PCB layout. Choosing the right hole diameter ensures the return flow of the solder in the reflow process and that machine mounting is supported. If a suitable hole size is used, production tolerances are compensated and reliable mounting is possible.

As a rule of thumb, the following applies when determining a suitable hole diameter:

$$d_i = d + 0.3 \text{ mm}$$

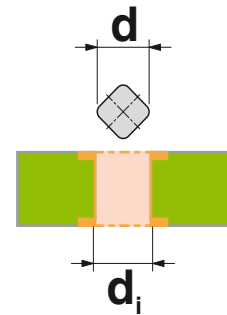

d = Diagonal of the square pin used
 d_i = Inside diameter of hole

With regard to dimensioning the residual ring, the same requirements as for wave-soldered pads largely apply. Taking into consideration the air and creepage distances and the clearance below the component around the pin, the ring width should be between 0.2 and 0.5 mm. The potentially larger volume of paste on wider rings can have a positive effect on the soldering quality (meniscus formation).

Solder paste printing

In the printing process, the solder paste is applied simultaneously for SMD components (surface mounting) and THR components (through hole mounting) to the pads/residual rings using a template. Templates with a thickness of 100 - 150 µm are currently used. The cutout in the template is usually calculated according to the following diagram:

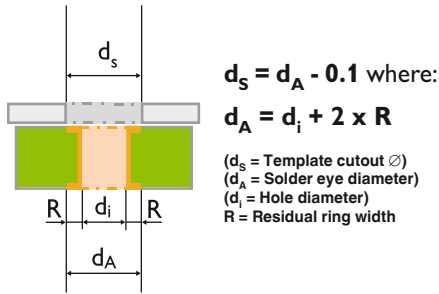

The overprinting of solder paste on the solder resist is thereby avoided.

Under ideal conditions, paste printing yields the following results:

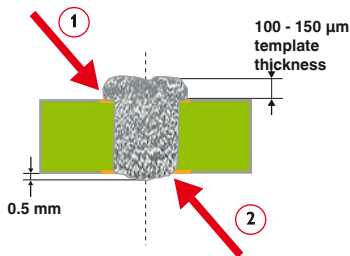

No overprinting required (1)
 The solder paste is intentionally pushed through by up to 0.5 mm below the PCB (2)

Solder paste printing determines the appearance and quality of the soldering spot. When conditions are not ideal, there are various ways of controlling the quantity of solder paste:

- Spreader angle and spreader speed control the filling degree and amount of solder pushed through
- The paste volume can be increased by means of overprint over the residual ring
- Ridges in the template holes reduce the filling degree and amount of solder pushed through

Mounting

There are significant cost advantages associated with integrating THR components in automated mounting with reflow processes.

However, due to their size and weight, THR components can usually only be mounted using pick and place machines. On the one hand this reduces mounting speeds (no loss of components) and on the other hand, a height of 25 - 40 mm is required for mounting components. Components are therefore picked up using standard vacuum pipettes.

The component is picked up at defined positions, it is then measured via the camera, and then placed on the PCB.



Component picked from the tape



Camera recording for component measurement

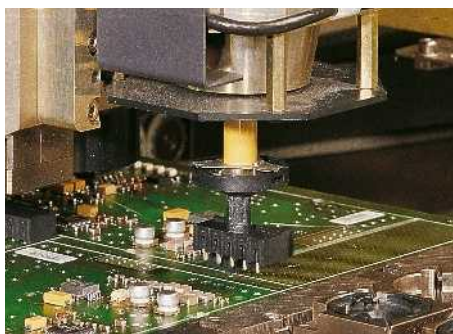

Component placed on the PCB

Mounting

Tape-on-reel packing is the most common way of supplying SMT and THR components.

For THR components, reels with the usual standard widths of 24/32/44/56/72 and 88 mm are used. Due to the component size, especially in the case of tall components, it must be ensured that the radius of the feeder is sufficient and there is enough space for input and output of the tape in the machine.



Tape-on-reel packing

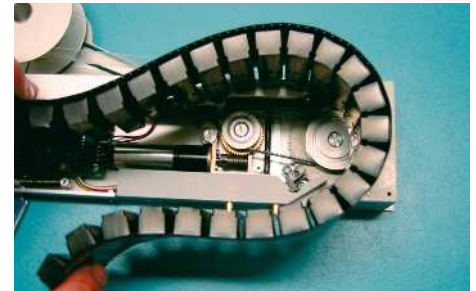

Component too large for feeder system



Special type of pin strip in a tube



High-volume THR component in a tray

Mounting types

Reflow soldering process

After mounting the components, the solder in the form of a paste drop (matchstick head) is ready at the pin tip below the hole.



In the subsequent soldering process, the paste melts when the liquid temperature is reached and passes through the hole along the pin flank with the help of the capillary effect. In the subsequent cooling phase, part of the solder sinks below once again and forms the characteristic solder globule.

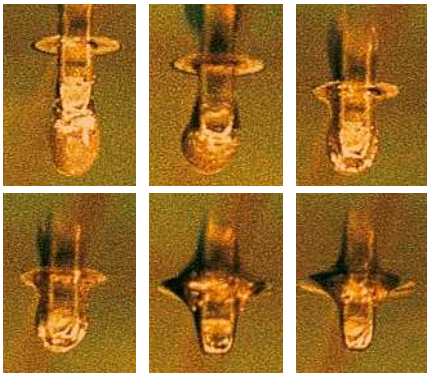

Modern SMD production mainly uses convection ovens with modern heat management with adjustable heating from above and below.

With regard to the THR technology, there are just a few model-specific limitations.

As a result vapor phase soldering ovens have been further developed in recent years. With its higher production bandwidth, this oven technology is gaining importance, thanks to its “inline” production. One particular point should be noted when using THR components: the condensate that settles on the paste drop can make it run. This can be counteracted by selecting a shorter solder pin length.

Standards and soldering profile

DIN EN 61760-3 applies for THR components. The reflow process is also described with temperature profiles according to standard DIN EN 61760-1 or also according to IEC 60058-2-58.

Standard IPC/JEDEC J-STD 20, previously described in the context of qualification, also contains corresponding profiles, which can be used as the basis for the relevant process profile.

Since the heat management of each individual board depends on a large number of factors (e.g., size and thickness of the board, component size, etc.), a direct profile cannot be specified for the use of THR components. Therefore recommendations can only be made based on the above standard profiles.

In practice, one would always try to solder at the lower limit of thermal loads. For widely used SnAgCu soldering alloys, common peak temperatures are between 235°C and 240°C.

Below is a recommended practical profile (component upper side):

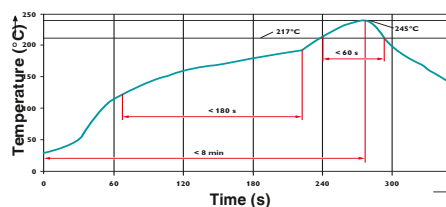

Lead-free reflow soldering profile (SnAgCu)

For lead-free reflow solderable components, Phoenix Contact confirms processability in accordance with IPC/JEDEC J-STD 020 with specification of the relevant moisture sensitive levels for the product range. In some cases, reduced maximum permissible “peak body temperature” is specified.

Inspection

Standard IPC-A-610 can be used for the inspection of THR soldering spots. The above parameters allow implementation of Class 3 soldering spots - products for maximum reliability. Through-contacting fill as well as the wetting of the solder globule surrounding are assessed:

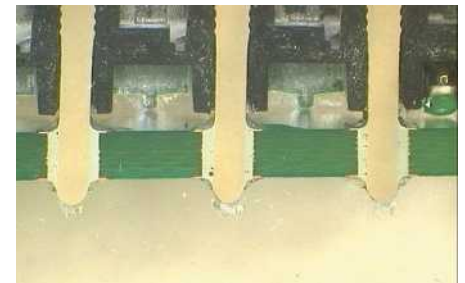

Filling degree of at least 75% achieved. Small solder globules form on both sides.

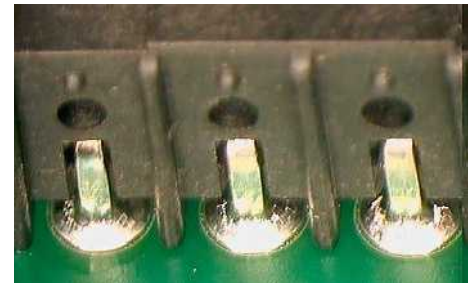

Wetting of surrounding (at least 75%) on solder destination and solder source side both 360° or 100% (typical for THR process).

THR soldering spots have a shape that is very similar to that of soldering spots created during wave or selective soldering. The main difference is the shape of the solder globule. Since less solder is available for the process, the solder globules that are formed are smaller or not fully developed.

This special appearance must be discussed with the Quality Assurance department or taken into account when using automatic inspection systems (AOI).

COMBICON press-in technology

Solder-free PCB connection

This mounting type, which does not involve soldering, is characterized by low press-in and high holding forces. It is used in applications where PCBs must not be subjected to thermal loads or where ready-soldered SMD components are not permitted on the PCB. The elastic press-in zone ensures reliable contacting and low contact resistance.

Headers in the EMC and EMSTB product ranges are equipped with the ERNIPRESS press-in technology contact system. They are suitable for PCBs with a thickness of 1.5 mm or more and meet the applicable requirements of standard DIN EN 60352-5: 1995-9. According to this standard, a special through-contacted hole is required, whose structure depends on the design type used (see pages 222 and 310).

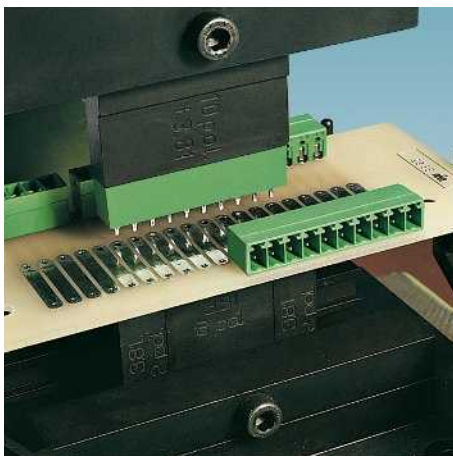

In the simplest case, the press-in method is implemented using a toggle press; pneumatic presses are used for automated mounting methods. The horizontal headers can be pressed into the PCB using a flat press-in stamp. Contact-supporting tools are not required. Contact-supporting lower stamps are available for vertical headers. Stamp sets consisting of an upper and lower stamp are available on request.

The high quality and reliability of press-in plug-in connectors are complemented by their easy handling and user-friendly repair (just press out).

Structure of the metal-plated hole for EMC 1,5/...-G(F)-..., EMCV 1,5/...-G(F)-...

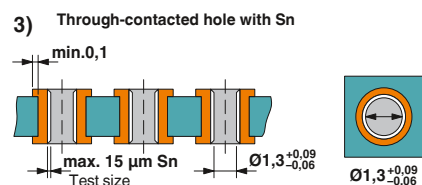
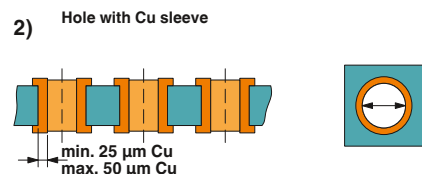
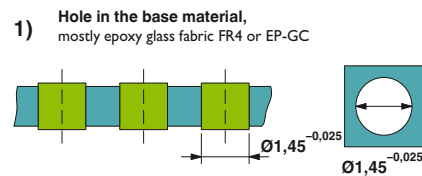

Structure of the metal-plated hole for EMSTB(A) 2,5/...-G(F)-... and EMSTBV(A) 2,5/...-G(F)-...

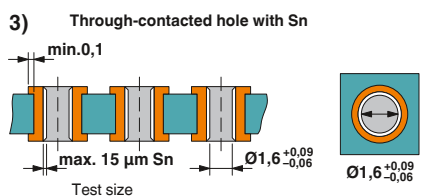
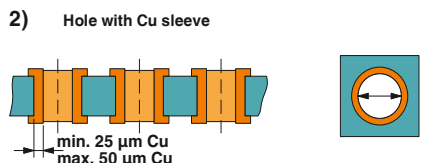
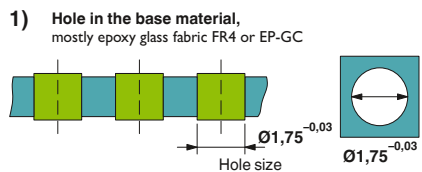

COMBICON TWIN plugs

Double conductor connection

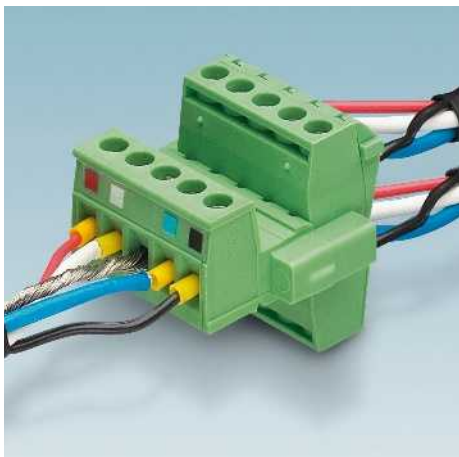

TWIN plug-in connector types are characterized by the connection of two conductors on one connection terminal. Depending on the size, TWIN plugs are used to loop through the signals or to distribute potential or power. A key feature is that the function of the subsequent devices is retained when removing individual plugs in a device series.

PTDA 1,5 TWIN plugs with spring connection, 3.5 or 5.0 mm pitch

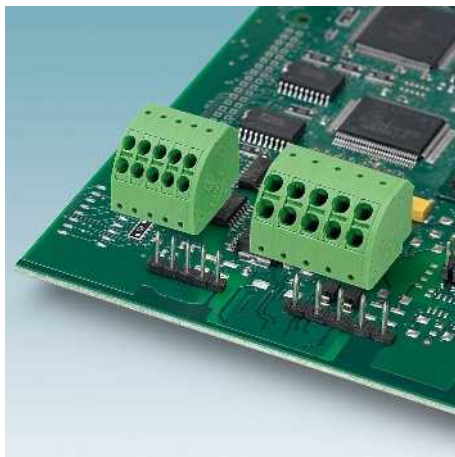

- With push-in spring connection
- Symmetrical, rounded design
- 45° angled connection direction
- Contacting on pin strips with 1 mm Ø or 1.3 mm Ø pins
- Conductor cross section: up to 1.5 or 2.5 mm²
- Rated current: 8 or 13.5 A
- Rated voltage: 240 or 400 V
- Open the clamping space via the release button using a screwdriver

TVFKC 1,5 TWIN plugs with spring connection, 5.0 mm pitch

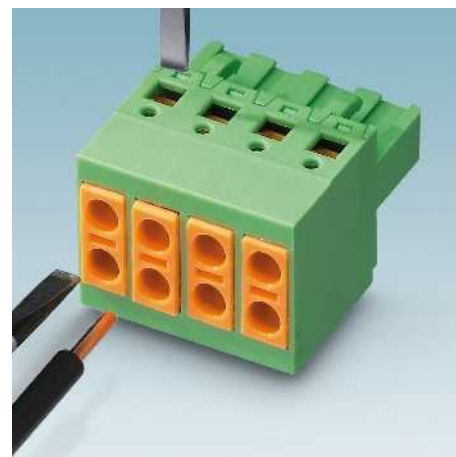

- With push-in spring connection
- Front conductor connection
- Conductor cross section: up to 1.5 mm²
- Rated current: 10 A
- Rated voltage: 320 V
- Low design height of just 15 mm
- Open the clamping space via the orange release button or the actuation shaft on the side using a screwdriver

FK-MPT 0,5 TWIN plugs with spring connection, 3.5 mm pitch

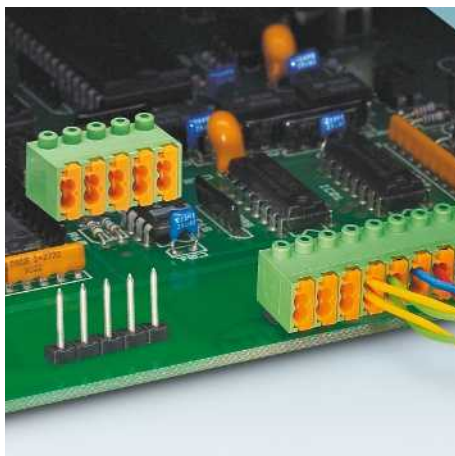

- With push-in spring connection
- Front conductor connection
- Contacting on pin strips with 1 mm Ø pins
- For solid conductors
- Conductor cross section: up to 0.5 mm²
- Rated current: 4 A
- Rated voltage: 250 V
- Open the clamping space via the orange release button using a screwdriver

TFMC 1,5 TWIN plugs with spring connection, 3.5 mm pitch

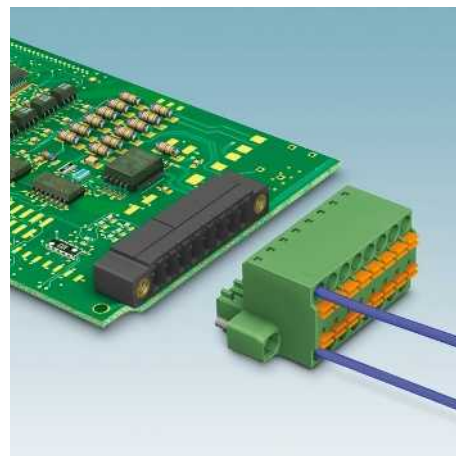

- With push-in spring connection
- Front conductor connection
- Conductor cross section: up to 1.5 mm²
- Rated current: 8 A
- Rated voltage: 160 V
- With touch connection for voltage testing using a 1 mm Ø test pin
- Open the clamping space via the orange spring lever using a screwdriver

QC 1-BUS TWIN plugs with displacement connection, 5.0 mm pitch



- With displacement connection
- No conductor pretreatment required
- Conductor cross section: up to 1 mm²
- Rated current: 10 A
- Rated voltage: 630 V
- Conductor connection: insert insulated conductor in the orange slide and press down using a screwdriver
- The conductor can also be released using a screwdriver

TVMSTB 2,5 TWIN plugs with screw connection, 5.08 mm pitch

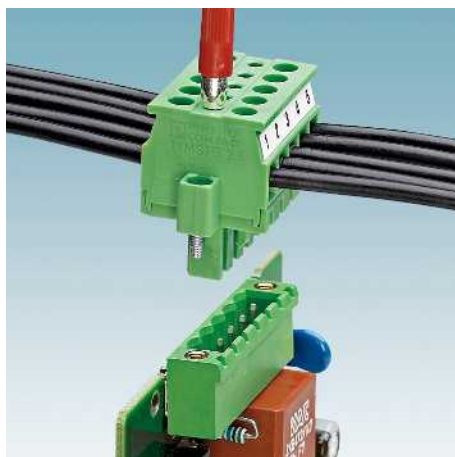

- With screw connection
- Conductor connection perpendicular to the plug-in direction
- Conductor cross section: up to 2.5 mm²
- Rated current: 12 A
- Rated voltage: 400 V
- With test connection for 2.3 mm Ø test plugs

TPC 16 TWIN plugs with screw connection, 10.16 mm pitch

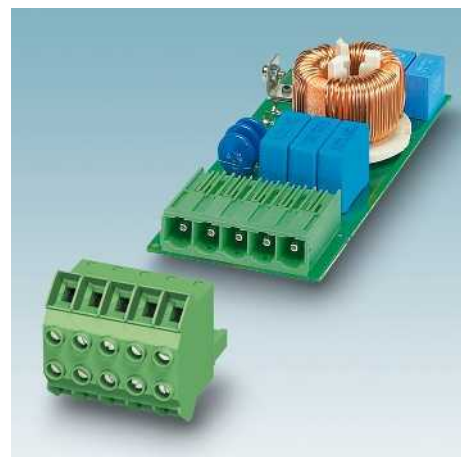

- With screw connection
- Compact design height of just 51.4 mm
- Conductor cross section: up to 16 mm²
- Rated current: 76 A
- Rated voltage: 1000 V

TFKC 2,5 TWIN plugs with spring connection, 5.08 mm pitch

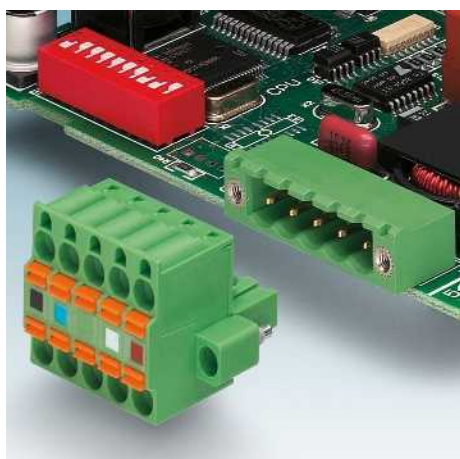

- With push-in spring-cage connection
- Conductor cross section: up to 2.5 mm²
- Rated current: 12 A
- Rated voltage: 320 V
- With test connection for 2.3 mm Ø test plugs
- Version for DeviceNet™ with gold-plated contact system
- Marker strips available for DeviceNet™ color coding
- Open the clamping space via the orange spring lever using a screwdriver

TMSTBP 2,5 TWIN plugs with screw connection, 5.08 mm pitch



- With screw connection
- Conductor connection parallel to the plug-in direction
- Conductor cross section: up to 2.5 mm²
- Rated current: 12 A
- Rated voltage: 320 V
- With test connection for 2.3 mm Ø test plugs
- Version for DeviceNet™ with gold-plated contact system
- Marker strips available for DeviceNet™ color coding

TSPC 5 TWIN plugs with spring connection, 7.62 mm pitch



- With push-in spring connection
- Front conductor connection
- Conductor cross section: up to 6 mm²
- Rated current: 41 A
- Rated voltage: 1000 V
- Open the clamping space via the actuation shaft using a screwdriver

Inverted contact systems

Numerous possible combinations

Inverted plug-in connector systems are mainly used wherever shock protection is required for the plug-in connector on the PCB. Compared to the standard system, a feature of inverted contact systems is the swapped position of the socket and pin contacts. The IMC 1,5, IC 2,5, and FKIC 2,5 as well as the GIC 2,5, IPC 5, and IPC 16 inverted plug-in connector ranges combine screw or spring-cage connection in the plug with socket contacts that can be soldered in the corresponding headers.

- IMC 1,5 plug-in connectors: 160 V
- IC 2,5 or FKIC 2,5 plug-in connectors: 250 V
- GIC 2,5 plug-in connectors: 400 V
- IPC 5 plug-in connectors: 1000 V
- IPC 16 plug-in connectors: 1000 V

Combination with the corresponding counterparts of the MC/FK-MCP 1,5 or MSTB 2,5/FKC 2,5 or GMSTB 2,5/GFKC 2,5 or PC 5/IPC 5, PC 16/IPC 16 plug-in systems offers a wide range of possible applications. The IC plug is used as an example in the following combinations. The FKIC spring connection version can be used as an alternative. Similar combinations are possible for IMC, GIC, and IPC plug-in connectors.

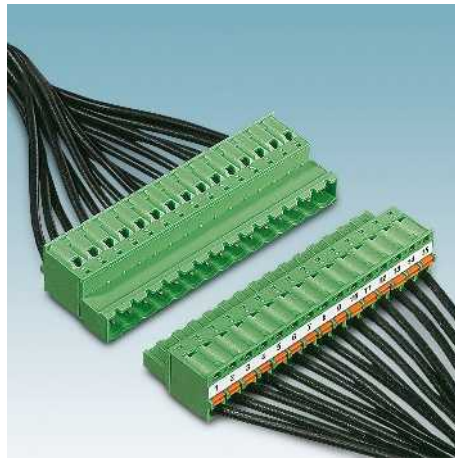

2. Two plugs as free-hanging connection.

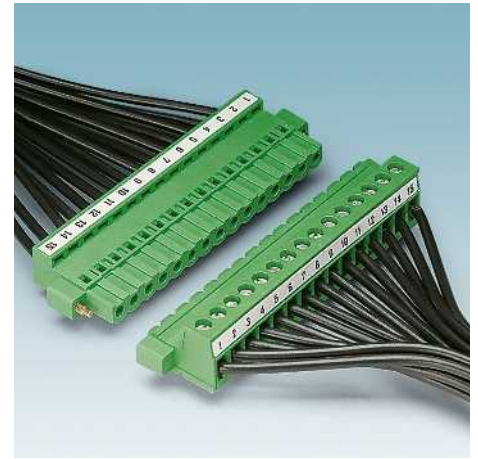

5. IC 2,5/... STGF with threaded flange for vibration-resistant free-hanging connection with MSTB plugs with screw flange.

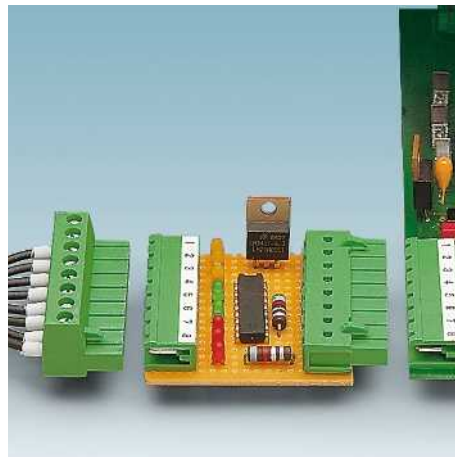

3. IC 2,5 versions and MSTB 2,5 headers to create test, indicator, convertor or branch adapters.

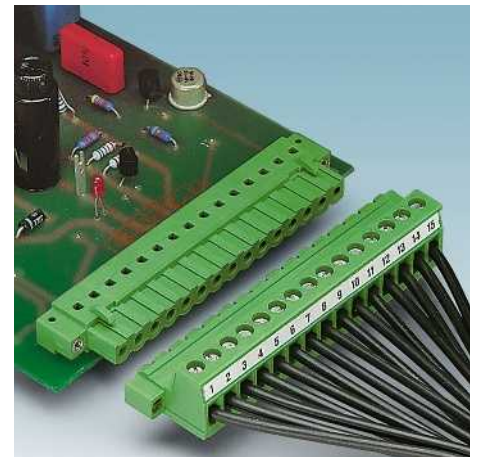

6. IC 2,5/... STF with screw flange for vibration-resistant connection with IC 2,5/... GF inverted headers.

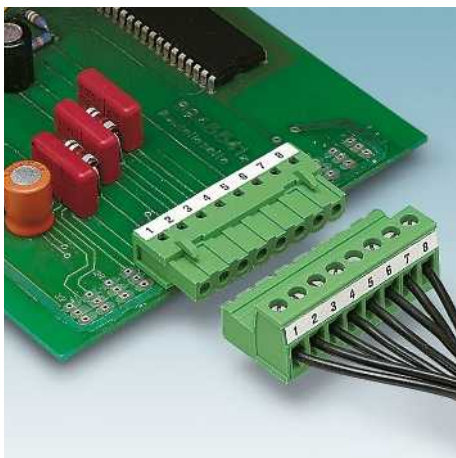

1. IC 2,5 plug and IC 2,5 header as shock-proof PCB output.



4. ICV 2,5 versions and MSTB 2,5 headers to create primary/secondary PCB connections. Here, FLRP lateral guide rails are used to stabilize the secondary PCB.

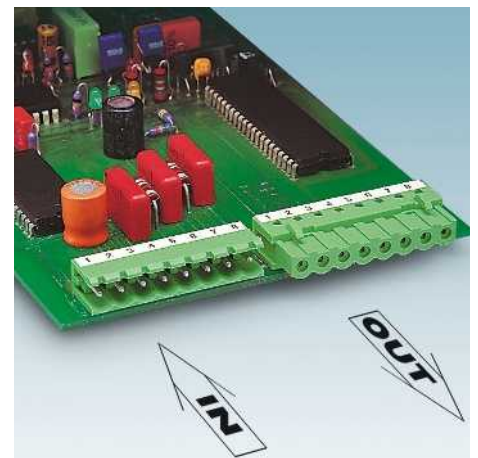

7. MSTB 2,5 and IC(V) 2,5 headers for the clear separation of inputs and (shock-proof) outputs.

Insertion and withdrawal forces

The insertion and withdrawal forces of a plug-in connector vary from 4 N to 8 N per position depending on the contact system and contact surface. In most applications, these insertion forces predominate over the pull-out forces. As far as the requirements are concerned, the pull-out forces defined by the weight of the connecting conductor and the plug-in connector itself can be too low for plug-in connectors with a small number of positions. It is recommended that plug versions with mounting flange for the header are used to prevent the connection being released too easily. The installation scenario often plays an important role here: the use of plug versions that support connection to the header is recommended if relatively long, non-supported connecting cables are used or when the device is used under harsh operating conditions and in the event of vibration.

STF/GF screw flange



As standard, the plugs are fixed to headers using screw locking. These versions (plugs with the designation -STF, headers with the designation -GF) are standard in all performance categories. Here, the screw is located in the plug and the corresponding thread in the base strip.

Threaded flange

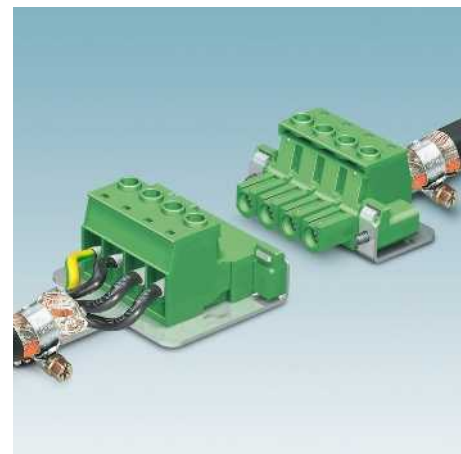

A screw flange version consisting of all inverted plugs is also available. In this case, the flange has a thread instead of a screw. Two plugs of a cable/cable connection can therefore be screwed against one another. This prevents accidental release of the connection.

RF/RN self-locking flange

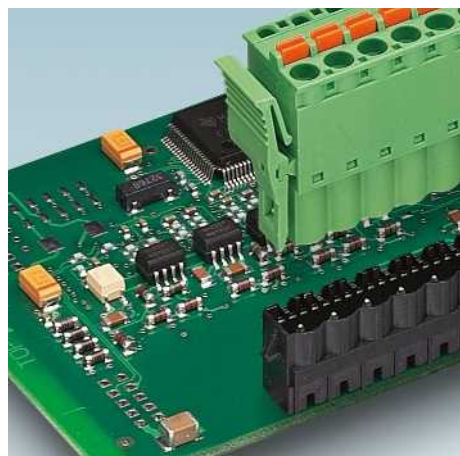

Applications that only require a vibration-resistant connection can use the self-locking flange instead of the screw flange. It locks automatically without having to use a tool. It is identified by RF (self-locking flange) in the plug designation and RN (engagement nose) in the designation for headers or inverted plugs.

Click and Lock

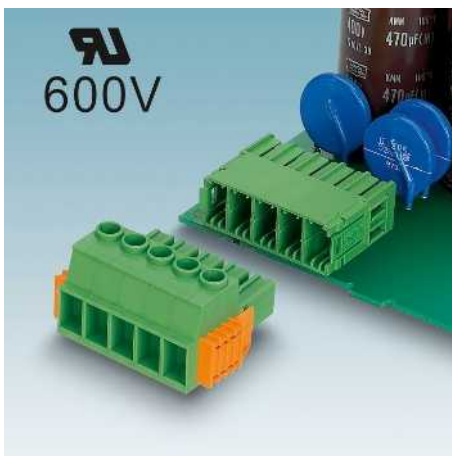

For the PC 5 range, the “Click and Lock” system is available as an alternative to the screw or threaded flange. This enables tool-free, automatic locking of the plug (-STCL) and base strip and of two plugs. This locking system is reliable even in the event of strong vibration and also saves more space than the screw locking flange.

Lock & Release



The “Lock & Release” mounting system combines a locking mechanism with a release mechanism. Both actuating levers on the plug lock when the plug is inserted in the header. Releasing the levers then automatically ejects the plug from the header.

Mounting flanges/test connections

Mounting flanges



Standard test plugs are used for pick-off, and can be ordered from the COMBICON range of accessories (see page 832).

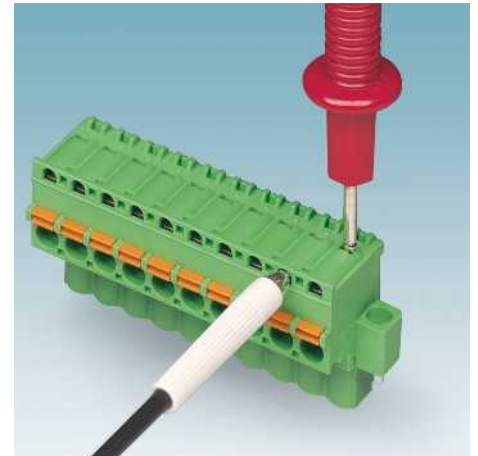

PCB terminal blocks for high currents in the range from 76 A to 125 A have mounting flanges which are used to connect the PCB terminal blocks to the PCB by means of a screw connection. It is also recommended that the conductors are supported.



Quick and easy testing using integrated test connections



Naturally, all standard measuring devices can be used for reliable testing.

The integrated test connection designed to accommodate a 2.3 mm Ø test plug enables you to test each individual contact point. Special test plugs are available for test connections smaller than 1 mm Ø.

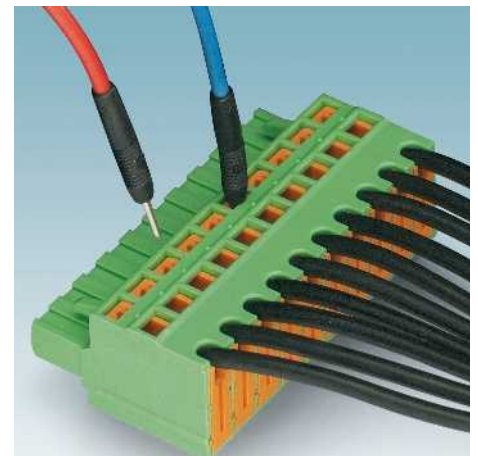

The COMBICON range from Phoenix Contact offers a variety of products with integrated test connections for service work and locating errors.

Measurements can therefore be taken easily without having to remove the wiring or other accessories.

Needless to say these test connections are also suitable for the continuous monitoring of process-relevant parameters.

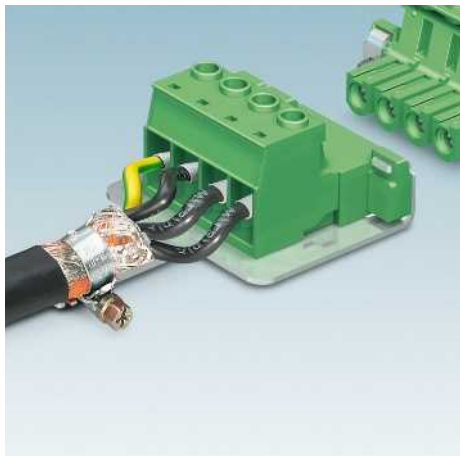

Strain relief

Strain relief elements have proven themselves, e.g., in high-position applications or applications with long cable outlets. Here, the mounting surface of the plug supports the connected cable effectively, thereby relieving the plug of the conductor pull-out force.

In the COMBICON control product range, additional versions are available with strain relief (e.g., the MSTB 2,5 range) or strain relief must be provided as an accessory by snapping it onto the standard plug (e.g., FKC 2,5 range). Strain relief is also available for the MC 1,5 range.

Shielding versions are available for the plugs in the COMBICON power product range. These too can also be used as cable strain relief. Four positions are available as standard, but any number of positions can be provided on request.

Strain can also be relieved using the cable housing for MC, MSTB, and PC 4 plugs. This also protects the plug from dust.

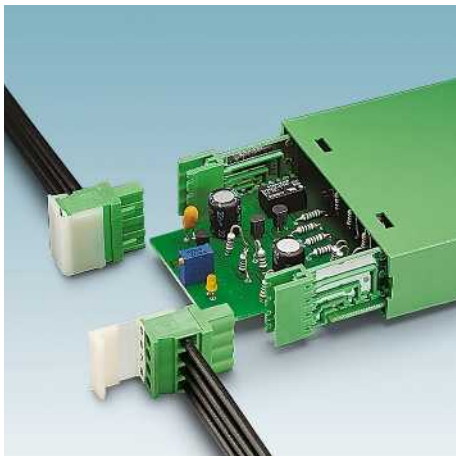

STE/GEH release aids

Versions with extraction aid (STE) are available for vertical MVSTBR/MVSTBW 2,5 plugs. The white accessory latch can be folded back after insertion and thereby additionally serves as shock protection for the screw.

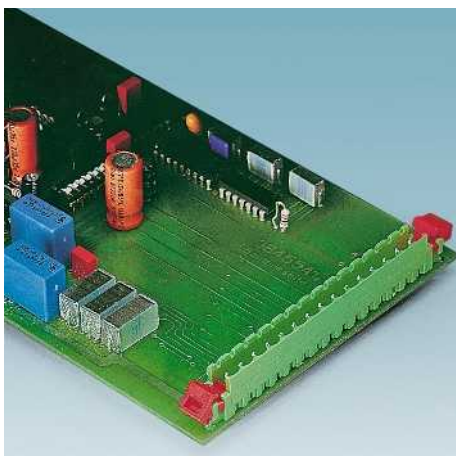

The release aid (GEH) is available as a special solution for vertical MSTBV 2,5 headers. An actuator can be used to easily release all plugs compatible with this base strip from the header.

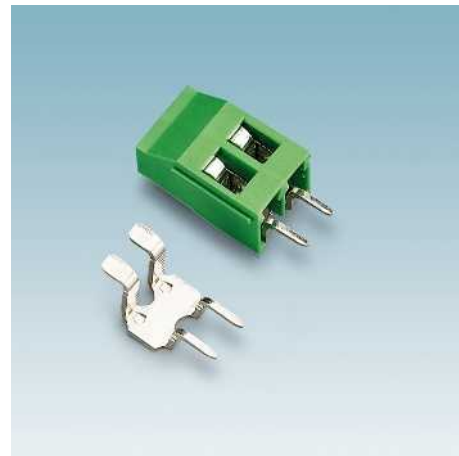

Bridges

Two methods are available for potential distribution or looping through the ground conductor in PCB terminal blocks. The easiest solution is a separate bridge fixed directly in the connection area, if necessary, with a supply conductor. Internally bridged versions are available in the standard MKDS product range. The entire clamping space is also available here.

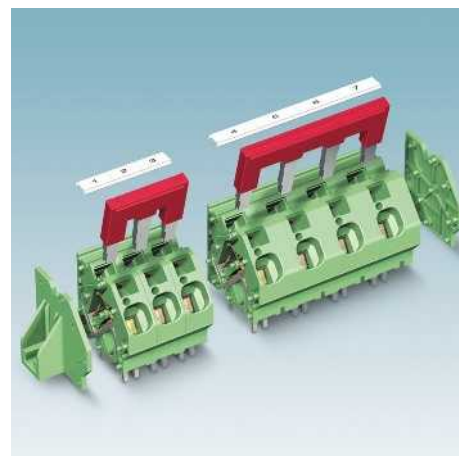

Fully insulated plug-in bridges are also available for ZFKDS 4 and ZFKDS 10 PCB terminal blocks. They enable individual electrical connection of the terminal blocks. The bridges, which are available with various numbers of positions, are inserted in the separate bridge shafts using minimal force.

Coding elements

Coding systems without loss of positions



Coding with CP-MSTB and CR-MSTB

Function: coding prevents the same type of plugs from being mixed up. To this end, the plugs are mounted with corresponding coding profiles (CP-MSTB) and the headers with corresponding coding sections (CR-MSTB). If the coding section and the coding profile are mounted on the same position, the plug cannot be plugged in. The image shows coding that can be plugged in.

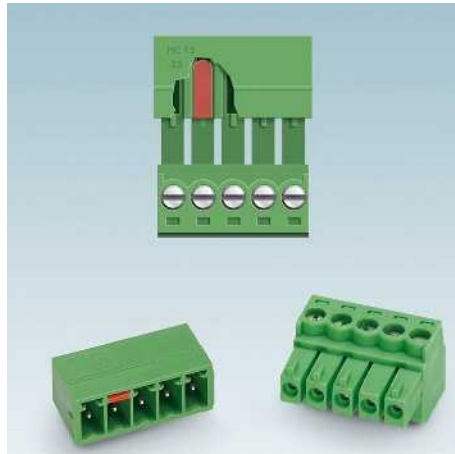

Coding with CP-MC 0,5 or CP-MSTB

Function: headers in the MC 0,5 and MC 1,5 product ranges are mounted with coding profiles (CP-MC 0,5 or CP-MSTB). The corresponding coding tabs are then cut on the plug side. If the coding profile is mounted on the same position where the coding tab has been cut, the combination can be plugged in (see image).



Coding with CP-PC RD or CP-HC

Function: headers and plugs in product series PC 4, PC 5, and PC 16 (CP-PC RD), and product series PC 35 (CP-HC) are mounted with coding profiles. Only correspondingly coded base strips and plugs can be plugged in. If the coding profile on the housing and on the plug are mounted on the same position, the plug cannot be plugged in. The image shows coding that can be plugged in.



Coding with CP-PT 2,5

Function: the plug is mounted with the CP-PT 2,5 coding profile irrespective of whether it is used vertically or horizontally. The coding ribs in the base strip then determine whether the plug can be plugged in. The corresponding positions of the coding ribs are formed during the manufacturing process. This ensures polarity protection among plugs of the same type. The combination shown in the image cannot be plugged in as the coding profile works against a coding rib in this case.

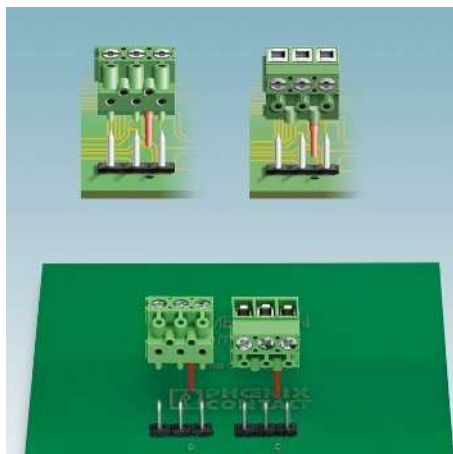

Coding with CP-PT 1,5

Function: the plug is mounted accordingly with the pin (CP-PT 1,5) depending on whether it is used horizontally or vertically. This pin then enters the hole provided in the layout of the PCB when plugged into the correct positions. Incorrect connection is therefore prevented.

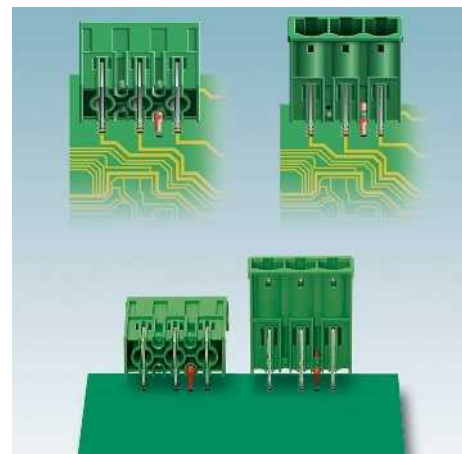

Coding with CS-IPC 16/6

Function: coding of PC 6-16 and IPC 16 headers before being mounted on the PCB. PC 6-16 and IPC 16 headers can be fitted with the CS-IPC 16/6 coding pin, whether used horizontally or vertically. The unused end of the coding pin can now be removed using a diagonal cutter. When mounting the PCB, the remaining part of the coding pin then enters the hole provided in the PCB. This provides anti-rotation protection on the PCB, particularly when mounting manually.

COMBICON Ex

COMBICON PCB terminal blocks and plug-in connectors for use in potentially explosive areas



If systems are installed in potentially explosive areas, a large number of safety precautions must be taken. The requirements placed on electrical equipment for use in areas with a danger of gas explosions are described in the IEC/EN 60079 series of standards.

Increased safety “Ex e”

The specific requirements placed on items of equipment with increased safety “Ex e” protection type are provided in Part 7 of the IEC 60079 series of standards. Compared to normal applications, these include stricter requirements for air and creepage distances, the heating response, resistance to aging, and the insulation capability of insulation materials.

The conformance of COMBICON Ex PCB terminal blocks and plug-in connectors with the requirements for increased safety is confirmed by EC-type examination certificates and markings for directives and standards. These documents and installation notes containing important information regarding the correct use of PCB terminal blocks and plug-in connectors in areas with increased safety can be found on the Internet at www.phoenixcontact.com.

General information:

For product-specific information, please refer to the installation notes.

- PCB terminal blocks and plug-in connectors are designed for installation in suitable housing. When used in environments containing potentially explosive gases or dust, this housing must meet the applicable requirements of IEC 60079-0, IEC 60079-3, and IEC 60079-7 or IEC 61241.

The PCB terminal blocks and plug-in connectors must be installed in a wiring space or housing so that they are secured against rotating or accidental loosening.

- For information on additional fixings, please refer to the installation notes.
- When connecting conductors, make sure that the wire insulation extends right up to the terminal point. Following installation of the PCB terminal blocks and plug-in connectors in a wiring space with increased safety “Ex e” protection type, the air and creepage distances must meet the requirements of IEC 60079-7. These requirements apply in particular to the mixed installation of different components and when using additional accessories.
- When using cross sections smaller than the rated cross section specified in the EC-type examination certificate, the corresponding lower current value must be specified in the EC-type examination certificate for the device.
- For some PCB terminal blocks, the specified voltage can be increased using pitch spacers. The voltages resulting from the use of one or more pitch spacers can be found in the EC-type examination certificate. We will be happy to confirm which other combinations are supported.

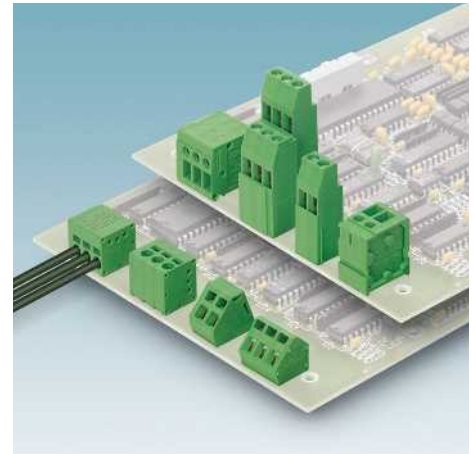

Intrinsic safety “Ex i”









For intrinsic safety “i” protection type according to IEC 60079-11, both PCB terminal blocks and plug-in connectors with Ex approval and standard products can be used. They are simply used as electrical equipment and do not require any particular certification or markings. Make sure that the air and creepage distances required in connection with intrinsically safe circuits are observed. The connection points of these circuits must be clearly marked. If marking is by means of color-coding, the connection points must be light blue.

Marking

The explosion-protected equipment must be marked in such a way as to guarantee that it is used correctly in accordance with its safety characteristics.

Note: in accordance with the specifications of the ATEX Directive, components such as PCB terminal blocks and plug-in connectors are excluded from CE marking.

Cross-reference list for CLASSIC COMBICON plug-in connectors with Ex approval

CLASSIC COMBICON plug	Type	CLASSIC COMBICON header	CLASSIC COMBICON header			
			MSTB[V]...GF EX Page 369	MSTB[V]A...G...RN EX Page 375	IC[V]...GF EX Page 377	GMSTB[V]...GF EX Page 375
	Pitch in mm		5.08	5.08	5.08	7.62
	MSTB...STF EX Page 369		•			
	MVSTB[R][W] Page 369		•			
	IC...STF EX Page 373				•	
	FKC...STF EX Page 371		•			
	FKC...ST...RF EX Page 371			•		
	FKIC...STF EX Page 373				•	
	GMSTB...STF EX Page 379					•
	GMVSTB[R][W]...STF EX Page 379					•
	GFKC...STF EX Page 381					•

Note:

The plug-in connectors only have approval for use in potentially explosive areas with increased safety Ex e in the combination shown here.

Technical information regarding the PCB connection

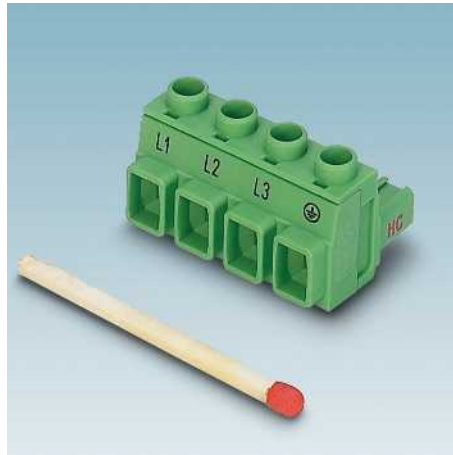

International approvals, such as UL/CUL consistently raise issues during device development. As a responsible manufacturer of device connection technology, we develop and test our products according to the latest safety standards in such a way that our customers do not encounter any problems with international approval for their devices.

COMBICON PCB terminal blocks and plug-in connectors are recognized components according to UL 1059. In the end application, these components undergo final evaluation and are approved together with the device according to UL 508 (C) or UL 840.

The stringent requirements of UL 1059 thereby ensure that a plug-in connector for 600 V UL in Use Group C observes a clearance of 9.5 mm and a creepage distance of 12.7 mm with a pitch of 7.62 mm. In the end application, these components undergo final evaluation and are approved together with the device according to UL 508 (C) or UL 840.

UL Online Certification Directory

Official recognition of the terminal blocks and plug-in connectors is confirmed by a UL report. This contains important information on the product, such as connection data (ratings), air and creepage distances, materials, dimensions, and application conditions (conditions of acceptability). Together with the product names, the connection data is documented in "yellow cards" or the UL Online Certification Directory as proof of approval. UL has published a website at www.ul.com/database where this data and corresponding explanations are generally available.

Phoenix Contact housing production is UL-certified

The plastics used in Phoenix Contact housing all have their own approvals. Our plastics production is recognized by Underwriters Laboratories as "UL Recognized Molder A1913" (File E240868) and is regularly audited.

The UL logo including ID and the plastic material code (e.g., P01) are also printed on the packing label of the electronics housing. Both during device approval and inspection of your electronics production, for the majority of product ranges it is very easy to verify the housing plastics' conformance with UL 746D using the material code on the label.

Product and device standards



UL 1059 “Terminal blocks”

In order that Phoenix Contact products can be used in industrial applications without restriction, they are generally tested and recognized according to UL 1059. The following table lists the air and creepage distances required for the components. The Use Group refers to the subsequent area of application of the termination device.

Device standards

UL 508 “Industrial control equipment”





Terminal blocks, which are recognized according to UL 1059, meet the requirements of UL 508 for field wiring terminal blocks and can therefore be used in accordance with this standard without restriction. UL 508 also permits alternative rating in accordance with UL 840.

UL 508 C “Power conversion equipment”

This UL standard applies specifically to power electronics (motor controllers, frequency inverters, etc.). The requirements for field wiring terminal blocks are similar to the specifications of UL 508. Alternative rating in accordance with UL 840 is also possible here.

UL 840 “Insulation coordination including clearances and creepage distances for electrical equipment”

This standard describes an alternative procedure for designing the insulation of end products for defined ambient conditions (surge voltage category, pollution degree, material index), provided that this is permitted by the device standard.

Use Group	Definition	Max. nominal voltage (V)	Required distances (mm)	
			Clearance	Creepage distance
A 	Operating elements, consoles, etc.	150	12.7	19.1
		300	19.1	31.8
		600	25.4	50.8
B 	Standard devices, including office and electronic data processing equipment, etc.	150	1.6	1.6
		300	2.4	2.4
		600	9.5	12.7
C 	Industrial applications, without restrictions	150	3.2	6.4
		300	6.4	9.5
		600	9.5	12.7
D 	Industrial applications, operating equipment with limited rating	300	1.6	3.2
		600	4.8	9.5

Alternative dimensioning of air and creepage distances according to UL 840

In accordance with UL 840 (3rd edition 2005), the following procedures are carried out to determine air and creepage distances:

1. Equivalent clearances

Not meeting the clearance required in the device standard is permitted if the termination device has passed one of the surge voltage tests described in UL 840 (Table 7.1) without sparkover. The amount of surge voltage depends on the clearance required in the product standard.

2. Clearances for limited surge voltages

If it is ensured that surge voltages occurring during operation do not exceed a specified maximum value, the required clearances for the known pollution degree can also be determined in accordance with Table 8.1.

3. Creepage distances

The minimum requirements described in Table 9.1 for general creepage distances and those specifically for PCBs must be met, taking into consideration the operating voltage, pollution degree, and creep resistance of the material.

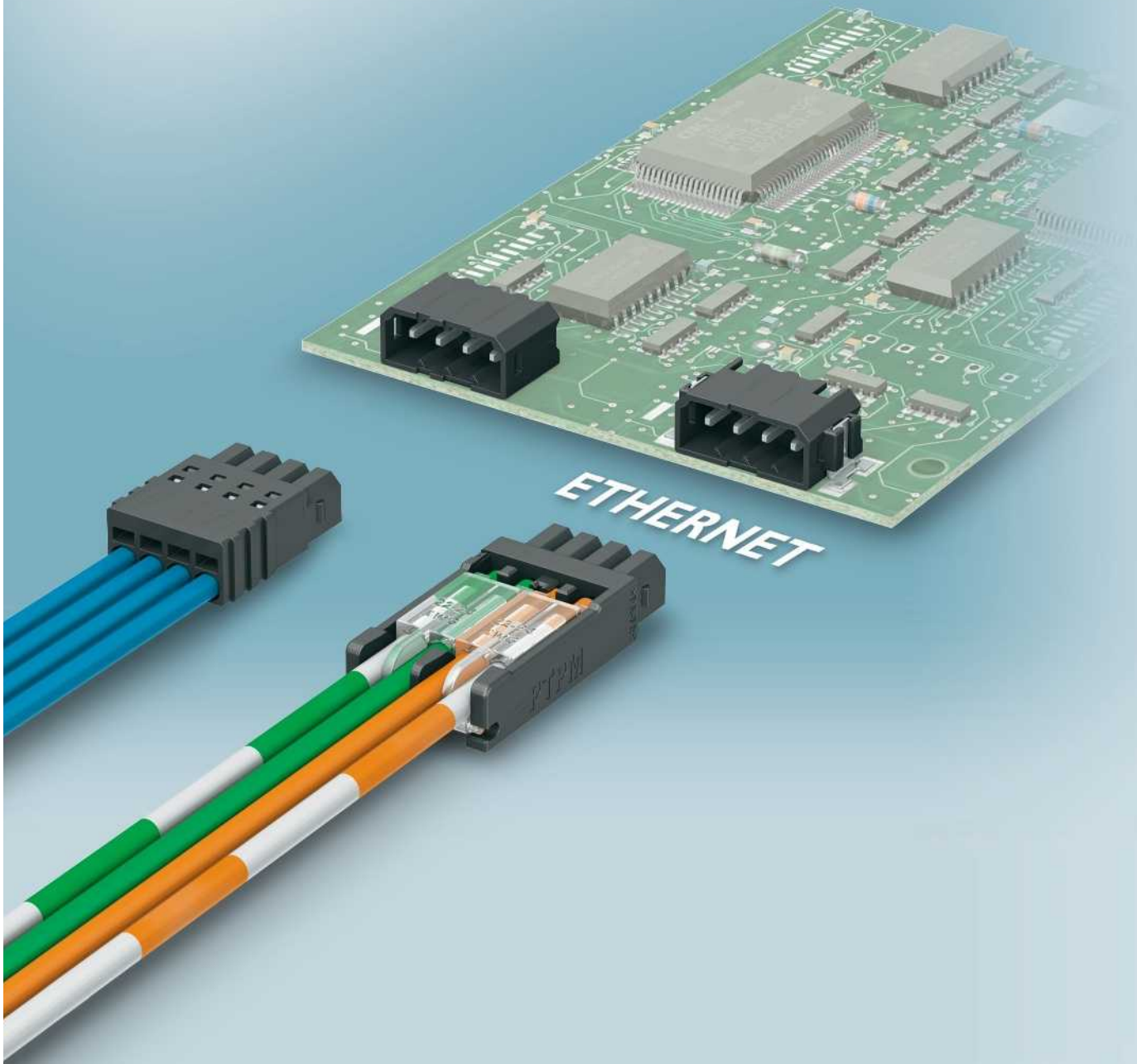

High density PCB terminal blocks and plug-in connectors

Electronic components are becoming increasingly compact and are mapping more and more functions. In order to follow this trend, PCB connection technology has to be adapted to the small size of other electronic components. These products, which are characterized by their extremely small size, are all available in the new COMBICON HD series.

COMBICON HD consists of PCB terminal blocks and plug-in connectors with 2.0, 2.5, and 2.54 mm pitch.

The PCB terminal blocks are designed for SMT and reflow soldering processes and have a push-in spring-cage connection or an insulation displacement connection.

The plug-in connectors are available with three connection technologies: push-in spring-cage, pierce, and insulation displacement technology. The corresponding headers can be connected to the PCB using wave soldering, reflow soldering or SMT processes.

General	46
COMBICON HD cross-reference list	48
PCB terminal blocks and plugs with 2.5 mm pitch	51
THR spring-cage PCB terminal blocks up to 0.75 mm ²	51
SMD spring-cage PCB terminal blocks up to 0.75 mm ²	53
Plugs with pierce contact up to 0.34 mm ² and spring-cage connection up to 0.75 mm ²	55
CAT5 plug with fast connection	57
SMT and THR base strips for plugs with pierce contact or spring-cage connection	59
Inverted SMT and THR base strips	61
PCB terminal blocks with insulation displacement connection with 2.5 mm pitch	63
Connection cross section up to 0.34 mm ²	63
Plugs with displacement connection, 2.0 to 2.54 mm pitch	65
Plugs with displacement connection up to 0.5 mm ²	65
Single and four-row headers for wave soldering and SMD processes	67
Bus plug-in connectors with connection cross section up to 0.75 mm ²	69

COMBICON High Density general

Reflow and SMT soldering processes

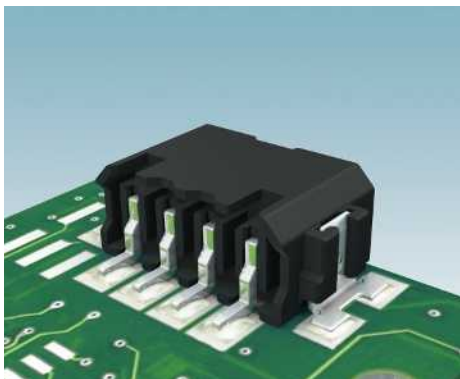

With its new COMBICON HD series, Phoenix Contact offers products that are specially tailored to THR and SMT soldering processes. The base strips and PCB terminal blocks in the COMBICON HD series are made from high-temperature-resistant material and are packed in taped form as standard. For terminal blocks with horizontal conductor connection, the suction area is located directly on the top of the housing. Versions with vertical conductor connection are equipped with a suction pad to enable automatic mounting.

Possible applications

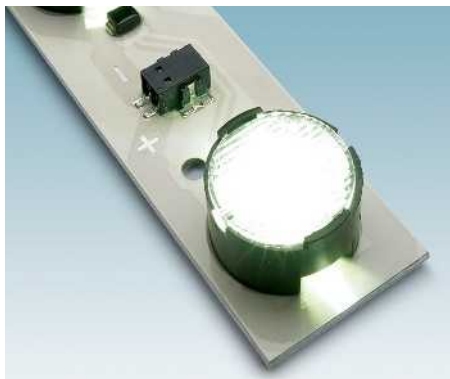

Due to their size, the products in the COMBICON HD series are ideal for all applications where space is limited. Since these terminal blocks can be mounted with other SMD components in a single step, further cost savings are made through additional selective soldering processes. Thanks to the SMT technology, the terminal blocks are particularly suitable for metal core PCBs, such as those used in LED lighting technology. The conventional field of application for CIOC miniature plug-in connectors is the networking of sensors and actuators with the controller. With the aid of link plugs, data can be transmitted safely to the PLC or to the field via bus cables.

Quick and easy wiring

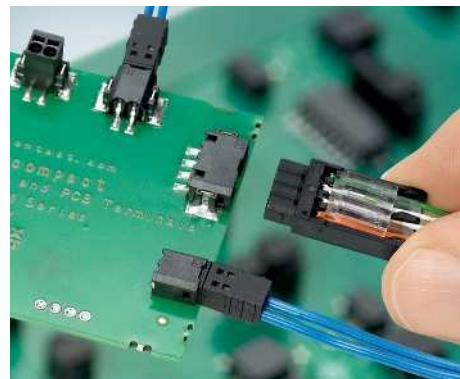

All products in the COMBICON HD series can be connected quickly and easily by means of push-in spring-cage, insulation displacement or pierce technology. The user therefore saves a lot of time during wiring.

COMBICON HD PCB terminal blocks and plug-in connectors with spring-cage connection support the tool-free connection of solid conductors and conductors with ferrules. A screwdriver can be used to open the clamping space via the integrated release shaft.

Plug-in connector versions with pierce connection do not require conductor pretreatment. When the cover is closed, the pierce metal penetrates the conductor insulation and thereby makes contact.

Basics of data transmission

Physical principles must be observed for the transmission of data via copper cables. It is not possible to transmit a signal from one end of a cable to the other without any loss. The dependence on various transmission parameters, such as capacitive and inductive influences and contact resistance, is too great. In order to classify their level of performance, they are split into various categories (CAT1 to CAT7). By determining the near end crosstalk attenuation and reflection loss it is possible to check a cable or plug-in connector's level of performance during data transmission.

Near end crosstalk (NEXT) reveals how greatly the signals of two adjacent wire pairs influence one another. If various signals are transmitted via different twisted wire pairs in a cable, crosstalk and therefore mutual signal interference can occur. The higher the near end crosstalk, the better the transmission quality.

The return loss indicates to what extent a signal is reflected in a cable. Signal reflection

can occur if there are disturbances on the transmission path, such as unevenness in the cable or the transition between the cable and plug-in connector. The higher the return loss, the lower the signal reflection and the better the transmission quality.

The two diagrams illustrate the near end crosstalk and the reflection loss of a PTPM plug-in connector with an Ethernet cable.

The top curve is the limiting curve. As long as the characteristic curve for the components to be tested is below this curve, the requirements of category 5 are met.

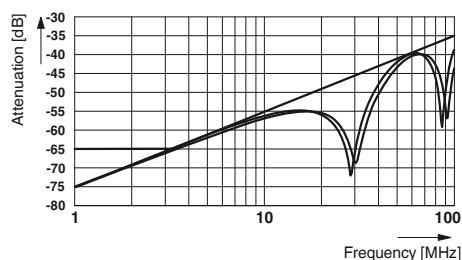

Near end crosstalk attenuation for PTPM plug with Ethernet cable

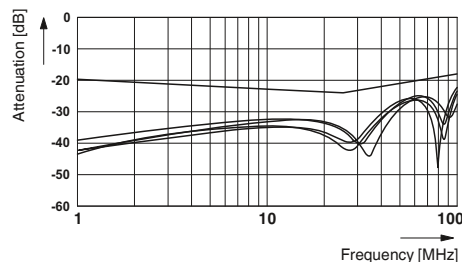

Reflection loss for PTPM plug with Ethernet cable

Conductor connection - miniature spring-cage PCB terminal blocks and plugs in the PTSM series

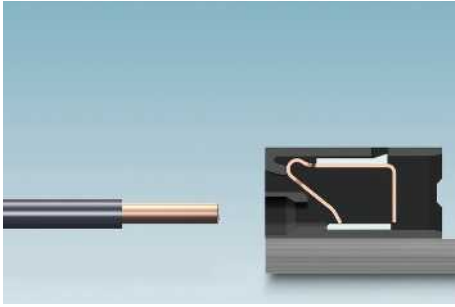

Strip conductor and connect solid conductor by means of direct plug-in technology. When connecting stranded conductors, the terminal point should be opened. To do this, insert a screwdriver in the opening above the cable entry funnel.

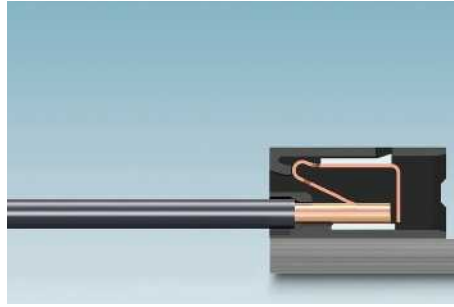

The conductor is connected and the terminal block is ready for operation.

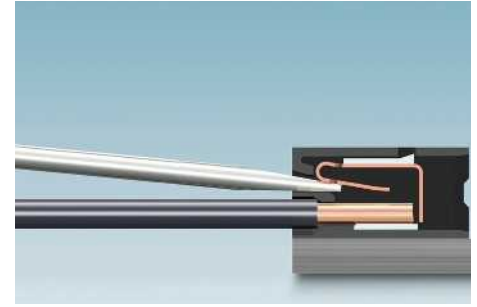

To release the conductor, insert the screwdriver in the opening above the cable entry funnel and remove the conductor.

Conductor connection - PTPM pierce contact connector

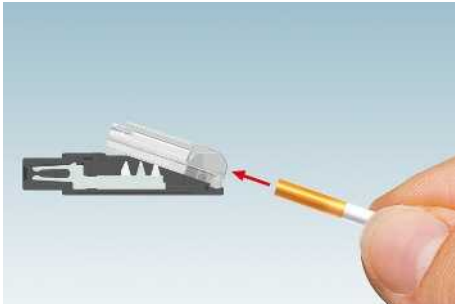

Insert the untreated conductor in the terminal block diagonally from below.

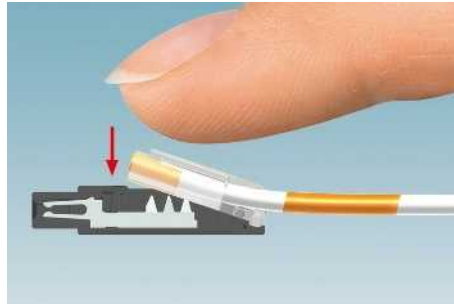

Slide the conductor through the cover so that it is flush with the cover. Now close the cover.

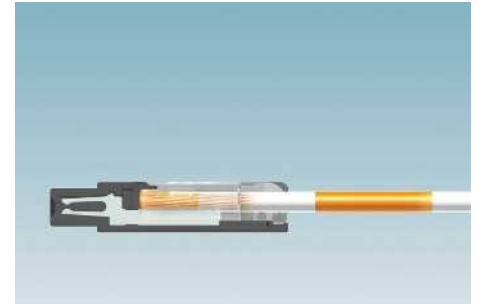

The conductor is connected. The pierce contacts have penetrated the conductor insulation and a gas-tight connection has been established.

Conductor connection - PTQ miniature IDC terminal block



By default, the terminal block is closed in order to enable automatic assembly. Open the cover up before connecting the conductor.



Insert the untreated conductor in the terminal block cover until it is visible in the housing cutout.







Press down on the cover to close the terminal block. The insulation displacement contacts thus cut through the insulation.

High density PCB terminal blocks and plug-in connectors

COMBICON High Density cross-reference list

		COMBICON HD headers								
COMBICON HD plugs	Type	PTSM...HH THR Page 59	PTSM...HV THR Page 59	PTSM...HH SMD Page 59	CIOC...F Page 65	CIOC...FL Page 65	CIOC...FV-A Page 67	CIOC...FV Page 67		
	Pitch	2.5	2.5	2.5	2.0	2.0	2.0	2.0		
	PTPM 0,2/...-P-2,5 Page 55	2.5	•	•	•					
	PTPM 0,4/...-P-2,5 Page 55	2.5	•	•	•					
	PTSM 0,5/...-P-2,5 Page 55	2.5	•	•	•					
	PTSM 0,5/...-HHI-2,5-THR Page 61	2.5	•	•	•					
	PTSM 0,5/...-HHI-2,5-SMD Page 61	2.5	•	•	•					
	CIOC...M Page 65	2.0				•	•	•	•	
	CIOC...LI Page 69	2.54								

			
CIOC...FH-SMD Page 67	CIOC...LIH Page 69	CIOC...LIV Page 69	CIOC...LI Page 69
2.0	2.54	2.54	2.54
•			
	•	•	•

High density PCB terminal blocks and plug-in connectors

PCB terminal blocks and connectors with 2.5 mm pitch

THR spring-cage PCB terminal blocks up to 0.75 mm²

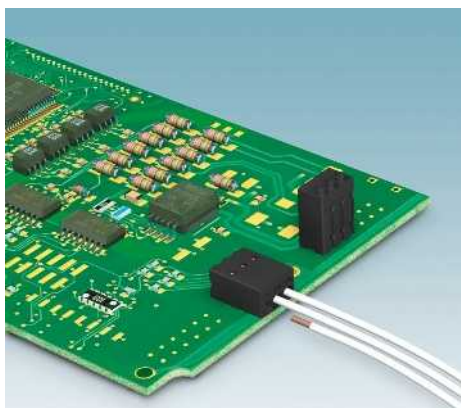

- Compact low-profile THR print terminal block, pitch 2.5 mm
- Spring-cage connection using direct plug-in method with a release button
- High current carrying capacity for high power transmission
- Double solder pins for stable hold on PCB
- Specifically designed for use in re-flow/solder processes
- Supplied in tape-on-reel packing according to IEC 60286-3 for automated mounting

Notes:

Pick and place pads for taped THR articles usually protrude beyond the components. The PCB layout must ensure that collisions are avoided when components are assembled. Dimensional drawings of tape reels and place pads can be found online at www.phoenixcontact.net/products.



PTSM is also available with white housings, see page 391.

Observe derating curve.

1) Stranded conductor cross section of up to 0.75 mm² supported, for a rated insulation voltage of 32 V for III/2.

2) Applies for single-phase networks.

Accessories

For all types	Type	Page
	Screwdriver SZS 0,4 X 2,0 Order No. 1205202	
	Ferrules with and without plastic sleeve	834
	Crimping pliers for 0.25 to 6 mm ² CRIMPFOX 6 Order No. 1212034	

Current carrying capacity curve

Type: PTSM 0,5/...-2,5-H- THR R...

Tested in accordance with DIN EN 60512-5-2:2003-01

Reduction factor = 1

No. of positions: 5

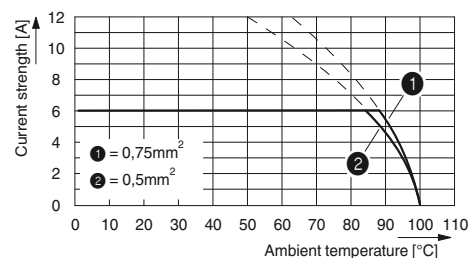

Technical data

Technical data in accordance to IEC / DIN VDE

Rated current / conductor cross section [A] / [mm²]

Rated insulation voltage for pollution degree 2 [V]

Pitch [mm]

Connection capacity

Solid / stranded [mm²] / [mm²] / AWG

Stranded with ferrules without plastic sleeve [mm²]

Stranded with ferrules with plastic sleeve [mm²]

Multi-conductor connection capacity (two conductors with the same cross section)

Solid / stranded [mm²]

Stranded with ferrules without plastic sleeve [mm²]

Stranded with TWIN ferrule with plastic sleeve [mm²]

Insulation coordination

Surge voltage category / pollution degree

Rated insulation voltage [V]

Rated surge voltage [kV]

Approval data (UL/CUL) Use Group

Nominal voltage [V]

Nominal current [A]

Connection capacity AWG AWG

Approval data (CSA) Use Group

Nominal voltage [V]

Nominal current [A]

Connection capacity AWG AWG

General data

Stripping length [mm]

Type of insulation material / insulation material group

Inflammability class according to UL 94

Drill hole diameter / pin dimensions [mm]

PTSM 0,5/...-2,5-H THR R24

6 / 0.5

200²)

2.5

0.14 - 0.5 / 0.2 - 0.5 / 24 - 20¹)

0.25 - 0.5

-

- / -

-

-

III / 3 III / 2 II / 2

63 200²) 200

2.5 2.5 2.5

B C D

150 - -

5 - -

26 - 20 - -

B C D

- - -

- - -

- - -

6

LCP / IIIa

V0

1.2 / 0.3 x 0.8 mm

PTSM 0,5/...-2,5-V THR R44

6 / 0.5

200²)

2.5

0.14 - 0.5 / 0.2 - 0.5 / 24 - 20¹)

0.25 - 0.5

-

- / -

-

-

III / 3 III / 2 II / 2

63 200²) 200

2.5 2.5 2.5

B C D

150 - -

5 - -

26 - 20 - -

B C D

- - -

- - -

- - -

6

LCP / IIIa

V0

1.2 / 0.3 x 0.8 mm

No. of pos. Dim. a [mm]

2 2.50

3 5.00

4 7.50

5 10.00

6 12.50

7 15.00

8 17.50



Horizontal PCB terminal block
for THR applications



Vertical PCB terminal block
for THR applications



Dimensional drawing

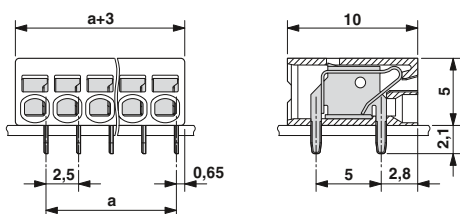

Drilling diagram

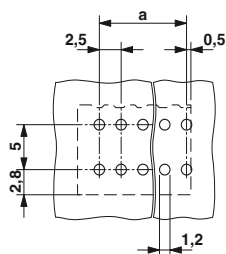

Dimensional drawing

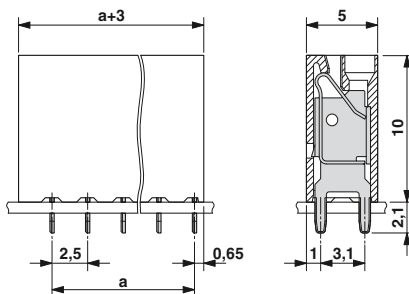

Drilling diagram

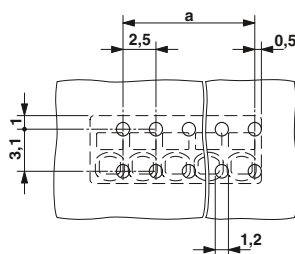

Ordering data

Type	Order No.	Pcs. / Pkt.
2.5 mm pitch, color: black		
PTSM 0,5/ 2-2,5-H THR R24	1770885	530
PTSM 0,5/ 3-2,5-H THR R32	1770898	530
PTSM 0,5/ 4-2,5-H THR R32	1770908	530
PTSM 0,5/ 5-2,5-H THR R32	1770911	530
PTSM 0,5/ 6-2,5-H THR R32	1770924	530
PTSM 0,5/ 7-2,5-H THR R32	1770937	530
PTSM 0,5/ 8-2,5-H THR R32	1770940	530

Ordering data

Type	Order No.	Pcs. / Pkt.
2.5 mm pitch, color: black		
PTSM 0,5/ 2-2,5-V THR R44	1770953	310
PTSM 0,5/ 3-2,5-V THR R44	1770966	310
PTSM 0,5/ 4-2,5-V THR R44	1770979	310
PTSM 0,5/ 5-2,5-V THR R44	1770982	310
PTSM 0,5/ 6-2,5-V THR R44	1770995	310
PTSM 0,5/ 7-2,5-V THR R44	1771004	310
PTSM 0,5/ 8-2,5-V THR R44	1771017	310

High density PCB terminal blocks and plug-in connectors

PCB terminal blocks and plugs with 2.5 mm pitch

SMD spring-cage PCB terminal blocks up to 0.75 mm²

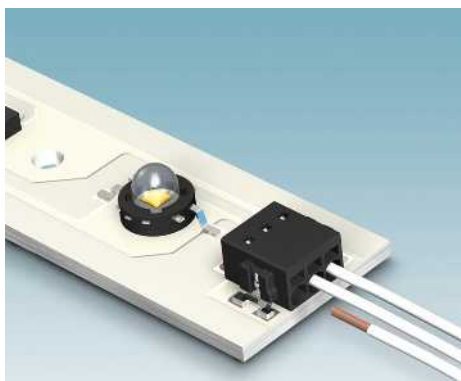

- Compact low-profile SMD print terminal block, pitch 2.5 mm
- Spring-cage connection using direct plug-in method with a release button
- High current carrying capacity for high power transmission
- Rugged soldering anchors for safe mechanical fastening on the surface
- Specially designed to be used in pure SMT processes
- Supplied in tape-on-reel packing according to IEC 60286-3 for automated mounting

Notes:

Pick and place pads for taped THR articles usually protrude beyond the components. The PCB layout must ensure that collisions are avoided when components are assembled. Dimensional drawings of tape reels and place pads can be found online at www.phoenixcontact.net/products.



PTSM is also available with white housings, see page 393.

Observe derating curve.

1) Stranded conductor cross section of up to 0.75 mm² supported, for a rated insulation voltage of 32 V for III/2.

2) Applies for single-phase networks.

Accessories

For all types	Type	Page
	Screwdriver SZS 0,4 X 2,0 Order No. 1205202	
	Ferrules with and without plastic sleeve	834
	Crimping pliers for 0.25 to 6 mm ² CRIMPFOX 6 Order No. 1212034	

Current carrying capacity curve

Type: PTSM 0,5/...-2,5-H- SMD R44

Tested in accordance with DIN EN 60512-5-2:2003-01

Reduction factor = 1

No. of positions: 5

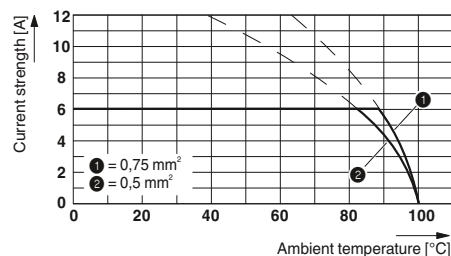

Technical data

Technical data in accordance to IEC / DIN VDE

Rated current / conductor cross section [A] / [mm²]

Rated insulation voltage for pollution degree 2 [V]

Pitch [mm]

Connection capacity

Solid / stranded [mm²] / [mm²] / AWG

Stranded with ferrules without plastic sleeve [mm²]

Stranded with ferrules with plastic sleeve [mm²]

Multi-conductor connection capacity (two conductors with the same cross section)

Solid / stranded [mm²]

Stranded with ferrules without plastic sleeve [mm²]

Stranded with TWIN ferrule with plastic sleeve [mm²]

Insulation coordination

Surge voltage category / pollution degree

Rated insulation voltage [V]

Rated surge voltage [kV]

Approval data (UL/CUL) Use Group

Nominal voltage [V]

Nominal current [A]

Connection capacity AWG AWG

Approval data (CSA) Use Group

Nominal voltage [V]

Nominal current [A]

Connection capacity AWG AWG

General data

Stripping length [mm]

Type of insulation material / insulation material group

Inflammability class according to UL 94

PTSM 0,5/ ...-2,5-H SMD R24

6 / 0.5

160²⁾

2.5

0.14 - 0.5 / 0.2 - 0.5 / 24 - 20¹⁾

0.25 - 0.5

-

- / -

-

-

III / 3 III / 2 II / 2

32 160²⁾ 160

2.5 2.5 2.5

B C D

150 - -

5 - -

26 - 20 - -

B C D

- - -

- - -

- - -

6

LCP / IIIa

V0

PTSM 0,5/ ...-2,5-V SMD R44

6 / 0.5

160²⁾

2.5

0.14 - 0.5 / 0.2 - 0.5 / 24 - 20¹⁾

0.25 - 0.5

-

- / -

-

-

III / 3 III / 2 II / 2

32 160²⁾ 160

2.5 2.5 2.5

B C D

150 - -

5 - -

26 - 20 - -

B C D

- - -

- - -

- - -

6

LCP / IIIa

V0

No. of pos. Dim. a [mm]

2 2.50

3 5.00

4 7.50

5 10.00

6 12.50

7 15.00

8 17.50



Horizontal PCB terminal block for SMD applications



Vertical PCB terminal block for SMD applications



Dimensional drawing

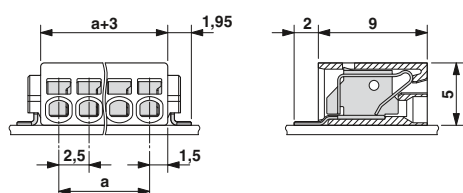

Drilling diagram

Dimension M: 7.7 mm

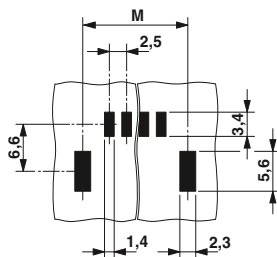

Ordering data

Type	Order No.	Pcs. / Pkt.
2.5 mm pitch, color: black		
PTSM 0,5/ 2-2,5-H SMD R24	1702473	770
PTSM 0,5/ 3-2,5-H SMD R44	1771033	770
PTSM 0,5/ 4-2,5-H SMD R24	1702474	770
PTSM 0,5/ 5-2,5-H SMD R44	1771059	770
PTSM 0,5/ 6-2,5-H SMD R44	1771062	770
PTSM 0,5/ 7-2,5-H SMD R44	1771075	770
PTSM 0,5/ 8-2,5-H SMD R44	1771088	770



Dimensional drawing

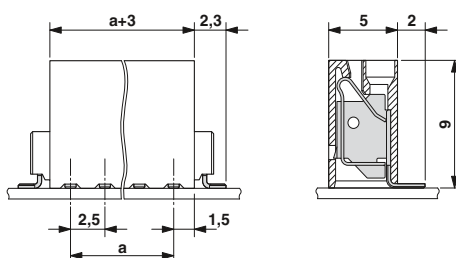

Drilling diagram

Dimension M: 8.4 mm

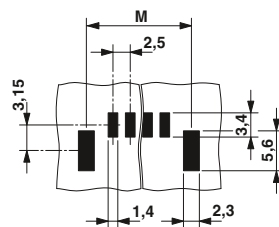

Ordering data

Type	Order No.	Pcs. / Pkt.
2.5 mm pitch, color: black		
PTSM 0,5/ 2-2,5-V SMD R44	1771091	400
PTSM 0,5/ 3-2,5-V SMD R44	1771101	400
PTSM 0,5/ 4-2,5-V SMD R44	1771114	400
PTSM 0,5/ 5-2,5-V SMD R44	1771127	400
PTSM 0,5/ 6-2,5-V SMD R44	1771130	400
PTSM 0,5/ 7-2,5-V SMD R44	1771143	400
PTSM 0,5/ 8-2,5-V SMD R44	1771156	400

High density PCB terminal blocks and plug-in connectors

PCB terminal blocks and plugs with 2.5 mm pitch

Plug with pierce contact up to 0.34 mm² and spring-cage connection up to 0.75 mm²

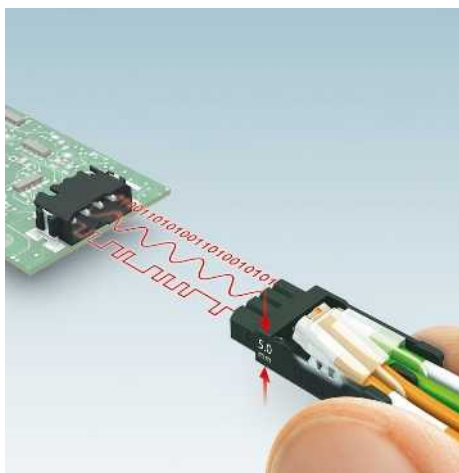

- Miniature plug with 2.5 mm pitch
- Can be plugged into THR and SMD headers
- Spring-cage and pierce contact technology
- Conductor connection up to 0.75 mm²
- High current carrying capacity up to 6 A

Notes:



Do not use ferrules with pierce contact plugs.

COMBICON select

You will find the possible plug-in connector combinations in COMBICON select at: www.phoenixcontact.net/products or starting on page 48.

¹⁾ Stranded conductor cross section of up to 0.75 mm² supported, for a rated insulation voltage of 32 V for III/2.

Accessories

For all types	Type	Page
For PTSM plugs only		
	Screwdriver SZS 0,4 X 2,0 Order No. 1205202	
	Ferrules with and without plastic sleeve	834
	Crimping pliers for 0.25 to 6 mm ² CRIMPFOX 6 Order No. 1212034	

Technical data

Technical data in accordance to IEC / DIN VDE	
Rated current / conductor cross section	[A] / [mm ²]
Rated insulation voltage for pollution degree 2	[V]
Pitch	[mm]
Connection capacity	
Solid / stranded	[mm ²] / [mm ²] / AWG
Insulation coordination	
Surge voltage category / pollution degree	
Rated insulation voltage	[V]
Rated surge voltage	[kV]
Approval data (UL/CUL)	Use Group
Nominal voltage	[V]
Nominal current	[A]
Connection capacity AWG	AWG
Approval data (CSA)	Use Group
Nominal voltage	[V]
Nominal current	[A]
Connection capacity AWG	AWG
General data	
Type of insulation material / insulation material group	
Inflammability class according to UL 94	

PTPM 0,2/...-P-2,5

2 / 0.14		
160		
2.5		
- / 0.14 - 0.14 / 26 - 26		
III / 3	III / 2	II / 2
40	160	160
2.5	2.5	2.5
B	C	D
50	-	50
2	-	2
26	-	26
B	C	D
-	-	-
-	-	-
-	-	-
PA/PC / III		
V0/V2		

PTPM 0,4/...-P-2,5

4 / 0.34		
125		
2.5		
- / 0.25 - 0.34 / 24 - 22		
III / 3	III / 2	II / 2
32	125	125
2.5	2.5	2.5
B	C	D
50	-	50
3	-	3
24 - 22	-	24 - 22
B	C	D
-	-	-
-	-	-
-	-	-
PA/PC / III		
V0/V2		

PTSM 0,5/ ...-P-2,5

6 / 0.5		
160		
2.5		
0.14 - 0.5 / 0.2 - 0.5 ¹⁾ / 24 - 20		
III / 3	III / 2	II / 2
100	160	320
2.5	2.5	2.5
B	C	D
150	-	-
5	-	-
26 - 20	-	-
B	C	D
-	-	-
-	-	-
-	-	-
PA / I		
V0		

No. of pos.	Dim. a [mm]
2	2.50
3	5.00
4	7.50
5	10.00
6	12.50
7	15.00
8	17.50
10	22.50



Pierce contact plug for conductor cross sections up to 0.14 mm²/26 AWG



Pierce contact plug for conductor cross sections up to 0.34 mm²/24 - 22 AWG



Spring-cage plug for conductor cross sections up to 0.75 mm²



Dimensional drawing

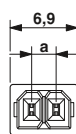
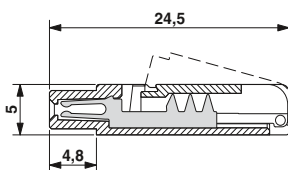
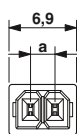
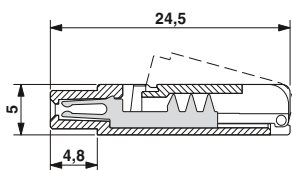

Dimensional drawing

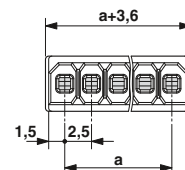
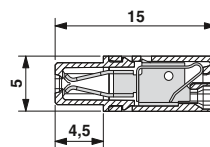

Ordering data		
Type	Order No.	Pcs. / Pkt.
PTPM 0,2/ 2-P-2,5	1780477	250
PTPM 0,2/ 4-P-2,5	1780480	250
PTPM 0,2/ 6-P-2,5	1780493	100
PTPM 0,2/ 8-P-2,5	1780503	100
PTPM 0,2/10-P-2,5	1780516	50

Ordering data		
Type	Order No.	Pcs. / Pkt.
PTPM 0,4/ 2-P-2,5	1780529	250
PTPM 0,4/ 4-P-2,5	1780532	250
PTPM 0,4/ 6-P-2,5	1780545	100
PTPM 0,4/ 8-P-2,5	1780558	100
PTPM 0,4/10-P-2,5	1780561	50

Ordering data		
Type	Order No.	Pcs. / Pkt.
PTSM 0,5/ 2-P-2,5	1778832	250
PTSM 0,5/ 3-P-2,5	1778845	250
PTSM 0,5/ 4-P-2,5	1778858	250
PTSM 0,5/ 5-P-2,5	1778861	100
PTSM 0,5/ 6-P-2,5	1778874	100
PTSM 0,5/ 7-P-2,5	1778887	100
PTSM 0,5/ 8-P-2,5	1778890	100

CAT5 plug with fast connection

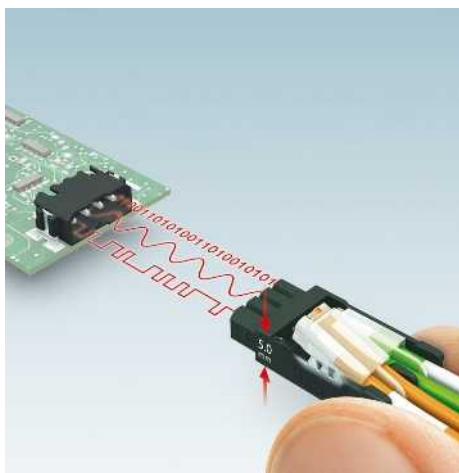

- 4-pos. miniature plug with 2.5 mm pitch
- CAT5 Ethernet-capable according to IEC 11801
- Paired fast connection
- Tool-free conductor connection
- Can be combined with 5-pos. THR and SMD base strips of types PTSM 0,5/5...

Accessories

For all types	Type	Page
	Base strip PTSM 0,5/ 5-HH-2,5- THR R32 Order No. 1778654	59
	Base strip PTSM 0,5/ 5-HV-2,5- THR R32 Order No. 1778586	59
	Base strip PTSM 0,5/ 5-HH-2,5- SMD R32 Order No. 1778793	59

Technical data

Technical data in accordance to IEC / DIN VDE	
Rated current / conductor cross section	[A] / [mm ²]
Rated insulation voltage for pollution degree 2	[V]

Pitch	[mm]
Connection capacity	
Solid / stranded	[mm ²] / [mm ²] / AWG
Insulation coordination	
Surge voltage category / pollution degree	
Rated insulation voltage	[V]
Rated surge voltage	[kV]
Approval data (UL/CUL)	Use Group
Nominal voltage	[V]
Nominal current	[A]
Connection capacity AWG	AWG
Approval data (CSA)	Use Group
Nominal voltage	[V]
Nominal current	[A]
Connection capacity AWG	AWG

General data	
Type of insulation material / insulation material group	
Inflammability class according to UL 94	

PTPM 0,2/ 5-P-2,5 PA CAT5

Rated current / conductor cross section	2 / 0.14
Rated insulation voltage for pollution degree 2	160

Pitch	2.5
Connection capacity	
Solid / stranded	- / 0.14 - 0.14 / 26 - 26
Insulation coordination	
Surge voltage category / pollution degree	III / 3 III / 2 II / 2
Rated insulation voltage	40 160 160
Rated surge voltage	2.5 2.5 2.5
Approval data (UL/CUL)	B C D
Nominal voltage	50 - 50
Nominal current	2 - 2
Connection capacity AWG	26 - 26
Approval data (CSA)	B C D
Nominal voltage	- - -
Nominal current	- - -
Connection capacity AWG	- - -

Type of insulation material / insulation material group	PA/PC / III
Inflammability class according to UL 94	V0/V2

PTPM 0,4/ 5-P-2,5 PA CAT5

Rated current / conductor cross section	4 / 0.34
Rated insulation voltage for pollution degree 2	125

Pitch	2.5
Connection capacity	
Solid / stranded	- / 0.25 - 0.34 / 24 - 22
Insulation coordination	
Surge voltage category / pollution degree	III / 3 III / 2 II / 2
Rated insulation voltage	32 125 125
Rated surge voltage	2.5 2.5 2.5
Approval data (UL/CUL)	B C D
Nominal voltage	50 - 50
Nominal current	3 - 3
Connection capacity AWG	24 - 22 - 24 - 22
Approval data (CSA)	B C D
Nominal voltage	- - -
Nominal current	- - -
Connection capacity AWG	- - -

Type of insulation material / insulation material group	PA/PC / III
Inflammability class according to UL 94	V0/V2

No. of pos.

4



Pierce connection of conductor cross sections of 0.14 mm²/26 AWG

Pierce connection of conductor cross sections from 0.25 to 0.34 mm²/24 - 22 AWG



Dimensional drawing

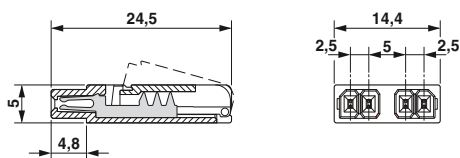

Dimensional drawing

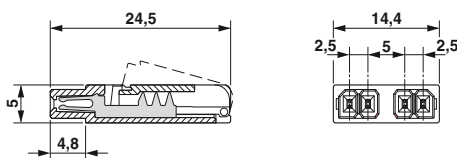

Ordering data

Type	Order No.	Pcs. / Pkt.
2.5 mm pitch, color: black		
PTPM 0,2/ 5-P-2,5 PA CAT5	1811161	100

Ordering data

Type	Order No.	Pcs. / Pkt.
2.5 mm pitch, color: black		
PTPM 0,4/ 5-P-2,5 PA CAT5	1811145	100

High density PCB terminal blocks and plug-in connectors

PCB terminal blocks and plugs with 2.5 mm pitch

SMT and THR headers for plugs with pierce contact or spring-cage connection

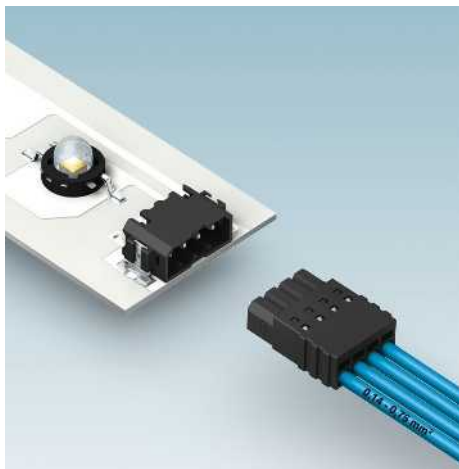

- Specifically designed for use in reflow and SMT processes
- High current carrying capacity of 6 A
- Rugged soldering anchors for safe mechanical fastening on the surface
- Supplied in tape-on-reel packing according to IEC 60286-3 for automated mounting
- Compatible with PTSM...-/PTPM...connectors
- Versions with and without positioning pins are available
- 2.5 mm pitch

Notes:

COMBICON select

You will find the possible plug-in connector combinations in COMBICON select at: www.phoenixcontact.net/products or starting on page 48.

Pick and place pads for taped THR articles usually protrude beyond the components. The PCB layout must ensure that collisions are avoided when components are assembled. Dimensional drawings of tape reels and place pads can be found online at www.phoenixcontact.net/products.

PTSM is also available with white housings, see page 397.

1) UL/CUL on request.

2) Current carrying dependent upon plug used.

3) Applies for single-phase networks.

Technical data

Technical data in accordance to IEC / DIN VDE

Rated current	[A]
Rated insulation voltage for pollution degree 2	[V]
Pitch	[mm]
Insulation coordination	
Surge voltage category / pollution degree	
Rated insulation voltage	[V]
Rated surge voltage	[kV]
Approval data (UL/CUL)	Use Group
Nominal voltage	[V]
Nominal current	[A]
Connection capacity AWG	AWG
Approval data (CSA)	Use Group
Nominal voltage	[V]
Nominal current	[A]
Connection capacity AWG	AWG
General data	
Type of insulation material / insulation material group	
Inflammability class according to UL 94	
Drill hole diameter / pin dimensions	[mm]

PTSM 0,5/ ...-HH-2,5-THR R16			PTSM 0,5/ ...-HV-2,5-THR R32			PTSM 0,5/ ...-HH0-2,5-SMD R32		
6 ²⁾			6 ²⁾			6		
160 ³⁾			160 ³⁾			160 ³⁾		
2.5			2.5			2.5		
III / 3	III / 2	II / 2	III / 3	III / 2	II / 2	III / 3	III / 2	II / 2
50	160 ³⁾	160	50	160 ³⁾	160	50	160 ³⁾	160
2.5	2.5	2.5	2.5	2.5	2.5	2.5	2.5	2.5
B	C	D	B	C	D	B	C	D
150	-	-	150	-	-	-	-	-
6	-	-	6	-	-	-	-	-
-	-	-	-	-	-	-	-	-
B	C	D	B	C	D	B	C	D
-	-	-	-	-	-	-	-	-
-	-	-	-	-	-	-	-	-
-	-	-	-	-	-	-	-	-
LCP / IIIa			LCP / IIIa			LCP / IIIa		
V0			V0			V0		
1.1 / 0.6 x 0.6 mm			1.1 / 0.6 x 0.6 mm			- / -		

No. of pos.	Dim. a [mm]
2	2.50
3	5.00
4	7.50
5	10.00
6	12.50
7	15.00
8	17.50
10	22.50



Horizontal header for THR applications



Vertical header for THR applications



Horizontal header for SMD applications



Dimensional drawing

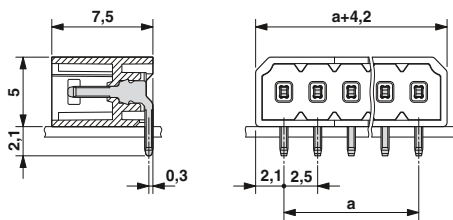

Drilling diagram

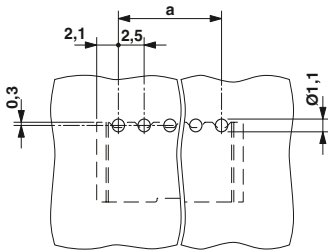

Ordering data

Type Order No. Pcs. / Pkt.
2.5 mm pitch, color: black, without positioning pin, with positioning pin, see www.phoenixcontact.net/products

PTSM 0,5/ 2-HH-2,5-THR R16	1778625	500
PTSM 0,5/ 3-HH-2,5-THR R32	1778638	500
PTSM 0,5/ 4-HH-2,5-THR R32	1778641	500
PTSM 0,5/ 5-HH-2,5-THR R32	1778654	500
PTSM 0,5/ 6-HH-2,5-THR R32	1778667	500
PTSM 0,5/ 7-HH-2,5-THR R44	1778670	500
PTSM 0,5/ 8-HH-2,5-THR R44	1778683	500
PTSM 0,5/10-HH-2,5-THR R44	1701569	500



Applied for: cUL / UL

Dimensional drawing

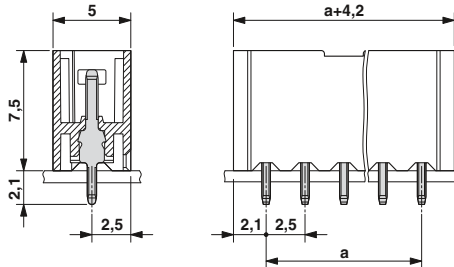

Drilling diagram

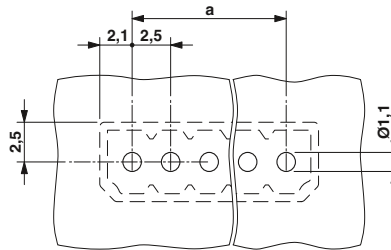

Ordering data

Type Order No. Pcs. / Pkt.
2.5 mm pitch, color: black, without positioning pin, with positioning pin, see www.phoenixcontact.net/products

PTSM 0,5/ 2-HV-2,5-THR R32	1778557	330
PTSM 0,5/ 3-HV-2,5-THR R32	1778560	330
PTSM 0,5/ 4-HV-2,5-THR R32	1778573	330
PTSM 0,5/ 5-HV-2,5-THR R32	1778586	330
PTSM 0,5/ 6-HV-2,5-THR R32	1778599	330
PTSM 0,5/ 7-HV-2,5-THR R44	1778609	330
PTSM 0,5/ 8-HV-2,5-THR R44	1778612	330
PTSM 0,5/10-HV-2,5-THR R44	1701567	330

Dimensional drawing

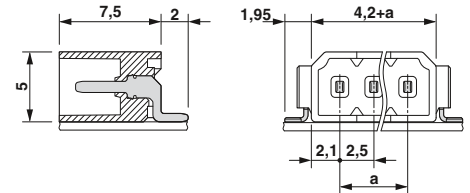

Drilling diagram

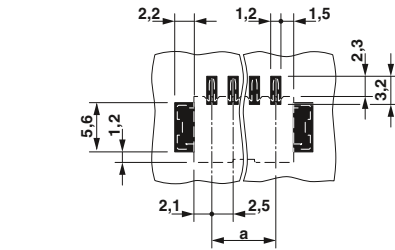

Ordering data

Type Order No. Pcs. / Pkt.
2.5 mm pitch, color: black, without positioning pin, with positioning pin, see www.phoenixcontact.net/products

PTSM 0,5/ 2-HH0-2,5-SMD R32	1808190	600
PTSM 0,5/ 3-HH0-2,5-SMD R32	1808200	600
PTSM 0,5/ 4-HH0-2,5-SMD R32	1808213	600
PTSM 0,5/ 5-HH0-2,5-SMD R32	1808226	600
PTSM 0,5/ 6-HH0-2,5-SMD R44	1808239	600
PTSM 0,5/ 7-HH0-2,5-SMD R44	1808242	600
PTSM 0,5/ 8-HH0-2,5-SMD R44	1808255	600

High density PCB terminal blocks and plug-in connectors

PCB terminal blocks and plugs with 2.5 mm pitch

Inverted SMT and THR base strips



- Specifically designed for use in reflow and SMT processes
- High current carrying capacity of 6 A
- Robust solder anchor for secure, mechanical fixing to the surface
- Supplied in tape-on-reel packing according to IEC 60286-3 for automated mounting
- Compatible with PTSM base strips
- Versions with and without positioning pins are available
- 2.5 mm pitch

Notes:

COMBICON select

You will find the possible plug-in connector combinations in COMBICON select at: www.phoenixcontact.net/products or starting on page 48.

Pick and place pads for taped THR articles usually protrude beyond the components. The PCB layout must ensure that collisions are avoided when components are assembled. Dimensional drawings of the pick and place pads can be found online at www.phoenixcontact.net/products.

PTSM is also available with white housings, see page 399.

¹⁾ UL/CUL on request.

²⁾ Applies for single-phase networks.

Technical data

Technical data in accordance to IEC / DIN VDE

Rated current	[A]	6
Rated insulation voltage for pollution degree 2	[V]	200 ²⁾
Pitch	[mm]	2.5
Insulation coordination		
Surge voltage category / pollution degree		
Rated insulation voltage	[V]	63 200 ²⁾ 200
Rated surge voltage	[kV]	2.5 2.5 2.5
Approval data (UL/CUL)	Use Group	B C D
Nominal voltage	[V]	- - -
Nominal current	[A]	- - -
Connection capacity AWG	AWG	- - -
Approval data (CSA)	Use Group	B C D
Nominal voltage	[V]	- - -
Nominal current	[A]	- - -
Connection capacity AWG	AWG	- - -
General data		
Type of insulation material / insulation material group		LCP / IIIa
Inflammability class according to UL 94		V0
Drill hole diameter / pin dimensions	[mm]	1 / 0.6 x 0.4 mm

PTSM 0,5/...-HHI-2,5-THR R24

Rated current	6
Rated insulation voltage for pollution degree 2	200 ²⁾
Pitch	2.5
Insulation coordination	
Surge voltage category / pollution degree	
Rated insulation voltage	63 200 ²⁾ 200
Rated surge voltage	2.5 2.5 2.5
Approval data (UL/CUL)	B C D
Nominal voltage	- - -
Nominal current	- - -
Connection capacity AWG	- - -
Approval data (CSA)	B C D
Nominal voltage	- - -
Nominal current	- - -
Connection capacity AWG	- - -
General data	
Type of insulation material / insulation material group	LCP / IIIa
Inflammability class according to UL 94	V0
Drill hole diameter / pin dimensions	1 / 0.6 x 0.4 mm

PTSM 0,5/...-HHI0-2,5-SMD R24

Rated current	6
Rated insulation voltage for pollution degree 2	160 ²⁾
Pitch	2.5
Insulation coordination	
Surge voltage category / pollution degree	
Rated insulation voltage	63 160 ²⁾ 160
Rated surge voltage	2.5 2.5 2.5
Approval data (UL/CUL)	B C D
Nominal voltage	- - -
Nominal current	- - -
Connection capacity AWG	- - -
Approval data (CSA)	B C D
Nominal voltage	- - -
Nominal current	- - -
Connection capacity AWG	- - -
General data	
Type of insulation material / insulation material group	LCP / IIIa
Inflammability class according to UL 94	V0
Drill hole diameter / pin dimensions	- / -

No. of pos.	Dim. a [mm]
2	2.50
3	5.00
4	7.50
5	10.00
6	12.50
7	15.00
8	17.50

N

N



Horizontal inverted header, THR solderable

Horizontal inverted header, SMD solderable

Dimensional drawing

Dimensional drawing

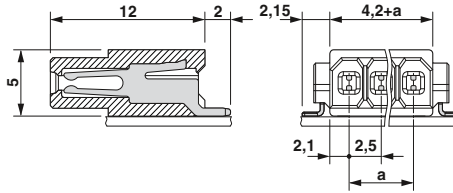
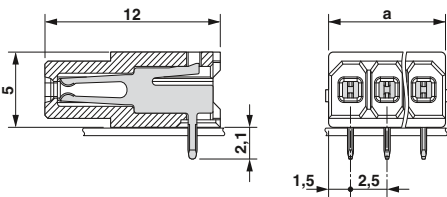

Drilling diagram

Drilling diagram

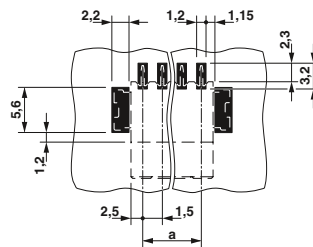
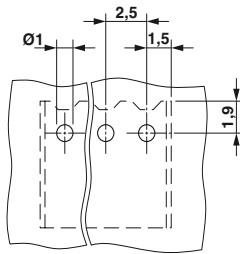

Ordering data

Ordering data

Type Order No. Pcs. / Pkt.
2.5 mm pitch, color: black, without positioning pin, with positioning pin, see www.phoenixcontact.net/products

Type Order No. Pcs. / Pkt.
2.5 mm pitch, color: black, without positioning pin, with positioning pin, see www.phoenixcontact.net/products

PTSM 0,5/ 2-HHI-2,5-THR R24	1815057	500
PTSM 0,5/ 3-HHI-2,5-THR R32	1815060	500
PTSM 0,5/ 4-HHI-2,5-THR R32	1815073	500
PTSM 0,5/ 5-HHI-2,5-THR R32	1815086	500
PTSM 0,5/ 6-HHI-2,5-THR R32	1815099	500
PTSM 0,5/ 7-HHI-2,5-THR R32	1815109	500
PTSM 0,5/ 8-HHI-2,5-THR R32	1815112	500

PTSM 0,5/ 2-HHI0-2,5-SMD R24	1815125	500
PTSM 0,5/ 3-HHI0-2,5-SMD R44	1815138	500
PTSM 0,5/ 4-HHI0-2,5-SMD R44	1815141	500
PTSM 0,5/ 5-HHI0-2,5-SMD R44	1815154	500
PTSM 0,5/ 6-HHI0-2,5-SMD R44	1815167	500
PTSM 0,5/ 7-HHI0-2,5-SMD R44	1815170	500
PTSM 0,5/ 8-HHI0-2,5-SMD R44	1815183	500

High density PCB terminal blocks and plug-in connectors

PCB terminal blocks with insulation displacement connection with 2.5 mm pitch

Connection cross section of up to 0.34 mm²

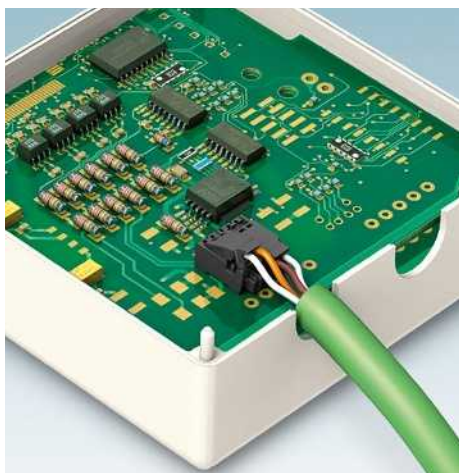

- Conductor connection without pre-treatment.
- 2.5 mm pitch
- THR solderable
- Taped as standard
- Secure locating mechanism
- Option to visually inspect the conductor position
- Supplied in taped packaging according to IEC 60286-3 for automatic assembly
- Anti-rotation pins
- Finger operation, no tools necessary

Notes:

Pick and place pads for taped THR articles usually protrude beyond the components. The PCB layout must ensure that collisions are avoided when components are assembled. Dimensional drawings of the pick and place pads can be found online at www.phoenixcontact.net/products.

Observe derating curve.

Current carrying capacity curve

Type: PTQ 0,3/..-2,5(-L) THR R32

Tested in accordance with DIN EN 60512-5-2:2003-01

Reduction factor = 1

No. of positions: 5

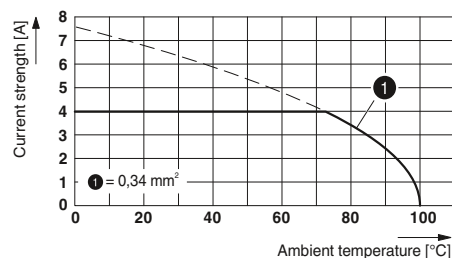

Technical data

Technical data in accordance to IEC / DIN VDE

Rated current / conductor cross section [A] / [mm²]

Rated insulation voltage for pollution degree 2 [V]

4 / 0.34

160

Pitch [mm]

2.5

Connection capacity

Solid / stranded [mm²] / [mm²] / AWG

0.14 - 0.34 / 0.14 - 0.34 / 26 - 22

Insulation coordination

Surge voltage category / pollution degree

III / 3 III / 2 II / 2

Rated insulation voltage [V]

160 160 200

Rated surge voltage [kV]

2.5 2.5 2.5

Approval data (UL/CUL) Use Group

B C D

Nominal voltage [V]

150 - -

Nominal current [A]

2 - -

Connection capacity AWG

24 - -

Approval data (CSA) Use Group

B C D

Nominal voltage [V]

- - -

Nominal current [A]

- - -

Connection capacity AWG

- - -

General data

Type of insulation material / insulation material group

LCP / IIIa

Inflammability class according to UL 94

V0

Drill hole diameter / pin dimensions [mm]

1.1 / 0.9 x 0.4

No. of pos.

Dim. a [mm]

2 2.50



IDC PCB terminal block



Dimensional drawing

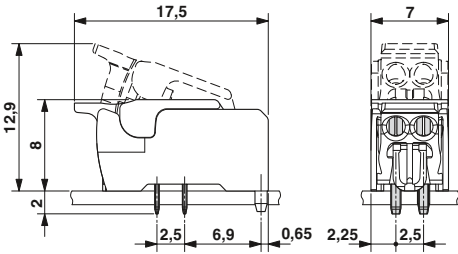

Drilling diagram

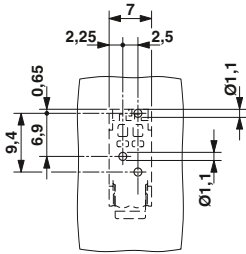

Ordering data

Type	Order No.	Pcs. / Pkt.
PTQ 0,3/ 2-2,5 THR R32	1702610	250

Plugs with displacement connection, 2.0 to 2.54 mm pitch

Plugs with displacement connection up to 0.5 mm²



- 3- and 4-pos. miniature plug-in connectors
- For sensor/actuator wiring
- Fast and safe displacement connection
- Gold-plated contact system
- Connection of AWG conductors with a 7-strand conductor structure and PVC insulation; other conductor types can be used on request
- Conductor connection with the help of conventional pliers
- Colored, transparent covers enable you to check that the displacement connection has been contacted correctly
- Panel feed-through with CIOC ...-FL
- Additional CIOC 3-2...-FL versions available on request

Notes:

In accordance with DIN EN 61984, COMBICON plug-in connectors have no switching power. During designated use, they must not be plugged in or disconnected when carrying voltage or under load.

COMBICON select

You will find the possible plug-in connector combinations in COMBICON select at: www.phoenixcontact.net/products or starting on page 48.

For 3-pos. items, please enquire about the minimum order amount and delivery time.

¹⁾ Different value for CIOC 3-20... and CIOC 4-20... = 24-20 AWG und stranded conductors = 0.25 - 0.5 mm².

Technical data

Technical data in accordance to IEC / DIN VDE

Rated current / conductor cross section [A] / [mm²]

Rated insulation voltage for pollution degree 2 [V]

Pitch [mm]

Connection capacity

Solid / stranded [mm²] / [mm²] / AWG

Insulation coordination

Surge voltage category / pollution degree

Rated insulation voltage [V]

Rated surge voltage [kV]

Approval data (UL/CUL) Use Group

Nominal voltage [V]

Nominal current [A]

Connection capacity AWG AWG

Approval data (CSA) Use Group

Nominal voltage [V]

Nominal current [A]

Connection capacity AWG AWG

Approval data (UL/CUL)

Nominal voltage [V]

Nominal current [A]

Connection capacity AWG AWG

General data

Type of insulation material / insulation material group

Inflammability class according to UL 94

3 / 0.25

32

2

- / 0.14 - 0.25 / 26 - 24¹⁾

III / 3 III / 2 II / 2

32

B C D

- - -

- - -

B C D

- - -

- - -

- - -

32

3

26-20

PBT/PC / -

V0

No. of pos. Dim. a [mm]

3 4.00

4 6.00

3 4.00

4 6.00

3 4.00

4 6.00

3 4.00

4 6.00

3 4.00

4 6.00

3 4.00

4 6.00



Plug with pin contact



Plug with socket contact



Plug as panel feed-through with socket contact



Dimensional drawing

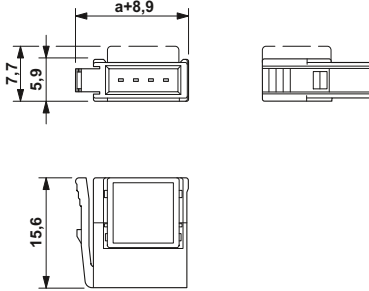

Dimensional drawing

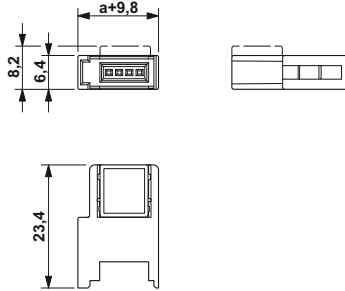

Dimensional drawing

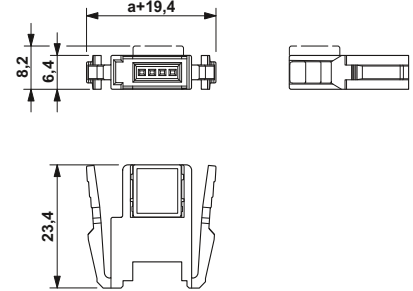

Ordering data

Type	Order No.	Pcs. / Pkt.
1.0 mm outside conductor diameter, 26 - 24 AWG, color: red (CIOC 3-... on request)		
CIOC 3-24-1,0-M	1701390	50
CIOC 4-24-1,0-M	1700994	50
1.2 mm outside conductor diameter, 26 - 24 AWG, color: yellow		
CIOC 3-24-1,2-M	1701391	50
CIOC 4-24-1,2-M	1701016	50
1.6 mm outside conductor diameter, 26 - 24 AWG, color: orange (CIOC 3-... on request)		
CIOC 3-24-1,6-M	1701392	50
CIOC 4-24-1,6-M	1701032	50
1.2 mm outside conductor diameter, 24 - 20 AWG, color: green (CIOC 3-... on request)		
CIOC 3-20-1,2-M	1701393	50
CIOC 4-20-1,2-M	1701058	50
1.6 mm outside conductor diameter, 24 - 20 AWG, color: blue (CIOC 3-... on request)		
CIOC 3-20-1,6-M	1701394	50
CIOC 4-20-1,6-M	1701074	50
2.0 mm outside conductor diameter, AWG 24-20, color: transparent		
CIOC 3-20-2,0-M	1701396	50
CIOC 4-20-2,0-M	1701090	50

Ordering data

Type	Order No.	Pcs. / Pkt.
1.0 mm outside conductor diameter, 26 - 24 AWG, color: red (CIOC 3-... on request)		
CIOC 3-24-1,0-F	1701397	50
CIOC 4-24-1,0-F	1701113	50
1.2 mm outside conductor diameter, 26 - 24 AWG, color: yellow		
CIOC 3-24-1,2-F	1701398	50
CIOC 4-24-1,2-F	1701139	50
1.6 mm outside conductor diameter, 26 - 24 AWG, color: orange (CIOC 3-... on request)		
CIOC 3-24-1,6-F	1701399	50
CIOC 4-24-1,6-F	1701155	50
1.2 mm outside conductor diameter, 24 - 20 AWG, color: green (CIOC 3-... on request)		
CIOC 3-20-1,2-F	1701400	50
CIOC 4-20-1,2-F	1701171	50
1.6 mm outside conductor diameter, 24 - 20 AWG, color: blue (CIOC 3-... on request)		
CIOC 3-20-1,6-F	1701402	50
CIOC 4-20-1,6-F	1701197	50
2.0 mm outside conductor diameter, AWG 24-20, color: transparent		
CIOC 3-20-2,0-F	1701403	50
CIOC 4-20-2,0-F	1701210	50

Ordering data

Type	Order No.	Pcs. / Pkt.
1.0 mm outside conductor diameter, AWG 26-24, color: red		
CIOC 4-24-1,0-FL	1701236	50
1.2 mm outside conductor diameter, 26 - 24 AWG, color: yellow		
CIOC 4-24-1,2-FL	1701252	50
1.6 mm outside conductor diameter, AWG 26-24, color: orange		
CIOC 4-24-1,6-FL	1701278	50
1.2 mm outside conductor diameter, AWG 24-20, color: green		
CIOC 4-20-1,2-FL	1701294	50
1.6 mm outside conductor diameter, 24 - 20 AWG, color: blue (CIOC 3-... on request)		
CIOC 3-20-1,6-FL	1701404	50
CIOC 4-20-1,6-FL	1701317	50
2.0 mm outside conductor diameter, AWG 24-20, color: transparent		
CIOC 4-20-2,0-FL	1701333	50

High density PCB terminal blocks and plug-in connectors

Plugs with displacement connection, 2.0 to 2.54 mm pitch

Single and four-row headers for wave soldering and SMD processes

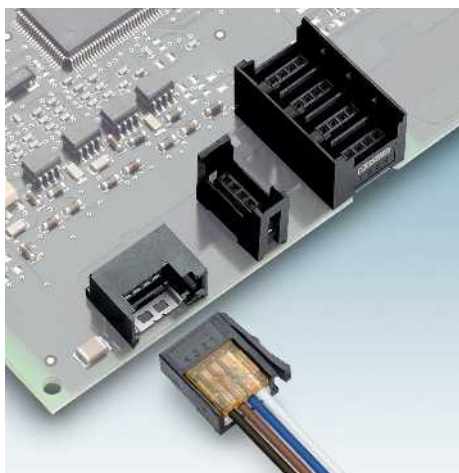

- 3-pos. and 4-pos. CIOC miniature headers for CIOC ...-M plugs
- Gold-plated contact system
- Enables space-saving installation of I/O modules and signal distributors

CIOC 4-1-FH-SMD-B

- Delivery form: Tape-on-reel packing according to IEC 60286-3, reel diameter: 380 mm, tape width: 32 mm

Notes:

In accordance with DIN EN 61984, COMBICON plug-in connectors have no switching power. During designated use, they must not be plugged in or disconnected when carrying voltage or under load.

COMBICON select

You will find the possible plug-in connector combinations in COMBICON select at: www.phoenixcontact.net/products or starting on page 48.

Technical data	
Technical data in accordance to IEC / DIN VDE	
Rated current	[A]
Rated insulation voltage for pollution degree 2	[V]
Pitch	[mm]
Insulation coordination	
Surge voltage category / pollution degree	
Rated insulation voltage	[V]
Rated surge voltage	[kV]
Approval data (UL/CUL)	Use Group
Nominal voltage	[V]
Nominal current	[A]
Connection capacity AWG	AWG
Approval data (CSA)	Use Group
Nominal voltage	[V]
Nominal current	[A]
Connection capacity AWG	AWG
Approval data (UL/CUL)	
Nominal voltage	[V]
Nominal current	[A]
Connection capacity AWG	AWG
General data	
Type of insulation material / insulation material group	
Inflammability class according to UL 94	

CIOC 4-1-FV-A			CIOC 4-4-FV			CIOC 4-1-FH-SMD-B R32		
3			3			3		
32			32			32		
2			2			2		
III / 3	III / 2	II / 2	III / 3	III / 2	II / 2	III / 3	III / 2	II / 2
32			32			32		
B	C	D	B	C	D	B	C	D
-	-	-	-	-	-	-	-	-
-	-	-	-	-	-	-	-	-
B	C	D	B	C	D	B	C	D
-	-	-	-	-	-	-	-	-
-	-	-	-	-	-	-	-	-
-	-	-	-	-	-	-	-	-
32			32			32		
3			3			3		
-			-			-		
PA / -			PA / -			LCP / IIIa		
V0			V0			V0		

No. of pos.	Dim. a [mm]
3	4.00
4	6.00

High density PCB terminal blocks and plug-in connectors

Plugs with displacement connection, 2.0 to 2.54 mm pitch



Single-row, for wave soldering processes
Plug-in direction vertical to the PCB



Four-row, for wave soldering processes
Plug-in direction vertical to the PCB



Single-row, taped, for SMD applications, plug-in direction parallel to the PCB



Dimensional drawing

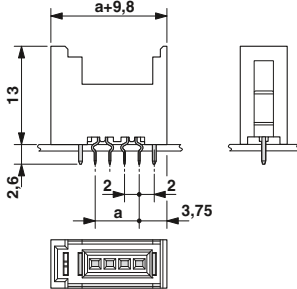

Drilling diagram

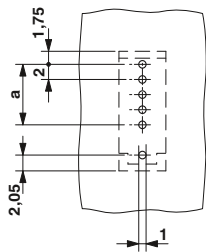

Ordering data

Type	Order No.	Pcs. / Pkt.
2 mm pitch, color: black		
CIOC 3-1-FV-A	1701551	100
CIOC 4-1-FV-A	1701388	100



Dimensional drawing

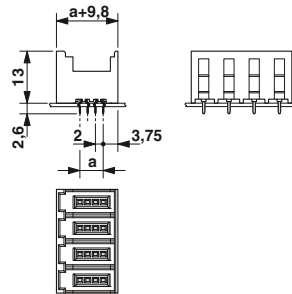

Drilling diagram

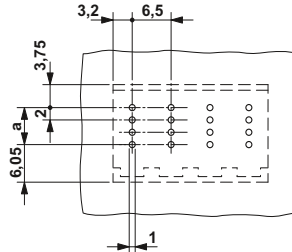

Ordering data

Type	Order No.	Pcs. / Pkt.
2 mm pitch, color: black		
CIOC 3-4-FV	1701552	50
CIOC 4-4-FV	1701401	50



Dimensional drawing

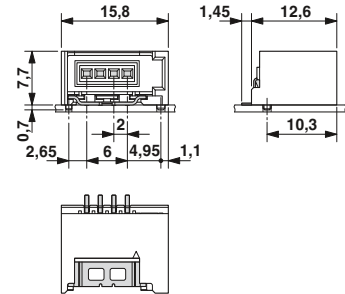

Drilling diagram

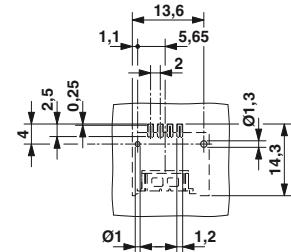

Ordering data

Type	Order No.	Pcs. / Pkt.
2 mm pitch, color: black		
CIOC 4-1-FH-SMD-B R32	1701322	400

Plugs with displacement connection, 2.0 to 2.54 mm pitch

Bus plug-in connectors up to 0.75 mm² connection cross section



- Supplementing the CIOC plug-in connector range with 4-pos. link connector with a 2.54 mm pitch
- Gold-plated contact system
- A plug-in pick-off at any point in the bus and power line can be achieved using two CIOC 4-18-LI plugs
- The CIOC 4-18-LI plug can be combined with the LIH or LIV base strips for a horizontal or vertical PCB connection

Notes:

In accordance with DIN EN 61984, COMBICON plug-in connectors have no switching power. During designated use, they must not be plugged in or disconnected when carrying voltage or under load.

COMBICON select

You will find the possible plug-in connectors combinations in COMBICON select at: www.phoenixcontact.net/products or starting on page 48.

Pick and place pads for taped THR articles usually protrude beyond the components. The PCB layout must ensure that collisions are avoided when components are assembled. Dimensional drawings of tape reels and place pads can be found online at www.phoenixcontact.net/products.

Technical data

Technical data in accordance to IEC / DIN VDE	
Rated current / conductor cross section	[A] / [mm ²]
Rated insulation voltage for pollution degree 2	[V]
Pitch	[mm]
Connection capacity	
Solid / stranded	[mm ²] / [mm ²] / AWG
Stranded with ferrules without plastic sleeve	[mm ²]
Stranded with ferrules with plastic sleeve	[mm ²]
Multi-conductor connection capacity (two conductors with the same cross section)	
Solid / stranded	[mm ²]
Stranded with ferrules without plastic sleeve	[mm ²]
Stranded with TWIN ferrule with plastic sleeve	[mm ²]
Insulation coordination	
Surge voltage category / pollution degree	
Rated insulation voltage	[V]
Rated surge voltage	[kV]
Approval data (UL/CUL)	Use Group
Nominal voltage	[V]
Nominal current	[A]
Connection capacity AWG	AWG
Approval data (CSA)	Use Group
Nominal voltage	[V]
Nominal current	[A]
Connection capacity AWG	AWG
General data	
Type of insulation material / insulation material group	
Inflammability class according to UL 94	

CIOC 4-18-LI			CIOC 4-1-LIH			CIOC 4-1-LIV					
Rated current / conductor cross section			5 / 0.75			5			5		
Rated insulation voltage for pollution degree 2			-			-			-		
Pitch			2.54			2.54			2.54		
Connection capacity											
Solid / stranded			- / - / 18 - 18			- / - / -			- / - / -		
Stranded with ferrules without plastic sleeve			-			-			-		
Stranded with ferrules with plastic sleeve			-			-			-		
Multi-conductor connection capacity (two conductors with the same cross section)											
Solid / stranded			- / -			- / -			- / -		
Stranded with ferrules without plastic sleeve			-			-			-		
Stranded with TWIN ferrule with plastic sleeve			-			-			-		
Insulation coordination											
Surge voltage category / pollution degree			III / 3 III / 2 II / 2			III / 3 III / 2 II / 2			III / 3 III / 2 II / 2		
Rated insulation voltage			160			160			160		
Rated surge voltage											
Approval data (UL/CUL)			B C D			B C D			B C D		
Nominal voltage			-			-			-		
Nominal current			-			-			-		
Connection capacity AWG			-			-			-		
Approval data (CSA)			B C D			B C D			B C D		
Nominal voltage			-			-			-		
Nominal current			-			-			-		
Connection capacity AWG			-			-			-		
General data											
Type of insulation material / insulation material group			PA/PBT / -			PBT / -			PBT / -		
Inflammability class according to UL 94			V0			V0			V0		

No. of pos.	Dim. a [mm]
4	7.62

High density PCB terminal blocks and plug-in connectors

Plugs with displacement connection, 2.0 to 2.54 mm pitch



Bus plug



Bus plug header,
plug-in direction parallel to the PCB



Bus plug header,
plug-in direction vertical to the PCB



Dimensional drawing

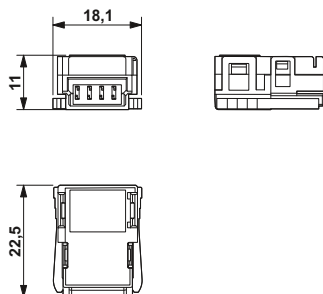

Dimensional drawing

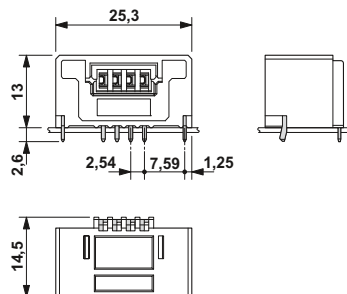

Dimensional drawing

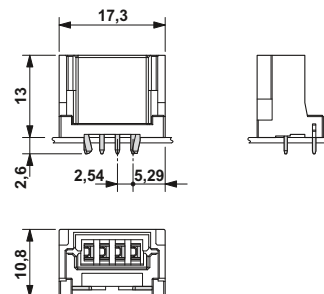

Drilling diagram

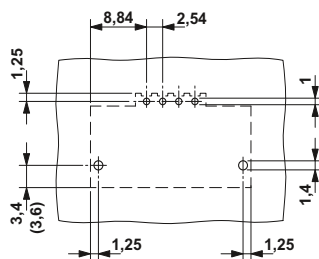

Drilling diagram

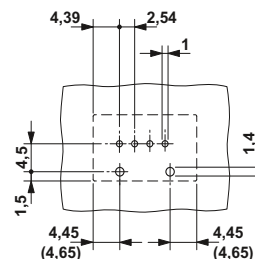

Ordering data

Type	Order No.	Pcs. / Pkt.
Color: Black		
CIOC 4-18-LI	1701359	100

Ordering data

Type	Order No.	Pcs. / Pkt.
Color: Black		
CIOC 4-1-LIH	1701362	100

Ordering data

Type	Order No.	Pcs. / Pkt.
Color: Black		
CIOC 4-1-LIV	1701375	100

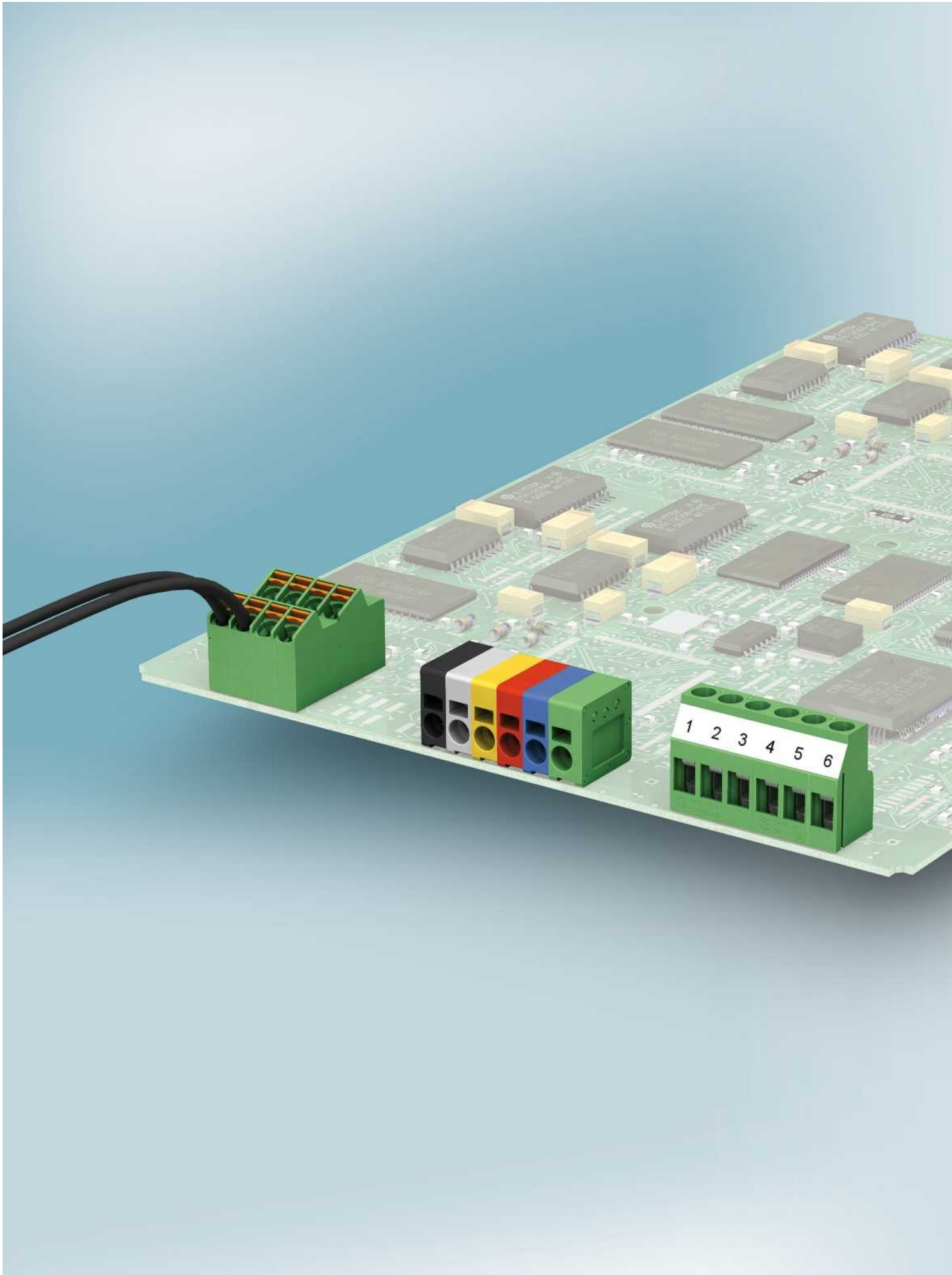

PCB terminal blocks with 2.54 to 7.62 mm pitch

The diverse applications for PCB terminal blocks in the field of measurement and control technology have resulted in a continually growing product range over the past several years, which meets the requirements of a large number of different devices and associated device specifications.

Whether using modern process interfaces or automation components through to the PLC, you will always find the right connection terminal block for your application in the PCB terminal block range.

The product range offers three connection technologies (screw, spring-cage, and insulation displacement connection). Single-level as well as double-, three-, and four-level terminal blocks are available to increase the contact density on the PCB. The screw and spring-cage versions are pin-compatible with each other. As a result, the user can choose between the two connection technologies without having to change the layout, thereby achieving a high level of flexibility in PCB production and reducing costs.

The range offers pitches from 2.54 to 7.62 mm. The terminal blocks are designed for currents up to 41 A and voltages up to 630 V (surge voltage category III/pollution degree 2). Conductor cross sections from 0.08 to 6 mm² can be connected.

When developing PCB terminal blocks, requirements for state-of-the-art production methods for electronic modules are taken into consideration. Products are available for SMT production in the form of PCB terminal blocks for through hole reflow (THR) and SMD assembly. PCB terminal blocks are available with press-in technology for solder-free processing. PCB terminal blocks that are suitable for the reflow process have high-temperature-resistant insulating housing. The various series are also available in bar or tape magazines.

Customer-specific requirements can also be taken into account when producing PCB terminal blocks. For example, the terminal blocks are available with a closed clamping space, as partially assembled versions or in various colors. Please contact us for more information.

General	72
PCB terminal blocks with screw and spring connection for the reflow process, currents up to 24 A, pitch 3.5/3.81/5.0/5.08 mm	75
Connection cross section up to 1.5 mm ²	75
Connection cross section up to 2.5 mm ²	77
SMD PCB terminal blocks with connection cross section up to 1.5 mm ²	82
PCB terminal blocks with screw connection for wave soldering processes, currents up to 24 A, pitch 2.54/3.5/3.81/5.0/5.08 mm	83
Connection cross section up to 0.5 mm ²	83
Connection cross section up to 1.5 mm ²	85
Connection cross section up to 2.5 mm ²	103
Front connection up to 2.5 mm ²	114
Single terminal blocks up to 2.5 mm ²	117
PCB terminal blocks with screw connection for wave soldering processes, currents up to 41 A, pitch 7.5/7.62 mm	119
Connection cross section up to 1.5 mm ²	119
Connection cross section up to 2.5 mm ²	123
Single terminal blocks up to 4 mm ²	127
PCB terminal blocks with spring-cage connection for wave soldering processes, currents up to 24 A, pitch 3.81/5.0/5.08 mm	129
Connection cross section up to 1.5 mm ²	129
Connection cross section up to 2.5 mm ²	135
PCB terminal blocks with push-in spring connection for wave soldering processes, currents up to 24 A, pitch 2.54/3.5/3.81/5.0/5.08/7.62 mm	137
Angled conductor connection up to 1.5 mm ²	137
Horizontal or vertical conductor connection up to 2.5 mm ²	141
With actuation rocker and connection up to 1.5 mm ²	145
Connection cross section up to 2.5 mm ²	153
PCB terminal blocks with displacement connection for wave soldering processes, currents up to 5 A, pitch 3.81	154
Connection cross section up to 0.34 mm ²	154
PCB terminal blocks with screw connection for the Ex area for wave soldering processes	157
Multi-level terminal blocks with connection up to 1.5 mm ²	157
Horizontal or vertical conductor connection up to 2.5 mm ²	158
PCB terminal blocks with spring connection for the Ex area for wave soldering processes	161
Angled conductor connection up to 2.5 mm ²	161
Horizontal or vertical conductor connection up to 2.5 mm ²	163
PCB isolating plugs	164
Flat-type fuse holders	165

PCB terminal blocks with 2.54 to 7.62 mm pitch

General

Customer-specific standard terminal blocks



PCB terminal blocks with open or closed clamping space

Customer-specific requirements and needs can be taken into account when producing PCB terminal blocks. The terminal blocks are available with a closed clamping space, as partially assembled versions and in various colors.

Standard terminal blocks with special functions



Versions with slotted-head and Phillips screws

The individual processing of PCB terminal blocks in the soldering process, and even the special features for conductor connection, are taken into account in many product ranges. Here, you can choose between slotted-head and Phillips screws, as well as various solder pin lengths. Please contact us for more information.

PCB terminal blocks with a variable number of positions

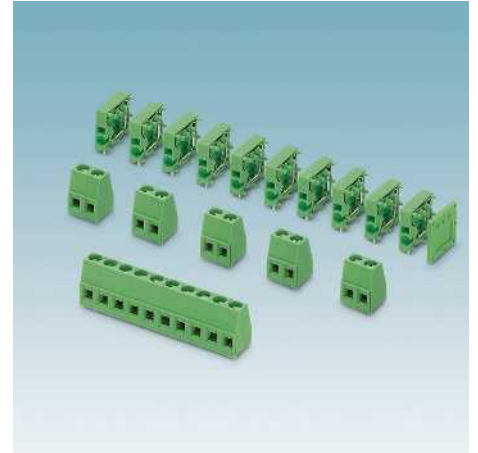

One-piece blocks and single PCB terminal blocks

PCB terminal blocks are available in three versions – as a one-piece block, as part blocks or as single terminal blocks. Part blocks can be assembled into high-position blocks using a keyway/featherkey joint. In the case of single terminal blocks, you can freely determine the number of positions for individual assembly. The row must only be interrupted if the number of positions exceeds 30, in order to compensate possible tolerances between terminal block and PCB.

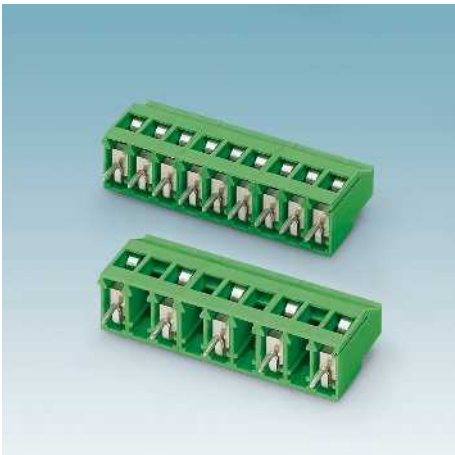

Fully or partially assembled versions



PCB terminal blocks with long or short solder pin



PCB terminal blocks with integrated test connection

Bridges



Internal bridges

Two methods are available for potential distribution or looping through the ground conductor in PCB terminal blocks. The easiest solution is a separate bridge fixed directly in the connection area, if necessary, with a supply conductor. Internally bridged versions are available in the standard MKDS product range. The entire clamping space is also available here.

Anti-rotation protection

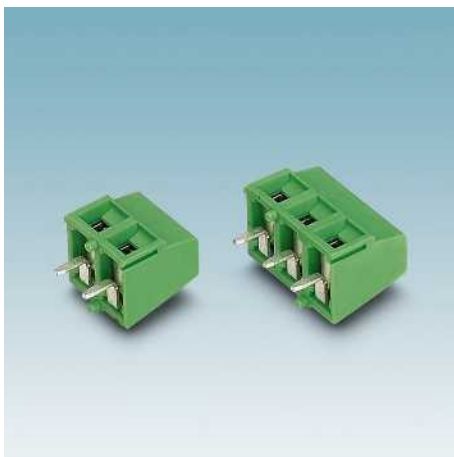

PCB terminal blocks with anti-rotation pins

2- and 3-pos. terminal blocks in particular are often subjected to high tightening torques, which cannot be absorbed by a few solder pins. Usually these terminal blocks must be supported during conductor connection.

If this is not possible, versions with additional anti-rotation pins are available for many terminal blocks.

Marking

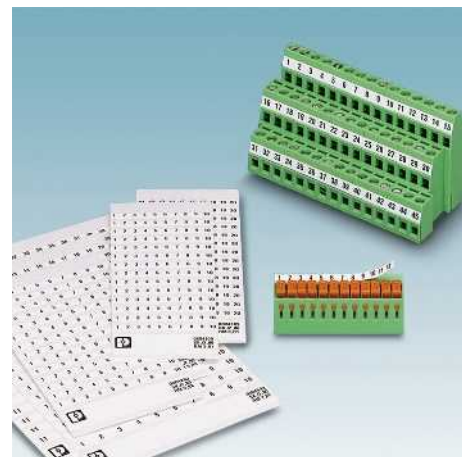

Marking with marker cards

For marking individual terminal points, marker cards (SK strips with consecutive numbers 1 - 10, 11 - 20) are available with 2.5 to 7.62 mm pitch for both single terminal blocks and multi-position PCB terminal blocks bases. Alternatively, the terminal blocks can also be supplied with individual marking.



Separate fixed bridge

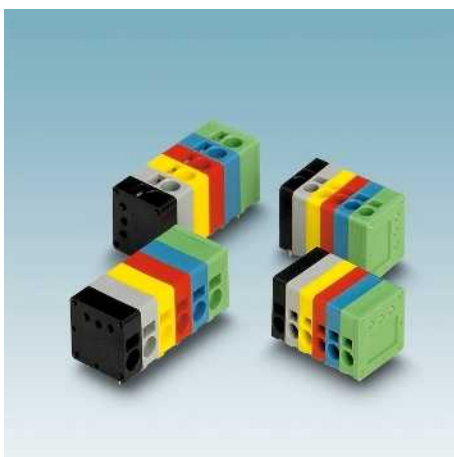

Color versions

Note:

Since the installation environment of the entire PCB cannot be influenced, the specified nominal voltage of all COMBICON PCB terminal blocks refers to the "as-delivered" state. For more detailed information on the dimensioning of air and creepage distances of PCBs, see page 849.

PCB terminal blocks with 2.54 to 7.62 mm pitch

PCB terminal blocks with screw and spring-cage connection for the reflow process, currents up to 24 A

Connection cross section of up to 1.5 mm²

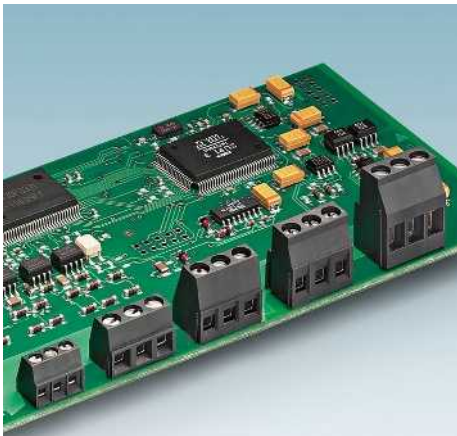

- Application in SMT reflow processes
- Standard types of PCB terminal blocks made of high-temperature resistant plastics
- Delivery form: box packaging - bulk
- Taped packaging in accordance with IEC 60286-3 for automatic assembly on request
- You can find user notes and recommendations for THR procedure on page 27

Notes:

In order to avoid tolerances between the terminal blocks and PCB, the terminal row should be interrupted when the number of positions exceeds 30.

1) Please observe the current carrying capacity curves. Further current carrying capacity curves on request.

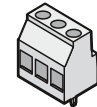

Metric 3.5 mm pitch

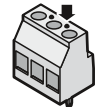

Detection lug for models with 3.81 mm inch pitch

Accessories

For all types	Type	Page
Only for MKDS 1/... HT BK		
	Screwdriver SZS 0,4 x 2,5 Order No. 1205037	
	Marker cards SK 3,5/2,8 or SK 3,81/2,8	797
Only for MKDSN 1,5/...HT BK and MKDS 1,5/...HT BK		
	Screwdriver SZS 0,6 x 3,5 Order No. 1205053	
	Insertion bridge EBP...- 5	829
	Marker cards SK 5/3,8 or SK 5,08/3,8	798

Current carrying capacity curve

Type: MKDS 1,5/...-HT BK
 Test as per DIN EN 60512-5-2:2003-01
 Reduction factor = 1
 No. of positions: 5

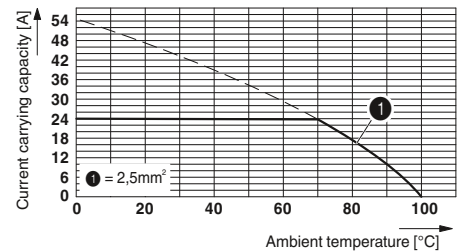

Technical data

Technical data in accordance to IEC / DIN VDE	
Rated current / conductor cross section	[A] / [mm ²]
Rated insulation voltage for pollution degree 2	[V]
Pitch	[mm]
Connection capacity	
Solid / stranded	[mm ²] / [mm ²] / AWG
Stranded with ferrules without plastic sleeve	[mm ²]
Stranded with ferrules with plastic sleeve	[mm ²]
Multi-conductor connection capacity (two conductors with the same cross section)	
Solid / stranded	[mm ²]
Insulation coordination	
Surge voltage category / pollution degree	
Rated insulation voltage	[V]
Rated surge voltage	[kV]
Approval data (UL/CUL)	Use Group
Nominal voltage	[V]
Nominal current	[A]
Connection capacity AWG	AWG
Approval data (CSA)	Use Group
Nominal voltage	[V]
Nominal current	[A]
Connection capacity AWG	AWG
General data	
Stripping length	[mm]
Screw thread	
Tightening torque	[Nm]
Type of insulation material / insulation material group	
Inflammability class according to UL 94	
Drill hole diameter / pin dimensions	[mm]

MKDS 1/ ...HT BK			MKDSN 1,5/ ... HT BK			MKDS 1,5/ ... HT BK		
13.5 ¹⁾ / 1.5			13.5 ¹⁾ / 1.5			17.5 ¹⁾ / 2.5		
200			320			320		
3.5 / 3.81			5 / 5.08			5 / 5.08		
0.14 - 1.5 / 0.14 - 1.5 / 26 - 16			0.14 - 1.5 / 0.14 - 1.5 / 26 - 16			0.14 - 2.5 / 0.14 - 1.5 / 26 - 14		
0.25 - 0.5			0.25 - 1			0.25 - 1.5		
0.25 - 0.5			0.25 - 1.5			0.25 - 1.5		
0.14 - 0.5 / 0.14 - 0.34			0.14 - 0.75 / 0.14 - 0.75			0.14 - 1 / 0.14 - 0.75		
III / 3	III / 2	II / 2	III / 3	III / 2	II / 2	III / 3	III / 2	II / 2
63	200	200	200	320	320	200	320	320
2.5	2.5	2.5	4	4	4	4	4	4
B	C	D	B	C	D	B	C	D
300	-	300	300	-	300	300	-	300
10	-	10	10	-	10	15	-	10
30 - 16	-	30 - 16	30 - 14	-	30 - 14	30 - 14	-	30 - 14
B	C	D	B	C	D	B	C	D
150	-	300	-	-	-	-	-	-
10	-	10	-	-	-	-	-	-
28 - 16	-	28 - 16	-	-	-	-	-	-
5			6			7		
M2			M3			M3		
0.22 - 0.25			0.5 - 0.6			0.5 - 0.6		
PA / IIIa			PA / IIIa			PA / IIIa		
V0			V0			V0		
1.1 / 0.5 x 0.9 mm			1.3 / 0.5 x 1 mm			1.3 / 0.9 x 0.9 mm		

No. of pos.	Dim. a [mm]
2	3.50
3	7.00
2	3.81
3	7.62
2	5.00
3	10.00
2	5.08
3	10.16



Without housing overlapping



With housing overlapping,
Low-profile design



With housing overlapping



Dimensional drawing

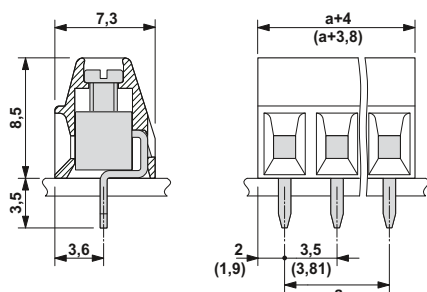

Drilling diagram

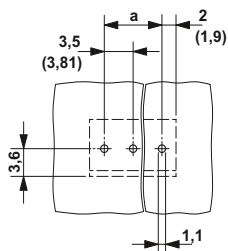

Dimensional drawing

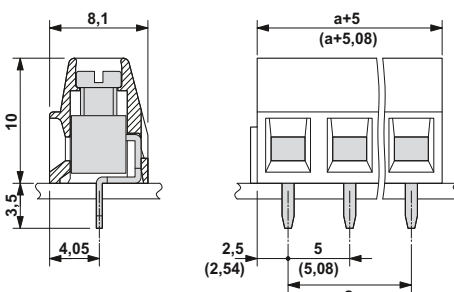

Drilling diagram

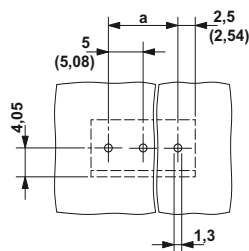

Dimensional drawing

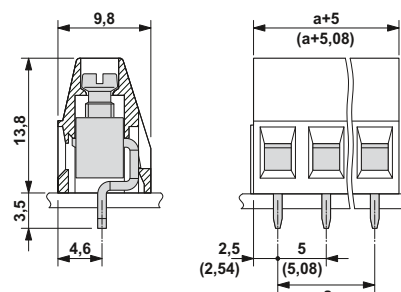

Drilling diagram

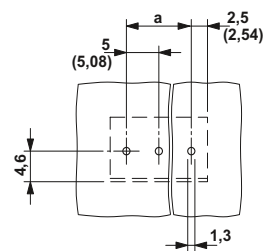

Ordering data

Type	Order No.	Pcs. / Pkt.
Pitch 3.5 mm, color: Black		
MKDS 1/ 2-3,5 HT BK	1985807	50
MKDS 1/ 3-3,5 HT BK	1984950	50
3.81 mm pitch, color: Black		
MKDS 1/ 2-3,81 HT BK	1985823	50
MKDS 1/ 3-3,81 HT BK	1985836	50

Ordering data

Type	Order No.	Pcs. / Pkt.
Pitch 5.0 mm, color: Black		
MKDSN 1,5/ 2 HT BK	1985849	50
MKDSN 1,5/ 3 HT BK	1985852	50
Headers, 5.08 mm pitch, color: Black		
MKDSN 1,5/ 2-5,08 HT BK	1985865	50
MKDSN 1,5/ 3-5,08 HT BK	1985878	50

Ordering data

Type	Order No.	Pcs. / Pkt.
Pitch 5.0 mm, color: Black		
MKDS 1,5/ 2 HT BK	1985881	50
MKDS 1,5/ 3 HT BK	1985894	50
Headers, 5.08 mm pitch, color: Black		
MKDS 1,5/ 2-5,08 HT BK	1985904	50
MKDS 1,5/ 3-5,08 HT BK	1985917	50

PCB terminal blocks with 2.54 to 7.62 mm pitch

PCB terminal blocks with screw and spring-cage connection for the reflow process, currents up to 24 A

Connection cross section of up to 2.5 mm²

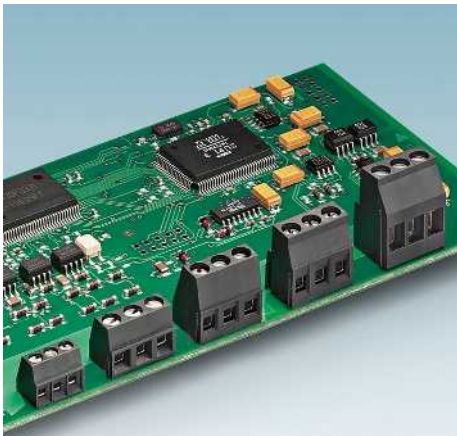

- 5.0 or 5.08 mm pitch
- Application in SMT reflow processes
- Standard types of PCB terminal blocks made of high-temperature resistant plastics
- Delivery form: box packaging - bulk
- Taped packaging in accordance with IEC 60286-3 for automatic assembly on request
- You can find user notes and recommendations for THR procedure on page 27

Notes:
 In order to avoid tolerances between the terminal blocks and PCB, the terminal row should be interrupted when the number of positions exceeds 30.
 1) Please observe the current carrying capacity curves. Further current carrying capacity curves on request.

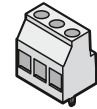

Metric 5 mm pitch

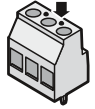

Detection lug for models with 5.08 mm inch pitch

Accessories		
For all types	Type	Page
	Screwdriver SZS 0,6 x 3,5 Order No. 1205053	
	Marker cards SK 5/3,8 or SK 5,08/3,8	798
	Insertion bridge EBP...- 5	829

Current carrying capacity curve

Type: MKDS 3/...HT BK
 Test following DIN EN 60512-5-2:2003-01
 Reduction factor = 1
 No. of positions: 5

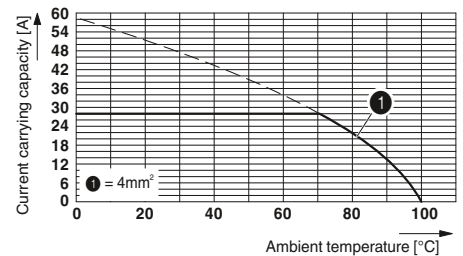

Technical data

Technical data in accordance to IEC / DIN VDE	
Rated current / conductor cross section	[A] / [mm ²]
Rated insulation voltage for pollution degree 2	[V]
Pitch	[mm]
Connection capacity	
Solid / stranded	[mm ²] / [mm ²] / AWG
Stranded with ferrules without plastic sleeve	[mm ²]
Stranded with ferrules with plastic sleeve	[mm ²]
Multi-conductor connection capacity (two conductors with the same cross section)	
Solid / stranded	[mm ²]
Stranded with ferrules without plastic sleeve	[mm ²]
Stranded with TWIN ferrule with plastic sleeve	[mm ²]
Insulation coordination	
Surge voltage category / pollution degree	
Rated insulation voltage	[V]
Rated surge voltage	[kV]
Approval data (UL/CUL)	Use Group
Nominal voltage	[V]
Nominal current	[A]
Connection capacity AWG	AWG
Approval data (CSA)	Use Group
Nominal voltage	[V]
Nominal current	[A]
Connection capacity AWG	AWG
General data	
Stripping length	[mm]
Screw thread	
Tightening torque	[Nm]
Type of insulation material / insulation material group	
Inflammability class according to UL 94	
Drill hole diameter / pin dimensions	[mm]

MKDSN 2,5/ ... HT BK

16 ¹⁾ / 2.5		
320		
5 / 5.08		
0.2 - 2.5 / 0.2 - 2.5 / 24 - 14		
0.25 - 2.5		
0.25 - 2.5		
0.2 - 0.75 / 0.2 - 0.75		
0.25 - 0.75		
0.5 - 1.5		
III / 3	III / 2	II / 2
200	320	320
4	4	4
B	C	D
300	-	300
20	-	15
30 - 12	-	30 - 12
B	C	D
-	-	-
-	-	-
-	-	-
-	-	-
6.5	8	
M3	M3	
0.5 - 0.6	0.5 - 0.6	
PA / IIIa	PA / IIIa	
V0	V0	
1.3 / 0.8 x 0.9 mm	1.3 / 0.9 x 0.9 mm	

MKDS 3/ ... HT BK

24 ¹⁾ / 4		
320		
5 / 5.08		
0.2 - 4 / 0.2 - 2.5 / 24 - 12		
0.25 - 2.5		
0.25 - 1.5		
0.2 - 1.5 / 0.2 - 1.5		
0.25 - 0.75		
0.5 - 1.5		
III / 3	III / 2	II / 2
200	320	320
4	4	4
B	C	D
300	-	300
15	-	10
30 - 12	-	30 - 12
B	C	D
-	-	-
10	-	10
-	-	-
28 - 12	-	28 - 12
8	M3	
0.5 - 0.6	0.5 - 0.6	
PA / IIIa	PA / IIIa	
V0	V0	
1.3 / 0.9 x 0.9 mm	1.3 / 0.9 x 0.9 mm	

ZFKDS 2,5-5,08 THT

24 ¹⁾ / 4		
320		
5.08		
0.2 - 4 / 0.2 - 2.5 / 24 - 12		
0.25 - 2.5		
0.25 - 1.5		
- / -		
-		
-		
III / 3	III / 2	II / 2
200	320	320
4	4	4
B	C	D
250	-	300
10	-	10
26 - 12	-	26 - 12
B	C	D
-	-	-
-	-	-
-	-	-
7	-	
-	-	
-	-	
PA / IIIa	PA / IIIa	
V0	V0	
1.3 / 0.8 x 0.8 mm	1.3 / 0.8 x 0.8 mm	

No. of pos.	Dim. a [mm]
2	5.00
3	10.00
1	
2	5.08
3	10.16
1	
1	



With screw connection and housing overlapping, low-profile design



With screw connection and housing overlapping

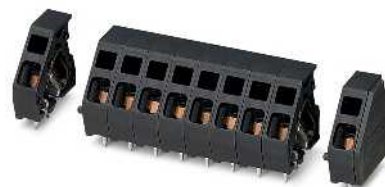

With spring-cage connection and two solder pins, modular design



Dimensional drawing

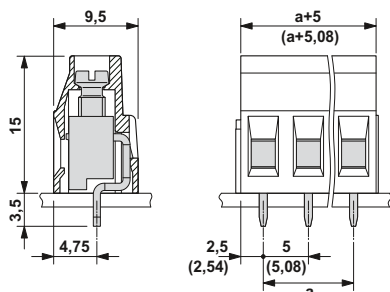

Drilling diagram

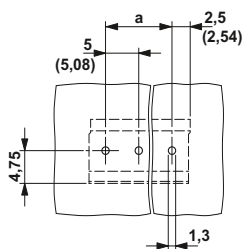

Dimensional drawing

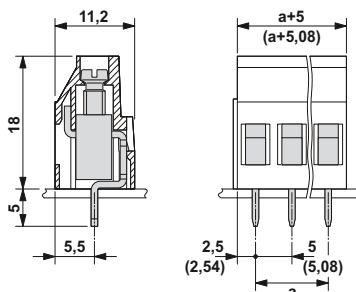

Drilling diagram

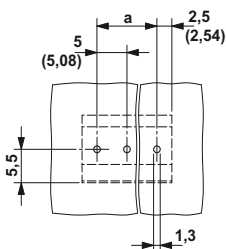

Dimensional drawing

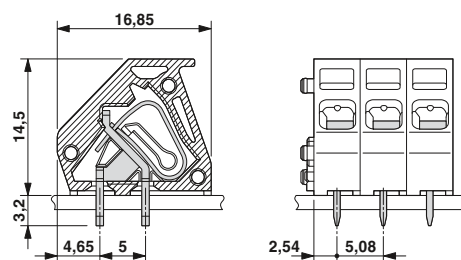

Drilling diagram

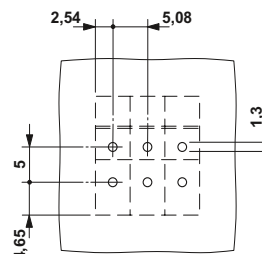

Ordering data

Type	Order No.	Pcs. / Pkt.
Pitch 5.0 mm, color: Black		
MKDSN 2,5/ 2 HT BK	1985920	50
MKDSN 2,5/ 3 HT BK	1985933	50
Headers, 5.08 mm pitch, color: Black		
MKDSN 2,5/ 2-5,08 HT BK	1985946	50
MKDSN 2,5/ 3-5,08 HT BK	1985959	50

Ordering data

Type	Order No.	Pcs. / Pkt.
Pitch 5.0 mm, color: Black		
MKDS 3/ 2 HT BK	1985962	50
MKDS 3/ 3 HT BK	1985975	50
Headers, 5.08 mm pitch, color: Black		
MKDS 3/ 2-5,08 HT BK	1985988	50
MKDS 3/ 3-5,08 HT BK	1985991	50

Ordering data

Type	Order No.	Pcs. / Pkt.
Headers, 5.08 mm pitch, color: Black		
ZFKDS 2,5-5,08 THT	1990245	50
End terminal block, 5.08 mm wide, necessary at the end of a row of terminal blocks (left), if a smooth side element is desired		
ZFKDS 2,5-5,08 L THT	1990261	50
End terminal block, 6.08 mm wide, necessary at the end of a row of terminal blocks (right)		
ZFKDSA 2,5-6,08 R THT	1990258	50

PCB terminal blocks with 2.54 to 7.62 mm pitch

PCB terminal blocks with push-in spring connection for the reflow process, currents up to 13.5 A

Horizontal or vertical conductor connection up to 1.5 mm²

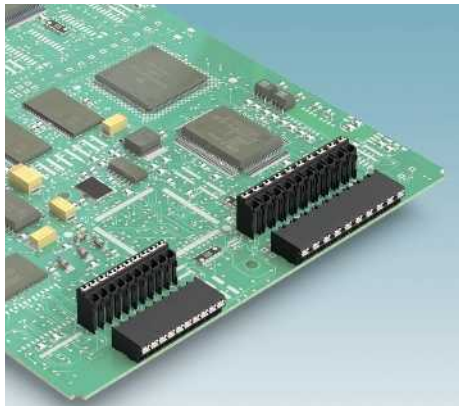

- Push-in direct plug-in technology for solid or stranded conductors
- Suitable for use in SMT reflow processes
- Horizontal and vertical design with 3.5 mm and 3.81 mm pitch
- Two solder pins for a high level of stability on the PCB
- Standard pin length of 2.6 mm also suitable for wave soldering processes
- Supplied in tape-on-reel packing according to IEC 60286-3 for automated mounting in the reflow process with pin length of 2.0 mm

Notes:

Pick and place pads for taped THR articles usually protrude beyond the components. The PCB layout must ensure that collisions are avoided when components are assembled. Dimensional drawings of tape reels and place pads can be found online at www.phoenixcontact.net/products.

1) Current carrying capacity curve upon request.



2) UL/CUL on request.

N



Pin length of 2.6 mm, box-packaged PCB terminal blocks, connection direction horizontal to the PCB

Accessories

For all types	Type	Page
	Screwdriver SZS 0,4 x 2,5 Order No. 1205037	
	Ferrules with and without plastic sleeve	834
	Crimping pliers for 0.25 to 6 mm ² CRIMPFOX 6 Order No. 1212034	

Dimensional drawing

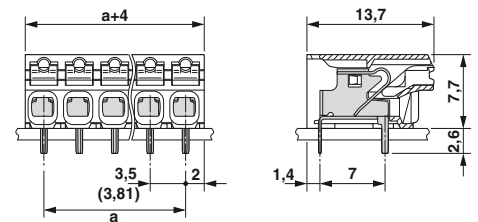

Drilling diagram

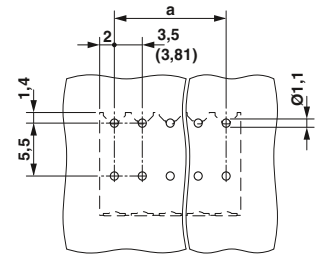

Technical data

Technical data in accordance to IEC / DIN VDE	
Rated current / conductor cross section	[A] / [mm ²]
Rated insulation voltage for pollution degree 2	[V]
Pitch	[mm]
Connection capacity	
Solid / stranded	[mm ²] / [mm ²] / AWG
Stranded with ferrules without plastic sleeve	[mm ²]
Stranded with ferrules with plastic sleeve	[mm ²]
Multi-conductor connection capacity (two conductors with the same cross section)	
Solid / stranded	[mm ²]
Stranded with ferrules without plastic sleeve	[mm ²]
Stranded with TWIN ferrule with plastic sleeve	[mm ²]
Insulation coordination	
Surge voltage category / pollution degree	III / 3 III / 2 II / 2
Rated insulation voltage	[V]
Rated surge voltage	[kV]
Approval data (UL/CUL)	Use Group
Nominal voltage	[V]
Nominal current	[A]
Connection capacity AWG	AWG
Approval data (CSA)	Use Group
Nominal voltage	[V]
Nominal current	[A]
Connection capacity AWG	AWG
General data	
Stripping length	[mm]
Type of insulation material / insulation material group	
Inflammability class according to UL 94	
Drill hole diameter / pin dimensions	[mm]

	13.5 ¹⁾ / 1.5
	160
	3.5 / 3.81
	0.2 - 1.5 / 0.2 - 1.5 / 24 - 16
	0.2 - 1.5
	0.2 - 0.75
	- / -
	-
	-
	III / 3 III / 2 II / 2
	160 160 320
	2.5 2.5 2.5
	B C D
	- - -
	- - -
	B C D
	- - -
	- - -
	- - -
	8
	LCP / IIIa
	V0
	1.1 / 0.7 x 0.3

No. of pos.	Dim. a [mm]
2	3.50
3	7.00
4	10.50
5	14.00
6	17.50
7	21.00
8	24.50
9	28.00
10	31.50
11	35.00
12	38.50

Ordering data

Type	Order No.	Pcs. / Pkt.
Pitch 3.5 mm, color: Black		
SPT-THR 1,5/ 2-H-3,5 P26	1822752	370
SPT-THR 1,5/ 3-H-3,5 P26	1822765	240
SPT-THR 1,5/ 4-H-3,5 P26	1822778	170
SPT-THR 1,5/ 5-H-3,5 P26	1822781	150
SPT-THR 1,5/ 6-H-3,5 P26	1822794	130
SPT-THR 1,5/ 7-H-3,5 P26	1822804	110
SPT-THR 1,5/ 8-H-3,5 P26	1822817	80
SPT-THR 1,5/ 9-H-3,5 P26	1822820	80
SPT-THR 1,5/10-H-3,5 P26	1822833	60
SPT-THR 1,5/11-H-3,5 P26	1822846	60
SPT-THR 1,5/12-H-3,5 P26	1822859	60
3.81 mm pitch, color: Black		
SPT-THR 1,5/ 2-H-3,81 P26	1822862	350
SPT-THR 1,5/ 3-H-3,81 P26	1822875	240
SPT-THR 1,5/ 4-H-3,81 P26	1822888	170
SPT-THR 1,5/ 5-H-3,81 P26	1822891	130
SPT-THR 1,5/ 6-H-3,81 P26	1822901	110
SPT-THR 1,5/ 7-H-3,81 P26	1822914	80
SPT-THR 1,5/ 8-H-3,81 P26	1822927	80
SPT-THR 1,5/ 9-H-3,81 P26	1822930	60
SPT-THR 1,5/10-H-3,81 P26	1822943	60
SPT-THR 1,5/11-H-3,81 P26	1822956	60
SPT-THR 1,5/12-H-3,81 P26	1822969	60

PCB terminal blocks with push-in spring connection for the reflow process, currents up to 13.5 A

N



Pin length of 2.6 mm, box-packaged PCB terminal blocks, connection direction vertical to the PCB

N



Pin length of 2.0 mm, taped PCB terminal blocks, connection direction horizontal to the PCB

N



Pin length of 2.0 mm, taped PCB terminal blocks, connection direction vertical to the PCB

Dimensional drawing

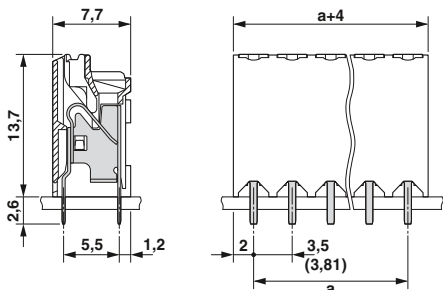

Drilling diagram

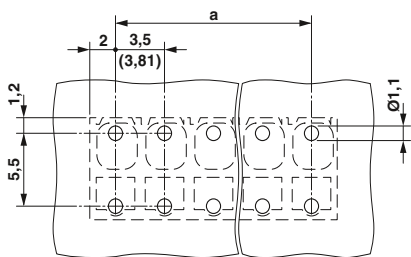

Dimensional drawing

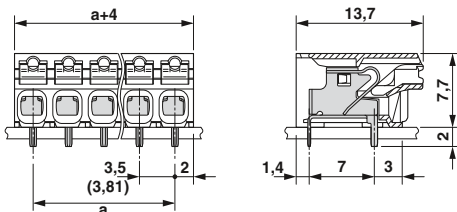

Drilling diagram

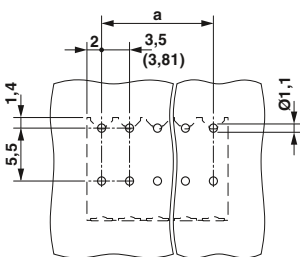

Dimensional drawing

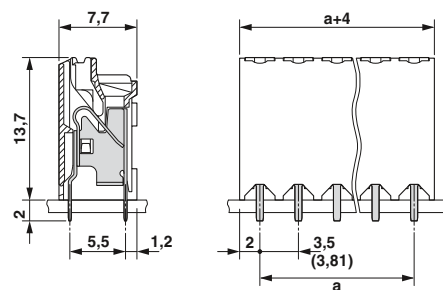

Drilling diagram

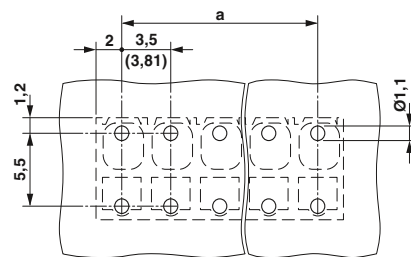

Ordering data

Type	Order No.	Pcs. / Pkt.
Pitch 3.5 mm, color: Black		
SPT-THR 1,5/ 2-V-3,5 P26	1822312	540
SPT-THR 1,5/ 3-V-3,5 P26	1822325	350
SPT-THR 1,5/ 4-V-3,5 P26	1822338	250
SPT-THR 1,5/ 5-V-3,5 P26	1822341	220
SPT-THR 1,5/ 6-V-3,5 P26	1822354	190
SPT-THR 1,5/ 7-V-3,5 P26	1822367	160
SPT-THR 1,5/ 8-V-3,5 P26	1822370	120
SPT-THR 1,5/ 9-V-3,5 P26	1822383	120
SPT-THR 1,5/10-V-3,5 P26	1822396	90
SPT-THR 1,5/11-V-3,5 P26	1822406	90
SPT-THR 1,5/12-V-3,5 P26	1822419	90
3.81 mm pitch, color: Black		
SPT-THR 1,5/ 2-V-3,81 P26	1822422	510
SPT-THR 1,5/ 3-V-3,81 P26	1822435	350
SPT-THR 1,5/ 4-V-3,81 P26	1822448	250
SPT-THR 1,5/ 5-V-3,81 P26	1822451	190
SPT-THR 1,5/ 6-V-3,81 P26	1822464	160
SPT-THR 1,5/ 7-V-3,81 P26	1822477	120
SPT-THR 1,5/ 8-V-3,81 P26	1822480	120
SPT-THR 1,5/ 9-V-3,81 P26	1822493	90
SPT-THR 1,5/10-V-3,81 P26	1822503	90
SPT-THR 1,5/11-V-3,81 P26	1822516	90
SPT-THR 1,5/12-V-3,81 P26	1822529	60

Ordering data

Type	Order No.	Pcs. / Pkt.
Pitch 3.5 mm, color: Black		
SPT-THR 1,5/ 2-H-3,5 P20 R24	1823638	250
SPT-THR 1,5/ 3-H-3,5 P20 R32	1823641	250
SPT-THR 1,5/ 4-H-3,5 P20 R32	1823654	250
SPT-THR 1,5/ 5-H-3,5 P20 R32	1823667	250
SPT-THR 1,5/ 6-H-3,5 P20 R44	1823670	250
SPT-THR 1,5/ 7-H-3,5 P20 R44	1823683	250
SPT-THR 1,5/ 8-H-3,5 P20 R44	1823696	250
SPT-THR 1,5/ 9-H-3,5 P20 R72	1823706	250
SPT-THR 1,5/10-H-3,5 P20 R72	1823719	250
SPT-THR 1,5/11-H-3,5 P20 R72	1823722	250
SPT-THR 1,5/12-H-3,5 P20 R72	1823735	250
3.81 mm pitch, color: Black		
SPT-THR 1,5/ 2-H-3,81 P20 R24	1823748	250
SPT-THR 1,5/ 3-H-3,81 P20 R32	1823751	250
SPT-THR 1,5/ 4-H-3,81 P20 R32	1823764	250
SPT-THR 1,5/ 5-H-3,81 P20 R32	1823777	250
SPT-THR 1,5/ 6-H-3,81 P20 R44	1823780	250
SPT-THR 1,5/ 7-H-3,81 P20 R44	1823793	250
SPT-THR 1,5/ 8-H-3,81 P20 R44	1823803	250
SPT-THR 1,5/ 9-H-3,81 P20 R72	1823816	250
SPT-THR 1,5/10-H-3,81 P20 R72	1823829	250
SPT-THR 1,5/11-H-3,81 P20 R72	1823832	250
SPT-THR 1,5/12-H-3,81 P20 R72	1823845	250

Ordering data

Type	Order No.	Pcs. / Pkt.
Pitch 3.5 mm, color: Black		
SPT-THR 1,5/ 2-V-3,5 P20 R24	1823191	180
SPT-THR 1,5/ 3-V-3,5 P20 R24	1823201	180
SPT-THR 1,5/ 4-V-3,5 P20 R44	1823214	180
SPT-THR 1,5/ 5-V-3,5 P20 R44	1823227	180
SPT-THR 1,5/ 6-V-3,5 P20 R44	1823230	180
SPT-THR 1,5/ 7-V-3,5 P20 R44	1823243	180
SPT-THR 1,5/ 8-V-3,5 P20 R72	1823256	180
SPT-THR 1,5/ 9-V-3,5 P20 R72	1823269	180
SPT-THR 1,5/10-V-3,5 P20 R72	1823272	180
SPT-THR 1,5/11-V-3,5 P20 R72	1823285	180
SPT-THR 1,5/12-V-3,5 P20 R72	1823298	180
3.81 mm pitch, color: Black		
SPT-THR 1,5/ 2-V-3,81 P20 R24	1823308	180
SPT-THR 1,5/ 3-V-3,81 P20 R24	1823311	180
SPT-THR 1,5/ 4-V-3,81 P20 R44	1823324	180
SPT-THR 1,5/ 5-V-3,81 P20 R44	1823337	180
SPT-THR 1,5/ 6-V-3,81 P20 R44	1823340	180
SPT-THR 1,5/ 7-V-3,81 P20 R44	1823353	180
SPT-THR 1,5/ 8-V-3,81 P20 R72	1823366	180
SPT-THR 1,5/ 9-V-3,81 P20 R72	1823379	180
SPT-THR 1,5/10-V-3,81 P20 R72	1823382	180
SPT-THR 1,5/11-V-3,81 P20 R72	1823395	180
SPT-THR 1,5/12-V-3,81 P20 R72	1823405	180

PCB terminal blocks with 2.54 to 7.62 mm pitch

PCB terminal blocks with push-in spring connection for the reflow process, currents up to 13.5 A

Horizontal and vertical conductor connection up to 1.5 mm²

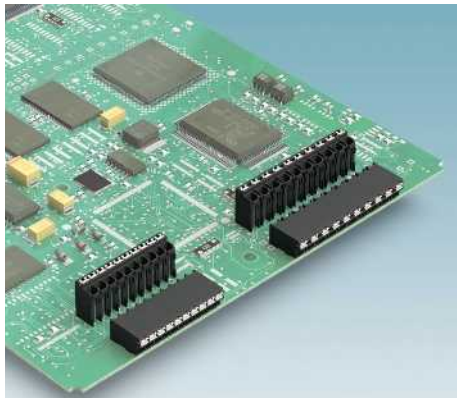

- Push-in direct plug-in technology for solid or stranded conductors
- Suitable for use in SMT reflow processes
- Horizontal and vertical design with 5.0 mm and 5.08 mm pitch
- Two solder pins for a high level of stability on the PCB
- Standard pin length of 2.6 mm also suitable for wave soldering processes
- Supplied in tape-on-reel packing according to IEC 60286-3 for automated mounting in the reflow process with pin length of 2.0 mm

Notes:

Pick and place pads for taped THR articles usually protrude beyond the components. The PCB layout must ensure that collisions are avoided when components are assembled. Dimensional drawings of tape reels and place pads can be found online at www.phoenixcontact.net/products.

1) Current carrying capacity curve upon request.



2) UL/CUL on request.

N



Pin length of 2.6 mm, box-packaged PCB terminal blocks, connection direction horizontal to the PCB

Accessories

For all types	Type	Page
	Screwdriver SZS 0,4 x 2,5 Order No. 1205037	
	Ferrules with and without plastic sleeve	834
	Crimping pliers for 0.25 to 6 mm ² CRIMPTFOX 6 Order No. 1212034	

Dimensional drawing

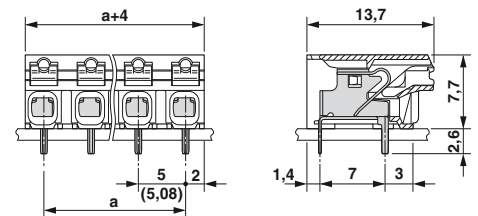

Drilling diagram

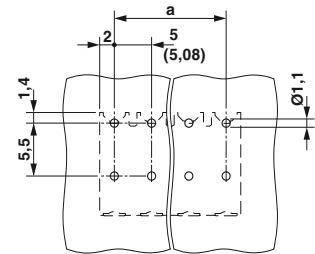

Technical data

Technical data in accordance to IEC / DIN VDE	
Rated current / conductor cross section	[A] / [mm ²]
Rated insulation voltage for pollution degree 2	[V]
Pitch	[mm]
Connection capacity	
Solid / stranded	[mm ²] / [mm ²] / AWG
Stranded with ferrules without plastic sleeve	[mm ²]
Stranded with ferrules with plastic sleeve	[mm ²]
Multi-conductor connection capacity (two conductors with the same cross section)	
Solid / stranded	[mm ²]
Stranded with ferrules without plastic sleeve	[mm ²]
Stranded with TWIN ferrule with plastic sleeve	[mm ²]
Insulation coordination	
Surge voltage category / pollution degree	III / 3 III / 2 II / 2
Rated insulation voltage	[V]
Rated surge voltage	[kV]
Approval data (UL/CUL)	Use Group B C D
Nominal voltage	[V]
Nominal current	[A]
Connection capacity AWG	AWG
Approval data (CSA)	Use Group B C D
Nominal voltage	[V]
Nominal current	[A]
Connection capacity AWG	AWG
General data	
Stripping length	[mm]
Type of insulation material / insulation material group	LCP / IIIa
Inflammability class according to UL 94	V0
Drill hole diameter / pin dimensions	[mm]

13.5 ¹⁾ / 1.5		
320		
5 / 5.08		
0.2 - 1.5 / 0.2 - 1.5 / 24 - 16		
0.2 - 1.5		
0.2 - 0.75		
- / -		
-		
-		
III / 3	III / 2	II / 2
250	320	500
4	4	4
B	C	D
-	-	-
-	-	-
-	-	-
B	C	D
-	-	-
-	-	-
-	-	-
-	-	-
8		
LCP / IIIa		
V0		
1.1 / 0.7 x 0.3 mm		

No. of pos.	Dim. a [mm]
2	5.00
3	10.00
4	15.00
5	20.00
6	25.00
7	30.00
8	35.00
9	40.00
10	45.00
11	50.00
12	55.00

Ordering data

Type	Order No.	Pcs. / Pkt.
Pitch 5.0 mm, color: Black		
SPT-THR 1,5/ 2-H-5,0 P26	1822972	300
SPT-THR 1,5/ 3-H-5,0 P26	1822985	190
SPT-THR 1,5/ 4-H-5,0 P26	1822998	130
SPT-THR 1,5/ 5-H-5,0 P26	1823007	110
SPT-THR 1,5/ 6-H-5,0 P26	1823010	80
SPT-THR 1,5/ 7-H-5,0 P26	1823023	60
SPT-THR 1,5/ 8-H-5,0 P26	1823036	60
SPT-THR 1,5/ 9-H-5,0 P26	1823049	40
SPT-THR 1,5/10-H-5,0 P26	1823052	40
SPT-THR 1,5/11-H-5,0 P26	1823065	40
SPT-THR 1,5/12-H-5,0 P26	1823078	40
Headers, 5.08 mm pitch, color: Black		
SPT-THR 1,5/ 2-H-5,08 P26	1823081	300
SPT-THR 1,5/ 3-H-5,08 P26	1823094	190
SPT-THR 1,5/ 4-H-5,08 P26	1823104	130
SPT-THR 1,5/ 5-H-5,08 P26	1823117	110
SPT-THR 1,5/ 6-H-5,08 P26	1823120	80
SPT-THR 1,5/ 7-H-5,08 P26	1823133	60
SPT-THR 1,5/ 8-H-5,08 P26	1823146	60
SPT-THR 1,5/ 9-H-5,08 P26	1823159	40
SPT-THR 1,5/10-H-5,08 P26	1823162	40
SPT-THR 1,5/11-H-5,08 P26	1823175	40
SPT-THR 1,5/12-H-5,08 P26	1823188	40

PCB terminal blocks with push-in spring connection for the reflow process, currents up to 13.5 A

N



Pin length of 2.6 mm, box-packaged PCB terminal blocks, connection direction vertical to the PCB

N



Pin length of 2.0 mm, taped PCB terminal blocks, connection direction horizontal to the PCB

N



Pin length of 2.0 mm, taped PCB terminal blocks, connection direction vertical to the PCB

Dimensional drawing

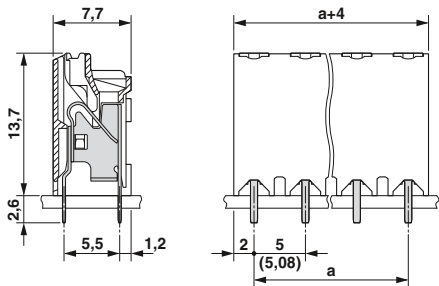

Dimensional drawing

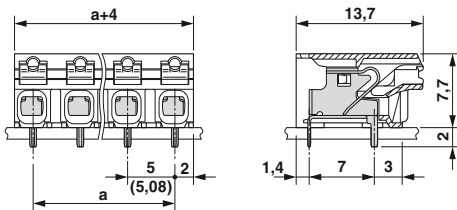

Dimensional drawing

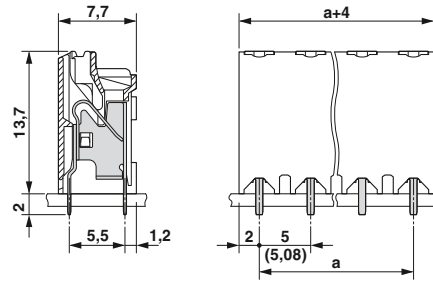

Drilling diagram

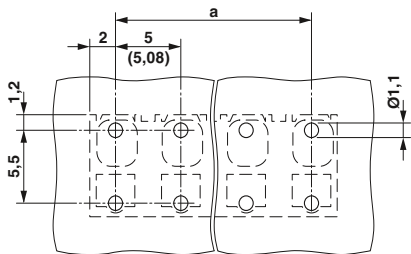

Drilling diagram

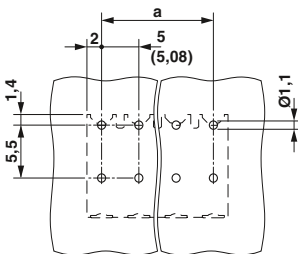

Drilling diagram

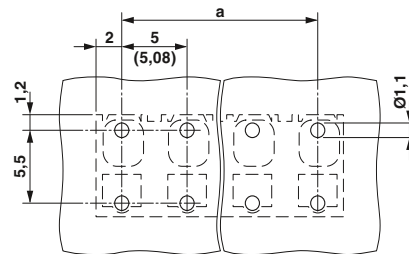

Ordering data

Type	Order No.	Pcs. / Pkt.
Pitch 5.0 mm, color: Black		
SPT-THR 1,5/ 2-V-5,0 P26	1822532	440
SPT-THR 1,5/ 3-V-5,0 P26	1822545	280
SPT-THR 1,5/ 4-V-5,0 P26	1822558	190
SPT-THR 1,5/ 5-V-5,0 P26	1822561	160
SPT-THR 1,5/ 6-V-5,0 P26	1822574	120
SPT-THR 1,5/ 7-V-5,0 P26	1822587	90
SPT-THR 1,5/ 8-V-5,0 P26	1822590	90
SPT-THR 1,5/ 9-V-5,0 P26	1822600	60
SPT-THR 1,5/10-V-5,0 P26	1822613	60
SPT-THR 1,5/11-V-5,0 P26	1822626	60
SPT-THR 1,5/12-V-5,0 P26	1822639	60
Headers, 5.08 mm pitch, color: Black		
SPT-THR 1,5/ 2-V-5,08 P26	1822642	440
SPT-THR 1,5/ 3-V-5,08 P26	1822655	280
SPT-THR 1,5/ 4-V-5,08 P26	1822668	190
SPT-THR 1,5/ 5-V-5,08 P26	1822671	160
SPT-THR 1,5/ 6-V-5,08 P26	1822684	120
SPT-THR 1,5/ 7-V-5,08 P26	1822697	90
SPT-THR 1,5/ 8-V-5,08 P26	1822707	90
SPT-THR 1,5/ 9-V-5,08 P26	1822710	60
SPT-THR 1,5/10-V-5,08 P26	1822723	60
SPT-THR 1,5/11-V-5,08 P26	1822736	60
SPT-THR 1,5/12-V-5,08 P26	1822749	60

Ordering data

Type	Order No.	Pcs. / Pkt.
Pitch 5.0 mm, color: Black		
SPT-THR 1,5/ 2-H-5,0 P20 R24	1823858	250
SPT-THR 1,5/ 3-H-5,0 P20 R32	1823861	250
SPT-THR 1,5/ 4-H-5,0 P20 R32	1823874	250
SPT-THR 1,5/ 5-H-5,0 P20 R56	1823887	250
SPT-THR 1,5/ 6-H-5,0 P20 R56	1823890	250
SPT-THR 1,5/ 7-H-5,0 P20 R56	1823900	250
SPT-THR 1,5/ 8-H-5,0 P20 R56	1823913	250
SPT-THR 1,5/ 9-H-5,0 P20 R88	1823926	250
SPT-THR 1,5/10-H-5,0 P20 R88	1823939	250
SPT-THR 1,5/11-H-5,0 P20 R88	1823942	250
SPT-THR 1,5/12-H-5,0 P20 R88	1823955	250
Headers, 5.08 mm pitch, color: Black		
SPT-THR 1,5/ 2-H-5,08 P20 R24	1823968	250
SPT-THR 1,5/ 3-H-5,08 P20 R32	1823971	250
SPT-THR 1,5/ 4-H-5,08 P20 R32	1823984	250
SPT-THR 1,5/ 5-H-5,08 P20 R56	1823997	250
SPT-THR 1,5/ 6-H-5,08 P20 R56	1824006	250
SPT-THR 1,5/ 7-H-5,08 P20 R56	1824019	250
SPT-THR 1,5/ 8-H-5,08 P20 R56	1824022	250
SPT-THR 1,5/ 9-H-5,08 P20 R88	1824035	250
SPT-THR 1,5/10-H-5,08 P20 R88	1824048	250
SPT-THR 1,5/11-H-5,08 P20 R88	1824051	250
SPT-THR 1,5/12-H-5,08 P20 R88	1824064	250

Ordering data

Type	Order No.	Pcs. / Pkt.
Pitch 5.0 mm, color: Black		
SPT-THR 1,5/ 2-V-5,0 P20 R24	1823418	180
SPT-THR 1,5/ 3-V-5,0 P20 R32	1823421	180
SPT-THR 1,5/ 4-V-5,0 P20 R56	1823434	180
SPT-THR 1,5/ 5-V-5,0 P20 R56	1823447	180
SPT-THR 1,5/ 6-V-5,0 P20 R56	1823450	180
SPT-THR 1,5/ 7-V-5,0 P20 R56	1823463	180
SPT-THR 1,5/ 8-V-5,0 P20 R88	1823476	180
SPT-THR 1,5/ 9-V-5,0 P20 R88	1823489	180
SPT-THR 1,5/10-V-5,0 P20 R88	1823492	180
SPT-THR 1,5/11-V-5,0 P20 R88	1823502	180
SPT-THR 1,5/12-V-5,0 P20 R88	1823515	180
Headers, 5.08 mm pitch, color: Black		
SPT-THR 1,5/ 2-V-5,08 P20 R24	1823528	180
SPT-THR 1,5/ 3-V-5,08 P20 R32	1823531	180
SPT-THR 1,5/ 4-V-5,08 P20 R56	1823544	180
SPT-THR 1,5/ 5-V-5,08 P20 R56	1823557	180
SPT-THR 1,5/ 6-V-5,08 P20 R56	1823560	180
SPT-THR 1,5/ 7-V-5,08 P20 R56	1823573	180
SPT-THR 1,5/ 8-V-5,08 P20 R88	1823586	180
SPT-THR 1,5/ 9-V-5,08 P20 R88	1823599	180
SPT-THR 1,5/10-V-5,08 P20 R88	1823609	180
SPT-THR 1,5/11-V-5,08 P20 R88	1823612	180
SPT-THR 1,5/12-V-5,08 P20 R88	1823625	180

PCB terminal blocks with 2.54 to 7.62 mm pitch

PCB terminal blocks with screw connection for the reflow process, currents of up to 24 A

SMD PCB terminal blocks with a connection cross section of up to 1.5 mm²



- Application in SMT reflow processes
- Standard types of PCB terminal blocks made of high-temperature resistant plastics
- Type of packing: tube magazine
- Box packaging or tape-on-reel packing in accordance with IEC 60286-3 for automatic assembly on request
- You can find user notes and recommendations for THR procedure on page 27



Notes:
B 2.2 x 6.5, ISO 7049/DIN ISO 7049 fixing screw is supplied as standard. Insertion hole: 2.6 mm, soldering tag: 2.5 x 1.2 mm
When ordering, please note the number of pieces per unit pack. For production reasons, only fully filled tube magazines can be supplied.
1) Current carrying capacity curve upon request.



Without housing overlapping, delivery form: tube magazine



Accessories

For all types	Type	Page
	Screwdriver SZS 0,4 x 2,5 Order No. 1205037	
	Marker cards SK 3,81/2,8	797

Dimensional drawing

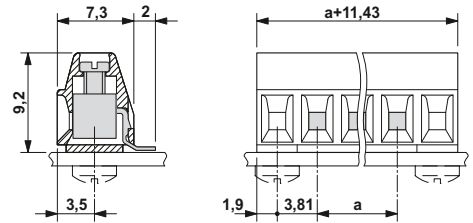

Drilling diagram

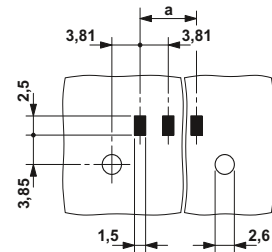

Technical data

Technical data in accordance to IEC / DIN VDE	
Rated current / conductor cross section	[A] / [mm ²]
Rated insulation voltage for pollution degree 2	[V]
Pitch	[mm]
Connection capacity	
Solid / stranded	[mm ²] / [mm ²] / AWG
Stranded with ferrules without plastic sleeve	[mm ²]
Stranded with ferrules with plastic sleeve	[mm ²]
Multi-conductor connection capacity (two conductors with the same cross section)	
Solid / stranded	[mm ²]
Stranded with ferrules without plastic sleeve	[mm ²]
Stranded with TWIN ferrule with plastic sleeve	[mm ²]
Insulation coordination	
Surge voltage category / pollution degree	
Rated insulation voltage	[V]
Rated surge voltage	[kV]
Approval data (UL/CUL)	Use Group
Nominal voltage	[V]
Nominal current	[A]
Connection capacity AWG	AWG
Approval data (CSA)	Use Group
Nominal voltage	[V]
Nominal current	[A]
Connection capacity AWG	AWG
General data	
Stripping length	[mm]
Screw thread	
Tightening torque	[Nm]
Type of insulation material / insulation material group	
Inflammability class according to UL 94	

8 ¹⁾ / 1.5		
160		
3.81		
0.14 - 1.5 / 0.14 - 1 / 26 - 16		
0.25 - 0.5		
0.25 - 0.5		
0.14 - 0.5 / 0.14 - 0.2		
-		
-		
III / 3	III / 2	II / 2
160	160	250
2.5	2.5	2.5
B	C	D
300	-	300
10	-	10
30 - 16	-	30 - 16
B	C	D
150	-	300
10	-	10
28 - 16	-	28 - 16
5		
M2		
0.22 - 0.25		
PA-F / IIIa		
V0		

No. of pos.	Dim. a [mm]
2	3.81
3	7.62
4	11.43
5	15.24
6	19.05
7	22.86
8	26.67
9	30.48
10	34.29
11	38.10
12	41.91

Ordering data

Type	Order No.	Pcs. / Pkt.
3.81 mm pitch, color: Black		
MKDS 1/ 2-3,81 SMD BK	1727230	35
MKDS 1/ 3-3,81 SMD BK	1727243	28
MKDS 1/ 4-3,81 SMD BK	1727256	23
MKDS 1/ 5-3,81 SMD BK	1727269	20
MKDS 1/ 6-3,81 SMD BK	1727272	17
MKDS 1/ 7-3,81 SMD BK	1727285	15
MKDS 1/ 8-3,81 SMD BK	1727175	14
MKDS 1/ 9-3,81 SMD BK	1727298	12
MKDS 1/10-3,81 SMD BK	1727308	11
MKDS 1/11-3,81 SMD BK	1727311	10
MKDS 1/12-3,81 SMD BK	1727324	10

Connection cross section of up to 0.5 mm²

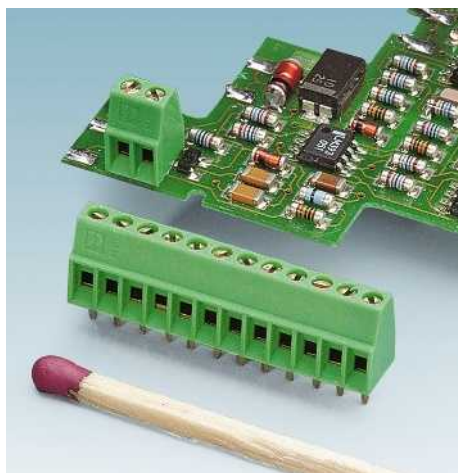

- MICRO PCB terminal block with 2.54 mm pitch
- Single-row type with horizontal connection direction
- Application in miniature assemblies with high contact density

Notes:

The 2 and 3-pos. versions have a locating pin (1.5 mm long) to support the mechanical load.
For drilling diagram and dimensional drawing for MPT 0,5/...2,54, 2 to 3-pos, see page 838.



MICRO PCB terminal block with 2.54 mm pitch



Dimensional drawing

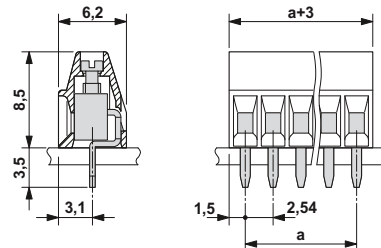

Drilling diagram

4 to 12-pos. variants

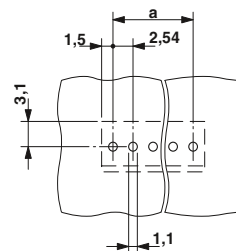

Accessories		
For all types	Type	Page
	Marker cards SK 2,54/2,8	796
	Screwdriver SZS 0,4 X 2,0 Order No. 1205202	

Technical data

Technical data in accordance to IEC / DIN VDE		
Rated current / conductor cross section	[A] / [mm ²]	6 / 0.5
Rated insulation voltage for pollution degree 2	[V]	160
Pitch	[mm]	2.54
Connection capacity		
Solid / stranded	[mm ²] / [mm ²] / AWG	0.14 - 0.5 / 0.14 - 0.5 / 26 - 20
Stranded with ferrules without plastic sleeve	[mm ²]	0.25 - 0.34
Stranded with ferrules with plastic sleeve	[mm ²]	0.25 - 0.34
Multi-conductor connection capacity (two conductors with the same cross section)		
Solid / stranded	[mm ²]	0.14 - 0.34 / 0.14 - 0.34
Stranded with ferrules without plastic sleeve	[mm ²]	-
Stranded with TWIN ferrule with plastic sleeve	[mm ²]	-
Insulation coordination		
Surge voltage category / pollution degree		III / 3 III / 2 II / 2
Rated insulation voltage	[V]	63 160 320
Rated surge voltage	[kV]	1.5 1.5 2.5
Approval data (UL/CUL)	Use Group	B C D
Nominal voltage	[V]	125 - -
Nominal current	[A]	6 - -
Connection capacity AWG	AWG	30 - 20 - -
Approval data (CSA)	Use Group	B C D
Nominal voltage	[V]	125 - -
Nominal current	[A]	6 - -
Connection capacity AWG	AWG	28 - 20 - -
General data		
Stripping length	[mm]	4.5
Screw thread		M1,6
Tightening torque	[Nm]	0.12 - 0.15
Type of insulation material / insulation material group		PA / I
Inflammability class according to UL 94		V0
Drill hole diameter / pin dimensions	[mm]	1.1 / 0.5 x 0.9 mm

Ordering data

Type	Order No.	Pcs. / Pkt.
Pitch 2.54 mm, color: green		
MPT 0,5/ 2-2,54	1725656	250
MPT 0,5/ 3-2,54	1725669	250
MPT 0,5/ 4-2,54	1725672	250
MPT 0,5/ 5-2,54	1725685	250
MPT 0,5/ 6-2,54	1725698	100
MPT 0,5/ 7-2,54	1725708	100
MPT 0,5/ 8-2,54	1725711	100
MPT 0,5/ 9-2,54	1725724	100
MPT 0,5/10-2,54	1725737	100
MPT 0,5/11-2,54	1725740	50
MPT 0,5/12-2,54	1725753	50

PCB terminal blocks with 2.54 to 7.62 mm pitch

PCB terminal blocks with screw connection for wave soldering processes, currents up to 24 A

Connection cross section of up to 1.5 mm²

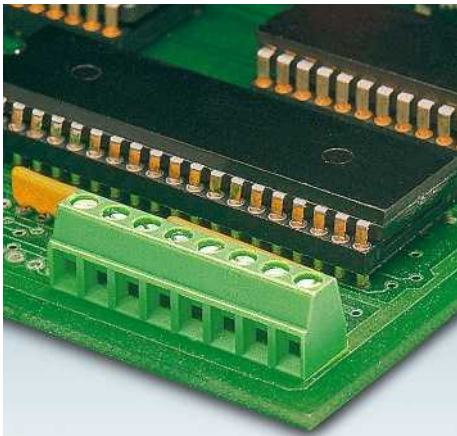

- PCB terminal blocks with extremely compact housing dimensions with 3.5 or 3.81 mm pitch

MKDS 1/...

- Single-row type with horizontal connection direction

SMKDS 1/...

- Conductor and screwdriver axis at an angle of 55° to the PCB
- An arrangement of several terminal block rows one behind the other – multi-level effect with the same design

MKKDS 1/...

- Double-level type with high packaging and connection density
- Offset levels for optimum accessibility of the terminal points

Notes:

1) Please observe the current carrying capacity curves. Further current carrying capacity curves on request.

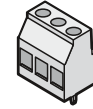

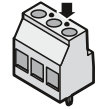

Metric 3.5 mm pitch



Detection lug for models with 3.81 mm inch pitch

Accessories

For all types	Type	Page
	Marker cards SK 3,5/2,8 or SK 3,81/2,8	797
	Screwdriver SZS 0,4 x 2,5 Order No. 1205037	

Current carrying capacity curve

Type: MKDS 1/5-3,5
Test following DIN EN 60512-5-2:2003-01
Reduction factor = 1
No. of positions = 5

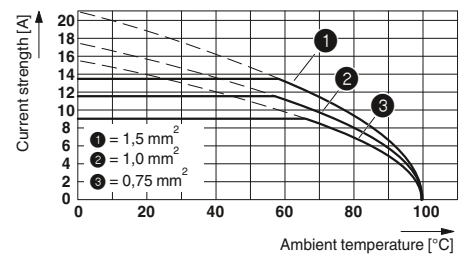

Technical data

Technical data in accordance to IEC / DIN VDE

Rated current / conductor cross section	[A] / [mm ²]
Rated insulation voltage for pollution degree 2	[V]
Pitch	[mm]
Connection capacity	
Solid / stranded	[mm ²] / [mm ²] / AWG
Stranded with ferrules without plastic sleeve	[mm ²]
Stranded with ferrules with plastic sleeve	[mm ²]
Multi-conductor connection capacity (two conductors with the same cross section)	
Solid / stranded	[mm ²]
Insulation coordination	
Surge voltage category / pollution degree	
Rated insulation voltage	[V]
Rated surge voltage	[kV]
Approval data (UL/CUL)	Use Group
Nominal voltage	[V]
Nominal current	[A]
Connection capacity AWG	AWG
Approval data (CSA)	Use Group
Nominal voltage	[V]
Nominal current	[A]
Connection capacity AWG	AWG
General data	
Stripping length	[mm]
Screw thread	
Tightening torque	[Nm]
Type of insulation material / insulation material group	
Inflammability class according to UL 94	
Drill hole diameter / pin dimensions	[mm]

MKDS 1/...

Rated current / conductor cross section	13.5 ¹⁾ / 1.5		
Rated insulation voltage for pollution degree 2	200		
Pitch	3.5 / 3.81		
Connection capacity			
Solid / stranded	0.14 - 1.5 / 0.14 - 1.5 / 26 - 16		
Stranded with ferrules without plastic sleeve	0.25 - 0.5		
Stranded with ferrules with plastic sleeve	0.25 - 0.5		
Multi-conductor connection capacity (two conductors with the same cross section)			
Solid / stranded	0.14 - 0.5 / 0.14 - 0.34		
Insulation coordination			
Surge voltage category / pollution degree	III / 3	III / 2	II / 2
Rated insulation voltage	160	200	400
Rated surge voltage	2.5	2.5	2.5
Approval data (UL/CUL)	B	C	D
Nominal voltage	300	-	300
Nominal current	10	-	10
Connection capacity AWG	30 - 16	-	30 - 16
Approval data (CSA)	B	C	D
Nominal voltage	150	-	300
Nominal current	10	-	10
Connection capacity AWG	28 - 16	-	28 - 16
General data			
Stripping length	5		
Screw thread	M2		
Tightening torque	0.22 - 0.25		
Type of insulation material / insulation material group	PA / I		
Inflammability class according to UL 94	V0		
Drill hole diameter / pin dimensions	1.1 / 0.5 x 0.9 mm		

SMKDS 1/...

Rated current / conductor cross section	10 ¹⁾ / 1.5		
Rated insulation voltage for pollution degree 2	200		
Pitch	3.5 / 3.81		
Connection capacity			
Solid / stranded	0.14 - 1.5 / 0.14 - 1 / 26 - 16		
Stranded with ferrules without plastic sleeve	0.25 - 0.5		
Stranded with ferrules with plastic sleeve	0.25 - 0.5		
Multi-conductor connection capacity (two conductors with the same cross section)			
Solid / stranded	0.14 - 0.5 / 0.14 - 0.2		
Insulation coordination			
Surge voltage category / pollution degree	III / 3	III / 2	II / 2
Rated insulation voltage	160	200	400
Rated surge voltage	2.5	2.5	2.5
Approval data (UL/CUL)	B	C	D
Nominal voltage	300	-	300
Nominal current	10	-	10
Connection capacity AWG	30 - 16	-	30 - 16
Approval data (CSA)	B	C	D
Nominal voltage	150	-	300
Nominal current	10	-	10
Connection capacity AWG	28 - 16	-	28 - 16
General data			
Stripping length	5		
Screw thread	M2		
Tightening torque	0.22 - 0.25		
Type of insulation material / insulation material group	PA / I		
Inflammability class according to UL 94	V0		
Drill hole diameter / pin dimensions	1.1 / 0.5 x 0.9 mm		

MKKDS 1/...

Rated current / conductor cross section	8 ¹⁾ / 1.5		
Rated insulation voltage for pollution degree 2	200		
Pitch	3.5 / 3.81		
Connection capacity			
Solid / stranded	0.14 - 1.5 / 0.14 - 1 / 26 - 16		
Stranded with ferrules without plastic sleeve	0.25 - 0.5		
Stranded with ferrules with plastic sleeve	0.25 - 0.5		
Multi-conductor connection capacity (two conductors with the same cross section)			
Solid / stranded	0.14 - 0.5 / 0.14 - 0.2		
Insulation coordination			
Surge voltage category / pollution degree	III / 3	III / 2	II / 2
Rated insulation voltage	160	200	400
Rated surge voltage	2.5	2.5	2.5
Approval data (UL/CUL)	B	C	D
Nominal voltage	300	-	300
Nominal current	10	-	10
Connection capacity AWG	30 - 16	-	30 - 16
Approval data (CSA)	B	C	D
Nominal voltage	150	-	300
Nominal current	10	-	10
Connection capacity AWG	28 - 16	-	28 - 16
General data			
Stripping length	5		
Screw thread	M2		
Tightening torque	0.22 - 0.25		
Type of insulation material / insulation material group	PA / I		
Inflammability class according to UL 94	V0		
Drill hole diameter / pin dimensions	1.1 / 0.5 x 0.9 mm		

No. of pos.	Dim. a [mm]
2	3.50
3	7.00
4	10.50
5	14.00
6	17.50
7	21.00
8	24.50
9	28.00
10	31.50
11	35.00
12	38.50
13	42.00
14	45.50
15	49.00
16	52.50
2	3.81
3	7.62
4	11.43
5	15.24
6	19.05
7	22.86
8	26.67
9	30.48
10	34.29
11	38.10
12	41.91



With horizontal connection direction

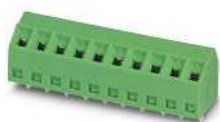

With 55° angled connection direction

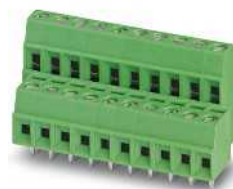

Double-level PCB terminal block with offset levels



Dimensional drawing

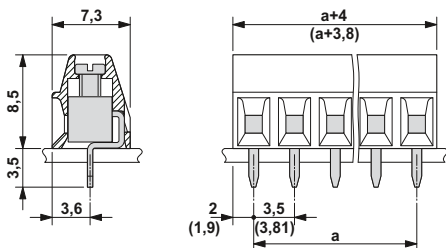

Drilling diagram

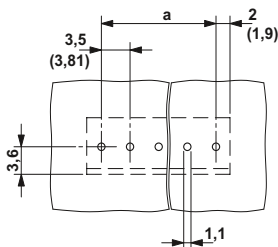

Ordering data

Type	Order No.	Pcs. / Pkt.
3.5 mm pitch, color: green		
MKDS 1/ 2-3,5	1751248	250
MKDS 1/ 3-3,5	1751251	250
MKDS 1/ 4-3,5	1751264	250
MKDS 1/ 5-3,5	1751277	250
MKDS 1/ 6-3,5	1751280	100
MKDS 1/ 7-3,5	1751293	100
MKDS 1/ 8-3,5	1751303	100
MKDS 1/ 9-3,5	1751316	100
MKDS 1/10-3,5	1751329	100
MKDS 1/11-3,5	1751332	50
MKDS 1/12-3,5	1751345	50
MKDS 1/13-3,5	1751358	50
MKDS 1/14-3,5	1751361	50
MKDS 1/15-3,5	1751374	50
MKDS 1/16-3,5	1751387	50
Pitch 3.81 mm, color: green		
MKDS 1/ 2-3,81	1727010	250
MKDS 1/ 3-3,81	1727023	250
MKDS 1/ 4-3,81	1727036	250
MKDS 1/ 5-3,81	1727049	250
MKDS 1/ 6-3,81	1727052	100
MKDS 1/ 7-3,81	1727065	100
MKDS 1/ 8-3,81	1727078	100
MKDS 1/ 9-3,81	1727081	100
MKDS 1/10-3,81	1727094	100
MKDS 1/11-3,81	1727104	50
MKDS 1/12-3,81	1727117	50



Dimensional drawing

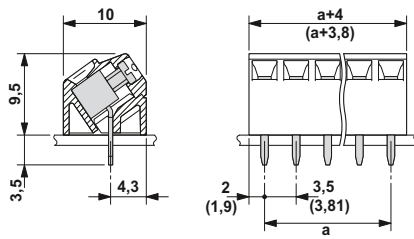

Drilling diagram

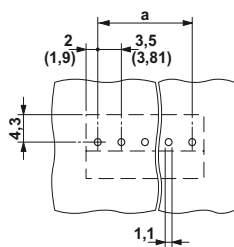

Ordering data

Type	Order No.	Pcs. / Pkt.
3.5 mm pitch, color: green		
SMKDS 1/ 2-3,5	1751099	250
SMKDS 1/ 3-3,5	1751109	250
SMKDS 1/ 4-3,5	1751112	250
SMKDS 1/ 5-3,5	1751125	100
SMKDS 1/ 6-3,5	1751138	100
SMKDS 1/ 7-3,5	1751141	100
SMKDS 1/ 8-3,5	1751154	100
SMKDS 1/ 9-3,5	1751167	100
SMKDS 1/10-3,5	1751170	100
SMKDS 1/11-3,5	1751183	50
SMKDS 1/12-3,5	1751196	50
SMKDS 1/13-3,5	1751206	50
SMKDS 1/14-3,5	1751219	50
SMKDS 1/15-3,5	1751222	50
SMKDS 1/16-3,5	1751235	50
Pitch 3.81 mm, color: green		
SMKDS 1/ 2-3,81	1728284	250
SMKDS 1/ 3-3,81	1728297	250
SMKDS 1/ 4-3,81	1728307	250
SMKDS 1/ 5-3,81	1728310	100
SMKDS 1/ 6-3,81	1728323	100
SMKDS 1/ 7-3,81	1728336	100
SMKDS 1/ 8-3,81	1728349	100
SMKDS 1/ 9-3,81	1728352	100
SMKDS 1/10-3,81	1728365	100
SMKDS 1/11-3,81	1728378	50
SMKDS 1/12-3,81	1728381	50



Dimensional drawing

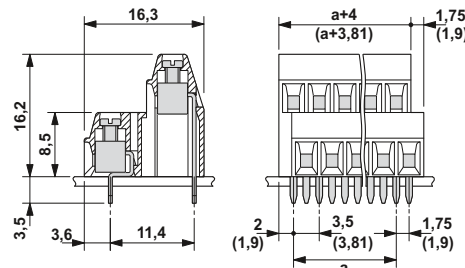

Drilling diagram

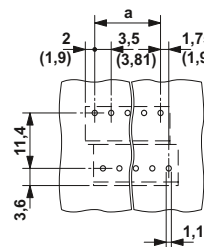

Ordering data

Type	Order No.	Pcs. / Pkt.
3.5 mm pitch, color: green		
MKKDS 1/ 2-3,5	1751390	50
MKKDS 1/ 3-3,5	1751400	50
MKKDS 1/ 4-3,5	1751413	50
MKKDS 1/ 5-3,5	1751426	50
MKKDS 1/ 6-3,5	1751439	50
MKKDS 1/ 7-3,5	1751442	50
MKKDS 1/ 8-3,5	1751455	50
MKKDS 1/ 9-3,5	1751468	50
MKKDS 1/10-3,5	1751471	50
MKKDS 1/11-3,5	1751484	50
MKKDS 1/12-3,5	1751497	50
MKKDS 1/13-3,5	1751507	50
MKKDS 1/14-3,5	1751510	50
MKKDS 1/15-3,5	1751523	50
MKKDS 1/16-3,5	1751536	50
Pitch 3.81 mm, color: green		
MKKDS 1/ 2-3,81	1708026	50
MKKDS 1/ 3-3,81	1708039	50
MKKDS 1/ 4-3,81	1708042	50
MKKDS 1/ 5-3,81	1708055	50
MKKDS 1/ 6-3,81	1708068	50
MKKDS 1/ 7-3,81	1708071	50
MKKDS 1/ 8-3,81	1708084	50
MKKDS 1/ 9-3,81	1708107	50
MKKDS 1/10-3,81	1708110	50
MKKDS 1/11-3,81	1708123	50
MKKDS 1/12-3,81	1708136	50

PCB terminal blocks with 2.54 to 7.62 mm pitch

PCB terminal blocks with screw connection for wave soldering processes, currents up to 24 A

Connection cross section of up to 1.5 mm²

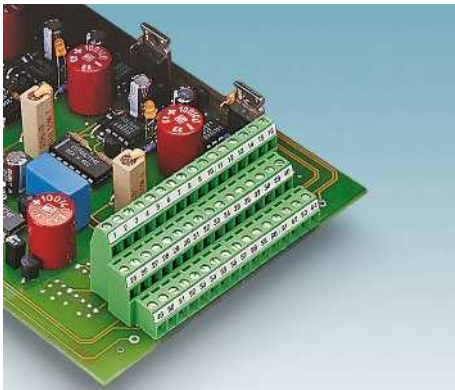

- PCB terminal blocks with extremely compact housing dimensions with 3.5 or 3.81 mm pitch

MK3DS 1/...

- Three-level type with high packaging and connection density
- Offset levels for optimum accessibility of the terminal points

SMKDS 1,5/...

- Conductor and screwdriver axis at an angle of 55° to the PCB
- An arrangement of several terminal block rows one behind the other – multi-level effect with the same design

MKDSFW 1,5/...

- Horizontal series with vertical connection direction to the PCB

Notes:
In order to avoid tolerances between the terminal blocks and PCB, the terminal row should be interrupted when the number of positions exceeds 30.
For dimensional drawing and drilling diagram of 2 and 3-pos. MKDSFW 1,5/...-3,5, see page 838.
1) Please observe the current carrying capacity curves. Further current carrying capacity curves on request.

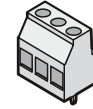

Metric 3.5 mm pitch

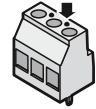

Detection lug for models with 3.81 mm inch pitch

Accessories

For all types	Type	Page
	Marker cards SK 3,5/2,8 or SK 3,81/2,8	797
	Screwdriver SZS 0,4 x 2,5 Order No. 1205037	

Current carrying capacity curve

Type: MK3DS 1/5-3,81
Test following DIN EN 60512-5-2:2003-01
Reduction factor = 1
No. of pos.:5

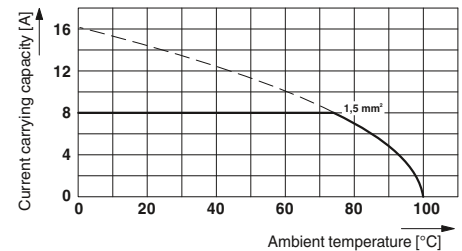

Technical data

Technical data in accordance to IEC / DIN VDE	
Rated current / conductor cross section	[A] / [mm ²]
Rated insulation voltage for pollution degree 2	[V]
Pitch	[mm]
Connection capacity	
Solid / stranded	[mm ²] / [mm ²] / AWG
Stranded with ferrules without plastic sleeve	[mm ²]
Stranded with ferrules with plastic sleeve	[mm ²]
Multi-conductor connection capacity (two conductors with the same cross section)	
Solid / stranded	[mm ²]
Stranded with ferrules without plastic sleeve	[mm ²]
Stranded with TWIN ferrule with plastic sleeve	[mm ²]
Insulation coordination	
Surge voltage category / pollution degree	
Rated insulation voltage	[V]
Rated surge voltage	[kV]
Approval data (UL/CUL)	Use Group
Nominal voltage	[V]
Nominal current	[A]
Connection capacity AWG	AWG
Approval data (CSA)	Use Group
Nominal voltage	[V]
Nominal current	[A]
Connection capacity AWG	AWG
General data	
Stripping length	[mm]
Screw thread	
Tightening torque	[Nm]
Type of insulation material / insulation material group	
Inflammability class according to UL 94	
Drill hole diameter / pin dimensions	[mm]

MK3DS 1/ ...-3,81		
Rated current / conductor cross section		
8 ¹⁾ / 1.5		
Rated insulation voltage for pollution degree 2		
160		
Pitch		
3.81		
Connection capacity		
Solid / stranded		
0.14 - 1.5 / 0.14 - 1 / 26 - 16		
Stranded with ferrules without plastic sleeve		
0.25 - 0.5		
Stranded with ferrules with plastic sleeve		
0.25 - 0.5		
Multi-conductor connection capacity (two conductors with the same cross section)		
Solid / stranded		
0.14 - 0.5 / 0.14 - 0.2		
Stranded with ferrules without plastic sleeve		
-		
Stranded with TWIN ferrule with plastic sleeve		
-		
Insulation coordination		
Surge voltage category / pollution degree		
III / 3	III / 2	II / 2
160	160	320
Rated insulation voltage		
2.5		
Rated surge voltage		
2.5		
Approval data (UL/CUL)		
B	C	D
Nominal voltage		
300	-	300
Nominal current		
10	-	10
Connection capacity AWG		
30 - 16	-	30 - 16
Approval data (CSA)		
B	C	D
Nominal voltage		
150	-	300
Nominal current		
10	-	10
Connection capacity AWG		
28 - 16	-	28 - 16
General data		
Stripping length		
5		
Screw thread		
M2		
Tightening torque		
0.22 - 0.25		
Type of insulation material / insulation material group		
PA / I		
Inflammability class according to UL 94		
V0		
Drill hole diameter / pin dimensions		
1.1 / 0.5 x 0.9 mm		

SMKDS 1,5/ ...-3,5		
Rated current / conductor cross section		
12 ¹⁾ / 1.5		
Rated insulation voltage for pollution degree 2		
160		
Pitch		
3.5		
Connection capacity		
Solid / stranded		
0.08 - 1.5 / 0.08 - 1.5 / 28 - 16		
Stranded with ferrules without plastic sleeve		
0.25 - 1.5		
Stranded with ferrules with plastic sleeve		
0.25 - 1.5		
Multi-conductor connection capacity (two conductors with the same cross section)		
Solid / stranded		
0.08 - 0.5 / 0.08 - 0.75		
Stranded with ferrules without plastic sleeve		
0.25 - 0.34		
Stranded with TWIN ferrule with plastic sleeve		
-		
Insulation coordination		
Surge voltage category / pollution degree		
III / 3	III / 2	II / 2
160	160	320
Rated insulation voltage		
2.5		
Rated surge voltage		
2.5		
Approval data (UL/CUL)		
B	C	D
Nominal voltage		
250	-	300
Nominal current		
10	-	10
Connection capacity AWG		
30 - 14	-	30 - 14
Approval data (CSA)		
B	C	D
Nominal voltage		
-	-	-
Nominal current		
-	-	-
Connection capacity AWG		
-	-	-
General data		
Stripping length		
7		
Screw thread		
M2		
Tightening torque		
0.22 - 0.25		
Type of insulation material / insulation material group		
PA / I		
Inflammability class according to UL 94		
V0		
Drill hole diameter / pin dimensions		
1.3 / 0.6 x 1 mm		

MKDSFW 1,5/ ...-3,5		
Rated current / conductor cross section		
12 ¹⁾ / 1.5		
Rated insulation voltage for pollution degree 2		
160		
Pitch		
3.5		
Connection capacity		
Solid / stranded		
0.14 - 1.5 / 0.14 - 1.5 / 26 - 16		
Stranded with ferrules without plastic sleeve		
0.25 - 1.5		
Stranded with ferrules with plastic sleeve		
0.25 - 1.5		
Multi-conductor connection capacity (two conductors with the same cross section)		
Solid / stranded		
0.14 - 0.75 / 0.14 - 0.75		
Stranded with ferrules without plastic sleeve		
0.25 - 0.5		
Stranded with TWIN ferrule with plastic sleeve		
0.5 - 1		
Insulation coordination		
Surge voltage category / pollution degree		
III / 3	III / 2	II / 2
160	160	320
Rated insulation voltage		
2.5		
Rated surge voltage		
2.5		
Approval data (UL/CUL)		
B	C	D
Nominal voltage		
300	-	300
Nominal current		
10	-	10
Connection capacity AWG		
30 - 14	-	30 - 14
Approval data (CSA)		
B	C	D
Nominal voltage		
-	-	-
Nominal current		
-	-	-
Connection capacity AWG		
-	-	-
General data		
Stripping length		
6		
Screw thread		
M2		
Tightening torque		
0.22 - 0.25		
Type of insulation material / insulation material group		
PA / I		
Inflammability class according to UL 94		
V0		
Drill hole diameter / pin dimensions		
1.3 / 0.5 x 0.9 mm		

No. of pos.	Dim. a [mm]
2	3.50
3	7.00
4	10.50
5	14.00
6	17.50
7	31.00
8	24.50
9	28.00
10	31.50
11	35.00
12	38.50
2	3.81
3	7.62
4	11.43
5	15.24
6	19.05
7	22.86
8	26.67
9	30.48
10	34.29
11	38.10
12	41.91

PCB terminal blocks with 2.54 to 7.62 mm pitch

PCB terminal blocks with screw connection for wave soldering processes, currents up to 24 A

Connection cross section of up to 1.5 mm²

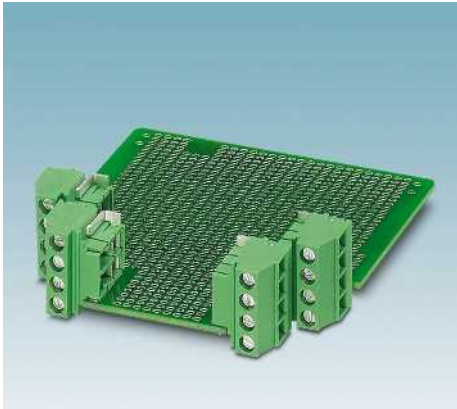

- PCB terminal block for ME/ME MAX electronic housing
- PCB terminal block is orthogonal to the PCB
- “Left” and “right” design
- Pitch 3.5 mm
- Number of positions between 3 and 5

Notes:

- 1) Please observe the current carrying capacity curves. Further current carrying capacity curves on request.
- 2) PCB terminal blocks with 5 mm pitch, see page 113.

Accessories

For all types	Type	Page
	Marker cards SK 3,5/2,8	797

Technical data

Technical data in accordance to IEC / DIN VDE	
Rated current / conductor cross section	[A] / [mm ²]
Rated insulation voltage for pollution degree 2	[V]
Pitch	[mm]
Connection capacity	
Solid / stranded	[mm ²] / [mm ²] / AWG
Stranded with ferrules without plastic sleeve	[mm ²]
Stranded with ferrules with plastic sleeve	[mm ²]
Multi-conductor connection capacity (two conductors with the same cross section)	
Solid / stranded	[mm ²]
Stranded with ferrules without plastic sleeve	[mm ²]
Stranded with TWIN ferrule with plastic sleeve	[mm ²]
Insulation coordination	
Surge voltage category / pollution degree	
Rated insulation voltage	[V]
Rated surge voltage	[kV]
Approval data (UL/CUL)	Use Group
Nominal voltage	[V]
Nominal current	[A]
Connection capacity AWG	AWG
Approval data (CSA)	Use Group
Nominal voltage	[V]
Nominal current	[A]
Connection capacity AWG	AWG
General data	
Stripping length	[mm]
Screw thread	
Tightening torque	[Nm]
Type of insulation material / insulation material group	
Inflammability class according to UL 94	
Drill hole diameter / pin dimensions	[mm]

MKDSO 1,5/ 3-L-3,5 KMGY

8 ¹⁾ / 1.5		
160		
3.5		
0.14 - 1.5 / 0.14 - 1.5 / 28 - 16		
0.25 - 1.5		
0.25 - 0.5		
0.08 - 0.5 / 0.08 - 0.75		
0.25 - 0.34		
0.5 - 0.5		
III / 3	III / 2	II / 2
160	160	320
2.5	2.5	2.5
B	C	D
-	-	-
-	-	-
-	-	-
B	C	D
-	-	-
-	-	-
-	-	-
7		
M2		
0.22 - 0.25		
PA / I		
V0		
1.2 / 0.8 x 0.8 mm		

MKDSO 1,5/ 3-R-3,5 KMGY

8 ¹⁾ / 1.5		
160		
3.5		
0.14 - 1.5 / 0.14 - 1.5 / 28 - 16		
0.25 - 1.5		
0.25 - 0.5		
0.08 - 0.5 / 0.08 - 0.75		
0.25 - 0.34		
0.5 - 0.5		
III / 3	III / 2	II / 2
160	160	320
2.5	2.5	2.5
B	C	D
-	-	-
-	-	-
-	-	-
B	C	D
-	-	-
-	-	-
-	-	-
7		
M2		
0.22 - 0.25		
PA / I		
V0		
1.2 / 0.8 x 0.8 mm		

No. of pos.	Dim. a [mm]
3	7.00
4	10.50
5	14.00



With "left" solder pins leading off at a right angle



With "right" solder pins leading off at a right angle



Dimensional drawing

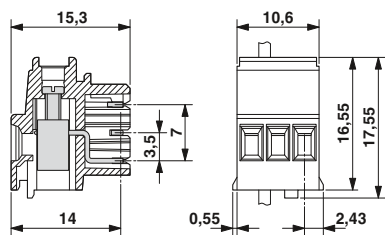

Drilling diagram

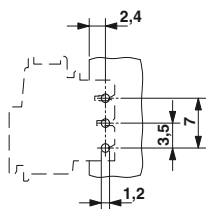

Dimensional drawing

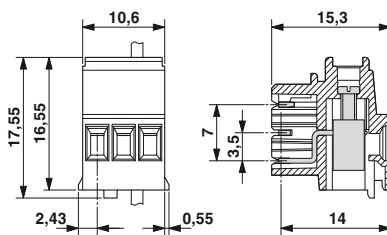

Drilling diagram

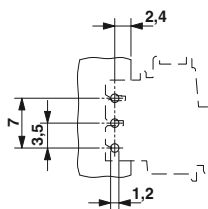

Ordering data

Type	Order No.	Pcs. / Pkt.
PCB terminal block, left, 3.5 mm pitch, color: light gray ²⁾		
MKDSO 1,5/ 3-L-3,5 KMGY	2278445	50
MKDSO 1,5/ 4-L-3,5 KMGY	2278432	50
MKDSO 1,5/ 5-L-3,5 KMGY	2278393	50

Ordering data

Type	Order No.	Pcs. / Pkt.
PCB terminal block, right, 3.5 mm pitch, color: light gray		
MKDSO 1,5/ 3-R-3,5 KMGY	2278458	50
MKDSO 1,5/ 4-R-3,5 KMGY	2278429	50
MKDSO 1,5/ 5-R-3,5 KMGY	2278416	50

PCB terminal blocks with 2.54 to 7.62 mm pitch

PCB terminal blocks with screw connection for wave soldering processes, currents up to 24 A

Connection cross section of up to 1.5 mm²



- PCB terminal blocks with compact housing dimensions and a flat design
- Conductor cross sections up to 1.5 mm²
- 5.0 or 5.08 mm pitch

MKDSN 1,5/...

- Single-row type with horizontal connection direction

SMKDSN 1,5/...

- Conductor and screwdriver axis at an angle of 55° to the PCB
- An arrangement of several terminal block rows one behind the other – multi-level effect with the same design

Notes:

In order to avoid tolerances between the terminal blocks and PCB, the terminal row should be interrupted when the number of positions exceeds 30.

1) Please observe the current carrying capacity curves. Further current carrying capacity curves on request.

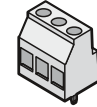

Metric 5 mm pitch

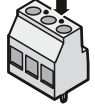

Detection lug for models with 5.08 mm inch pitch

Accessories

For all types	Type	Page
	Marker cards SK 5/3,8 or SK 5,08/3,8	798
	Screwdriver SZS 0,6 x 3,5 Order No. 1205053	
	Insertion bridge EBP...- 5	829

Current carrying capacity curve

Type: MKDSN 1,5/5
Test following DIN EN 60512-5-2:2003-01
Reduction factor = 1
No. of pos.:5

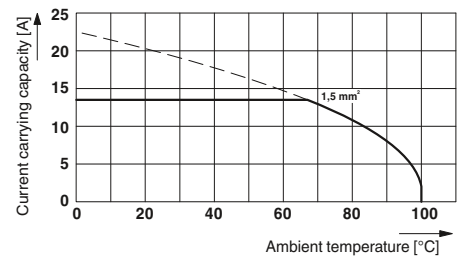

Technical data

Technical data in accordance to IEC / DIN VDE

Rated current / conductor cross section	[A] / [mm ²]
Rated insulation voltage for pollution degree 2	[V]
Pitch	[mm]
Connection capacity	
Solid / stranded	[mm ²] / [mm ²] / AWG
Stranded with ferrules without plastic sleeve	[mm ²]
Stranded with ferrules with plastic sleeve	[mm ²]
Multi-conductor connection capacity (two conductors with the same cross section)	
Solid / stranded	[mm ²]
Stranded with ferrules without plastic sleeve	[mm ²]
Stranded with TWIN ferrule with plastic sleeve	[mm ²]
Insulation coordination	
Surge voltage category / pollution degree	
Rated insulation voltage	[V]
Rated surge voltage	[kV]
Approval data (UL/CUL)	Use Group
Nominal voltage	[V]
Nominal current	[A]
Connection capacity AWG	AWG
Approval data (CSA)	Use Group
Nominal voltage	[V]
Nominal current	[A]
Connection capacity AWG	AWG
General data	
Stripping length	[mm]
Screw thread	
Tightening torque	[Nm]
Type of insulation material / insulation material group	
Inflammability class according to UL 94	
Drill hole diameter / pin dimensions	[mm]

MKDSN 1,5/ ...

Rated current / conductor cross section	13.5 ¹⁾ / 1.5
Rated insulation voltage for pollution degree 2	400
Pitch	5 / 5.08
Connection capacity	
Solid / stranded	0.14 - 1.5 / 0.14 - 1.5 / 26 - 16
Stranded with ferrules without plastic sleeve	0.25 - 1
Stranded with ferrules with plastic sleeve	0.25 - 1.5
Multi-conductor connection capacity (two conductors with the same cross section)	
Solid / stranded	0.14 - 0.75 / 0.14 - 0.75
Stranded with ferrules without plastic sleeve	0.25 - 0.5
Stranded with TWIN ferrule with plastic sleeve	0.5 - 0.75
Insulation coordination	
Surge voltage category / pollution degree	III / 3 III / 2 II / 2
Rated insulation voltage	250 400 630
Rated surge voltage	4 4 4
Approval data (UL/CUL)	B C D
Nominal voltage	300 - - 300
Nominal current	10 - - 10
Connection capacity AWG	30 - 14 - - 30 - 14
Approval data (CSA)	B C D
Nominal voltage	150 - - 300
Nominal current	10 - - 10
Connection capacity AWG	28 - 14 - - 28 - 14
General data	
Stripping length	6
Screw thread	M3
Tightening torque	0.5 - 0.6
Type of insulation material / insulation material group	PA / I
Inflammability class according to UL 94	V0
Drill hole diameter / pin dimensions	1.3 / 0.5 x 1 mm

SMKDSN 1,5/ ...

Rated current / conductor cross section	13.5 ¹⁾ / 1.5
Rated insulation voltage for pollution degree 2	400
Pitch	5 / 5.08
Connection capacity	
Solid / stranded	0.14 - 1.5 / 0.14 - 1.5 / 26 - 16
Stranded with ferrules without plastic sleeve	0.25 - 1.5
Stranded with ferrules with plastic sleeve	0.25 - 1.5
Multi-conductor connection capacity (two conductors with the same cross section)	
Solid / stranded	0.14 - 0.75 / 0.14 - 0.75
Stranded with ferrules without plastic sleeve	0.25 - 0.5
Stranded with TWIN ferrule with plastic sleeve	0.5 - 1
Insulation coordination	
Surge voltage category / pollution degree	III / 3 III / 2 II / 2
Rated insulation voltage	250 400 630
Rated surge voltage	4 4 4
Approval data (UL/CUL)	B C D
Nominal voltage	300 - - 300
Nominal current	10 - - 10
Connection capacity AWG	30 - 14 - - 30 - 14
Approval data (CSA)	B C D
Nominal voltage	150 - - 300
Nominal current	10 - - 10
Connection capacity AWG	28 - 14 - - 28 - 14
General data	
Stripping length	6
Screw thread	M3
Tightening torque	0.5 - 0.6
Type of insulation material / insulation material group	PA / I
Inflammability class according to UL 94	V0
Drill hole diameter / pin dimensions	1.3 / 0.5 x 1 mm

No. of pos.	Dim. a [mm]
2	5.00
3	10.00
4	15.00
5	20.00
6	25.00
7	30.00
8	35.00
9	40.00
10	45.00
11	50.00
12	55.00
13	60.00
14	65.00
15	70.00
16	75.00
2	5.08
3	10.16
4	15.24
5	20.32
6	25.40
7	30.48
8	35.56
9	40.64
10	45.72
11	50.80
12	55.88
13	60.96
14	66.04
15	71.12
16	76.20



Low-profile design, with housing overlapping

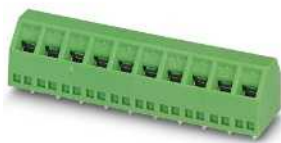

With 55° angled connection direction, without housing overlapping



Dimensional drawing

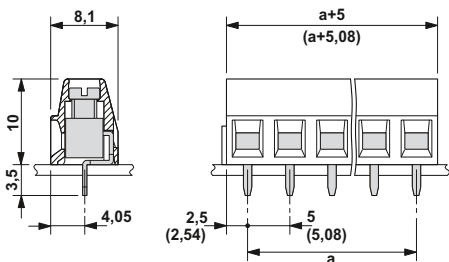

Dimensional drawing

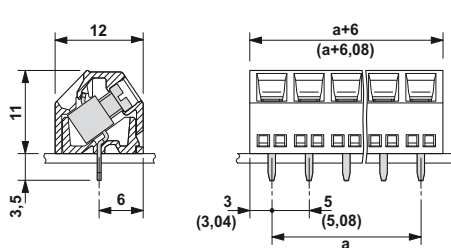

Drilling diagram

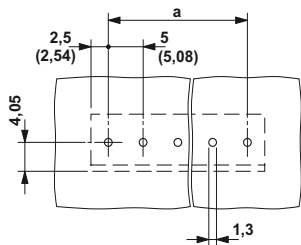

Drilling diagram

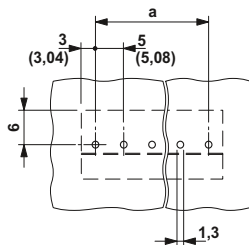

Ordering data

Type	Order No.	Pcs. / Pkt.
5.0 mm pitch, color: green		
MKDSN 1,5/ 2	1729018	250
MKDSN 1,5/ 3	1729021	250
MKDSN 1,5/ 4	1729034	250
MKDSN 1,5/ 5	1729047	250
MKDSN 1,5/ 6	1729050	100
MKDSN 1,5/ 7	1729063	100
MKDSN 1,5/ 8	1729076	100
MKDSN 1,5/ 9	1729089	100
MKDSN 1,5/10	1729092	100
MKDSN 1,5/11	1729102	50
MKDSN 1,5/12	1729115	50
5.08 mm pitch, color: green		
MKDSN 1,5/ 2-5,08	1729128	250
MKDSN 1,5/ 3-5,08	1729131	250
MKDSN 1,5/ 4-5,08	1729144	250
MKDSN 1,5/ 5-5,08	1729157	250
MKDSN 1,5/ 6-5,08	1729160	100
MKDSN 1,5/ 7-5,08	1729173	100
MKDSN 1,5/ 8-5,08	1729186	100
MKDSN 1,5/ 9-5,08	1729199	100
MKDSN 1,5/10-5,08	1729209	100
MKDSN 1,5/11-5,08	1729212	50
MKDSN 1,5/12-5,08	1729225	50

Ordering data

Type	Order No.	Pcs. / Pkt.
5.0 mm pitch, color: green		
SMKDSN 1,5/ 2	1869062	250
SMKDSN 1,5/ 3	1869075	250
SMKDSN 1,5/ 4	1869088	250
SMKDSN 1,5/ 5	1869091	100
SMKDSN 1,5/ 6	1869101	100
SMKDSN 1,5/ 7	1869114	100
SMKDSN 1,5/ 8	1869127	100
SMKDSN 1,5/ 9	1869130	100
SMKDSN 1,5/10	1869143	100
SMKDSN 1,5/11	1869156	50
SMKDSN 1,5/12	1869169	50
SMKDSN 1,5/13	1869172	50
SMKDSN 1,5/14	1869185	50
SMKDSN 1,5/15	1869198	50
SMKDSN 1,5/16	1869208	50
5.08 mm pitch, color: green		
SMKDSN 1,5/ 2-5,08	1869211	250
SMKDSN 1,5/ 3-5,08	1869224	250
SMKDSN 1,5/ 4-5,08	1869237	250
SMKDSN 1,5/ 5-5,08	1869240	100
SMKDSN 1,5/ 6-5,08	1869253	100
SMKDSN 1,5/ 7-5,08	1869266	100
SMKDSN 1,5/ 8-5,08	1869279	100
SMKDSN 1,5/ 9-5,08	1869282	100
SMKDSN 1,5/10-5,08	1869295	100
SMKDSN 1,5/11-5,08	1869305	50
SMKDSN 1,5/12-5,08	1869318	50
SMKDSN 1,5/13-5,08	1869321	50
SMKDSN 1,5/14-5,08	1869334	50
SMKDSN 1,5/15-5,08	1869347	50
SMKDSN 1,5/16-5,08	1869350	50

PCB terminal blocks with 2.54 to 7.62 mm pitch

PCB terminal blocks with screw connection for wave soldering processes, currents up to 24 A

Connection cross section of up to 1.5 mm²

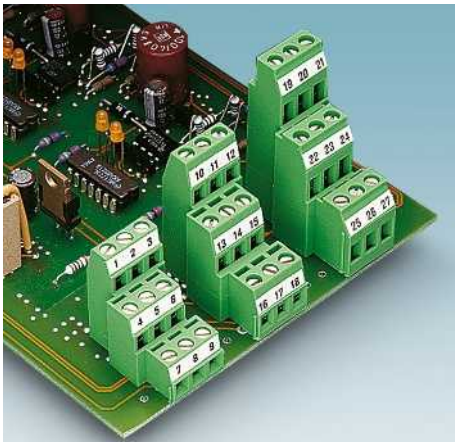

- Compact housing dimensions and low-profile design
- Conductor cross sections up to 1.5 mm²
- 5.0 or 5.08 mm pitch

MKKDSN 1,5/...

- Double-level type with high packaging and connection density
- Offset levels for optimum accessibility of the terminal points

MKKDSNH 1,5/...

- Single-row type, back level of the double-level PCB terminal block

MK3DSN 1,5/...

- Three-level type with high packaging and connection density
- Offset levels for optimum accessibility of the terminal points

Notes:

In order to avoid tolerances between the terminal blocks and PCB, the terminal row should be interrupted when the number of positions exceeds 30.

1) Please observe the current carrying capacity curves. Further current carrying capacity curves on request.

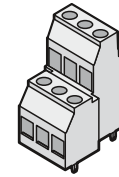

Metric 5 mm pitch

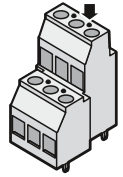

Detection lug for models with 5.08 mm inch pitch

Accessories

For all types	Type	Page
	Marker cards SK 5/3,8 or SK 5,08/3,8	798
	Screwdriver SZS 0,6 x 3,5 Order No. 1205053	
	Insertion bridge EBP...-5	829

Current carrying capacity curve

Type: MKKDSN 1,5/5
Test following DIN EN 60512-5-2:2003-01
Reduction factor = 1
No. of positions: 5

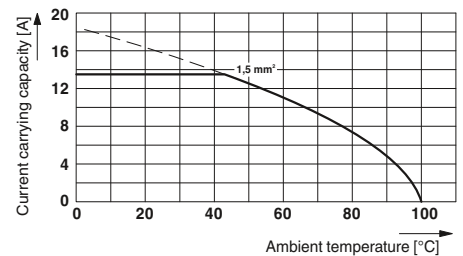

Technical data

Technical data in accordance to IEC / DIN VDE	
Rated current / conductor cross section	[A] / [mm ²]
Rated insulation voltage for pollution degree 2	[V]
Pitch	[mm]
Solid / stranded	[mm ²] / [mm ²] / AWG
Stranded with ferrules without plastic sleeve	[mm ²]
Stranded with ferrules with plastic sleeve	[mm ²]
Multi-conductor connection capacity (two conductors with the same cross section)	
Solid / stranded	[mm ²]
Stranded with ferrules without plastic sleeve	[mm ²]
Stranded with TWIN ferrule with plastic sleeve	[mm ²]
Insulation coordination	
Surge voltage category / pollution degree	
Rated insulation voltage	[V]
Rated surge voltage	[kV]
Approval data (UL/CUL)	Use Group
Nominal voltage	[V]
Nominal current	[A]
Connection capacity AWG	AWG
Approval data (CSA)	Use Group
Nominal voltage	[V]
Nominal current	[A]
Connection capacity AWG	AWG
General data	
Stripping length	[mm]
Screw thread	
Tightening torque	[Nm]
Type of insulation material / insulation material group	
Inflammability class according to UL 94	
Drill hole diameter / pin dimensions	[mm]

MKKDSN 1,5/ ...			MKKDSNH 1,5/ ...-5,08			MK3DSN 1,5/ ...-5,08		
13.5 ¹⁾ / 1.5			13.5 ¹⁾ / 1.5			10 ¹⁾ / 1.5		
400			400			400		
5 / 5.08			5.08			5.08		
0.14 - 1.5 / 0.14 - 1.5 / 26 - 16			0.14 - 1.5 / 0.14 - 1.5 / 26 - 16			0.14 - 1.5 / 0.14 - 1.5 / 26 - 16		
0.25 - 1			0.25 - 1.5			0.25 - 1		
0.25 - 1			0.25 - 1.5			0.25 - 1		
0.14 - 0.75 / 0.14 - 0.75			0.14 - 0.75 / 0.14 - 0.75			0.14 - 0.75 / 0.14 - 0.75		
0.25 - 0.5			0.25 - 0.5			0.25 - 0.5		
0.5 - 0.5			0.5 - 1			0.5 - 0.5		
III / 3	III / 2	II / 2	III / 3	III / 2	II / 2	III / 3	III / 2	II / 2
250	400	630	250	400	630	250	400	630
4	4	4	4	4	4	4	4	4
B	C	D	B	C	D	B	C	D
300	-	300	300	-	300	300	-	300
10	-	10	10	-	10	10	-	10
30 - 14	-	30 - 14	30 - 14	-	30 - 14	30 - 14	-	30 - 14
B	C	D	B	C	D	B	C	D
150	-	300	-	-	-	150	-	300
10	-	10	-	-	-	10	-	10
28 - 14	-	28 - 14	-	-	-	28 - 14	-	28 - 14
6			6			6		
M3			M3			M3		
0.5 - 0.6			0.5 - 0.6			0.5 - 0.6		
PA / I			PA / I			PA / I		
V0			V0			V2		
1.3 / 0.5 x 1 mm			1.3 / 0.5 x 1 mm			1.3 / 0.5 x 1 mm		

No. of pos.	Dim. a [mm]
2	5.00
3	10.00
4	15.00
5	20.00
6	25.00
7	30.00
8	35.00
2	5.08
3	10.16
4	15.24
5	20.32
6	25.40
7	30.48
8	35.56

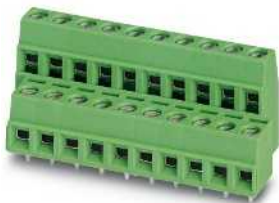

Double-level PCB terminal block with offset levels, with housing overlapping

High PCB terminal block with housing overlapping

Three-level PCB terminal block with offset levels, with housing overlapping



Dimensional drawing

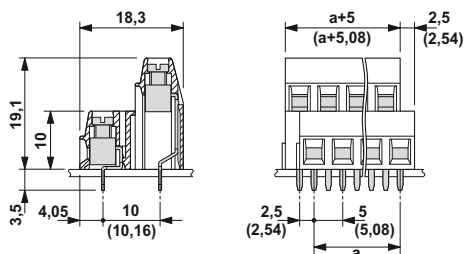

Dimensional drawing

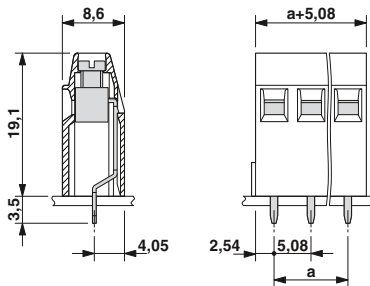

Dimensional drawing

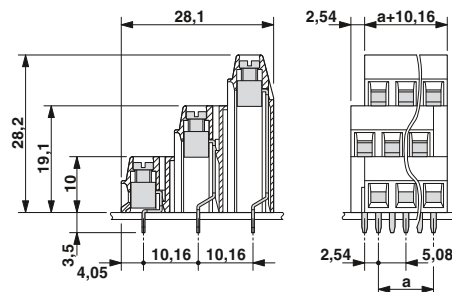

Drilling diagram

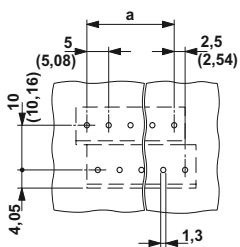

Drilling diagram

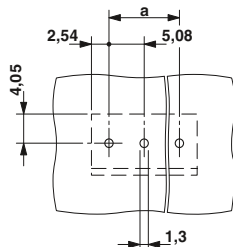

Drilling diagram

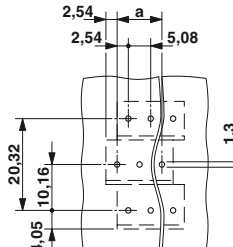

Ordering data

Type	Order No.	Pcs. / Pkt.
5.0 mm pitch, color: green		
MKKDSN 1,5/ 2	1726037	250
MKKDSN 1,5/ 3	1726053	250
MKKDSN 1,5/ 4	1726118	50
MKKDSN 1,5/ 5	1726121	50
MKKDSN 1,5/ 6	1726134	50
MKKDSN 1,5/ 7	1726147	50
MKKDSN 1,5/ 8	1726150	50
5.08 mm pitch, color: green		
MKKDSN 1,5/ 2-5,08	1726040	250
MKKDSN 1,5/ 3-5,08	1726066	250
MKKDSN 1,5/ 4-5,08	1726163	50
MKKDSN 1,5/ 5-5,08	1726176	50
MKKDSN 1,5/ 6-5,08	1726189	50
MKKDSN 1,5/ 7-5,08	1726192	50
MKKDSN 1,5/ 8-5,08	1726202	50

Ordering data

Type	Order No.	Pcs. / Pkt.
5.08 mm pitch, color: green		
MKKDSNH 1,5/ 2-5,08	1731828	50
MKKDSNH 1,5/ 3-5,08	1731831	50
MKKDSNH 1,5/ 4-5,08	1731857	50

Ordering data

Type	Order No.	Pcs. / Pkt.
5.08 mm pitch, color: green		
MK3DSN 1,5/ 2-5,08	1723289	100
MK3DSN 1,5/ 3-5,08	1723292	100

PCB terminal blocks with 2.54 to 7.62 mm pitch

PCB terminal blocks with screw connection for wave soldering processes, currents up to 24 A

Connection cross section of up to 1.5 mm²

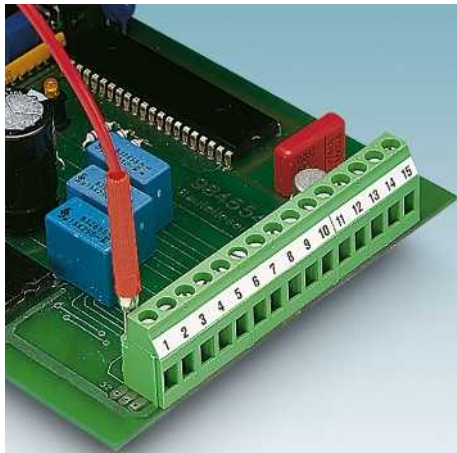

- Single-row PCB terminal blocks for conductor cross sections up to 1.5 mm²
- 5.0 or 5.08 mm pitch

MKDSP 1,5/...

- With a 2.3 mm Ø test connection

SMKDSP 1,5/...

- Conductor and screwdriver axis at an angle of 35° to the PCB
- An arrangement of several terminal block rows one behind the other – multi-level effect with the same design
- With a 2.3 mm Ø test connection

Notes:

In order to avoid tolerances between the terminal blocks and PCB, the terminal row should be interrupted when the number of positions exceeds 30.

1) Please observe the current carrying capacity curves. Further current carrying capacity curves on request.

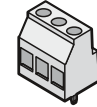



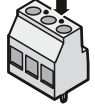

Metric 5 mm pitch



Detection lug for models with 5.08 mm inch pitch

Accessories

For all types	Type	Page
	Marker cards SK 5/3,8 or SK 5,08/3,8	798
	Screwdriver SZS 0,6 x 3,5 Order No. 1205053	
	Insertion bridge EBP...- 5	829
Only for MKDSP 1,5 and SMKDSP 1,5		
	Test plug MPS	831
Only for MKDS 1,5		
	Pitch spacer, width 1.25 mm RZ 1,25-MKDS 1,5 Order No. 1702048	

Current carrying capacity curve

Type: MKDS 1,5/2 and MKDS 1,5/3
Test as per DIN EN 60512-5-2:2003-01
Reduction factor = 1
No. of positions: 5

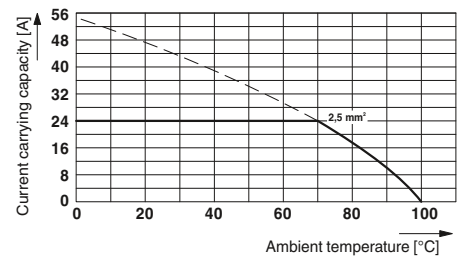

Technical data

Technical data in accordance to IEC / DIN VDE	
Rated current / conductor cross section	[A] / [mm ²]
Rated insulation voltage for pollution degree 2	[V]
Pitch	[mm]
Connection capacity	
Solid / stranded	[mm ²] / [mm ²] / AWG
Stranded with ferrules without plastic sleeve	[mm ²]
Stranded with ferrules with plastic sleeve	[mm ²]
Multi-conductor connection capacity (two conductors with the same cross section)	
Solid / stranded	[mm ²]
Stranded with ferrules without plastic sleeve	[mm ²]
Stranded with TWIN ferrule with plastic sleeve	[mm ²]
Insulation coordination	
Surge voltage category / pollution degree	
Rated insulation voltage	[V]
Rated surge voltage	[kV]
Approval data (UL/CUL)	Use Group
Nominal voltage	[V]
Nominal current	[A]
Connection capacity AWG	AWG
Approval data (CSA)	Use Group
Nominal voltage	[V]
Nominal current	[A]
Connection capacity AWG	AWG
General data	
Stripping length	[mm]
Screw thread	
Tightening torque	[Nm]
Type of insulation material / insulation material group	
Inflammability class according to UL 94	
Drill hole diameter / pin dimensions	[mm]

MKDS 1,5/ ...

17.5 ¹⁾ / 2.5		
400		
5 / 5.08		
0.14 - 2.5 / 0.14 - 1.5 / 26 - 14		
0.25 - 1.5		
0.25 - 1.5		
0.14 - 1 / 0.14 - 0.75		
0.25 - 0.5		
0.5 - 1		
III / 3	III / 2	II / 2
250	400	630
4	4	4
B	C	D
300	-	300
15	-	10
30 - 14	-	30 - 14
B	C	D
300	-	300
10	-	10
28 - 14	-	28 - 14
7		
M3		
0.5 - 0.6		
PA / I		
V0		
1.3 / 0.9 x 0.9 mm		

MKDSP 1,5/ ...

17.5 ¹⁾ / 2.5		
400		
5 / 5.08		
0.14 - 2.5 / 0.14 - 1.5 / 26 - 14		
0.25 - 1.5		
0.25 - 1.5		
0.14 - 1 / 0.14 - 0.75		
0.25 - 0.5		
0.5 - 1		
III / 3	III / 2	II / 2
250	400	630
4	4	4
B	C	D
300	-	300
10	-	10
30 - 14	-	30 - 14
B	C	D
300	-	300
10	-	10
28 - 14	-	28 - 14
7		
M3		
0.5 - 0.6		
PA / I		
V0		
1.3 / 0.9 x 0.9 mm		

SMKDSP 1,5/ ...

17.5 ¹⁾ / 2.5		
400		
5 / 5.08		
0.14 - 2.5 / 0.14 - 1.5 / 26 - 14		
0.25 - 1.5		
0.25 - 1.5		
0.14 - 1 / 0.14 - 0.75		
0.25 - 0.5		
0.5 - 1		
III / 3	III / 2	II / 2
250	400	630
4	4	4
B	C	D
250	-	300
15	-	10
30 - 14	-	30 - 14
B	C	D
300	-	300
10	-	10
28 - 14	-	28 - 14
7		
M3		
0.5 - 0.6		
PA / I		
V0		
1.3 / 0.9 x 0.9 mm		

No. of pos.	Dim. a [mm]
2	5.00
3	10.00
4	15.00
5	20.00
6	25.00
7	30.00
8	35.00
9	40.00
10	45.00
11	50.00
12	55.00
2	5.08
3	10.16
4	15.24
5	20.32
6	25.40
7	30.48
8	35.56
9	40.64
10	45.72
11	50.80
12	55.88



Horizontal connection direction, with housing overlapping



Horizontal connection direction, with test connection and housing overlapping



With 35° angled connection direction, with test connection and housing overlapping



Dimensional drawing

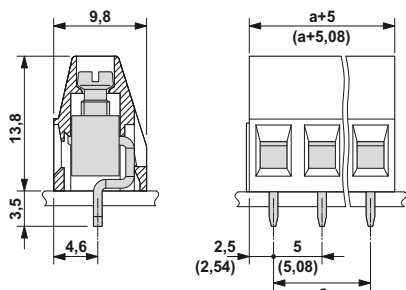

Drilling diagram

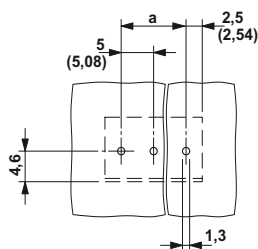

Dimensional drawing

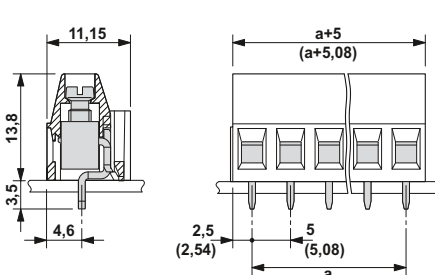

Drilling diagram

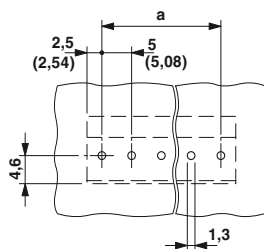

Dimensional drawing

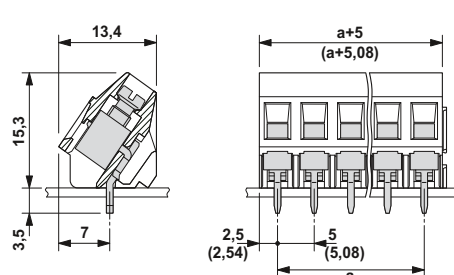

Drilling diagram

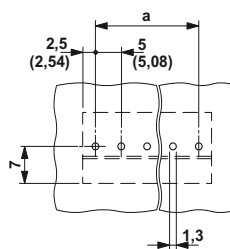

Ordering data

Type	Order No.	Pcs. / Pkt.
5.0 mm pitch, color: green		
MKDS 1,5/ 2	1715022	250
MKDS 1,5/ 3	1715035	250
MKDS 1,5/ 4	1715048	250
MKDS 1,5/ 8	1715080	50
MKDS 1,5/12	1715129	50
5.08 mm pitch, color: green		
MKDS 1,5/ 2-5,08	1715721	250
MKDS 1,5/ 3-5,08	1715734	250
MKDS 1,5/ 4-5,08	1715747	250
MKDS 1,5/ 8-5,08	1715789	50
MKDS 1,5/10-5,08	1715802	50
MKDS 1,5/12-5,08	1715828	50

Ordering data

Type	Order No.	Pcs. / Pkt.
5.0 mm pitch, color: green		
MKDSP 1,5/ 2	1730010	50
MKDSP 1,5/ 3	1730023	50
MKDSP 1,5/ 4	1730036	50
MKDSP 1,5/ 5	1730049	50
MKDSP 1,5/ 6	1730052	50
MKDSP 1,5/ 7	1730065	50
MKDSP 1,5/ 8	1730078	50
MKDSP 1,5/ 9	1730081	50
MKDSP 1,5/10	1730094	50
MKDSP 1,5/11	1730104	50
MKDSP 1,5/12	1730117	50
5.08 mm pitch, color: green		
MKDSP 1,5/ 2-5,08	1730120	50
MKDSP 1,5/ 3-5,08	1730133	50
MKDSP 1,5/ 4-5,08	1730146	50
MKDSP 1,5/ 5-5,08	1730159	50
MKDSP 1,5/ 6-5,08	1730162	50
MKDSP 1,5/ 7-5,08	1730175	50
MKDSP 1,5/ 8-5,08	1730188	50
MKDSP 1,5/ 9-5,08	1730191	50
MKDSP 1,5/10-5,08	1730201	50
MKDSP 1,5/11-5,08	1730214	50
MKDSP 1,5/12-5,08	1730227	50

Ordering data

Type	Order No.	Pcs. / Pkt.
5.0 mm pitch, color: green		
SMKDSP 1,5/ 2	1733415	250
SMKDSP 1,5/ 3	1733428	250
SMKDSP 1,5/ 4	1733431	250
SMKDSP 1,5/ 5	1733444	250
SMKDSP 1,5/ 6	1733457	50
SMKDSP 1,5/ 7	1733460	50
SMKDSP 1,5/ 8	1733473	50
SMKDSP 1,5/ 9	1733486	50
SMKDSP 1,5/10	1733499	50
SMKDSP 1,5/11	1733509	50
SMKDSP 1,5/12	1733512	50
5.08 mm pitch, color: green		
SMKDSP 1,5/ 2-5,08	1733570	250
SMKDSP 1,5/ 3-5,08	1733583	250
SMKDSP 1,5/ 4-5,08	1733596	250
SMKDSP 1,5/ 5-5,08	1733606	250
SMKDSP 1,5/ 6-5,08	1733619	50
SMKDSP 1,5/ 7-5,08	1733622	50
SMKDSP 1,5/ 8-5,08	1733635	50
SMKDSP 1,5/ 9-5,08	1733648	50
SMKDSP 1,5/10-5,08	1733651	50
SMKDSP 1,5/11-5,08	1733664	50
SMKDSP 1,5/12-5,08	1733677	50

PCB terminal blocks with 2.54 to 7.62 mm pitch

PCB terminal blocks with screw connection for wave soldering processes, currents up to 24 A

Connection cross section of up to 1.5 mm²



– 5.0 or 5.08 mm pitch

MKDSFW 1,5/...

- Horizontal series with vertical connection direction to the PCB
- with stand-off/offset

MKDS 1,5-B

- PCB terminal block with internally bridged soldering metal
- Looping through common potentials irrespective of the conducting path

MKKDS 1,5/...

- Double-row type for conductor cross sections up to 1.5 mm² with horizontal connection direction

Notes:

In order to avoid tolerances between the terminal blocks and PCB, the terminal row should be interrupted when the number of positions exceeds 30.

1) Please observe the current carrying capacity curves. Further current carrying capacity curves on request.

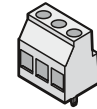

Metric 5 mm pitch

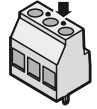

Detection lug for models with 5.08 mm inch pitch

Accessories

For all types	Type	Page
	Marker cards SK 5/3,8 or SK 5,08/3,8	798
	Screwdriver SZS 0,6 x 3,5 Order No. 1205053	
	Insertion bridge EBP... 5	829

Current carrying capacity curve

Type: MKKDS 1,5/2 and MKKDS 1,5/3
Test following DIN EN 60512-5-2:2003-01
Reduction factor = 1
No. of positions: 5

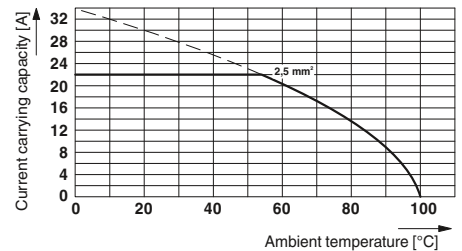

Technical data

Technical data in accordance to IEC / DIN VDE

Rated current / conductor cross section [A] / [mm²]
Rated insulation voltage for pollution degree 2 [V]

Pitch [mm]

Connection capacity

Solid / stranded [mm²] / [mm²] / AWG

Stranded with ferrules without plastic sleeve [mm²]

Stranded with ferrules with plastic sleeve [mm²]

Multi-conductor connection capacity (two conductors with the same cross section)

Solid / stranded [mm²]

Stranded with ferrules without plastic sleeve [mm²]

Stranded with TWIN ferrule with plastic sleeve [mm²]

Insulation coordination

Surge voltage category / pollution degree

Rated insulation voltage [V]

Rated surge voltage [kV]

Approval data (UL/CUL) Use Group

Nominal voltage [V]

Nominal current [A]

Connection capacity AWG AWG

Approval data (CSA) Use Group

Nominal voltage [V]

Nominal current [A]

Connection capacity AWG AWG

General data

Stripping length [mm]

Screw thread

Tightening torque [Nm]

Type of insulation material / insulation material group

Inflammability class according to UL 94

Drill hole diameter / pin dimensions [mm]

	MKDSFW 1,5/ ...			MKDS 1,5/ ...-B-5,08			MKKDS 1,5/ ...			No. of pos.	Dim. a [mm]
Rated current / conductor cross section [A] / [mm ²]	17.5 ¹⁾ / 2.5			17.5 ¹⁾ / 2.5			17.5 ¹⁾ / 2.5			2	5.00
Rated insulation voltage for pollution degree 2 [V]	400			400			400			3	10.00
Pitch [mm]	5			5.08			5 / 5.08				
Connection capacity										2	5.08
Solid / stranded [mm ²] / [mm ²] / AWG	0.14 - 2.5 / 0.14 - 1.5 / 26 - 14			0.14 - 2.5 / 0.14 - 1.5 / 26 - 14			0.14 - 2.5 / 0.14 - 1.5 / 26 - 14			3	10.16
Stranded with ferrules without plastic sleeve [mm ²]	0.25 - 1.5			0.25 - 1.5			0.25 - 1				
Stranded with ferrules with plastic sleeve [mm ²]	0.25 - 1.5			0.25 - 1.5			0.25 - 1.5			2	5.08
Multi-conductor connection capacity (two conductors with the same cross section)										3	10.16
Solid / stranded [mm ²]	0.14 - 1 / 0.14 - 0.75			0.14 - 1 / 0.14 - 0.75			0.14 - 1 / 0.14 - 0.75				
Stranded with ferrules without plastic sleeve [mm ²]	0.25 - 0.5			0.25 - 0.5			0.25 - 0.5			2	5.08
Stranded with TWIN ferrule with plastic sleeve [mm ²]	0.5 - 1			0.5 - 1			0.5 - 0.5			3	10.16
Insulation coordination											
Surge voltage category / pollution degree	III / 3	III / 2	II / 2	III / 3	III / 2	II / 2	III / 3	III / 2	II / 2	2	5.08
Rated insulation voltage [V]	250	400	630	250	400	630	250	400	630	3	10.16
Rated surge voltage [kV]	4	4	4	4	4	4	4	4	4		
Approval data (UL/CUL) Use Group	B	C	D	B	C	D	B	C	D		
Nominal voltage [V]	300	-	300	300	-	300	125	-	300		
Nominal current [A]	10	-	10	10	-	10	10	-	10		
Connection capacity AWG AWG	30 - 14	-	30 - 14	30 - 14	-	30 - 14	30 - 14	-	30 - 14		
Approval data (CSA) Use Group	B	C	D	B	C	D	B	C	D		
Nominal voltage [V]	300	-	300	-	-	-	300	-	300		
Nominal current [A]	10	-	10	-	-	-	10	-	10		
Connection capacity AWG AWG	24 - 14	-	24 - 14	-	-	-	28 - 14	-	28 - 14		
General data											
Stripping length [mm]	8			7			7				
Screw thread	M3			M3			M3				
Tightening torque [Nm]	0.5 - 0.6			0.5 - 0.6			0.5 - 0.6				
Type of insulation material / insulation material group	PA / I			PA / I			PA / I				
Inflammability class according to UL 94	V2			V0			V0				
Drill hole diameter / pin dimensions [mm]	1.3 / 0.9 x 0.9 mm			1.3 / 0.9 x 0.9 mm			1.3 / 0.9 x 0.9 mm				

PCB terminal blocks with 2.54 to 7.62 mm pitch

PCB terminal blocks with screw connection for wave soldering processes, currents up to 24 A

Connection cross section of up to 1.5 mm²

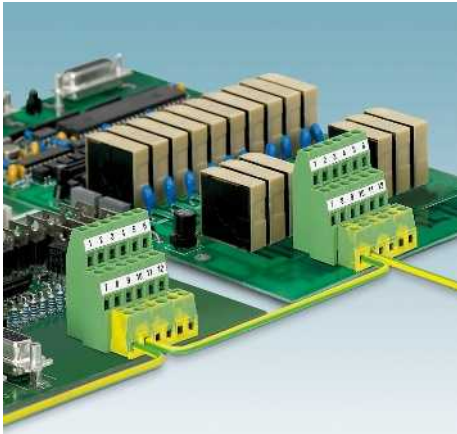

MK3DS 1,5/...

- Three-level type with high packaging and connection density

MK3DS 1,5/...-A....

- Three-level type with internally bridged PE distributor terminal block in the lower level

MK3DS 1,5/...-BC...

- Three-level type without distributor terminal block in the lower level
- Multi-level PCB terminal block with offset levels for optimum accessibility of the terminal points

Notes:

In order to avoid tolerances between the terminal blocks and PCB, the terminal row should be interrupted when the number of positions exceeds 30.

1) Please observe the current carrying capacity curves. Further current carrying capacity curves on request.

2) 1. Level

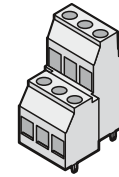

Metric 5 mm pitch

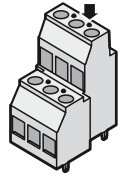

Detection lug for models with 5.08 mm inch pitch

Accessories

For all types	Type	Page
	Marker cards SK 5,08/3,8	798
	Screwdriver SZS 0,6 x 3,5 Order No. 1205053	
	Insertion bridge EBP...-5	829

Current carrying capacity curve

Type: MK3DS 1,5/...-5,08
Test following DIN EN 60512-5-2:2003-01
Reduction factor = 1
No. of positions: 5

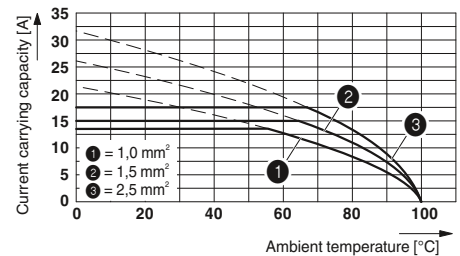

Technical data

Technical data in accordance to IEC / DIN VDE

Rated current / conductor cross section	[A] / [mm ²]
Rated insulation voltage for pollution degree 2	[V]
Pitch	[mm]
Connection capacity	
Solid / stranded	[mm ²] / [mm ²] / AWG
Stranded with ferrules without plastic sleeve	[mm ²]
Stranded with ferrules with plastic sleeve	[mm ²]
Multi-conductor connection capacity (two conductors with the same cross section)	
Solid / stranded	[mm ²]
Stranded with ferrules without plastic sleeve	[mm ²]
Stranded with TWIN ferrule with plastic sleeve	[mm ²]
Insulation coordination	
Surge voltage category / pollution degree	
Rated insulation voltage	[V]
Rated surge voltage	[kV]
Approval data (UL/CUL)	Use Group
Nominal voltage	[V]
Nominal current	[A]
Connection capacity AWG	AWG
Approval data (CSA)	Use Group
Nominal voltage	[V]
Nominal current	[A]
Connection capacity AWG	AWG
General data	
Stripping length	[mm]
Screw thread	
Tightening torque	[Nm]
Type of insulation material / insulation material group	
Inflammability class according to UL 94	
Drill hole diameter / pin dimensions	[mm]

MK3DS 1,5/ ...-5,08

Rated current / conductor cross section	15 ¹⁾ / 2.5
Rated insulation voltage for pollution degree 2	400
Pitch	5.08
Connection capacity	
Solid / stranded	0.14 - 2.5 / 0.14 - 1.5 / 26 - 14
Stranded with ferrules without plastic sleeve	0.25 - 1.5
Stranded with ferrules with plastic sleeve	0.25 - 1.5
Multi-conductor connection capacity (two conductors with the same cross section)	
Solid / stranded	0.14 - 1 / 0.14 - 0.75
Stranded with ferrules without plastic sleeve	0.25 - 0.5
Stranded with TWIN ferrule with plastic sleeve	0.5 - 0.5 ²⁾
Insulation coordination	
Surge voltage category / pollution degree	III / 3 III / 2 II / 2
Rated insulation voltage	250 400 630
Rated surge voltage	4 4 4
Approval data (UL/CUL)	B C D
Nominal voltage	125 - 300
Nominal current	10 - 10
Connection capacity AWG	30 - 14 - 30 - 14
Approval data (CSA)	B C D
Nominal voltage	300 - 300
Nominal current	10 - 10
Connection capacity AWG	28 - 14 - 28 - 14
General data	
Stripping length	7
Screw thread	M3
Tightening torque	0.5 - 0.6
Type of insulation material / insulation material group	PA / I
Inflammability class according to UL 94	V0
Drill hole diameter / pin dimensions	1.3 / 0.9 x 0.9 mm

MK3DS 1,5/ ...-5,08-A-GNYE

Rated current / conductor cross section	15 ¹⁾ / 2.5
Rated insulation voltage for pollution degree 2	400
Pitch	5.08
Connection capacity	
Solid / stranded	0.14 - 2.5 / 0.14 - 1.5 / 26 - 14
Stranded with ferrules without plastic sleeve	0.25 - 1.5
Stranded with ferrules with plastic sleeve	0.25 - 1.5
Multi-conductor connection capacity (two conductors with the same cross section)	
Solid / stranded	0.14 - 1 / 0.14 - 0.75
Stranded with ferrules without plastic sleeve	0.25 - 0.5
Stranded with TWIN ferrule with plastic sleeve	0.5 - 0.5
Insulation coordination	
Surge voltage category / pollution degree	III / 3 III / 2 II / 2
Rated insulation voltage	250 400 630
Rated surge voltage	4 4 4
Approval data (UL/CUL)	B C D
Nominal voltage	125 - 300
Nominal current	10 - 10
Connection capacity AWG	30 - 14 - 30 - 14
Approval data (CSA)	B C D
Nominal voltage	- - -
Nominal current	- - -
Connection capacity AWG	- - -
General data	
Stripping length	7
Screw thread	M3
Tightening torque	0.5 - 0.6
Type of insulation material / insulation material group	PA / I
Inflammability class according to UL 94	V0
Drill hole diameter / pin dimensions	1.3 / 0.9 x 0.9 mm

MK3DS 1,5/ ...-5,08-BC

Rated current / conductor cross section	15 ¹⁾ / 2.5
Rated insulation voltage for pollution degree 2	400
Pitch	5.08
Connection capacity	
Solid / stranded	0.14 - 2.5 / 0.14 - 1.5 / 26 - 14
Stranded with ferrules without plastic sleeve	0.25 - 1.5
Stranded with ferrules with plastic sleeve	0.25 - 1.5
Multi-conductor connection capacity (two conductors with the same cross section)	
Solid / stranded	0.14 - 1 / 0.14 - 0.75
Stranded with ferrules without plastic sleeve	0.25 - 0.5
Stranded with TWIN ferrule with plastic sleeve	0.5 - 0.5
Insulation coordination	
Surge voltage category / pollution degree	III / 3 III / 2 II / 2
Rated insulation voltage	250 400 630
Rated surge voltage	4 4 4
Approval data (UL/CUL)	B C D
Nominal voltage	125 - 300
Nominal current	10 - 10
Connection capacity AWG	30 - 14 - 30 - 14
Approval data (CSA)	B C D
Nominal voltage	- - -
Nominal current	- - -
Connection capacity AWG	- - -
General data	
Stripping length	7
Screw thread	M3
Tightening torque	0.5 - 0.6
Type of insulation material / insulation material group	PA / I
Inflammability class according to UL 94	V0
Drill hole diameter / pin dimensions	1.3 / 0.9 x 0.9 mm

No. of pos.	Dim. a [mm]
2	5.08
3	10.16



With offset levels and housing overlapping



With internally bridged PE distributor terminal block in the lower level, with housing overlapping



Without distributor terminal block in the lower level, with housing overlapping



Dimensional drawing

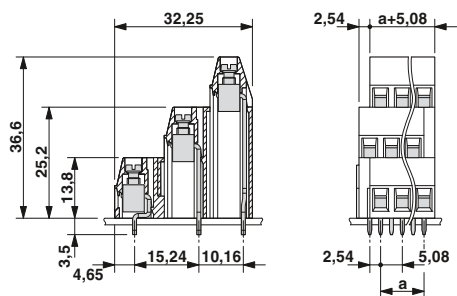

Drilling diagram

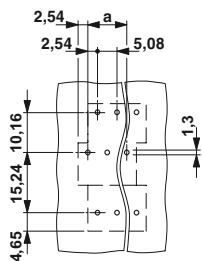

Ordering data

Type	Order No.	Pcs. / Pkt.
5.08 mm pitch, color: green		
MK3DS 1,5/ 2-5,08	1724013	100
MK3DS 1,5/ 3-5,08	1724026	100



Dimensional drawing

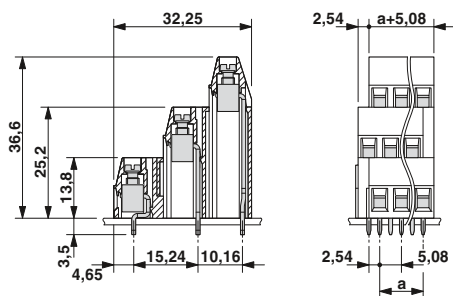

Drilling diagram

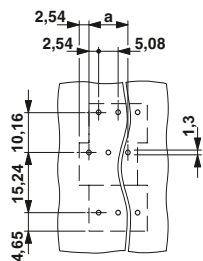

Ordering data

Type	Order No.	Pcs. / Pkt.
5.08 mm pitch, color: green/green-yellow		
MK3DS 1,5/ 2-5,08-A-GNYE	1868717	50
MK3DS 1,5/ 3-5,08-A-GNYE	1868720	50



Dimensional drawing

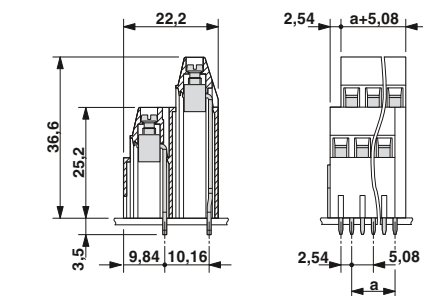

Drilling diagram

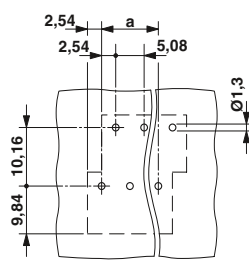

Ordering data

Type	Order No.	Pcs. / Pkt.
5.08 mm pitch, color: green		
MK3DS 1,5/ 2-5,08-BC	1706413	50
MK3DS 1,5/ 3-5,08-BC	1706426	50

PCB terminal blocks with 2.54 to 7.62 mm pitch

PCB terminal blocks with screw connection for wave soldering processes, currents up to 24 A

Connection cross section of up to 1.5 mm²

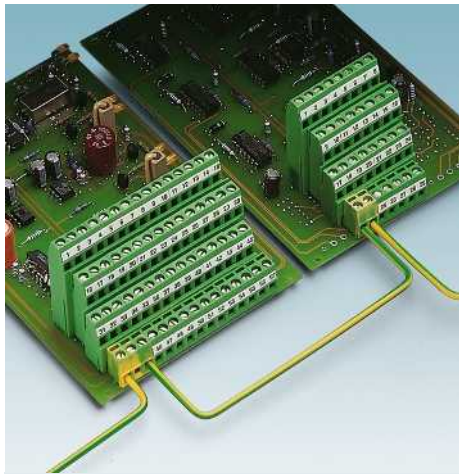

– 5.08 mm pitch

MK4DS 1,5 / ...

– Four-level type with high packaging and connection density

MK4DS 1,5/...-A...

– Four-level type with internally bridged PE distributor terminal block in the lower level

MK4DS 1,5/...-BCD...

– Four-level type without distributor terminal block in the lower level
– Multi-level PCB terminal block with offset levels for optimum accessibility of the terminal points

Notes:

In order to avoid tolerances between the terminal blocks and PCB, the terminal row should be interrupted when the number of positions exceeds 30.

1) Please observe the current carrying capacity curves. Further current carrying capacity curves on request.

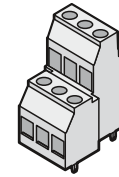

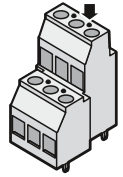

Metric 5 mm pitch



Detection lug for models with 5.08 mm inch pitch

Accessories

For all types	Type	Page
	Marker cards SK 5/3,8 or SK 5,08/3,8	798
	Screwdriver SZS 0,6 x 3,5 Order No. 1205053	
	Insertion bridge EBP... 5	829

Current carrying capacity curve

Type: MK4DS 1,5/2-5,08 and MK4DS 1,5/3-5,08
Test following DIN EN 60512-5-2:2003-01
Reduction factor = 1
No. of positions: 5

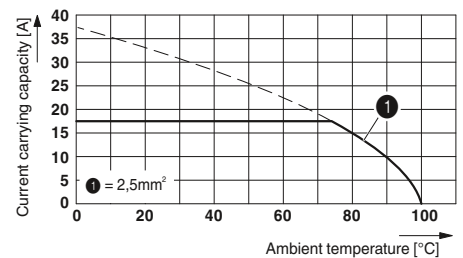

Technical data

Technical data in accordance to IEC / DIN VDE

Rated current / conductor cross section [A] / [mm²]
Rated insulation voltage for pollution degree 2 [V]

Pitch [mm]

Connection capacity

Solid / stranded [mm²] / [mm²] / AWG

Stranded with ferrules without plastic sleeve [mm²]

Stranded with ferrules with plastic sleeve [mm²]

Multi-conductor connection capacity (two conductors with the same cross section)

Solid / stranded [mm²]

Stranded with ferrules without plastic sleeve [mm²]

Stranded with TWIN ferrule with plastic sleeve [mm²]

Insulation coordination

Surge voltage category / pollution degree

Rated insulation voltage [V]

Rated surge voltage [kV]

Approval data (UL/CUL) Use Group

Nominal voltage [V]

Nominal current [A]

Connection capacity AWG AWG

Approval data (CSA) Use Group

Nominal voltage [V]

Nominal current [A]

Connection capacity AWG AWG

General data

Stripping length [mm]

Screw thread

Tightening torque [Nm]

Type of insulation material / insulation material group

Inflammability class according to UL 94

Drill hole diameter / pin dimensions [mm]

MK4DS 1,5/ ...-5,08

15¹⁾ / 2.5
400

5.08

0.14 - 2.5 / 0.14 - 1.5 / 26 - 14

0.25 - 1.5

0.25 - 1.5

0.14 - 1 / 0.14 - 0.75

0.25 - 0.5

0.5 - 0.5

III / 3 III / 2 II / 2

250 400 630

4 4 4

B C D

125 - 300

10 - 10

30 - 14 - 30 - 14

B C D

- - -

- - -

- - -

- - -

7

M3

0.5 - 0.6

PA / I

V0

1.3 / 0.9 x 0.9 mm

MK4DS 1,5/ ...-5,08-A GNYE

15¹⁾ / 2.5
400

5.08

0.14 - 2.5 / 0.14 - 1.5 / 26 - 14

0.25 - 1.5

0.25 - 1.5

0.14 - 1 / 0.14 - 0.75

0.25 - 0.5

0.5 - 0.5

III / 3 III / 2 II / 2

250 400 630

4 4 4

B C D

125 - 300

10 - 10

30 - 14 - 30 - 14

B C D

- - -

- - -

- - -

7

M3

0.5 - 0.6

PA / I

V0

1.3 / 0.9 x 0.9 mm

MK4DS 1,5/ ...-5,08-BCD

15¹⁾ / 2.5
400

5.08

0.14 - 2.5 / 0.14 - 1.5 / 26 - 14

0.25 - 1.5

0.25 - 1.5

0.14 - 1 / 0.14 - 0.75

0.25 - 0.5

0.5 - 0.5

III / 3 III / 2 II / 2

250 400 630

4 4 4

B C D

125 - 300

10 - 10

30 - 14 - 30 - 14

B C D

- - -

- - -

- - -

7

M3

0.5 - 0.6

PA / I

V0

1.3 / 0.9 x 0.9 mm

No. of pos.	Dim. a [mm]
2	5.08
3	10.16



With offset levels and housing overlapping

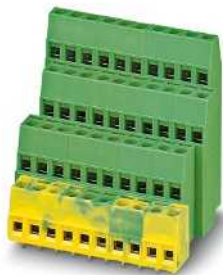

With internally bridged PE distributor terminal block in the lower level and housing overlapping



Without distributor terminal block in the lower level, with housing overlapping



Dimensional drawing

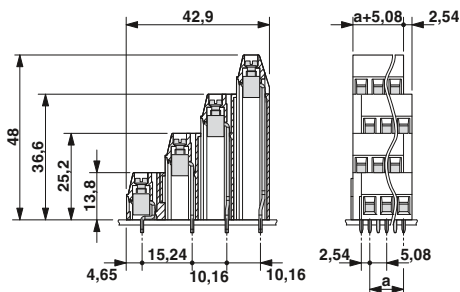

Drilling diagram

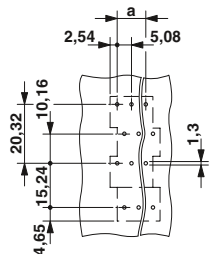

Ordering data

Type	Order No.	Pcs. / Pkt.
5.08 mm pitch, color: green		
MK4DS 1,5/ 2-5,08	1868827	50
MK4DS 1,5/ 3-5,08	1868830	50



Dimensional drawing

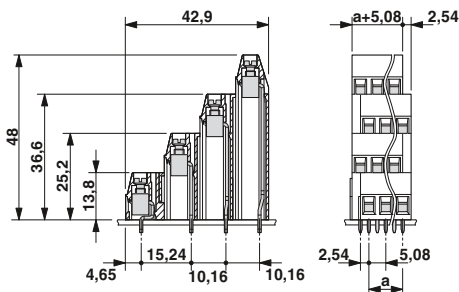

Drilling diagram

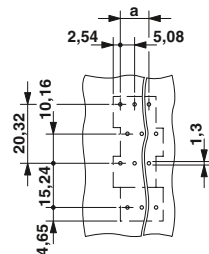

Ordering data

Type	Order No.	Pcs. / Pkt.
5.08 mm pitch, color: green/green-yellow		
MK4DS 1,5/ 2-5,08-A GNYE	1707001	50
MK4DS 1,5/ 3-5,08-A GNYE	1707140	50



Dimensional drawing

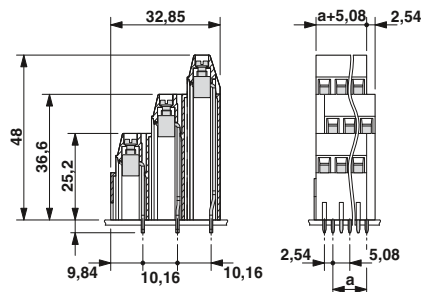

Drilling diagram

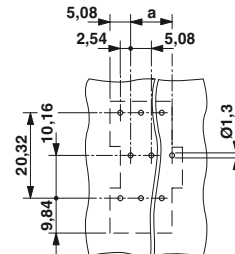

Ordering data

Type	Order No.	Pcs. / Pkt.
5.08 mm pitch, color: green		
MK4DS 1,5/ 2-5,08-BCD	1706947	50
MK4DS 1,5/ 3-5,08-BCD	1706950	50

PCB terminal blocks with 2.54 to 7.62 mm pitch

PCB terminal blocks with screw connection for wave soldering processes, currents up to 24 A

Connection cross section of up to 2.5 mm²

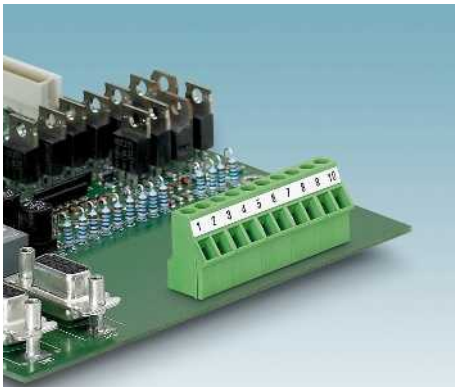

MKDSN 2,5/...

- Low design, generously dimensioned
- 2.5 mm² connection cross section
- 5.0 or 5.08 mm pitch
- +/- screw

SMKDS 2,5/...

- Conductor connection at an angle of 40° to the PCB
- Screwdriver axis vertical to the PCB
- 5.08 mm pitch

Notes:

In order to avoid tolerances between the terminal blocks and PCB, the terminal row should be interrupted when the number of positions exceeds 30.

1) Please observe the current carrying capacity curves. Further current carrying capacity curves on request.

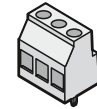

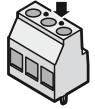

Metric 5 mm pitch



Detection lug for models with 5.08 mm inch pitch

Accessories

For all types	Type	Page
	Marker cards SK 5/3,8 or SK 5,08/3,8	798
	Screwdriver SZS 0,6 x 3,5 Order No. 1205053	
	Insertion bridge EBP... 5	829

Current carrying capacity curve

Type: MKDSN 2,5/2
Test following DIN EN 60512-5-2:2003-01
Reduction factor = 1
No. of positions: 5

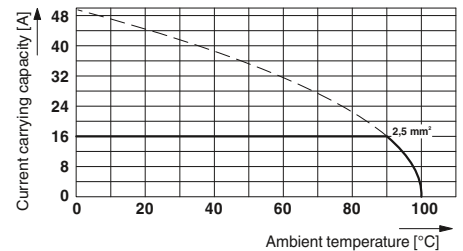

Technical data

Technical data in accordance to IEC / DIN VDE	
Rated current / conductor cross section	[A] / [mm ²]
Rated insulation voltage for pollution degree 2	[V]
Pitch	[mm]
Connection capacity	
Solid / stranded	[mm ²] / [mm ²] / AWG
Stranded with ferrules without plastic sleeve	[mm ²]
Stranded with ferrules with plastic sleeve	[mm ²]
Multi-conductor connection capacity (two conductors with the same cross section)	
Solid / stranded	[mm ²]
Stranded with ferrules without plastic sleeve	[mm ²]
Stranded with TWIN ferrule with plastic sleeve	[mm ²]
Insulation coordination	
Surge voltage category / pollution degree	
Rated insulation voltage	[V]
Rated surge voltage	[kV]
Approval data (UL/CUL)	Use Group
Nominal voltage	[V]
Nominal current	[A]
Connection capacity AWG	AWG
Approval data (CSA)	Use Group
Nominal voltage	[V]
Nominal current	[A]
Connection capacity AWG	AWG
General data	
Stripping length	[mm]
Screw thread	
Tightening torque	[Nm]
Type of insulation material / insulation material group	
Inflammability class according to UL 94	
Drill hole diameter / pin dimensions	[mm]

MKDSN 2,5/ ...

16 ¹⁾ / 2.5		
400		
5 / 5.08		
0.2 - 2.5 / 0.2 - 2.5 / 24 - 14		
0.25 - 2.5		
0.25 - 2.5		
0.2 - 0.75 / 0.2 - 0.75		
0.25 - 0.75		
0.5 - 1.5		
III / 3	III / 2	II / 2
250	400	630
4	4	4
B	C	D
300	-	300
20	-	15
30 - 12	-	30 - 12
B	C	D
-	-	-
-	-	-
-	-	-
6.5		
M3		
0.5 - 0.6		
PA / I		
V0		
1.3 / 0.8 x 0.9 mm		

SMKDS 2,5/ ...-5,08

20 ¹⁾ / 2.5		
400		
5.08		
0.14 - 2.5 / 0.14 - 2.5 / 26 - 14		
0.25 - 2.5		
0.25 - 2.5		
0.14 - 0.75 / 0.14 - 0.75		
0.25 - 0.75		
0.5 - 1.5		
III / 3	III / 2	II / 2
250	400	630
4	4	4
B	C	D
250	-	300
10	-	10
30 - 12	-	30 - 12
B	C	D
-	-	-
-	-	-
-	-	-
11		
M3		
0.5 - 0.6		
PA / I		
V0		
1.4 / 1 x 0.9 mm		

No. of pos.	Dim. a [mm]
2	5.00
3	10.00
4	15.00
2	5.08
3	10.16
4	15.24
5	20.32
6	25.40
7	30.48
8	35.56
9	40.64
10	45.72



Low-profile design, with housing overlapping



With 40° angled connection direction and housing overlapping



Dimensional drawing

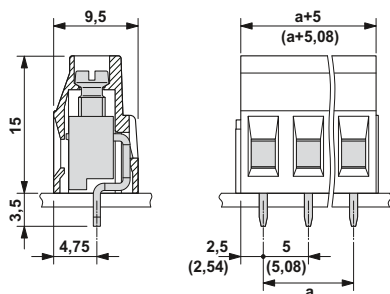

Drilling diagram

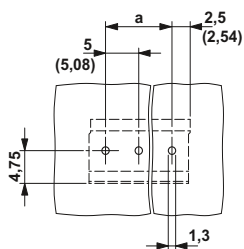

Dimensional drawing

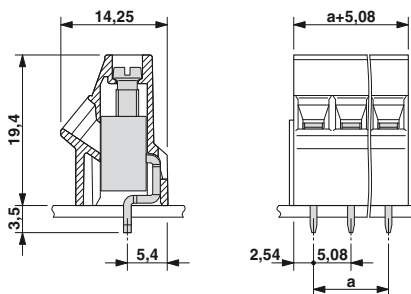

Drilling diagram

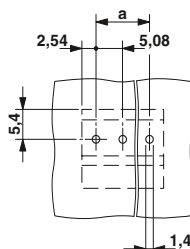

Ordering data

Type	Order No.	Pcs. / Pkt.
5.0 mm pitch, color: green		
MKDSN 2,5/ 2	1890963	250
MKDSN 2,5/ 3	1890976	250
MKDSN 2,5/ 4	1890989	250
5.08 mm pitch, color: green		
MKDSN 2,5/ 2-5,08	1888687	250
MKDSN 2,5/ 3-5,08	1888690	250
MKDSN 2,5/ 4-5,08	1888700	250

Ordering data

Type	Order No.	Pcs. / Pkt.
5.08 mm pitch, color: green		
SMKDS 2,5/ 2-5,08	1705469	50
SMKDS 2,5/ 3-5,08	1705472	50
SMKDS 2,5/ 4-5,08	1995664	50
SMKDS 2,5/ 5-5,08	1702558	50
SMKDS 2,5/ 6-5,08	1736777	50
SMKDS 2,5/ 7-5,08	1766174	50
SMKDS 2,5/ 8-5,08	1736845	50
SMKDS 2,5/ 9-5,08	1701626	50
SMKDS 2,5/10-5,08	1736780	50

PCB terminal blocks with 2.54 to 7.62 mm pitch

PCB terminal blocks with screw connection for wave soldering processes, currents up to 24 A

Connection cross section of up to 2.5 mm²

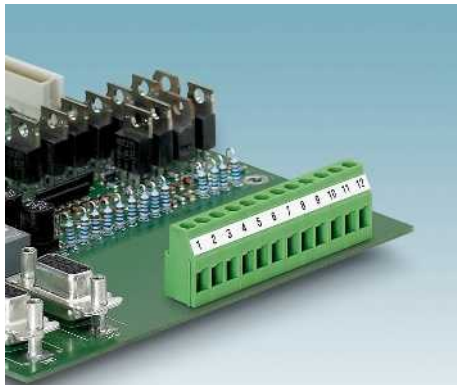

– Standard PCB terminal blocks with 5.0 or 5.08 mm pitch

MKDS 3/...-B-5,08

– Distributor terminal block with an internally bridged soldering metal
– Looping through common potentials irrespective of the conducting path

MKDSP 3/...

– With integrated test connection to accommodate 2 mm Ø test pins or 2.3 mm Ø test plugs

Notes:

In order to avoid tolerances between the terminal blocks and PCB, the terminal row should be interrupted when the number of positions exceeds 30.

1) Please observe the current carrying capacity curves. Further current carrying capacity curves on request.

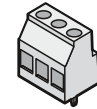

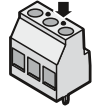

Metric 5 mm pitch



Detection lug for models with 5.08 mm inch pitch

Accessories

For all types	Type	Page
	Marker cards SK 5/3,8 or SK 5,08/3,8	798
	Screwdriver SZS 0,6 x 3,5 Order No. 1205053	
	Insertion bridge EBP... 5	829
	Single cover for individual terminal positions EA-MKDS Order No. 1711408	
Only for MKDS 3		
	Pitch spacer, width 1.25 mm RZ 1,25-MKDS 3 Order No. 1703047	
Only for MKDSP 3		
	Test plug MPS	831

Current carrying capacity curve

Type: MKDS 3/2 and MKDS 3/3
Test following DIN EN 60512-5-2:2003-01
Reduction factor = 1
No. of positions: 5

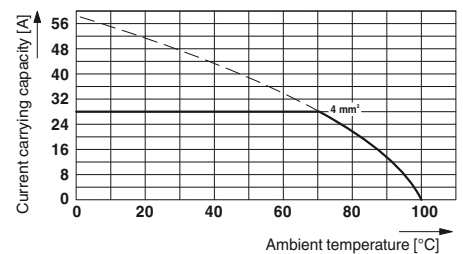

Technical data

Technical data in accordance to IEC / DIN VDE

Rated current / conductor cross section	[A] / [mm ²]
Rated insulation voltage for pollution degree 2	[V]
Pitch	[mm]
Connection capacity	
Solid / stranded	[mm ²] / [mm ²] / AWG
Stranded with ferrules without plastic sleeve	[mm ²]
Stranded with ferrules with plastic sleeve	[mm ²]
Multi-conductor connection capacity (two conductors with the same cross section)	
Solid / stranded	[mm ²]
Stranded with ferrules without plastic sleeve	[mm ²]
Stranded with TWIN ferrule with plastic sleeve	[mm ²]
Insulation coordination	
Surge voltage category / pollution degree	
Rated insulation voltage	[V]
Rated surge voltage	[kV]
Approval data (UL/CUL)	Use Group
Nominal voltage	[V]
Nominal current	[A]
Connection capacity AWG	AWG
Approval data (CSA)	Use Group
Nominal voltage	[V]
Nominal current	[A]
Connection capacity AWG	AWG
General data	
Stripping length	[mm]
Screw thread	
Tightening torque	[Nm]
Type of insulation material / insulation material group	
Inflammability class according to UL 94	
Drill hole diameter / pin dimensions	[mm]

MKDS 3/ ...

Rated current / conductor cross section	24 ¹⁾ / 4
Rated insulation voltage for pollution degree 2	400
Pitch	5 / 5.08
Connection capacity	
Solid / stranded	0.2 - 4 / 0.2 - 2.5 / 24 - 12
Stranded with ferrules without plastic sleeve	0.25 - 2.5
Stranded with ferrules with plastic sleeve	0.25 - 2.5
Multi-conductor connection capacity (two conductors with the same cross section)	
Solid / stranded	0.2 - 1.5 / 0.2 - 1.5
Stranded with ferrules without plastic sleeve	0.25 - 0.75
Stranded with TWIN ferrule with plastic sleeve	0.5 - 1.5
Insulation coordination	
Surge voltage category / pollution degree	III / 3 III / 2 II / 2
Rated insulation voltage	250 400 630
Rated surge voltage	4 4 4
Approval data (UL/CUL)	B C D
Nominal voltage	300 - 300
Nominal current	15 - 10
Connection capacity AWG	30 - 12 - 30 - 12
Approval data (CSA)	B C D
Nominal voltage	300 - 300
Nominal current	10 - 10
Connection capacity AWG	28 - 12 - 28 - 12
General data	
Stripping length	8
Screw thread	M3
Tightening torque	0.5 - 0.6
Type of insulation material / insulation material group	PA / I
Inflammability class according to UL 94	V0
Drill hole diameter / pin dimensions	1.3 / 0.9 x 0.9 mm

MKDS 3/ ...-B-5,08

Rated current / conductor cross section	24 ¹⁾ / 4
Rated insulation voltage for pollution degree 2	400
Pitch	5.08
Connection capacity	
Solid / stranded	0.2 - 4 / 0.2 - 2.5 / 24 - 12
Stranded with ferrules without plastic sleeve	0.25 - 2.5
Stranded with ferrules with plastic sleeve	0.25 - 2.5
Multi-conductor connection capacity (two conductors with the same cross section)	
Solid / stranded	0.2 - 1.5 / 0.2 - 1.5
Stranded with ferrules without plastic sleeve	0.25 - 0.75
Stranded with TWIN ferrule with plastic sleeve	0.5 - 1.5
Insulation coordination	
Surge voltage category / pollution degree	III / 3 III / 2 II / 2
Rated insulation voltage	250 400 630
Rated surge voltage	4 4 4
Approval data (UL/CUL)	B C D
Nominal voltage	300 - 300
Nominal current	15 - 10
Connection capacity AWG	30 - 12 - 30 - 12
Approval data (CSA)	B C D
Nominal voltage	300 - 300
Nominal current	10 - 10
Connection capacity AWG	28 - 12 - 28 - 12
General data	
Stripping length	8
Screw thread	M3
Tightening torque	0.5 - 0.6
Type of insulation material / insulation material group	PA / I
Inflammability class according to UL 94	V0
Drill hole diameter / pin dimensions	1.3 / 0.9 x 0.9 mm

MKDSP 3/ ...

Rated current / conductor cross section	24 ¹⁾ / 4
Rated insulation voltage for pollution degree 2	400
Pitch	5 / 5.08
Connection capacity	
Solid / stranded	0.2 - 4 / 0.2 - 2.5 / 24 - 12
Stranded with ferrules without plastic sleeve	0.25 - 2.5
Stranded with ferrules with plastic sleeve	0.25 - 2.5
Multi-conductor connection capacity (two conductors with the same cross section)	
Solid / stranded	0.2 - 1.5 / 0.2 - 1.5
Stranded with ferrules without plastic sleeve	0.25 - 0.75
Stranded with TWIN ferrule with plastic sleeve	0.5 - 1.5
Insulation coordination	
Surge voltage category / pollution degree	III / 3 III / 2 II / 2
Rated insulation voltage	250 400 630
Rated surge voltage	4 4 4
Approval data (UL/CUL)	B C D
Nominal voltage	250 - 300
Nominal current	15 - 10
Connection capacity AWG	30 - 12 - 30 - 12
Approval data (CSA)	B C D
Nominal voltage	300 - 300
Nominal current	10 - 10
Connection capacity AWG	28 - 12 - 28 - 12
General data	
Stripping length	8
Screw thread	M3
Tightening torque	0.5 - 0.6
Type of insulation material / insulation material group	PA / II
Inflammability class according to UL 94	V0
Drill hole diameter / pin dimensions	1.3 / 0.9 x 0.9 mm

No. of pos.	Dim. a [mm]
2	5.00
3	10.00
4	15.00
2	5.08
3	10.16
4	15.24
2	5.08
3	10.16
2	5.08
3	10.16

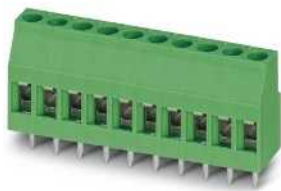

With housing overlapping



With housing overlapping, bridged internally

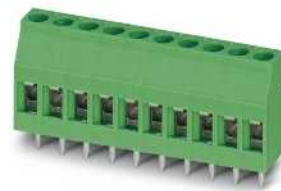

With housing overlapping and test connection



Dimensional drawing

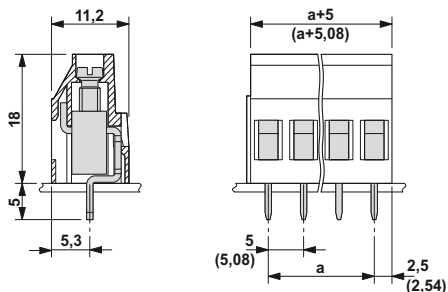

Drilling diagram

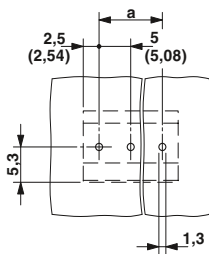

Ordering data

Type	Order No.	Pcs. / Pkt.
5.0 mm pitch, color: green		
MKDS 3/ 2	1711026	100
MKDS 3/ 3	1711039	100
MKDS 3/ 4	1711042	50
5.08 mm pitch, color: green		
MKDS 3/ 2-5,08	1711725	100
MKDS 3/ 3-5,08	1711738	100
MKDS 3/ 4-5,08	1712805	50



Dimensional drawing

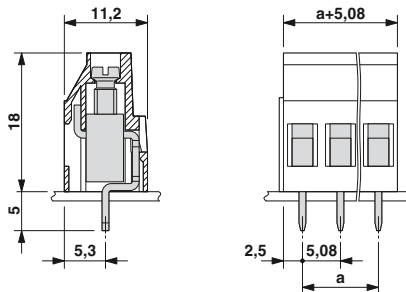

Drilling diagram

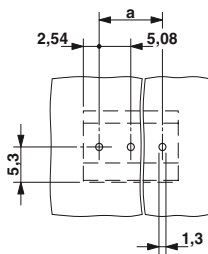

Ordering data

Type	Order No.	Pcs. / Pkt.
5.08 mm pitch, color: green		
MKDS 3/ 2-B-5,08	1707904	50
MKDS 3/ 3-B-5,08	1707917	50
Headers, 5.08 mm pitch, color: Black		
MKDS 3/ 2-B-5,08 BK	1706455	50
MKDS 3/ 3-B-5,08 BK	1706468	50
Pitch 5.08 mm, color: Blue		
MKDS 3/ 2-B-5,08 BU	1706439	50
MKDS 3/ 3-B-5,08 BU	1706442	50
Pitch 5.08 mm, color: green-yellow		
MKDS 3/ 2-B-5,08 GNYE	1706471	50
MKDS 3/ 3-B-5,08 GNYE	1706484	50



Dimensional drawing

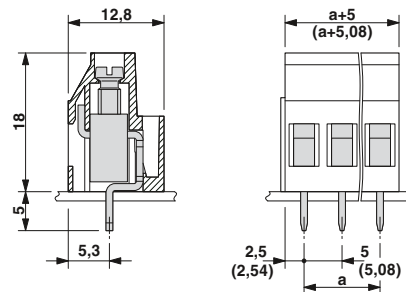

Drilling diagram

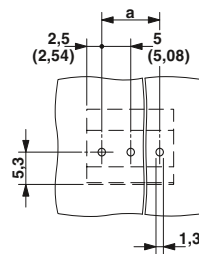

Ordering data

Type	Order No.	Pcs. / Pkt.
5.0 mm pitch, color: green		
MKDSP 3/ 2	1714023	50
MKDSP 3/ 3	1714036	50
5.08 mm pitch, color: green		
MKDSP 3/ 2-5,08	1714722	50
MKDSP 3/ 3-5,08	1714735	50

PCB terminal blocks with 2.54 to 7.62 mm pitch

PCB terminal blocks with screw connection for wave soldering processes, currents up to 24 A

Connection cross section of up to 2.5 mm²

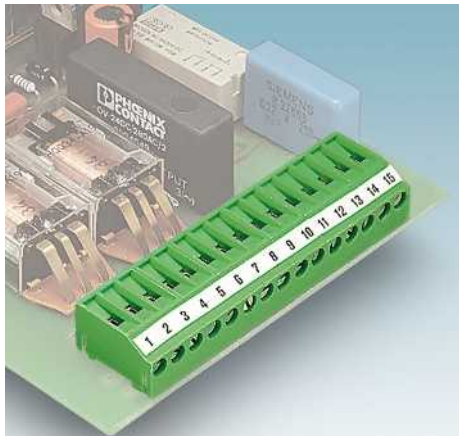

SMKDS 3/...

- Conductor and screwdriver axis at an angle of 35° to the PCB
- An arrangement of several terminal block rows one behind the other – multi-level effect with the same design

MKDSFW 3/... and MKDSF 3/...

- Generously dimensioned wiring space, solid conductor up to 4 mm²
- Horizontal series with vertical connection direction to the PCB
- MKDSFW 1.5 with stand-off/offset
- MKDSF 3 with an angled solder pin guided backwards out of the housing

Notes:

In order to avoid tolerances between the terminal blocks and PCB, the terminal row should be interrupted when the number of positions exceeds 30.

1) Please observe the current carrying capacity curves. Further current carrying capacity curves on request.

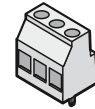



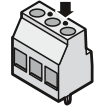

Metric 5 mm pitch



Detection lug for models with 5.08 mm inch pitch

Accessories

For all types	Type	Page
	Marker cards SK 5/3,8 or SK 5,08/3,8	798
	Screwdriver SZS 0,6 x 3,5 Order No. 1205053	
	Insertion bridge EBP...- 5	829
	Test plug SPB 5-MKDS 3 Order No. 1301216	833
Only for MKDSF 3		
	Single cover for individual terminal positions EA-MKDS Order No. 1711408	

Current carrying capacity curve

Type: SMKDS 3/2 and SMKDS 3/3
Test following DIN EN 60512-5-2:2003-01
Reduction factor = 1
No. of positions: 5

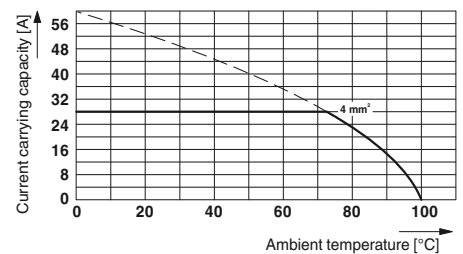

Technical data

Technical data in accordance to IEC / DIN VDE	
Rated current / conductor cross section	[A] / [mm ²]
Rated insulation voltage for pollution degree 2	[V]
Pitch	[mm]
Connection capacity	
Solid / stranded	[mm ²] / [mm ²] / AWG
Stranded with ferrules without plastic sleeve	[mm ²]
Stranded with ferrules with plastic sleeve	[mm ²]
Multi-conductor connection capacity (two conductors with the same cross section)	
Solid / stranded	[mm ²]
Stranded with ferrules without plastic sleeve	[mm ²]
Stranded with TWIN ferrule with plastic sleeve	[mm ²]
Insulation coordination	
Surge voltage category / pollution degree	
Rated insulation voltage	[V]
Rated surge voltage	[kV]
Approval data (UL/CUL)	Use Group
Nominal voltage	[V]
Nominal current	[A]
Connection capacity AWG	AWG
Approval data (CSA)	Use Group
Nominal voltage	[V]
Nominal current	[A]
Connection capacity AWG	AWG
General data	
Stripping length	[mm]
Screw thread	
Tightening torque	[Nm]
Type of insulation material / insulation material group	
Inflammability class according to UL 94	
Drill hole diameter / pin dimensions	[mm]

SMKDS 3/...

24 ¹⁾ / 4		
400		
5 / 5.08		
0.2 - 4 / 0.2 - 2.5 / 24 - 12		
0.25 - 2.5		
0.25 - 2.5		
0.2 - 1.5 / 0.2 - 1.5		
0.25 - 0.75		
0.5 - 1.5		
III / 3	III / 2	II / 2
250	400	630
4	4	4
B	C	D
250	-	300
15	-	10
30 - 12	-	30 - 12
B	C	D
300	-	300
10	-	10
28 - 12	-	28 - 12
8		
M3		
0.5 - 0.6		
PA / I		
V0		
1.3 / 0.9 x 0.9 mm		

MKDSFW 3/...

24 ¹⁾ / 4		
400		
5		
0.2 - 4 / 0.2 - 2.5 / 24 - 12		
0.25 - 1		
0.25 - 1		
0.2 - 1.5 / 0.2 - 1.5		
0.25 - 0.75		
0.5 - 1.5		
III / 3	III / 2	II / 2
250	400	630
4	4	4
B	C	D
250	-	300
16	-	10
30 - 12	-	30 - 12
B	C	D
300	-	300
10	-	10
28 - 12	-	28 - 12
8		
M3		
0.5 - 0.6		
PA / I		
V2		
1.3 / 0.9 x 0.9 mm		

MKDSF 3/...

24 ¹⁾ / 4		
400		
5 / 5.08		
0.2 - 4 / 0.2 - 2.5 / 24 - 12		
0.25 - 2.5		
0.25 - 2.5		
0.2 - 1.5 / 0.2 - 1.5		
0.25 - 0.75		
0.5 - 1.5		
III / 3	III / 2	II / 2
250	400	630
4	4	4
B	C	D
250	-	300
15	-	10
30 - 12	-	30 - 12
B	C	D
300	-	300
10	-	10
28 - 12	-	28 - 12
8		
M3		
0.5 - 0.6		
PA / I		
V0		
1.3 / 0.9 x 0.9 mm		

No. of pos.	Dim. a [mm]
2	5.00
3	10.00
4	15.00
6	25.00
8	35.00
12	55.00
2	5.08
3	10.16
4	15.24
6	25.40

PCB terminal blocks with 2.54 to 7.62 mm pitch

PCB terminal blocks with screw connection for wave soldering processes, currents up to 24 A

Connection cross section of up to 2.5 mm²

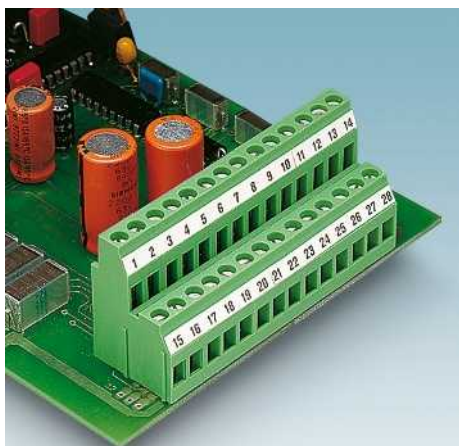

MKKDS 3/...

- Double-level type with high packaging and connection density
- Offset levels for optimum accessibility of the terminal points

MKKDSG 3/...

- Double-level type with high packaging and connection density
- Non-offset levels for space-saving installation in device housings

MKKDSH 3/...

- Single-row type, back level of the double-level PCB terminal block

Notes:

In order to avoid tolerances between the terminal blocks and PCB, the terminal row should be interrupted when the number of positions exceeds 30.

1) Please observe the current carrying capacity curves. Further current carrying capacity curves on request.

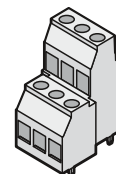

Metric 5 mm pitch

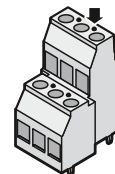

Detection lug for models with 5.08 mm inch pitch

Accessories

For all types	Type	Page
	Marker cards SK 5/3,8 or SK 5,08/3,8	798
	Screwdriver SZS 0,6 x 3,5 Order No. 1205053	
	Single cover for individual terminal positions EA-MKDS Order No. 1711408	
	Insertion bridge EBP... 5	829
	Test plug SPB 5-MKDS 3 Order No. 1301216	833

Current carrying capacity curve

Type: MKKDS 3/2 and MKKDS 3/3
Test following DIN EN 60512-5-2:2003-01
Reduction factor = 1
No. of positions: 5

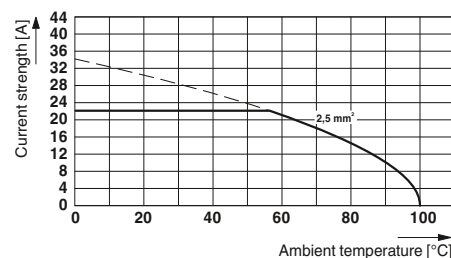

Technical data

Technical data in accordance to IEC / DIN VDE	
Rated current / conductor cross section	[A] / [mm ²]
Rated insulation voltage for pollution degree 2	[V]
Pitch	[mm]
Connection capacity	
Solid / stranded	[mm ²] / [mm ²] / AWG
Stranded with ferrules without plastic sleeve	[mm ²]
Stranded with ferrules with plastic sleeve	[mm ²]
Multi-conductor connection capacity (two conductors with the same cross section)	
Solid / stranded	[mm ²]
Stranded with ferrules without plastic sleeve	[mm ²]
Stranded with TWIN ferrule with plastic sleeve	[mm ²]
Insulation coordination	
Surge voltage category / pollution degree	
Rated insulation voltage	[V]
Rated surge voltage	[kV]
Approval data (UL/CUL)	Use Group
Nominal voltage	[V]
Nominal current	[A]
Connection capacity AWG	AWG
Approval data (CSA)	Use Group
Nominal voltage	[V]
Nominal current	[A]
Connection capacity AWG	AWG
General data	
Stripping length	[mm]
Screw thread	
Tightening torque	[Nm]
Type of insulation material / insulation material group	
Inflammability class according to UL 94	
Drill hole diameter / pin dimensions	[mm]

MKKDS 3/...

22 ¹⁾ / 4		
400		
5 / 5.08		
0.2 - 4 / 0.2 - 2.5 / 24 - 12		
0.25 - 1.5		
0.25 - 2.5		
0.2 - 1.5 / 0.2 - 1.5		
0.25 - 0.75		
0.5 - 0.5		
III / 3	III / 2	II / 2
250	400	630
4	4	4
B	C	D
125	-	300
15	-	10
30 - 12	-	30 - 12
B	C	D
300	-	300
10	-	10
28 - 12	-	28 - 12
7		
M3		
0.5 - 0.6		
PA / I		
V0		
1.3 / 0.9 x 0.9 mm		

MKKDSG 3/...

17.5 ¹⁾ / 4		
400		
5		
0.2 - 4 / 0.2 - 2.5 / 24 - 12		
0.25 - 1.5		
0.25 - 2.5		
0.2 - 1.5 / 0.2 - 1.5		
0.25 - 0.75		
0.5 - 0.5		
III / 3	III / 2	II / 2
250	400	630
4	4	4
B	C	D
125	-	300
10	-	10
30 - 12	-	30 - 12
B	C	D
300	-	300
10	-	10
28 - 12	-	28 - 12
7		
M3		
0.5 - 0.6		
PA / I		
V0		
1.3 / 0.9 x 0.9 mm		

MKKDSH 3/...

24 ¹⁾ / 4		
400		
5		
0.2 - 4 / 0.2 - 2.5 / 24 - 12		
0.25 - 1.5		
0.25 - 2.5		
0.2 - 1.5 / 0.2 - 1.5		
0.25 - 0.75		
0.5 - 1.5		
III / 3	III / 2	II / 2
250	400	630
4	4	4
B	C	D
125	-	300
15	-	10
30 - 12	-	30 - 12
B	C	D
-	-	-
-	-	-
-	-	-
7		
M3		
0.5 - 0.6		
PA / I		
V0		
1.3 / 0.9 x 0.9 mm		

No. of pos.	Dim. a [mm]
2	5.00
3	10.00
2	5.08
3	10.16

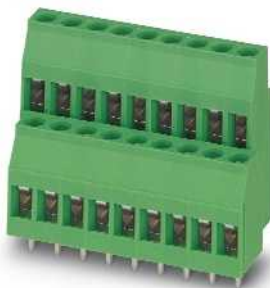

Double-level PCB terminal block with offset levels, with housing overlapping



Double-level PCB terminal blocks without offset levels, with housing overlapping



High PCB terminal block with housing overlapping



Dimensional drawing

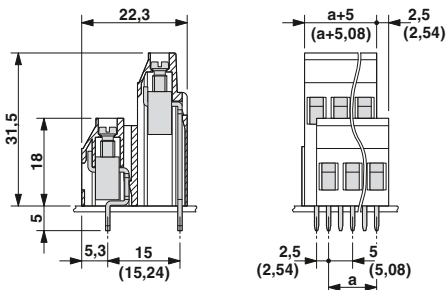

Drilling diagram

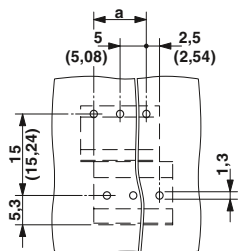

Dimensional drawing

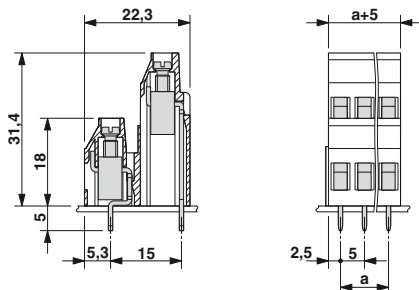

Drilling diagram

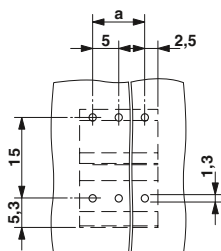

Dimensional drawing

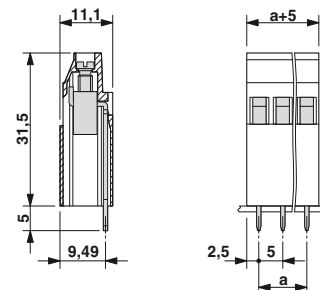

Drilling diagram

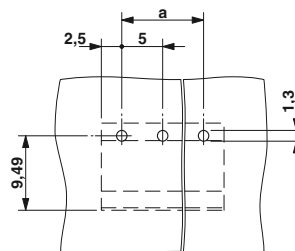

Ordering data

Type	Order No.	Pcs. / Pkt.
5.0 mm pitch, color: green		
MKKDS 3/ 2	1721029	50
MKKDS 3/ 3	1721032	50
5.08 mm pitch, color: green		
MKKDS 3/ 2-5,08	1721728	50
MKKDS 3/ 3-5,08	1721731	50

Ordering data

Type	Order No.	Pcs. / Pkt.
5.0 mm pitch, color: green		
MKKDSG 3/ 2	1721090	50
MKKDSG 3/ 3	1721087	50

Ordering data

Type	Order No.	Pcs. / Pkt.
Printed circuit termination block, for soldering into the printed circuit board, 5.0 mm pitch		
MKKDSH 3/ 2	1721045	50
MKKDSH 3/ 3	1721346	50

PCB terminal blocks with 2.54 to 7.62 mm pitch

PCB terminal blocks with screw connection for wave soldering processes, currents up to 24 A

Connection cross section of up to 2.5 mm²

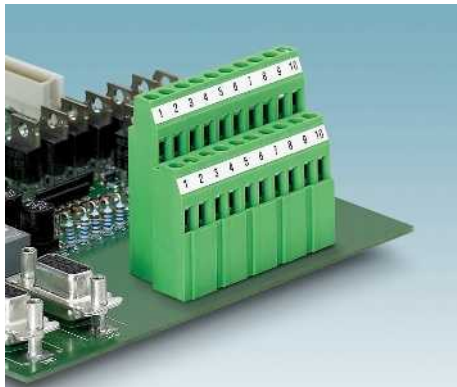

MK3DS 3/...

- Three-level type with high packaging and connection density
- Offset levels for optimum accessibility of the terminal points

MKKDSH 3/...

- Single-row type, back level of the three-level PCB terminal block
- The high types are suitable for applications with molded PCBs

MKKDSMH 3/...

- Double-row type, middle and back level of the three-level PCB terminal block

Notes:

In order to avoid tolerances between the terminal blocks and PCB, the terminal row should be interrupted when the number of positions exceeds 30.

1) Please observe the current carrying capacity curves. Further current carrying capacity curves on request.

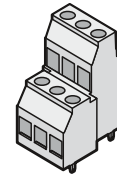

Metric 5 mm pitch

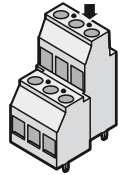

Detection lug for models with 5.08 mm inch pitch

Accessories

For all types	Type	Page
	Marker cards SK 5,08/3,8	798
	Screwdriver SZS 0,6 x 3,5 Order No. 1205053	
	Single cover for individual terminal positions EA-MKDS Order No. 1711408	
	Insertion bridge EBP...-5	829
	Test plug SPB 5-MKDS 3 Order No. 1301216	833

Current carrying capacity curve

Type: MK3DS 3/2 and MK3DS 3/3
Test following DIN EN 60512-5-2:2003-01
Reduction factor = 1
No. of positions: 5

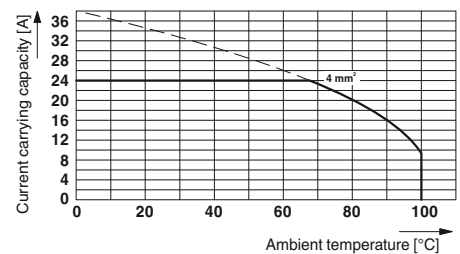

Technical data

Technical data in accordance to IEC / DIN VDE

Rated current / conductor cross section [A] / [mm²]
Rated insulation voltage for pollution degree 2 [V]

Pitch [mm]

Connection capacity

Solid / stranded [mm²] / [mm²] / AWG

Stranded with ferrules without plastic sleeve [mm²]

Stranded with ferrules with plastic sleeve [mm²]

Multi-conductor connection capacity (two conductors with the same cross section)

Solid / stranded [mm²]

Stranded with ferrules without plastic sleeve [mm²]

Stranded with TWIN ferrule with plastic sleeve [mm²]

Insulation coordination

Surge voltage category / pollution degree

Rated insulation voltage [V]

Rated surge voltage [kV]

Approval data (UL/CUL) Use Group

Nominal voltage [V]

Nominal current [A]

Connection capacity AWG AWG

Approval data (CSA) Use Group

Nominal voltage [V]

Nominal current [A]

Connection capacity AWG AWG

General data

Stripping length [mm]

Screw thread

Tightening torque [Nm]

Type of insulation material / insulation material group

Inflammability class according to UL 94

Drill hole diameter / pin dimensions [mm]

	MK3DS 3/ ...-5,08			MK3DSH 3/ ...-5,08			MK3DSMH 3/ ...-5,08		
Rated current / conductor cross section [A] / [mm ²]	17.5 ¹⁾ / 4			24 ¹⁾ / 4			22 ¹⁾ / 4		
Rated insulation voltage for pollution degree 2 [V]	400			400			400		
Pitch [mm]	5.08			5.08			5.08		
Connection capacity									
Solid / stranded [mm ²] / [mm ²] / AWG	0.2 - 4 / 0.2 - 2.5 / 24 - 12			0.2 - 4 / 0.2 - 2.5 / 24 - 12			0.2 - 4 / 0.2 - 2.5 / 24 - 12		
Stranded with ferrules without plastic sleeve [mm ²]	0.25 - 1.5			0.25 - 1.5			0.25 - 1.5		
Stranded with ferrules with plastic sleeve [mm ²]	0.25 - 2.5			0.25 - 2.5			0.25 - 2.5		
Multi-conductor connection capacity (two conductors with the same cross section)									
Solid / stranded [mm ²]	0.2 - 1.5 / 0.2 - 1.5			0.2 - 1.5 / 0.2 - 1.5			0.2 - 1.5 / 0.2 - 1.5		
Stranded with ferrules without plastic sleeve [mm ²]	0.25 - 0.75			0.25 - 0.75			0.25 - 0.75		
Stranded with TWIN ferrule with plastic sleeve [mm ²]	0.5 - 0.5			0.5 - 1.5			0.5 - 0.5		
Insulation coordination									
Surge voltage category / pollution degree	III / 3	III / 2	II / 2	III / 3	III / 2	II / 2	III / 3	III / 2	II / 2
Rated insulation voltage [V]	250	400	630	250	400	630	250	400	630
Rated surge voltage [kV]	4	4	4	4	4	4	4	4	4
Approval data (UL/CUL) Use Group	B	C	D	B	C	D	B	C	D
Nominal voltage [V]	125	-	300	125	-	300	125	-	300
Nominal current [A]	20	-	10	15	-	10	15	-	10
Connection capacity AWG AWG	30 - 12	-	30 - 12	30 - 12	-	30 - 12	30 - 12	-	30 - 12
Approval data (CSA) Use Group	B	C	D	B	C	D	B	C	D
Nominal voltage [V]	300	-	300	-	-	-	-	-	-
Nominal current [A]	10	-	10	-	-	-	-	-	-
Connection capacity AWG AWG	28 - 12	-	28 - 12	-	-	-	-	-	-
General data									
Stripping length [mm]	7			7			7		
Screw thread	M3			M3			M3		
Tightening torque [Nm]	0.5 - 0.6			0.5 - 0.6			0.5 - 0.6		
Type of insulation material / insulation material group	PA / I			PA / I			PA / I		
Inflammability class according to UL 94	V0			V0			V0		
Drill hole diameter / pin dimensions [mm]	1.3 / 0.9 x 0.9 mm			1.3 / 0.9 x 0.9 mm			1.3 / 0.9 x 0.9 mm		

No. of pos.	Dim. a [mm]
2	5.08
3	10.16



Three-level PCB terminal block with offset levels, with housing overlapping



High PCB terminal block with housing overlapping



High double-level PCB terminal block with offset levels and housing overlapping



Dimensional drawing

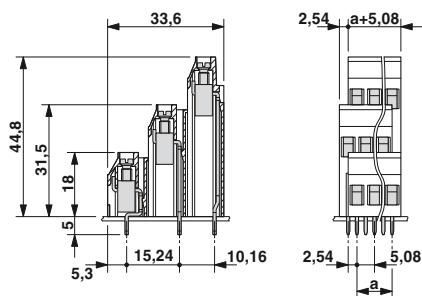

Drilling diagram

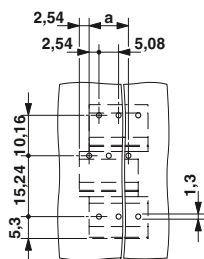

Ordering data

Type	Order No.	Pcs. / Pkt.
5.08 mm pitch, color: green		
MK3DS 3/ 2-5,08	1723014	50
MK3DS 3/ 3-5,08	1723027	50



Dimensional drawing

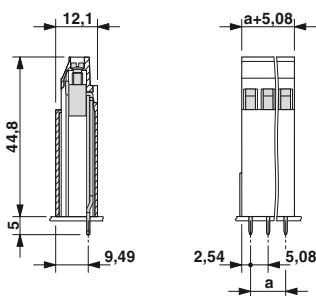

Drilling diagram

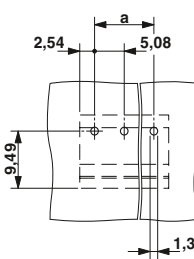

Ordering data

Type	Order No.	Pcs. / Pkt.
5.08 mm pitch, color: green		
MK3DSH 3/ 2-5,08	1723182	50
MK3DSH 3/ 3-5,08	1723195	50



Dimensional drawing

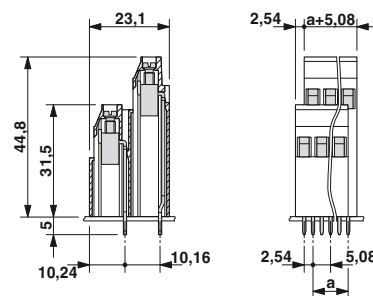

Drilling diagram

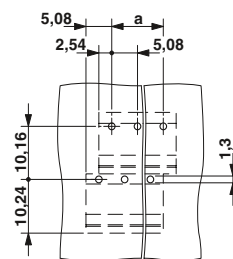

Ordering data

Type	Order No.	Pcs. / Pkt.
5.08 mm pitch, color: green		
MK3DSMH 3/ 2-5,08	1723205	50
MK3DSMH 3/ 3-5,08	1723218	50

PCB terminal blocks with 2.54 to 7.62 mm pitch

PCB terminal blocks with screw connection for wave soldering processes, currents up to 24 A

Connection cross section of up to 2.5 mm²

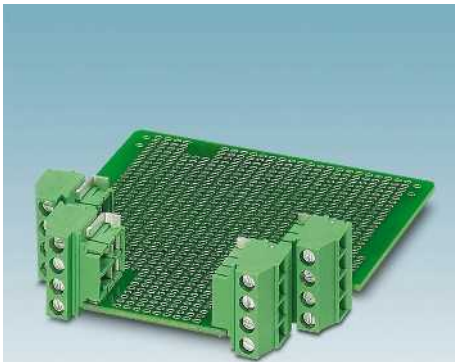

- PCB terminal block for ME/ME MAX electronic housing
- PCB terminal block is orthogonal to the PCB
- "Left" and "right" design
- Pitch 5 mm
- Number of positions between 2 and 4

Notes:
 1) Please observe the current carrying capacity curves. Further current carrying capacity curves on request.

Accessories		
For all types	Type	Page
	Marker cards SK 5/3,8 or SK 5,08/3,8	798

Current carrying capacity curve
 Type: MKDSO 2,5/4...L(R)
 Test based on DIN EN 60512-5-2:2003-01
 Reduction factor = 1
 Number of positions: 4

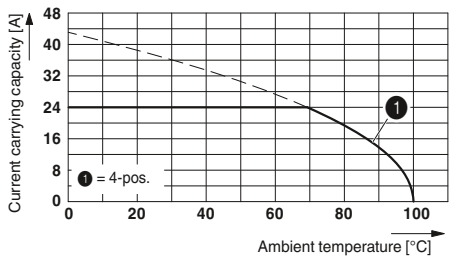

Technical data

Technical data in accordance to IEC / DIN VDE	
Rated current / conductor cross section	[A] / [mm ²]
Rated insulation voltage for pollution degree 2	[V]
Pitch	[mm]
Connection capacity	
Solid / stranded	[mm ²] / [mm ²] / AWG
Stranded with ferrules without plastic sleeve	[mm ²]
Stranded with ferrules with plastic sleeve	[mm ²]
Multi-conductor connection capacity (two conductors with the same cross section)	
Solid / stranded	[mm ²]
Stranded with ferrules without plastic sleeve	[mm ²]
Stranded with TWIN ferrule with plastic sleeve	[mm ²]
Insulation coordination	
Surge voltage category / pollution degree	
Rated insulation voltage	[V]
Rated surge voltage	[kV]
Approval data (UL/CUL)	Use Group
Nominal voltage	[V]
Nominal current	[A]
Connection capacity AWG	AWG
Approval data (CSA)	Use Group
Nominal voltage	[V]
Nominal current	[A]
Connection capacity AWG	AWG
General data	
Stripping length	[mm]
Screw thread	
Tightening torque	[Nm]
Type of insulation material / insulation material group	
Inflammability class according to UL 94	
Drill hole diameter / pin dimensions	[mm]

MKDSO 2,5/ ...-L			MKDSO 2,5/ ...-R		
24 ¹⁾ / 2.5			24 ¹⁾ / 2.5		
400			400		
5			5		
0.14 - 2.5 / 0.14 - 2.5 / 26 - 14			0.14 - 2.5 / 0.14 - 2.5 / 26 - 14		
0.25 - 2.5			0.25 - 2.5		
0.25 - 2.5			0.25 - 2.5		
0.14 - 0.75 / 0.14 - 0.75			0.14 - 0.75 / 0.14 - 0.75		
0.25 - 0.75			0.25 - 0.75		
0.5 - 1.5			0.5 - 1.5		
III / 3	III / 2	II / 2	III / 3	III / 2	II / 2
250	400	630	250	400	630
4	4	4	4	4	4
B	C	D	B	C	D
300	-	300	300	-	300
20	-	15	20	-	15
30 - 12	-	30 - 12	30 - 12	-	30 - 12
B	C	D	B	C	D
300	-	300	300	-	300
10	-	10	10	-	10
28 - 12	-	28 - 12	28 - 12	-	28 - 12
8			8		
M3			M3		
0.5 - 0.6			0.5 - 0.6		
PA / I			PA / I		
V0			V0		
1.4 / 0.8 x 1			1.4 / 0.8 x 1		

No. of pos.	Dim. a [mm]
2	5.00
3	10.00
4	15.00



With "left" solder pins leading off at a right angle

With "right" solder pins leading off at a right angle



Dimensional drawing

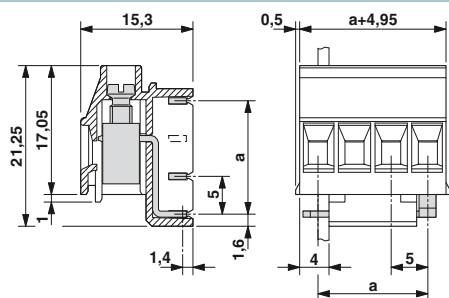

Drilling diagram

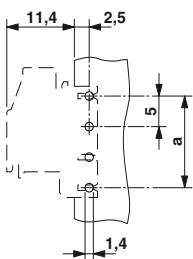

Dimensional drawing

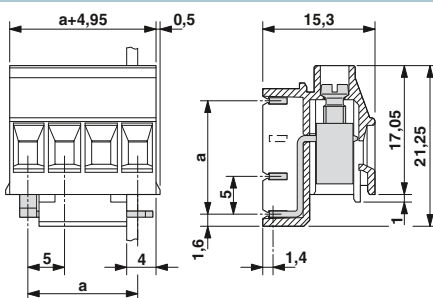

Drilling diagram

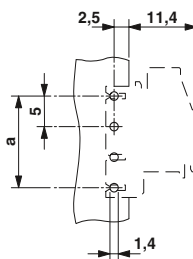

Ordering data

Type	Order No.	Pcs. / Pkt.
PCB terminal block, 5 mm pitch, color: green		
MKDSO 2,5/ 2-L	1707205	250
MKDSO 2,5/ 3-L	1707221	250
MKDSO 2,5/ 4-L	1707234	250
PCB terminal block, left, 5 mm pitch, color: light gray		
MKDSO 2,5/ 2-L KMGY	2915261	250
MKDSO 2,5/ 3-L KMGY	2854102	250
MKDSO 2,5/ 4-L KMGY	2908485	250

Ordering data

Type	Order No.	Pcs. / Pkt.
PCB terminal block, right, 5 mm pitch, color: green		
MKDSO 2,5/ 2-R	1707195	250
MKDSO 2,5/ 3-R	1707218	250
MKDSO 2,5/ 4-R	1707247	250
PCB terminal block, right, 5 mm pitch, color: light gray		
MKDSO 2,5/ 2-R KMGY	2915258	250
MKDSO 2,5/ 3-R KMGY	2854092	250
MKDSO 2,5/ 4-R KMGY	2908472	250

PCB terminal blocks with 2.54 to 7.62 mm pitch

PCB terminal blocks with screw connection for wave soldering processes, currents up to 24 A

Front screw connections up to 2.5 mm²

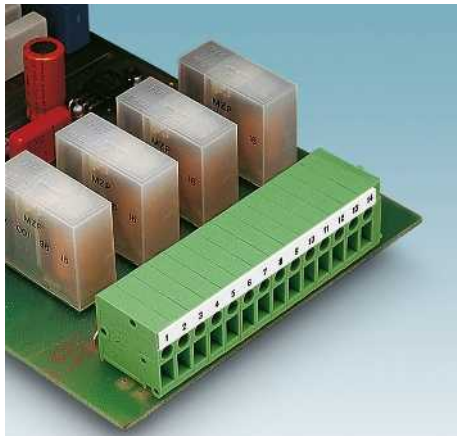

- Screw terminal blocks with a front conductor connection
- Generously dimensioned connection cross section up to 2.5 mm²
- Double solder pin for high stability on the PCB
- Voltage increase through the use of pitch spacers
- For flush mounting in the front of devices
- Horizontal and vertical types

Notes:



- 1) 400 V is achieved when the pitch spacer RZ 2,5-FRONT 2,5-H(V) is inserted.
- 2) Current carrying capacity curve upon request.



Horizontal connection direction,
5 mm pin spacing



Accessories

For all types	Type	Page
	Screwdriver SZS 0,3 x 3,0 Order No. 1207404	
Only for FRONT 2,5-H/...		
	Pitch spacer, width: 2.5 mm RZ 2,5-FRONT 2,5-H Order No. 1700079	
Only for FRONT 2,5-V/...		
	Pitch spacer, width: 2.5 mm RZ 2,5-FRONT 2,5-V Order No. 1700082	

Dimensional drawing

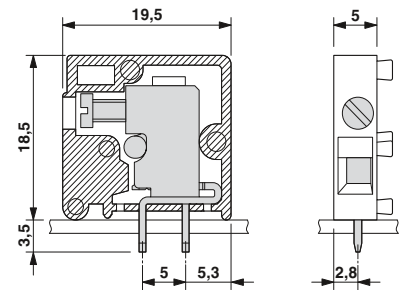

Drilling diagram

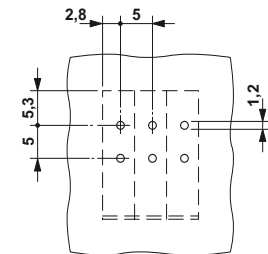

Technical data

Technical data in accordance to IEC / DIN VDE	
Rated current / conductor cross section	[A] / [mm ²]
Rated insulation voltage for pollution degree 2	[V]
Pitch	[mm]
Connection capacity	
Solid / stranded	[mm ²] / [mm ²] / AWG
Stranded with ferrules without plastic sleeve	[mm ²]
Stranded with ferrules with plastic sleeve	[mm ²]
Multi-conductor connection capacity (two conductors with the same cross section)	
Solid / stranded	[mm ²]
Stranded with ferrules without plastic sleeve	[mm ²]
Stranded with TWIN ferrule with plastic sleeve	[mm ²]
Insulation coordination	
Surge voltage category / pollution degree	
Rated insulation voltage	[V]
Rated surge voltage	[kV]
Approval data (UL/CUL)	Use Group
Nominal voltage	[V]
Nominal current	[A]
Connection capacity AWG	AWG
Approval data (CSA)	Use Group
Nominal voltage	[V]
Nominal current	[A]
Connection capacity AWG	AWG
General data	
Stripping length	[mm]
Screw thread	
Tightening torque	[Nm]
Type of insulation material / insulation material group	
Inflammability class according to UL 94	
Drill hole diameter / pin dimensions	[mm]

	24 ²) / 2.5
	400
	5
	0.2 - 2.5 / 0.2 - 2.5 / 24 - 14
	0.25 - 1.5
	0.25 - 1.5
	0.2 - 0.75 / 0.2 - 0.75
	0.25 - 0.34
	-
	III / 3 III / 2 II / 2
	250 ¹⁾ 400 630
	4 4 4
	B C D
	250 - 300
	10 - 10
	30 - 12 - 30 - 12
	B C D
	300 - 300
	10 - 10
	24 - 12 - 24 - 12
	9
	M2,5
	0.4 - 0.5
	PA / I
	V0
	1.2 / 0.8 x 0.8 mm

No. of pos.	Dim. a [mm]
2	5.00
3	10.00
4	15.00
5	20.00
6	25.00
7	30.00
8	35.00
9	40.00
10	45.00
11	50.00
12	55.00

Ordering data

Type	Order No.	Pcs. / Pkt.
5.0 mm pitch, color: green		
FRONT 2,5-H/SA 5/ 2	1868665	20
FRONT 2,5-H/SA 5/ 3	1700121	20
FRONT 2,5-H/SA 5/ 4	1700781	20
FRONT 2,5-H/SA 5/ 5	1724660	20
FRONT 2,5-H/SA 5/ 6	1891975	20
FRONT 2,5-H/SA 5/ 7	1988257	20
FRONT 2,5-H/SA 5/ 8	1724673	20
FRONT 2,5-H/SA 5/ 9	1744109	20
FRONT 2,5-H/SA 5/10	1773264	20
FRONT 2,5-H/SA 5/11	1701382	20
FRONT 2,5-H/SA 5/12	1892893	20



Horizontal connection direction,
10 mm pin spacing



Vertical connection direction,
5 mm pin spacing



Vertical connection direction,
10 mm pin spacing



Dimensional drawing

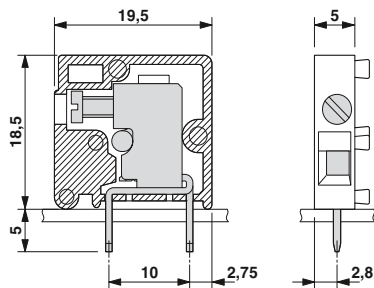

Drilling diagram

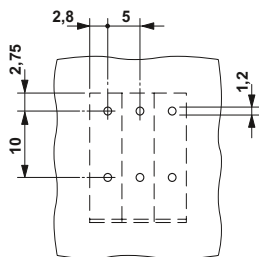

Ordering data

Type	Order No.	Pcs. / Pkt.
5.0 mm pitch, color: green		
FRONT 2,5-H/SA10/ 2	1724657	20
FRONT 2,5-H/SA10/ 3	1904215	20
FRONT 2,5-H/SA10/ 4	1773170	20
FRONT 2,5-H/SA10/ 5	1773183	20
FRONT 2,5-H/SA10/ 6	1773196	20
FRONT 2,5-H/SA10/ 7	1773206	20
FRONT 2,5-H/SA10/ 8	1773219	20
FRONT 2,5-H/SA10/ 9	1773222	20
FRONT 2,5-H/SA10/10	1773235	20
FRONT 2,5-H/SA10/11	1773248	20
FRONT 2,5-H/SA10/12	1773251	20



Dimensional drawing

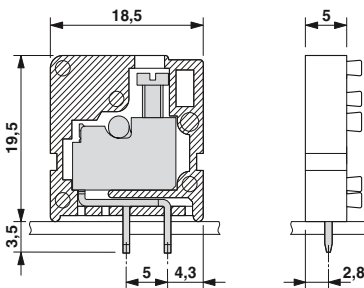

Drilling diagram

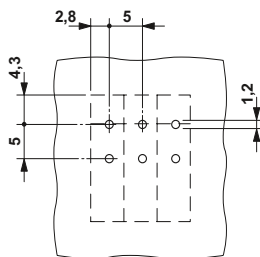

Ordering data

Type	Order No.	Pcs. / Pkt.
5.0 mm pitch, color: green		
FRONT 2,5-V/SA 5/ 2	1700244	20
FRONT 2,5-V/SA 5/ 3	1700134	20
FRONT 2,5-V/SA 5/ 4	1888250	20
FRONT 2,5-V/SA 5/ 5	1700354	20
FRONT 2,5-V/SA 5/ 6	1700231	20
FRONT 2,5-V/SA 5/ 7	1724152	20
FRONT 2,5-V/SA 5/ 8	1700710	20
FRONT 2,5-V/SA 5/ 9	1724165	20
FRONT 2,5-V/SA 5/10	1700765	20
FRONT 2,5-V/SA 5/11	1700118	20
FRONT 2,5-V/SA 5/12	1889974	20



Dimensional drawing

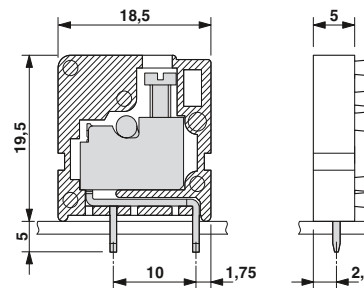

Drilling diagram

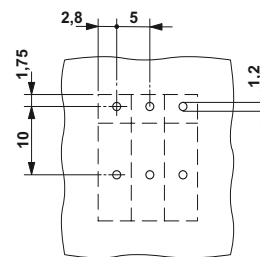

Ordering data

Type	Order No.	Pcs. / Pkt.
5.0 mm pitch, color: green		
FRONT 2,5-V/SA10/ 2	1704114	20
FRONT 2,5-V/SA10/ 3	1704897	20
FRONT 2,5-V/SA10/ 4	1732238	20
FRONT 2,5-V/SA10/ 5	1773277	20
FRONT 2,5-V/SA10/ 6	1701230	20
FRONT 2,5-V/SA10/ 7	1773280	20
FRONT 2,5-V/SA10/ 8	1704127	20
FRONT 2,5-V/SA10/ 9	1704907	20
FRONT 2,5-V/SA10/10	1700778	20
FRONT 2,5-V/SA10/11	1773293	20
FRONT 2,5-V/SA10/12	1931741	20

PCB terminal blocks with 2.54 to 7.62 mm pitch

PCB terminal blocks with screw connection for wave soldering processes, currents up to 24 A

Single terminal blocks of up to 2.5 mm²

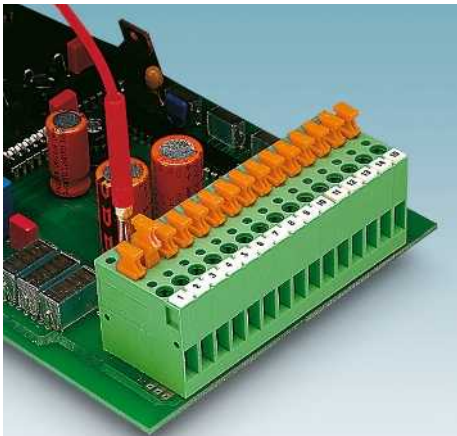

- Double solder pin for high stability on the PCB
- Low-heat generating current transfer in the conducting path
- Increase in voltage with pitch spacers
- A plate-type design enables blocking for larger number of positions

Notes:

In order to avoid tolerances between the terminal blocks and PCB, the terminal row should be interrupted when the number of positions exceeds 30.





1) 400 V is achieved when the pitch spacer RZ-KDS 2,5 is inserted.

2) 500 V is achieved when the pitch spacer RZ 2.54 is inserted.

3) 500 V is achieved when the pitch spacer RZ 2,54 is inserted.

4) Current carrying capacity curve available on request.

Accessories

For all types	Type	Page
	Test plug MPS	831
	Reducing plug RPS Order No. 0201647	831
Only for KDS 2,5		
	Pitch spacer, width: 2.5 mm RZ-KDS 2,5 Order No. 1705029	
Only for KDS 3-PMT and KDS 3-MT		
	Pitch spacer, width: 2.54 mm RZ 2,54 Order No. 1780044	

Technical data

Technical data in accordance to IEC / DIN VDE

Rated current / conductor cross section [A] / [mm²]

Rated insulation voltage for pollution degree 2 [V]

Pitch [mm]

Connection capacity

Solid / stranded [mm²] / [mm²] / AWG

Stranded with ferrules without plastic sleeve [mm²]

Stranded with ferrules with plastic sleeve [mm²]

Multi-conductor connection capacity (two conductors with the same cross section)

Solid / stranded [mm²]

Stranded with ferrules without plastic sleeve [mm²]

Stranded with TWIN ferrule with plastic sleeve [mm²]

Insulation coordination

Surge voltage category / pollution degree

Rated insulation voltage [V]

Rated surge voltage [kV]

Approval data (UL/CUL) Use Group

Nominal voltage [V]

Nominal current [A]

Connection capacity AWG AWG

Approval data (CSA) Use Group

Nominal voltage [V]

Nominal current [A]

Connection capacity AWG AWG

General data

Stripping length [mm]

Screw thread

Tightening torque [Nm]

Type of insulation material / insulation material group

Inflammability class according to UL 94

Drill hole diameter / pin dimensions [mm]

KDS 2,5

24⁴⁾ / 4

400

5

0.2 - 4 / 0.2 - 2.5 / 24 - 12

0.25 - 2.5

0.25 - 1.5

0.2 - 1 / 0.2 - 1.5

0.25 - 0.5

0.5 - 1

III / 3 III / 2 II / 2

250¹⁾ 400 630

4 4 4

B C D

250 - 300

15 - 10

30 - 12 30 - 12

B C D

300 - 300

10 - 10

24 - 12 24 - 12

9

M3

0.5 - 0.6

PA / I

V2

1.4 / 1.1 x 0.7 mm

KDS 3-PMT

13.5⁴⁾ / 4

320

5.08

0.2 - 4 / 0.2 - 2.5 / 24 - 12

0.25 - 2.5

0.25 - 1.5

0.2 - 1 / 0.2 - 1

0.25 - 0.75

0.5 - 1

III / 3 III / 2 II / 2

320³⁾ 320 630

4 4 4

B C D

250 - 300

15 - 10

28 - 12 28 - 12

B C D

300 - 300

- - -

- - -

8

M3

0.5 - 0.6

PA / I

V2

1.2 / 0.8 x 0.8 mm

KDS 3-MT

15⁴⁾ / 4

320

5.08

0.2 - 4 / 0.2 - 2.5 / 24 - 12

0.25 - 2.5

0.25 - 1.5

0.2 - 1 / 0.2 - 1

0.25 - 0.75

0.5 - 1

III / 3 III / 2 II / 2

320²⁾ 320 630

4 4 4

B C D

250 - 300

15 - 10

28 - 12 28 - 12

B C D

300 - 300

10 - 10

24 - 12 24 - 12

8

M3

0.5 - 0.6

PA / I

V2

1.4 / 1.1 x 0.8 mm

No. of pos.

1

1

1

1



Single PCB terminal block, alignable

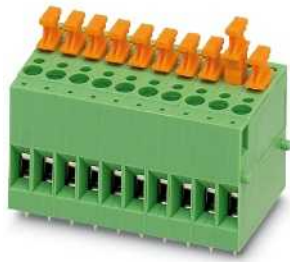

Disconnect terminal block with test connection on both sides of the disconnect point

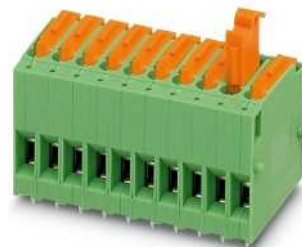

Knife disconnect terminal block with test socket



Dimensional drawing

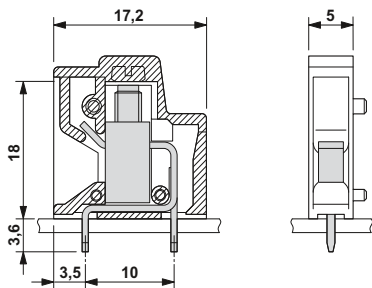

Drilling diagram

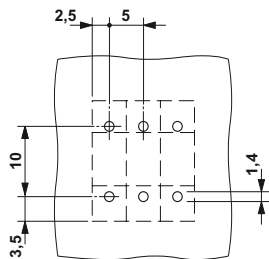

Ordering data

Type	Order No.	Pcs. / Pkt.
5.0 mm pitch, color: green KDS 2,5	1705016	50
Pitch 5 mm, color: Blue KDS 2,5 BU	1705090	50



Dimensional drawing

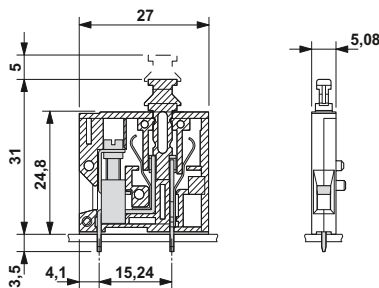

Drilling diagram

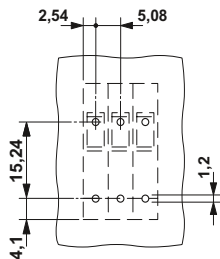

Ordering data

Type	Order No.	Pcs. / Pkt.
5.08 mm pitch, color: green KDS 3-PMT	1780028	50



Dimensional drawing

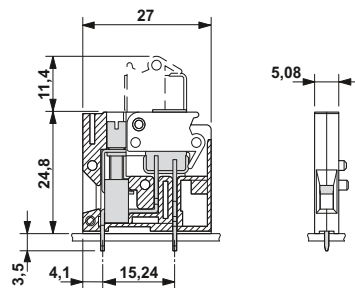

Drilling diagram

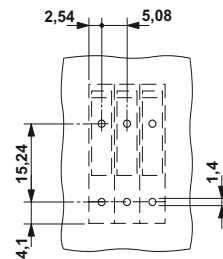

Ordering data

Type	Order No.	Pcs. / Pkt.
5.08 mm pitch, color: green KDS 3-MT	1780015	50

PCB terminal blocks with 2.54 to 7.62 mm pitch

PCB terminal blocks with screw connection for wave soldering processes, currents of up to 41 A

Connection cross section of up to 1.5 mm²

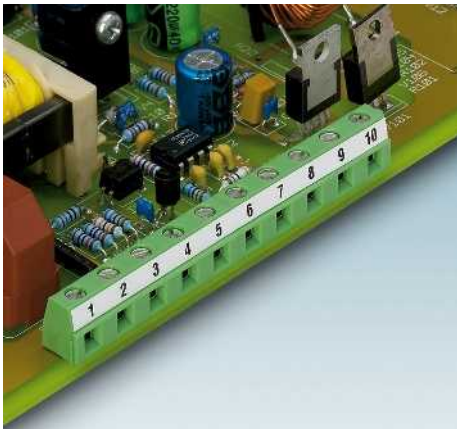

GMKDSN 1,5/...

- Single-row PCB terminal blocks for 630 V applications with a 7.62 mm pitch
- Can be connected in series with the corresponding standard models of the MKDSN 1,5 range
- Low design for especially compact mains connections

GSMKDSN 1,5/...

- Angled type with the connection direction at an angle of 55° to the PCB
- An arrangement of several terminal block rows one behind the other – multi-level effect with the same design

Notes:

In order to avoid tolerances between the terminal blocks and PCB, the terminal row should be interrupted when the number of positions exceeds 30.

1) Please observe the current carrying capacity curves. Further current carrying capacity curves on request.

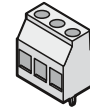

Metric 7.5 mm pitch

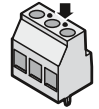

Detection lug for models with 7.62 mm inch pitch

Accessories

For all types	Type	Page
	Marker cards SK 7,62/5	800
	Screwdriver SZS 0,4 x 2,5 Order No. 1205037	

Current carrying capacity curve

Type: GMKDSN 1,5/5-7,62
Test following DIN EN 60512-5-2:2003-01
Reduction factor = 1
No. of positions: 5

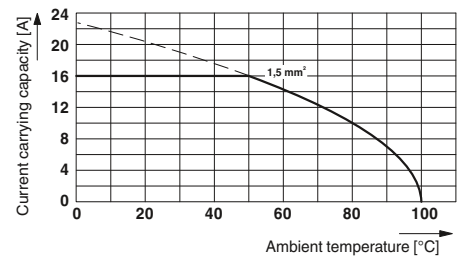

Technical data

Technical data in accordance to IEC / DIN VDE

Rated current / conductor cross section	[A] / [mm ²]
Rated insulation voltage for pollution degree 2	[V]
Pitch	[mm]
Connection capacity	
Solid / stranded	[mm ²] / [mm ²] / AWG
Stranded with ferrules without plastic sleeve	[mm ²]
Stranded with ferrules with plastic sleeve	[mm ²]
Multi-conductor connection capacity (two conductors with the same cross section)	
Solid / stranded	[mm ²]
Stranded with ferrules without plastic sleeve	[mm ²]
Stranded with TWIN ferrule with plastic sleeve	[mm ²]
Insulation coordination	
Surge voltage category / pollution degree	
Rated insulation voltage	[V]
Rated surge voltage	[kV]
Approval data (UL/CUL)	Use Group
Nominal voltage	[V]
Nominal current	[A]
Connection capacity AWG	AWG
Approval data (CSA)	Use Group
Nominal voltage	[V]
Nominal current	[A]
Connection capacity AWG	AWG
General data	
Stripping length	[mm]
Screw thread	
Tightening torque	[Nm]
Type of insulation material / insulation material group	
Inflammability class according to UL 94	
Drill hole diameter / pin dimensions	[mm]

GMKDSN 1,5/ ...-7,62

16 ¹⁾ / 1.5			16 ¹⁾ / 1.5		
630			630		
7.62			7.62		
0.14 - 1.5 / 0.14 - 1.5 / 26 - 16			0.14 - 1.5 / 0.14 - 1.5 / 26 - 16		
0.25 - 1.5			0.25 - 1.5		
0.25 - 1.5			0.25 - 1.5		
0.14 - 0.75 / 0.14 - 0.75			0.14 - 0.75 / 0.14 - 0.75		
0.25 - 0.5			0.25 - 0.5		
0.5 - 1			0.5 - 1		
III / 3	III / 2	II / 2	III / 3	III / 2	II / 2
400	630	1000	500	630	1000
6	6	6	6	6	6
B	C	D	B	C	D
300	-	300	300	-	300
10	-	10	10	-	10
30 - 14	-	30 - 14	30 - 14	-	30 - 14
B	C	D	B	C	D
300	-	300	300	-	300
10	-	10	10	-	10
28 - 14	-	28 - 14	28 - 14	-	28 - 14
6			6		
M3			M3		
0.5 - 0.6			0.5 - 0.6		
PA / I			PA / I		
V0			V2		
1.3 / 0.5 x 1 mm			1.3 / 0.5 x 1 mm		

GSMKDSN 1,5/ ...-7,62

No. of pos.	Dim. a [mm]
2	7.62
3	15.24
4	22.86
5	30.48
6	38.10
7	45.72
8	53.34
9	60.96
10	68.58
11	76.20
12	83.82



Low-profile design,
with housing overlapping



Low-profile design,
with 55° angled connection direction and
housing overlapping



Dimensional drawing

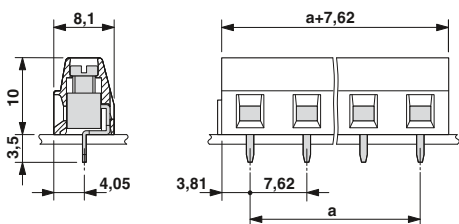

Drilling diagram

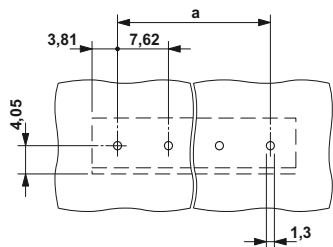

Ordering data

Type	Order No.	Pcs. / Pkt.
Pitch 7.62 mm, color: green		
GMKDSN 1,5/ 2-7,62	1707027	50
GMKDSN 1,5/ 3-7,62	1707030	50
GMKDSN 1,5/ 4-7,62	1707043	50
GMKDSN 1,5/ 5-7,62	1707056	50
GMKDSN 1,5/ 6-7,62	1707069	50
GMKDSN 1,5/ 7-7,62	1707072	50
GMKDSN 1,5/ 8-7,62	1707085	50
GMKDSN 1,5/ 9-7,62	1707108	50
GMKDSN 1,5/10-7,62	1707111	50
GMKDSN 1,5/11-7,62	1707124	50
GMKDSN 1,5/12-7,62	1707137	50



Dimensional drawing

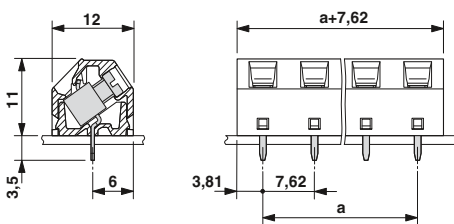

Drilling diagram

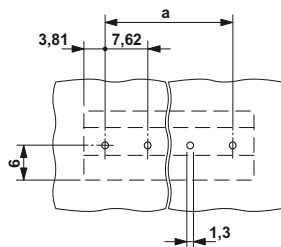

Ordering data

Type	Order No.	Pcs. / Pkt.
Pitch 7.62 mm, color: green		
GSMKDSN 1,5/ 2-7,62	1718605	50
GSMKDSN 1,5/ 3-7,62	1718618	50
GSMKDSN 1,5/ 4-7,62	1718621	50
GSMKDSN 1,5/ 5-7,62	1718634	50
GSMKDSN 1,5/ 6-7,62	1718647	50
GSMKDSN 1,5/ 7-7,62	1718650	50
GSMKDSN 1,5/ 8-7,62	1718663	50
GSMKDSN 1,5/ 9-7,62	1718676	50
GSMKDSN 1,5/10-7,62	1718689	50
GSMKDSN 1,5/11-7,62	1718692	50
GSMKDSN 1,5/12-7,62	1718702	50

PCB terminal blocks with 2.54 to 7.62 mm pitch

PCB terminal blocks with screw connection for wave soldering processes, currents of up to 41 A

Connection cross section of up to 1.5 mm²

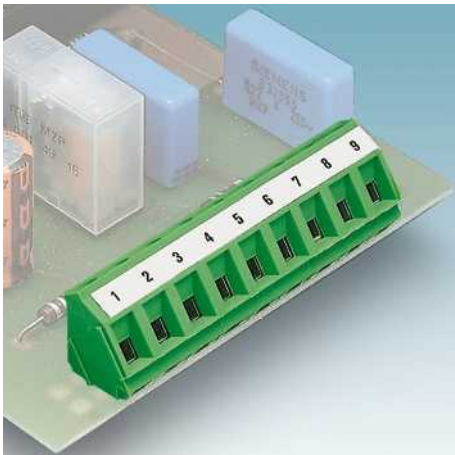

GMKDS 1,5/...

- Single-row PCB terminal blocks for 630 V applications with a 7.62 mm pitch
- Can be connected in series with the corresponding standard models of the MKDS 1,5 range

GSMKDSP 1,5/...

- Conductor and screwdriver axis at an angle of 35° to the PCB
- An arrangement of several terminal block rows one behind the other – multi-level effect with the same design
- With an integrated 2.3 mm Ø test connection

Notes:

In order to avoid tolerances between the terminal blocks and PCB, the terminal row should be interrupted when the number of positions exceeds 30.

1) Please observe the current carrying capacity curves. Further current carrying capacity curves on request.

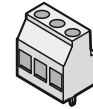



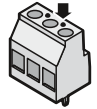

Metric 7.5 mm pitch



Detection lug for models with 7.62 mm inch pitch

Accessories

For all types	Type	Page
	Screwdriver SZS 0,6 x 3,5 Order No. 1205053	
	Marker cards SK 7,5/5 or SK 7,62/5	800
Only for GSMKDSP 1,5		
	Test plug MPS	831
	Reducing plug RPS Order No. 0201647	831

Current carrying capacity curve

Type: GMKDS 1,5/2 and GMKDS 1,5/3
Test following DIN EN 60512-5-2:2003-01
Reduction factor = 1
No. of positions: 5

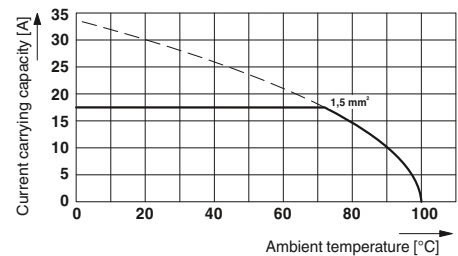

Technical data

Technical data in accordance to IEC / DIN VDE

Rated current / conductor cross section [A] / [mm²]

Rated insulation voltage for pollution degree 2 [V]

Pitch [mm]

Connection capacity

Solid / stranded [mm²] / [mm²] / AWG

Stranded with ferrules without plastic sleeve [mm²]

Stranded with ferrules with plastic sleeve [mm²]

Multi-conductor connection capacity (two conductors with the same cross section)

Solid / stranded [mm²]

Stranded with ferrules without plastic sleeve [mm²]

Stranded with TWIN ferrule with plastic sleeve [mm²]

Insulation coordination

Surge voltage category / pollution degree

Rated insulation voltage [V]

Rated surge voltage [kV]

Approval data (UL/CUL) Use Group

Nominal voltage [V]

Nominal current [A]

Connection capacity AWG AWG

Approval data (CSA) Use Group

Nominal voltage [V]

Nominal current [A]

Connection capacity AWG AWG

General data

Stripping length [mm]

Screw thread

Tightening torque [Nm]

Type of insulation material / insulation material group

Inflammability class according to UL 94

Drill hole diameter / pin dimensions [mm]

GMKDS 1,5/ ...

17.5¹⁾ / 1.5
630

7.5 / 7.62

0.14 - 1.5 / 0.14 - 1.5 / 26 - 16

0.25 - 1

0.25 - 1

0.14 - 1 / 0.14 - 0.75

0.25 - 0.5

0.5 - 1

III / 3 III / 2 II / 2

500 630 1000

6 6 6

B C D

300 - 300

10 - 10

30 - 14 - 30 - 14

B C D

300 - 300

10 - 10

28 - 14 - 28 - 14

6.5

M3

0.5 - 0.6

PA / I

V0

1.3 / 0.9 x 0.9 mm

GSMKDSP 1,5/ ...

17.5¹⁾ / 2.5
630

7.5 / 7.62

0.14 - 2.5 / 0.14 - 1.5 / 26 - 14

0.25 - 1.5

0.25 - 1.5

0.14 - 1 / 0.14 - 0.75

0.25 - 0.5

0.5 - 1

III / 3 III / 2 II / 2

500 630 1000

6 6 6

B C D

300 - 300

10 - 10

30 - 14 - 30 - 14

B C D

- - -

- - -

- - -

7

M3

0.5 - 0.6

PA / I

V0

1.3 / 0.9 x 0.9 mm

No. of pos. Dim. a [mm]

2 7.50

3 15.00

2 7.62

3 15.24



With horizontal connection direction and housing overlapping

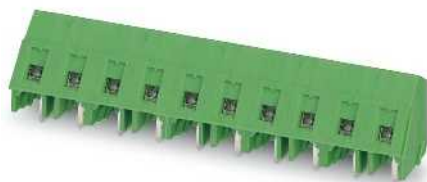

With 35° angled connection direction and housing overlapping



Dimensional drawing

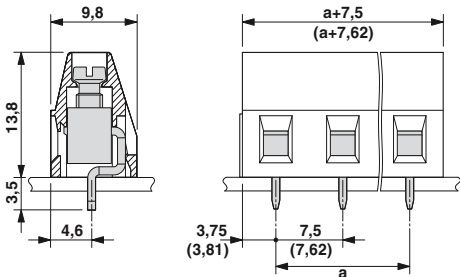

Drilling diagram

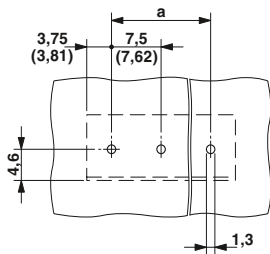

Dimensional drawing

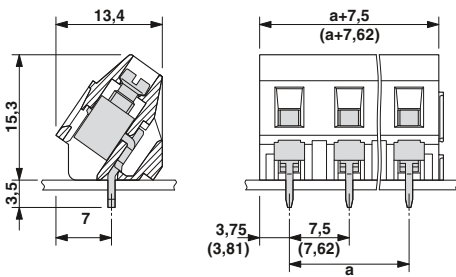

Drilling diagram

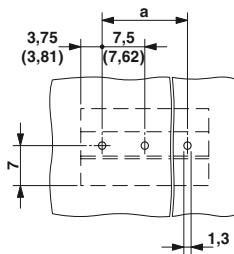

Ordering data

Type	Order No.	Pcs. / Pkt.
7.5 mm pitch, color: green		
GMKDS 1,5/ 2	1717020	250
GMKDS 1,5/ 3	1717033	250
Pitch 7.62 mm, color: green		
GMKDS 1,5/ 2-7,62	1717729	250
GMKDS 1,5/ 3-7,62	1717732	250

Ordering data

Type	Order No.	Pcs. / Pkt.
7.5 mm pitch, color: green		
GSMKDSP 1,5/ 2	1718029	250
GSMKDSP 1,5/ 3	1718032	250
Pitch 7.62 mm, color: green		
GSMKDSP 1,5/ 2-7,62	1718728	250
GSMKDSP 1,5/ 3-7,62	1718731	250

PCB terminal blocks with 2.54 to 7.62 mm pitch

PCB terminal blocks with screw connection for wave soldering processes, currents of up to 41 A

Connection cross section of up to 2.5 mm²

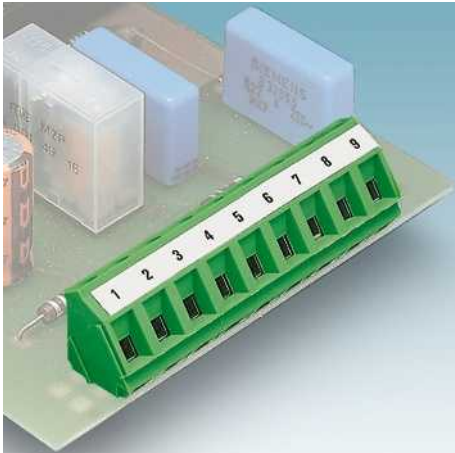

- Single-row PCB terminal blocks for 630 V applications with a 7.62 mm pitch
- Can be connected in series with corresponding standard models of the MKDS 3 range

GMKDSP 3/...

- With an additionally integrated test connection to accommodate 2 mm Ø test pins or 2.3 mm Ø test connectors

GSMKDS 3/...

- Conductor and screwdriver axis at an angle of 35° to the PCB
- An arrangement of several terminal block rows one behind the other – multi-level effect with the same design

Notes:

In order to avoid tolerances between the terminal blocks and PCB, the terminal row should be interrupted when the number of positions exceeds 30.

1) Please observe the current carrying capacity curves. Further current carrying capacity curves on request.

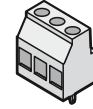

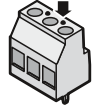

Metric 7.5 mm pitch



Detection lug for models with 7.62 mm inch pitch

Accessories

For all types	Type	Page
	Marker cards SK 7,5/5 or SK 7,62/5	800
	Screwdriver SZS 0,6 x 3,5 Order No. 1205053	
Only for GMKDS 3 and GMKDSP 3		
	Single cover for individual terminal positions EA-MKDS Order No. 1711408	
Only for GMKDS 3		
	Test plug MPS	831
	Reducing plug RPS Order No. 0201647	831
	Test plug SPB 5-MKDS 3 Order No. 1301216	833

Current carrying capacity curve

Type: GMKDS 3/2 and GMKDS 3/3
Test following DIN EN 60512-5-2:2003-01
Reduction factor = 1
No. of positions: 5

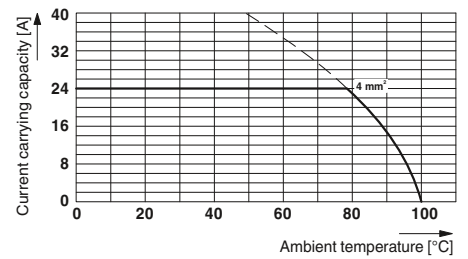

Technical data

Technical data in accordance to IEC / DIN VDE	
Rated current / conductor cross section	[A] / [mm ²]
Rated insulation voltage for pollution degree 2	[V]
Pitch	[mm]
Connection capacity	
Solid / stranded	[mm ²] / [mm ²] / AWG
Stranded with ferrules without plastic sleeve	[mm ²]
Stranded with ferrules with plastic sleeve	[mm ²]
Multi-conductor connection capacity (two conductors with the same cross section)	
Solid / stranded	[mm ²]
Stranded with ferrules without plastic sleeve	[mm ²]
Stranded with TWIN ferrule with plastic sleeve	[mm ²]
Insulation coordination	
Surge voltage category / pollution degree	
Rated insulation voltage	[V]
Rated surge voltage	[kV]
Approval data (UL/CUL)	Use Group
Nominal voltage	[V]
Nominal current	[A]
Connection capacity AWG	AWG
Approval data (CSA)	Use Group
Nominal voltage	[V]
Nominal current	[A]
Connection capacity AWG	AWG
General data	
Stripping length	[mm]
Screw thread	
Tightening torque	[Nm]
Type of insulation material / insulation material group	
Inflammability class according to UL 94	
Drill hole diameter / pin dimensions	[mm]

GMKDS 3/ ...			GMKDSP 3/ ...			GSMKDS 3/ ...		
24 ¹⁾ / 4			24 ¹⁾ / 4			24 ¹⁾ / 4		
630			630			630		
7.5 / 7.62			7.5 / 7.62			7.5 / 7.62		
0.2 - 4 / 0.2 - 2.5 / 24 - 12			0.2 - 4 / 0.2 - 2.5 / 24 - 12			0.2 - 4 / 0.2 - 2.5 / 24 - 12		
0.25 - 2.5			0.25 - 2.5			0.25 - 2.5		
0.25 - 2.5			0.25 - 2.5			0.25 - 2.5		
0.2 - 1.5 / 0.2 - 1.5			0.2 - 1.5 / 0.2 - 1.5			0.2 - 1.5 / 0.2 - 1.5		
0.25 - 0.75			0.25 - 0.75			0.25 - 0.75		
0.5 - 1.5			0.5 - 1.5			0.5 - 1.5		
III / 3	III / 2	II / 2	III / 3	III / 2	II / 2	III / 3	III / 2	II / 2
500	630	1000	500	630	1000	500	630	1000
6	6	6	6	6	6	6	6	6
B	C	D	B	C	D	B	C	D
250	-	300	250	-	300	250	-	300
15	-	10	15	-	10	15	-	10
30 - 12	-	30 - 12	30 - 12	-	30 - 12	30 - 12	-	30 - 12
B	C	D	B	C	D	B	C	D
300	-	300	-	-	-	300	-	300
10	-	10	-	-	-	10	-	10
28 - 12	-	28 - 12	-	-	-	28 - 12	-	28 - 12
8			7			8		
M3			M3			M3		
0.5 - 0.6			0.5 - 0.6			0.5 - 0.6		
PA / I			PA / I			PA / II		
V0			V2			V0		
1.3 / 0.9 x 0.9 mm			1.3 / 0.9 x 0.9 mm			1.3 / 0.9 x 0.9 mm		

No. of pos.	Dim. a [mm]
2	7.50
3	15.00
2	7.62
3	15.24

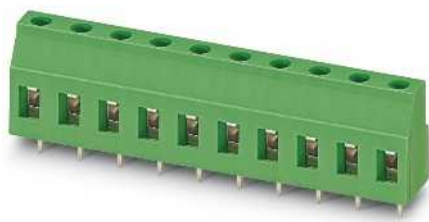

With housing overlapping

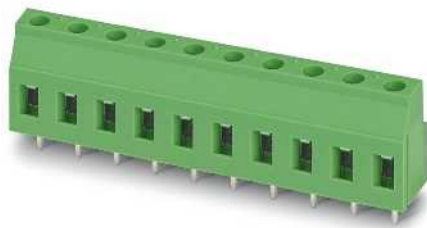

With test connection and housing overlapping



With 35° angled connection direction and housing overlapping



Dimensional drawing

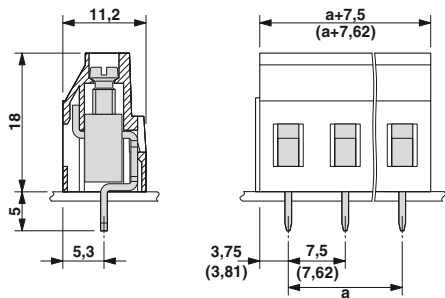

Drilling diagram

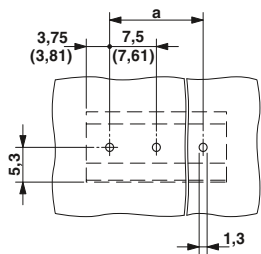

Ordering data

Type	Order No.	Pcs. / Pkt.
7.5 mm pitch, color: green		
GMKDS 3/ 2	1731022	100
GMKDS 3/ 3	1731035	100
Pitch 7.62 mm, color: green		
GMKDS 3/ 2-7,62	1731721	100
GMKDS 3/ 3-7,62	1731734	100



Dimensional drawing

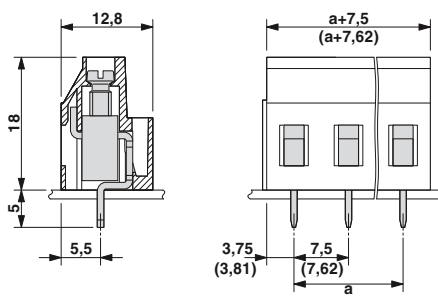

Drilling diagram

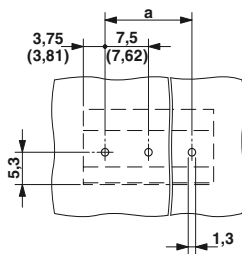

Ordering data

Type	Order No.	Pcs. / Pkt.
7.5 mm pitch, color: green		
GMKDSP 3/ 2	1732021	50
GMKDSP 3/ 3	1732034	50
Pitch 7.62 mm, color: green		
GMKDSP 3/ 2-7,62	1732720	50
GMKDSP 3/ 3-7,62	1732733	50



Dimensional drawing

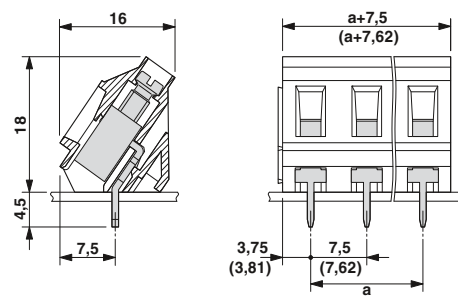

Drilling diagram

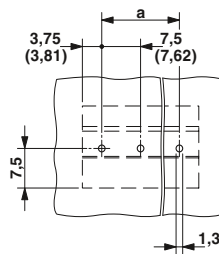

Ordering data

Type	Order No.	Pcs. / Pkt.
7.5 mm pitch, color: green		
GSMKDS 3/ 2	1733020	100
GSMKDS 3/ 3	1733033	100
Pitch 7.62 mm, color: green		
GSMKDS 3/ 2-7,62	1733729	100
GSMKDS 3/ 3-7,62	1733732	100

PCB terminal blocks with 2.54 to 7.62 mm pitch

PCB terminal blocks with screw connection for wave soldering processes, currents of up to 41 A

Connection cross section of up to 2.5 mm²



- PCB terminal block ME MAX electronic housing
- PCB terminal block is orthogonal to the PCB
- "Left" and "right" design
- 7.5 mm pitch
- 2 and 3-pos.

Accessories		
For all types	Type	Page
	Marker cards SK 7,5/3,8	799
	Screwdriver SZS 0,6 x 3,5 Order No. 1205053	

Current carrying capacity curve

Type: MKDSO 2,5 HV/3L-7,5 KMGY
 Tested in accordance with DIN EN 60512-5-2: 2003-01
 Reduction factor: 1
 No. of positions: 3

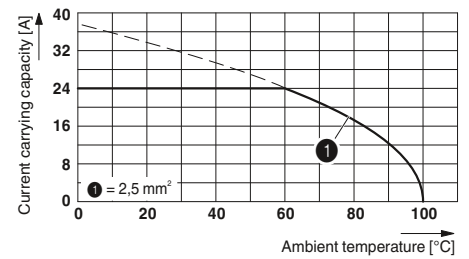

Technical data

Technical data in accordance to IEC / DIN VDE	
Rated current / conductor cross section	[A] / [mm ²]
Rated insulation voltage for pollution degree 2	[V]
Pitch	[mm]
Connection capacity	
Solid / stranded	[mm ²] / [mm ²] / AWG
Stranded with ferrules without plastic sleeve	[mm ²]
Stranded with ferrules with plastic sleeve	[mm ²]
Multi-conductor connection capacity (two conductors with the same cross section)	
Solid / stranded	[mm ²]
Stranded with ferrules without plastic sleeve	[mm ²]
Stranded with TWIN ferrule with plastic sleeve	[mm ²]
Insulation coordination	
Surge voltage category / pollution degree	
Rated insulation voltage	[V]
Rated surge voltage	[kV]
Approval data (UL/CUL)	Use Group
Nominal voltage	[V]
Nominal current	[A]
Connection capacity AWG	AWG
Approval data (CSA)	Use Group
Nominal voltage	[V]
Nominal current	[A]
Connection capacity AWG	AWG
General data	
Stripping length	[mm]
Screw thread	
Tightening torque	[Nm]
Type of insulation material / insulation material group	
Inflammability class according to UL 94	
Drill hole diameter / pin dimensions	[mm]

MKDSO 2,5 HV/ ...L-7,5 KMGY			MKDSO 2,5 HV/ ...R-7,5 KMGY		
Rated current / conductor cross section			24 / 2.5		
Rated insulation voltage for pollution degree 2			630		
Pitch			7.5		
Connection capacity					
Solid / stranded			0.2 - 2.5 / 0.2 - 2.5 / 24 - 14		
Stranded with ferrules without plastic sleeve			0.25 - 2.5		
Stranded with ferrules with plastic sleeve			0.25 - 2.5		
Multi-conductor connection capacity (two conductors with the same cross section)					
Solid / stranded			0.2 - 0.75 / 0.25 - 0.75		
Stranded with ferrules without plastic sleeve			0.25 - 0.75		
Stranded with TWIN ferrule with plastic sleeve			0.25 - 1.5		
Insulation coordination					
Surge voltage category / pollution degree			III / 3	III / 2	II / 2
Rated insulation voltage			600	630	1000
Rated surge voltage			6	6	6
Approval data (UL/CUL)			B	C	D
Nominal voltage			300	300	600
Nominal current			20	20	5
Connection capacity AWG			30 - 12	30 - 12	30 - 12
Approval data (CSA)			B	C	D
Nominal voltage			-	-	-
Nominal current			-	-	-
Connection capacity AWG			-	-	-
General data					
Stripping length			8		
Screw thread			M3		
Tightening torque			0.5 - 0.6		
Type of insulation material / insulation material group			PA / I		
Inflammability class according to UL 94			V0		
Drill hole diameter / pin dimensions			1.4 / 0.8 mm x 1 mm		

No. of pos.	Dim. a [mm]
2	7.50
3	15.00



With "left" solder pins leading off at a right angle

With "right" solder pins leading off at a right angle



Dimensional drawing

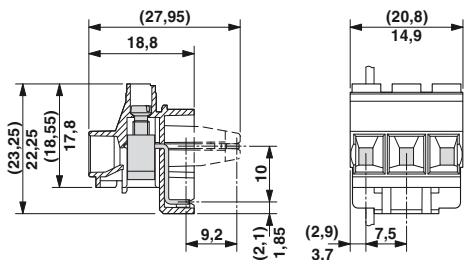

Dimensional drawing

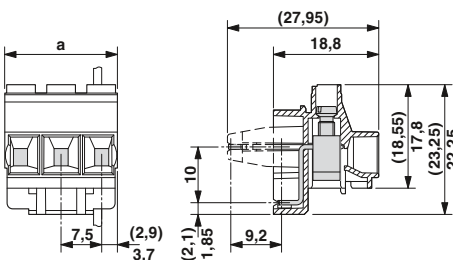

Drilling diagram

Drill hole 1 only for 3-pos. version

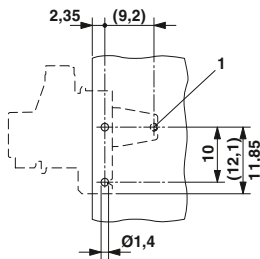

Drilling diagram

Drill hole 1 only for 3-pos. version

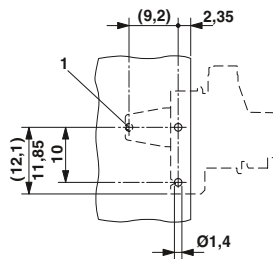

Ordering data

Type	Order No.	Pcs. / Pkt.
PCB terminal block, high-current-compatible, only for ME MAX housing, 7.5 mm pitch, color: light gray		
MKDSO 2,5 HV/ 2L-7,5 KMGY	2199676	50
MKDSO 2,5 HV/ 3L-7,5 KMGY	2890946	50

Ordering data

Type	Order No.	Pcs. / Pkt.
PCB terminal block, high-current-compatible, only for ME MAX housing, 7.5 mm pitch, color: light gray		
MKDSO 2,5 HV/ 2R-7,5 KMGY	2199773	50
MKDSO 2,5 HV/ 3R-7,5 KMGY	2890959	50

PCB terminal blocks with 2.54 to 7.62 mm pitch

PCB terminal blocks with screw connection for wave soldering processes, currents of up to 41 A

Single terminal blocks of up to 4 mm²

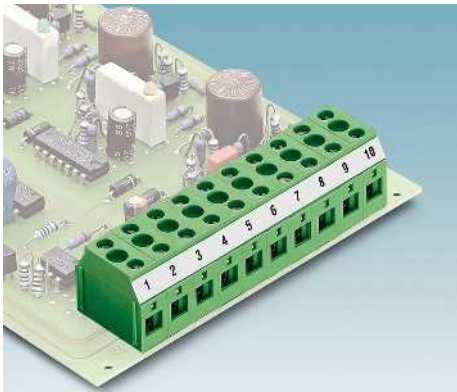

- Rugged single terminal block
- Double solder pin for high stability on the PCB
- Low-heat generating current transfer in the conducting path
- Increase in voltage with pitch spacers
- Allows a through wiring with a separate exit to the PCB
- A plate-type design enables blocking for larger number of positions

Notes:
1) It achieves 500 V when a RZ-KDS 4 pitch spacer is inserted.
2) Current carrying capacity between the conductor connections: 41 A; for solder connection: 32 A. Please observe the current carrying capacity curve. Other current carrying capacity curves are available on request.

Accessories

For all types	Type	Page
	Marker cards SK 7,5/3,8	799
	Pitch spacer, width: 2.5 mm RZ-KDS 4 Order No. 1705058	
	Screwdriver SZS 0,6 x 3,5 Order No. 1205053	
Only for KDSP 4		
	Test plug MPS	831
	Reducing plug RPS Order No. 0201647	831

Current carrying capacity curve

Type: KDS 4
Test following DIN EN 60512-5-2:2003-01
Reduction factor = 1
No. of positions: 5

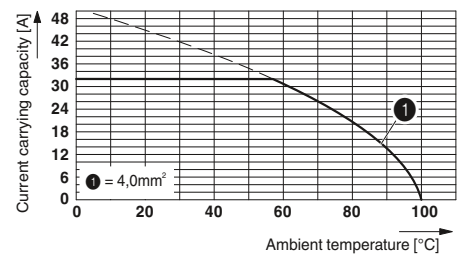

Technical data

Technical data in accordance to IEC / DIN VDE

Rated current / conductor cross section [A] / [mm²]
Rated insulation voltage for pollution degree 2 [V]

Pitch [mm]

Connection capacity

Solid / stranded [mm²] / [mm²] / AWG

Stranded with ferrules without plastic sleeve [mm²]

Stranded with ferrules with plastic sleeve [mm²]

Multi-conductor connection capacity (two conductors with the same cross section)

Solid / stranded [mm²]

Stranded with ferrules without plastic sleeve [mm²]

Stranded with TWIN ferrule with plastic sleeve [mm²]

Insulation coordination

Surge voltage category / pollution degree

Rated insulation voltage [V]

Rated surge voltage [kV]

Approval data (UL/CUL) Use Group

Nominal voltage [V]

Nominal current [A]

Connection capacity AWG AWG

Approval data (CSA) Use Group

Nominal voltage [V]

Nominal current [A]

Connection capacity AWG AWG

General data

Stripping length [mm]

Screw thread

Tightening torque [Nm]

Type of insulation material / insulation material group

Inflammability class according to UL 94

Drill hole diameter / pin dimensions [mm]

KDS 4

KDSP 4

Rated current / conductor cross section [A] / [mm ²]	41 ²⁾ / 6			41 ²⁾ / 6		
Rated insulation voltage for pollution degree 2 [V]	320			320		
Pitch [mm]	7.5			7.5		
Connection capacity						
Solid / stranded [mm ²] / [mm ²] / AWG	0.2 - 6 / 0.2 - 4 / 24 - 10			0.2 - 6 / 0.2 - 4 / 24 - 10		
Stranded with ferrules without plastic sleeve [mm ²]	0.25 - 4			0.25 - 4		
Stranded with ferrules with plastic sleeve [mm ²]	0.25 - 4			0.25 - 4		
Multi-conductor connection capacity (two conductors with the same cross section)						
Solid / stranded [mm ²]	0.2 - 1.5 / 0.2 - 1			0.2 - 1.5 / 0.2 - 1		
Stranded with ferrules without plastic sleeve [mm ²]	0.25 - 1			0.25 - 1		
Stranded with TWIN ferrule with plastic sleeve [mm ²]	0.5 - 2.5			0.5 - 2.5		
Insulation coordination						
Surge voltage category / pollution degree	III / 3	III / 2	II / 2	III / 3	III / 2	II / 2
Rated insulation voltage [V]	320 ¹⁾	320	630	320 ¹⁾	320	630
Rated surge voltage [kV]	4	4	4	4	4	4
Approval data (UL/CUL) Use Group	B	C	D	B	C	D
Nominal voltage [V]	300	-	300	300	-	300
Nominal current [A]	30	-	10	30	-	10
Connection capacity AWG AWG	30 - 10	-	30 - 10	30 - 10	-	30 - 10
Approval data (CSA) Use Group	B	C	D	B	C	D
Nominal voltage [V]	300	-	300	300	-	300
Nominal current [A]	30	-	10	30	-	10
Connection capacity AWG AWG	28 - 10	-	28 - 10	28 - 10	-	28 - 10
General data						
Stripping length [mm]	8			8		
Screw thread	M3			M3		
Tightening torque [Nm]	0.6 - 0.8			0.6 - 0.8		
Type of insulation material / insulation material group	PA / I			PA / I		
Inflammability class according to UL 94	V0			V0		
Drill hole diameter / pin dimensions [mm]	1.3 / 0.9 x 0.9 mm			1.3 / 0.9 x 0.9 mm		

No. of pos.

1



Single terminal block



Single terminal block with test connection



Dimensional drawing

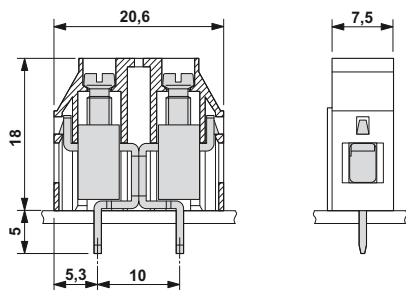

Drilling diagram

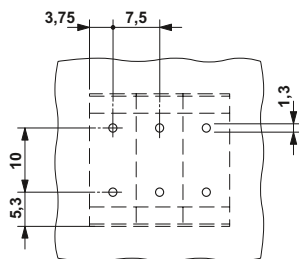

Ordering data

Type	Order No.	Pcs. / Pkt.
7.5 mm pitch, color: green		
KDS 4	1780507	50



Dimensional drawing

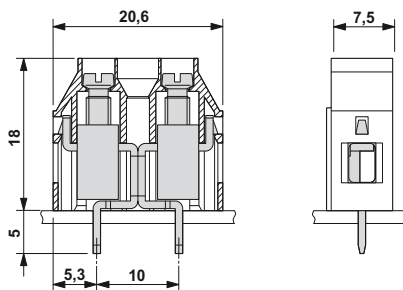

Drilling diagram

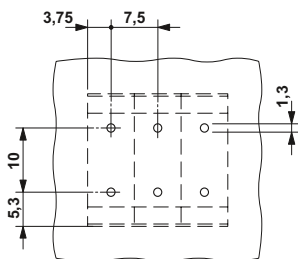

Ordering data

Type	Order No.	Pcs. / Pkt.
7.5 mm pitch, color: green		
KDSP 4	1780536	50

PCB terminal blocks with 2.54 to 7.62 mm pitch

PCB terminal blocks with spring-cage connection for wave soldering processes, currents up to 24 A

Connection cross section of up to 1.5 mm²

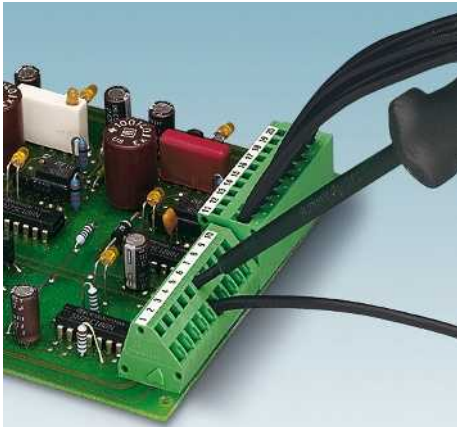





- Pitch: 3.81 mm
- Single-level PCB single terminal blocks with spring-cage connection
- A plate-type design enables blocking for larger number of positions
- Double solder pin for high stability on the PCB
- W-type with an orange opening lever, enables operation of the terminal point without tools
- Delivery form: position discs in blocks of 10
- Products with various numbers of positions with an end terminal can be supplied on request

Notes:

In order to avoid tolerances between the terminal blocks and PCB, the terminal row should be interrupted when the number of positions exceeds 30.

1) Please observe the current carrying capacity curves. Further current carrying capacity curves on request.

Accessories

For all types	Type	Page
	Marker cards SK 3,81/2,8	797
	Screwdriver SZF 0-0,4 x 2,5 Order No. 1204504	
	Ferrules with and without plastic sleeve	834
	Crimping pliers for 0.25 to 6 mm ² CRIMPFOX 6 Order No. 1212034	

Current carrying capacity curve

Type: ZFKDS 1-3,81
Test following DIN EN 60512-5-2:2003-01
Reduction factor = 1
No. of positions: 5

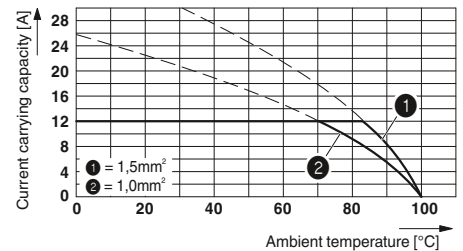

Technical data

Technical data in accordance to IEC / DIN VDE

Rated current / conductor cross section	[A] / [mm ²]
Rated insulation voltage for pollution degree 2	[V]
Pitch	[mm]
Connection capacity	
Solid / stranded	[mm ²] / [mm ²] / AWG
Stranded with ferrules without plastic sleeve	[mm ²]
Stranded with ferrules with plastic sleeve	[mm ²]
Insulation coordination	
Surge voltage category / pollution degree	
Rated insulation voltage	[V]
Rated surge voltage	[kV]
Approval data (UL/CUL)	Use Group
Nominal voltage	[V]
Nominal current	[A]
Connection capacity AWG	AWG
Approval data (CSA)	Use Group
Nominal voltage	[V]
Nominal current	[A]
Connection capacity AWG	AWG
General data	
Stripping length	[mm]
Type of insulation material / insulation material group	
Inflammability class according to UL 94	
Drill hole diameter / pin dimensions	[mm]

ZFKDS 1-3,81

Rated current / conductor cross section	12 ¹⁾ / 1.5			12 ¹⁾ / 1.5		
Rated insulation voltage for pollution degree 2	200			200		
Pitch	3.81			3.81		
Connection capacity						
Solid / stranded	0.14 - 1.5 / 0.14 - 1 / 26 - 16			0.14 - 1.5 / 0.14 - 1 / 26 - 16		
Stranded with ferrules without plastic sleeve	0.25 - 0.5			0.25 - 0.5		
Stranded with ferrules with plastic sleeve	0.25 - 0.5			0.25 - 0.5		
Insulation coordination						
Surge voltage category / pollution degree	III / 3	III / 2	II / 2	III / 3	III / 2	II / 2
Rated insulation voltage	200	200	400	160	200	400
Rated surge voltage	2.5	2.5	2.5	2.5	2.5	2.5
Approval data (UL/CUL)	B	C	D	B	C	D
Nominal voltage	250	-	300	250	-	300
Nominal current	10	-	10	10	-	10
Connection capacity AWG	26 - 16	-	26 - 16	26 - 16	-	26 - 16
Approval data (CSA)	B	C	D	B	C	D
Nominal voltage	-	-	-	-	-	-
Nominal current	-	-	-	-	-	-
Connection capacity AWG	-	-	-	-	-	-
General data						
Stripping length	7.5			7.5		
Type of insulation material / insulation material group	PA / I			PA / I		
Inflammability class according to UL 94	V0			V0		
Drill hole diameter / pin dimensions	1.2 / 0.7 x 0.8 mm			1.2 / 0.7 x 1 mm		

No. of pos.

1

1



Without actuation rocker,
with housing overlapping

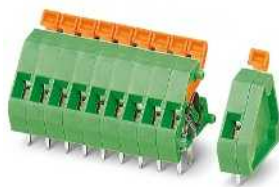

With actuation rocker
and housing overlapping



Dimensional drawing

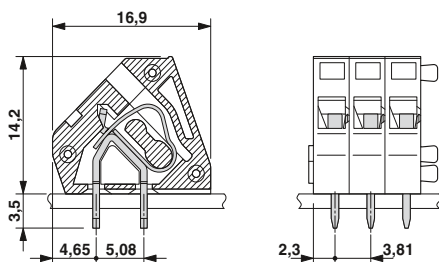

Drilling diagram

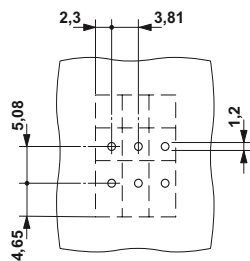

Ordering data

Type	Order No.	Pcs. / Pkt.
Pitch 3.81 mm, color: green		
ZFKDS 1-3,81	1704978	50
End terminal block, 6.35 mm wide, necessary at the end of a row of terminal blocks		
ZFKDSA 1-6,35	1704981	50



Dimensional drawing

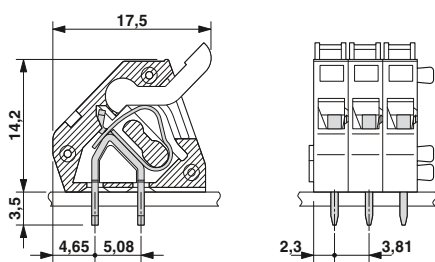

Drilling diagram

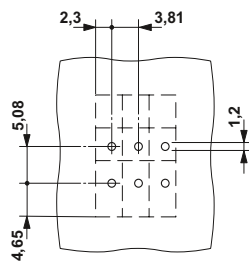

Ordering data

Type	Order No.	Pcs. / Pkt.
Pitch 3.81 mm, color: green		
ZFKDS 1-W-3,81	1705003	50
End terminal block, with actuation rocker, 6.35 mm wide, necessary at the end of a row of terminal blocks		
ZFKDSA 1-W-6,35	1704994	50

PCB terminal blocks with 2.54 to 7.62 mm pitch

PCB terminal blocks with spring-cage connection for wave soldering processes, currents up to 24 A

Connection cross section of up to 1.5 mm²

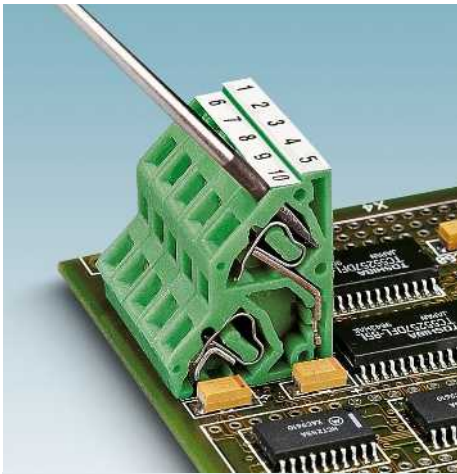

- 5.0 or 5.08 mm pitch
- Single and double-level PCB single terminal blocks with spring-cage connection
- A plate-type design enables blocking for larger number of positions
- Double solder pin for high stability on the PCB
- Compact housing dimensions
- W-type with an orange opening lever, enables operation of the terminal point without tools
- Delivery form: position discs in blocks of 10
- Products with various numbers of positions with an end terminal can be supplied on request

Notes:
 In order to avoid tolerances between the terminal blocks and PCB, the terminal row should be interrupted when the number of positions exceeds 30.
 1) Please observe the current carrying capacity curves. Further current carrying capacity curves on request.

Accessories		
For all types	Type	Page
	Screwdriver SZF 1-0,6 x 3,5 Order No. 1204517	
	Ferrules with and without plastic sleeve	834
	Crimping pliers for 0.25 to 6 mm ² CRIMPFIX 6 Order No. 1212034	
Only for ZFKDS 1,5C-5,0 and ZFKKDS 1,5C-5,0		
	Marker cards SK 5/3,8	798
Only for ZFKDS 1,5-W-5,08		
	Marker cards SK 5,08/3,8	798
	Pitch spacer, width: 2.54 mm RZ-ZFKDS 1,5 Order No. 1870666	

Current carrying capacity curve

Type: ZFKDS 1,5C-5,0
 Test following DIN EN 60512-5-2:2003-01
 Reduction factor = 1
 No. of positions: 5

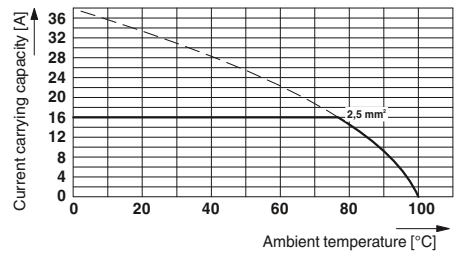

Technical data

Technical data in accordance to IEC / DIN VDE	
Rated current / conductor cross section	[A] / [mm ²]
Rated insulation voltage for pollution degree 2	[V]
Pitch	[mm]
Connection capacity	
Solid / stranded	[mm ²] / [mm ²] / AWG
Stranded with ferrules without plastic sleeve	[mm ²]
Stranded with ferrules with plastic sleeve	[mm ²]
Insulation coordination	
Surge voltage category / pollution degree	
Rated insulation voltage	[V]
Rated surge voltage	[kV]
Approval data (UL/CUL)	Use Group
Nominal voltage	[V]
Nominal current	[A]
Connection capacity AWG	AWG
Approval data (CSA)	Use Group
Nominal voltage	[V]
Nominal current	[A]
Connection capacity AWG	AWG
General data	
Stripping length	[mm]
Type of insulation material / insulation material group	
Inflammability class according to UL 94	
Drill hole diameter / pin dimensions	[mm]

ZFKDS 1,5C-5,0			ZFKKDS 1,5C-5,0			ZFKDS 1,5-W-5,08		
16 ¹⁾ / 2.5			16 ¹⁾ / 2.5			16 ¹⁾ / 2.5		
400			400			400		
5			5			5.08		
0.2 - 2.5 / 0.2 - 1.5 / 24 - 14			0.2 - 2.5 / 0.2 - 1.5 / 24 - 14			0.2 - 2.5 / 0.2 - 1.5 / 24 - 14		
0.25 - 1.5			0.25 - 1.5			0.25 - 1.5		
0.25 - 1.5			0.25 - 1.5			0.25 - 1.5		
III / 3	III / 2	II / 2	III / 3	III / 2	II / 2	III / 3	III / 2	II / 2
250	400	630	250	400	630	250	400	630
4	4	4	4	4	4	4	4	4
B	C	D	B	C	D	B	C	D
250	-	300	250	-	300	-	-	-
10	-	10	10	-	10	-	-	-
26 - 12	-	26 - 12	26 - 12	-	26 - 12	-	-	-
B	C	D	B	C	D	B	C	D
-	-	-	-	-	-	300	-	300
-	-	-	-	-	-	10	-	10
-	-	-	-	-	-	28 - 12	-	28 - 12
7			7			7.5		
PA / I			PA / I			PA / I		
V0			V0			V0		
1.1 / 0.7 x 0.7			1.1 / 0.7 x 0.7 mm			1.3 / 0.7 x 1 mm		

No. of pos.	
1	
1	
1	
1	
1	

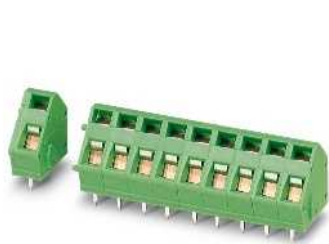

Compact design,
without actuation rocker



Double-level PCB terminal block,
compact design,
without actuation rocker



With actuation rocker



Dimensional drawing

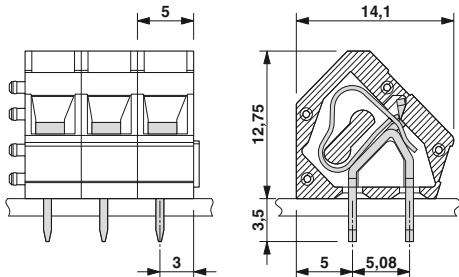

Drilling diagram

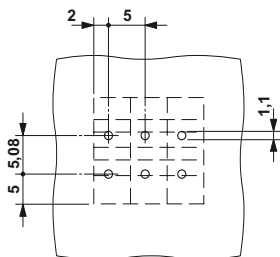

Ordering data

Type	Order No.	Pcs. / Pkt.
5.0 mm pitch, color: green		
ZFKDS 1,5C-5,0	1889259	50
End terminal, 6.4 mm wide, necessary at the end of a row of terminal blocks		
ZFKDSA 1,5C-6,0	1889262	50



Dimensional drawing

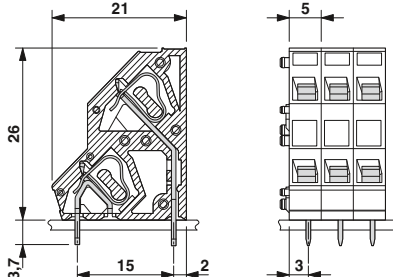

Drilling diagram

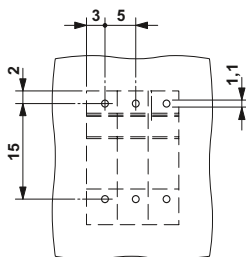

Ordering data

Type	Order No.	Pcs. / Pkt.
5.0 mm pitch, color: green		
ZFKKDS 1,5C-5,0	1889301	50
End terminal block, 5 mm wide, necessary at the beginning of a row of terminal blocks (left), if a smooth side element is desired		
ZFKKDSA 1,5C-5,0 L	1889275	50
End terminal block, necessary at the end of a row of terminal blocks (right)		
ZFKKDSA 1,5C-6,0 R	1889288	50



Dimensional drawing

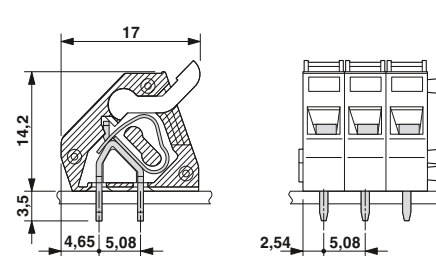

Drilling diagram

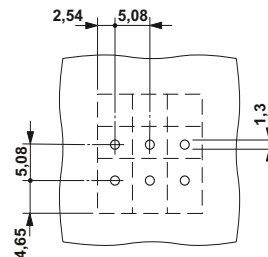

Ordering data

Type	Order No.	Pcs. / Pkt.
5.08 mm pitch, color: green		
ZFKDS 1,5-W-5,08	1706714	250
End terminal block, with actuation rocker, 7.62 mm wide, necessary at the end of a row of terminal blocks		
ZFKDSA 1,5-W-7,62	1706730	250

PCB terminal blocks with 2.54 to 7.62 mm pitch

PCB terminal blocks with spring-cage connection for wave soldering processes, currents up to 24 A

Connection cross section of up to 1.5 mm²

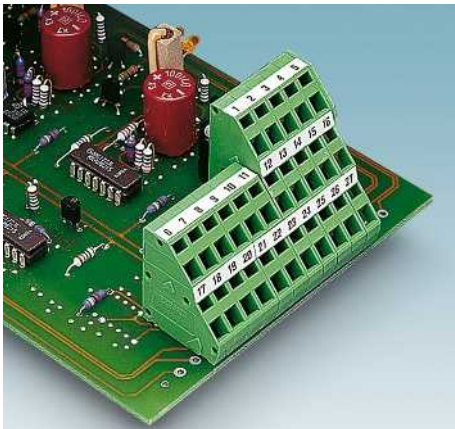





- 5.08 mm pitch
- Three and four-level PCB single terminal blocks with spring-cage connection
- A plate-type design enables blocking for larger number of positions
- Pin-compatible with screw connection of PCB terminal blocks MK3DS 1,5 and MK4DS 1,5; two alternative connection technologies are thus available for the same application without complex changes in the layout.
- Delivery form: position discs in blocks of 10
- Products with various numbers of positions with an end terminal can be supplied on request

Notes:

In order to avoid tolerances between the terminal blocks and PCB, the terminal row should be interrupted when the number of positions exceeds 30.

1) Please observe the current carrying capacity curves. Further current carrying capacity curves on request.

Accessories

For all types	Type	Page
	Marker cards SK 5,08/3,8	798
	Screwdriver SZF 1-0,6 x 3,5 Order No. 1204517	
	Ferrules with and without plastic sleeve	834
	Crimping pliers for 0.25 to 6 mm ² CRIMPFOX 6 Order No. 1212034	

Current carrying capacity curve

Type: ZFK3DS 1,5-5,08
Test following DIN EN 60512-5-2:2003-01
Reduction factor = 1
No. of positions: 5

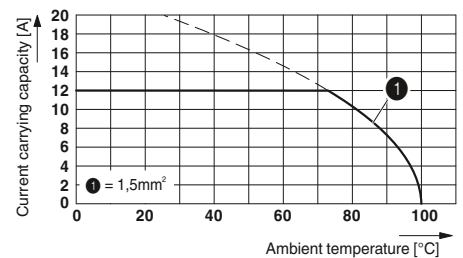

Technical data

Technical data in accordance to IEC / DIN VDE

Rated current / conductor cross section	[A] / [mm ²]
Rated insulation voltage for pollution degree 2	[V]
Pitch	[mm]
Connection capacity	
Solid / stranded	[mm ²] / [mm ²] / AWG
Stranded with ferrules without plastic sleeve	[mm ²]
Stranded with ferrules with plastic sleeve	[mm ²]
Insulation coordination	
Surge voltage category / pollution degree	
Rated insulation voltage	[V]
Rated surge voltage	[kV]
Approval data (UL/CUL)	Use Group
Nominal voltage	[V]
Nominal current	[A]
Connection capacity AWG	AWG
Approval data (CSA)	Use Group
Nominal voltage	[V]
Nominal current	[A]
Connection capacity AWG	AWG
General data	
Stripping length	[mm]
Type of insulation material / insulation material group	
Inflammability class according to UL 94	
Drill hole diameter / pin dimensions	[mm]

ZFK3DS 1,5-5,08

Rated current / conductor cross section	12 ¹⁾ / 2.5
Rated insulation voltage for pollution degree 2	400
Pitch	5.08
Connection capacity	
Solid / stranded	0.2 - 2.5 / 0.2 - 1.5 / 24 - 14
Stranded with ferrules without plastic sleeve	0.25 - 1.5
Stranded with ferrules with plastic sleeve	0.25 - 1.5
Insulation coordination	
Surge voltage category / pollution degree	III / 3 III / 2 II / 2
Rated insulation voltage	250 400 630
Rated surge voltage	4 4 4
Approval data (UL/CUL)	B C D
Nominal voltage	250 - 300
Nominal current	10 - 10
Connection capacity AWG	26 - 12 - 26 - 12
Approval data (CSA)	B C D
Nominal voltage	300 - -
Nominal current	10 - 10
Connection capacity AWG	28 - 12 - 28 - 12
General data	
Stripping length	7.5
Type of insulation material / insulation material group	PA / I
Inflammability class according to UL 94	V0
Drill hole diameter / pin dimensions	1.3 / 0.7 x 1 mm

ZFK4DS 1,5-5,08

Rated current / conductor cross section	12 ¹⁾ / 2.5
Rated insulation voltage for pollution degree 2	400
Pitch	5.08
Connection capacity	
Solid / stranded	0.2 - 2.5 / 0.2 - 1.5 / 24 - 14
Stranded with ferrules without plastic sleeve	0.25 - 1.5
Stranded with ferrules with plastic sleeve	0.25 - 1.5
Insulation coordination	
Surge voltage category / pollution degree	III / 3 III / 2 II / 2
Rated insulation voltage	250 400 630
Rated surge voltage	4 4 4
Approval data (UL/CUL)	B C D
Nominal voltage	250 - 300
Nominal current	10 - 10
Connection capacity AWG	26 - 12 - 26 - 12
Approval data (CSA)	B C D
Nominal voltage	- - -
Nominal current	- - -
Connection capacity AWG	- - -
General data	
Stripping length	7.5
Type of insulation material / insulation material group	PA / I
Inflammability class according to UL 94	V0
Drill hole diameter / pin dimensions	1.3 / 0.7 x 1 mm

No. of pos.

1

1

1



Three-level PCB terminal block

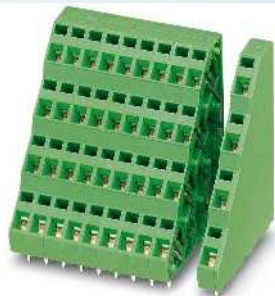

Four-level PCB terminal block



Dimensional drawing

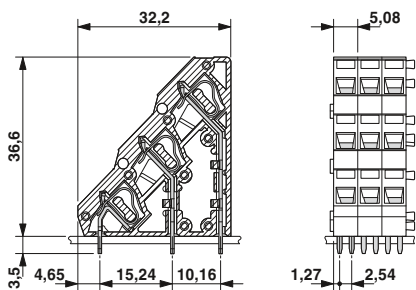

Drilling diagram

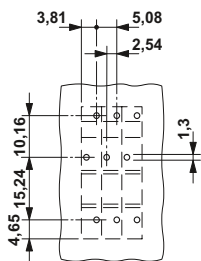

Dimensional drawing

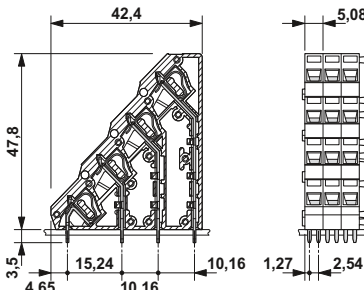

Drilling diagram

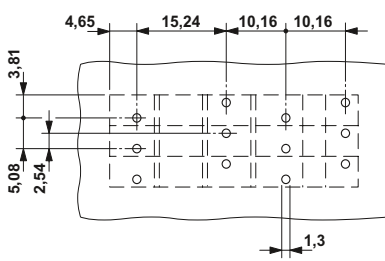

Ordering data

Type	Order No.	Pcs. / Pkt.
5.08 mm pitch, color: green		
ZFK3DS 1,5-5,08	1704415	100
End terminal block, 6.08 mm wide, necessary at the end of a row of terminal blocks		
ZFK3DSA 1,5-6,08	1704554	250
Segment terminal block, 6.35 mm wide, necessary to align double-level terminal blocks ZFKKDS 1,5-5,08		
ZFK3DSA 1,5-5,08-DS	1706167	50

Ordering data

Type	Order No.	Pcs. / Pkt.
5.08 mm pitch, color: green		
ZFK4DS 1,5-5,08	1869910	50
End terminal block, 6.08 mm wide, necessary at the end of a row of terminal blocks		
ZFK4DSA 1,5-6,08	1869923	50

PCB terminal blocks with 2.54 to 7.62 mm pitch

PCB terminal blocks with spring-cage connection for wave soldering processes, currents up to 24 A

Connection cross section of up to 2.5 mm²

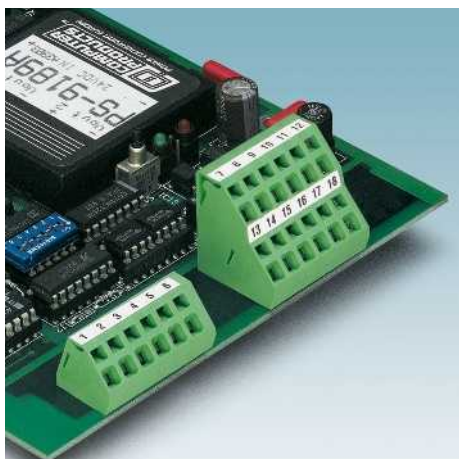

- 5.08 mm pitch
- A plate-type design enables blocking for larger number of positions
- Double solder pin for high stability on the PCB
- Delivery form: position discs in blocks of 10
- Products with various numbers of positions with an end terminal can be supplied on request

Notes:

In order to avoid tolerances between the terminal blocks and PCB, the terminal row should be interrupted when the number of positions exceeds 30.

1) Please observe the current carrying capacity curves. Further current carrying capacity curves on request.

Accessories

For all types	Type	Page
	Crimping pliers for 0.25 to 6 mm ² CRIMPFOX 6 Order No. 1212034	
	Screwdriver SZF 1-0,6 x 3,5 Order No. 1204517	
	Marker cards SK 5,08/3,8	798
Only for ZFKDS 2,5-5,08		
	Pitch spacer, width: 2.54 mm RZ-ZFKDS 2,5 Order No. 1931039	
Only for ZFKKDS 2,5-5,08		
	Pitch spacer, width: 2.54 mm RZ-ZFKKDS 2,5 Order No. 1934612	

Current carrying capacity curve

Type: ZFKDS 2,5-5,08
Test following DIN EN 60512-5-2:2003-01
Reduction factor = 1
No. of positions: 5

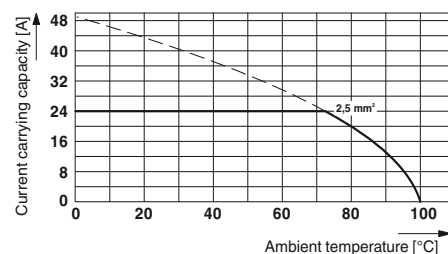

Technical data

Technical data in accordance to IEC / DIN VDE

Rated current / conductor cross section	[A] / [mm ²]
Rated insulation voltage for pollution degree 2	[V]
Pitch	[mm]
Connection capacity	
Solid / stranded	[mm ²] / [mm ²] / AWG
Stranded with ferrules without plastic sleeve	[mm ²]
Stranded with ferrules with plastic sleeve	[mm ²]
Insulation coordination	
Surge voltage category / pollution degree	
Rated insulation voltage	[V]
Rated surge voltage	[kV]
Approval data (UL/CUL)	Use Group
Nominal voltage	[V]
Nominal current	[A]
Connection capacity AWG	AWG
Approval data (CSA)	Use Group
Nominal voltage	[V]
Nominal current	[A]
Connection capacity AWG	AWG
General data	
Stripping length	[mm]
Type of insulation material / insulation material group	
Inflammability class according to UL 94	
Drill hole diameter / pin dimensions	[mm]

ZFKDS 2,5-5,08

Rated current / conductor cross section	24 ¹⁾ / 4
Rated insulation voltage for pollution degree 2	400
Pitch	5.08
Connection capacity	
Solid / stranded	0.2 - 4 / 0.2 - 2.5 / 24 - 12
Stranded with ferrules without plastic sleeve	0.25 - 2.5
Stranded with ferrules with plastic sleeve	0.25 - 1.5
Insulation coordination	
Surge voltage category / pollution degree	III / 3 III / 2 II / 2
Rated insulation voltage	250 400 630
Rated surge voltage	4 4 4
Approval data (UL/CUL)	B C D
Nominal voltage	250 - 300
Nominal current	10 - 10
Connection capacity AWG	26 - 12 - 26 - 12
Approval data (CSA)	B C D
Nominal voltage	- - -
Nominal current	- - -
Connection capacity AWG	- - -
General data	
Stripping length	7
Type of insulation material / insulation material group	PA / I
Inflammability class according to UL 94	V0
Drill hole diameter / pin dimensions	1.3 / 0.8 x 0.8 mm

ZFKKDS 2,5-5,08

Rated current / conductor cross section	17.5 ¹⁾ / 4
Rated insulation voltage for pollution degree 2	400
Pitch	5.08
Connection capacity	
Solid / stranded	0.2 - 4 / 0.2 - 2.5 / 24 - 12
Stranded with ferrules without plastic sleeve	0.25 - 2.5
Stranded with ferrules with plastic sleeve	0.25 - 1.5
Insulation coordination	
Surge voltage category / pollution degree	III / 3 III / 2 II / 2
Rated insulation voltage	250 400 630
Rated surge voltage	4 4 4
Approval data (UL/CUL)	B C D
Nominal voltage	250 - 300
Nominal current	10 - 10
Connection capacity AWG	26 - 12 - 26 - 12
Approval data (CSA)	B C D
Nominal voltage	- - -
Nominal current	- - -
Connection capacity AWG	- - -
General data	
Stripping length	7
Type of insulation material / insulation material group	PA / I
Inflammability class according to UL 94	V0
Drill hole diameter / pin dimensions	1.3 / 0.8 x 0.8 mm

No. of pos.

1

1

1



Single-level PCB terminal block



Double-level PCB terminal block



Dimensional drawing

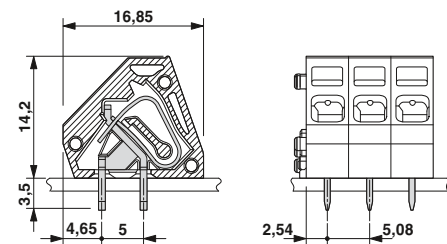

Drilling diagram

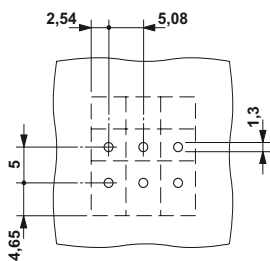

Ordering data

Type	Order No.	Pcs. / Pkt.
5.08 mm pitch, color: green		
ZFKDS 2,5-5,08	1904969	50
End terminal block, 5.08 mm wide, necessary at the end of a row of terminal blocks (left), if a smooth side element is desired		
ZFKDS 2,5-5,08 L	1905214	50
End terminal block, 6.08 mm wide, necessary at the end of a row of terminal blocks (right)		
ZFKDSA 2,5-6,08 R	1905010	50



Dimensional drawing

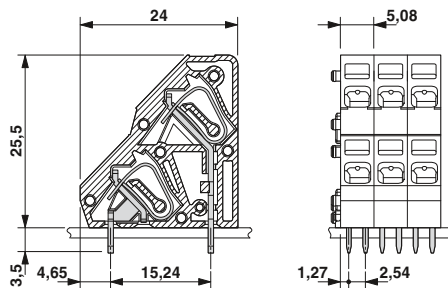

Drilling diagram

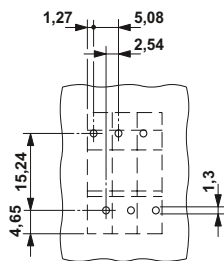

Ordering data

Type	Order No.	Pcs. / Pkt.
5.08 mm pitch, color: green		
ZFKKDS 2,5-5,08	1905023	50
End terminal block, 5.08 mm wide, necessary at the end of a row of terminal blocks (left), if a smooth side element is desired		
ZFKKDS 2,5-5,08 L	1905227	50
End terminal block, 6.08 mm wide, necessary at the end of a row of terminal blocks (right)		
ZFKKDSA 2,5-6,08 R	1905036	50

PCB terminal blocks with 2.54 to 7.62 mm pitch



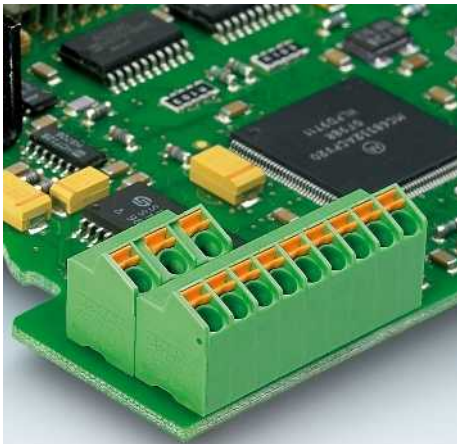

PCB terminal blocks with push-in spring connection for wave soldering processes, currents up to 24 A

Angled conductor connection of up to 1 mm²



- Angled PCB terminal block with 3.5/5.0 mm pitch with integrated touch connection
- Convenient and fast conductor connection using push-in direct plug-in system
- Easy operation when loosening the conductor using an orange actuating lever
- Different pitch dimensions can be combined depending on product range
- Arrangement of several rows for high packing densities possible
- Compact design with only 10 mm constructional depth
- Drilling diagram and dimensions are the same shape as the reliable screw connection SMKDS 1

Notes:
 In order to avoid tolerances between the terminal blocks and PCB, the terminal row should be interrupted when the number of positions exceeds 30.
 1) Please observe the current carrying capacity curves. Further current carrying capacity curves on request.

Accessories		
For all types	Type	Page
	Screwdriver SZS 0,4 x 2,5 Order No. 1205037	
	Ferrules with and without plastic sleeve	834
	Crimping pliers for 0.25 to 6 mm ² CRIMPFIX 6 Order No. 1212034	
Only for SPTA 1/...-3.5		
	Marker cards SK 3,5/2,8	797
Only for SPTA 1/...-5.0		
	Marker cards SK 5/3,8	798

Current carrying capacity curve

Type: SPTA 1 ...3.5
 Test following DIN EN 60512-5-2:2003-01
 Reduction factor = 1
 No. of positions: 5

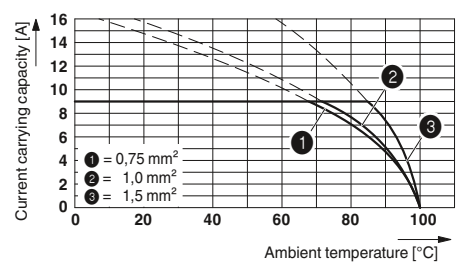

Technical data

Technical data in accordance to IEC / DIN VDE	
Rated current / conductor cross section	[A] / [mm ²]
Rated insulation voltage for pollution degree 2	[V]
Pitch	[mm]
Connection capacity	
Solid / stranded	[mm ²] / [mm ²] / AWG
Stranded with ferrules without plastic sleeve	[mm ²]
Stranded with ferrules with plastic sleeve	[mm ²]
Insulation coordination	
Surge voltage category / pollution degree	
Rated insulation voltage	[V]
Rated surge voltage	[kV]
Approval data (UL/CUL)	Use Group
Nominal voltage	[V]
Nominal current	[A]
Connection capacity AWG	AWG
Approval data (CSA)	Use Group
Nominal voltage	[V]
Nominal current	[A]
Connection capacity AWG	AWG
General data	
Stripping length	[mm]
Type of insulation material / insulation material group	
Inflammability class according to UL 94	
Drill hole diameter / pin dimensions	[mm]

SPTA 1/ ...-3,5			SPTA 1/ ...-5,0		
9 ¹⁾ / 1.5			9 ¹⁾ / 1.5		
200			320		
3.5			5		
0.2 - 1.5 / 0.2 - 1 / 24 - 16			0.2 - 1.5 / 0.2 - 1 / 24 - 16		
0.25 - 0.75			0.25 - 0.75		
0.25 - 0.75			0.25 - 0.75		
III / 3	III / 2	II / 2	III / 3	III / 2	II / 2
160	200	400	250	320	630
2.5	2.5	2.5	4	4	4
B	C	D	B	C	D
150	-	300	150	-	300
10	-	10	10	-	10
26 - 16	-	26 - 16	26 - 16	-	26 - 16
B	C	D	B	C	D
-	-	-	-	-	-
-	-	-	-	-	-
8			8		
PA / I			PA / I		
V0			V0		
1.1 / 0.6 x 1.0 mm			1.1 / 0.6 x 1.0 mm		

No. of pos.	Dim. a [mm]
2	3.50
3	7.00
4	10.50
5	14.00
6	17.50
7	21.00
8	24.50
9	28.00
10	31.50
11	35.00
12	38.50
2	5.00
3	10.00
4	15.00
5	20.00
6	25.00
7	30.00
8	35.00
9	40.00
10	45.00
11	50.00
12	55.00

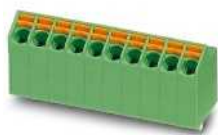

3.5 mm pitch, with 25° angled connection direction and opening lever



5 mm pitch, with 25° angled connection direction and opening lever



Dimensional drawing

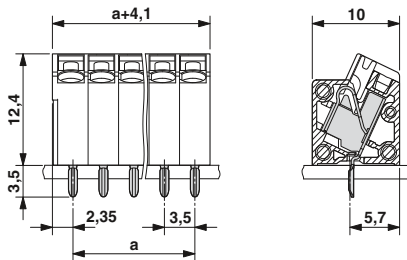

Drilling diagram

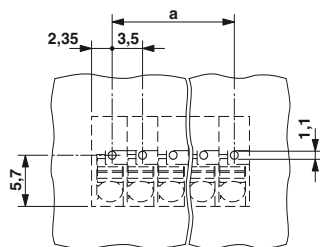

Ordering data

Type	Order No.	Pcs. / Pkt.
3.5 mm pitch, color: green		
SPTA 1/ 2-3,5	1752104	100
SPTA 1/ 3-3,5	1752117	100
SPTA 1/ 4-3,5	1752120	50
SPTA 1/ 5-3,5	1752133	50
SPTA 1/ 6-3,5	1752146	50
SPTA 1/ 7-3,5	1752159	50
SPTA 1/ 8-3,5	1752162	50
SPTA 1/ 9-3,5	1752175	50
SPTA 1/10-3,5	1752188	50
SPTA 1/11-3,5	1752191	50
SPTA 1/12-3,5	1752201	50



Dimensional drawing

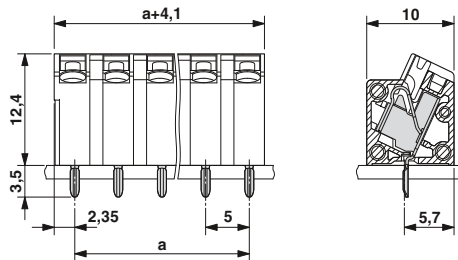

Drilling diagram

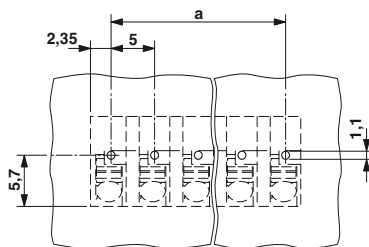

Ordering data

Type	Order No.	Pcs. / Pkt.
5.0 mm pitch, color: green		
SPTA 1/ 2-5,0	1752214	100
SPTA 1/ 3-5,0	1752227	100
SPTA 1/ 4-5,0	1752230	50
SPTA 1/ 5-5,0	1752243	50
SPTA 1/ 6-5,0	1752256	50
SPTA 1/ 7-5,0	1752269	50
SPTA 1/ 8-5,0	1752272	50
SPTA 1/ 9-5,0	1752285	50
SPTA 1/10-5,0	1752298	50
SPTA 1/11-5,0	1752308	50
SPTA 1/12-5,0	1752311	50

PCB terminal blocks with 2.54 to 7.62 mm pitch

PCB terminal blocks with push-in spring connection for wave soldering processes, currents up to 24 A

Angled conductor connection of up to 1.5 mm²





- Angled PCB terminal block with 3.81/5.08 mm pitch with integrated touch connection
- Convenient and fast conductor connection using push-in direct plug-in system
- Easy operation when loosening the conductor using an orange actuating lever
- Different pitch dimensions can be combined depending on product range
- Front pin is a solder pin for additional mechanical stability only, it does not have any electrical properties

Notes:

In order to avoid tolerances between the terminal blocks and PCB, the terminal row should be interrupted when the number of positions exceeds 30.

1) Please observe the current carrying capacity curves. Further current carrying capacity curves on request.

Accessories

For all types	Type	Page
	Screwdriver SZS 0,4 x 2,5 Order No. 1205037	
	Ferrules with and without plastic sleeve	834
	Crimping pliers for 0.25 to 6 mm ² CRIMPFIX 6 Order No. 1212034	
Only for SPTA 1,5/...-3,81		
	Marker cards SK 3,81/2,8	797
Only for SPTA 1,5/...-5,08		
	Marker cards SK 5,08/3,8	798

Current carrying capacity curve

Type: SPTA 1,5 ...3,81
Test following DIN EN 60512-5-2:2003-01
Reduction factor = 0.8
No. of positions: 5

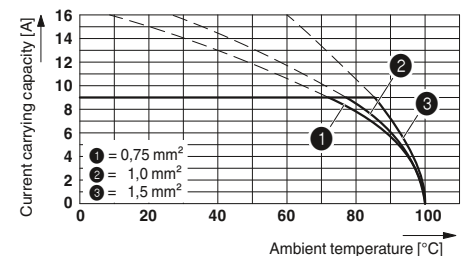

Technical data

Technical data in accordance to IEC / DIN VDE	
Rated current / conductor cross section	[A] / [mm ²]
Rated insulation voltage for pollution degree 2	[V]
Pitch	[mm]
Connection capacity	
Solid / stranded	[mm ²] / [mm ²] / AWG
Stranded with ferrules without plastic sleeve	[mm ²]
Stranded with ferrules with plastic sleeve	[mm ²]
Insulation coordination	
Surge voltage category / pollution degree	
Rated insulation voltage	[V]
Rated surge voltage	[kV]
Approval data (UL/CUL)	Use Group
Nominal voltage	[V]
Nominal current	[A]
Connection capacity AWG	AWG
Approval data (CSA)	Use Group
Nominal voltage	[V]
Nominal current	[A]
Connection capacity AWG	AWG
General data	
Stripping length	[mm]
Type of insulation material / insulation material group	
Inflammability class according to UL 94	
Drill hole diameter / pin dimensions	[mm]

SPTA 1,5/ ...-3,81

9 ¹⁾ / 1.5			9 ¹⁾ / 1.5		
160			320		
3.81			5.08		
0.2 - 1.5 / 0.2 - 1.5 / 24 - 16			0.2 - 1.5 / 0.2 - 1.5 / 24 - 16		
0.25 - 1.5			0.25 - 1.5		
0.25 - 1.5			0.25 - 1.5		
III / 3	III / 2	II / 2	III / 3	III / 2	II / 2
160	160	320	250	320	630
2.5	2.5	2.5	4	4	4
B	C	D	B	C	D
300	-	-	300	-	300
10	-	-	10	-	10
26 - 16	-	-	26 - 16	-	26 - 16
B	C	D	B	C	D
-	-	-	-	-	-
-	-	-	-	-	-
-	-	-	-	-	-
10			10		
PA / I			PA / I		
V0			V0		
1.1 / 0.6 x 1.0 mm			1.1 / 0.6 x 1.0 mm		

SPTA 1,5/ ...-5,08

No. of pos.	Dim. a [mm]
2	3.81
3	7.62
4	11.43
5	15.24
6	19.05
7	22.86
8	26.67
9	30.48
10	34.29
11	38.10
12	41.91
2	5.08
3	10.16
4	15.24
5	20.32
6	25.40
7	30.48
8	35.56
9	40.64
10	45.72
11	50.80
12	55.88

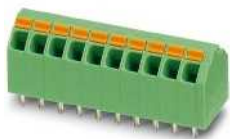

3.81 mm pitch,
with 45° angled connection direction and
opening lever

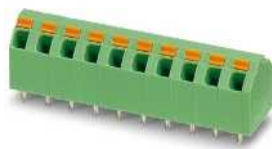

5.08 mm pitch,
with 45° angled connection direction and
opening lever



Dimensional drawing

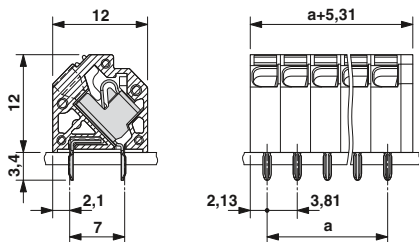

Drilling diagram

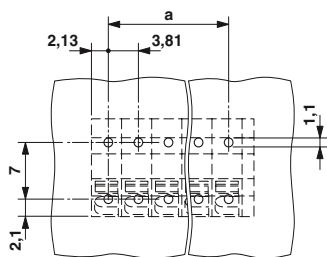

Ordering data

Type	Order No.	Pcs. / Pkt.
Pitch 3.81 mm, color: green		
SPTA 1,5/ 2-3,81	1751477	100
SPTA 1,5/ 3-3,81	1751480	100
SPTA 1,5/ 4-3,81	1751493	50
SPTA 1,5/ 5-3,81	1751503	50
SPTA 1,5/ 6-3,81	1751516	50
SPTA 1,5/ 7-3,81	1743184	50
SPTA 1,5/ 8-3,81	1751529	50
SPTA 1,5/ 9-3,81	1751532	50
SPTA 1,5/10-3,81	1751545	50
SPTA 1,5/11-3,81	1743197	50
SPTA 1,5/12-3,81	1751558	50



Dimensional drawing

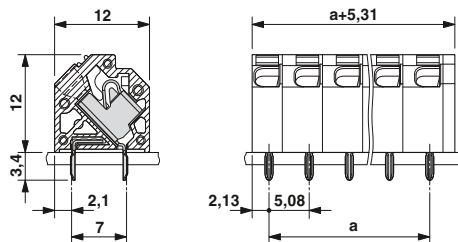

Drilling diagram

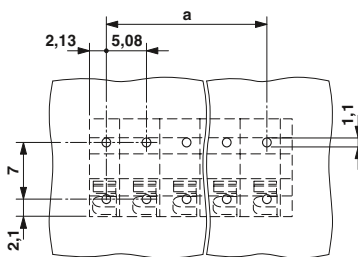

Ordering data

Type	Order No.	Pcs. / Pkt.
5.08 mm pitch, color: green		
SPTA 1,5/ 2-5,08	1751163	100
SPTA 1,5/ 3-5,08	1744442	100
SPTA 1,5/ 4-5,08	1751189	50
SPTA 1,5/ 5-5,08	1751192	50
SPTA 1,5/ 6-5,08	1751202	50
SPTA 1,5/ 7-5,08	1751215	50
SPTA 1,5/ 8-5,08	1751228	50
SPTA 1,5/ 9-5,08	1751231	50
SPTA 1,5/10-5,08	1751244	50
SPTA 1,5/11-5,08	1751257	50
SPTA 1,5/12-5,08	1751464	50

PCB terminal blocks with 2.54 to 7.62 mm pitch

PCB terminal blocks with push-in spring connection for wave soldering processes, currents up to 24 A

Horizontal or vertical conductor connection of up to 2.5 mm²

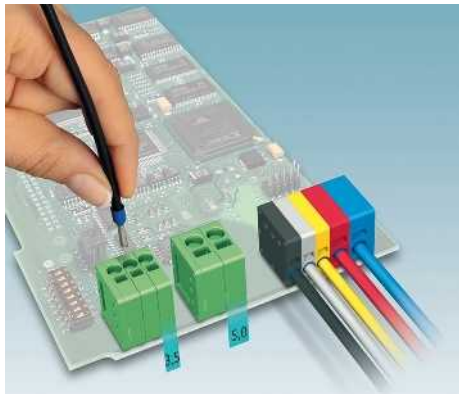

- PCB terminal blocks with front spring connection
- Pitch 3.5 mm
- Double solder pin for high stability on the PCB
- Generously dimensioned connection cross section with a compact 3.5 mm pitch
- Push-in direct plug-in method for solid or stranded conductors with ferrules
- When connecting stranded conductors without ferrules, the terminal point is opened using standard screwdrivers
- Horizontal and vertical types
- Larger numbers of positions on request
- Can be combined with the 5.0 mm pitch

Notes:			
In order to avoid tolerances between the terminal blocks and PCB, the terminal row should be interrupted when the number of positions exceeds 30.			
1) Please observe the current carrying capacity curves. Further current carrying capacity curves on request.			
2) Voltages with pitch spacer			
	III/3	III/2	II/2
With RZ-SPT-2,5-2,5	320 V	400 V	630 V
With RZ-SPT-2,5-5,0	500 V	630 V	800 V

Accessories		
For all types	Type	Page
	Screwdriver SZF 0-0,4 x 2,5 Order No. 1204504	
	Marker cards SK 3,5/2,8	797
	Pitch spacer, width: 2.5 mm RZ-SPT 2,5-2,5 Order No. 1772595	
	Pitch spacer, width: 5 mm RZ-SPT 2,5-5,0 Order No. 1772605	
	Crimping pliers for 0.25 to 6 mm ² CRIMPFOX 6 Order No. 1212034	

Current carrying capacity curve
Type: SPT 1,5/5-3,5-H
Test following DIN EN 60512-5-2:2003-01
Reduction factor = 1
No. of positions: 5

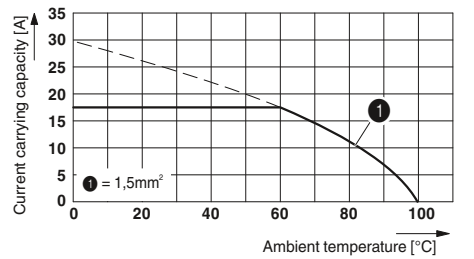

Technical data

Technical data in accordance to IEC / DIN VDE	
Rated current / conductor cross section	[A] / [mm ²]
Rated insulation voltage for pollution degree 2	[V]
Pitch	[mm]
Connection capacity	
Solid / stranded	[mm ²] / [mm ²] / AWG
Stranded with ferrules without plastic sleeve	[mm ²]
Stranded with ferrules with plastic sleeve	[mm ²]
Insulation coordination	
Surge voltage category / pollution degree	
Rated insulation voltage	[V]
Rated surge voltage	[kV]
Approval data (UL/CUL)	Use Group
Nominal voltage	[V]
Nominal current	[A]
Connection capacity AWG	AWG
Approval data (CSA)	Use Group
Nominal voltage	[V]
Nominal current	[A]
Connection capacity AWG	AWG
General data	
Stripping length	[mm]
Type of insulation material / insulation material group	
Inflammability class according to UL 94	
Drill hole diameter / pin dimensions	[mm]

SPT 1,5/ ...-H-3,5			SPT 1,5/ ...-V-3,5		
17.5 ¹⁾ / 1.5			17.5 ¹⁾ / 1.5		
200 ²⁾			200 ²⁾		
3.5			3.5		
0.2 - 1.5 / 0.2 - 1.5 / 24 - 16			0.2 - 1.5 / 0.2 - 1.5 / 24 - 16		
0.25 - 1.5			0.25 - 1.5		
0.25 - 0.75			0.25 - 0.75		
III / 3	III / 2	II / 2	III / 3	III / 2	II / 2
160	200 ²⁾	400	160	200 ²⁾	400
2.5	2.5	2.5	2.5	2.5	2.5
B	C	D	B	C	D
150	-	300	150	-	300
10	-	10	10	-	10
24 - 16	24 - 16	24 - 16	24 - 16	24 - 16	24 - 16
B	C	D	B	C	D
-	-	-	-	-	-
-	-	-	-	-	-
10			10		
PA / I			PA / I		
V0			V0		
1.1 / 0.8 x 0.8 mm			1.1 / 0.8 x 0.8 mm		

No. of pos.	Dim. a [mm]
2	3.50
3	7.00
4	10.50
5	14.00
6	17.50
7	21.00
8	24.50
9	28.00
10	31.50
11	35.00
12	38.50



Connection direction parallel to the PCB



Connection direction vertical to the PCB



Dimensional drawing

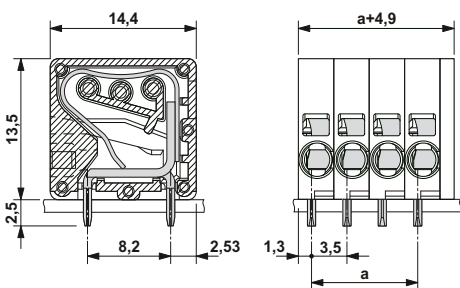

Drilling diagram

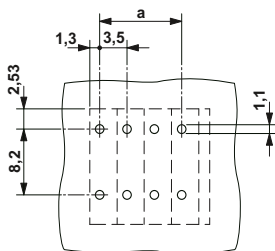

Dimensional drawing

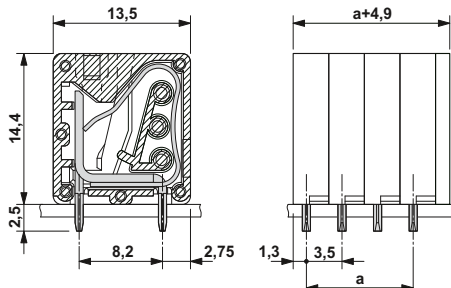

Drilling diagram

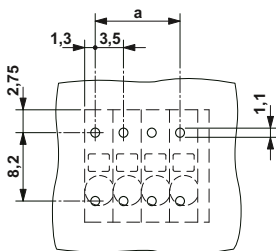

Ordering data

Type	Order No.	Pcs. / Pkt.
3.5 mm pitch, color: green		
SPT 1,5/ 2-H-3,5	1990737	100
SPT 1,5/ 3-H-3,5	1990740	100
SPT 1,5/ 4-H-3,5	1990753	100
SPT 1,5/ 5-H-3,5	1990766	100
SPT 1,5/ 6-H-3,5	1990779	100
SPT 1,5/ 7-H-3,5	1990782	50
SPT 1,5/ 8-H-3,5	1990795	50
SPT 1,5/ 9-H-3,5	1990805	50
SPT 1,5/10-H-3,5	1990818	50
SPT 1,5/11-H-3,5	1990821	50
SPT 1,5/12-H-3,5	1990834	50

Ordering data

Type	Order No.	Pcs. / Pkt.
3.5 mm pitch, color: green		
SPT 1,5/ 2-V-3,5	1990850	100
SPT 1,5/ 3-V-3,5	1990863	100
SPT 1,5/ 4-V-3,5	1990876	100
SPT 1,5/ 5-V-3,5	1990889	100
SPT 1,5/ 6-V-3,5	1990892	100
SPT 1,5/ 7-V-3,5	1990902	50
SPT 1,5/ 8-V-3,5	1990915	50
SPT 1,5/ 9-V-3,5	1990928	50
SPT 1,5/10-V-3,5	1990931	50
SPT 1,5/11-V-3,5	1990944	50
SPT 1,5/12-V-3,5	1990957	50

PCB terminal blocks with 2.54 to 7.62 mm pitch

PCB terminal blocks with push-in spring connection for wave soldering processes, currents up to 24 A

Horizontal or vertical conductor connection of up to 2.5 mm²

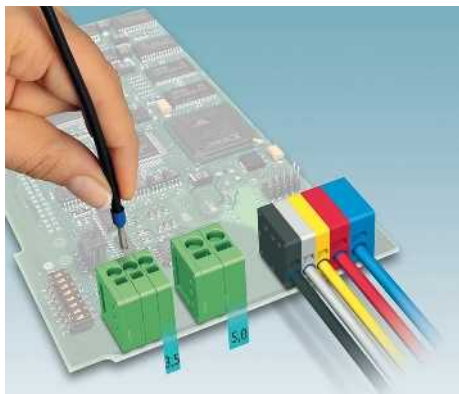

- PCB terminal blocks with front spring connection
- 5.0 mm pitch
- Double solder pin for high stability on the PCB
- Generously dimensioned connection cross section up to 2.5 mm²
- Push-in direct plug-in method for solid or stranded conductors with ferrules
- When connecting stranded conductors without ferrules, the terminal point is opened using standard screwdrivers
- Horizontal and vertical types
- Larger numbers of positions on request
- Can be combined with the 3.5 mm pitch

Notes:			
In order to avoid tolerances between the terminal blocks and PCB, the terminal row should be interrupted when the number of positions exceeds 30.			
1) Please observe the current carrying capacity curves. Further current carrying capacity curves on request.			
2) Voltages with pitch spacer			
	III/3	III/2	II/2
With RZ-SPT-2,5-2,5	400 V	630 V	800 V
With RZ-SPT-2,5-5,0	630 V	800 V	1000 V

Accessories		
For all types	Type	Page
	Screwdriver SZF 1-0,6 x 3,5 Order No. 1204517	
	Marker cards SK 5/3,8	798
	Pitch spacer, width: 2.5 mm RZ-SPT 2,5-2,5 Order No. 1772595	
	Pitch spacer, width: 5 mm RZ-SPT 2,5-5,0 Order No. 1772605	
	Crimping pliers for 0.25 to 6 mm ² CRIMPFOX 6 Order No. 1212034	

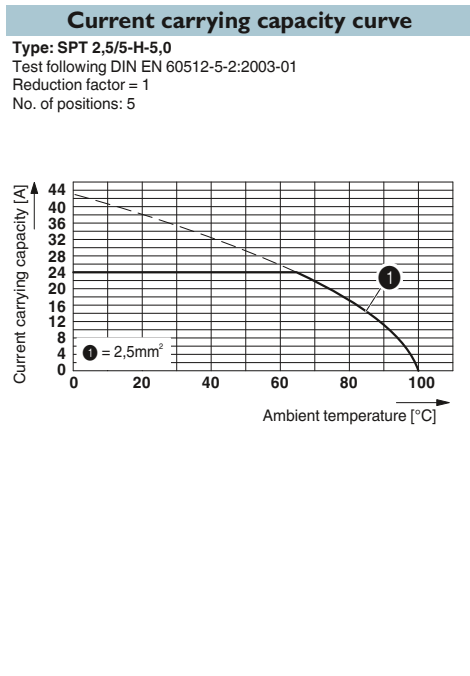

Technical data	
Technical data in accordance to IEC / DIN VDE	
Rated current / conductor cross section	[A] / [mm ²]
Rated insulation voltage for pollution degree 2	[V]
Pitch	[mm]
Solid / stranded	[mm ²] / [mm ²] / AWG
Stranded with ferrules without plastic sleeve	[mm ²]
Stranded with ferrules with plastic sleeve	[mm ²]
Insulation coordination	
Surge voltage category / pollution degree	
Rated insulation voltage	[V]
Rated surge voltage	[kV]
Approval data (UL/CUL)	Use Group
Nominal voltage	[V]
Nominal current	[A]
Connection capacity AWG	AWG
Approval data (CSA)	Use Group
Nominal voltage	[V]
Nominal current	[A]
Connection capacity AWG	AWG
General data	
Stripping length	[mm]
Type of insulation material / insulation material group	
Inflammability class according to UL 94	
Drill hole diameter / pin dimensions	[mm]

SPT 2,5/ ...-H-5,0			SPT 2,5/ ...-V-5,0		
24 ¹⁾ / 4			24 ¹⁾ / 4		
400 ²⁾			400 ²⁾		
5			5		
0.2 - 4 / 0.2 - 2.5 / 24 - 12			0.2 - 4 / 0.2 - 2.5 / 24 - 12		
0.25 - 2.5			0.25 - 2.5		
0.25 - 1.5			0.25 - 1.5		
III / 3	III / 2	II / 2	III / 3	III / 2	II / 2
250	400 ²⁾	630	250	400 ²⁾	630
4	4	4	4	4	4
B	C	D	B	C	D
300	-	300	300	-	300
20	-	10	20	-	10
24 - 12	24 - 12	24 - 12	24 - 12	24 - 12	24 - 12
B	C	D	B	C	D
-	-	-	-	-	-
-	-	-	-	-	-
-	-	-	-	-	-
10			10		
PA / I			PA / I		
V0			V0		
1.1 / 0.8 x 0.8 mm			1.1 / 0.8 x 0.8 mm		

No. of pos.	Dim. a [mm]
2	5.00
3	10.00
4	15.00
5	20.00
6	25.00
7	30.00
8	35.00
9	40.00
10	45.00
11	50.00
12	55.00



Connection direction parallel to the PCB



Connection direction vertical to the PCB



Dimensional drawing

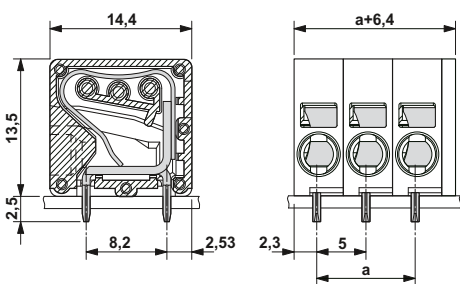

Drilling diagram

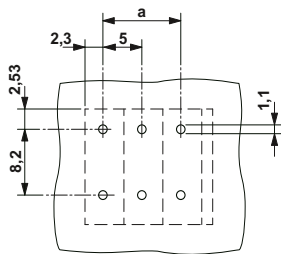

Dimensional drawing

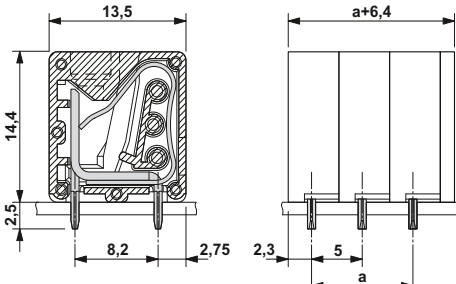

Drilling diagram

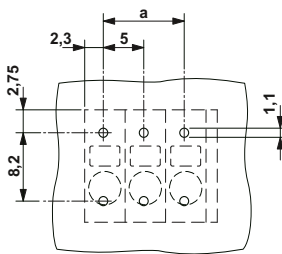

Ordering data

Type	Order No.	Pcs. / Pkt.
5.0 mm pitch, color: green		
SPT 2,5/ 2-H-5,0	1990973	100
SPT 2,5/ 3-H-5,0	1990986	100
SPT 2,5/ 4-H-5,0	1990999	100
SPT 2,5/ 5-H-5,0	1991008	100
SPT 2,5/ 6-H-5,0	1991011	100
SPT 2,5/ 7-H-5,0	1991024	50
SPT 2,5/ 8-H-5,0	1991037	50
SPT 2,5/ 9-H-5,0	1991040	50
SPT 2,5/10-H-5,0	1991053	50
SPT 2,5/11-H-5,0	1991066	50
SPT 2,5/12-H-5,0	1991079	50

Ordering data

Type	Order No.	Pcs. / Pkt.
5.0 mm pitch, color: green		
SPT 2,5/ 2-V-5,0	1991095	100
SPT 2,5/ 3-V-5,0	1991105	100
SPT 2,5/ 4-V-5,0	1991118	100
SPT 2,5/ 5-V-5,0	1991121	100
SPT 2,5/ 6-V-5,0	1991134	100
SPT 2,5/ 7-V-5,0	1991147	50
SPT 2,5/ 8-V-5,0	1991150	50
SPT 2,5/ 9-V-5,0	1991163	50
SPT 2,5/10-V-5,0	1991176	50
SPT 2,5/11-V-5,0	1991189	50
SPT 2,5/12-V-5,0	1991192	50

PCB terminal blocks with 2.54 to 7.62 mm pitch

PCB terminal blocks with push-in spring connection for wave soldering processes, currents up to 24 A

With actuation rocker with a connection cross section of up to 1 mm²



- PCB terminal blocks with front spring connection
- Horizontal and vertical types
- Double solder pin for high stability on the PCB
- Push-in direct plug-in method for solid or stranded conductors with ferrules
- When connecting stranded conductors without ferrules, the terminal point is opened using an orange opening lever.
- Delivery form: position discs in blocks of 10

Notes:
In order to avoid tolerances between the terminal blocks and PCB, the terminal row should be interrupted when the number of positions exceeds 30.
1) Please observe the current carrying capacity curves. Further current carrying capacity curves on request.
2) Only solid conductors

Accessories		
For all types	Type	Page
	Ferrules with and without plastic sleeve	834
	Crimping pliers for 0.25 to 6 mm ² CRIMPFOX 6 Order No. 1212034	
Only for FFKDSA/...-2,54		
	Marker cards SK 2,54/2,8	796
Only for FFKDSA/...-3,81		
	Marker cards SK 3,81/2,8	797

Current carrying capacity curve
 Type: FFKDS/H-2,54
 Test following DIN EN 60512-5-2:2003-01
 Reduction factor = 1
 No. of positions: 5

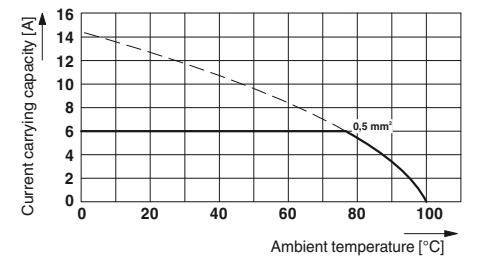

Technical data

Technical data in accordance to IEC / DIN VDE	
Rated current / conductor cross section	[A] / [mm ²]
Rated insulation voltage for pollution degree 2	[V]
Pitch	[mm]
Connection capacity	
Solid / stranded	[mm ²] / [mm ²] / AWG
Stranded with ferrules without plastic sleeve	[mm ²]
Stranded with ferrules with plastic sleeve	[mm ²]
Insulation coordination	
Surge voltage category / pollution degree	
Rated insulation voltage	[V]
Rated surge voltage	[kV]
Approval data (UL/CUL)	Use Group
Nominal voltage	[V]
Nominal current	[A]
Connection capacity AWG	AWG
Approval data (CSA)	Use Group
Nominal voltage	[V]
Nominal current	[A]
Connection capacity AWG	AWG
General data	
Stripping length	[mm]
Type of insulation material / insulation material group	
Inflammability class according to UL 94	
Drill hole diameter / pin dimensions	[mm]

FFKDS/H-2,54			FFKDS/V-2,54			FFKDS/H-3,81		
6 ¹⁾ / 0.5			6 ¹⁾ / 0.5			12 ¹⁾ / 1		
160			160			160		
2.54			2.54			3.81		
0.14 - 0.5 / 0.14 - 0.5 / 26 - 20 ²⁾			0.14 - 0.5 / 0.14 - 0.5 / 26 - 20			0.14 - 1 / 0.14 - 1 / 26 - 18		
-			-			0.25 - 0.34		
-			-			0.25 - 0.34		
III / 3	III / 2	II / 2	III / 3	III / 2	II / 2	III / 3	III / 2	II / 2
63	160	320	63	160	320	160	160	320
2.5	2.5	2.5	2.5	2.5	2.5	2.5	2.5	2.5
B	C	D	B	C	D	B	C	D
150	-	-	150	-	-	300	-	300
6	-	-	6	-	-	6	-	6
26 - 20 ²⁾	-	-	26 - 20 ²⁾	-	-	26 - 16 ²⁾	-	26 - 16 ²⁾
B	C	D	B	C	D	B	C	D
150	-	-	150	-	-	150	-	-
6	-	-	6	-	-	10	-	-
20 ²⁾	-	-	20 ²⁾	-	-	26 - 18 ²⁾	-	-
11			11			10		
PA / I			PA / I			PA / I		
V0			V0			V0		
1.1 / 0.5 x 0.8 mm			1.1 / 0.5 x 0.8 mm			1.3 / 0.5 x 1 mm		

No. of pos.
1
1
1
1
1
1
1



2.54 mm pitch, with opening lever,
conductor connection parallel to the PCB

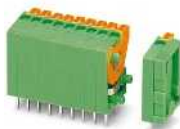

2.54 mm pitch, with opening lever,
conductor connection vertical to the PCB



3.81 mm pitch, with opening lever,
conductor connection parallel to the PCB



Dimensional drawing

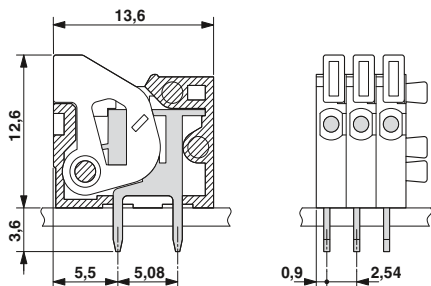

Drilling diagram

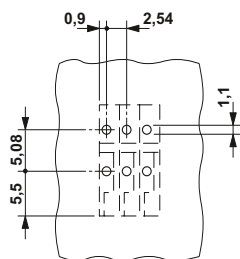

Ordering data

Type	Order No.	Pcs. / Pkt.
Pitch 2.54 mm, color: green		
FFKDS/H-2,54	1791826	250

End terminal block, 5.08 mm wide, necessary at the end of a row of terminal blocks, for horizontal connection

FFKDSA1/H-5,08	1791868	250
----------------	---------	-----



Dimensional drawing

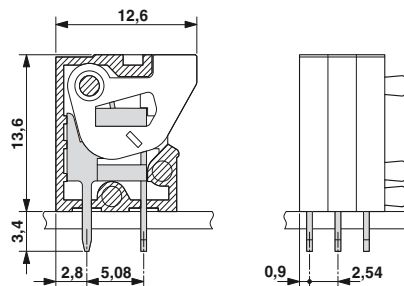

Drilling diagram

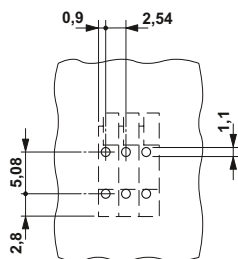

Ordering data

Type	Order No.	Pcs. / Pkt.
Pitch 2.54 mm, color: green		
FFKDS/V-2,54	1791813	250

End terminal block, 5.08 mm wide, necessary at the end of a row of terminal blocks, for vertical connection

FFKDSA1/V-5,08	1791855	250
----------------	---------	-----



Dimensional drawing

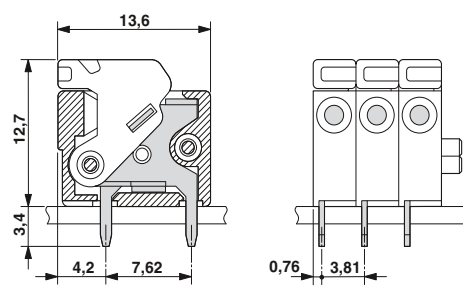

Drilling diagram

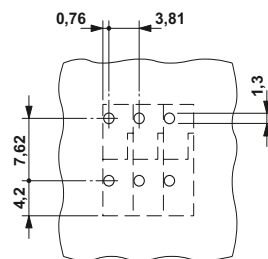

Ordering data

Type	Order No.	Pcs. / Pkt.
Pitch 3.81 mm, color: green		
FFKDS/H-3,81	1789650	100

End terminal block, 6.35 mm wide, necessary at the end of a row of terminal blocks, for horizontal connection

FFKDSA1/H-6,35	1789634	50
----------------	---------	----

PCB terminal blocks with 2.54 to 7.62 mm pitch

PCB terminal blocks with push-in spring connection for wave soldering processes, currents up to 24 A

With actuation rocker with a connection cross section of up to 1.5 mm²

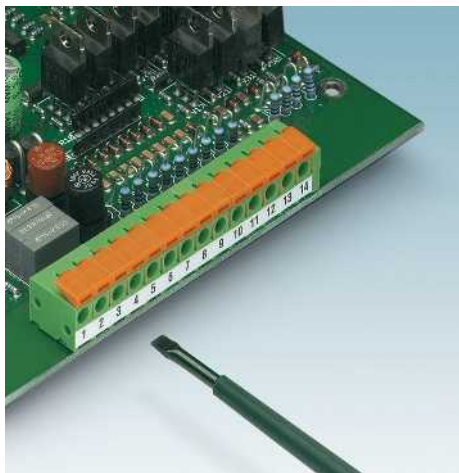

- PCB terminal blocks with front spring connection
- Horizontal and vertical types
- Double solder pin for high stability on the PCB
- Push-in direct plug-in method for solid or stranded conductors with ferrules
- When connecting stranded conductors without ferrules, the terminal point is opened using an orange opening lever.
- Delivery form: position discs in blocks of 10

FFKDS/H1-5,08

- Opening lever for convenient operation using a screwdriver

FFKDS/H2-5,08

- The compact opening lever enables assembly in a housing cutout

Notes:
In order to avoid tolerances between the terminal blocks and PCB, the terminal row should be interrupted when the number of positions exceeds 30.
1) Please observe the current carrying capacity curves. Further current carrying capacity curves on request.
2) Only solid conductors

Accessories		
For all types	Type	Page
	Ferrules with and without plastic sleeve	834
	Crimping pliers for 0.25 to 6 mm ² CRIMPFOX 6 Order No. 1212034	
Only for FFKDSA/...-3,81		
	Marker cards SK 3,81/2,8	797
Only for FFKDSA/...-5,08		
	Marker cards SK 5,08/3,8	798

Current carrying capacity curve

Type: FFKDS/V-3,81
Test following DIN EN 60512-5-2:2003-01
Reduction factor = 1
No. of positions: 5

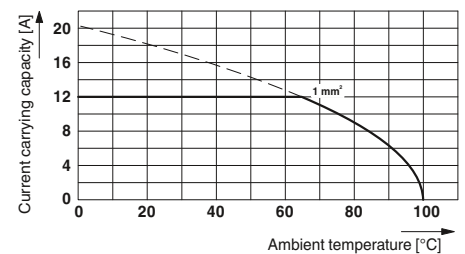

Technical data

Technical data in accordance to IEC / DIN VDE	
Rated current / conductor cross section	[A] / [mm ²]
Rated insulation voltage for pollution degree 2	[V]
Pitch	[mm]
Connection capacity	
Solid / stranded	[mm ²] / [mm ²] / AWG
Stranded with ferrules without plastic sleeve	[mm ²]
Stranded with ferrules with plastic sleeve	[mm ²]
Insulation coordination	
Surge voltage category / pollution degree	
Rated insulation voltage	[V]
Rated surge voltage	[kV]
Approval data (UL/CUL)	Use Group
Nominal voltage	[V]
Nominal current	[A]
Connection capacity AWG	AWG
Approval data (CSA)	Use Group
Nominal voltage	[V]
Nominal current	[A]
Connection capacity AWG	AWG
General data	
Stripping length	[mm]
Type of insulation material / insulation material group	
Inflammability class according to UL 94	
Drill hole diameter / pin dimensions	[mm]

FFKDS/V-3,81			FFKDS/H1-5,08			FFKDS/H2-5,08		
12 ¹⁾ / 1			15 ¹⁾ / 1.5			15 ¹⁾ / 1.5		
160			320			320		
3.81			5.08			5.08		
0.14 - 1 / 0.14 - 1 / 26 - 18			0.2 - 1.5 / 0.2 - 1.5 / 24 - 16			0.2 - 1.5 / 0.2 - 1.5 / 24 - 16		
0.25 - 0.34			0.25 - 0.75			0.25 - 0.75		
0.25 - 0.34			0.25 - 0.75			0.25 - 0.75		
III / 3	III / 2	II / 2	III / 3	III / 2	II / 2	III / 3	III / 2	II / 2
160	160	320	250	320	630	250	320	630
2.5	2.5	2.5	4	4	4	4	4	4
B	C	D	B	C	D	B	C	D
300	-	300	300	-	300	300	-	300
6	-	6	10	-	10	10	-	10
26 - 16	-	26 - 16	22 - 16	-	22 - 16	22 - 16	-	22 - 16
B	C	D	B	C	D	B	C	D
150	-	-	300	-	300	300	-	300
10	-	-	10	-	10	10	-	10
26 - 18 ²⁾	-	-	16 ²⁾	-	16 ²⁾	16 ²⁾	-	16 ²⁾
10			10			10		
PA / I			PA / I			PA / I		
V0			V0			V0		
1.3 / 0.5 x 1 mm			1.3 / 0.5 x 1 mm			1.3 / 0.5 x 1 mm		

No. of pos.	
1	
1	
1	
1	
1	
1	

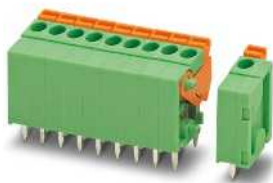

3.81 mm pitch, with opening lever, conductor connection vertical to the PCB

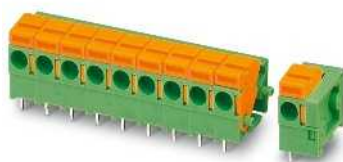

5.08 mm pitch, with opening lever, conductor connection parallel to the PCB

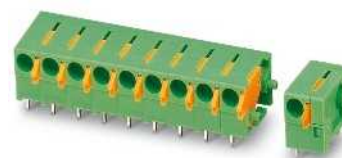

5.08 mm pitch, with shortened opening lever, conductor connection parallel to the PCB



Dimensional drawing

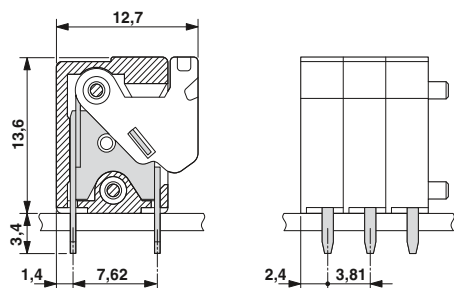

Drilling diagram

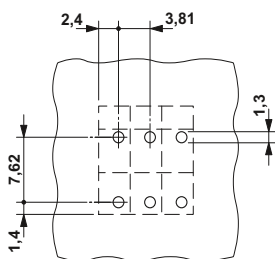

Ordering data

Type	Order No.	Pcs. / Pkt.
Pitch 3.81 mm, color: green		
FFKDS/V-3,81	1789647	100
End terminal block, 6.35 mm wide, necessary at the end of a row of terminal blocks		
FFKDSA1/V-6,35	1789621	50



Dimensional drawing

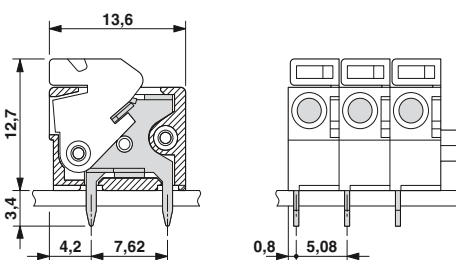

Drilling diagram

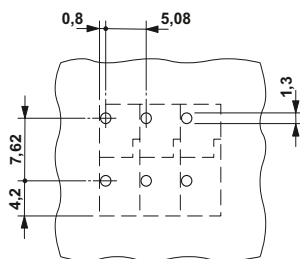

Ordering data

Type	Order No.	Pcs. / Pkt.
5.08 mm pitch, color: green		
FFKDS/H1-5,08	1790335	250
End terminal block, 7.62 mm wide, necessary at the end of a row of terminal blocks		
FFKDSA1/H1-7,62	1790513	250



Dimensional drawing

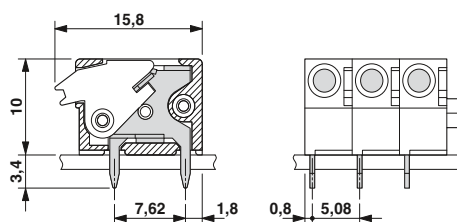

Drilling diagram

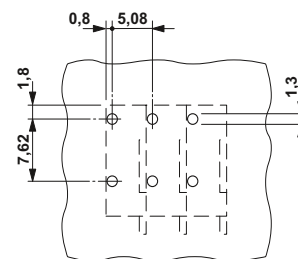

Ordering data

Type	Order No.	Pcs. / Pkt.
5.08 mm pitch, color: green		
FFKDS/H2-5,08	1790461	250
End terminal block, 7.62 mm wide, necessary at the end of a row of terminal blocks, with shortened opening lever		
FFKDSA1/H2-7,62	1790500	250

PCB terminal blocks with 2.54 to 7.62 mm pitch

PCB terminal blocks with push-in spring connection for wave soldering processes, currents up to 24 A

With actuation rocker with a connection cross section of up to 1.5 mm²

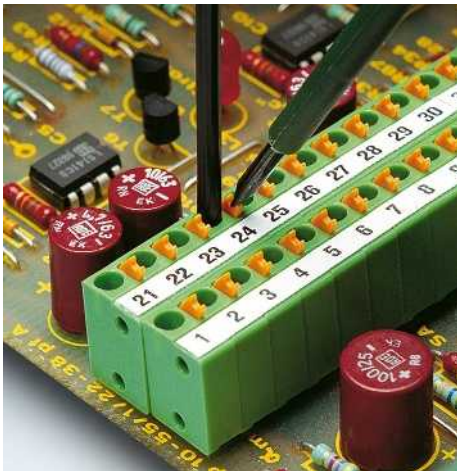

- Double solder pin for high stability on the PCB
- Push-in direct plug-in method for solid or stranded conductors with ferrules
- When connecting stranded conductors without ferrules, the terminal point is opened using an orange opening lever.
- Delivery form: position discs in blocks of 10

FFKDS/V1-5,08 and FFKDS/H1-7,62

- Opening lever for convenient operation using a screwdriver

FFKDS/V2-5,08

- The compact opening lever enables the direct arrangement of several PCB terminal block bases in a row

Notes:

In order to avoid tolerances between the terminal blocks and PCB, the terminal row should be interrupted when the number of positions exceeds 30.

1) Please observe the current carrying capacity curves. Further current carrying capacity curves on request.

2) Only solid conductors.

Accessories

For all types	Type	Page
	Ferrules with and without plastic sleeve	834
	Crimping pliers for 0.25 to 6 mm ² CRIMPFOX 6 Order No. 1212034	
Only for FFKDSA/...-5,08		
	Marker cards SK 5,08/3,8	798
Only for FFKDSA/...-7,62		
	Marker cards SK 7,62/5	800

Current carrying capacity curve

Type: FFKDS/V1-5,08
Test following DIN EN 60512-5-2:2003-01
Reduction factor = 1
No. of positions: 5

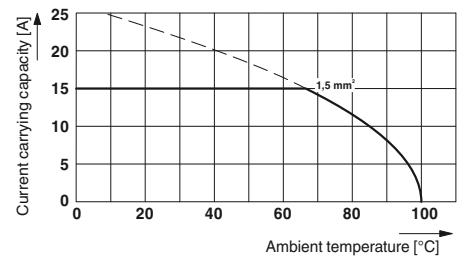

Technical data

Technical data in accordance to IEC / DIN VDE

Rated current / conductor cross section	[A] / [mm ²]
Rated insulation voltage for pollution degree 2	[V]
Pitch	[mm]
Connection capacity	
Solid / stranded	[mm ²] / [mm ²] / AWG
Stranded with ferrules without plastic sleeve	[mm ²]
Stranded with ferrules with plastic sleeve	[mm ²]
Insulation coordination	
Surge voltage category / pollution degree	
Rated insulation voltage	[V]
Rated surge voltage	[kV]
Approval data (UL/CUL)	Use Group
Nominal voltage	[V]
Nominal current	[A]
Connection capacity AWG	AWG
Approval data (CSA)	Use Group
Nominal voltage	[V]
Nominal current	[A]
Connection capacity AWG	AWG
General data	
Stripping length	[mm]
Type of insulation material / insulation material group	
Inflammability class according to UL 94	
Drill hole diameter / pin dimensions	[mm]

FFKDS/V1-5,08

15 ¹⁾ / 1.5		
320		
5.08		
0.2 - 1.5 / 0.2 - 1.5 / 24 - 16		
0.25 - 0.75		
0.25 - 0.75		
III / 3	III / 2	II / 2
320	320	630
4	4	4
B	C	D
300	-	300
10	-	10
22 - 16	-	22 - 16
B	C	D
300	-	300
10	-	10
16 ²⁾	-	16 ²⁾
10		
PA / I		
V0		
1.3 / 0.5 x 1 mm		

FFKDS/V2-5,08

15 ¹⁾ / 1.5		
320		
5.08		
0.2 - 1.5 / 0.2 - 1.5 / 24 - 16		
0.25 - 0.75		
0.25 - 0.75		
III / 3	III / 2	II / 2
320	320	630
4	4	4
B	C	D
300	-	300
10	-	10
22 - 16	-	22 - 16
B	C	D
300	-	300
10	-	10
16 ²⁾	-	16 ²⁾
10		
PA / I		
V0		
1.3 / 0.5 x 1 mm		

FFKDSA/H1-7,62

17.5 ¹⁾ / 1.5		
630		
7.62		
0.2 - 1.5 / 0.2 - 1.5 / 24 - 16		
0.25 - 0.75		
0.25 - 0.75		
III / 3	III / 2	II / 2
400	630	1000
6	6	6
B	C	D
300	-	300
10	-	10
22 - 16	-	22 - 16
B	C	D
300	-	300
10	-	10
16 ²⁾	-	16 ²⁾
10		
PA / I		
V0		
1.3 / 0.5 x 1 mm		

No. of pos.

1

1

1

1

1

1

1

1



5.08 mm pitch, with opening lever, conductor connection vertical to the PCB

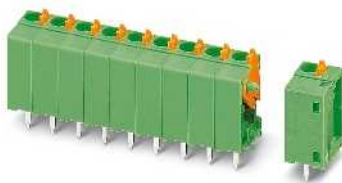

5.08 mm pitch, with shortened opening lever, conductor connection vertical to the PCB

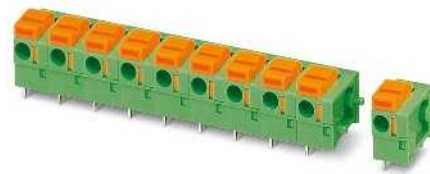

7.62 mm pitch, with opening lever, conductor connection parallel to the PCB



Dimensional drawing

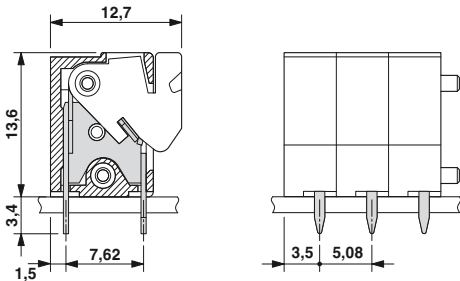

Drilling diagram

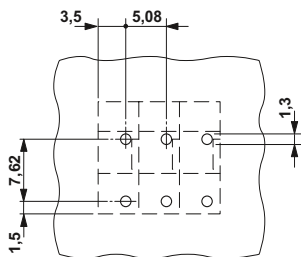

Dimensional drawing

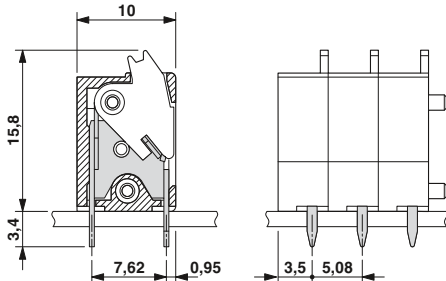

Drilling diagram

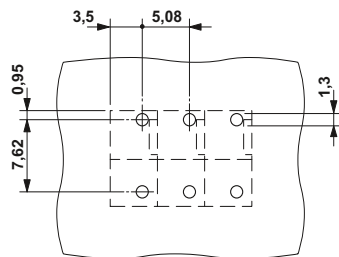

Dimensional drawing

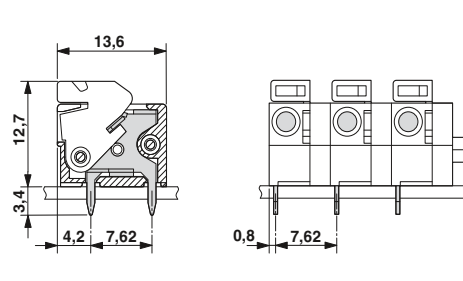

Drilling diagram

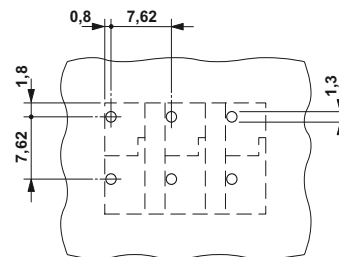

Ordering data

Type	Order No.	Pcs. / Pkt.
5.08 mm pitch, color: green		
FFKDS/V1-5,08	1790319	250
End terminal block, 7.62 mm wide, necessary at the end of a row of terminal blocks		
FFKDSA1/V1-7,62	1790490	250

Ordering data

Type	Order No.	Pcs. / Pkt.
5.08 mm pitch, color: green		
FFKDS/V2-5,08	1790348	250
End terminal block, 7.62 mm wide, necessary at the end of a row of terminal blocks, with shortened opening lever		
FFKDSA1/V2-7,62	1790487	250

Ordering data

Type	Order No.	Pcs. / Pkt.
Pitch 7.62 mm, color: green		
FFKDSA/H1-7,62	1790351	250
End terminal block, 7.62 mm wide, necessary at the end of a row of terminal blocks		
FFKDSA1/H1-7,62	1790513	250

PCB terminal blocks with 2.54 to 7.62 mm pitch

PCB terminal blocks with push-in spring connection for wave soldering processes, currents up to 24 A

With actuation rocker with a connection cross section of up to 1.5 mm²

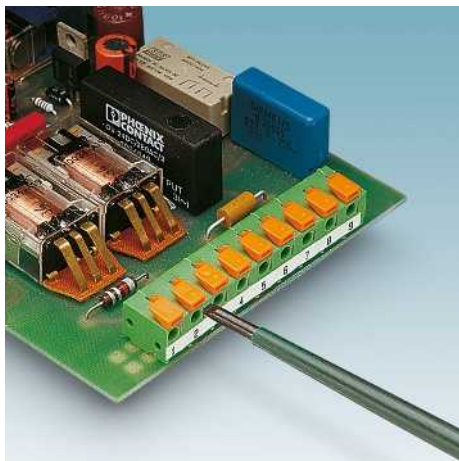

- Double solder pin for high stability on the PCB
- Push-in direct plug-in method for solid or stranded conductors with ferrules
- When connecting stranded conductors without ferrules, the terminal point is opened using an orange opening lever.
- Delivery form: position discs in blocks of 10

FFKDSA/V1-7,62

- Opening lever for convenient operation using a screwdriver

FFKDSA/H2-7,62 and FFKDSA/V2-7,62

- The compact opening lever enables assembly in a housing cutout

Notes:

In order to avoid tolerances between the terminal blocks and PCB, the terminal row should be interrupted when the number of positions exceeds 30.

1) Please observe the current carrying capacity curves. Further current carrying capacity curves on request.

2) Only solid conductors.

Accessories

For all types	Type	Page
	Marker cards SK 7,62/5	800
	Ferrules with and without plastic sleeve	834
	Crimping pliers for 0.25 to 6 mm ² CRIMPFOX 6 Order No. 1212034	

Current carrying capacity curve

Type: FFKDSA/V1-7,62
Test following DIN EN 60512-5-2:2003-01
Reduction factor = 1
No. of positions: 5

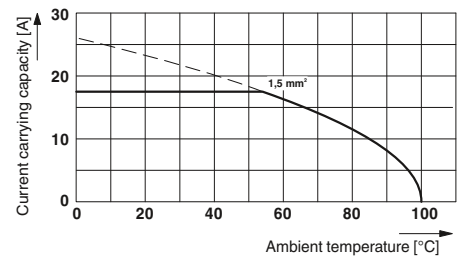

Technical data

Technical data in accordance to IEC / DIN VDE

Rated current / conductor cross section	[A] / [mm ²]
Rated insulation voltage for pollution degree 2	[V]
Pitch	[mm]
Connection capacity	
Solid / stranded	[mm ²] / [mm ²] / AWG
Stranded with ferrules without plastic sleeve	[mm ²]
Stranded with ferrules with plastic sleeve	[mm ²]
Insulation coordination	
Surge voltage category / pollution degree	
Rated insulation voltage	[V]
Rated surge voltage	[kV]
Approval data (UL/CUL)	Use Group
Nominal voltage	[V]
Nominal current	[A]
Connection capacity AWG	AWG
Approval data (CSA)	Use Group
Nominal voltage	[V]
Nominal current	[A]
Connection capacity AWG	AWG
General data	
Stripping length	[mm]
Type of insulation material / insulation material group	
Inflammability class according to UL 94	
Drill hole diameter / pin dimensions	[mm]

FFKDSA/H2-7,62

Rated current / conductor cross section	17.5 ¹⁾ / 1.5
Rated insulation voltage for pollution degree 2	630
Pitch	7.62
Connection capacity	
Solid / stranded	0.2 - 1.5 / 0.2 - 1.5 / 24 - 16
Stranded with ferrules without plastic sleeve	0.25 - 0.75
Stranded with ferrules with plastic sleeve	0.25 - 0.75
Insulation coordination	
Surge voltage category / pollution degree	III / 3 III / 2 II / 2
Rated insulation voltage	400 630 1000
Rated surge voltage	6 6 6
Approval data (UL/CUL)	B C D
Nominal voltage	300 - 300
Nominal current	10 - 10
Connection capacity AWG	22 - 16 - 22 - 16
Approval data (CSA)	B C D
Nominal voltage	300 - 300
Nominal current	10 - 10
Connection capacity AWG	16 ²⁾ - 16 ²⁾
General data	
Stripping length	10
Type of insulation material / insulation material group	PA / I
Inflammability class according to UL 94	V0
Drill hole diameter / pin dimensions	1.3 / 0.5 x 1 mm

FFKDSA/V1-7,62

Rated current / conductor cross section	17.5 ¹⁾ / 1.5
Rated insulation voltage for pollution degree 2	630
Pitch	7.62
Connection capacity	
Solid / stranded	0.2 - 1.5 / 0.2 - 1.5 / 24 - 16
Stranded with ferrules without plastic sleeve	0.25 - 0.75
Stranded with ferrules with plastic sleeve	0.25 - 0.75
Insulation coordination	
Surge voltage category / pollution degree	III / 3 III / 2 II / 2
Rated insulation voltage	500 630 1000
Rated surge voltage	6 6 6
Approval data (UL/CUL)	B C D
Nominal voltage	300 - 300
Nominal current	10 - 10
Connection capacity AWG	22 - 16 - 22 - 16
Approval data (CSA)	B C D
Nominal voltage	300 - 300
Nominal current	10 - 10
Connection capacity AWG	16 ²⁾ - 16 ²⁾
General data	
Stripping length	10
Type of insulation material / insulation material group	PA / I
Inflammability class according to UL 94	V0
Drill hole diameter / pin dimensions	1.3 / 0.5 x 1 mm

FFKDSA/V2-7,62

Rated current / conductor cross section	17.5 ¹⁾ / 1.5
Rated insulation voltage for pollution degree 2	630
Pitch	7.62
Connection capacity	
Solid / stranded	0.2 - 1.5 / 0.2 - 1.5 / 24 - 16
Stranded with ferrules without plastic sleeve	0.25 - 0.75
Stranded with ferrules with plastic sleeve	0.25 - 0.75
Insulation coordination	
Surge voltage category / pollution degree	III / 3 III / 2 II / 2
Rated insulation voltage	500 630 1000
Rated surge voltage	6 6 6
Approval data (UL/CUL)	B C D
Nominal voltage	300 - 300
Nominal current	10 - 10
Connection capacity AWG	22 - 16 - 22 - 16
Approval data (CSA)	B C D
Nominal voltage	300 - 300
Nominal current	10 - 10
Connection capacity AWG	16 ²⁾ - 16 ²⁾
General data	
Stripping length	10
Type of insulation material / insulation material group	PA / I
Inflammability class according to UL 94	V0
Drill hole diameter / pin dimensions	1.3 / 0.5 x 1 mm

No. of pos.

1

1

1

1

1

1

1



7.62 mm pitch, with shortened opening lever, conductor connection parallel to the PCB



7.62 mm pitch, with opening lever, conductor connection vertical to the PCB

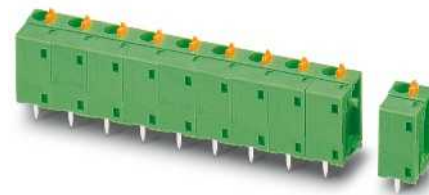

7.62 mm pitch, with shortened opening lever, conductor connection vertical to the PCB



Dimensional drawing

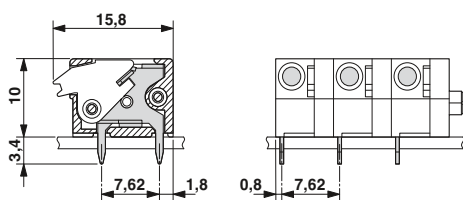

Drilling diagram

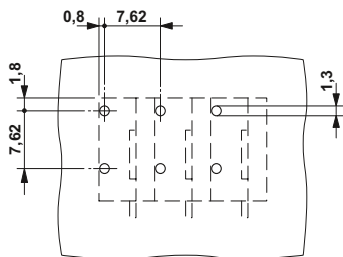

Ordering data

Type	Order No.	Pcs. / Pkt.
Pitch 7.62 mm, color: green		
FFKDSA/H2-7,62	1790458	250

End terminal block, 7.62 mm wide, necessary at the end of a row of terminal blocks, with shortened opening lever

FFKDSA1/H2-7,62	1790500	250
-----------------	---------	-----



Dimensional drawing

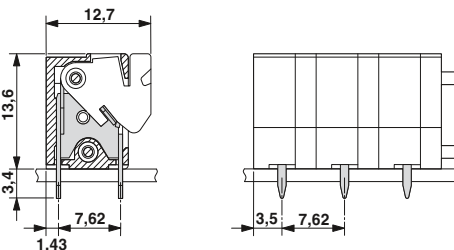

Drilling diagram

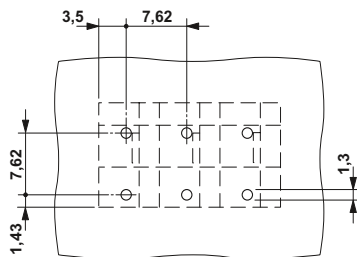

Ordering data

Type	Order No.	Pcs. / Pkt.
Pitch 7.62 mm, color: green		
FFKDSA/V1-7,62	1790364	250

End terminal block, 7.62 mm wide, necessary at the end of a row of terminal blocks

FFKDSA1/V1-7,62	1790490	250
-----------------	---------	-----



Dimensional drawing

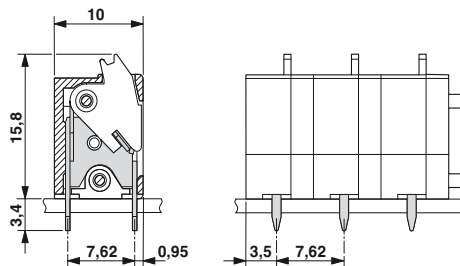

Drilling diagram

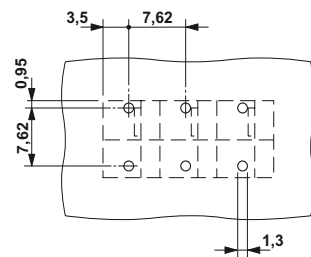

Ordering data

Type	Order No.	Pcs. / Pkt.
Pitch 7.62 mm, color: green		
FFKDSA/V2-7,62	1790377	250

End terminal block, 7.62 mm wide, necessary at the end of a row of terminal blocks, with shortened opening lever

FFKDSA1/V2-7,62	1790487	250
-----------------	---------	-----

PCB terminal blocks with 2.54 to 7.62 mm pitch

PCB terminal blocks with push-in spring connection for wave soldering processes, currents up to 24 A

Connection cross section of up to 2.5 mm²



- Spring-cage PCB terminal block for electronic housing ME/ME MAX
- Push-in technology simplifies connection
- Design version “left” and “right”
- Pitch 5 mm
- Number of positions between 2 and 4

Current carrying capacity curve

Type: FKDSO 2,5/...KMGY

Tested in accordance with DIN EN 60512-5-2:2003-01

Reduction factor = 1

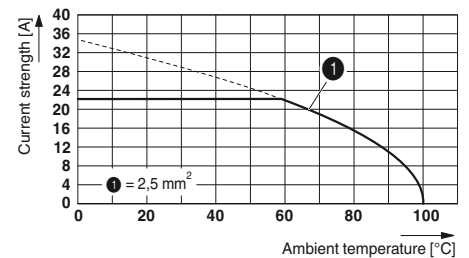

Technical data

Technical data in accordance to IEC / DIN VDE	
Rated current / conductor cross section	[A] / [mm ²]
Rated insulation voltage for pollution degree 2	[V]
Pitch	[mm]
Connection capacity	
Solid / stranded	[mm ²] / [mm ²] / AWG
Stranded with ferrules without plastic sleeve	[mm ²]
Stranded with ferrules with plastic sleeve	[mm ²]
Insulation coordination	
Surge voltage category / pollution degree	
Rated insulation voltage	[V]
Rated surge voltage	[kV]
Approval data (UL/CUL)	Use Group
Nominal voltage	[V]
Nominal current	[A]
Connection capacity AWG	AWG
Approval data (CSA)	Use Group
Nominal voltage	[V]
Nominal current	[A]
Connection capacity AWG	AWG
General data	
Stripping length	[mm]
Type of insulation material / insulation material group	
Inflammability class according to UL 94	
Drill hole diameter / pin dimensions	[mm]

FKDSO 2,5/ ...-L KMGY

22 / 2.5		
250		
5		
0.2 - 2.5 / 0.2 - 2.5 / 24 - 14		
0.25 - 2.5		
0.25 - 2.5		
III / 3	III / 2	II / 2
250	250	250
4	4	4
B	C	D
300	-	300
10	-	5
24 - 14	-	24 - 14
B	C	D
-	-	-
-	-	-
-	-	-
10		
PA / I		
V0		
1.4 / 0.8 x 1.0 mm		

FKDSO 2,5/ ...-R KMGY

22 / 2.5		
250		
5		
0.2 - 2.5 / 0.2 - 2.5 / 24 - 14		
0.25 - 2.5		
0.25 - 2.5		
III / 3	III / 2	II / 2
250	250	250
4	4	4
B	C	D
300	-	300
10	-	5
24 - 14	-	24 - 14
B	C	D
-	-	-
-	-	-
-	-	-
10		
PA / I		
V0		
1.4 / 0.8 x 1.0 mm		

No. of pos.	Dim. a [mm]
2	5.00
3	10.00
4	15.00



With "left" solder pins leading off at a right angle

With "right" solder pins leading off at a right angle



Dimensional drawing

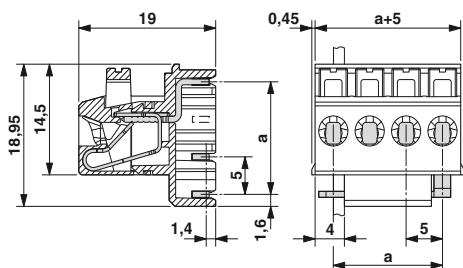

Drilling diagram

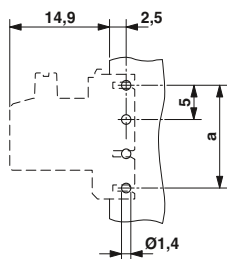

Ordering data

Type	Order No.	Pcs. / Pkt.
Spring-cage PCB terminal block, left, pitch 5 mm, color: light gray		
FKDSO 2,5/ 2-L KMGY	2200315	50
FKDSO 2,5/ 3-L KMGY	2200318	50
FKDSO 2,5/ 4-L KMGY	2200319	50



Dimensional drawing

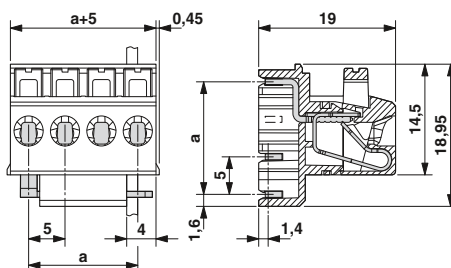

Drilling diagram

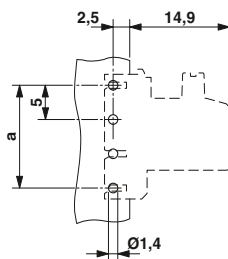

Ordering data

Type	Order No.	Pcs. / Pkt.
Spring-cage PCB terminal block, right, pitch 5 mm, color: light gray		
FKDSO 2,5/ 2-R KMGY	2200316	50
FKDSO 2,5/ 3-R KMGY	2200317	50
FKDSO 2,5/ 4-R KMGY	2200320	50

PCB terminal blocks with 2.54 to 7.62 mm pitch

PCB terminal blocks with displacement connection for wave soldering processes, currents up to 5 A

Connection cross section of up to 0.34 mm²

Notes:
1) Current carrying capacity curve upon request.

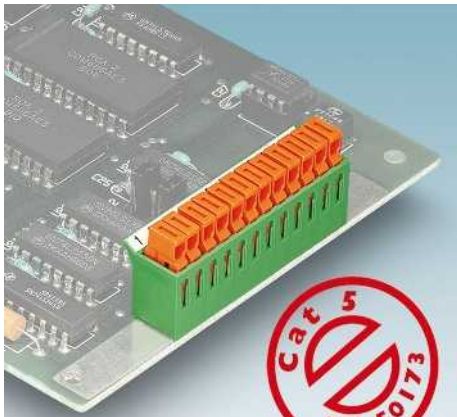

- PCB terminal block with fast insulation displacement connection technology with a 3.81 mm pitch
- Connection of insulated conductor without tools in a short assembly time
- With a cut-off frequency of more than 100 MHz, the IDC range fulfills the quality requirement of CAT 5 in accordance with EN 50173 and ISO/IEC 11801
- The IDC range is suitable for cables with PVC and PE insulation
- You can find user notes and recommendations for IDC technology on page 22

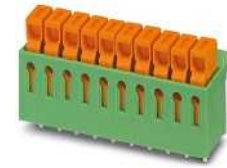

With displacement connection



Dimensional drawing

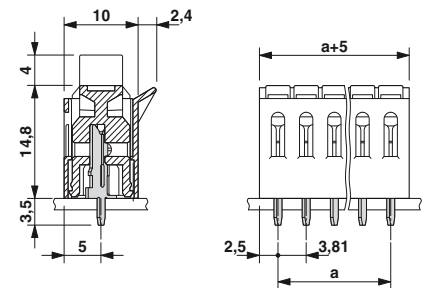

Drilling diagram

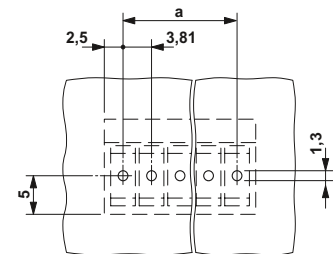

Accessories		
For all types	Type	Page
	Marker cards SK 3,81/2,8	797

Technical data

Technical data in accordance to IEC / DIN VDE	
Rated current / conductor cross section [A] / [mm ²]	5 ¹⁾ / 0.34
Rated insulation voltage for pollution degree 2 [V]	160
Pitch [mm]	3.81
Connection capacity	
Solid / stranded [mm ²] / [mm ²] / AWG	0.13 - 0.34 / 0.22 - 0.34 / 26 - 22
Stranded with ferrules without plastic sleeve [mm ²]	-
Stranded with ferrules with plastic sleeve [mm ²]	-
Insulation coordination	
Surge voltage category / pollution degree	III / 3 III / 2 II / 2
Rated insulation voltage [V]	160 160 320
Rated surge voltage [kV]	2.5 2.5 2.5
Approval data (UL/CUL) Use Group	B C D
Nominal voltage [V]	250 - 300
Nominal current [A]	5 - 5
Connection capacity AWG	28 - 22 - 28 - 22
Approval data (CSA) Use Group	B C D
Nominal voltage [V]	300 - 300
Nominal current [A]	5 - 5
Connection capacity AWG	28 - 22 - 28 - 22
General data	
Type of insulation material / insulation material group	PA / I
Inflammability class according to UL 94	V0
Drill hole diameter / pin dimensions [mm]	1.3 / 1 x 0.4 mm

Ordering data

Type	Order No.	Pcs. / Pkt.
2 3.81	1706170	50
3 7.62	1706183	50
4 11.43	1706196	50
5 15.24	1706206	50
6 19.05	1706219	50
7 22.86	1706222	50
8 26.67	1706235	50
9 30.48	1706248	50
10 34.29	1706251	50
11 38.10	1706264	50
12 41.91	1706277	50

PCB terminal blocks with 2.54 to 7.62 mm pitch

PCB terminal blocks with screw connection for the Ex area for wave soldering process

Multi-level terminal blocks with a connection cross section of up to 1.5 mm²

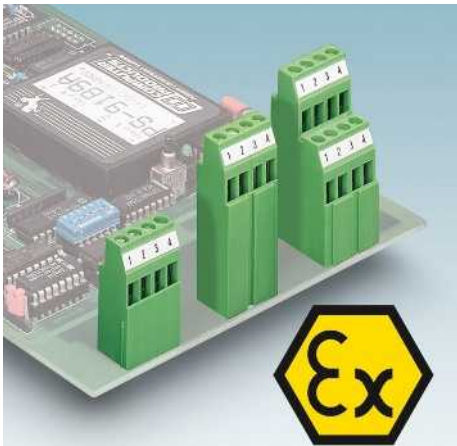

– High housing design suitable for potting

MKKDSH 3/...

– Single-row type, back level of the double-level PCB terminal block



MK3DSH 3/...

– Single-row type, back level of the three-level PCB terminal block

MK3DSMH 3/...

– Double-row type, middle, and back level of the three-level PCB terminal block
 – Other user notes and installation instructions for PCB terminal blocks in the EX area can be found at www.phoenixcontact.net/products and on the page 40

Accessories

For all types	Type	Page
	Screwdriver SZS 0,6 x 3,5 Order No. 1205053	
	Marker cards SK 5/3,8 or SK 5,08/3,8	798
	Single cover for individual terminal positions EA-MKDS Order No. 1711408	

Technical data

Ex e terminal blocks as per EN/IEC 60079-0 and EN/IEC 60079-7	
Ex marking	ATEX-RL / IEC60079-0
Examination certificate	
IECEX certificate	
Rated voltage	[V]
Rated current	[A] / [2.5 mm ²]
Connection capacity	
Solid / stranded	[mm ²]
Solid / stranded	AWG
General data	
Stripping length	[mm]
Screw thread	
Tightening torque	[Nm]
Type of insulation material / insulation material group	
Inflammability class according to UL 94	
Drill hole diameter / pin dimensions	[mm]

MKKDSH 3/ ...-EX

0344  II 2G / Ex e II
KEMA 01ATEX2130 U
IECEX KEM 07.0019 U
176
20
0.2 - 4 / 0.2 - 2.5
24 - 12 / 24 - 14
7
M3
0.5 - 0.6
PA / I
V0
1.3 / 0.9 x 0.9 mm

MK3DSH 3/ ...-5,08-EX

0344  II 2G / Ex e II
KEMA 01ATEX2130 U
IECEX KEM 07.0019 U
176
20
0.2 - 4 / 0.2 - 2.5
24 - 12 / 24 - 14
7
M3
0.5 - 0.6
PA / I
V0
1.3 / 0.9 x 0.9 mm

MK3DSMH 3/ ...-5,08-EX

0344  II 2G / Ex e II
KEMA 01ATEX2130 U
IECEX KEM 07.0019 U
176
19
0.2 - 4 / 0.2 - 2.5
24 - 12 / 24 - 14
7
M3
0.5 - 0.6
PA / I
V0
1.3 / 0.9 x 0.9 mm

No. of pos.	Dim. a [mm]
2	5.00
3	10.00
2	5.08
3	10.16



31.5 mm high PCB terminal block



44.8 mm high PCB terminal block



44.8 mm high double-level PCB terminal block with offset levels

Ex:

Dimensional drawing

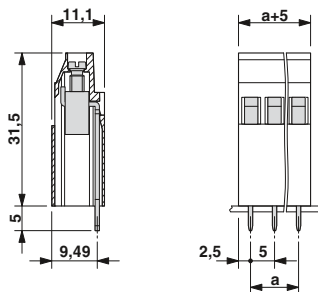

Drilling diagram

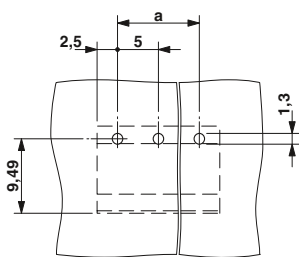

Ordering data

Type	Order No.	Pcs. / Pkt.
5.0 mm pitch, color: green		
MKKDSH 3/ 2-EX	1869790	50
MKKDSH 3/ 3-EX	1869800	50

Ex:

Dimensional drawing

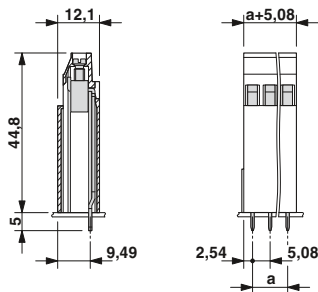

Drilling diagram

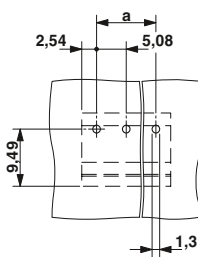

Ordering data

Type	Order No.	Pcs. / Pkt.
5.08 mm pitch, color: green		
MK3DSH 3/ 2-5,08-EX	1869774	50
MK3DSH 3/ 3-5,08-EX	1869787	50

Ex:

Dimensional drawing

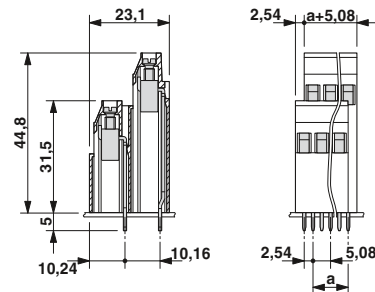

Drilling diagram

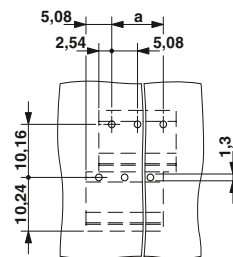

Ordering data

Type	Order No.	Pcs. / Pkt.
5.08 mm pitch, color: green		
MK3DSMH 3/ 2-5,08-EX	1870255	50
MK3DSMH 3/ 3-5,08-EX	1870268	50

PCB terminal blocks with 2.54 to 7.62 mm pitch

PCB terminal blocks with screw connection for the Ex area for wave soldering process

Horizontal or vertical conductor connection of up to 2.5 mm²



- Conductor connection in the front
- Horizontal and vertical types
- Double solder pin for high stability on the PCB
- Pin spacing of 5 mm and 10 mm
- Delivery form: position discs in blocks of 10, cover not included
- Voltage can be increased using pitch spacers
- Other user notes and installation instructions for PCB terminal blocks in the EX area can be found at www.phoenixcontact.net/products and on page 40

Notes:

- 1) 275 V with an inserted RZ 2,5-FRONT 2,5...-EX pitch spacer.
440 V with two inserted RZ 2,5-FRONT 2,5...-EX pitch spacers.



Horizontal connection direction,
5 mm pin spacing



Accessories

For all types	Type	Page
	Screwdriver SZS 0,3 x 3,0 Order No. 1207404	
For FRONT 2,5-H/SA...EX		
	Cover D-FRONT 2,5 H O.Z. Order No. 1700024	
	Pitch spacer, width: 2.5 mm RZ 2,5-FRONT 2,5 H- EX Order No. 1701269	
For FRONT 2,5-V/SA...EX		
	Cover D-FRONT 2,5 V O.Z. Order No. 1700011	
	Pitch spacer, width: 2.5 mm RZ 2,5-FRONT 2,5 V-EX Order No. 1700794	

Dimensional drawing

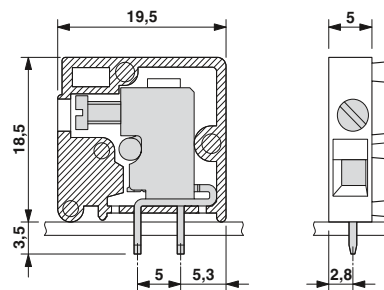

Drilling diagram

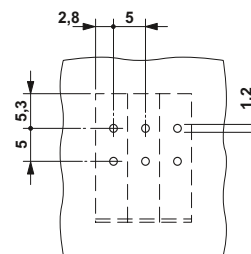

Technical data

Ex e terminal blocks as per EN/IEC 60079-0 and EN/IEC 60079-7	
Ex marking	ATEX-RL / IEC60079-0
Examination certificate	
IECEX certificate	
Rated voltage	[V]
Rated current	[A] / [2.5 mm ²]
Connection capacity	
Solid / stranded	[mm ²]
Solid / stranded	AWG
General data	
Stripping length	[mm]
Screw thread	
Tightening torque	[Nm]
Type of insulation material / insulation material group	
Inflammability class according to UL 94	
Drill hole diameter / pin dimensions	[mm]

0344 Ex II 2G / Ex e II
KEMA 00ATEX2053 U
IECEX KEM 07.0023 U
176 ¹⁾
20
0.2 - 2.5 / 0.2 - 2.5
24 - 14 / 24 - 14
9
M2,5
0.4 - 0.5
PA / I
V0
1.2 / 0.8 x 0.8 mm

No. of pos.

1

Ordering data

Type	Order No.	Pcs. / Pkt.
5.0 mm pitch, color: green		
FRONT 2,5-H/SA 5-EX	1701159	50



Horizontal connection direction,
10 mm pin spacing



Vertical connection direction,
5 mm pin spacing



Vertical connection direction,
10 mm pin spacing



Dimensional drawing

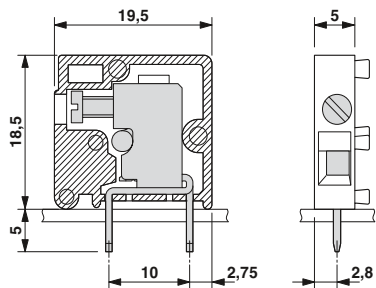

Drilling diagram

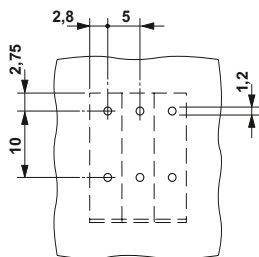

Ordering data

Type	Order No.	Pcs. / Pkt.
5.0 mm pitch, color: green FRONT 2,5-H/SA10-EX	1700325	50



Dimensional drawing

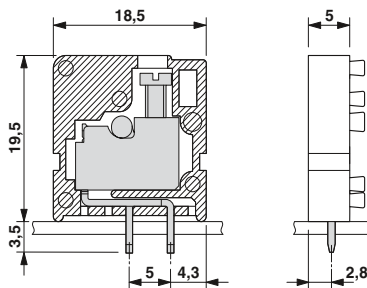

Drilling diagram

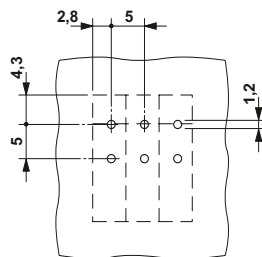

Ordering data

Type	Order No.	Pcs. / Pkt.
5.0 mm pitch, color: green FRONT 2,5-V/SA 5-EX	1701162	50



Dimensional drawing

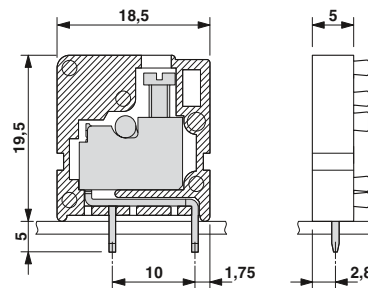

Drilling diagram

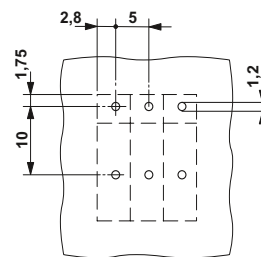

Ordering data

Type	Order No.	Pcs. / Pkt.
5.0 mm pitch, color: green FRONT 2,5-V/SA10-EX	1700309	50

PCB terminal blocks with 2.54 to 7.62 mm pitch

PCB terminal blocks with spring connection for the Ex area for wave soldering processes

Angled conductor connection of up to 2.5 mm²







- Single terminal block with spring-cage connection
- Compact housing dimensions
- Double solder pin for high stability on the PCB
- A plate-type design enables blocking for larger number of positions
- Desk shape with a clear delimitation of the conductor entry and the actuation opening (screwdriver shaft)
- Delivery form: position discs in blocks of 10, end terminal block not included
- Other user notes and installation instructions for PCB terminal blocks in the EX area can be found at www.phoenixcontact.net/products and on the page 40

Notes:

1) 275 V with an inserted RZ-ZFKDS 2,5 pitch spacer, order no. 1931039.

Accessories

For all types	Type	Page
	Screwdriver SZF 1-0,6 x 3,5 Order No. 1204517	
Only for ZFKDS 1,5C-5,0-EX		
	Marker cards SK 5/3,8	798
Only for ZFKDS 2,5-5,08-EX		
	Pitch spacer, width: 2.54 mm RZ-ZFKDS 2,5 Order No. 1931039	
	Marker cards SK 5,08/3,8	798

Technical data

Ex e terminal blocks as per EN/IEC 60079-0 and EN/IEC 60079-7	
Ex marking	ATEX-RL / IEC60079-0
Examination certificate	
IECEX certificate	
Rated voltage	[V]
Rated current	[A] / [2.5 mm ²]
Connection capacity	
Solid / stranded	[mm ²]
Solid / stranded	AWG
General data	
Stripping length	[mm]
Screw thread	
Tightening torque	[Nm]
Type of insulation material / insulation material group	
Inflammability class according to UL 94	
Drill hole diameter / pin dimensions	[mm]

ZFKDS 1,5C-5,0-EX

0344  II 2G / Ex e II
PTB 06ATEX1073 U
IECEX PTB 06.0096.U
176
16
0.2 - 2.5 / 0.2 - 1.5
24 - 14 / 24 - 16
7
-
-
PA / I
V0
1.1 / 0.7 x 0.7

ZFKDS 2,5-5,08-EX

0344  II 2G / Ex e II
PTB 06ATEX1073 U
IECEX PTB 06.0096.U
137 ¹⁾
22
0.2 - 4 / 0.2 - 2.5
24 - 14 / 24 - 16
7
-
-
PA / I
V0
1.3 / 0.8 x 0.8

No. of pos.

1
1
1
1
1

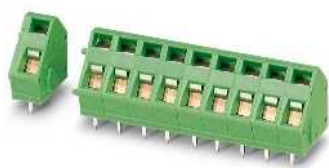

1.5 mm² connection cross section, compact design

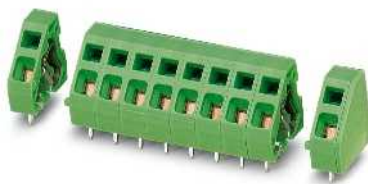

2.5 mm² connection cross section

Ex:

Dimensional drawing

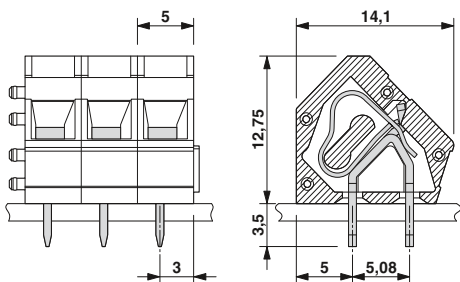

Drilling diagram

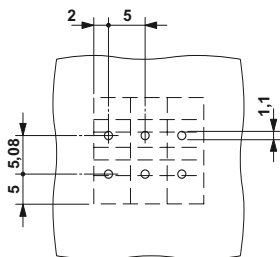

Ordering data

Type	Order No.	Pcs. / Pkt.
5.0 mm pitch, color: green		
ZFKDS 1,5C-5,0-EX	1732111	50
End terminal, 6.4 mm wide, necessary at the end of a row of terminal blocks		
ZFKDSA 1,5C-6,0-EX	1732124	50

Ex:

Dimensional drawing

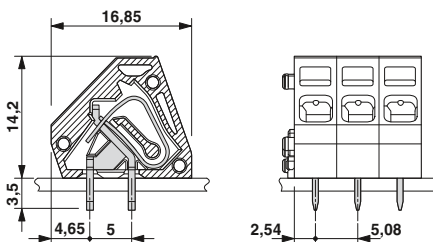

Drilling diagram

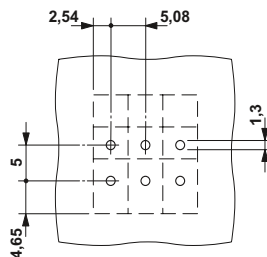

Ordering data

Type	Order No.	Pcs. / Pkt.
5.08 mm pitch, color: green		
ZFKDS 2,5-5,08-EX	1732137	50
End terminal block, 5.08 mm wide, necessary at the end of a row of terminal blocks (left), if a smooth side element is desired		
ZFKDS 2,5-5,08 L-EX	1732140	50
End terminal block, 6.08 mm wide, necessary at the end of a row of terminal blocks (right)		
ZFKDSA 2,5-6,08 R-EX	1732153	50

PCB terminal blocks with 2.54 to 7.62 mm pitch

PCB terminal blocks with spring connection for the Ex area for wave soldering processes

Horizontal or vertical conductor connection of up to 2.5 mm²



- Front push-in spring-cage connection
- Horizontal and vertical types
- Double solder pin for high stability on the PCB
- Push-in direct plug-in method for solid and stranded conductors with ferrules
- The terminal point must be opened using a standard screwdriver for the connection of a stranded conductor without ferrule
- Voltage can be increased using pitch spacers
- Other user notes and installation instructions for PCB terminal blocks in the EX area can be found at www.phoenixcontact.net/products and on the page 40

Notes:

The following ferrules can be used for these PCB terminal blocks:
 3201275 AI 0,5-10WH
 3201288 AI 0,75-10GY
 3200182 AI 1-10RD
 3200195 AI 1,5-10BK
 3202533 AI 2,5-10BU

1) 275 V with an inserted RZ-SPT 2,5-2,5 pitch spacer.
 440 V with an inserted RZ-SPT 2,5-5,0 pitch spacer.

Accessories

For all types	Type	Page
	Screwdriver SZF 1-0,6 x 3,5 Order No. 1204517	
	Marker cards SK 5/3,8	798
	Pitch spacer, width: 2.5 mm RZ-SPT 2,5-2,5 Order No. 1772595	
	Pitch spacer, width: 5 mm RZ-SPT 2,5-5,0 Order No. 1772605	
	Crimping pliers for 0.25 to 6 mm ² CRIMPFOX 6 Order No. 1212034	

Technical data

Ex e terminal blocks as per EN/IEC 60079-0 and EN/IEC 60079-7	
Ex marking	ATEX-RL / IEC60079-0
Examination certificate	
IECEX certificate	
Rated voltage	[V]
Rated current	[A] / [2.5 mm ²]
Connection capacity	
Solid / stranded	[mm ²]
Solid / stranded	AWG
General data	
Stripping length	[mm]
Screw thread	
Tightening torque	[Nm]
Type of insulation material / insulation material group	
Inflammability class according to UL 94	
Drill hole diameter / pin dimensions	[mm]

SPT 2,5/ ...-H-5,0-EX

0344  II 2G / Ex e II
KEMA 07ATEX0193 U
IECEX KEM 07.0057 U
176 ¹⁾
23
0.2 - 4 / 0.2 - 2.5
24 - 14 / 24 - 12
10
-
-
PA / I
V0
1.1 / 0.8 x 0.8

SPT 2,5/ ...-V-5,0-EX

0344  II 2G / Ex e II
KEMA 07ATEX0193 U
IECEX KEM 07.0057 U
176 ¹⁾
23
0.2 - 4 / 0.2 - 2.5
24 - 14 / 24 - 12
10
-
-
PA / I
V0
1.1 / 0.8 x 0.8

No. of pos.	Dim. a [mm]
2	5.00
3	10.00
4	15.00
5	20.00
6	25.00
7	30.00
8	35.00
9	40.00
10	45.00
11	50.00
12	55.00



Connection direction parallel to the PCB

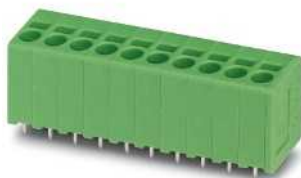

Connection direction vertical to the PCB

Ex:

Dimensional drawing

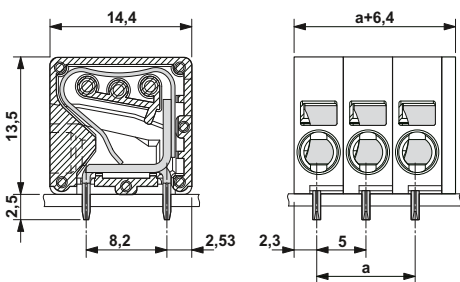

Drilling diagram

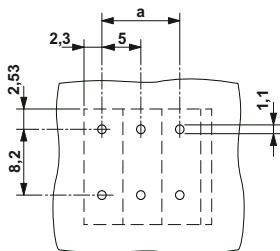

Ex:

Dimensional drawing

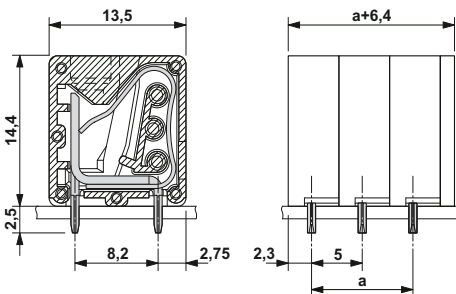

Drilling diagram

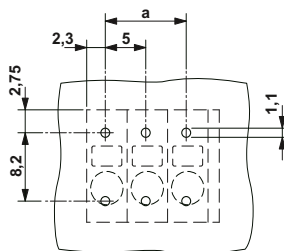

Ordering data

Type	Order No.	Pcs. / Pkt.
5.0 mm pitch, color: green		
SPT 2,5/ 2-H-5,0-EX	1732386	50
SPT 2,5/ 3-H-5,0-EX	1732399	50
SPT 2,5/ 4-H-5,0-EX	1732409	50
SPT 2,5/ 5-H-5,0-EX	1732412	50
SPT 2,5/ 6-H-5,0-EX	1732425	50
SPT 2,5/ 7-H-5,0-EX	1732438	50
SPT 2,5/ 8-H-5,0-EX	1732441	50
SPT 2,5/ 9-H-5,0-EX	1732454	50
SPT 2,5/10-H-5,0-EX	1732467	50
SPT 2,5/11-H-5,0-EX	1732470	50
SPT 2,5/12-H-5,0-EX	1732483	50

Ordering data

Type	Order No.	Pcs. / Pkt.
5.0 mm pitch, color: green		
SPT 2,5/ 2-V-5,0-EX	1732496	50
SPT 2,5/ 3-V-5,0-EX	1732506	50
SPT 2,5/ 4-V-5,0-EX	1732519	50
SPT 2,5/ 5-V-5,0-EX	1732522	50
SPT 2,5/ 6-V-5,0-EX	1732535	50
SPT 2,5/ 7-V-5,0-EX	1732548	50
SPT 2,5/ 8-V-5,0-EX	1732551	50
SPT 2,5/ 9-V-5,0-EX	1732564	50
SPT 2,5/10-V-5,0-EX	1732577	50
SPT 2,5/11-V-5,0-EX	1732580	50
SPT 2,5/12-V-5,0-EX	1732593	50

PCB terminal blocks with 2.54 to 7.62 mm pitch

Printed circuit disconnect plugs / flat-type fuse holder

PCB isolating connectors



- Easy circuit disconnection using removable isolating connectors
- A special snap-lock fitting ensures a tight fit of the slide even when the disconnect point is open
- Can be used as an individual element or in combination with PCB terminal blocks with a 5.08 mm pitch
- Operation of the isolating connector with the help of a TZ connector extraction tool offered as an accessory or a screwdriver



PCB disconnect plugs

Accessories

For all types	Type	Page
	Test plug MPS	831
	Reducing plug RPS Order No. 0201647	831
	TZ plug extraction tool as pullout aid for the discon- nect slide TZ Order No. 0306704	

Dimensional drawing

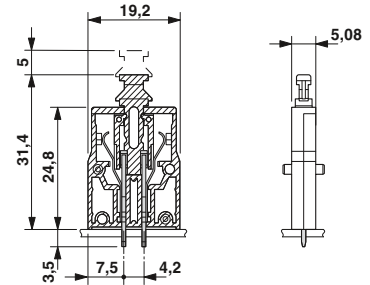

Drilling diagram

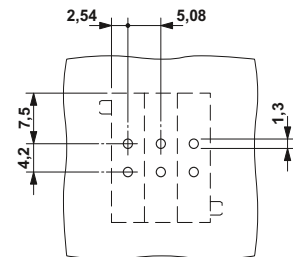

Technical data

Technical data in accordance to IEC / DIN VDE				
Rated current / conductor cross section	[A] / [mm ²]	12 / 0		
Rated insulation voltage for pollution degree 2	[V]	320		
Pitch	[mm]	5.08		
Multi-conductor connection capacity (two conductors with the same cross section)				
Insulation coordination				
Surge voltage category / pollution degree		III / 3	III / 2	II / 2
Rated insulation voltage	[V]	250	320	400
Rated surge voltage	[kV]	4	4	4
Approval data (UL/CUL)	Use Group	B	C	D
Nominal voltage	[V]	-	-	-
Nominal current	[A]	-	-	-
Connection capacity AWG	AWG	-	-	-
Approval data (CSA)	Use Group	B	C	D
Nominal voltage	[V]	-	-	-
Nominal current	[A]	-	-	-
Connection capacity AWG	AWG	-	-	-
General data				
Type of insulation material / insulation material group		PA / I		
Inflammability class according to UL 94		V0		
Drill hole diameter / pin dimensions	[mm]	1.3 / 0.8 x 0.9 mm		

No. of pos.

1

Ordering data

Type	Order No.	Pcs. / Pkt.
5.08 mm pitch, color: green		
PTS-5,08	1876521	50

Flat-type fuse holders

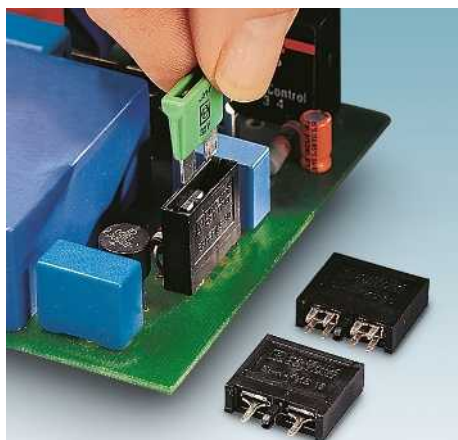

- Fuse holders for flat-type fuses with a maximum nominal voltage of 32 V
- With SNAP IN foot for safe pre-assembly on the PCB

SI-H-FKS 15

- For fuses with a nominal current of 2 to 15 A

SI-H-FKS 30

- For fuses with a nominal current of 2 to 30 A

Notes:
 In accordance with DIN EN 61984, COMBICON plug-in connectors have no switching power. During designated use, they must not be plugged in or disconnected when carrying voltage or under load.
 For dimensional drawing and drilling diagram for SI-H-FKS 30, visit www.phoenixcontact.net/products.



PCB fuse carrier for 5 mm wide automotive flat-type fuses



Dimensional drawing

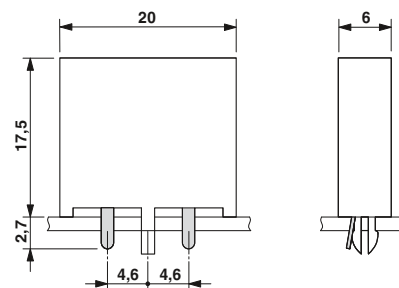

Drilling diagram

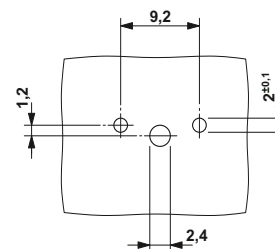

Technical data

Technical data in accordance to IEC / DIN VDE		
Rated current / conductor cross section	[A] / [mm ²]	- / 0
Rated insulation voltage for pollution degree 2	[V]	-
Pitch	[mm]	0
Insulation coordination		
Surge voltage category / pollution degree		III / 3 III / 2 II / 2
Rated insulation voltage	[V]	
Rated surge voltage	[kV]	
General data		
Type of insulation material / insulation material group		- / -
Inflammability class according to UL 94		-

Ordering data

No. of pos.	Type	Order No.	Pcs. / Pkt.
1	Printed circuit fuse carrier, for 5 mm wide automotive flat-type fuses up to max. 15 A SI-H-FKS 15	1728996	50
1	Printed circuit fuse carrier, for 5 mm wide automotive flat-type fuses up to max. 30 A SI-H-FKS 30	1727528	50
	Flat-type fuse inserts, (max. 32 V) acc. to ISO/DIS 8820/2 DIN 72 581-3		
	SI FORM C 2 A	0913689	50
	SI FORM C 4 A DIN 72581	0913731	50
	SI FORM C 5 A DIN 72581	0913692	50
	SI FORM C 7,5 A DIN 72581	0913702	50
	SI FORM C 10 A DIN 72581	0913715	50
	SI FORM C 15 A DIN 72581	0913676	50
	SI FORM C 20 A DIN 72581	0913744	50
	SI FORM C 25 A DIN 72581	0913757	50
	SI FORM C 30 A DIN 72581	0913760	50

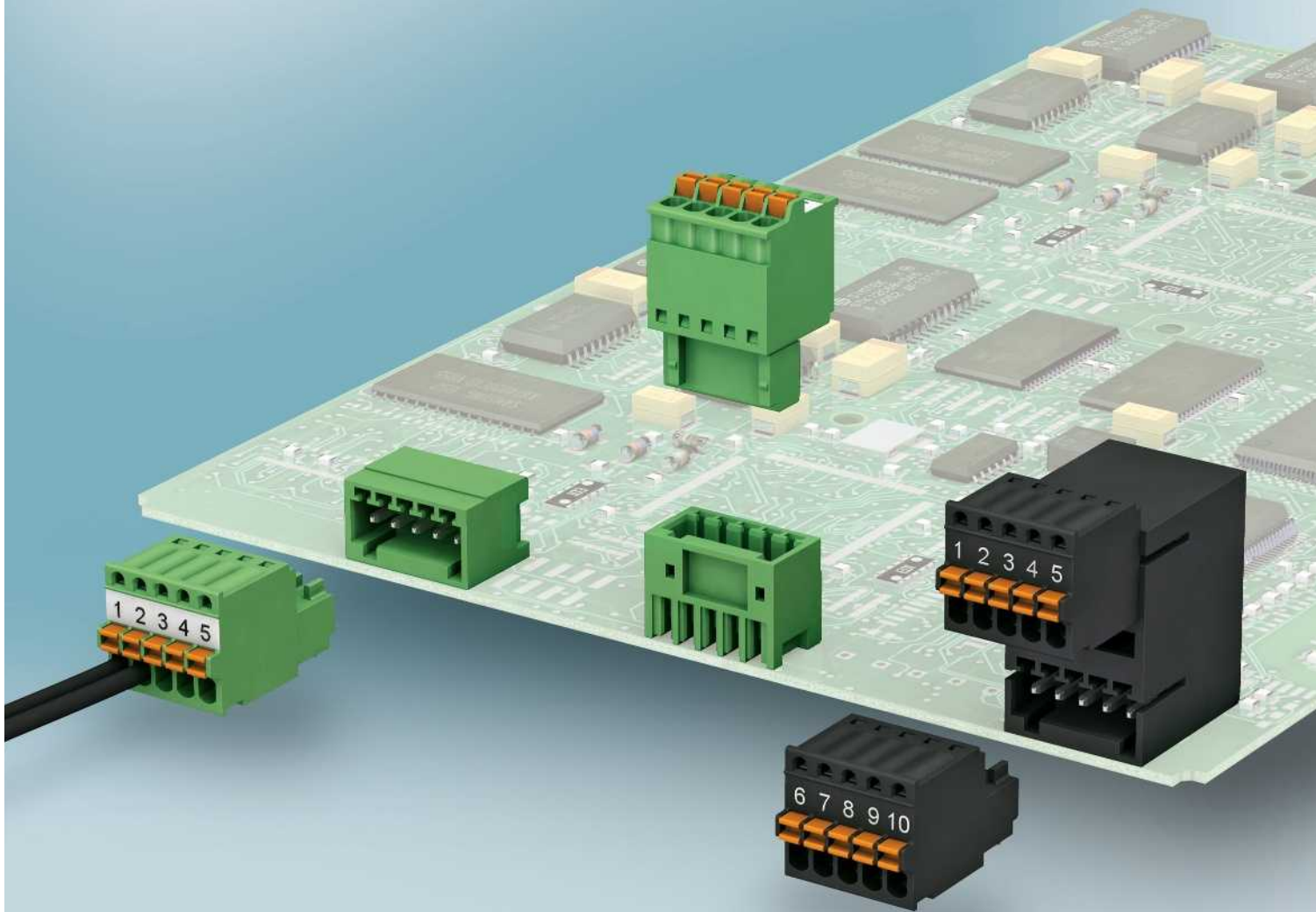

Plug-in connector systems with 2.5 and 2.54 mm pitch

The plug-in connectors in the COMBICON Micro series offer maximum packing density on the PCB or on the front of the device.

Convenient conductor connection is ensured by the push-in spring connection up to 0.5 mm² with orange spring lever.

The plug-in connectors are available with 2.5/2.54 mm micro pitch.

Single and double-level headers for the SMT process and wave soldering are available on the PCB side.

High-temperature-resistant headers with 2.54 mm pitch are supplied in tape-on-reel packing for automated SMT processes.

In addition, the FMC 0,5/MC 0,5 plug-in connector system offers the advantage of a gold-plated contact system.

MICRO-COMBICON plug-in connectors, 2.5 mm pitch up to 4 A	168
Plugs with push-in spring connection	168
Headers for reflow processes	170
Headers for wave soldering processes	172
MICRO COMBICON plug-in connectors, 2.54 mm pitch up to 6 A	174
Plugs with push-in spring connection	174
Headers for reflow/SMD processes	176

Micro plug-in connectors with 2.5 mm and 2.54 mm pitch

MICRO COMBICON plug-in connectors, 2.5 mm pitch up to 4 A

Single-level header for reflow processes

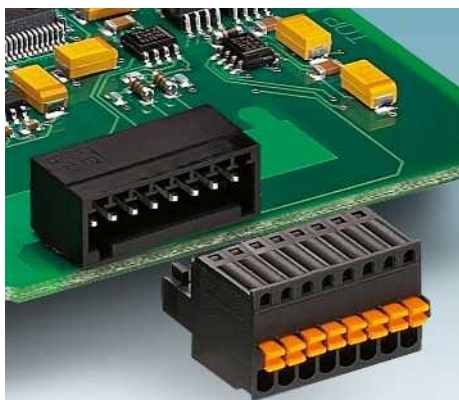

- Application in SMT reflow processes
- Low-profile THR headers with a compact MICRO pitch of 2.5 mm
- Delivery form: Box packaging; bulk for small series
- Delivery form: Taped packaging in accordance with IEC 60286-3 for automatic assembly
- Coil diameter 330 mm, tape width 44 mm
- Alternative pin lengths 1.4 mm or 2.6 mm on request
- Can be combined with FK-MC 0 plug
- You can find user notes and recommendations for THR procedure on page 27

Notes:

In accordance with DIN EN 61984, COMBICON plug-in connectors have no switching power. During designated use, they must not be plugged in or disconnected when carrying voltage or under load.



The CP-MC 0,5 coding profile may only be used after reflow soldering.

Pick and place pads for taped THR articles usually protrude beyond the components. The PCB layout must ensure that collisions are avoided when components are assembled. Dimensional drawings of tape reels and place pads can be found online at www.phoenixcontact.net/products.

COMBICON select

Possible combinations for plug-in connectors can be found in COMBICON select at www.phoenixcontact.net/products.

Accessories

For all types	Type	Page
	Coding profile CP-MC 0,5 Order No. 1881435	38
	Marker cards SK 2,5/4/2,8	796



Box-packaged headers, plug-in direction parallel to the PCB



Dimensional drawing

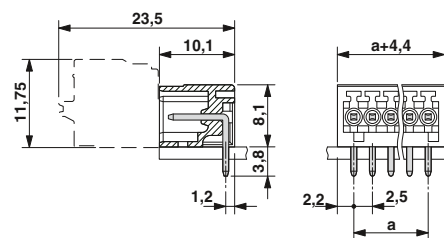

Drilling diagram

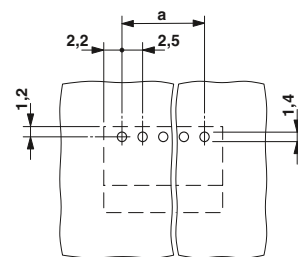

Technical data

Technical data in accordance to IEC / DIN VDE	
Rated current	[A] 4
Rated insulation voltage for pollution degree 2	[V] 160
Pitch	[mm] 2.5
Insulation coordination	
Surge voltage category / pollution degree	III / 3 III / 2 II / 2
Rated insulation voltage	[V] 32 160 160
Rated surge voltage	[kV] 1.5 2.5 2.5
Approval data (UL/CUL)	Use Group B C D
Nominal voltage	[V] 125 - -
Nominal current	[A] 4 - -
Connection capacity AWG	AWG - - -
Approval data (CSA)	Use Group B C D
Nominal voltage	[V] - - -
Nominal current	[A] - - -
Connection capacity AWG	AWG - - -
General data	
Type of insulation material / insulation material group	PA / IIIa
Inflammability class according to UL 94	V0
Drill hole diameter / pin dimensions	[mm] 1.4 / 0,8 x 0,8 mm

Ordering data

No. of pos.	Dim. a [mm]	Type	Order No.	Pcs. / Pkt.
2.5 mm pitch, color: black				
2	2.50	MC 0,5/ 2-G-2,5 THT	1963421	50
3	5.00	MC 0,5/ 3-G-2,5 THT	1963434	50
4	7.50	MC 0,5/ 4-G-2,5 THT	1963447	50
5	10.00	MC 0,5/ 5-G-2,5 THT	1963450	50
6	12.50	MC 0,5/ 6-G-2,5 THT	1963463	50
7	15.00	MC 0,5/ 7-G-2,5 THT	1963476	50
8	17.50	MC 0,5/ 8-G-2,5 THT	1939303	50
9	20.00	MC 0,5/ 9-G-2,5 THT	1963492	50
10	22.50	MC 0,5/10-G-2,5 THT	1963502	50
11	25.00	MC 0,5/11-G-2,5 THT	1963515	50
12	27.50	MC 0,5/12-G-2,5 THT	1939316	50

Micro plug-in connectors with 2.5 mm and 2.54 mm pitch

MICRO COMBICON plug-in connectors, 2.5 mm pitch up to 4 A



Box-packaged headers,
plug-in direction vertical to the PCB



Taped headers,
plug-in direction parallel to the PCB



Taped headers,
plug-in direction vertical to the PCB



Dimensional drawing

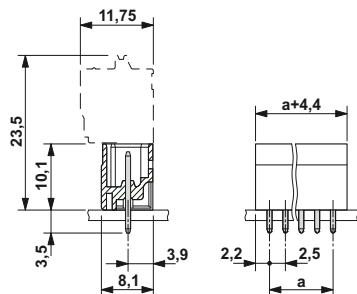

Drilling diagram

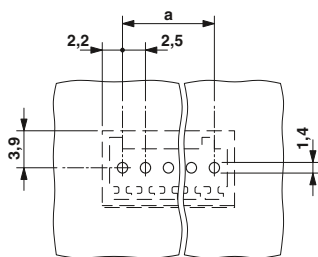

Ordering data

Type	Order No.	Pcs. / Pkt.
2.5 mm pitch, color: black		
MCV 0,5/ 2-G-2,5 THT	1963531	50
MCV 0,5/ 3-G-2,5 THT	1963544	50
MCV 0,5/ 4-G-2,5 THT	1963557	50
MCV 0,5/ 5-G-2,5 THT	1963560	50
MCV 0,5/ 6-G-2,5 THT	1963573	50
MCV 0,5/ 7-G-2,5 THT	1963586	50
MCV 0,5/ 8-G-2,5 THT	1963599	50
MCV 0,5/ 9-G-2,5 THT	1963609	50
MCV 0,5/10-G-2,5 THT	1963612	50
MCV 0,5/11-G-2,5 THT	1963625	50
MCV 0,5/12-G-2,5 THT	1963638	50



Dimensional drawing

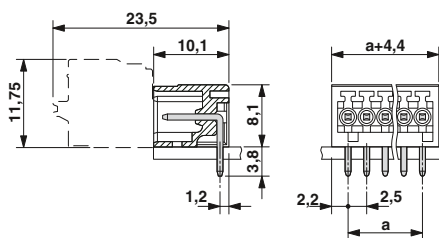

Drilling diagram

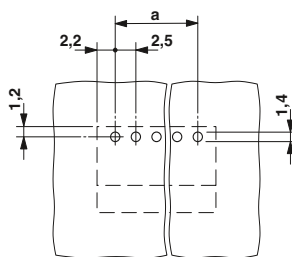

Ordering data

Type	Order No.	Pcs. / Pkt.
2.5 mm pitch, color: black		
MC 0,5/ 2-G-2,5 THT R44	1963641	330
MC 0,5/ 3-G-2,5 THT R44	1963654	330
MC 0,5/ 4-G-2,5 THT R44	1963667	330
MC 0,5/ 5-G-2,5 THT R44	1963670	330
MC 0,5/ 6-G-2,5 THT R44	1963683	330
MC 0,5/ 7-G-2,5 THT R44	1963696	330
MC 0,5/ 8-G-2,5 THT R44	1963706	330
MC 0,5/ 9-G-2,5 THT R44	1963719	330
MC 0,5/10-G-2,5 THT R44	1963722	330
MC 0,5/11-G-2,5 THT R44	1963735	330
MC 0,5/12-G-2,5 THT R44	1963748	330



Dimensional drawing

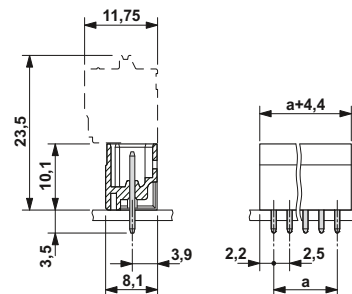

Drilling diagram

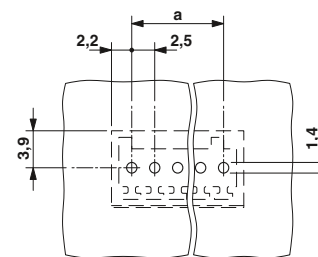

Ordering data

Type	Order No.	Pcs. / Pkt.
2.5 mm pitch, color: black		
MCV 0,5/ 2-G-2,5 THT R44	1963751	220
MCV 0,5/ 3-G-2,5 THT R44	1963764	220
MCV 0,5/ 4-G-2,5 THT R44	1963777	220
MCV 0,5/ 5-G-2,5 THT R44	1963780	220
MCV 0,5/ 6-G-2,5 THT R44	1963793	220
MCV 0,5/ 7-G-2,5 THT R44	1963803	220
MCV 0,5/ 8-G-2,5 THT R44	1963816	220
MCV 0,5/ 9-G-2,5 THT R44	1963829	220
MCV 0,5/10-G-2,5 THT R44	1963845	220
MCV 0,5/11-G-2,5 THT R44	1963858	220
MCV 0,5/12-G-2,5 THT R44	1963861	220

Micro plug-in connectors with 2.5 mm and 2.54 mm pitch

MICRO COMBICON plug-in connectors, 2.5 mm pitch up to 4 A

Single and double-level headers for wave soldering processes

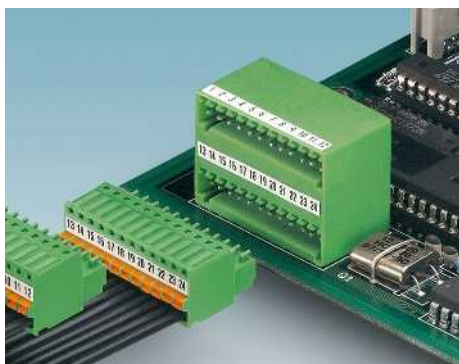

– Can be combined with FK-MC 0,5 plug

MC(V) 0,5/...G

- Low-profile headers with a compact MICRO pitch of 2.5 mm
- Plug-in direction parallel and vertical to the PCB
- Individual position encoding by inserting the coding profiles

MCD(V) 0,5/...-G1

- Low-profile double-level headers with high contact density
- Plug-in direction parallel and vertical to the PCB
- Without a level offset, for flush installation in the front of the devices

Notes:

In accordance with DIN EN 61984, COMBICON plug-in connectors have no switching power. During designated use, they must not be plugged in or disconnected when carrying voltage or under load.

COMBICON select

Possible combinations for plug-in connectors can be found in COMBICON select at www.phoenixcontact.net/products.



Single-level header, plug-in direction parallel to the PCB



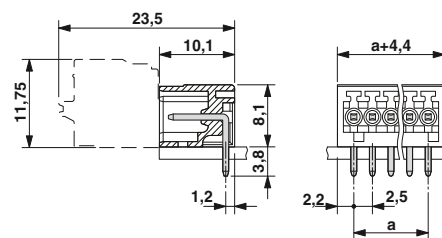

Dimensional drawing

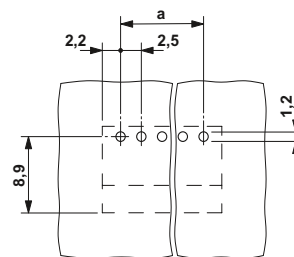

Drilling diagram



Accessories		
For all types	Type	Page
	Coding profile CP-MC 0,5 Order No. 1881435	38
	Marker cards SK 2,54/2,8	796

Technical data

Technical data in accordance to IEC / DIN VDE

Rated current	[A]	4
Rated insulation voltage for pollution degree 2	[V]	160
Pitch	[mm]	2.5
Insulation coordination		
Surge voltage category / pollution degree		III / 3 III / 2 II / 2
Rated insulation voltage	[V]	80 160 320
Rated surge voltage	[kV]	1.5 2.5 2.5
Approval data (UL/CUL)	Use Group	B C D
Nominal voltage	[V]	125 - -
Nominal current	[A]	4 - -
Connection capacity AWG	AWG	- - -
Approval data (CSA)	Use Group	B C D
Nominal voltage	[V]	- - -
Nominal current	[A]	- - -
Connection capacity AWG	AWG	- - -
General data		
Type of insulation material / insulation material group		PA / I
Inflammability class according to UL 94		V0
Drill hole diameter / pin dimensions	[mm]	1.2 / 0,8 x 0,8 mm

Ordering data

No. of pos.	Dim. a [mm]	Type	Order No.	Pcs. / Pkt.
Pitch 2.5 mm, color: green				
2	2.50	MC 0,5/ 2-G-2,5	1881448	50
3	5.00	MC 0,5/ 3-G-2,5	1881451	50
4	7.50	MC 0,5/ 4-G-2,5	1881464	50
5	10.00	MC 0,5/ 5-G-2,5	1881477	50
6	12.50	MC 0,5/ 6-G-2,5	1881480	50
7	15.00	MC 0,5/ 7-G-2,5	1881493	50
8	17.50	MC 0,5/ 8-G-2,5	1881503	50
9	20.00	MC 0,5/ 9-G-2,5	1881516	50
10	22.50	MC 0,5/10-G-2,5	1881529	50
11	25.00	MC 0,5/11-G-2,5	1881532	50
12	27.50	MC 0,5/12-G-2,5	1881545	50



Single-level header,
plug-in direction vertical to the PCB



Double-level headers,
plug-in direction parallel to the PCB



Double-level headers,
plug-in direction vertical to the PCB



Dimensional drawing

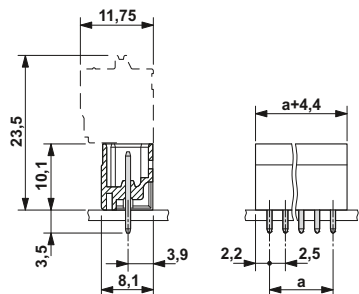

Drilling diagram

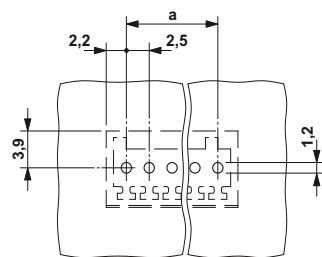

Ordering data

Type	Order No.	Pcs. / Pkt.
Pitch 2.5 mm, color: green		
MCV 0,5/ 2-G-2,5	1881558	50
MCV 0,5/ 3-G-2,5	1881561	50
MCV 0,5/ 4-G-2,5	1881574	50
MCV 0,5/ 5-G-2,5	1881587	50
MCV 0,5/ 6-G-2,5	1881590	50
MCV 0,5/ 7-G-2,5	1881600	50
MCV 0,5/ 8-G-2,5	1881613	50
MCV 0,5/ 9-G-2,5	1881626	50
MCV 0,5/10-G-2,5	1881639	50
MCV 0,5/11-G-2,5	1881642	50
MCV 0,5/12-G-2,5	1881655	50



Dimensional drawing

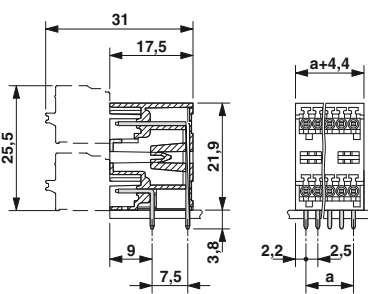

Drilling diagram

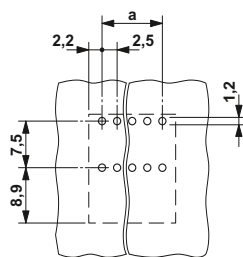

Ordering data

Type	Order No.	Pcs. / Pkt.
Pitch 2.5 mm, color: green		
MCD 0,5/ 2-G1-2,5	1894804	50
MCD 0,5/ 3-G1-2,5	1894817	50
MCD 0,5/ 4-G1-2,5	1894820	50
MCD 0,5/ 5-G1-2,5	1894833	50
MCD 0,5/ 6-G1-2,5	1894846	50
MCD 0,5/ 7-G1-2,5	1894859	50
MCD 0,5/ 8-G1-2,5	1894862	50
MCD 0,5/ 9-G1-2,5	1894875	50
MCD 0,5/10-G1-2,5	1894888	50
MCD 0,5/11-G1-2,5	1894891	50
MCD 0,5/12-G1-2,5	1894901	50



Dimensional drawing

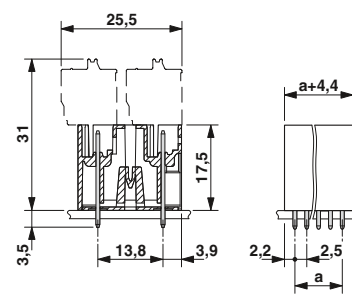

Drilling diagram

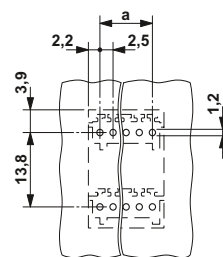

Ordering data

Type	Order No.	Pcs. / Pkt.
Pitch 2.5 mm, color: green		
MCDV 0,5/ 2-G1-2,5	1894914	50
MCDV 0,5/ 3-G1-2,5	1894927	50
MCDV 0,5/ 4-G1-2,5	1894930	50
MCDV 0,5/ 5-G1-2,5	1894943	50
MCDV 0,5/ 6-G1-2,5	1894956	50
MCDV 0,5/ 7-G1-2,5	1894969	50
MCDV 0,5/ 8-G1-2,5	1894972	50
MCDV 0,5/ 9-G1-2,5	1894985	50
MCDV 0,5/10-G1-2,5	1894998	50
MCDV 0,5/11-G1-2,5	1895007	50
MCDV 0,5/12-G1-2,5	1895010	50

Micro plug-in connectors with 2.5 mm and 2.54 mm pitch

MICRO COMBICON plug-in connectors, 2.54 mm pitch up to 6 A

Plugs with push-in spring connection

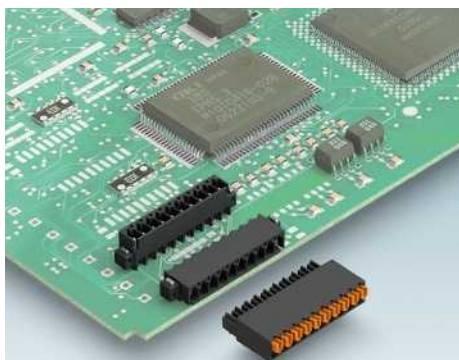

- Ultra-flat design height of just 5.4 mm
- Can be combined with MC(V) 0,5 headers with 2.54 mm pitch
- User-friendly actuation of the spring lever using a screwdriver
- Versions with fixed coding of the first position (C1) or the last position (C2)
- Touch connection for voltage testing using a 0.64 mm Ø test pin

Notes:

In accordance with DIN EN 61984, COMBICON plug-in connectors have no switching power. During designated use, they must not be plugged in or disconnected when carrying voltage or under load.

COMBICON select

Possible combinations for plug-in connectors can be found in COMBICON select at www.phoenixcontact.net/products.





1) Derating curves on request.

N



Flat plug, with gold-plated contact system

Accessories

For all types	Type	Page
	Marker cards SK 2,54/2,8	796
	Screwdriver SZS 0,4 X 2,0 Order No. 1205202	
	Ferrules with and without plastic sleeve	834
	Crimping pliers for 0.25 to 6 mm ² CRIMPFOX 6 Order No. 1212034	

Dimensional drawing

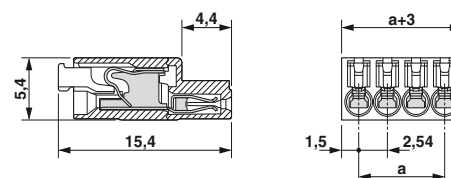

Technical data

Technical data in accordance to IEC / DIN VDE	
Rated current / conductor cross section	[A] / [mm ²]
Rated insulation voltage for pollution degree 2	[V]
Pitch	[mm]
Connection capacity	
Solid / stranded	[mm ²] / [mm ²] / AWG
Stranded with ferrules without plastic sleeve	[mm ²]
Stranded with ferrules with plastic sleeve	[mm ²]
Multi-conductor connection capacity (two conductors with the same cross section)	
Insulation coordination	
Surge voltage category / pollution degree	
Rated insulation voltage	[V]
Rated surge voltage	[kV]
Approval data (UL/CUL)	Use Group
Nominal voltage	[V]
Nominal current	[A]
Connection capacity AWG	AWG
Approval data (CSA)	Use Group
Nominal voltage	[V]
Nominal current	[A]
Connection capacity AWG	AWG
General data	
Stripping length	[mm]
Type of insulation material / insulation material group	
Inflammability class according to UL 94	

6 ¹⁾ / 0.5		
160		
2.54		
0.14 - 0.5 / 0.14 - 0.5 / 26 - 20		
0.25 - 0.34		
0.14 - 0.25		
III / 3	III / 2	II / 2
32	160	160
2.5	2.5	2.5
B	C	D
-	-	-
-	-	-
-	-	-
-	-	-
-	-	-
-	-	-
7	LCP / IIIa	
V0		

Ordering data

No. of pos.	Dim. a [mm]	Type	Order No.	Pcs. / Pkt.
2.54 mm pitch, color: black				
2	2.54	FMC 0,5/ 2-ST-2,54	1821096	200
3	5.08	FMC 0,5/ 3-ST-2,54	1821106	200
4	7.62	FMC 0,5/ 4-ST-2,54	1821119	200
5	10.16	FMC 0,5/ 5-ST-2,54	1821122	200
6	12.70	FMC 0,5/ 6-ST-2,54	1821135	200
7	15.24	FMC 0,5/ 7-ST-2,54	1821148	100
8	17.78	FMC 0,5/ 8-ST-2,54	1821151	100
9	20.32	FMC 0,5/ 9-ST-2,54	1821164	100
10	22.86	FMC 0,5/10-ST-2,54	1821177	100
11	25.40	FMC 0,5/11-ST-2,54	1821180	100
12	27.94	FMC 0,5/12-ST-2,54	1821193	100
13	30.48	FMC 0,5/13-ST-2,54	1821203	100
14	33.02	FMC 0,5/14-ST-2,54	1821216	100
15	35.56	FMC 0,5/15-ST-2,54	1821229	100
16	38.10	FMC 0,5/16-ST-2,54	1821232	100

N

N



Plug with gold-plated contact system, fixed coding of the first position (C1)

Plug with gold-plated contact system, fixed coding of the last position (C2)

Dimensional drawing

Dimensional drawing

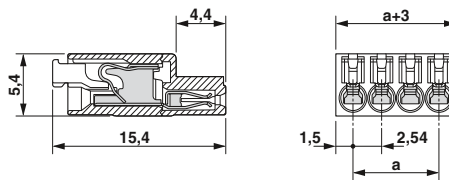
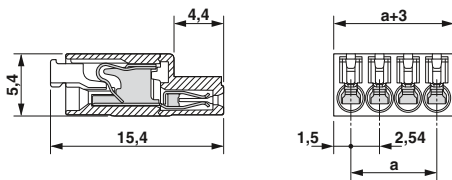

Ordering data

Ordering data

Type	Order No.	Pcs. / Pkt.
2.54 mm pitch, color: black		
FMC 0,5/ 2-ST-2,54 C1	1706263	200
FMC 0,5/ 3-ST-2,54 C1	1706262	200
FMC 0,5/ 4-ST-2,54 C1	1706261	200
FMC 0,5/ 5-ST-2,54 C1	1706259	200
FMC 0,5/ 6-ST-2,54 C1	1706258	200
FMC 0,5/ 7-ST-2,54 C1	1706256	100
FMC 0,5/ 8-ST-2,54 C1	1706255	100
FMC 0,5/ 9-ST-2,54 C1	1706254	100
FMC 0,5/10-ST-2,54 C1	1706253	100
FMC 0,5/11-ST-2,54 C1	1706252	100
FMC 0,5/12-ST-2,54 C1	1706250	100
FMC 0,5/13-ST-2,54 C1	1706249	100
FMC 0,5/14-ST-2,54 C1	1706247	100
FMC 0,5/15-ST-2,54 C1	1706246	100
FMC 0,5/16-ST-2,54 C1	1706245	100

Type	Order No.	Pcs. / Pkt.
2.54 mm pitch, color: black		
FMC 0,5/ 2-ST-2,54 C2	1706243	200
FMC 0,5/ 3-ST-2,54 C2	1706242	200
FMC 0,5/ 4-ST-2,54 C2	1706241	200
FMC 0,5/ 5-ST-2,54 C2	1706240	200
FMC 0,5/ 6-ST-2,54 C2	1706239	200
FMC 0,5/ 7-ST-2,54 C2	1706238	100
FMC 0,5/ 8-ST-2,54 C2	1706237	100
FMC 0,5/ 9-ST-2,54 C2	1706236	100
FMC 0,5/10-ST-2,54 C2	1706234	100
FMC 0,5/11-ST-2,54 C2	1706233	100
FMC 0,5/12-ST-2,54 C2	1706232	100
FMC 0,5/13-ST-2,54 C2	1706230	100
FMC 0,5/14-ST-2,54 C2	1706229	100
FMC 0,5/15-ST-2,54 C2	1706227	100
FMC 0,5/16-ST-2,54 C2	1706226	100

Micro plug-in connectors with 2.5 mm and 2.54 mm pitch

MICRO COMBICON plug-in connectors, 2.54 mm pitch up to 6 A

Headers for reflow/SMD processes

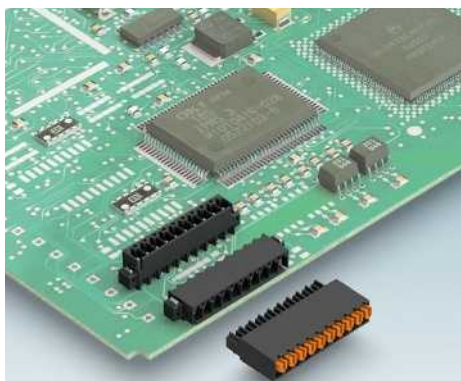

- Versions for use in THR or SMD processes
- With anchor metal for secure hold on the PCB
- Can be combined with non-coded FMC 0,5...ST plugs

Notes:

In accordance with DIN EN 61984, COMBICON plug-in connectors have no switching power. During designated use, they must not be plugged in or disconnected when carrying voltage or under load.

COMBICON select

Possible combinations for plug-in connectors can be found in COMBICON select at www.phoenixcontact.net/products.

Pick and place pads for taped THR articles usually protrude beyond the components. The PCB layout must ensure that collisions are avoided when components are assembled. Dimensional drawings of the pick and place pads can be found online at www.phoenixcontact.net/products.

N



Header for THR applications, pin length 2.0 mm, gold-plated contact system, plug-in direction parallel to the PCB

Accessories

For all types	Type	Page
	Marker cards SK 2,54/2,8	796

Dimensional drawing

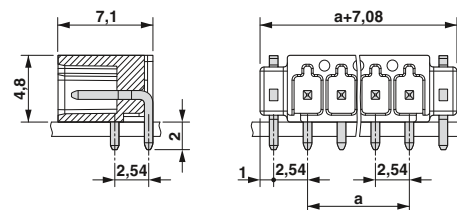

Drilling diagram

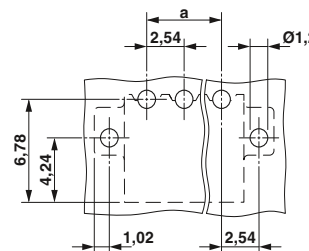

Technical data

Technical data in accordance to IEC / DIN VDE	
Rated current	[A]
Rated insulation voltage for pollution degree 2	[V]
Pitch	[mm]
Insulation coordination	
Surge voltage category / pollution degree	III / 3 III / 2 II / 2
Rated insulation voltage	[V]
Rated surge voltage	[kV]
Approval data (UL/CUL)	Use Group B C D
Nominal voltage	[V]
Nominal current	[A]
Connection capacity AWG	AWG
Approval data (CSA)	Use Group B C D
Nominal voltage	[V]
Nominal current	[A]
Connection capacity AWG	AWG
General data	
Type of insulation material / insulation material group	LCP / IIIa
Inflammability class according to UL 94	V0
Drill hole diameter / pin dimensions	[mm] 1.2 / 0,64 x 0,64 mm

Ordering data

No. of pos.	Dim. a [mm]	Type	Order No.	Pcs. / Pkt.
2.54 mm pitch, color: black				
2	2.54	MC 0,5/ 2-G-2,54 P20 THR R24	1821245	465
3	5.08	MC 0,5/ 3-G-2,54 P20 THR R24	1821258	465
4	7.62	MC 0,5/ 4-G-2,54 P20 THR R24	1821261	465
5	10.16	MC 0,5/ 5-G-2,54 P20 THR R24	1821274	465
6	12.70	MC 0,5/ 6-G-2,54 P20 THR R44	1821287	465
7	15.24	MC 0,5/ 7-G-2,54 P20 THR R44	1821290	465
8	17.78	MC 0,5/ 8-G-2,54 P20 THR R44	1821300	465
9	20.32	MC 0,5/ 9-G-2,54 P20 THR R44	1821313	465
10	22.86	MC 0,5/10-G-2,54 P20 THR R56	1821326	465
11	25.40	MC 0,5/11-G-2,54 P20 THR R56	1821339	465
12	27.94	MC 0,5/12-G-2,54 P20 THR R56	1821342	465
13	30.48	MC 0,5/13-G-2,54 P20 THR R56	1821355	465
14	33.02	MC 0,5/14-G-2,54 P20 THR R56	1821368	465
15	35.56	MC 0,5/15-G-2,54 P20 THR R56	1821371	465
16	38.10	MC 0,5/16-G-2,54 P20 THR R72	1821384	465

N

N

N



Header for THR applications, pin length 2.0 mm, gold-plated contact system, plug-in direction vertical to the PCB



Header for SMD applications, gold-plated contact system, plug-in direction parallel to the PCB



Header for SMD applications, gold-plated contact system, plug-in direction vertical to the PCB

Dimensional drawing

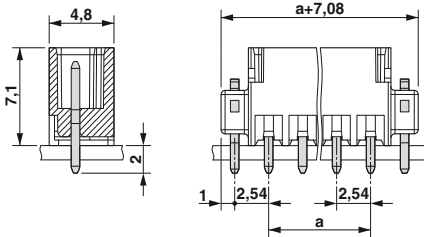

Dimensional drawing

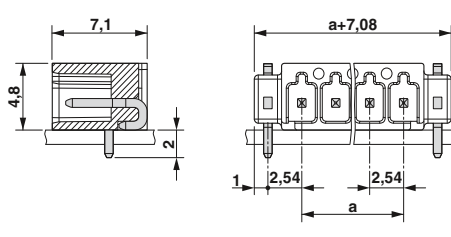

Dimensional drawing

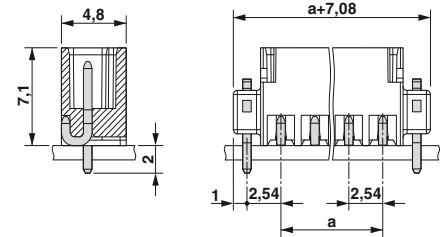

Drilling diagram

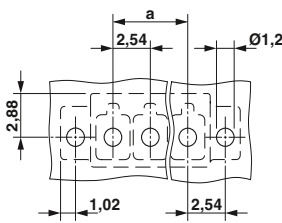

Drilling diagram

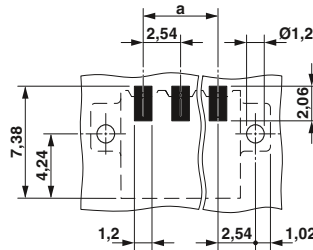

Drilling diagram

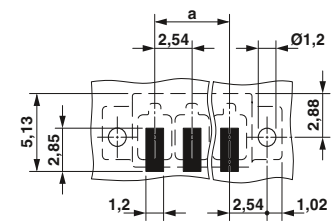

Ordering data

Type	Order No.	Pcs. / Pkt.
2.54 mm pitch, color: black		
MCV 0,5/ 2-G-2,54 P20 THR R24	1821397	315
MCV 0,5/ 3-G-2,54 P20 THR R24	1821407	315
MCV 0,5/ 4-G-2,54 P20 THR R24	1821410	315
MCV 0,5/ 5-G-2,54 P20 THR R24	1821423	315
MCV 0,5/ 6-G-2,54 P20 THR R44	1821436	315
MCV 0,5/ 7-G-2,54 P20 THR R44	1821449	315
MCV 0,5/ 8-G-2,54 P20 THR R44	1821452	315
MCV 0,5/ 9-G-2,54 P20 THR R44	1821465	315
MCV 0,5/10-G-2,54 P20 THR R56	1821478	315
MCV 0,5/11-G-2,54 P20 THR R56	1821481	315
MCV 0,5/12-G-2,54 P20 THR R56	1821494	315
MCV 0,5/13-G-2,54 P20 THR R56	1821504	315
MCV 0,5/14-G-2,54 P20 THR R56	1821517	315
MCV 0,5/15-G-2,54 P20 THR R56	1821520	315
MCV 0,5/16-G-2,54 P20 THR R72	1821533	315

Ordering data

Type	Order No.	Pcs. / Pkt.
2.54 mm pitch, color: black		
MC 0,5/ 2-G-2,54 SMD R24	1821698	465
MC 0,5/ 3-G-2,54 SMD R24	1821708	465
MC 0,5/ 4-G-2,54 SMD R24	1821711	465
MC 0,5/ 5-G-2,54 SMD R24	1821724	465
MC 0,5/ 6-G-2,54 SMD R44	1821737	465
MC 0,5/ 7-G-2,54 SMD R44	1821740	465
MC 0,5/ 8-G-2,54 SMD R44	1821753	465
MC 0,5/ 9-G-2,54 SMD R44	1821766	465
MC 0,5/10-G-2,54 SMD R56	1821779	465
MC 0,5/11-G-2,54 SMD R56	1821782	465
MC 0,5/12-G-2,54 SMD R56	1821795	465
MC 0,5/13-G-2,54 SMD R56	1821805	465
MC 0,5/14-G-2,54 SMD R56	1821818	465
MC 0,5/15-G-2,54 SMD R56	1821821	465
MC 0,5/16-G-2,54 SMD R72	1821834	465

Ordering data

Type	Order No.	Pcs. / Pkt.
2.54 mm pitch, color: black		
MCV 0,5/ 2-G-2,54 SMD R24	1821546	315
MCV 0,5/ 3-G-2,54 SMD R24	1821559	315
MCV 0,5/ 4-G-2,54 SMD R24	1821562	315
MCV 0,5/ 5-G-2,54 SMD R24	1821575	315
MCV 0,5/ 6-G-2,54 SMD R44	1821588	315
MCV 0,5/ 7-G-2,54 SMD R44	1821591	315
MCV 0,5/ 8-G-2,54 SMD R44	1821601	315
MCV 0,5/ 9-G-2,54 SMD R44	1821614	315
MCV 0,5/10-G-2,54 SMD R56	1821627	315
MCV 0,5/11-G-2,54 SMD R56	1821630	315
MCV 0,5/12-G-2,54 SMD R56	1821643	315
MCV 0,5/13-G-2,54 SMD R56	1821656	315
MCV 0,5/14-G-2,54 SMD R56	1821669	315
MCV 0,5/15-G-2,54 SMD R56	1821672	315
MCV 0,5/16-G-2,54 SMD R72	1821685	315

Micro plug-in connectors with 2.5 mm and 2.54 mm pitch

MICRO COMBICON plug-in connectors, 2.54 mm pitch up to 6 A

Headers for reflow/SMD processes

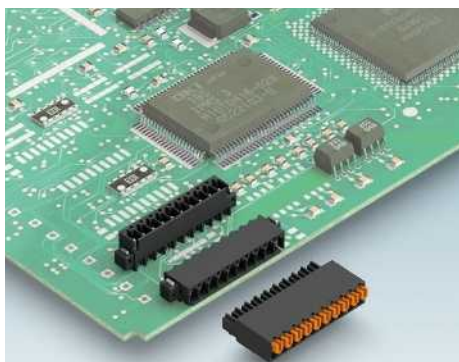

- Versions for use in THR or SMD processes
- With anchor metal for secure hold on the PCB
- Delivery form: tape-on-reel packing according to IEC 60286-3 for automated assembly
- With fixed coding of the first position (C1) or the last position (C2)
- Can be combined with coded plugs FMC 0,5...ST... C1 or C2

Notes:

In accordance with DIN EN 61984, COMBICON plug-in connectors have no switching power. During designated use, they must not be plugged in or disconnected when carrying voltage or under load.

COMBICON select

Possible combinations for plug-in connectors can be found in COMBICON select at www.phoenixcontact.net/products.

Pick and place pads for taped THR articles usually protrude beyond the components. The PCB layout must ensure that collisions are avoided when components are assembled. Dimensional drawings of the pick and place pads can be found online at www.phoenixcontact.net/products.

N



Coded header for THR applications, pin length 2.0 mm, gold-plated contact system, plug-in direction parallel to the PCB

Accessories

For all types	Type	Page
	Marker cards SK 2,54/2,8	796

Dimensional drawing

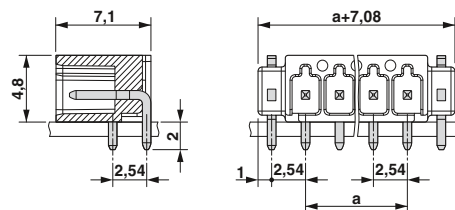

Drilling diagram

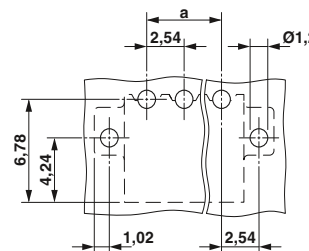

Technical data

Technical data in accordance to IEC / DIN VDE	
Rated current	[A] 6
Rated insulation voltage for pollution degree 2	[V] 160
Pitch	[mm] 2.54
Insulation coordination	
Surge voltage category / pollution degree	III / 3 III / 2 II / 2
Rated insulation voltage	[V] 32 160 160
Rated surge voltage	[kV] 2.5 2.5 2.5
Approval data (UL/CUL)	Use Group B C D
Nominal voltage	[V] - - -
Nominal current	[A] - - -
Connection capacity AWG	AWG - - -
Approval data (CSA)	Use Group B C D
Nominal voltage	[V] - - -
Nominal current	[A] - - -
Connection capacity AWG	AWG - - -
General data	
Type of insulation material / insulation material group	LCP / IIIa
Inflammability class according to UL 94	V0
Drill hole diameter / pin dimensions	[mm] 1.2 / 0,64 x 0,64 mm

Ordering data

Type	Order No.	Pcs. / Pkt.
2.54 mm pitch, color: black		
MC 0,5/ 2-G-2,54 P20THRR24C1	1706225	465
MC 0,5/ 3-G-2,54 P20THRR24C1	1706224	465
MC 0,5/ 4-G-2,54 P20THRR24C1	1706223	465
MC 0,5/ 5-G-2,54 P20THRR24C1	1706221	465
MC 0,5/ 6-G-2,54 P20THRR44C1	1706220	465
MC 0,5/ 7-G-2,54 P20THRR44C1	1706218	465
MC 0,5/ 8-G-2,54 P20THRR44C1	1706217	465
MC 0,5/ 9-G-2,54 P20THRR44C1	1706216	465
MC 0,5/10-G-2,54 P20THRR44C1	1706214	465
MC 0,5/11-G-2,54 P20THRR56C1	1706213	465
MC 0,5/12-G-2,54 P20THRR56C1	1706212	465
MC 0,5/13-G-2,54 P20THRR56C1	1706211	465
MC 0,5/14-G-2,54 P20THRR56C1	1706210	465
MC 0,5/15-G-2,54 P20THRR56C1	1706209	465
MC 0,5/16-G-2,54 P20THRR72C1	1706208	465
2.54 mm pitch, color: black		
MC 0,5/ 2-G-2,54 P20THRR24C2	1706207	465
MC 0,5/ 3-G-2,54 P20THRR24C2	1706205	465
MC 0,5/ 4-G-2,54 P20THRR24C2	1706204	465
MC 0,5/ 5-G-2,54 P20THRR24C2	1706203	465
MC 0,5/ 6-G-2,54 P20THRR44C2	1706201	465
MC 0,5/ 7-G-2,54 P20THRR44C2	1706200	465
MC 0,5/ 8-G-2,54 P20THRR44C2	1706199	465
MC 0,5/ 9-G-2,54 P20THRR44C2	1706198	465
MC 0,5/10-G-2,54 P20THRR44C2	1706197	465
MC 0,5/11-G-2,54 P20THRR56C2	1706195	465
MC 0,5/12-G-2,54 P20THRR56C2	1706194	465
MC 0,5/13-G-2,54 P20THRR56C2	1706193	465
MC 0,5/14-G-2,54 P20THRR56C2	1706191	465
MC 0,5/15-G-2,54 P20THRR56C2	1706190	465
MC 0,5/16-G-2,54 P20THRR72C2	1706188	465

Micro plug-in connectors with 2.5 mm and 2.54 mm pitch

MICRO COMBICON plug-in connectors, 2.54 mm pitch up to 6 A

N



Coded header for THR applications, pin length 2.0 mm, gold-plated contact system, plug-in direction vertical to the PCB

Dimensional drawing

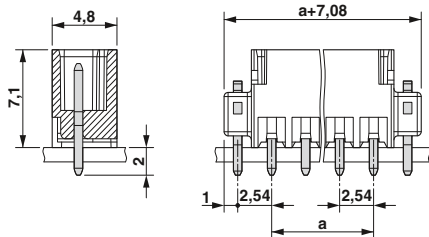

Drilling diagram

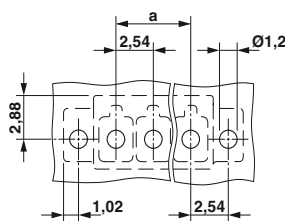

Ordering data

Type	Order No.	Pcs. / Pkt.
2.54 mm pitch, color: black		
MCV 0,5/ 2-G-2,54 P20THRR24C1	1706187	315
MCV 0,5/ 3-G-2,54 P20THRR24C1	1706186	315
MCV 0,5/ 4-G-2,54 P20THRR24C1	1706185	315
MCV 0,5/ 5-G-2,54 P20THRR44C1	1706184	315
MCV 0,5/ 6-G-2,54 P20THRR44C1	1706182	315
MCV 0,5/ 7-G-2,54 P20THRR44C1	1706181	315
MCV 0,5/ 8-G-2,54 P20THRR44C1	1706180	315
MCV 0,5/ 9-G-2,54 P20THRR56C1	1706179	315
MCV 0,5/10-G-2,54 P20THRR56C1	1706178	315
MCV 0,5/11-G-2,54 P20THRR56C1	1706177	315
MCV 0,5/12-G-2,54 P20THRR56C1	1706175	315
MCV 0,5/13-G-2,54 P20THRR56C1	1706174	315
MCV 0,5/14-G-2,54 P20THRR72C1	1706173	315
MCV 0,5/15-G-2,54 P20THRR72C1	1706172	315
MCV 0,5/16-G-2,54 P20THRR72C1	1706171	315
2.54 mm pitch, color: black		
MCV 0,5/ 2-G-2,54 P20THRR24C2	1706169	315
MCV 0,5/ 3-G-2,54 P20THRR24C2	1706168	315
MCV 0,5/ 4-G-2,54 P20THRR24C2	1706166	315
MCV 0,5/ 5-G-2,54 P20THRR44C2	1706165	315
MCV 0,5/ 6-G-2,54 P20THRR44C2	1706164	315
MCV 0,5/ 7-G-2,54 P20THRR44C2	1706162	315
MCV 0,5/ 8-G-2,54 P20THRR44C2	1706161	315
MCV 0,5/ 9-G-2,54 P20THRR56C2	1706160	315
MCV 0,5/10-G-2,54 P20THRR56C2	1706159	315
MCV 0,5/11-G-2,54 P20THRR56C2	1706158	315
MCV 0,5/12-G-2,54 P20THRR56C2	1706157	315
MCV 0,5/13-G-2,54 P20THRR56C2	1706156	315
MCV 0,5/14-G-2,54 P20THRR72C2	1706155	315
MCV 0,5/15-G-2,54 P20THRR72C2	1706153	315
MCV 0,5/16-G-2,54 P20THRR72C2	1706152	315

N



Coded header for SMD applications, gold-plated contact system, plug-in direction parallel to the PCB

Dimensional drawing

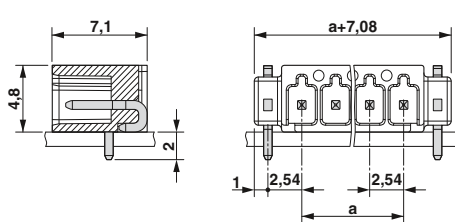

Drilling diagram

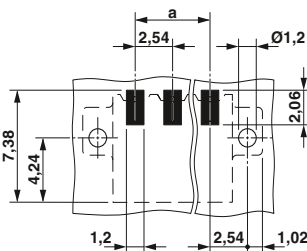

Ordering data

Type	Order No.	Pcs. / Pkt.
2.54 mm pitch, color: black		
MC 0,5/ 2-G-2,54 SMDR24C1	1706151	465
MC 0,5/ 3-G-2,54 SMDR24C1	1706149	465
MC 0,5/ 4-G-2,54 SMDR24C1	1706148	465
MC 0,5/ 5-G-2,54 SMDR24C1	1706146	465
MC 0,5/ 6-G-2,54 SMDR44C1	1706145	465
MC 0,5/ 7-G-2,54 SMDR44C1	1706144	465
MC 0,5/ 8-G-2,54 SMDR44C1	1706143	465
MC 0,5/ 9-G-2,54 SMDR44C1	1706142	465
MC 0,5/10-G-2,54 SMDR44C1	1706140	465
MC 0,5/11-G-2,54 SMDR56C1	1706139	465
MC 0,5/12-G-2,54 SMDR56C1	1706137	465
MC 0,5/13-G-2,54 SMDR56C1	1706136	465
MC 0,5/14-G-2,54 SMDR56C1	1706135	465
MC 0,5/15-G-2,54 SMDR56C1	1706133	465
MC 0,5/16-G-2,54 SMDR72C1	1706132	465
2.54 mm pitch, color: black		
MC 0,5/ 2-G-2,54 SMDR24C2	1706131	465
MC 0,5/ 3-G-2,54 SMDR24C2	1706130	465
MC 0,5/ 4-G-2,54 SMDR24C2	1706129	465
MC 0,5/ 5-G-2,54 SMDR24C2	1706128	465
MC 0,5/ 6-G-2,54 SMDR44C2	1706127	465
MC 0,5/ 7-G-2,54 SMDR44C2	1706126	465
MC 0,5/ 8-G-2,54 SMDR44C2	1706124	465
MC 0,5/ 9-G-2,54 SMDR44C2	1706123	465
MC 0,5/10-G-2,54 SMDR44C2	1706122	465
MC 0,5/11-G-2,54 SMDR56C2	1706120	465
MC 0,5/12-G-2,54 SMDR56C2	1706119	465
MC 0,5/13-G-2,54 SMDR56C2	1706117	465
MC 0,5/14-G-2,54 SMDR56C2	1706116	465
MC 0,5/15-G-2,54 SMDR56C2	1706115	465
MC 0,5/16-G-2,54 SMDR72C2	1706114	465

N



Coded header for SMD applications, gold-plated contact system, plug-in direction vertical to the PCB

Dimensional drawing

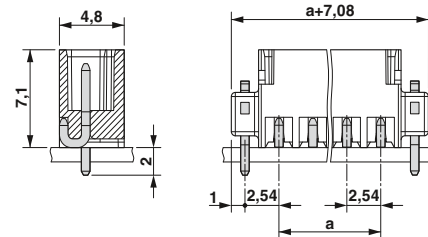

Drilling diagram

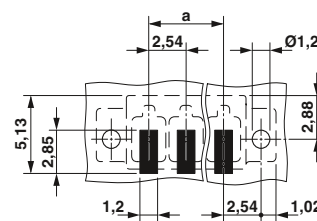

Ordering data

Type	Order No.	Pcs. / Pkt.
2.54 mm pitch, color: black		
MCV 0,5/ 2-G-2,54 SMDR24C1	1706113	315
MCV 0,5/ 3-G-2,54 SMDR24C1	1706111	315
MCV 0,5/ 4-G-2,54 SMDR24C1	1706110	315
MCV 0,5/ 5-G-2,54 SMDR44C1	1706108	315
MCV 0,5/ 6-G-2,54 SMDR44C1	1706107	315
MCV 0,5/ 7-G-2,54 SMDR44C1	1706106	315
MCV 0,5/ 8-G-2,54 SMDR44C1	1706104	315
MCV 0,5/ 9-G-2,54 SMDR56C1	1706103	315
MCV 0,5/10-G-2,54 SMDR56C1	1706102	315
MCV 0,5/11-G-2,54 SMDR56C1	1706101	315
MCV 0,5/12-G-2,54 SMDR56C1	1706100	315
MCV 0,5/13-G-2,54 SMDR56C1	1706098	315
MCV 0,5/14-G-2,54 SMDR72C1	1706097	315
MCV 0,5/15-G-2,54 SMDR72C1	1706096	315
MCV 0,5/16-G-2,54 SMDR72C1	1706094	315
2.54 mm pitch, color: black		
MCV 0,5/ 2-G-2,54 SMDR24C2	1706093	315
MCV 0,5/ 3-G-2,54 SMDR24C2	1706092	315
MCV 0,5/ 4-G-2,54 SMDR24C2	1706091	315
MCV 0,5/ 5-G-2,54 SMDR44C2	1706090	315
MCV 0,5/ 6-G-2,54 SMDR44C2	1706089	315
MCV 0,5/ 7-G-2,54 SMDR44C2	1706088	315
MCV 0,5/ 8-G-2,54 SMDR44C2	1706087	315
MCV 0,5/ 9-G-2,54 SMDR56C2	1706085	315
MCV 0,5/10-G-2,54 SMDR56C2	1706084	315
MCV 0,5/11-G-2,54 SMDR56C2	1706083	315
MCV 0,5/12-G-2,54 SMDR56C2	1706081	315
MCV 0,5/13-G-2,54 SMDR56C2	1706080	315
MCV 0,5/14-G-2,54 SMDR72C2	1706078	315
MCV 0,5/15-G-2,54 SMDR72C2	1706077	315
MCV 0,5/16-G-2,54 SMDR72C2	1706076	315

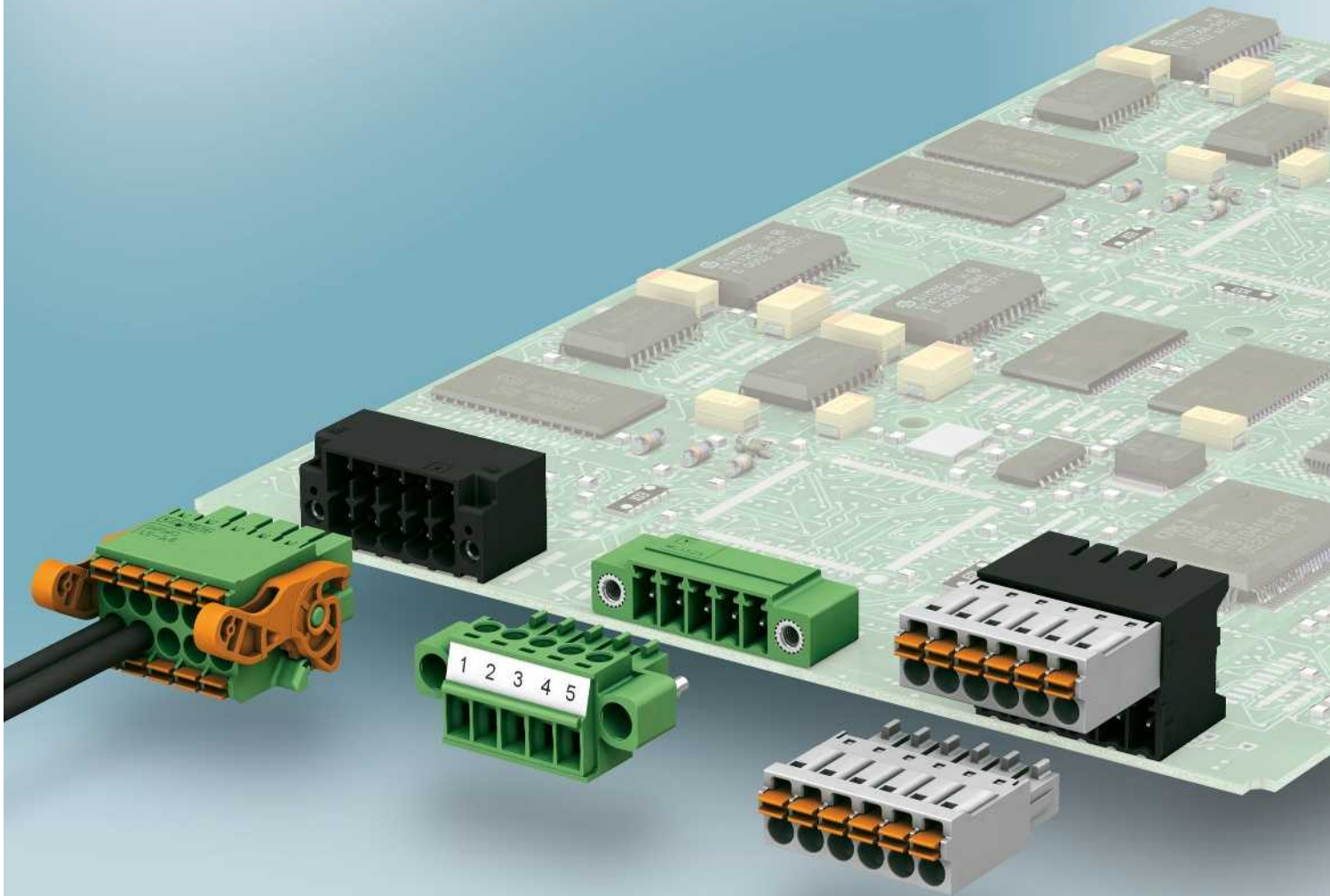

Mini plug-in connectors with 3.5/3.81 and 5.08 mm pitch

The trend towards the miniaturization of modules and devices continues. In terms of device development, an ever increasing number of wiring points on devices have to be taken into consideration.

The plug-in connectors in the COMBICON Mini series follow this trend with space-saving 3.5/3.81 mm and 5.08 mm pitch. Thanks to their compact dimensions, they offer convenient conductor connection up to 1.5 mm².

In addition to proven screw connection, the product range includes innovative push-in spring connection, fast insulation displacement connection technology, and crimp connections for assembly.























A wide choice of different designs are available for plug-in combinations.











The header range offers horizontal, vertical or double-level versions for the wave soldering and SMT process. Through hole reflow (THR) headers, which are made from high-temperature-resistant material, are available in tape-on-reel packing, enabling fully automated handling in the SMT process.

COMBICON control mini cross-reference list	182
MINI-COMBICON plug-in connectors, 3.5/3.81 and 5.08 mm pitch	184
Double-row plugs with push-in spring connection	184
Double row headers for reflow processes	186
Plugs with screw connection	190
Inverted plugs with screw connection	196
Plugs with push-in spring connection	198
Plugs with displacement connection	204
Plugs with crimp connection	206
Single-level headers for reflow processes	208
Double-level headers for reflow processes	218
Single-level headers for press-in technology	222
Single-level headers for wave soldering processes	224
Orthogonal headers for wave soldering processes	230
Double-level headers for wave soldering processes	234
Inverted headers for wave soldering processes	238
Headers for panel feed-throughs and direct mounting	240
Cable housings	242
Fiber optics for headers	244
Plugs with screw connection with 5.08 mm pitch	246
Headers for wave soldering processes with 5.08 mm pitch	248
Special designs	
SUBCON headers with MINI COMBICON pin connector pattern	251

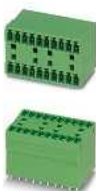
Mini plug-in connectors with 3.5/3.81 and 5.08 mm pitch

COMBICON control mini cross-reference list

MINI COMBICON plugs	Type	Pitch	MINI COMBICON headers						
									
			DMC...G(F) Page 186	IMC...ST(GF) Page 196	EMC(V)...G MC(V)...G (THR) Page 222 224 / 208	EMC(V)...GF MC(V)...GF(THR) Page 223 208	SMC...G(F) Page 228	MC ..GF-LR MCV ...GF-LR Page 225	MCDN...G1 MCDNV...G1 Page 218 220
			3.5	3.81	3.5 3.81	3.5 3.81	3.81	3.5 3.81	3.5 3.81
	DFMC...ST Page 184 DFMC...STF(...-LR) Page 185	3.5 3.5	• •						
	MC...ST Page 190 MC...STF Page 191	3.5 3.81 3.5 3.81		• •	• •	• •	• •	• •	
	MC...ST-LR Page 191	3.5 3.81						• •	
	FRONT-MC...ST Page 194 FRONT-MC...STF Page 195	3.81 3.81		• •	• •	• •	• •		
	MCVR(W)...ST Page 192 MCVR(W)...STF Page 193	3.5 3.81 3.5 3.81		• •	• •	• •	• •	• •	
	FK-MCP...ST-LR Page 199	3.5 3.81						• •	
	FK-MCP...ST Page 198 FK-MCP...STF Page 199	3.5 3.81 3.5 3.81		• •	• •	• •	• •	• •	
	FMC...ST Page 200 FMC...STF Page 201	3.5 3.81 3.5 3.81		• •	• •	• •	• •	• •	• •
	FMC...ST...RF Page 201	3.5							
	FMCD...ST Page 201	3.5							•
	TFMC...ST Page 202 TFMC...STF Page 202	3.5 3.5			•	•	•	•	
	QC...ST Page 204 QC...STF Page 205	3.81 3.81		• •	• •	• •	• •	• •	
	MCC...STZ Page 206 MCC...STZF Page 207	3.81 3.81		• •	• •	• •	• •	• •	
	IMC...G Page 238 IMCV...G Page 239	3.81 3.81		• •	• •	• •	• •	• •	
	MC...ST(1) Page 246 MC...ST(1)F Page 247	5.08 5.08							

 MC(V)...G RN MCDN(V)...G1 RN Page 225 219 3.5	 MCO...G Page 230	 MCO...G1 Page 232	 MCD(V)...G Page 234	 MCD(V)...GF Page 235	 MCD(V)...G1 Page 235	 MCDV...G1F Page 235	 DFK-MC...GF Page 240	 MCVU...GFD Page 241	 MC...G MCV...G Page 248	 MC...GF MCV...GF Page 249
	3.81	3.5	3.81	3.81	3.81	3.81	3.81	3.81	5.08	5.08
	•	•	•		•	•	•	•		
	•		•		•					
	•		•		•					
	•	•	•		•					
	•	•	•		•					
•										
	•		•		•					
	•		•		•					
	•		•		•					
	•		•		•					
									•	•

Mini plug-in connectors with 3.5/3.81 and 5.08 mm pitch

MINI COMBICON plug-in connectors, pitches 3.5 or 3.81 and 5.08 mm

Double-row plug with push-in spring connection



- Fast conductor connection through push-in direct plug-in technology
- Extremely flat design, 13.3 mm
- Combination with very flat DMC headers
- Conductor cross section up to 1.5 mm²
- Versions with and without screw flanges and Lock & Release levers
- Lock & Release levers lock the connector to the header and function as a release tool
- Higher numbers of positions up to 20-pos. can be found at: www.phoenixcontact.net/products

Notes:

In accordance with DIN EN 61984, COMBICON plug-in connectors have no switching power. During designated use, they must not be plugged in or disconnected when carrying voltage or under load.

COMBICON select

You will find the possible plug-in connector combinations in COMBICON select at: www.phoenixcontact.net/products or starting on page 182.

The maximum torque for the screw flange is 0.2 Nm.

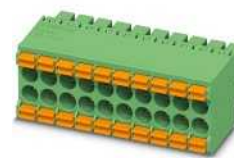

Two-row connector with push-in connection

Accessories

For all types	Type	Page
	Marker cards SK 3,5/2,8	797
	Coding profile CP-DMC-THR NAT Order No. 1790647	
	Screwdriver SZS 0,4 x 2,5 Order No. 1205037	
	Ferrules with and without plastic sleeve	834
	Crimping pliers for 0.25 to 6 mm ² CRIMPPFOX 6 Order No. 1212034	



Dimensional drawing

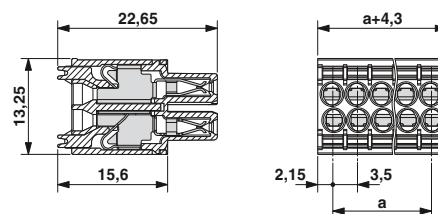

Note derating curves

Derating curves, determined as per DIN EN 61984 (VDE 0627):2002-09
Representation based on DIN EN 60512-5-2:2003-01
Connected conductor cross section = 1.5 mm²
Reduction factor = 0.8
Number of positions = see diagram

Technical data

Technical data in accordance to IEC / DIN VDE	
Rated current / conductor cross section	[A] / [mm ²]
Rated insulation voltage for pollution degree 2	[V]
Pitch	[mm]
Connection capacity	
Solid / stranded	[mm ²] / [mm ²] / AWG
Stranded with ferrules without plastic sleeve	[mm ²]
Stranded with ferrules with plastic sleeve	[mm ²]
Multi-conductor connection capacity (two conductors with the same cross section)	
Solid / stranded	[mm ²]
Stranded with ferrules without plastic sleeve	[mm ²]
Stranded with TWIN ferrule with plastic sleeve	[mm ²]
Insulation coordination	
Surge voltage category / pollution degree	III / 3 III / 2 II / 2
Rated insulation voltage	[V]
Rated surge voltage	[kV]
Approval data (UL/CUL)	Use Group
Nominal voltage	[V]
Nominal current	[A]
Connection capacity AWG	AWG
Approval data (CSA)	Use Group
Nominal voltage	[V]
Nominal current	[A]
Connection capacity AWG	AWG
General data	
Stripping length	[mm]
Type of insulation material / insulation material group	
Inflammability class according to UL 94	

	8 / 1.5
	160
	3.5
	0.2 - 1.5 / 0.2 - 1.5 / 24 - 16
	0.25 - 1.5
	0.25 - 0.75
	- / -
	-
	-
	III / 3 III / 2 II / 2
	160 160 250
	2.5 2.5 2.5
	B C D
	150 - -
	8 - -
	16 - 24 - -
	B C D
	- - -
	- - -
	- - -
	10
	PA / I
	V0

No. of pos.	Dim. a [mm]
2	3.50
3	7.00
4	10.50
5	14.00
6	17.50
7	21.00
8	24.50
9	28.00
10	31.50
11	35.00
12	38.50
13	42.00
14	45.50
15	49.00
16	52.50

Ordering data

Type	Order No.	Pcs. / Pkt.
3.5 mm pitch, color: green		
DFMC 1,5/ 2-ST-3,5	1790108	50
DFMC 1,5/ 3-ST-3,5	1790111	50
DFMC 1,5/ 4-ST-3,5	1790124	50
DFMC 1,5/ 5-ST-3,5	1790137	50
DFMC 1,5/ 6-ST-3,5	1790140	50
DFMC 1,5/ 7-ST-3,5	1790153	50
DFMC 1,5/ 8-ST-3,5	1790166	50
DFMC 1,5/ 9-ST-3,5	1790179	50
DFMC 1,5/10-ST-3,5	1790182	50
DFMC 1,5/11-ST-3,5	1790195	50
DFMC 1,5/12-ST-3,5	1790205	50
DFMC 1,5/13-ST-3,5	1790218	50
DFMC 1,5/14-ST-3,5	1790221	50
DFMC 1,5/15-ST-3,5	1790234	50
DFMC 1,5/16-ST-3,5	1790247	50

Mini plug-in connectors with 3.5/3.81 and 5.08 mm pitch

MINI COMBICON plug-in connectors, pitches 3.5 or 3.81 and 5.08 mm

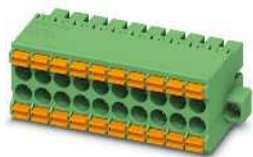

With screw flange

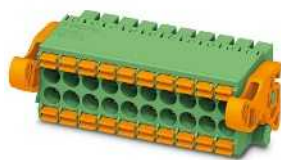

With Lock & Release levers for locking and releasing



Dimensional drawing

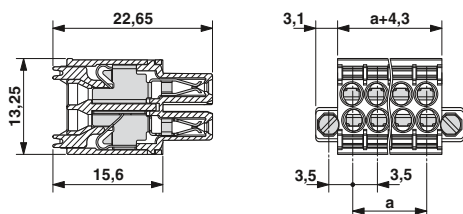

Dimensional drawing

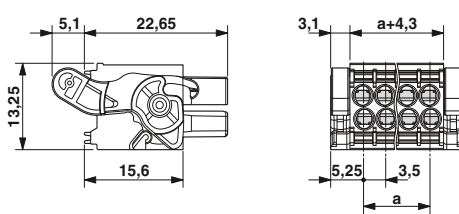

Representative derating curve

Type: DFMC 1,5/...-ST-3,5 with DMC 1,5/...-G1-3,5 P20 THR

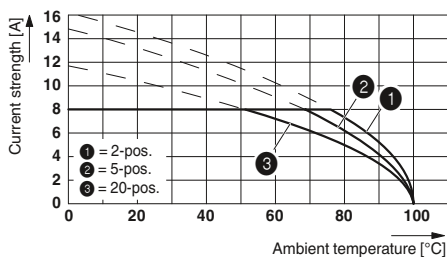

Ordering data

Type	Order No.	Pcs. / Pkt.
3.5 mm pitch, color: green		
DFMC 1,5/ 2-STF-3,5	1790292	50
DFMC 1,5/ 3-STF-3,5	1790302	50
DFMC 1,5/ 4-STF-3,5	1790315	50
DFMC 1,5/ 5-STF-3,5	1790328	50
DFMC 1,5/ 6-STF-3,5	1790331	50
DFMC 1,5/ 7-STF-3,5	1790344	50
DFMC 1,5/ 8-STF-3,5	1790357	50
DFMC 1,5/ 9-STF-3,5	1790360	50
DFMC 1,5/10-STF-3,5	1790373	50
DFMC 1,5/11-STF-3,5	1790386	50
DFMC 1,5/12-STF-3,5	1790399	50
DFMC 1,5/13-STF-3,5	1790409	50
DFMC 1,5/14-STF-3,5	1790412	50
DFMC 1,5/15-STF-3,5	1790425	50
DFMC 1,5/16-STF-3,5	1790438	50

Ordering data

Type	Order No.	Pcs. / Pkt.
3.5 mm pitch, color: green		
DFMC 1,5/ 2-ST-3,5-LR	1790483	50
DFMC 1,5/ 3-ST-3,5-LR	1790496	50
DFMC 1,5/ 4-ST-3,5-LR	1790506	50
DFMC 1,5/ 5-ST-3,5-LR	1790519	50
DFMC 1,5/ 6-ST-3,5-LR	1790522	50
DFMC 1,5/ 7-ST-3,5-LR	1790535	50
DFMC 1,5/ 8-ST-3,5-LR	1790548	50
DFMC 1,5/ 9-ST-3,5-LR	1790551	50
DFMC 1,5/10-ST-3,5-LR	1790564	50
DFMC 1,5/11-ST-3,5-LR	1790577	50
DFMC 1,5/12-ST-3,5-LR	1790580	50
DFMC 1,5/13-ST-3,5-LR	1790593	50
DFMC 1,5/14-ST-3,5-LR	1790603	50
DFMC 1,5/15-ST-3,5-LR	1790616	50
DFMC 1,5/16-ST-3,5-LR	1790629	50

Mini plug-in connectors with 3.5/3.81 and 5.08 mm pitch

MINI COMBICON plug-in connectors, pitches 3.5 or 3.81 and 5.08 mm

Two-row headers for reflow processes

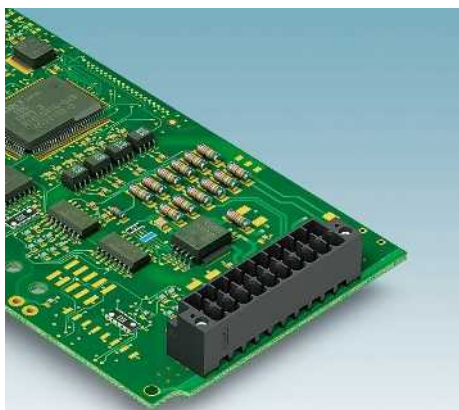

- Extremely small THR two-row headers for SMT and wave soldering processes
- At 8 mm, the distance from the edge of the PCB to the first row of holes is compatible with MC headers
- Headers with flange can be combined with screw-type Lock & Release lever connectors
- Type of packaging: bulk
- Higher numbers of positions up to 20-pos. can be found at: www.phoenixcontact.net/products

Notes:

In accordance with DIN EN 61984, COMBICON plug-in connectors have no switching power. During designated use, they must not be plugged in or disconnected when carrying voltage or under load.

COMBICON select



You will find the possible plug-in connector combinations in COMBICON select at: www.phoenixcontact.net/products or starting on page 182.

Panel cutout dimensions for DMC 1,5 and DMCV 1,5 appear on page 840.



Plug-in direction parallel to the PCB

Accessories

For all types	Type	Page
	Coding profile CP-DMC-THR NAT Order No. 1790647	
	Marker cards SK 3,5/2,8	797

Dimensional drawing

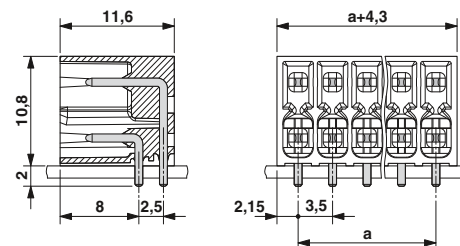

Drilling diagram

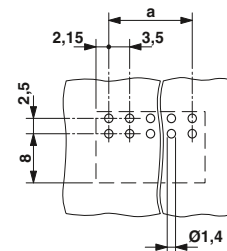

Technical data

Technical data in accordance to IEC / DIN VDE

Rated current	[A]	8
Rated insulation voltage for pollution degree 2	[V]	160
Pitch	[mm]	3.5
Insulation coordination		
Surge voltage category / pollution degree		III / 3 III / 2 II / 2
Rated insulation voltage	[V]	160 160 250
Rated surge voltage	[kV]	2.5 2.5 2.5
Approval data (UL/CUL)	Use Group	B C D
Nominal voltage	[V]	150 - -
Nominal current	[A]	8 - -
Connection capacity AWG	AWG	- - -
Approval data (CSA)	Use Group	B C D
Nominal voltage	[V]	- - -
Nominal current	[A]	- - -
Connection capacity AWG	AWG	- - -
General data		
Type of insulation material / insulation material group		LCP / IIIa
Inflammability class according to UL 94		V0
Drill hole diameter / pin dimensions	[mm]	1.4 / 0,8 x 0,8 mm

No. of pos.	Dim. a [mm]
2	3.50
3	7.00
4	10.50
5	14.00
6	17.50
7	21.00
8	24.50
9	28.00
10	31.50
11	35.00
12	38.50
13	42.00
14	45.50
15	49.00
16	52.50

Ordering data

Type	Order No.	Pcs. / Pkt.
Pitch 3.5 mm, color: Black		
DMC 1,5/ 2-G1-3,5 P20THR	1786837	50
DMC 1,5/ 3-G1-3,5 P20THR	1786840	50
DMC 1,5/ 4-G1-3,5 P20THR	1786853	50
DMC 1,5/ 5-G1-3,5 P20THR	1786866	50
DMC 1,5/ 6-G1-3,5 P20THR	1786879	50
DMC 1,5/ 7-G1-3,5 P20THR	1786882	50
DMC 1,5/ 8-G1-3,5 P20THR	1786895	50
DMC 1,5/ 9-G1-3,5 P20THR	1786905	50
DMC 1,5/10-G1-3,5 P20THR	1786918	50
DMC 1,5/11-G1-3,5 P20THR	1786921	50
DMC 1,5/12-G1-3,5 P20THR	1786934	50
DMC 1,5/13-G1-3,5 P20THR	1786947	50
DMC 1,5/14-G1-3,5 P20THR	1786950	50
DMC 1,5/15-G1-3,5 P20THR	1786963	50
DMC 1,5/16-G1-3,5 P20THR	1786976	50

Mini plug-in connectors with 3.5/3.81 and 5.08 mm pitch

MINI COMBICON plug-in connectors, pitches 3.5 or 3.81 and 5.08 mm



With Lock & Release mechanism and threaded flange, plug-in direction parallel to the PCB



Plug-in direction vertical to the PCB



With Lock & Release mechanism and threaded flange, plug-in direction vertical to the PCB



Dimensional drawing

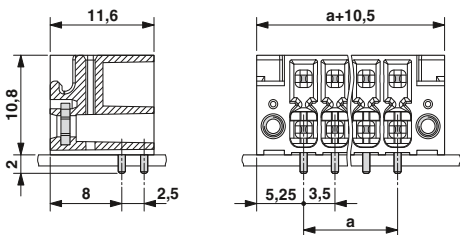

Drilling diagram

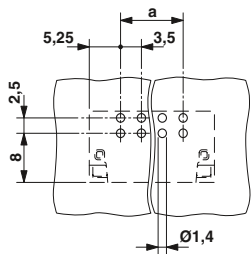

Ordering data

Type	Order No.	Pcs. / Pkt.
Pitch 3.5 mm, color: Black		
DMC 1,5/ 2-G1F-3,5-LR P20THR	1787014	50
DMC 1,5/ 3-G1F-3,5-LR P20THR	1787027	50
DMC 1,5/ 4-G1F-3,5-LR P20THR	1787030	50
DMC 1,5/ 5-G1F-3,5-LR P20THR	1787043	50
DMC 1,5/ 6-G1F-3,5-LR P20THR	1787056	50
DMC 1,5/ 7-G1F-3,5-LR P20THR	1787069	50
DMC 1,5/ 8-G1F-3,5-LR P20THR	1787072	50
DMC 1,5/ 9-G1F-3,5-LR P20THR	1787085	50
DMC 1,5/10-G1F-3,5-LR P20THR	1787098	50
DMC 1,5/11-G1F-3,5-LR P20THR	1787108	50
DMC 1,5/12-G1F-3,5-LR P20THR	1787111	50
DMC 1,5/13-G1F-3,5-LR P20THR	1787124	50
DMC 1,5/14-G1F-3,5-LR P20THR	1787137	50
DMC 1,5/15-G1F-3,5-LR P20THR	1787140	50
DMC 1,5/16-G1F-3,5-LR P20THR	1787153	50



Dimensional drawing

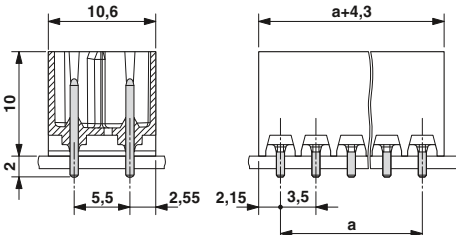

Drilling diagram

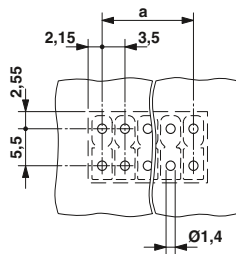

Ordering data

Type	Order No.	Pcs. / Pkt.
Pitch 3.5 mm, color: Black		
DMCV 1,5/ 2-G1-3,5 P20THR	1787205	50
DMCV 1,5/ 3-G1-3,5 P20THR	1787218	50
DMCV 1,5/ 4-G1-3,5 P20THR	1787221	50
DMCV 1,5/ 5-G1-3,5 P20THR	1787234	50
DMCV 1,5/ 6-G1-3,5 P20THR	1787247	50
DMCV 1,5/ 7-G1-3,5 P20THR	1787250	50
DMCV 1,5/ 8-G1-3,5 P20THR	1787263	50
DMCV 1,5/ 9-G1-3,5 P20THR	1787276	50
DMCV 1,5/10-G1-3,5 P20THR	1787289	50
DMCV 1,5/11-G1-3,5 P20THR	1787292	50
DMCV 1,5/12-G1-3,5 P20THR	1787302	50
DMCV 1,5/13-G1-3,5 P20THR	1787315	50
DMCV 1,5/14-G1-3,5 P20THR	1787328	50
DMCV 1,5/15-G1-3,5 P20THR	1787331	50
DMCV 1,5/16-G1-3,5 P20THR	1787344	50



Dimensional drawing

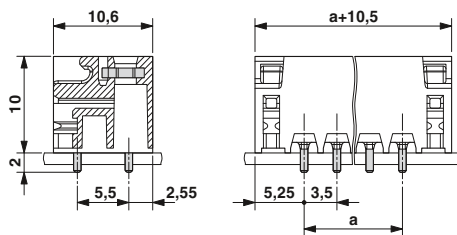

Drilling diagram

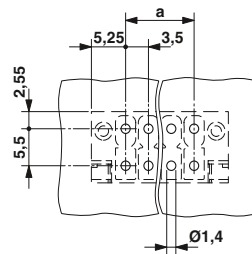

Ordering data

Type	Order No.	Pcs. / Pkt.
Pitch 3.5 mm, color: Black		
DMCV 1,5/ 2-G1F-3,5-LR P20THR	1787399	50
DMCV 1,5/ 3-G1F-3,5-LR P20THR	1787409	50
DMCV 1,5/ 4-G1F-3,5-LR P20THR	1787412	50
DMCV 1,5/ 5-G1F-3,5-LR P20THR	1787425	50
DMCV 1,5/ 6-G1F-3,5-LR P20THR	1787438	50
DMCV 1,5/ 7-G1F-3,5-LR P20THR	1787441	50
DMCV 1,5/ 8-G1F-3,5-LR P20THR	1787454	50
DMCV 1,5/ 9-G1F-3,5-LR P20THR	1787467	50
DMCV 1,5/10-G1F-3,5-LR P20THR	1787470	50
DMCV 1,5/11-G1F-3,5-LR P20THR	1787483	50
DMCV 1,5/12-G1F-3,5-LR P20THR	1787496	50
DMCV 1,5/13-G1F-3,5-LR P20THR	1787506	50
DMCV 1,5/14-G1F-3,5-LR P20THR	1787519	50
DMCV 1,5/15-G1F-3,5-LR P20THR	1787522	50
DMCV 1,5/16-G1F-3,5-LR P20THR	1787535	50

Mini plug-in connectors with 3.5/3.81 and 5.08 mm pitch

MINI COMBICON plug-in connectors, pitches 3.5 or 3.81 and 5.08 mm

Two-row headers for reflow processes

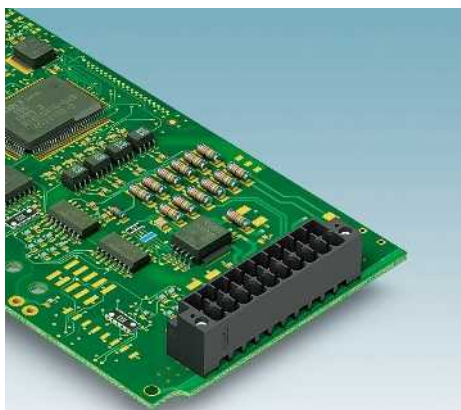

- Tape-on-reel packing according to IEC 60286-3 for automated mounting
- Reel diameter 330 mm
- Tape width corresponds to order designation
- Extremely small THR two-row headers for SMT and wave soldering processes
- At 8 mm, the distance from the edge of the PCB to the first row of holes is compatible with MC headers
- Headers with flange can be combined with screw-type Lock & Release lever connectors

Notes:

In accordance with DIN EN 61984, COMBICON plug-in connectors have no switching power. During designated use, they must not be plugged in or disconnected when carrying voltage or under load.

COMBICON select

You will find the possible plug-in connector combinations in COMBICON select at: www.phoenixcontact.net/products or starting on page 182.



Panel cutout dimensions for DMC 1,5 and DMCV 1,5 appear on page 840.

Pick and place pads for taped THR articles usually protrude beyond the components. The PCB layout must ensure that collisions are avoided when components are assembled. Dimensional drawings of tape reels and place pads can be found online at www.phoenixcontact.net/products.



Plug-in direction parallel to the PCB

Accessories

For all types	Type	Page
	Coding profile CP-DMC-THR NAT Order No. 1790647	
	Marker cards SK 3,5/2,8	797



Dimensional drawing

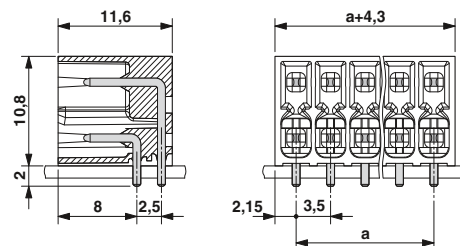

Drilling diagram

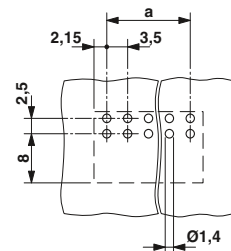

Technical data

Technical data in accordance to IEC / DIN VDE	
Rated current	[A] 8
Rated insulation voltage for pollution degree 2	[V] 160
Pitch	[mm] 3.5
Insulation coordination	
Surge voltage category / pollution degree	III / 3 III / 2 II / 2
Rated insulation voltage	[V] 160 160 250
Rated surge voltage	[kV] 2.5 2.5 2.5
Approval data (UL/CUL)	Use Group B C D
Nominal voltage	[V] 150 - -
Nominal current	[A] 8 - -
Connection capacity AWG	AWG - - -
Approval data (CSA)	Use Group B C D
Nominal voltage	[V] - - -
Nominal current	[A] - - -
Connection capacity AWG	AWG - - -
General data	
Type of insulation material / insulation material group	LCP / IIIa
Inflammability class according to UL 94	V0
Drill hole diameter / pin dimensions	[mm] 1.4 / 0,8 x 0,8 mm

No. of pos.	Dim. a [mm]
2	3.50
3	7.00
4	10.50
5	14.00
6	17.50
7	21.00
8	24.50
9	28.00
10	31.50
11	35.00
12	38.50
13	42.00
14	45.50

Ordering data

Type	Order No.	Pcs. / Pkt.
Pitch 3.5 mm, color: Black		
DMC 1,5/ 2-G1-3,5 P20THR R24-1	1816137	180
DMC 1,5/ 3-G1-3,5 P20THR R24-2	1816140	180
DMC 1,5/ 4-G1-3,5 P20THR R44	1816153	180
DMC 1,5/ 5-G1-3,5 P20THR R44	1816166	180
DMC 1,5/ 6-G1-3,5 P20THR R44	1818478	180
DMC 1,5/ 7-G1-3,5 P20THR R56	1818481	180
DMC 1,5/ 8-G1-3,5 P20THR R56	1816179	180
DMC 1,5/ 9-G1-3,5 P20THR R56	1818494	180
DMC 1,5/10-G1-3,5 P20THR R56	1816182	180
DMC 1,5/11-G1-3,5 P20THR R72	1706049	180
DMC 1,5/12-G1-3,5 P20THR R72	1706051	180
DMC 1,5/13-G1-3,5 P20THR R72	1706052	180
DMC 1,5/14-G1-3,5 P20THR R72	1706054	180

Mini plug-in connectors with 3.5/3.81 and 5.08 mm pitch

MINI COMBICON plug-in connectors, pitches 3.5 or 3.81 and 5.08 mm



N

With Lock & Release mechanism and threaded flange, plug-in direction parallel to the PCB



N

Plug-in direction vertical to the PCB

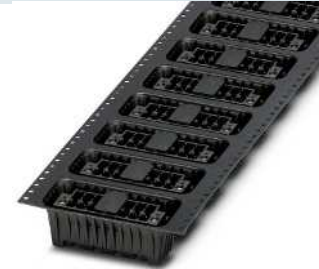

N

With Lock & Release mechanism and threaded flange, plug-in direction vertical to the PCB

Dimensional drawing

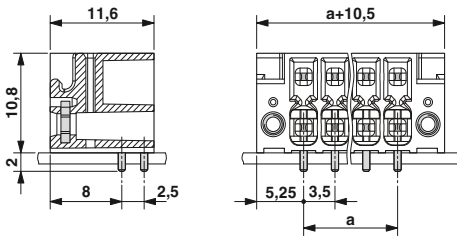

Dimensional drawing

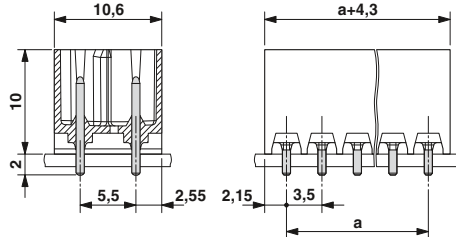

Dimensional drawing

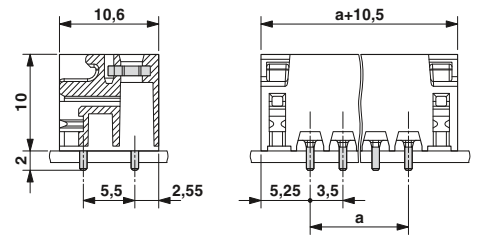

Drilling diagram

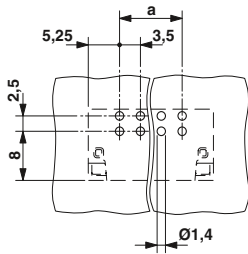

Drilling diagram

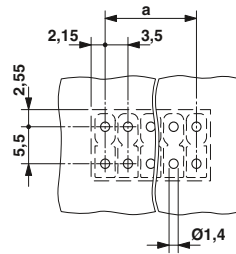

Drilling diagram

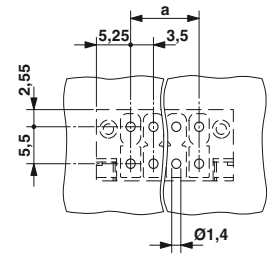

Ordering data

Type	Order No.	Pcs. / Pkt.
Pitch 3.5 mm, color: Black		
DMC 1,5/ 2-G1F-3,5-LRP20THRR44	1818504	180
DMC 1,5/ 3-G1F-3,5-LRP20THRR44	1818517	180
DMC 1,5/ 4-G1F-3,5-LRP20THRR44	1818520	180
DMC 1,5/ 5-G1F-3,5-LRP20THRR56	1818533	180
DMC 1,5/ 6-G1F-3,5-LRP20THRR56	1818546	180
DMC 1,5/ 7-G1F-3,5-LRP20THRR56	1818559	180
DMC 1,5/ 8-G1F-3,5-LRP20THRR56	1818562	180
DMC 1,5/ 9-G1F-3,5-LRP20THRR72	1706055	180
DMC 1,5/10-G1F-3,5-LRP20THRR72	1706064	180
DMC 1,5/11-G1F-3,5-LRP20THRR72	1706065	180
DMC 1,5/12-G1F-3,5-LRP20THRR72	1706067	180

Ordering data

Type	Order No.	Pcs. / Pkt.
Pitch 3.5 mm, color: Black		
DMCV 1,5/ 2-G1-3,5 P20THR R24	1818575	220
DMCV 1,5/ 3-G1-3,5 P20THR R24	1818588	220
DMCV 1,5/ 4-G1-3,5 P20THR R44	1818591	220
DMCV 1,5/ 5-G1-3,5 P20THR R44	1818601	220
DMCV 1,5/ 6-G1-3,5 P20THR R44	1818614	220
DMCV 1,5/ 7-G1-3,5 P20THR R56	1818627	220
DMCV 1,5/ 8-G1-3,5 P20THR R56	1818630	220
DMCV 1,5/ 9-G1-3,5 P20THR R56	1818643	220
DMCV 1,5/10-G1-3,5 P20THR R56	1818656	220
DMCV 1,5/11-G1-3,5 P20THR R72	1818669	220
DMCV 1,5/12-G1-3,5 P20THR R72	1818672	220
DMCV 1,5/13-G1-3,5 P20THR R72	1818685	220
DMCV 1,5/14-G1-3,5 P20THR R72	1818698	220

Ordering data

Type	Order No.	Pcs. / Pkt.
Pitch 3.5 mm, color: Black		
DMCV 1,5/ 2-G1F-3,5-LRP20THRR32	1818708	220
DMCV 1,5/ 3-G1F-3,5-LRP20THRR44	1818711	220
DMCV 1,5/ 4-G1F-3,5-LRP20THRR44	1818724	220
DMCV 1,5/ 5-G1F-3,5-LRP20THRR56	1818737	220
DMCV 1,5/ 6-G1F-3,5-LRP20THRR56	1818740	220
DMCV 1,5/ 7-G1F-3,5-LRP20THRR56	1818753	220
DMCV 1,5/ 8-G1F-3,5-LRP20THRR56	1818766	220
DMCV 1,5/ 9-G1F-3,5-LRP20THRR72	1818779	220
DMCV 1,5/10-G1F-3,5-LRP20THRR72	1818782	220
DMCV 1,5/11-G1F-3,5-LRP20THRR72	1818795	220
DMCV 1,5/12-G1F-3,5-LRP20THRR72	1818805	220

Mini plug-in connectors with 3.5/3.81 and 5.08 mm pitch

MINI COMBICON plug-in connectors, pitches 3.5 or 3.81 and 5.08 mm

Connector with a screw connection



- Flat design of the MC 1,5 connector range
- Generously dimensioned wiring space
- Plug-in direction parallel to the conductor axis
- Versions with and without screw flanges and Lock & Release levers
- Individual position coding by removing the coding tab and connecting the coding profile to the header
- Versions with a pullout aid can be provided; cables can be fixed to the pullout aid using cable binders
- Higher numbers of positions up to 20-pos. can be found at: www.phoenixcontact.net/products

Notes:

In accordance with DIN EN 61984, COMBICON plug-in connectors have no switching power. During designated use, they must not be plugged in or disconnected when carrying voltage or under load.

COMBICON select

You will find the possible plug-in connector combinations in COMBICON select at: www.phoenixcontact.net/products or starting on page 182.

Dimension b:

3 to 4-pos. = 9.9 mm
5 to 7-pos. = 17.2 mm
8 to 9-pos. = 27.9 mm
≥ 10-pos. = 34.7 mm

The maximum torque for the screw flange is 0.3 Nm.

1) Please observe the derating curves. Derating curves of further combination options on request.



Plug with screw connection



Dimensional drawing

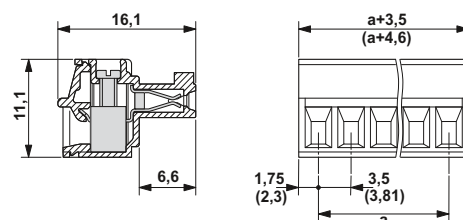

Note derating curves

Derating curves, determined as per DIN EN 61984 (VDE 0627):2002-09
Representation based on DIN EN 60512-5-2:2003-01
Connected conductor cross section = 1.5 mm²
Reduction factor = 0.8
Number of positions = see diagram

Accessories

For all types	Type	Page
	Marker cards SK 3,5/2,8 or SK 3,81/2,8	797
	Screwdriver SZS 0,4 x 2,5 Order No. 1205037	
Only for a 3.81 mm pitch		
	Insertion bridge EBPL...3,81	829

Technical data

Technical data in accordance to IEC / DIN VDE	
Rated current / conductor cross section	[A] / [mm ²]
Rated insulation voltage for pollution degree 2	[V]
Pitch	[mm]
Connection capacity	
Solid / stranded	[mm ²] / [mm ²] / AWG
Stranded with ferrules without plastic sleeve	[mm ²]
Stranded with ferrules with plastic sleeve	[mm ²]
Multi-conductor connection capacity (two conductors with the same cross section)	
Solid / stranded	[mm ²]
Stranded with ferrules without plastic sleeve	[mm ²]
Stranded with TWIN ferrule with plastic sleeve	[mm ²]
Insulation coordination	
Surge voltage category / pollution degree	III / 3 III / 2 II / 2
Rated insulation voltage	[V]
Rated surge voltage	[kV]
Approval data (UL/CUL)	Use Group
Nominal voltage	[V]
Nominal current	[A]
Connection capacity AWG	AWG
Approval data (CSA)	Use Group
Nominal voltage	[V]
Nominal current	[A]
Connection capacity AWG	AWG
General data	
Stripping length	[mm]
Screw thread	
Tightening torque	[Nm]
Type of insulation material / insulation material group	
Inflammability class according to UL 94	

	8 ¹⁾ / 1.5		
	160		
	3.5 / 3.81		
	0.14 - 1.5 / 0.14 - 1.5 / 28 - 16		
	0.25 - 1.5		
	0.25 - 0.5		
	0.08 - 0.5 / 0.08 - 0.75		
	0.25 - 0.34		
	0.5 - 0.5		
	III / 3	III / 2	II / 2
	160	160	320
	2.5	2.5	2.5
	B	C	D
	300	-	300
	8	-	8
	30 - 14	-	30 - 14
	B	C	D
	300	-	300
	8	-	8
	28 - 16	-	28 - 16
	7		
	M2		
	0.22 - 0.25		
	PA / I		
	V0		

Ordering data

Type	Order No.	Pcs. / Pkt.
3.5 mm pitch, color: green		
MC 1,5/ 2-ST-3,5	1840366	50
MC 1,5/ 3-ST-3,5	1840379	50
MC 1,5/ 4-ST-3,5	1840382	50
MC 1,5/ 5-ST-3,5	1840395	50
MC 1,5/ 6-ST-3,5	1840405	50
MC 1,5/ 7-ST-3,5	1840418	50
MC 1,5/ 8-ST-3,5	1840421	50
MC 1,5/ 9-ST-3,5	1840434	50
MC 1,5/10-ST-3,5	1840447	50
MC 1,5/11-ST-3,5	1840450	50
MC 1,5/12-ST-3,5	1840463	50
MC 1,5/13-ST-3,5	1840476	50
MC 1,5/14-ST-3,5	1840489	50
MC 1,5/15-ST-3,5	1840492	50
MC 1,5/16-ST-3,5	1840502	50
Pitch 3.81 mm, color: green		
MC 1,5/ 2-ST-3,81	1803578	50
MC 1,5/ 3-ST-3,81	1803581	50
MC 1,5/ 4-ST-3,81	1803594	50
MC 1,5/ 5-ST-3,81	1803604	50
MC 1,5/ 6-ST-3,81	1803617	50
MC 1,5/ 7-ST-3,81	1803620	50
MC 1,5/ 8-ST-3,81	1803633	50
MC 1,5/ 9-ST-3,81	1803646	50
MC 1,5/10-ST-3,81	1803659	50
MC 1,5/11-ST-3,81	1803662	50
MC 1,5/12-ST-3,81	1803675	50
MC 1,5/13-ST-3,81	1803688	50
MC 1,5/14-ST-3,81	1803691	50
MC 1,5/15-ST-3,81	1803701	50
MC 1,5/16-ST-3,81	1803714	50



With pull-out aid

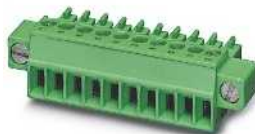

With screw flange



With Lock & Release system



Dimensional drawing

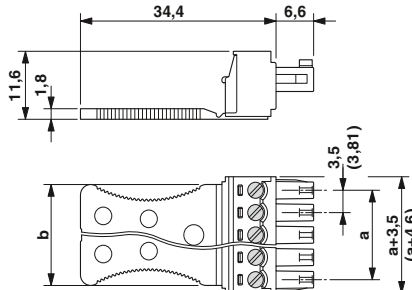

Dimensional drawing

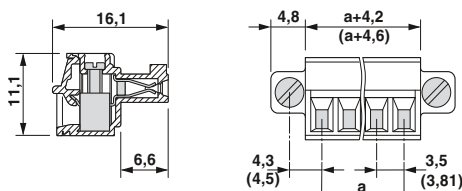

Dimensional drawing

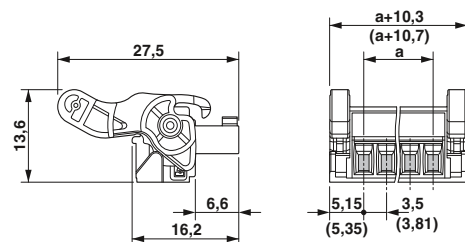

Representative derating curves of the above-mentioned plugs

Type: MC 1,5/...-ST-3.81 with MC 1,5/...-G-3.81

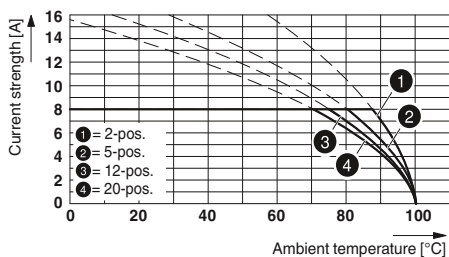

Type: MC 1,5/...-ST-3.81 with MCD 1,5/...-G-3.81

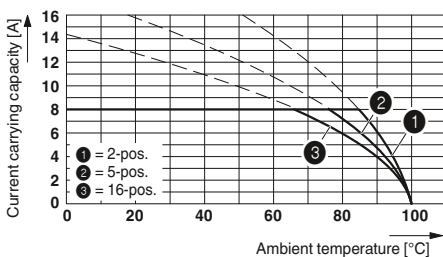

Type: MC 1,5/...-ST-3.81 with SMC 1,5/...-G-3.81

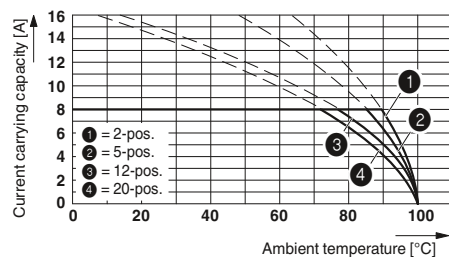

Ordering data

Type	Order No.	Pcs. / Pkt.
3.5 mm pitch, color: green		
MC 1,5/ 3-STZ1-3,5	1768871	50
MC 1,5/ 4-STZ1-3,5	1767500	50
MC 1,5/ 5-STZ2-3,5	1767623	50
MC 1,5/ 6-STZ2-3,5	1767610	50
MC 1,5/ 7-STZ2-3,5	1768884	50
MC 1,5/ 8-STZ3-3,5	1765599	50
MC 1,5/ 9-STZ3-3,5	1768897	50
MC 1,5/10-STZ4-3,5	1766255	50
MC 1,5/11-STZ4-3,5	1768907	50
MC 1,5/12-STZ4-3,5	1768910	50

Ordering data

Type	Order No.	Pcs. / Pkt.
3.5 mm pitch, color: green		
MC 1,5/ 2-STF-3,5	1847055	50
MC 1,5/ 3-STF-3,5	1847068	50
MC 1,5/ 4-STF-3,5	1847071	50
MC 1,5/ 5-STF-3,5	1847084	50
MC 1,5/ 6-STF-3,5	1847097	50
MC 1,5/ 7-STF-3,5	1847107	50
MC 1,5/ 8-STF-3,5	1847181	50
MC 1,5/ 9-STF-3,5	1847194	50
MC 1,5/10-STF-3,5	1847204	50
MC 1,5/11-STF-3,5	1847217	50
MC 1,5/12-STF-3,5	1847220	50
MC 1,5/13-STF-3,5	1847233	50
MC 1,5/14-STF-3,5	1847246	50
MC 1,5/15-STF-3,5	1847259	50
MC 1,5/16-STF-3,5	1847262	50

Ordering data

Type	Order No.	Pcs. / Pkt.
3.5 mm pitch, color: green		
MC 1,5/ 2-ST-3,5-LR	1816852	50
MC 1,5/ 3-ST-3,5-LR	1816865	50
MC 1,5/ 4-ST-3,5-LR	1816878	50
MC 1,5/ 5-ST-3,5-LR	1816881	50
MC 1,5/ 6-ST-3,5-LR	1816894	50
MC 1,5/ 7-ST-3,5-LR	1816904	50
MC 1,5/ 8-ST-3,5-LR	1816917	50
MC 1,5/ 9-ST-3,5-LR	1816920	50
MC 1,5/10-ST-3,5-LR	1816933	50
MC 1,5/11-ST-3,5-LR	1816946	50
MC 1,5/12-ST-3,5-LR	1816959	50
MC 1,5/13-ST-3,5-LR	1816962	50
MC 1,5/14-ST-3,5-LR	1816975	50
MC 1,5/15-ST-3,5-LR	1816988	50
MC 1,5/16-ST-3,5-LR	1816991	50

Pitch 3.81 mm, color: green		
MC 1,5/ 3-STZ1-3,81	1768923	50
MC 1,5/ 4-STZ1-3,81	1767461	50
MC 1,5/ 5-STZ2-3,81	1768936	50
MC 1,5/ 6-STZ2-3,81	1767694	50
MC 1,5/ 7-STZ2-3,81	1768949	50
MC 1,5/ 8-STZ3-3,81	1768952	50
MC 1,5/ 9-STZ3-3,81	1767665	50
MC 1,5/10-STZ4-3,81	1767209	50
MC 1,5/11-STZ4-3,81	1768965	50
MC 1,5/12-STZ4-3,81	1768978	50
MC 1,5/13-STZ4-3,81	1765557	50

Pitch 3.81 mm, color: green		
MC 1,5/ 2-STF-3,81	1827703	50
MC 1,5/ 3-STF-3,81	1827716	50
MC 1,5/ 4-STF-3,81	1827729	50
MC 1,5/ 5-STF-3,81	1827732	50
MC 1,5/ 6-STF-3,81	1827745	50
MC 1,5/ 7-STF-3,81	1827758	50
MC 1,5/ 8-STF-3,81	1827761	50
MC 1,5/ 9-STF-3,81	1827774	50
MC 1,5/10-STF-3,81	1827787	50
MC 1,5/11-STF-3,81	1827790	50
MC 1,5/12-STF-3,81	1827803	50
MC 1,5/13-STF-3,81	1827813	50
MC 1,5/14-STF-3,81	1827826	50
MC 1,5/15-STF-3,81	1827839	50
MC 1,5/16-STF-3,81	1827842	50

Pitch 3.81 mm, color: green		
MC 1,5/ 2-ST-3,81-LR	1817042	50
MC 1,5/ 3-ST-3,81-LR	1817055	50
MC 1,5/ 4-ST-3,81-LR	1817068	50
MC 1,5/ 5-ST-3,81-LR	1817071	50
MC 1,5/ 6-ST-3,81-LR	1817084	50
MC 1,5/ 7-ST-3,81-LR	1817097	50
MC 1,5/ 8-ST-3,81-LR	1817107	50
MC 1,5/ 9-ST-3,81-LR	1817110	50
MC 1,5/10-ST-3,81-LR	1817123	50
MC 1,5/11-ST-3,81-LR	1817136	50
MC 1,5/12-ST-3,81-LR	1817149	50
MC 1,5/13-ST-3,81-LR	1817152	50
MC 1,5/14-ST-3,81-LR	1817165	50
MC 1,5/15-ST-3,81-LR	1817178	50
MC 1,5/16-ST-3,81-LR	1817181	50

Mini plug-in connectors with 3.5/3.81 and 5.08 mm pitch

MINI COMBICON plug-in connectors, pitches 3.5 or 3.81 and 5.08 mm

Connector with a screw connection

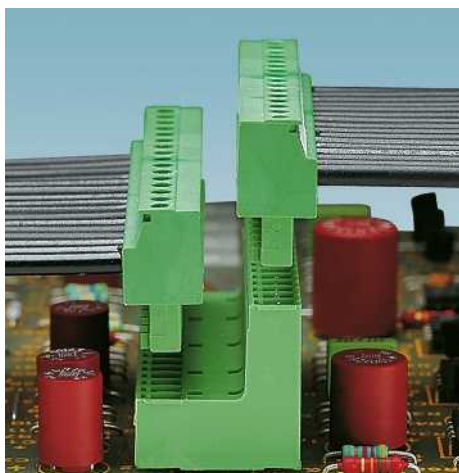

- Plugs for vertical plug-in direction
- Compact dimensions of the MCV 1,5 connector range
- Generously dimensioned wiring space
- Versions with and without a screw flange
- Individual position coding by removing the coding tab and connecting the coding profile to the header

Notes:

In accordance with DIN EN 61984, COMBICON plug-in connectors have no switching power. During designated use, they must not be plugged in or disconnected when carrying voltage or under load.

COMBICON select

You will find the possible plug-in connector combinations in COMBICON select at: www.phoenixcontact.net/products or starting on page 182.



The maximum torque for the screw flange is 0.3 Nm.

¹⁾ Derating curves on request.



Conductor entry facing coding side

Accessories

For all types	Type	Page
	Marker cards SK 3,5/2,8 or SK 3,81/2,8	797
	Screwdriver SZS 0,4 x 2,5 Order No. 1205037	
Only for a 3.81 mm pitch		
	Insertion bridge EBPL...-3,81	829



Dimensional drawing

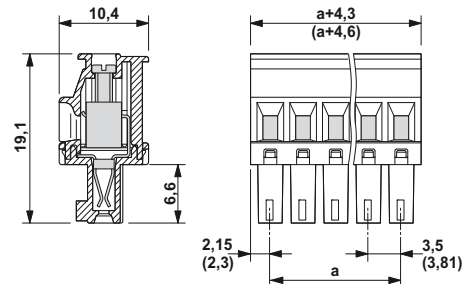

Technical data

Technical data in accordance to IEC / DIN VDE	
Rated current / conductor cross section	[A] / [mm ²]
Rated insulation voltage for pollution degree 2	[V]
Pitch	[mm]
Connection capacity	
Solid / stranded	[mm ²] / [mm ²] / AWG
Stranded with ferrules without plastic sleeve	[mm ²]
Stranded with ferrules with plastic sleeve	[mm ²]
Multi-conductor connection capacity (two conductors with the same cross section)	
Solid / stranded	[mm ²]
Stranded with ferrules without plastic sleeve	[mm ²]
Stranded with TWIN ferrule with plastic sleeve	[mm ²]
Insulation coordination	
Surge voltage category / pollution degree	
Rated insulation voltage	[V]
Rated surge voltage	[kV]
Approval data (UL/CUL)	Use Group
Nominal voltage	[V]
Nominal current	[A]
Connection capacity AWG	AWG
Approval data (CSA)	Use Group
Nominal voltage	[V]
Nominal current	[A]
Connection capacity AWG	AWG
General data	
Stripping length	[mm]
Screw thread	
Tightening torque	[Nm]
Type of insulation material / insulation material group	
Inflammability class according to UL 94	

	8 ¹⁾ / 1.5		
	160		
	3.5 / 3.81		
	0.14 - 1.5 / 0.14 - 1.5 / 28 - 16		
	0.25 - 1.5		
	0.25 - 0.5		
	0.08 - 0.5 / 0.08 - 0.75		
	0.25 - 0.34		
	0.5 - 0.5		
	III / 3	III / 2	II / 2
	160	160	320
	2.5	2.5	2.5
	B	C	D
	300	-	300
	8	-	8
	30 - 14	-	30 - 14
	B	C	D
	-	-	-
	-	-	-
	-	-	-
	7		
	M2		
	0.22 - 0.25		
	PA / I		
	V0		

No. of pos.	Dim. a [mm]
2	3.50
3	7.00
4	10.50
5	14.00
6	17.50
7	21.00
8	24.50
9	28.00
10	31.50
11	35.00
12	38.50
13	42.00
14	45.50
15	49.00
16	52.50
2	3.81
3	7.62
4	11.43
5	15.24
6	19.05
7	22.86
8	26.67
9	30.48
10	34.29
11	38.10
12	41.91
13	45.72
14	49.53
15	53.34
16	57.15

Ordering data

Type	Order No.	Pcs. / Pkt.
3.5 mm pitch, color: green		
MCVR 1,5/ 2-ST-3,5	1863152	50
MCVR 1,5/ 3-ST-3,5	1863165	50
MCVR 1,5/ 4-ST-3,5	1863178	50
MCVR 1,5/ 5-ST-3,5	1863181	50
MCVR 1,5/ 6-ST-3,5	1863194	50
MCVR 1,5/ 7-ST-3,5	1863204	50
MCVR 1,5/ 8-ST-3,5	1863217	50
MCVR 1,5/ 9-ST-3,5	1863220	50
MCVR 1,5/10-ST-3,5	1863233	50
MCVR 1,5/11-ST-3,5	1863246	50
MCVR 1,5/12-ST-3,5	1863259	50
MCVR 1,5/13-ST-3,5	1863262	50
MCVR 1,5/14-ST-3,5	1863275	50
MCVR 1,5/15-ST-3,5	1863288	50
MCVR 1,5/16-ST-3,5	1863291	50
Pitch 3.81 mm, color: green		
MCVR 1,5/ 2-ST-3,81	1827127	50
MCVR 1,5/ 3-ST-3,81	1827130	50
MCVR 1,5/ 4-ST-3,81	1827143	50
MCVR 1,5/ 5-ST-3,81	1827156	50
MCVR 1,5/ 6-ST-3,81	1827169	50
MCVR 1,5/ 7-ST-3,81	1827172	50
MCVR 1,5/ 8-ST-3,81	1827185	50
MCVR 1,5/ 9-ST-3,81	1827198	50
MCVR 1,5/10-ST-3,81	1827208	50
MCVR 1,5/11-ST-3,81	1827211	50
MCVR 1,5/12-ST-3,81	1827224	50
MCVR 1,5/13-ST-3,81	1827237	50
MCVR 1,5/14-ST-3,81	1827240	50
MCVR 1,5/15-ST-3,81	1827253	50
MCVR 1,5/16-ST-3,81	1827266	50



Conductor entry facing coding side, with screw flange



Conductor entry facing rippled side



Conductor entry facing rippled side, with screw flange



Dimensional drawing

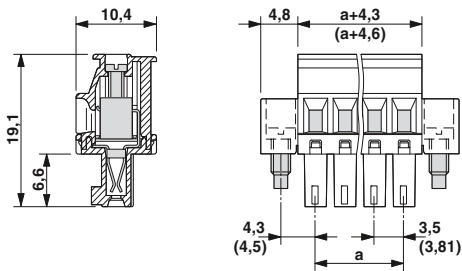

Dimensional drawing

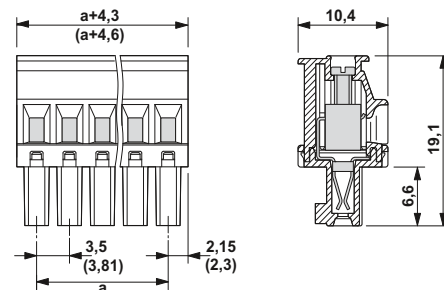

Dimensional drawing

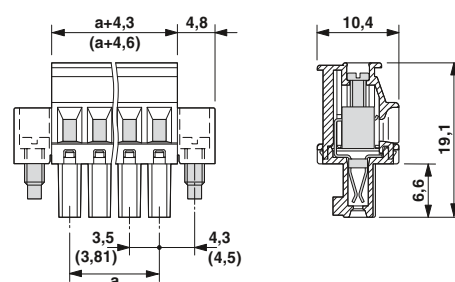

Ordering data

Type	Order No.	Pcs. / Pkt.
3.5 mm pitch, color: green		
MCVR 1,5/ 2-STF-3,5	1863301	50
MCVR 1,5/ 3-STF-3,5	1863314	50
MCVR 1,5/ 4-STF-3,5	1863327	50
MCVR 1,5/ 5-STF-3,5	1863330	50
MCVR 1,5/ 6-STF-3,5	1863343	50
MCVR 1,5/ 7-STF-3,5	1863356	50
MCVR 1,5/ 8-STF-3,5	1863369	50
MCVR 1,5/ 9-STF-3,5	1863372	50
MCVR 1,5/10-STF-3,5	1863385	50
MCVR 1,5/11-STF-3,5	1863398	50
MCVR 1,5/12-STF-3,5	1863408	50
MCVR 1,5/13-STF-3,5	1863411	50
MCVR 1,5/14-STF-3,5	1863424	50
MCVR 1,5/15-STF-3,5	1863437	50
MCVR 1,5/16-STF-3,5	1863440	50
Pitch 3.81 mm, color: green		
MCVR 1,5/ 2-STF-3,81	1828346	50
MCVR 1,5/ 3-STF-3,81	1828359	50
MCVR 1,5/ 4-STF-3,81	1828362	50
MCVR 1,5/ 5-STF-3,81	1828375	50
MCVR 1,5/ 6-STF-3,81	1828388	50
MCVR 1,5/ 7-STF-3,81	1828391	50
MCVR 1,5/ 8-STF-3,81	1828401	50
MCVR 1,5/ 9-STF-3,81	1828414	50
MCVR 1,5/10-STF-3,81	1828427	50
MCVR 1,5/11-STF-3,81	1828430	50
MCVR 1,5/12-STF-3,81	1828443	50
MCVR 1,5/13-STF-3,81	1828456	50
MCVR 1,5/14-STF-3,81	1828469	50
MCVR 1,5/15-STF-3,81	1828472	50
MCVR 1,5/16-STF-3,81	1828485	50

Ordering data

Type	Order No.	Pcs. / Pkt.
3.5 mm pitch, color: green		
MCVW 1,5/ 2-ST-3,5	1862852	50
MCVW 1,5/ 3-ST-3,5	1862865	50
MCVW 1,5/ 4-ST-3,5	1862878	50
MCVW 1,5/ 5-ST-3,5	1862881	50
MCVW 1,5/ 6-ST-3,5	1862894	50
MCVW 1,5/ 7-ST-3,5	1862904	50
MCVW 1,5/ 8-ST-3,5	1862917	50
MCVW 1,5/ 9-ST-3,5	1862920	50
MCVW 1,5/10-ST-3,5	1862933	50
MCVW 1,5/11-ST-3,5	1862946	50
MCVW 1,5/12-ST-3,5	1862959	50
MCVW 1,5/13-ST-3,5	1862962	50
MCVW 1,5/14-ST-3,5	1862975	50
MCVW 1,5/15-ST-3,5	1862988	50
MCVW 1,5/16-ST-3,5	1862991	50
Pitch 3.81 mm, color: green		
MCVW 1,5/ 2-ST-3,81	1826979	50
MCVW 1,5/ 3-ST-3,81	1826982	50
MCVW 1,5/ 4-ST-3,81	1826995	50
MCVW 1,5/ 5-ST-3,81	1827004	50
MCVW 1,5/ 6-ST-3,81	1827017	50
MCVW 1,5/ 7-ST-3,81	1827020	50
MCVW 1,5/ 8-ST-3,81	1827033	50
MCVW 1,5/ 9-ST-3,81	1827046	50
MCVW 1,5/10-ST-3,81	1827059	50
MCVW 1,5/11-ST-3,81	1827062	50
MCVW 1,5/12-ST-3,81	1827075	50
MCVW 1,5/13-ST-3,81	1827088	50
MCVW 1,5/14-ST-3,81	1827091	50
MCVW 1,5/15-ST-3,81	1827101	50
MCVW 1,5/16-ST-3,81	1827114	50

Ordering data

Type	Order No.	Pcs. / Pkt.
3.5 mm pitch, color: green		
MCVW 1,5/ 2-STF-3,5	1863000	50
MCVW 1,5/ 3-STF-3,5	1863013	50
MCVW 1,5/ 4-STF-3,5	1863026	50
MCVW 1,5/ 5-STF-3,5	1863039	50
MCVW 1,5/ 6-STF-3,5	1863042	50
MCVW 1,5/ 7-STF-3,5	1863055	50
MCVW 1,5/ 8-STF-3,5	1863068	50
MCVW 1,5/ 9-STF-3,5	1863071	50
MCVW 1,5/10-STF-3,5	1863084	50
MCVW 1,5/11-STF-3,5	1863097	50
MCVW 1,5/12-STF-3,5	1863107	50
MCVW 1,5/13-STF-3,5	1863110	50
MCVW 1,5/14-STF-3,5	1863123	50
MCVW 1,5/15-STF-3,5	1863136	50
MCVW 1,5/16-STF-3,5	1863149	50
Pitch 3.81 mm, color: green		
MCVW 1,5/ 2-STF-3,81	1828498	50
MCVW 1,5/ 3-STF-3,81	1828508	50
MCVW 1,5/ 4-STF-3,81	1828511	50
MCVW 1,5/ 5-STF-3,81	1828524	50
MCVW 1,5/ 6-STF-3,81	1828537	50
MCVW 1,5/ 7-STF-3,81	1828540	50
MCVW 1,5/ 8-STF-3,81	1828553	50
MCVW 1,5/ 9-STF-3,81	1828566	50
MCVW 1,5/10-STF-3,81	1828579	50
MCVW 1,5/11-STF-3,81	1828582	50
MCVW 1,5/12-STF-3,81	1828595	50
MCVW 1,5/13-STF-3,81	1828605	50
MCVW 1,5/14-STF-3,81	1828618	50
MCVW 1,5/15-STF-3,81	1828621	50
MCVW 1,5/16-STF-3,81	1828634	50

Mini plug-in connectors with 3.5/3.81 and 5.08 mm pitch

MINI COMBICON plug-in connectors, pitches 3.5 or 3.81 and 5.08 mm

Connector with a screw connection



- Plugs with front screw connection
- Pitch: 3.81 mm
- Screwdriver axis parallel to the conductor axis
- Generously dimensioned wiring space
- Individual position coding by removing the coding tab and connecting the coding profile to the header
- Versions with and without a screw flange
- Higher numbers of positions up to 20-pos. can be found at: www.phoenixcontact.net/products

Notes:

In accordance with DIN EN 61984, COMBICON plug-in connectors have no switching power. During designated use, they must not be plugged in or disconnected when carrying voltage or under load.

COMBICON select

You will find the possible plug-in connector combinations in COMBICON select at: www.phoenixcontact.net/products or starting on page 182.



The maximum torque for the screw flange is 0.3 Nm.

¹⁾ Please observe the derating curves. Derating curves of further combination options on request.



With front screw connection

Accessories

For all types	Type	Page
	Marker cards SK 3,5/2,8 or SK 3,81/2,8	797
	Screwdriver SZS 0,4 x 2,5 Order No. 1205037	
	Insertion bridge EBPL...-3,81	829



Dimensional drawing

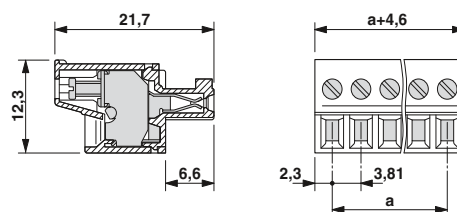

Note derating curves

Derating curves, determined as per DIN EN 61984 (VDE 0627):2002-09
Representation based on DIN EN 60512-5-2:2003-01
Connected conductor cross section = 1.5 mm²
Reduction factor = 0.8
Number of positions = see diagram

Technical data

Technical data in accordance to IEC / DIN VDE

Rated current / conductor cross section [A] / [mm²]

Rated insulation voltage for pollution degree 2 [V]

Pitch [mm]

Connection capacity

Solid / stranded [mm²] / [mm²] / AWG

Stranded with ferrules without plastic sleeve [mm²]

Stranded with ferrules with plastic sleeve [mm²]

Multi-conductor connection capacity (two conductors with the same cross section)

Solid / stranded [mm²]

Stranded with ferrules without plastic sleeve [mm²]

Stranded with TWIN ferrule with plastic sleeve [mm²]

Insulation coordination

Surge voltage category / pollution degree

Rated insulation voltage [V]

Rated surge voltage [kV]

Approval data (UL/CUL) Use Group

Nominal voltage [V]

Nominal current [A]

Connection capacity AWG

Approval data (CSA) Use Group

Nominal voltage [V]

Nominal current [A]

Connection capacity AWG

General data

Stripping length [mm]

Screw thread

Tightening torque [Nm]

Type of insulation material / insulation material group

Inflammability class according to UL 94

8¹⁾ / 1.5

160

3.81

0.14 - 1.5 / 0.14 - 1.5 / 28 - 16

0.25 - 1.5

0.25 - 0.5

0.14 - 0.5 / 0.14 - 0.75

0.25 - 0.34

0.5 - 0.5

III / 3 III / 2 II / 2

160 160 320

2.5 2.5 2.5

B C D

300 - 300

8 - 8

30 - 16 - 30 - 16

B C D

300 - 300

8 - 8

28 - 16 - 28 - 16

9

M2

0.22 - 0.25

PA / I

V0

No. of pos.

Dim. a [mm]

2 3.81

3 7.62

4 11.43

5 15.24

6 19.05

7 22.86

8 26.67

9 30.48

10 34.29

11 38.10

12 41.91

13 45.72

14 49.53

15 53.34

16 57.18

Ordering data

Type

Pitch 3.81 mm, color: green

Order No.

Pcs. / Pkt.

FRONT-MC 1,5/ 2-ST-3,81 1850660 50

FRONT-MC 1,5/ 3-ST-3,81 1850673 50

FRONT-MC 1,5/ 4-ST-3,81 1850686 50

FRONT-MC 1,5/ 5-ST-3,81 1850699 50

FRONT-MC 1,5/ 6-ST-3,81 1850709 50

FRONT-MC 1,5/ 7-ST-3,81 1850712 50

FRONT-MC 1,5/ 8-ST-3,81 1850725 50

FRONT-MC 1,5/ 9-ST-3,81 1850738 50

FRONT-MC 1,5/10-ST-3,81 1850741 50

FRONT-MC 1,5/11-ST-3,81 1850754 50

FRONT-MC 1,5/12-ST-3,81 1850767 50

FRONT-MC 1,5/13-ST-3,81 1850770 50

FRONT-MC 1,5/14-ST-3,81 1850783 50

FRONT-MC 1,5/15-ST-3,81 1850796 50

FRONT-MC 1,5/16-ST-3,81 1850806 50



With front screw connection
and screw flange



Dimensional drawing

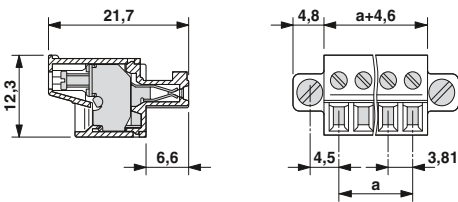

Representative derating curve

Type: FRONT-MC 1,5/...-ST-3,81 with MC 1,5/...-G-3,81

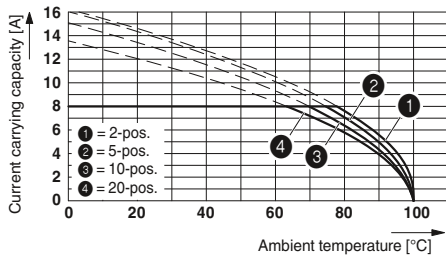

Ordering data

Type	Order No.	Pcs. / Pkt.
Pitch 3.81 mm, color: green		
FRONT-MC 1,5/ 2-STF-3,81	1850851	50
FRONT-MC 1,5/ 3-STF-3,81	1850864	50
FRONT-MC 1,5/ 4-STF-3,81	1850877	50
FRONT-MC 1,5/ 5-STF-3,81	1850880	50
FRONT-MC 1,5/ 6-STF-3,81	1850893	50
FRONT-MC 1,5/ 7-STF-3,81	1850903	50
FRONT-MC 1,5/ 8-STF-3,81	1850916	50
FRONT-MC 1,5/ 9-STF-3,81	1850929	50
FRONT-MC 1,5/10-STF-3,81	1850932	50
FRONT-MC 1,5/11-STF-3,81	1850945	50
FRONT-MC 1,5/12-STF-3,81	1850958	50
FRONT-MC 1,5/13-STF-3,81	1850961	50
FRONT-MC 1,5/14-STF-3,81	1850974	50
FRONT-MC 1,5/15-STF-3,81	1850987	50
FRONT-MC 1,5/16-STF-3,81	1850990	50

Mini plug-in connectors with 3.5/3.81 and 5.08 mm pitch

MINI COMBICON plug-in connectors, pitches 3.5 or 3.81 and 5.08 mm

Inverted connectors with a screw connection

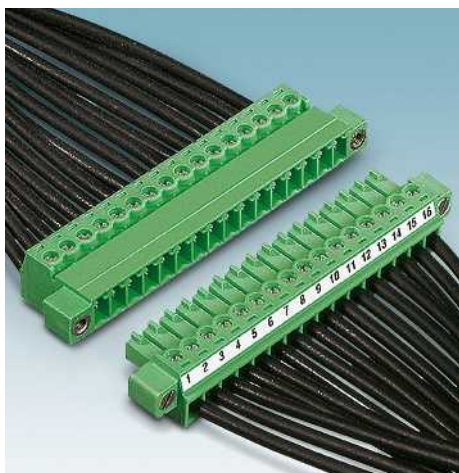

- Use in contact protected applications
- Combination options with MC 1,5 connectors for free hanging connections
- Pitch: 3.81 mm
- Combination options with IMC headers for a clear separation of PCB inputs/outputs
- Individual position coding by connecting the coding profile to the inverted connector and by removing the coding tab on the counterpart
- Versions with and without a threaded flange

Notes:

In accordance with DIN EN 61984, COMBICON plug-in connectors have no switching power. During designated use, they must not be plugged in or disconnected when carrying voltage or under load.

COMBICON select

You will find the possible plug-in connector combinations in COMBICON select at: www.phoenixcontact.net/products or starting on page 182.

The maximum torque for the screw flange is 0.3 Nm.

¹⁾ Please observe the derating curves. Derating curves of further combination options on request.



Inverted plug with screw connection



Dimensional drawing

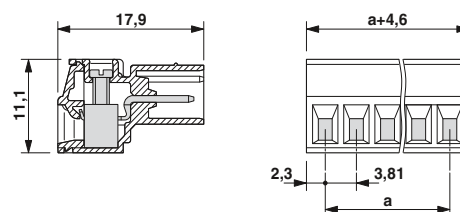

Note derating curves

Derating curves, determined as per DIN EN 61984 (VDE 0627):2002-09
Representation based on DIN EN 60512-5-2:2003-01
Connected conductor cross section = 1.5 mm²
Reduction factor = 0.8
Number of positions = see diagram

Accessories

For all types	Type	Page
	Coding profile CP-MSTB Order No. 1734634	38
	Screwdriver SZS 0,4 x 2,5 Order No. 1205037	
	Marker cards SK 3,81/2,8	797
	Insertion bridge EBPL...-3,81	829

Technical data

Technical data in accordance to IEC / DIN VDE	
Rated current / conductor cross section	[A] / [mm ²]
Rated insulation voltage for pollution degree 2	[V]
Pitch	[mm]
Connection capacity	
Solid / stranded	[mm ²] / [mm ²] / AWG
Stranded with ferrules without plastic sleeve	[mm ²]
Stranded with ferrules with plastic sleeve	[mm ²]
Multi-conductor connection capacity (two conductors with the same cross section)	
Solid / stranded	[mm ²]
Stranded with ferrules without plastic sleeve	[mm ²]
Stranded with TWIN ferrule with plastic sleeve	[mm ²]
Insulation coordination	
Surge voltage category / pollution degree	III / 3 III / 2 II / 2
Rated insulation voltage	[V]
Rated surge voltage	[kV]
Approval data (UL/CUL)	Use Group
Nominal voltage	[V]
Nominal current	[A]
Connection capacity AWG	AWG
Approval data (CSA)	Use Group
Nominal voltage	[V]
Nominal current	[A]
Connection capacity AWG	AWG
General data	
Stripping length	[mm]
Screw thread	
Tightening torque	[Nm]
Type of insulation material / insulation material group	
Inflammability class according to UL 94	

	8 ¹⁾ / 1.5	
	160	
	3.81	
	0.14 - 1.5 / 0.14 - 1.5 / 28 - 16	
	0.25 - 1.5	
	0.25 - 0.5	
	0.08 - 0.5 / 0.08 - 0.75	
	0.2 - 0.34	
	0.5 - 0.5	
	III / 3	III / 2 II / 2
	160	160 320
	2.5	2.5 2.5
	B	C D
	300	- 300
	8	- 8
	30 - 14	- 30 - 14
	B	C D
	-	- -
	-	- -
	-	- -
	7	
	M2	
	0.22 - 0.25	
	PA / I	
	V0	

Ordering data

No. of pos.	Dim. a [mm]	Type	Order No.	Pcs. / Pkt.
Pitch 3.81 mm, color: green				
2	3.81	IMC 1,5/ 2-ST-3,81	1857883	50
3	7.62	IMC 1,5/ 3-ST-3,81	1857896	50
4	11.43	IMC 1,5/ 4-ST-3,81	1857906	50
5	15.24	IMC 1,5/ 5-ST-3,81	1857919	50
6	19.05	IMC 1,5/ 6-ST-3,81	1857922	50
7	22.86	IMC 1,5/ 7-ST-3,81	1857935	50
8	26.67	IMC 1,5/ 8-ST-3,81	1857948	50
9	30.48	IMC 1,5/ 9-ST-3,81	1857951	50
10	34.29	IMC 1,5/10-ST-3,81	1857964	50
11	38.10	IMC 1,5/11-ST-3,81	1857977	50
12	41.91	IMC 1,5/12-ST-3,81	1857980	50
13	45.72	IMC 1,5/13-ST-3,81	1857993	50
14	49.53	IMC 1,5/14-ST-3,81	1858002	50
15	53.34	IMC 1,5/15-ST-3,81	1858015	50
16	57.15	IMC 1,5/16-ST-3,81	1858028	50



With threaded flange for screw connection
 with MC plugs



Dimensional drawing

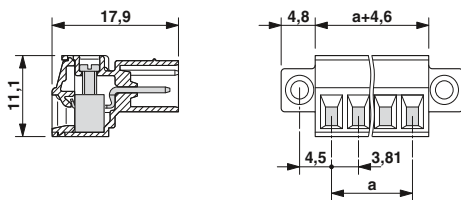

Representative derating curve

Type: IMC 1,5/...-ST-3,81 with IMC 1,5/...-G-3,81

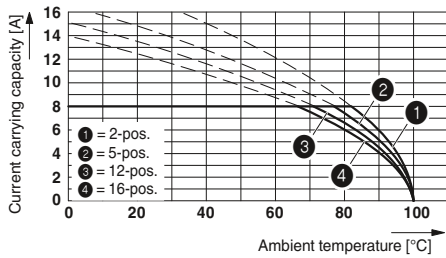

Ordering data

Type	Order No.	Pcs. / Pkt.
Pitch 3.81 mm, color: green		
IMC 1,5/ 2-STGF-3,81	1858031	50
IMC 1,5/ 3-STGF-3,81	1858044	50
IMC 1,5/ 4-STGF-3,81	1858057	50
IMC 1,5/ 5-STGF-3,81	1858060	50
IMC 1,5/ 6-STGF-3,81	1858073	50
IMC 1,5/ 7-STGF-3,81	1858086	50
IMC 1,5/ 8-STGF-3,81	1858099	50
IMC 1,5/ 9-STGF-3,81	1858109	50
IMC 1,5/10-STGF-3,81	1858112	50
IMC 1,5/11-STGF-3,81	1858125	50
IMC 1,5/12-STGF-3,81	1858138	50
IMC 1,5/13-STGF-3,81	1858141	50
IMC 1,5/14-STGF-3,81	1858154	50
IMC 1,5/15-STGF-3,81	1858167	50
IMC 1,5/16-STGF-3,81	1858170	50

Mini plug-in connectors with 3.5/3.81 and 5.08 mm pitch

MINI COMBICON plug-in connectors, pitches 3.5 or 3.81 and 5.08 mm

Plug with push-in spring connection

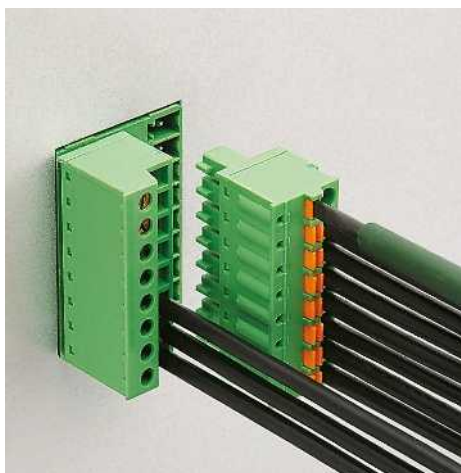

- Different combination options with MC headers with a 3.5/3.81 pitch
- Fast conductor connection, thanks to push-in spring connection
- Convenient operation of the terminal point using a screwdriver
- Test connection to accommodate 1.2 mm Ø test pins or 1 mm Ø test connectors
- Versions with and without a screw flange
- Versions with Lock & Release system
- Higher numbers of positions up to 20-pos. can be found at: www.phoenixcontact.net/products

Notes:

In accordance with DIN EN 61984, COMBICON plug-in connectors have no switching power. During designated use, they must not be plugged in or disconnected when carrying voltage or under load.

COMBICON select

You will find the possible plug-in connector combinations in COMBICON select at: www.phoenixcontact.net/products or starting on page 182.

The maximum torque for the screw flange is 0.3 Nm.

1) Please observe the derating curves. Derating curves of further combination options on request.

2) Use of ferrules with stripping length $L_2 = 10$ mm



Plug with push-in spring connection



Dimensional drawing

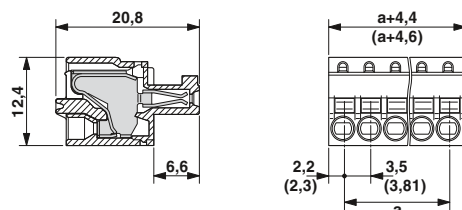

Note derating curves

Derating curves, determined as per DIN EN 61984 (VDE 0627):2002-09
Representation based on DIN EN 60512-5-2:2003-01
Connected conductor cross section = 1.5 mm²
Reduction factor = 0.8
Number of positions = see diagram

Accessories

For all types	Type	Page
	Screwdriver SZS 0,4 x 2,5 Order No. 1205037	
	Marker cards SK 3,5/2,8 or SK 3,81/2,8	797
	Ferrules with and without plastic sleeve	834
	Crimping pliers for 0.25 to 6 mm ² CRIMPFOX 6 Order No. 1212034	
	Test plug MPS-MT 1-S Order No. 1944372	831

Technical data

Technical data in accordance to IEC / DIN VDE	
Rated current / conductor cross section	[A] / [mm ²]
Rated insulation voltage for pollution degree 2	[V]
Pitch	[mm]
Connection capacity	
Solid / stranded	[mm ²] / [mm ²] / AWG
Stranded with ferrules without plastic sleeve	[mm ²]
Stranded with ferrules with plastic sleeve	[mm ²]
Multi-conductor connection capacity (two conductors with the same cross section)	
Solid / stranded	[mm ²]
Stranded with ferrules without plastic sleeve	[mm ²]
Stranded with TWIN ferrule with plastic sleeve	[mm ²]
Insulation coordination	
Surge voltage category / pollution degree	III / 3 III / 2 II / 2
Rated insulation voltage	[V]
Rated surge voltage	[kV]
Approval data (UL/CUL)	Use Group
Nominal voltage	[V]
Nominal current	[A]
Connection capacity AWG	AWG
Approval data (CSA)	Use Group
Nominal voltage	[V]
Nominal current	[A]
Connection capacity AWG	AWG
General data	
Stripping length	[mm]
Type of insulation material / insulation material group	
Inflammability class according to UL 94	

	8 ¹⁾ / 1.5
	160
	3.5 / 3.81
	0.14 - 1.5 / 0.14 - 1.5 / 26 - 16
	0.25 - 1.5 ²⁾
	0.25 - 0.5 ²⁾
	- / -
	-
	-
	III / 3 III / 2 II / 2
	160 160 320
	2.5 2.5 2.5
	B C D
	300 - 300
	8 - 8
	28 - 16 - 28 - 16
	B C D
	- - -
	- - -
	- - -
	9
	PA / I
	V0

Ordering data

No. of pos.	Dim. a [mm]	Type	Order No.	Pcs. / Pkt.
3.5 mm pitch, color: green				
2	3.50	FK-MCP 1,5/ 2-ST-3,5	1939918	50
3	7.00	FK-MCP 1,5/ 3-ST-3,5	1939921	50
4	10.50	FK-MCP 1,5/ 4-ST-3,5	1939934	50
5	14.00	FK-MCP 1,5/ 5-ST-3,5	1939947	50
6	17.50	FK-MCP 1,5/ 6-ST-3,5	1939950	50
7	21.00	FK-MCP 1,5/ 7-ST-3,5	1939960	50
8	24.50	FK-MCP 1,5/ 8-ST-3,5	1939963	50
9	28.00	FK-MCP 1,5/ 9-ST-3,5	1939976	50
10	31.50	FK-MCP 1,5/ 10-ST-3,5	1939989	50
11	35.00	FK-MCP 1,5/ 11-ST-3,5	1939992	50
12	38.50	FK-MCP 1,5/ 12-ST-3,5	1940004	50
13	42.00	FK-MCP 1,5/ 13-ST-3,5	1940017	50
14	45.50	FK-MCP 1,5/ 14-ST-3,5	1940020	50
15	49.00	FK-MCP 1,5/ 15-ST-3,5	1940033	50
16	52.50	FK-MCP 1,5/ 16-ST-3,5	1940046	50
Pitch 3.81 mm, color: green				
2	3.81	FK-MCP 1,5/ 2-ST-3,81	1851041	50
3	7.62	FK-MCP 1,5/ 3-ST-3,81	1851054	50
4	11.43	FK-MCP 1,5/ 4-ST-3,81	1851067	50
5	15.24	FK-MCP 1,5/ 5-ST-3,81	1851070	50
6	19.05	FK-MCP 1,5/ 6-ST-3,81	1851083	50
7	22.86	FK-MCP 1,5/ 7-ST-3,81	1851096	50
8	26.67	FK-MCP 1,5/ 8-ST-3,81	1851106	50
9	30.48	FK-MCP 1,5/ 9-ST-3,81	1851119	50
10	34.29	FK-MCP 1,5/ 10-ST-3,81	1851122	50
11	38.10	FK-MCP 1,5/ 11-ST-3,81	1851135	50
12	41.91	FK-MCP 1,5/ 12-ST-3,81	1851148	50
13	45.72	FK-MCP 1,5/ 13-ST-3,81	1851151	50
14	49.53	FK-MCP 1,5/ 14-ST-3,81	1851164	50
15	53.34	FK-MCP 1,5/ 15-ST-3,81	1851177	50
16	57.15	FK-MCP 1,5/ 16-ST-3,81	1851180	50

Mini plug-in connectors with 3.5/3.81 and 5.08 mm pitch

MINI COMBICON plug-in connectors, pitches 3.5 or 3.81 and 5.08 mm



With screw flange



With Lock & Release system



Dimensional drawing

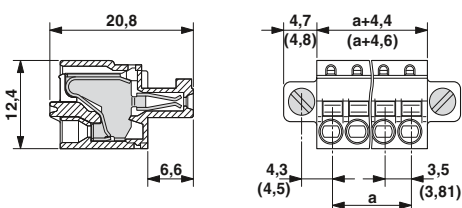

Dimensional drawing

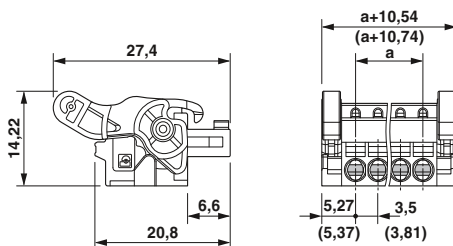

Representative derating curve

Type: FK-MCP 1,5/...-ST-3,81 with MC 1,5/...-G-3,81

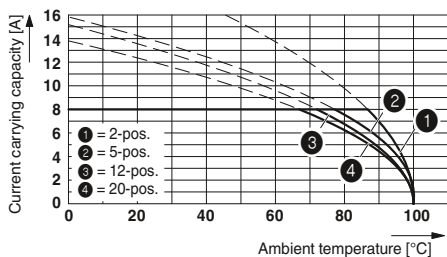

Ordering data

Type	Order No.	Pcs. / Pkt.
3.5 mm pitch, color: green		
FK-MCP 1,5/ 2-STF-3,5	1940091	50
FK-MCP 1,5/ 3-STF-3,5	1940101	50
FK-MCP 1,5/ 4-STF-3,5	1940114	50
FK-MCP 1,5/ 5-STF-3,5	1940127	50
FK-MCP 1,5/ 6-STF-3,5	1940130	50
FK-MCP 1,5/ 7-STF-3,5	1940143	50
FK-MCP 1,5/ 8-STF-3,5	1940156	50
FK-MCP 1,5/ 9-STF-3,5	1940169	50
FK-MCP 1,5/10-STF-3,5	1940172	50
FK-MCP 1,5/11-STF-3,5	1940185	50
FK-MCP 1,5/12-STF-3,5	1940198	50
FK-MCP 1,5/13-STF-3,5	1940208	50
FK-MCP 1,5/14-STF-3,5	1940211	50
FK-MCP 1,5/15-STF-3,5	1940224	50
FK-MCP 1,5/16-STF-3,5	1940237	50
Pitch 3.81 mm, color: green		
FK-MCP 1,5/ 2-STF-3,81	1851232	50
FK-MCP 1,5/ 3-STF-3,81	1851245	50
FK-MCP 1,5/ 4-STF-3,81	1851258	50
FK-MCP 1,5/ 5-STF-3,81	1851261	50
FK-MCP 1,5/ 6-STF-3,81	1851274	50
FK-MCP 1,5/ 7-STF-3,81	1851287	50
FK-MCP 1,5/ 8-STF-3,81	1851290	50
FK-MCP 1,5/ 9-STF-3,81	1851300	50
FK-MCP 1,5/10-STF-3,81	1851313	50
FK-MCP 1,5/11-STF-3,81	1851326	50
FK-MCP 1,5/12-STF-3,81	1851339	50
FK-MCP 1,5/13-STF-3,81	1851342	50
FK-MCP 1,5/14-STF-3,81	1851355	50
FK-MCP 1,5/15-STF-3,81	1851368	50
FK-MCP 1,5/16-STF-3,81	1851371	50

Ordering data

Type	Order No.	Pcs. / Pkt.
3.5 mm pitch, color: green		
FK-MCP 1,5/ 2-ST-3,5-LR	1817233	50
FK-MCP 1,5/ 3-ST-3,5-LR	1817246	50
FK-MCP 1,5/ 4-ST-3,5-LR	1817259	50
FK-MCP 1,5/ 5-ST-3,5-LR	1817262	50
FK-MCP 1,5/ 6-ST-3,5-LR	1817275	50
FK-MCP 1,5/ 7-ST-3,5-LR	1817288	50
FK-MCP 1,5/ 8-ST-3,5-LR	1817291	50
FK-MCP 1,5/ 9-ST-3,5-LR	1817301	50
FK-MCP 1,5/10-ST-3,5-LR	1817314	50
FK-MCP 1,5/11-ST-3,5-LR	1817327	50
FK-MCP 1,5/12-ST-3,5-LR	1817330	50
FK-MCP 1,5/13-ST-3,5-LR	1817343	50
FK-MCP 1,5/14-ST-3,5-LR	1817356	50
FK-MCP 1,5/15-ST-3,5-LR	1817369	50
FK-MCP 1,5/16-ST-3,5-LR	1817372	50
Pitch 3.81 mm, color: green		
FK-MCP 1,5/ 2-ST-3,81-LR	1817424	50
FK-MCP 1,5/ 3-ST-3,81-LR	1817437	50
FK-MCP 1,5/ 4-ST-3,81-LR	1817440	50
FK-MCP 1,5/ 5-ST-3,81-LR	1817453	50
FK-MCP 1,5/ 6-ST-3,81-LR	1817466	50
FK-MCP 1,5/ 7-ST-3,81-LR	1817479	50
FK-MCP 1,5/ 8-ST-3,81-LR	1817482	50
FK-MCP 1,5/ 9-ST-3,81-LR	1817495	50
FK-MCP 1,5/10-ST-3,81-LR	1817505	50
FK-MCP 1,5/11-ST-3,81-LR	1817518	50
FK-MCP 1,5/12-ST-3,81-LR	1817521	50
FK-MCP 1,5/13-ST-3,81-LR	1817534	50
FK-MCP 1,5/14-ST-3,81-LR	1817547	50
FK-MCP 1,5/15-ST-3,81-LR	1817550	50
FK-MCP 1,5/16-ST-3,81-LR	1817563	50

Mini plug-in connectors with 3.5/3.81 and 5.08 mm pitch

MINI COMBICON plug-in connectors, pitches 3.5 or 3.81 and 5.08 mm

Plug with push-in spring connection

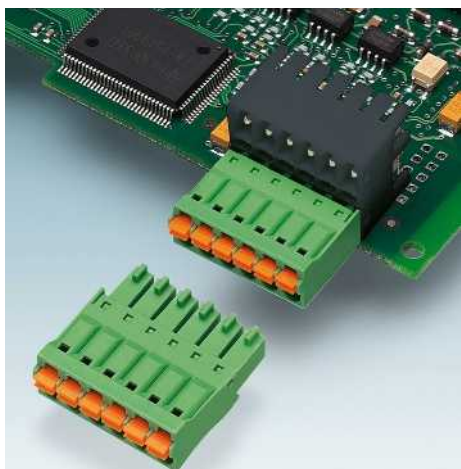

- Extremely flat design, only 7.8 mm
- Different combination options with all MC 1,5 headers with a 3.5 mm pitch
- Maximum contact and packaging density in combination with double-level MCDN(V) 1,5 headers
- Fast conductor connection, thanks to push-in spring connection
- Convenient operation of the terminal point using a screwdriver
- Touch connection for voltage testing using a 1 mm Ø test pin
- Versions with and without a screw flange or with a self-locking flange

Notes:

In accordance with DIN EN 61984, COMBICON plug-in connectors have no switching power. During designated use, they must not be plugged in or disconnected when carrying voltage or under load.

COMBICON select

You will find the possible plug-in connector combinations in COMBICON select at: www.phoenixcontact.net/products or starting on page 182.

For larger numbers of positions up to 20-pos., visit www.phoenixcontact.net/products

The maximum torque for the screw flange is 0.3 Nm.

¹⁾ Please observe the derating curves. Derating curves of further combination options on request.



Plug with flat design



Dimensional drawing

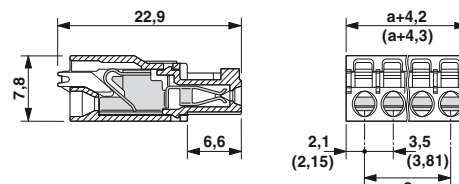

Note derating curves

Derating curves, determined as per DIN EN 61984 (VDE 0627):2002-09
Representation based on DIN EN 60512-5-2:2003-01
Connected conductor cross section = 1.5 mm²
Reduction factor = 0.8
Number of positions = see diagram

Accessories

For all types	Type	Page
	Marker cards SK 3,5/2,8	797
	Screwdriver SZS 0,4 x 2,5 Order No. 1205037	
	Ferrules with and without plastic sleeve	834
	Crimping pliers for 0.25 to 6 mm ² CRIMPFOX 6 Order No. 1212034	

Technical data

Technical data in accordance to IEC / DIN VDE	
Rated current / conductor cross section	[A] / [mm ²]
Rated insulation voltage for pollution degree 2	[V]
Pitch	[mm]
Connection capacity	
Solid / stranded	[mm ²] / [mm ²] / AWG
Stranded with ferrules without plastic sleeve	[mm ²]
Stranded with ferrules with plastic sleeve	[mm ²]
Multi-conductor connection capacity (two conductors with the same cross section)	
Solid / stranded	[mm ²]
Stranded with ferrules without plastic sleeve	[mm ²]
Stranded with TWIN ferrule with plastic sleeve	[mm ²]
Insulation coordination	
Surge voltage category / pollution degree	III / 3 III / 2 II / 2
Rated insulation voltage	[V]
Rated surge voltage	[kV]
Approval data (UL/CUL)	Use Group
Nominal voltage	[V]
Nominal current	[A]
Connection capacity AWG	AWG
Approval data (CSA)	Use Group
Nominal voltage	[V]
Nominal current	[A]
Connection capacity AWG	AWG
General data	
Stripping length	[mm]
Type of insulation material / insulation material group	
Inflammability class according to UL 94	

8 ¹⁾ / 1.5		
160		
3.5 / 3.81		
0.2 - 1.5 / 0.2 - 1.5 / 24 - 16		
0.25 - 1.5		
0.25 - 0.75		
- / -		
-		
-		
III / 3	III / 2	II / 2
160	160	320
2.5	2.5	2.5
B	C	D
150	-	150
8	-	8
24 - 16	-	24 - 16
B	C	D
-	-	-
-	-	-
-	-	-
10		
PA / I		
V0		

Ordering data

No. of pos.	Dim. a [mm]	Type	Order No.	Pcs. / Pkt.
3.5 mm pitch, color: green				
2	3.50	FMC 1,5/ 2-ST-3,5	1952267	50
3	7.00	FMC 1,5/ 3-ST-3,5	1952270	50
4	10.50	FMC 1,5/ 4-ST-3,5	1952283	50
5	14.00	FMC 1,5/ 5-ST-3,5	1952296	50
6	17.50	FMC 1,5/ 6-ST-3,5	1952306	50
7	21.00	FMC 1,5/ 7-ST-3,5	1952319	50
8	24.50	FMC 1,5/ 8-ST-3,5	1952322	50
9	28.00	FMC 1,5/ 9-ST-3,5	1952335	50
10	31.50	FMC 1,5/ 10-ST-3,5	1952348	50
11	35.00	FMC 1,5/ 11-ST-3,5	1952351	50
12	38.50	FMC 1,5/ 12-ST-3,5	1952364	50
13	42.00	FMC 1,5/ 13-ST-3,5	1952377	50
14	45.50	FMC 1,5/ 14-ST-3,5	1952380	50
15	49.00	FMC 1,5/ 15-ST-3,5	1952393	50
16	52.50	FMC 1,5/ 16-ST-3,5	1952403	50
Pitch 3.81 mm, color: green				
2	3.81	FMC 1,5/ 2-ST-3,81	1745894	50
3	7.62	FMC 1,5/ 3-ST-3,81	1745904	50
4	11.43	FMC 1,5/ 4-ST-3,81	1745917	50
5	15.24	FMC 1,5/ 5-ST-3,81	1745920	50
6	19.05	FMC 1,5/ 6-ST-3,81	1748011	50
7	22.86	FMC 1,5/ 7-ST-3,81	1748024	50
8	26.67	FMC 1,5/ 8-ST-3,81	1748037	50
9	30.48	FMC 1,5/ 9-ST-3,81	1748040	50
10	34.29	FMC 1,5/ 10-ST-3,81	1748053	50
11	38.10	FMC 1,5/ 11-ST-3,81	1748066	50
12	41.91	FMC 1,5/ 12-ST-3,81	1748079	50
13	44.72	FMC 1,5/ 13-ST-3,81	1748082	50
14	48.53	FMC 1,5/ 14-ST-3,81	1748095	50
15	52.34	FMC 1,5/ 15-ST-3,81	1748105	50
16	56.15	FMC 1,5/ 16-ST-3,81	1748118	50



Plug with flat design with self-locking flange



Plug with flat design with screw flange

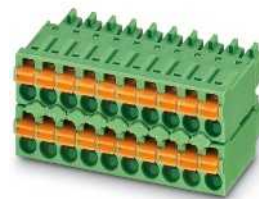

Double-row plug with flat design



Dimensional drawing

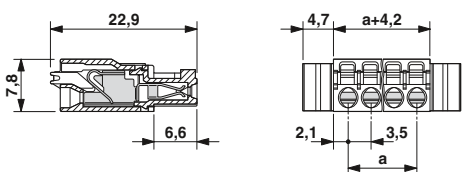

Dimensional drawing

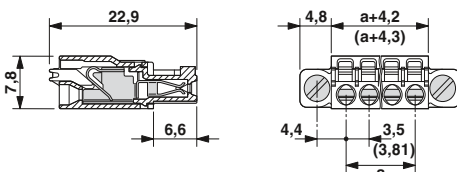

Dimensional drawing

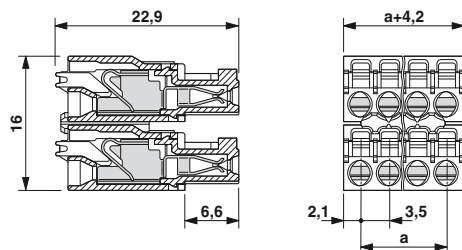

Representative derating curves of the above-mentioned plugs

Type: FMC 1,5/...-ST-3,5 with MCDN 1,5/...-G1-3,5 P26THR

Type: FMC 1,5/...-ST-3,5 with MCDNV 1,5/...-G1-3,5 P26THR

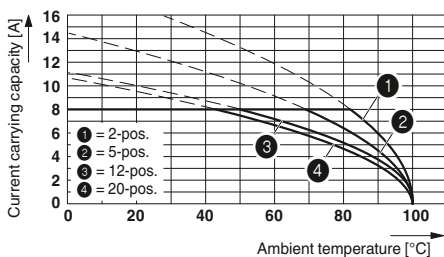
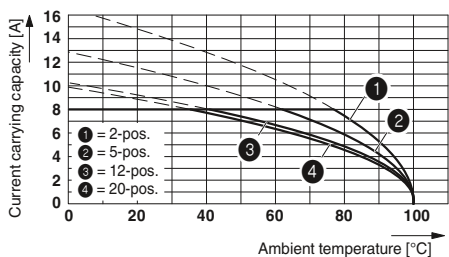

Ordering data

Type	Order No.	Pcs. / Pkt.
3.5 mm pitch, color: green		
FMC 1,5/ 2-ST-3,5-RF	1952021	50
FMC 1,5/ 3-ST-3,5-RF	1952034	50
FMC 1,5/ 4-ST-3,5-RF	1952047	50
FMC 1,5/ 5-ST-3,5-RF	1952050	50
FMC 1,5/ 6-ST-3,5-RF	1952063	50
FMC 1,5/ 7-ST-3,5-RF	1952076	50
FMC 1,5/ 8-ST-3,5-RF	1952089	50
FMC 1,5/ 9-ST-3,5-RF	1952092	50
FMC 1,5/10-ST-3,5-RF	1952102	50
FMC 1,5/11-ST-3,5-RF	1952115	50
FMC 1,5/12-ST-3,5-RF	1952128	50
FMC 1,5/13-ST-3,5-RF	1952131	50
FMC 1,5/14-ST-3,5-RF	1952144	50
FMC 1,5/15-ST-3,5-RF	1952157	50
FMC 1,5/16-ST-3,5-RF	1952160	50

Ordering data

Type	Order No.	Pcs. / Pkt.
3.5 mm pitch, color: green		
FMC 1,5/ 2-STF-3,5	1966091	50
FMC 1,5/ 3-STF-3,5	1966101	50
FMC 1,5/ 4-STF-3,5	1966114	50
FMC 1,5/ 5-STF-3,5	1966127	50
FMC 1,5/ 6-STF-3,5	1966130	50
FMC 1,5/ 7-STF-3,5	1966143	50
FMC 1,5/ 8-STF-3,5	1966156	50
FMC 1,5/ 9-STF-3,5	1966169	50
FMC 1,5/10-STF-3,5	1966172	50
FMC 1,5/11-STF-3,5	1966185	50
FMC 1,5/12-STF-3,5	1966198	50
FMC 1,5/13-STF-3,5	1966208	50
FMC 1,5/14-STF-3,5	1966211	50
FMC 1,5/15-STF-3,5	1966224	50
FMC 1,5/16-STF-3,5	1966237	50
Pitch 3.81 mm, color: green		
FMC 1,5/ 2-STF-3,81	1748354	50
FMC 1,5/ 3-STF-3,81	1748367	50
FMC 1,5/ 4-STF-3,81	1748370	50
FMC 1,5/ 5-STF-3,81	1748383	50
FMC 1,5/ 6-STF-3,81	1748396	50
FMC 1,5/ 7-STF-3,81	1748406	50
FMC 1,5/ 8-STF-3,81	1748419	50
FMC 1,5/ 9-STF-3,81	1748422	50
FMC 1,5/10-STF-3,81	1748435	50
FMC 1,5/11-STF-3,81	1748448	50
FMC 1,5/12-STF-3,81	1748451	50
FMC 1,5/13-STF-3,81	1748464	50
FMC 1,5/14-STF-3,81	1748477	50
FMC 1,5/15-STF-3,81	1748480	50
FMC 1,5/16-STF-3,81	1748493	50

Ordering data

Type	Order No.	Pcs. / Pkt.
3.5 mm pitch, color: green		
FMCD 1,5/ 3-ST-3,5	1738814	50
FMCD 1,5/ 4-ST-3,5	1738827	50
FMCD 1,5/ 5-ST-3,5	1738830	50
FMCD 1,5/ 6-ST-3,5	1738843	50
FMCD 1,5/ 7-ST-3,5	1738856	50
FMCD 1,5/ 8-ST-3,5	1738869	50
FMCD 1,5/ 9-ST-3,5	1738872	50
FMCD 1,5/10-ST-3,5	1738885	50
FMCD 1,5/11-ST-3,5	1738898	50
FMCD 1,5/12-ST-3,5	1738908	50
FMCD 1,5/13-ST-3,5	1738911	50
FMCD 1,5/14-ST-3,5	1738924	50
FMCD 1,5/15-ST-3,5	1738937	50
FMCD 1,5/16-ST-3,5	1738940	50

Mini plug-in connectors with 3.5/3.81 and 5.08 mm pitch

MINI COMBICON plug-in connectors, pitches 3.5 or 3.81 and 5.08 mm

Plug with push-in spring connection

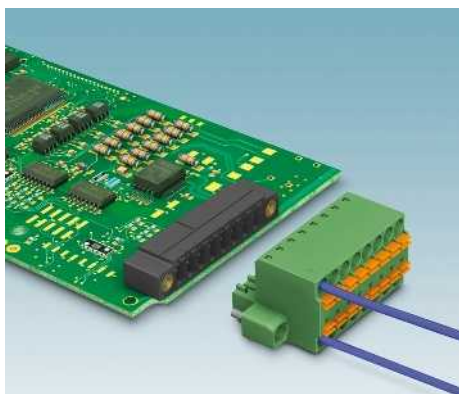

- Very compact front TWIN connection for 1.5 mm²
- Signal distribution up to 8 A directly on device
- Fast conductor connection, thanks to push-in spring connection
- Two connections per position
- Touch connection for voltage testing using a 1 mm Ø test pin
- Versions with and without a screw flange

Notes:

In accordance with DIN EN 61984, COMBICON plug-in connectors have no switching power. During designated use, they must not be plugged in or disconnected when carrying voltage or under load.

COMBICON select

You will find the possible plug-in connector combinations in COMBICON select at: www.phoenixcontact.net/products or starting on page 182.

The maximum torque for the screw flange is 0.3 Nm.

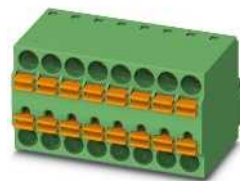

With two connections per position



Dimensional drawing

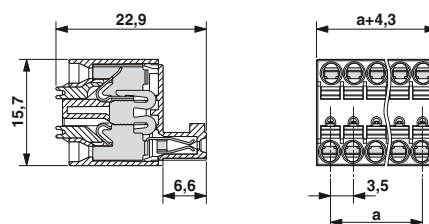

Note derating curves

Derating curves, determined as per DIN EN 61984 (VDE 0627):2002-09
Representation based on DIN EN 60512-5-2:2003-01
Connected conductor cross section = 1.5 mm²
Reduction factor = 0.8
Number of positions = see diagram

Accessories

For all types	Type	Page
	Marker cards SK 3,5/2,8	797
	Screwdriver SZS 0,4 x 2,5 Order No. 1205037	
	Ferrules with and without plastic sleeve	834
	Crimping pliers for 0.25 to 6 mm ² CRIMPFOX 6 Order No. 1212034	

Technical data

Technical data in accordance to IEC / DIN VDE	
Rated current / conductor cross section	[A] / [mm ²]
Rated insulation voltage for pollution degree 2	[V]
Pitch	[mm]
Connection capacity	
Solid / stranded	[mm ²] / [mm ²] / AWG
Stranded with ferrules without plastic sleeve	[mm ²]
Stranded with ferrules with plastic sleeve	[mm ²]
Multi-conductor connection capacity (two conductors with the same cross section)	
Solid / stranded	[mm ²]
Stranded with ferrules without plastic sleeve	[mm ²]
Stranded with TWIN ferrule with plastic sleeve	[mm ²]
Insulation coordination	
Surge voltage category / pollution degree	III / 3 III / 2 II / 2
Rated insulation voltage	[V] 160 160 320
Rated surge voltage	[kV] 2.5 2.5 2.5
Approval data (UL/CUL)	Use Group B C D
Nominal voltage	[V] 300 - -
Nominal current	[A] 8 - -
Connection capacity AWG	AWG 24 - 16 - -
Approval data (CSA)	Use Group B C D
Nominal voltage	[V] - - -
Nominal current	[A] - - -
Connection capacity AWG	AWG - - -
General data	
Stripping length	[mm] 10
Type of insulation material / insulation material group	PA / I
Inflammability class according to UL 94	V0

Ordering data

No. of pos.	Dim. a [mm]	Type	Order No.	Pcs. / Pkt.
3.5 mm pitch, color: green				
2	3.50	TFMC 1,5/ 2-ST-3,5	1772618	50
3	7.00	TFMC 1,5/ 3-ST-3,5	1772621	50
4	10.50	TFMC 1,5/ 4-ST-3,5	1772634	50
5	14.00	TFMC 1,5/ 5-ST-3,5	1772647	50
6	17.50	TFMC 1,5/ 6-ST-3,5	1772650	50
7	21.00	TFMC 1,5/ 7-ST-3,5	1772663	50
8	24.50	TFMC 1,5/ 8-ST-3,5	1772676	50
9	28.00	TFMC 1,5/ 9-ST-3,5	1772689	50
10	31.50	TFMC 1,5/10-ST-3,5	1772692	50

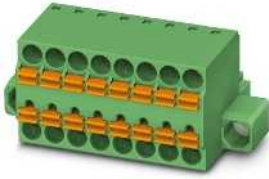

With screw flange



Dimensional drawing

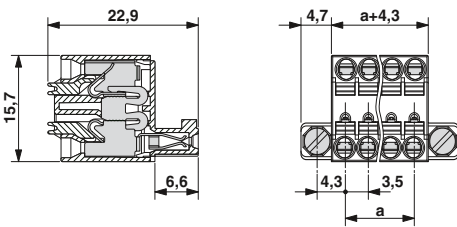

Representative derating curve

Type: TFMC 1,5/...-ST-3,5 with MCV 1,5/....-G-3,5

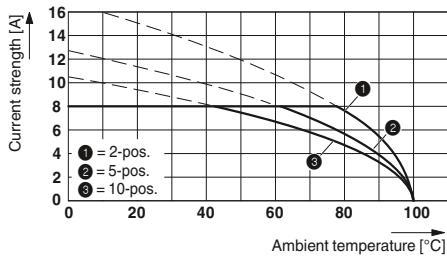

Ordering data

Type	Order No.	Pcs. / Pkt.
3.5 mm pitch, color: green		
TFMC 1,5/ 2-STF-3,5	1772702	50
TFMC 1,5/ 3-STF-3,5	1772715	50
TFMC 1,5/ 4-STF-3,5	1772728	50
TFMC 1,5/ 5-STF-3,5	1772731	50
TFMC 1,5/ 6-STF-3,5	1772744	50
TFMC 1,5/ 7-STF-3,5	1772757	50
TFMC 1,5/ 8-STF-3,5	1772760	50
TFMC 1,5/ 9-STF-3,5	1772773	50
TFMC 1,5/10-STF-3,5	1772786	50

Mini plug-in connectors with 3.5/3.81 and 5.08 mm pitch

MINI COMBICON plug-in connectors, pitches 3.5 or 3.81 and 5.08 mm

Plug with displacement connection

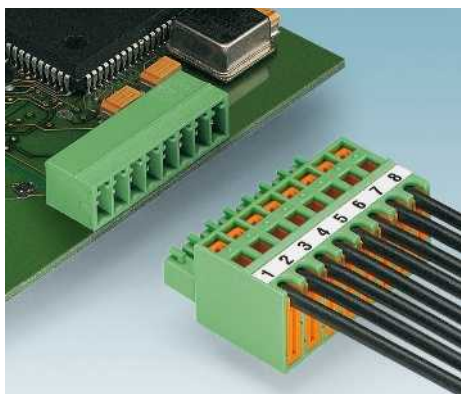

- Reduced wiring time since pretreatment of the conductor is no longer necessary
- Stranded conductors of 0.34 to 0.5 mm² with PVC or PE insulation
- Connection as per EN 60352-4
- Integrated 1.2 mm Ø test connection
- Versions with and without a screw flange
- User notes and recommendations for the insulation displacement technology can be found on page 22

Notes:

In accordance with DIN EN 61984, COMBICON plug-in connectors have no switching power. During designated use, they must not be plugged in or disconnected when carrying voltage or under load.

COMBICON select

You will find the possible plug-in connector combinations in COMBICON select at: www.phoenixcontact.net/products or starting on page 182.

The maximum torque for the screw flange is 0.3 Nm.

¹⁾ Please observe the derating curves. Derating curves of further combination options on request.

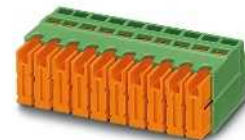

Plug with displacement connection



Dimensional drawing

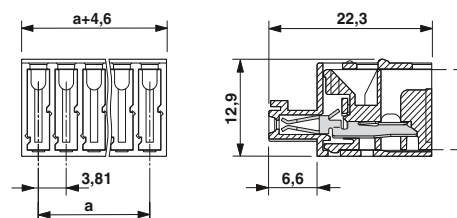

Note derating curves

Derating curves, determined as per DIN EN 61984 (VDE 0627):2002-09
Representation based on DIN EN 60512-5-2:2003-01
Connected conductor cross section = 0.5 mm²
Reduction factor = 0.8
Number of positions = see diagram

Accessories

For all types	Type	Page
	Marker cards SK 3,81/2,8	797
	Screwdriver SZS 0,4 X 2,0 Order No. 1205202	

Technical data

Technical data in accordance to IEC / DIN VDE	
Rated current / conductor cross section	[A] / [mm ²]
Rated insulation voltage for pollution degree 2	[V]
Pitch	[mm]
Connection capacity	
Solid / stranded	[mm ²] / [mm ²] / AWG
Stranded with ferrules without plastic sleeve	[mm ²]
Stranded with ferrules with plastic sleeve	[mm ²]
Multi-conductor connection capacity (two conductors with the same cross section)	
Solid / stranded	[mm ²]
Stranded with ferrules without plastic sleeve	[mm ²]
Stranded with TWIN ferrule with plastic sleeve	[mm ²]
Insulation coordination	
Surge voltage category / pollution degree	III / 3 III / 2 II / 2
Rated insulation voltage	[V] 200 200 400
Rated surge voltage	[kV] 4 4 4
Approval data (UL/CUL)	Use Group B C D
Nominal voltage	[V] 300 300 -
Nominal current	[A] 6 6 -
Connection capacity AWG	AWG 24 - 20 24 - 20 -
Approval data (CSA)	Use Group B C D
Nominal voltage	[V] - - -
Nominal current	[A] - - -
Connection capacity AWG	AWG - - -
General data	
Type of insulation material / insulation material group	PA / I
Inflammability class according to UL 94	V0

Ordering data

No. of pos.	Dim. a [mm]	Type	Order No.	Pcs. / Pkt.
Pitch 3.81 mm, color: green				
2	3.81	QC 0,5/ 2-ST-3,81	1897393	50
3	7.62	QC 0,5/ 3-ST-3,81	1897403	50
4	11.43	QC 0,5/ 4-ST-3,81	1897416	50
5	15.24	QC 0,5/ 5-ST-3,81	1897429	50
6	19.05	QC 0,5/ 6-ST-3,81	1897432	50
7	22.86	QC 0,5/ 7-ST-3,81	1897445	50
8	26.67	QC 0,5/ 8-ST-3,81	1897458	50
9	30.48	QC 0,5/ 9-ST-3,81	1897461	50
10	34.29	QC 0,5/10-ST-3,81	1897474	50
11	38.10	QC 0,5/11-ST-3,81	1897487	50
12	41.91	QC 0,5/12-ST-3,81	1897490	50
13	45.72	QC 0,5/13-ST-3,81	1897500	50
14	49.53	QC 0,5/14-ST-3,81	1897513	50
15	53.34	QC 0,5/15-ST-3,81	1897526	50
16	57.15	QC 0,5/16-ST-3,81	1897539	50



With screw flange



Dimensional drawing

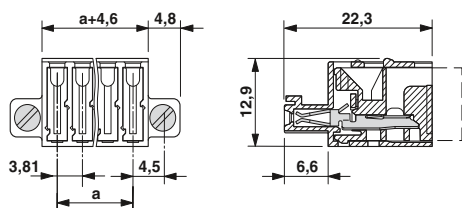

Representative derating curve

Type: QC 0,5/...-STF-3,81 with MC 1,5/...-G-3,81

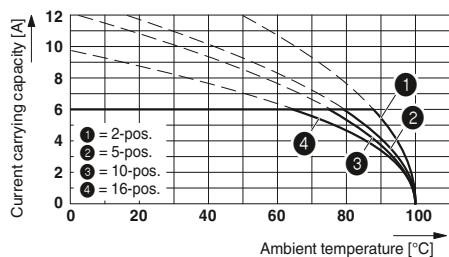

Ordering data

Type	Order No.	Pcs. / Pkt.
Pitch 3.81 mm, color: green		
QC 0,5/ 2-STF-3,81	1897542	50
QC 0,5/ 3-STF-3,81	1897555	50
QC 0,5/ 4-STF-3,81	1897568	50
QC 0,5/ 5-STF-3,81	1897571	50
QC 0,5/ 6-STF-3,81	1897584	50
QC 0,5/ 7-STF-3,81	1897597	50
QC 0,5/ 8-STF-3,81	1897607	50
QC 0,5/ 9-STF-3,81	1897610	50
QC 0,5/10-STF-3,81	1897623	50
QC 0,5/11-STF-3,81	1897636	50
QC 0,5/12-STF-3,81	1897649	50
QC 0,5/13-STF-3,81	1897652	50
QC 0,5/14-STF-3,81	1897665	50
QC 0,5/15-STF-3,81	1897678	50
QC 0,5/16-STF-3,81	1897681	50

Mini plug-in connectors with 3.5/3.81 and 5.08 mm pitch

MINI COMBICON plug-in connectors, pitches 3.5 or 3.81 and 5.08 mm

Connectors with crimp connection



- Flat design of the MCC 1 plug range
- Versions with and without a screw flange
- With snap-lock option for pullout aid
- Can be combined with MC 1,5 base strips and IMC 1,5 plugs
- Two different crimp contacts can be used:

MCC-MT 0,2 -0,35

- for conductor cross sections of 0.2 to 0.34 mm² (AWG 24-22) and currents of 4 to 5 A

MCC-MT 0,5-1,0

- for conductor cross sections of 0.5 to 1.0 mm² (AWG 20-18) and currents of 6 to 8 A

Notes:
In accordance with DIN EN 61984, COMBICON plug-in connectors have no switching power. During designated use, they must not be plugged in or disconnected when carrying voltage or under load.
COMBICON select You will find the possible plug-in connector combinations in COMBICON select at: www.phoenixcontact.net/products or starting on page 182.
For larger numbers of positions up to 20-pos. and additional technical data, visit www.phoenixcontact.com .
The maximum torque for the screw flange is 0.3 Nm.
¹⁾ Please observe the derating curves. Derating curves of further combination options on request.



Plugs with crimp connection

Accessories		
For all types	Type	Page
	Module socket contact MCC-MT...	827
	Pullout aid STZ...-PCC 4-7,62	828
	Crimping pliers for 0.14 to 1.5 mm ² CRIMPFOX-1,6-ER-1,50-GH Order No. 1772793	
	Screwdriver SZF 0-0,4 x 2,5 Order No. 1204504	



Dimensional drawing

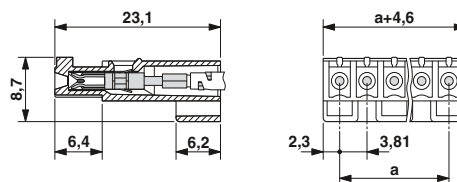

Note derating curves

Derating curves, determined as per DIN EN 61984 (VDE 0627):2002-09
Representation based on DIN EN 60512-5-2:2003-01
Connected conductor cross section = 1 mm²
Reduction factor = 0.8
Number of positions = see diagram

Technical data

Technical data in accordance to IEC / DIN VDE	
Rated current / conductor cross section	[A] / [mm ²]
Rated insulation voltage for pollution degree 2	[V]
Pitch	[mm]
Connection capacity	
Solid / stranded	[mm ²] / [mm ²] / AWG
Stranded with ferrules without plastic sleeve	[mm ²]
Stranded with ferrules with plastic sleeve	[mm ²]
Multi-conductor connection capacity (two conductors with the same cross section)	
Solid / stranded	[mm ²]
Stranded with ferrules without plastic sleeve	[mm ²]
Stranded with TWIN ferrule with plastic sleeve	[mm ²]
Insulation coordination	
Surge voltage category / pollution degree	III / 3 III / 2 II / 2
Rated insulation voltage	[V] 160 160 320
Rated surge voltage	[kV] 2.5 2.5 2.5
Approval data (UL/CUL)	Use Group B C D
Nominal voltage	[V] 300 - 300
Nominal current	[A] 8 - 8
Connection capacity AWG	AWG 20 - 18 - 20 - 18
Approval data (CSA)	Use Group B C D
Nominal voltage	[V] - - -
Nominal current	[A] - - -
Connection capacity AWG	AWG - - -
General data	
Type of insulation material / insulation material group	PA / I
Inflammability class according to UL 94	V0

Ordering data

No. of pos.	Dim. a [mm]	Type	Order No.	Pcs. / Pkt.
Pitch 3.81 mm, color: green				
2	3.81	MCC 1/ 2-STZ-3,81	1852176	50
3	7.62	MCC 1/ 3-STZ-3,81	1852189	50
4	11.43	MCC 1/ 4-STZ-3,81	1852192	50
5	15.24	MCC 1/ 5-STZ-3,81	1852202	50
6	19.05	MCC 1/ 6-STZ-3,81	1852215	50
7	22.86	MCC 1/ 7-STZ-3,81	1852228	50
8	26.67	MCC 1/ 8-STZ-3,81	1852231	50
9	30.48	MCC 1/ 9-STZ-3,81	1852244	50
10	34.29	MCC 1/10-STZ-3,81	1852257	50
11	38.10	MCC 1/11-STZ-3,81	1852260	50
12	41.91	MCC 1/12-STZ-3,81	1852273	50
13	45.72	MCC 1/13-STZ-3,81	1852286	50
14	49.53	MCC 1/14-STZ-3,81	1852299	50
15	53.34	MCC 1/15-STZ-3,81	1852309	50
16	57.15	MCC 1/16-STZ-3,81	1852312	50



With screw flange



Dimensional drawing

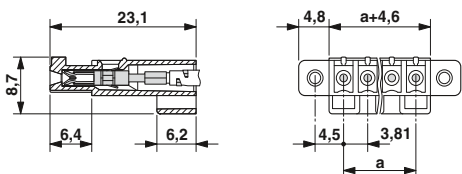

Representative derating curve

Type: MCC 1/...-ST-3,81 with MC 1,5/...-G-3,81

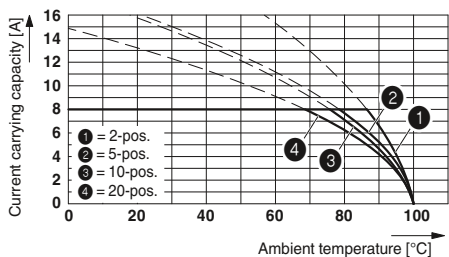

Ordering data

Type	Order No.	Pcs. / Pkt.
Pitch 3.81 mm, color: green		
MCC 1/ 2-STZF-3,81	1852367	50
MCC 1/ 3-STZF-3,81	1852370	50
MCC 1/ 4-STZF-3,81	1852383	50
MCC 1/ 5-STZF-3,81	1852396	50
MCC 1/ 6-STZF-3,81	1852406	50
MCC 1/ 7-STZF-3,81	1852419	50
MCC 1/ 8-STZF-3,81	1852422	50
MCC 1/ 9-STZF-3,81	1852435	50
MCC 1/10-STZF-3,81	1852448	50
MCC 1/11-STZF-3,81	1852451	50
MCC 1/12-STZF-3,81	1852464	50
MCC 1/13-STZF-3,81	1852477	50
MCC 1/14-STZF-3,81	1852480	50
MCC 1/15-STZF-3,81	1852493	50
MCC 1/16-STZF-3,81	1852503	50

Mini plug-in connectors with 3.5/3.81 and 5.08 mm pitch

MINI COMBICON plug-in connectors, pitches 3.5 or 3.81 and 5.08 mm

Single-level header for reflow processes

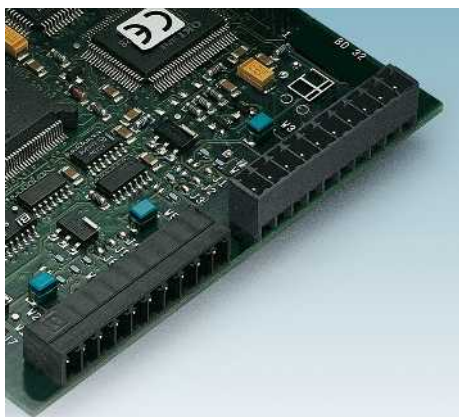

- High-precision pin strips for increased tolerance requirements
- Position tolerance of pins less than ± 0.1 mm around zero position
- Short 1.4 mm pin, no overhang in 1.6 mm PCBs for two-sided mounting
- Tape-on-reel packing according to IEC 60286-3 for automated mounting
- 330 mm roll diameter
- Tape width corresponds to order designation, e.g., R32 = 32 mm tape width
- You can find user notes and recommendations for THR procedure on page 27

Notes:

In accordance with DIN EN 61984, COMBICON plug-in connectors have no switching power. During designated use, they must not be plugged in or disconnected when carrying voltage or under load.



COMBICON select

You will find the possible plug-in connector combinations in COMBICON select at: www.phoenixcontact.net/products or starting on page 182.

CP-MSTB may only be used after reflow soldering. CP-MSTB NAT HT may also be used prior to reflow soldering.

Pick and place pads for taped THR articles usually protrude beyond the components. The PCB layout must ensure that collisions are avoided when components are assembled. Dimensional drawings of tape reels and place pads can be found online at www.phoenixcontact.net/products.

Accessories

For all types	Type	Page
	Coding profile CP-MSTB Order No. 1734634	38
	Marker cards SK 3,81/2,8	797



N

Pin length 1.4 mm,
taped headers,
plug-in direction parallel to the PCB



Dimensional drawing

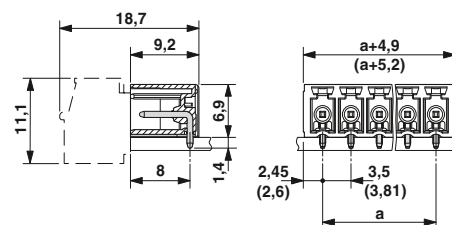

Drilling diagram

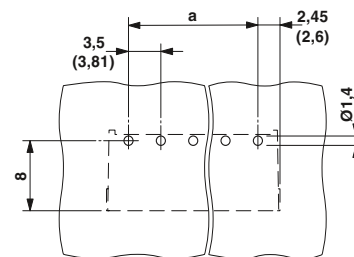

Technical data

Technical data in accordance to IEC / DIN VDE	
Rated current	[A] 8
Rated insulation voltage for pollution degree 2	[V] 160
Pitch	[mm] 3.5
Insulation coordination	
Surge voltage category / pollution degree	III / 3 III / 2 II / 2
Rated insulation voltage	[V] 160 160 250
Rated surge voltage	[kV] 2.5 2.5 2.5
Approval data (UL/CUL)	Use Group B C D
Nominal voltage	[V] 300 - 300
Nominal current	[A] 8 - 8
Connection capacity AWG	AWG - - -
Approval data (CSA)	Use Group B C D
Nominal voltage	[V] - - -
Nominal current	[A] - - -
Connection capacity AWG	AWG - - -
General data	
Type of insulation material / insulation material group	LCP / IIIa
Inflammability class according to UL 94	V0
Drill hole diameter / pin dimensions	[mm] 1.4 / 0,8 x 0,8 mm

No. of pos.	Dim. a [mm]
2	3.50
3	7.00
4	10.50
5	14.00
6	17.50
7	21.00
8	24.50
9	28.00
10	31.50
11	35.00
12	38.50

Ordering data

Type	Order No.	Pcs. / Pkt.
Pitch 3.5 mm, color: Black		
MC 1,5/ 2-G-3,5 P14 THRR32	1788958	470
MC 1,5/ 3-G-3,5 P14 THRR32	1788974	470
MC 1,5/ 4-G-3,5 P14 THRR32	1788990	470
MC 1,5/ 5-G-3,5 P14 THRR56	1789012	470
MC 1,5/ 6-G-3,5 P14 THRR56	1789038	470
MC 1,5/ 7-G-3,5 P14 THRR56	1789054	470
MC 1,5/ 8-G-3,5 P14 THRR56	1789070	470
MC 1,5/ 9-G-3,5 P14 THRR56	1789096	470
MC 1,5/10-G-3,5 P14 THRR56	1789119	470
MC 1,5/11-G-3,5 P14 THRR56	1789135	470
MC 1,5/12-G-3,5 P14 THRR72	1789151	380
3.81 mm pitch, color: Black		
MC 1,5/ 2-G-3,81 P14 THRR32	1722095	470
MC 1,5/ 3-G-3,81 P14 THRR32	1722105	470
MC 1,5/ 4-G-3,81 P14 THRR32	1722118	470
MC 1,5/ 5-G-3,81 P14 THRR56	1702662	470
MC 1,5/ 6-G-3,81 P14 THRR56	1702663	470
MC 1,5/ 7-G-3,81 P14 THRR56	1702664	470
MC 1,5/ 8-G-3,81 P14 THRR56	1702665	470
MC 1,5/ 9-G-3,81 P14 THRR56	1702666	470
MC 1,5/10-G-3,81 P14 THRR56	1702667	470
MC 1,5/11-G-3,81 P14 THRR56	1702668	470
MC 1,5/12-G-3,81 P14 THRR72	1702669	380

Mini plug-in connectors with 3.5/3.81 and 5.08 mm pitch

MINI COMBICON plug-in connectors, pitches 3.5 or 3.81 and 5.08 mm

Single-level header for reflow processes



- High-precision pin strips for increased tolerance requirements
- Position tolerance of pins less than ±0.1 mm around zero position
- Short 2.0 mm pin for reduced overhang in 1.6 mm PCBs
- Tape-on-reel packing according to IEC 60286-3 for automated mounting
- 330 mm roll diameter
- Tape width corresponds to order designation, e.g., R32 = 32 mm tape width
- You can find user notes and recommendations for THR procedure on page 27

Notes:

In accordance with DIN EN 61984, COMBICON plug-in connectors have no switching power. During designated use, they must not be plugged in or disconnected when carrying voltage or under load.

COMBICON select

You will find the possible plug-in connector combinations in COMBICON select at: www.phoenixcontact.net/products or starting on page 182.

CP-MSTB may only be used after reflow soldering. CP-MSTB NAT HT may also be used prior to reflow soldering.



Pick and place pads for taped THR articles usually protrude beyond the components. The PCB layout must ensure that collisions are avoided when components are assembled. Dimensional drawings of tape reels and place pads can be found online at www.phoenixcontact.net/products.



N

Pin length 2.0 mm,
Taped headers,
Plug-in direction parallel to the PCB

Accessories

For all types	Type	Page
	Coding profile CP-MSTB Order No. 1734634	38
	Marker cards SK 3,5/2,8 or SK 3,81/2,8	797

Dimensional drawing

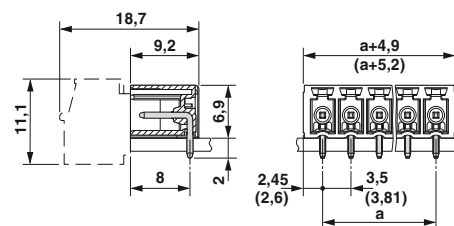

Drilling diagram

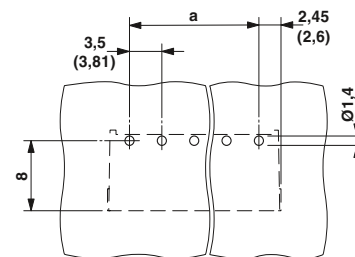

Technical data

Technical data in accordance to IEC / DIN VDE	
Rated current	[A] 8
Rated insulation voltage for pollution degree 2	[V] 160
Pitch	[mm] 3.5
Insulation coordination	
Surge voltage category / pollution degree	III / 3 III / 2 II / 2
Rated insulation voltage	[V] 160 160 250
Rated surge voltage	[kV] 2.5 2.5 2.5
Approval data (UL/CUL)	Use Group B C D
Nominal voltage	[V] 300 - 300
Nominal current	[A] 8 - 8
Connection capacity AWG	AWG - - -
Approval data (CSA)	Use Group B C D
Nominal voltage	[V] - - -
Nominal current	[A] - - -
Connection capacity AWG	AWG - - -
General data	
Type of insulation material / insulation material group	LCP / IIIa
Inflammability class according to UL 94	V0
Drill hole diameter / pin dimensions	[mm] 1.4 / 0,8 x 0,8 mm

Ordering data

Type	Order No.	Pcs. / Pkt.
Pitch 3.5 mm, color: Black		
MC 1,5/ 2-G-3,5 P20 THRR32	1788738	470
MC 1,5/ 3-G-3,5 P20 THRR32	1788754	470
MC 1,5/ 4-G-3,5 P20 THRR32	1788770	470
MC 1,5/ 5-G-3,5 P20 THRR56	1788796	470
MC 1,5/ 6-G-3,5 P20 THRR56	1788819	470
MC 1,5/ 7-G-3,5 P20 THRR56	1788835	470
MC 1,5/ 8-G-3,5 P20 THRR56	1788851	470
MC 1,5/ 9-G-3,5 P20 THRR56	1788877	470
MC 1,5/10-G-3,5 P20 THRR56	1788893	470
MC 1,5/11-G-3,5 P20 THRR56	1788916	470
MC 1,5/12-G-3,5 P20 THRR72	1788932	380
3.81 mm pitch, color: Black		
MC 1,5/ 2-G-3,81 P20 THRR32	1782572	470
MC 1,5/ 3-G-3,81 P20 THRR32	1782585	470
MC 1,5/ 4-G-3,81 P20 THRR32	1782598	470
MC 1,5/ 5-G-3,81 P20 THRR56	1782608	470
MC 1,5/ 6-G-3,81 P20 THRR56	1782611	470
MC 1,5/ 7-G-3,81 P20 THRR56	1782624	470
MC 1,5/ 8-G-3,81 P20 THRR56	1782637	470
MC 1,5/ 9-G-3,81 P20 THRR56	1782640	470
MC 1,5/10-G-3,81 P20 THRR56	1782653	470
MC 1,5/11-G-3,81 P20 THRR56	1782666	470
MC 1,5/12-G-3,81 P20 THRR72	1782679	380

Mini plug-in connectors with 3.5/3.81 and 5.08 mm pitch

MINI COMBICON plug-in connectors, pitches 3.5 or 3.81 and 5.08 mm



N

Pin length 2.0 mm, with threaded flange,
Taped headers,
Plug-in direction parallel to the PCB



N

Pin length 2.0 mm,
Taped headers,
Plug-in direction vertical to the PCB



N

Pin length 2.0 mm, with threaded flange,
Taped headers,
Plug-in direction vertical to the PCB



Dimensional drawing

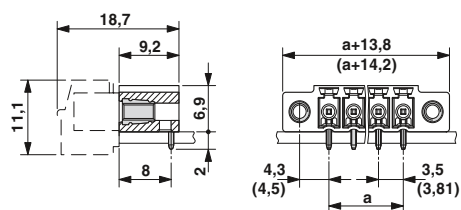

Drilling diagram

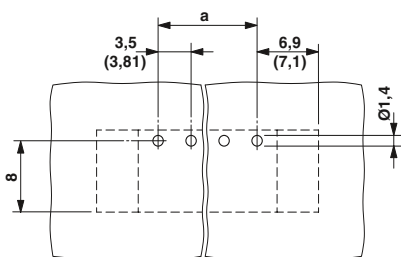

Ordering data

Type	Order No.	Pcs. / Pkt.
Pitch 3.5 mm, color: Black		
MC 1,5/ 2-GF-3,5 P20 THRR32	1789397	470
MC 1,5/ 3-GF-3,5 P20 THRR56	1789410	470
MC 1,5/ 4-GF-3,5 P20 THRR56	1789436	470
MC 1,5/ 5-GF-3,5 P20 THRR56	1789452	470
MC 1,5/ 6-GF-3,5 P20 THRR56	1789478	470
MC 1,5/ 7-GF-3,5 P20 THRR56	1789494	470
MC 1,5/ 8-GF-3,5 P20 THRR56	1789517	470
MC 1,5/ 9-GF-3,5 P20 THRR72	1789533	470
MC 1,5/10-GF-3,5 P20 THRR72	1789559	380
MC 1,5/11-GF-3,5 P20 THRR72	1789575	380
MC 1,5/12-GF-3,5 P20 THRR72	1789591	380
3.81 mm pitch, color: Black		
MC 1,5/ 2-GF-3,81 P20 THRR32	1782022	470
MC 1,5/ 3-GF-3,81 P20 THRR56	1782035	470
MC 1,5/ 4-GF-3,81 P20 THRR56	1782048	470
MC 1,5/ 5-GF-3,81 P20 THRR56	1782051	470
MC 1,5/ 6-GF-3,81 P20 THRR56	1782064	470
MC 1,5/ 7-GF-3,81 P20 THRR56	1782077	470
MC 1,5/ 8-GF-3,81 P20 THRR56	1782080	470
MC 1,5/ 9-GF-3,81 P20 THRR72	1782093	470
MC 1,5/10-GF-3,81 P20 THRR72	1782103	380
MC 1,5/11-GF-3,81 P20 THRR72	1782116	380
MC 1,5/12-GF-3,81 P20 THRR72	1782129	380



Dimensional drawing

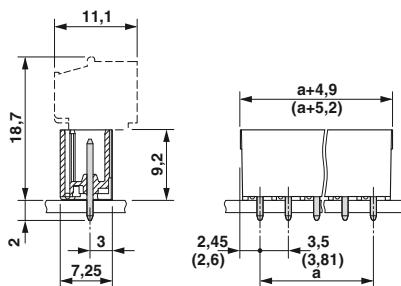

Drilling diagram

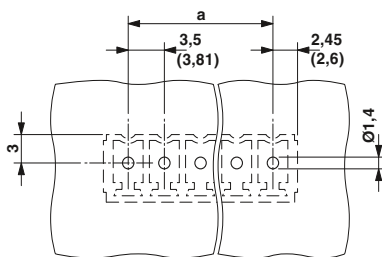

Ordering data

Type	Order No.	Pcs. / Pkt.
Pitch 3.5 mm, color: Black		
MCV 1,5/ 2-G-3,5 P20 THRR32	1780888	200
MCV 1,5/ 3-G-3,5 P20 THRR32	1780901	200
MCV 1,5/ 4-G-3,5 P20 THRR32	1780927	200
MCV 1,5/ 5-G-3,5 P20 THRR56	1780943	200
MCV 1,5/ 6-G-3,5 P20 THRR56	1780969	200
MCV 1,5/ 7-G-3,5 P20 THRR56	1780985	200
MCV 1,5/ 8-G-3,5 P20 THRR56	1781007	200
MCV 1,5/ 9-G-3,5 P20 THRR56	1781023	200
MCV 1,5/10-G-3,5 P20 THRR56	1781049	200
MCV 1,5/11-G-3,5 P20 THRR56	1781065	200
MCV 1,5/12-G-3,5 P20 THRR72	1781081	180
3.81 mm pitch, color: Black		
MCV 1,5/ 2-G-3,81 P20 THRR32	1825665	200
MCV 1,5/ 3-G-3,81 P20 THRR32	1825678	200
MCV 1,5/ 4-G-3,81 P20 THRR32	1825681	200
MCV 1,5/ 5-G-3,81 P20 THRR56	1825694	200
MCV 1,5/ 6-G-3,81 P20 THRR56	1825704	200
MCV 1,5/ 7-G-3,81 P20 THRR56	1825717	200
MCV 1,5/ 8-G-3,81 P20 THRR56	1825720	200
MCV 1,5/ 9-G-3,81 P20 THRR56	1825733	200
MCV 1,5/10-G-3,81 P20 THRR56	1825746	200
MCV 1,5/11-G-3,81 P20 THRR72	1825759	200
MCV 1,5/12-G-3,81 P20 THRR72	1825762	180



Dimensional drawing

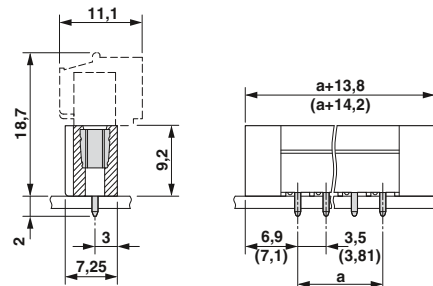

Drilling diagram

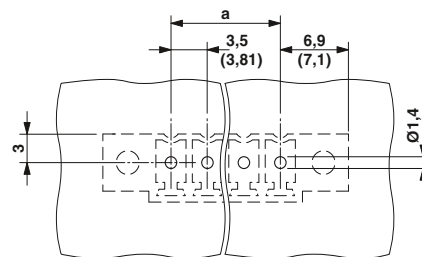

Ordering data

Type	Order No.	Pcs. / Pkt.
Pitch 3.5 mm, color: Black		
MCV 1,5/ 2-GF-3,5 P20 THRR32	1780668	200
MCV 1,5/ 3-GF-3,5 P20 THRR56	1780684	200
MCV 1,5/ 4-GF-3,5 P20 THRR56	1780707	200
MCV 1,5/ 5-GF-3,5 P20 THRR56	1780723	200
MCV 1,5/ 6-GF-3,5 P20 THRR56	1780749	200
MCV 1,5/ 7-GF-3,5 P20 THRR56	1780765	200
MCV 1,5/ 8-GF-3,5 P20 THRR56	1780781	200
MCV 1,5/ 9-GF-3,5 P20 THRR56	1780804	200
MCV 1,5/10-GF-3,5 P20 THRR72	1780820	180
MCV 1,5/11-GF-3,5 P20 THRR72	1780846	180
MCV 1,5/12-GF-3,5 P20 THRR72	1780862	180
3.81 mm pitch, color: Black		
MCV 1,5/ 2-GF-3,81 P20 THRR32	1825775	200
MCV 1,5/ 3-GF-3,81 P20 THRR56	1825788	200
MCV 1,5/ 4-GF-3,81 P20 THRR56	1825791	200
MCV 1,5/ 5-GF-3,81 P20 THRR56	1825801	200
MCV 1,5/ 6-GF-3,81 P20 THRR56	1825814	200
MCV 1,5/ 7-GF-3,81 P20 THRR56	1825827	200
MCV 1,5/ 8-GF-3,81 P20 THRR56	1825830	200
MCV 1,5/ 9-GF-3,81 P20 THRR72	1825843	200
MCV 1,5/10-GF-3,81 P20 THRR72	1825856	180
MCV 1,5/11-GF-3,81 P20 THRR72	1825869	180
MCV 1,5/12-GF-3,81 P20 THRR72	1825872	180

Mini plug-in connectors with 3.5/3.81 and 5.08 mm pitch

MINI COMBICON plug-in connectors, pitches 3.5 or 3.81 and 5.08 mm

Single-level header for reflow processes



- High-precision pin strips for increased tolerance requirements
- Position tolerance of pins less than ± 0.1 mm around zero position
- 2.6 mm pin
- Tape-on-reel packing according to IEC 60286-3 for automated mounting
- 330 mm roll diameter
- Tape width corresponds to order designation, e.g., R32 = 32 mm tape width
- You can find user notes and recommendations for THR procedure on page 27

Notes:

In accordance with DIN EN 61984, COMBICON plug-in connectors have no switching power. During designated use, they must not be plugged in or disconnected when carrying voltage or under load.

COMBICON select

You will find the possible plug-in connector combinations in COMBICON select at: www.phoenixcontact.net/products or starting on page 182.

CP-MSTB may only be used after reflow soldering. CP-MSTB NAT HT may also be used prior to reflow soldering.

Pick and place pads for taped THR articles usually protrude beyond the components. The PCB layout must ensure that collisions are avoided when components are assembled. Dimensional drawings of tape reels and place pads can be found online at www.phoenixcontact.net/products.



N

Pin length 2.6 mm,
taped headers,
plug-in direction parallel to the PCB



Dimensional drawing

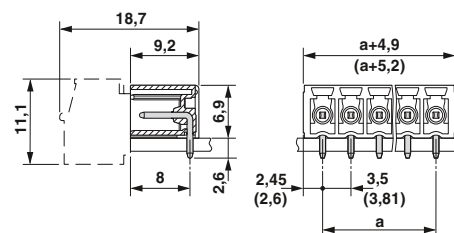

Drilling diagram

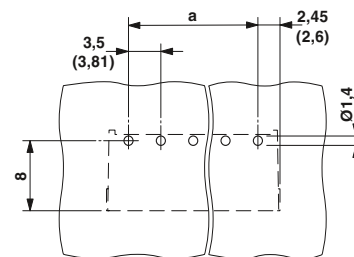

Accessories		
For all types	Type	Page
	Coding profile CP-MSTB Order No. 1734634	38
	Marker cards SK 3.5/2.8 or SK 3.81/2.8	797

Technical data

Technical data in accordance to IEC / DIN VDE

Rated current	[A]	8
Rated insulation voltage for pollution degree 2	[V]	160
Pitch	[mm]	3.5 / 3.81
Insulation coordination		III / 3 III / 2 II / 2
Surge voltage category / pollution degree		160 160 250
Rated insulation voltage	[V]	2.5 2.5 2.5
Rated surge voltage	[kV]	B C D
Approval data (UL/CUL)	Use Group	B C D
Nominal voltage	[V]	300 - 300
Nominal current	[A]	8 - 8
Connection capacity AWG	AWG	- - -
Approval data (CSA)	Use Group	B C D
Nominal voltage	[V]	- - -
Nominal current	[A]	- - -
Connection capacity AWG	AWG	- - -
General data		LCP / IIIa
Type of insulation material / insulation material group		V0
Inflammability class according to UL 94		1.4 / 0.8 x 0.8 mm
Drill hole diameter / pin dimensions	[mm]	

Ordering data

No. of pos.	Dim. a [mm]	Type	Order No.	Pcs. / Pkt.
Pitch 3.5 mm, color: Black				
2	3.50	MC 1,5/ 2-G-3,5 P26 THRR32	1788518	470
3	7.00	MC 1,5/ 3-G-3,5 P26 THRR32	1788534	470
4	10.50	MC 1,5/ 4-G-3,5 P26 THRR32	1788550	470
5	14.00	MC 1,5/ 5-G-3,5 P26 THRR56	1788576	470
6	17.50	MC 1,5/ 6-G-3,5 P26 THRR56	1788592	470
7	21.00	MC 1,5/ 7-G-3,5 P26 THRR56	1788615	470
8	24.50	MC 1,5/ 8-G-3,5 P26 THRR56	1788631	470
9	28.00	MC 1,5/ 9-G-3,5 P26 THRR56	1788657	470
10	31.50	MC 1,5/ 10-G-3,5 P26 THRR56	1788673	470
11	35.00	MC 1,5/ 11-G-3,5 P26 THRR56	1788699	470
12	38.50	MC 1,5/ 12-G-3,5 P26 THRR72	1788712	380
Pitch 3.5 mm, color: Black				
2	3.81	MC 1,5/ 2-G-3,81 P26 THRR32	1782462	470
3	7.62	MC 1,5/ 3-G-3,81 P26 THRR32	1782475	470
4	11.43	MC 1,5/ 4-G-3,81 P26 THRR32	1782488	470
5	15.24	MC 1,5/ 5-G-3,81 P26 THRR56	1782491	470
6	19.05	MC 1,5/ 6-G-3,81 P26 THRR56	1782501	470
7	22.86	MC 1,5/ 7-G-3,81 P26 THRR56	1782514	470
8	26.67	MC 1,5/ 8-G-3,81 P26 THRR56	1782527	470
9	30.48	MC 1,5/ 9-G-3,81 P26 THRR56	1782530	470
10	34.29	MC 1,5/ 10-G-3,81 P26 THRR56	1782543	470
11	38.10	MC 1,5/ 11-G-3,81 P26 THRR56	1782556	470
12	41.91	MC 1,5/ 12-G-3,81 P26 THRR72	1782569	380

Mini plug-in connectors with 3.5/3.81 and 5.08 mm pitch

MINI COMBICON plug-in connectors, pitches 3.5 or 3.81 and 5.08 mm



Z

Pin length 2.6 mm, with threaded flange, taped headers, plug-in direction parallel to the PCB



2.6 mm pin length, taped headers, plug-in direction vertical to the PCB



2.6 mm pin length, with threaded flange, taped headers, plug-in direction vertical to the PCB



Dimensional drawing

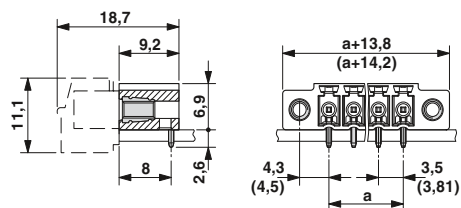

Drilling diagram

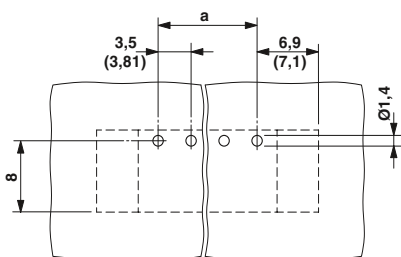

Ordering data

Type	Order No.	Pcs. / Pkt.
Pitch 3.5 mm, color: Black		
MC 1,5/ 2-GF-3,5 P26 THRR32	1789177	470
MC 1,5/ 3-GF-3,5 P26 THRR56	1789193	470
MC 1,5/ 4-GF-3,5 P26 THRR56	1789216	470
MC 1,5/ 5-GF-3,5 P26 THRR56	1789232	470
MC 1,5/ 6-GF-3,5 P26 THRR56	1789258	470
MC 1,5/ 7-GF-3,5 P26 THRR56	1789274	470
MC 1,5/ 8-GF-3,5 P26 THRR56	1789290	470
MC 1,5/ 9-GF-3,5 P26 THRR72	1789313	470
MC 1,5/10-GF-3,5 P26 THRR72	1789339	380
MC 1,5/11-GF-3,5 P26 THRR72	1789355	380
MC 1,5/12-GF-3,5 P26 THRR72	1789371	380
Pitch 3.5 mm, color: Black		
MC 1,5/ 2-GF-3,81 P26 THRR32	1781913	470
MC 1,5/ 3-GF-3,81 P26 THRR56	1781926	470
MC 1,5/ 4-GF-3,81 P26 THRR56	1781939	470
MC 1,5/ 5-GF-3,81 P26 THRR56	1781942	470
MC 1,5/ 6-GF-3,81 P26 THRR56	1781955	470
MC 1,5/ 7-GF-3,81 P26 THRR56	1781968	470
MC 1,5/ 8-GF-3,81 P26 THRR56	1781971	470
MC 1,5/ 9-GF-3,81 P26 THRR72	1781984	470
MC 1,5/10-GF-3,81 P26 THRR72	1781997	380
MC 1,5/11-GF-3,81 P26 THRR72	1782006	380
MC 1,5/12-GF-3,81 P26 THRR72	1782019	380



Dimensional drawing

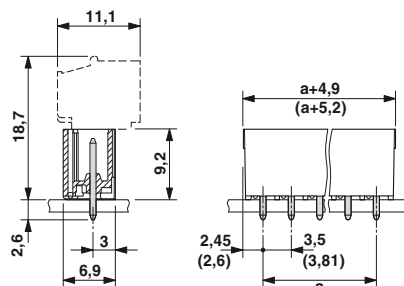

Drilling diagram

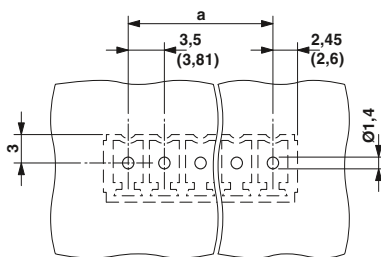

Ordering data

Type	Order No.	Pcs. / Pkt.
Pitch 3.5 mm, color: Black		
MCV 1,5/ 2-G-3,5 P26 THRR32	1779378	200
MCV 1,5/ 3-G-3,5 P26 THRR32	1779394	200
MCV 1,5/ 4-G-3,5 P26 THRR32	1779417	200
MCV 1,5/ 5-G-3,5 P26 THRR56	1779433	200
MCV 1,5/ 6-G-3,5 P26 THRR56	1779459	200
MCV 1,5/ 7-G-3,5 P26 THRR56	1779475	200
MCV 1,5/ 8-G-3,5 P26 THRR56	1779491	200
MCV 1,5/ 9-G-3,5 P26 THRR56	1779514	200
MCV 1,5/10-G-3,5 P26 THRR56	1779530	200
MCV 1,5/11-G-3,5 P26 THRR56	1779899	200
MCV 1,5/12-G-3,5 P26 THRR72	1779572	180
Pitch 3.5 mm, color: Black		
MCV 1,5/ 2-G-3,81 P26 THRR32	1713554	200
MCV 1,5/ 3-G-3,81 P26 THRR32	1712843	200
MCV 1,5/ 4-G-3,81 P26 THRR32	1712872	200
MCV 1,5/ 5-G-3,81 P26 THRR56	1712898	200
MCV 1,5/ 6-G-3,81 P26 THRR56	1712911	200
MCV 1,5/ 7-G-3,81 P26 THRR56	1712937	200
MCV 1,5/ 8-G-3,81 P26 THRR56	1712940	200
MCV 1,5/ 9-G-3,81 P26 THRR56	1713567	200
MCV 1,5/10-G-3,81 P26 THRR56	1712966	200
MCV 1,5/11-G-3,81 P26 THRR72	1714003	180
MCV 1,5/12-G-3,81 P26 THRR72	1712982	200



Dimensional drawing

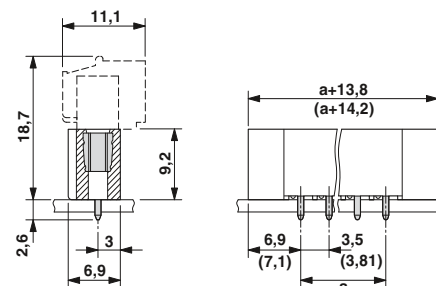

Drilling diagram

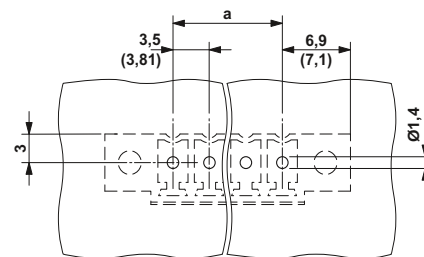

Ordering data

Type	Order No.	Pcs. / Pkt.
Pitch 3.5 mm, color: Black		
MCV 1,5/ 2-GF-3,5 P26 THRR32	1779077	200
MCV 1,5/ 3-GF-3,5 P26 THRR56	1779093	200
MCV 1,5/ 4-GF-3,5 P26 THRR56	1779116	200
MCV 1,5/ 5-GF-3,5 P26 THRR56	1779132	200
MCV 1,5/ 6-GF-3,5 P26 THRR56	1779158	200
MCV 1,5/ 7-GF-3,5 P26 THRR56	1779174	200
MCV 1,5/ 8-GF-3,5 P26 THRR56	1779190	200
MCV 1,5/ 9-GF-3,5 P26 THRR56	1779213	200
MCV 1,5/10-GF-3,5 P26 THRR72	1779239	180
MCV 1,5/11-GF-3,5 P26 THRR72	1780121	180
MCV 1,5/12-GF-3,5 P26 THRR72	1780163	180
Pitch 3.5 mm, color: Black		
MCV 1,5/ 2-GF-3,81 P26 THRR32	1713347	200
MCV 1,5/ 3-GF-3,81 P26 THRR56	1713350	200
MCV 1,5/ 4-GF-3,81 P26 THRR56	1713363	200
MCV 1,5/ 5-GF-3,81 P26 THRR56	1713376	200
MCV 1,5/ 6-GF-3,81 P26 THRR56	1713389	200
MCV 1,5/ 7-GF-3,81 P26 THRR56	1713392	200
MCV 1,5/ 8-GF-3,81 P26 THRR56	1713402	200
MCV 1,5/ 9-GF-3,81 P26 THRR72	1713415	180
MCV 1,5/10-GF-3,81 P26 THRR72	1713428	200
MCV 1,5/11-GF-3,81 P26 THRR72	1713431	200
MCV 1,5/12-GF-3,81 P26 THRR72	1713444	200

Mini plug-in connectors with 3.5/3.81 and 5.08 mm pitch

MINI COMBICON plug-in connectors, pitches 3.5 or 3.81 and 5.08 mm

Single-level header for reflow processes

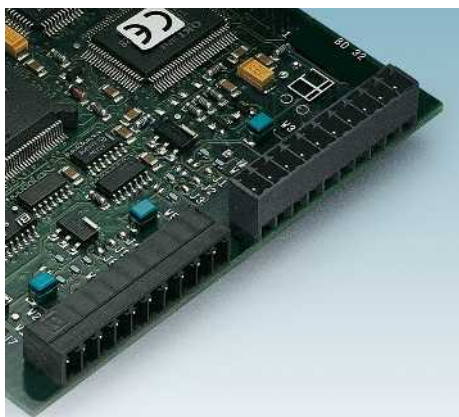

- High-precision pin strips for increased tolerance requirements
- Position tolerance of pins less than ± 0.1 mm around zero position
- Short 1.4 mm pin, no overhang in 1.6 mm PCBs for two-sided mounting
- Box packaging
- You can find user notes and recommendations for THR procedure on page 27

Notes:

In accordance with DIN EN 61984, COMBICON plug-in connectors have no switching power. During designated use, they must not be plugged in or disconnected when carrying voltage or under load.



COMBICON select

You will find the possible plug-in connector combinations in COMBICON select at: www.phoenixcontact.net/products or starting on page 182.

CP-MSTB may only be used after reflow soldering. CP-MSTB NAT HT may also be used prior to reflow soldering.

Dimensional drawings of the free space for solder paste, the tape, and pick-and-place pads can be found online at www.phoenixcontact.net/products.

Accessories

For all types	Type	Page
	Coding profile CP-MSTB Order No. 1734634	38
	Marker cards SK 3,5/2,8 or SK 3,81/2,8	797

N



1.4 mm pin length,
box-packaged headers,
plug-in direction parallel to the PCB



Dimensional drawing

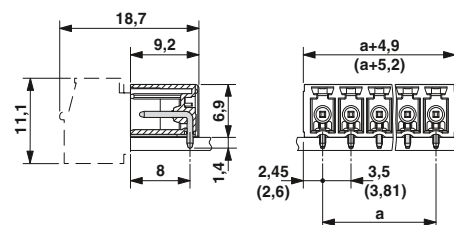

Drilling diagram

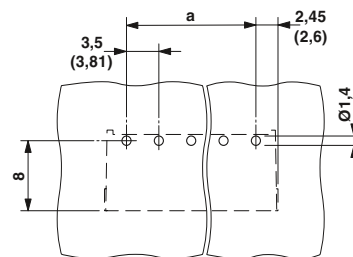

Technical data

Technical data in accordance to IEC / DIN VDE	
Rated current	[A] 8
Rated insulation voltage for pollution degree 2	[V] 160
Pitch	[mm] 3.5
Insulation coordination	
Surge voltage category / pollution degree	III / 3 III / 2 II / 2
Rated insulation voltage	[V] 160 160 250
Rated surge voltage	[kV] 2.5 2.5 2.5
Approval data (UL/CUL)	Use Group B C D
Nominal voltage	[V] 300 - 300
Nominal current	[A] 8 - 8
Connection capacity AWG	AWG - - -
Approval data (CSA)	Use Group B C D
Nominal voltage	[V] - - -
Nominal current	[A] - - -
Connection capacity AWG	AWG - - -
General data	
Type of insulation material / insulation material group	LCP / IIIa
Inflammability class according to UL 94	V0
Drill hole diameter / pin dimensions	[mm] 1.4 / 0,8 x 0,8 mm

Ordering data

No. of pos.	Dim. a [mm]	Type	Order No.	Pcs. / Pkt.
Pitch 3.5 mm, color: Black				
2	3.50	MC 1,5/ 2-G-3,5 P14 THR	1788945	50
3	7.00	MC 1,5/ 3-G-3,5 P14 THR	1788961	50
4	10.50	MC 1,5/ 4-G-3,5 P14 THR	1788987	50
5	14.00	MC 1,5/ 5-G-3,5 P14 THR	1789009	50
6	17.50	MC 1,5/ 6-G-3,5 P14 THR	1789025	50
7	21.00	MC 1,5/ 7-G-3,5 P14 THR	1789041	50
8	24.50	MC 1,5/ 8-G-3,5 P14 THR	1789067	50
9	28.00	MC 1,5/ 9-G-3,5 P14 THR	1789083	50
10	31.50	MC 1,5/10-G-3,5 P14 THR	1789106	50
11	35.00	MC 1,5/11-G-3,5 P14 THR	1789122	50
12	38.50	MC 1,5/12-G-3,5 P14 THR	1789148	50
3.81 mm pitch, color: Black				
2	3.81	MC 1,5/ 2-G-3,81 P14 THR	1782352	100
3	7.62	MC 1,5/ 3-G-3,81 P14 THR	1782365	100
4	11.43	MC 1,5/ 4-G-3,81 P14 THR	1782378	100
5	15.24	MC 1,5/ 5-G-3,81 P14 THR	1782381	50
6	19.05	MC 1,5/ 6-G-3,81 P14 THR	1782394	50
7	22.86	MC 1,5/ 7-G-3,81 P14 THR	1782404	50
8	26.67	MC 1,5/ 8-G-3,81 P14 THR	1782417	50
9	30.48	MC 1,5/ 9-G-3,81 P14 THR	1782420	50
10	34.29	MC 1,5/10-G-3,81 P14 THR	1782433	50
11	38.10	MC 1,5/11-G-3,81 P14 THR	1782446	50
12	41.91	MC 1,5/12-G-3,81 P14 THR	1782459	50

Z



Pin length of 1.4 mm, with threaded flange
Box-packaged headers
Plug-in direction parallel to the PCB



1.4 mm pin length, box-packaged headers,
plug-in direction vertical to the PCB



1.4 mm pin length, with threaded flange, box-packaged headers, plug-in direction vertical to the PCB



Dimensional drawing

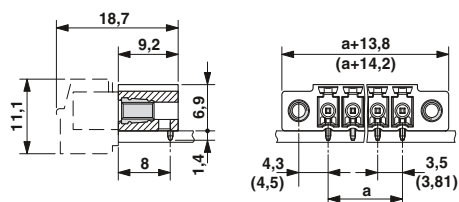

Drilling diagram

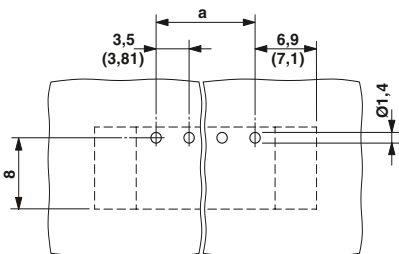

Ordering data

Type	Order No.	Pcs. / Pkt.
Pitch 3.5 mm, color: Black		
MC 1,5/ 2-GF-3,5 P14 THR	1789601	50
MC 1,5/ 3-GF-3,5 P14 THR	1789627	50
MC 1,5/ 4-GF-3,5 P14 THR	1789643	50
MC 1,5/ 5-GF-3,5 P14 THR	1789669	50
MC 1,5/ 6-GF-3,5 P14 THR	1789685	50
MC 1,5/ 7-GF-3,5 P14 THR	1789708	50
MC 1,5/ 8-GF-3,5 P14 THR	1789724	50
MC 1,5/ 9-GF-3,5 P14 THR	1789740	50
MC 1,5/10-GF-3,5 P14 THR	1789766	50
MC 1,5/11-GF-3,5 P14 THR	1789782	50
MC 1,5/12-GF-3,5 P26 THR	1789368	50
3.81 mm pitch, color: Black		
MC 1,5/ 2-GF-3,81 P14 THR	1781803	100
MC 1,5/ 3-GF-3,81 P14 THR	1781816	100
MC 1,5/ 4-GF-3,81 P14 THR	1781829	100
MC 1,5/ 5-GF-3,81 P14 THR	1781832	50
MC 1,5/ 6-GF-3,81 P14 THR	1781845	50
MC 1,5/ 7-GF-3,81 P14 THR	1781858	50
MC 1,5/ 8-GF-3,81 P14 THR	1781861	50
MC 1,5/ 9-GF-3,81 P14 THR	1781874	50
MC 1,5/10-GF-3,81 P14 THR	1781887	50
MC 1,5/11-GF-3,81 P14 THR	1781890	50
MC 1,5/12-GF-3,81 P14 THR	1781900	50



Dimensional drawing

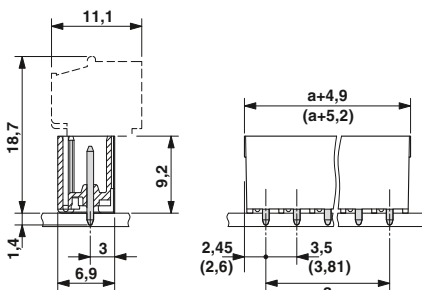

Drilling diagram

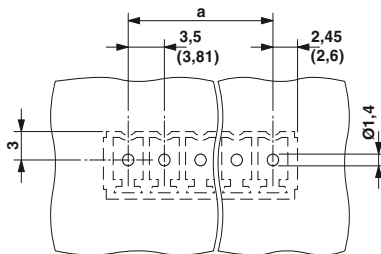

Ordering data

Type	Order No.	Pcs. / Pkt.
Pitch 3.5 mm, color: Black		
MCV 1,5/ 2-G-3,5 P14 THR	1780192	100
MCV 1,5/ 3-G-3,5 P14 THR	1780215	100
MCV 1,5/ 4-G-3,5 P14 THR	1780231	100
MCV 1,5/ 5-G-3,5 P14 THR	1780257	50
MCV 1,5/ 6-G-3,5 P14 THR	1780273	50
MCV 1,5/ 7-G-3,5 P14 THR	1780299	50
MCV 1,5/ 8-G-3,5 P14 THR	1780312	50
MCV 1,5/ 9-G-3,5 P14 THR	1780338	50
MCV 1,5/10-G-3,5 P14 THR	1780354	50
MCV 1,5/11-G-3,5 P14 THR	1780370	50
MCV 1,5/12-G-3,5 P14 THR	1780396	50
3.81 mm pitch, color: Black		
MCV 1,5/ 2-G-3,81 P14 THR	1707007	50
MCV 1,5/ 3-G-3,81 P14 THR	1707010	50
MCV 1,5/ 4-G-3,81 P14 THR	1707023	50
MCV 1,5/ 5-G-3,81 P14 THR	1707036	50
MCV 1,5/ 6-G-3,81 P14 THR	1707049	50
MCV 1,5/ 7-G-3,81 P14 THR	1707052	50
MCV 1,5/ 8-G-3,81 P14 THR	1707065	50
MCV 1,5/ 9-G-3,81 P14 THR	1707078	50
MCV 1,5/10-G-3,81 P14 THR	1707081	50
MCV 1,5/11-G-3,81 P14 THR	1707094	50
MCV 1,5/12-G-3,81 P14 THR	1707104	50



Dimensional drawing

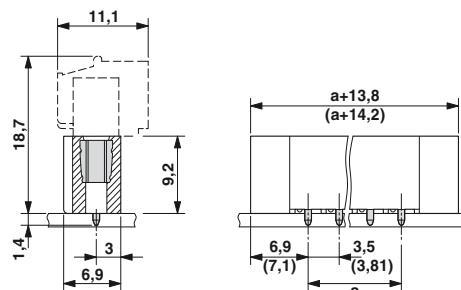

Drilling diagram

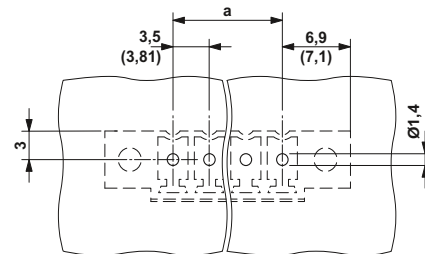

Ordering data

Type	Order No.	Pcs. / Pkt.
Pitch 3.5 mm, color: Black		
MCV 1,5/ 2-GF-3,5 P14 THR	1779938	100
MCV 1,5/ 3-GF-3,5 P14 THR	1779954	100
MCV 1,5/ 4-GF-3,5 P14 THR	1779970	100
MCV 1,5/ 5-GF-3,5 P14 THR	1779996	50
MCV 1,5/ 6-GF-3,5 P14 THR	1780011	50
MCV 1,5/ 7-GF-3,5 P14 THR	1780037	50
MCV 1,5/ 8-GF-3,5 P14 THR	1780053	50
MCV 1,5/ 9-GF-3,5 P14 THR	1780079	50
MCV 1,5/10-GF-3,5 P14 THR	1780095	50
MCV 1,5/11-GF-3,5 P14 THR	1780134	50
MCV 1,5/12-GF-3,5 P14 THR	1780176	50
3.81 mm pitch, color: Black		
MCV 1,5/ 2-GF-3,81 P14 THR	1707214	50
MCV 1,5/ 3-GF-3,81 P14 THR	1707227	50
MCV 1,5/ 4-GF-3,81 P14 THR	1707230	50
MCV 1,5/ 5-GF-3,81 P14 THR	1707243	50
MCV 1,5/ 6-GF-3,81 P14 THR	1707256	50
MCV 1,5/ 7-GF-3,81 P14 THR	1707269	50
MCV 1,5/ 8-GF-3,81 P14 THR	1707272	50
MCV 1,5/ 9-GF-3,81 P14 THR	1707285	50
MCV 1,5/10-GF-3,81 P14 THR	1707298	50
MCV 1,5/11-GF-3,81 P14 THR	1707308	50
MCV 1,5/12-GF-3,81 P14 THR	1707311	50

Mini plug-in connectors with 3.5/3.81 and 5.08 mm pitch

MINI COMBICON plug-in connectors, pitches 3.5 or 3.81 and 5.08 mm

Single-level header for reflow processes



- High-precision pin strips for increased tolerance requirements
- Position tolerance of pins less than ±0.1 mm around zero position
- 2.6 mm pin length
- Box packaging
- You can find user notes and recommendations for THR procedure on page 27

Notes:

In accordance with DIN EN 61984, COMBICON plug-in connectors have no switching power. During designated use, they must not be plugged in or disconnected when carrying voltage or under load.

COMBICON select

You will find the possible plug-in connector combinations in COMBICON select at: www.phoenixcontact.net/products or starting on page 182.

CP-MSTB may only be used after reflow soldering. CP-MSTB NAT HT may also be used prior to reflow soldering.

Dimensional drawings of the free space for solder paste, the tape, and pick-and-place pads can be found online at www.phoenixcontact.net/products.



N



2.6 mm pin length,
box-packaged headers,
plug-in direction parallel to the PCB



Accessories

For all types	Type	Page
	Coding profile CP-MSTB Order No. 1734634	38
	Coding profile CP-MSTB NAT HT Order No. 1954359	38
	Marker cards SK 3,81/2,8	797

Dimensional drawing

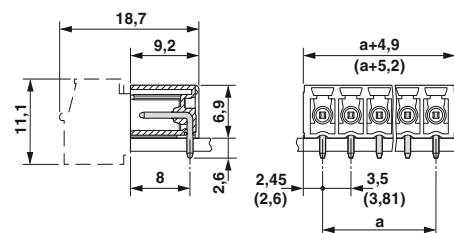

Drilling diagram

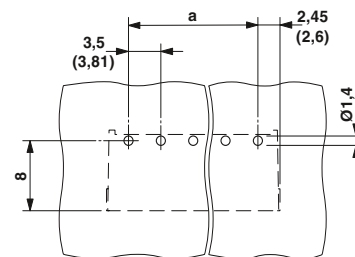

Technical data

Technical data in accordance to IEC / DIN VDE	
Rated current	[A] 8
Rated insulation voltage for pollution degree 2	[V] 160
Pitch	[mm] 3.5 / 3.81
Insulation coordination	
Surge voltage category / pollution degree	III / 3 III / 2 II / 2
Rated insulation voltage	[V] 160 160 250
Rated surge voltage	[kV] 2.5 2.5 2.5
Approval data (UL/CUL)	Use Group B C D
Nominal voltage	[V] 300 - 300
Nominal current	[A] 8 - 8
Connection capacity AWG	AWG - - -
Approval data (CSA)	Use Group B C D
Nominal voltage	[V] - - -
Nominal current	[A] - - -
Connection capacity AWG	AWG - - -
General data	
Type of insulation material / insulation material group	LCP / IIIa
Inflammability class according to UL 94	V0
Drill hole diameter / pin dimensions	[mm] 1.4 / 0,8 x 0,8 mm

No. of pos.	Dim. a [mm]
2	3.50
3	7.00
4	10.50
5	14.00
6	17.50
7	21.00
8	24.50
9	28.00
10	31.50
11	35.00
12	38.50

Ordering data

Type	Order No.	Pcs. / Pkt.
Pitch 3.5 mm, color: Black		
MC 1,5/ 2-G-3,5 P26 THR	1788505	50
MC 1,5/ 3-G-3,5 P26 THR	1788521	50
MC 1,5/ 4-G-3,5 P26 THR	1788547	50
MC 1,5/ 5-G-3,5 P26 THR	1788563	50
MC 1,5/ 6-G-3,5 P26 THR	1788589	50
MC 1,5/ 7-G-3,5 P26 THR	1788602	50
MC 1,5/ 8-G-3,5 P26 THR	1788628	50
MC 1,5/ 9-G-3,5 P26 THR	1788644	50
MC 1,5/10-G-3,5 P26 THR	1788660	50
MC 1,5/11-G-3,5 P26 THR	1788686	50
MC 1,5/12-G-3,5 P26 THR	1788709	50
Pitch 3.5 mm, color: Black		
MC 1,5/ 2-G-3,81 P26 THR	1721986	100
MC 1,5/ 3-G-3,81 P26 THR	1721999	100
MC 1,5/ 4-G-3,81 P26 THR	1722008	100
MC 1,5/ 5-G-3,81 P26 THR	1722011	50
MC 1,5/ 6-G-3,81 P26 THR	1722024	50
MC 1,5/ 7-G-3,81 P26 THR	1722037	50
MC 1,5/ 8-G-3,81 P26 THR	1722040	50
MC 1,5/ 9-G-3,81 P26 THR	1722053	50
MC 1,5/10-G-3,81 P26 THR	1722066	50
MC 1,5/11-G-3,81 P26 THR	1722079	50
MC 1,5/12-G-3,81 P26 THR	1722082	50

Z



Pin length of 2.6 mm, with threaded flange
Box-packaged headers
Plug-in direction parallel to the PCB



2.6 mm pin length, box-packaged headers,
plug-in direction vertical to the PCB



2.6 mm pin length, with threaded flange, box-packaged headers, plug-in direction vertical to the PCB



Dimensional drawing

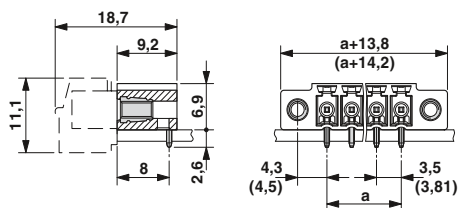

Drilling diagram

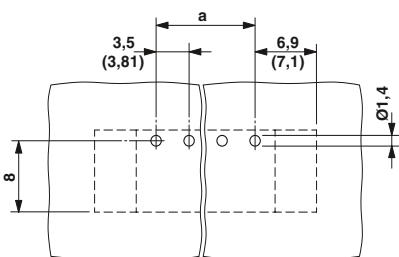

Ordering data

Type	Order No.	Pcs. / Pkt.
Pitch 3.5 mm, color: Black		
MC 1,5/ 2-GF-3,5 P26 THR	1789164	50
MC 1,5/ 3-GF-3,5 P26 THR	1789180	50
MC 1,5/ 4-GF-3,5 P26 THR	1789203	50
MC 1,5/ 5-GF-3,5 P26 THR	1789229	50
MC 1,5/ 6-GF-3,5 P26 THR	1789245	50
MC 1,5/ 7-GF-3,5 P26 THR	1789261	50
MC 1,5/ 8-GF-3,5 P26 THR	1789287	50
MC 1,5/ 9-GF-3,5 P26 THR	1789300	50
MC 1,5/10-GF-3,5 P26 THR	1789326	50
MC 1,5/11-GF-3,5 P26 THR	1789342	50
MC 1,5/12-GF-3,5 P26 THR	1789368	50
3.81 mm pitch, color: Black		
MC 1,5/ 2-GF-3,81 P26 THR	1722150	100
MC 1,5/ 3-GF-3,81 P26 THR	1722163	100
MC 1,5/ 4-GF-3,81 P26 THR	1722176	100
MC 1,5/ 5-GF-3,81 P26 THR	1722189	50
MC 1,5/ 6-GF-3,81 P26 THR	1722202	50
MC 1,5/ 7-GF-3,81 P26 THR	1722215	50
MC 1,5/ 8-GF-3,81 P26 THR	1722228	50
MC 1,5/ 9-GF-3,81 P26 THR	1722231	50
MC 1,5/10-GF-3,81 P26 THR	1722244	50
MC 1,5/11-GF-3,81 P26 THR	1722257	50
MC 1,5/12-GF-3,81 P26 THR	1722260	50



Dimensional drawing

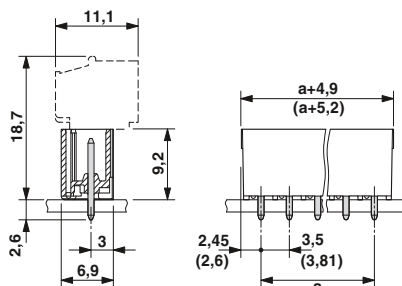

Drilling diagram

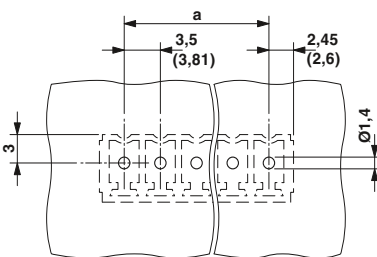

Ordering data

Type	Order No.	Pcs. / Pkt.
Pitch 3.5 mm, color: Black		
MCV 1,5/ 2-G-3,5 P26 THR	1779365	100
MCV 1,5/ 3-G-3,5 P26 THR	1779381	100
MCV 1,5/ 4-G-3,5 P26 THR	1779404	100
MCV 1,5/ 5-G-3,5 P26 THR	1779420	50
MCV 1,5/ 6-G-3,5 P26 THR	1779446	50
MCV 1,5/ 7-G-3,5 P26 THR	1779462	50
MCV 1,5/ 8-G-3,5 P26 THR	1779488	50
MCV 1,5/ 9-G-3,5 P26 THR	1779501	50
MCV 1,5/10-G-3,5 P26 THR	1779527	50
MCV 1,5/11-G-3,5 P26 THR	1779543	50
MCV 1,5/12-G-3,5 P26 THR	1779569	50
3.81 mm pitch, color: Black		
MCV 1,5/ 2-G-3,81 P26 THR	1707421	50
MCV 1,5/ 3-G-3,81 P26 THR	1707434	50
MCV 1,5/ 4-G-3,81 P26 THR	1707447	50
MCV 1,5/ 5-G-3,81 P26 THR	1707450	50
MCV 1,5/ 6-G-3,81 P26 THR	1707463	50
MCV 1,5/ 7-G-3,81 P26 THR	1707476	50
MCV 1,5/ 8-G-3,81 P26 THR	1707489	50
MCV 1,5/ 9-G-3,81 P26 THR	1707492	50
MCV 1,5/10-G-3,81 P26 THR	1707502	50
MCV 1,5/11-G-3,81 P26 THR	1707515	50
MCV 1,5/12-G-3,81 P26 THR	1707528	50



Dimensional drawing

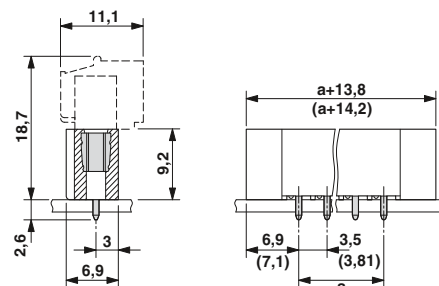

Drilling diagram

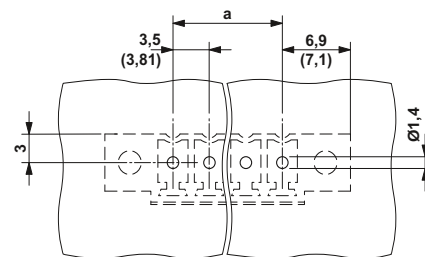

Ordering data

Type	Order No.	Pcs. / Pkt.
Pitch 3.5 mm, color: Black		
MCV 1,5/ 2-GF-3,5 P26 THR	1779064	100
MCV 1,5/ 3-GF-3,5 P26 THR	1779080	100
MCV 1,5/ 4-GF-3,5 P26 THR	1779103	100
MCV 1,5/ 5-GF-3,5 P26 THR	1779129	50
MCV 1,5/ 6-GF-3,5 P26 THR	1779145	50
MCV 1,5/ 7-GF-3,5 P26 THR	1779161	50
MCV 1,5/ 8-GF-3,5 P26 THR	1779187	50
MCV 1,5/ 9-GF-3,5 P26 THR	1779200	50
MCV 1,5/10-GF-3,5 P26 THR	1779226	50
MCV 1,5/11-GF-3,5 P26 THR	1780118	50
MCV 1,5/12-GF-3,5 P26 THR	1780150	50
3.81 mm pitch, color: Black		
MCV 1,5/ 2-GF-3,81 P26 THR	1707638	50
MCV 1,5/ 3-GF-3,81 P26 THR	1707641	50
MCV 1,5/ 4-GF-3,81 P26 THR	1707654	50
MCV 1,5/ 5-GF-3,81 P26 THR	1707667	50
MCV 1,5/ 6-GF-3,81 P26 THR	1707670	50
MCV 1,5/ 7-GF-3,81 P26 THR	1707683	50
MCV 1,5/ 8-GF-3,81 P26 THR	1707696	50
MCV 1,5/ 9-GF-3,81 P26 THR	1707706	50
MCV 1,5/10-GF-3,81 P26 THR	1707719	50
MCV 1,5/11-GF-3,81 P26 THR	1707722	50
MCV 1,5/12-GF-3,81 P26 THR	1707735	50

Mini plug-in connectors with 3.5/3.81 and 5.08 mm pitch

MINI COMBICON plug-in connectors, pitches 3.5 or 3.81 and 5.08 mm

Double-level header for reflow processes

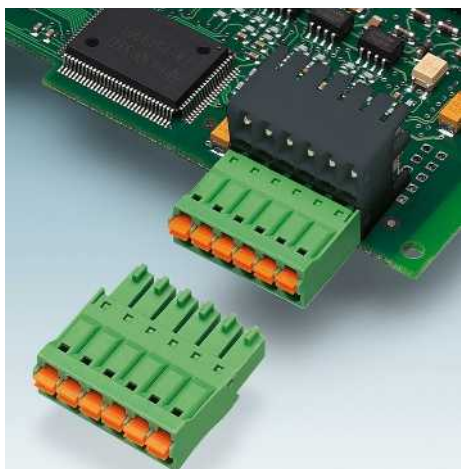

- Application in SMT reflow processes
- THR double-level pin strips with a flat design featuring compact pitches of 3.5 mm and 3.81 mm
- Alternative pin lengths 1.4 mm or 2.6 mm
- Plug-in direction parallel to the PCB
- Without a level offset, for flush installation in the front of the devices
- Versions with engagement noses for locking plugs with self-locking flanges
- Higher numbers of positions up to 20-pos. can be found at: www.phoenixcontact.net/products
- Relevant FMC 1,5/...plugs can be found on page 200

Notes:

In accordance with DIN EN 61984, COMBICON plug-in connectors have no switching power. During designated use, they must not be plugged in or disconnected when carrying voltage or under load.



COMBICON select

You will find the possible plug-in connector combinations in COMBICON select at: www.phoenixcontact.net/products or starting on page 182.

Application notes and suggestions for the THR process can be found on page 27.

CP-MSTB may only be used after reflow soldering. CP-MSTB NAT HT may also be used prior to reflow soldering.

Accessories

For all types	Type	Page
	Coding profile CP-MSTB Order No. 1734634	38
	Marker cards SK 3,5/2,8 or SK 3,81/2,8	797



1.4 mm pin length,
plug-in direction parallel to the PCB



Dimensional drawing

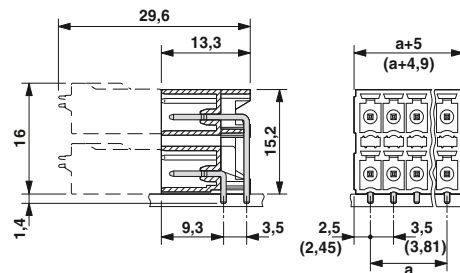

Drilling diagram

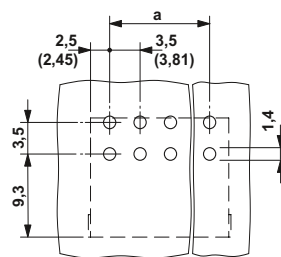

Technical data

Technical data in accordance to IEC / DIN VDE	
Rated current	[A] 8
Rated insulation voltage for pollution degree 2	[V] 160
Pitch	[mm] 3.5 / 3.81
Insulation coordination	
Surge voltage category / pollution degree	III / 3 III / 2 II / 2
Rated insulation voltage	[V] 160 160 250
Rated surge voltage	[kV] 2.5 2.5 2.5
Approval data (UL/CUL)	Use Group B C D
Nominal voltage	[V] 150 - 150
Nominal current	[A] 8 - 8
Connection capacity AWG	AWG - - -
Approval data (CSA)	Use Group B C D
Nominal voltage	[V] - - -
Nominal current	[A] - - -
Connection capacity AWG	AWG - - -
General data	
Type of insulation material / insulation material group	LCP / IIIa
Inflammability class according to UL 94	V0
Drill hole diameter / pin dimensions	[mm] 1.4 / 0.8 x 0.8 mm

Ordering data

No. of pos.	Dim. a [mm]	Type	Order No.	Pcs. / Pkt.
Pitch 3.5 mm, color: Black				
2	3.50	MCDN 1,5/ 2-G1-3,5 P14THR	1953907	50
3	7.00	MCDN 1,5/ 3-G1-3,5 P14THR	1953923	50
4	10.50	MCDN 1,5/ 4-G1-3,5 P14THR	1953936	50
5	14.00	MCDN 1,5/ 5-G1-3,5 P14THR	1953949	50
6	17.50	MCDN 1,5/ 6-G1-3,5 P14THR	1953952	50
7	21.00	MCDN 1,5/ 7-G1-3,5 P14THR	1953965	50
8	24.50	MCDN 1,5/ 8-G1-3,5 P14THR	1953978	50
9	28.00	MCDN 1,5/ 9-G1-3,5 P14THR	1953981	50
10	31.50	MCDN 1,5/10-G1-3,5 P14THR	1953994	50
11	35.00	MCDN 1,5/11-G1-3,5 P14THR	1954003	50
12	38.50	MCDN 1,5/12-G1-3,5 P14THR	1954032	50
13	42.00	MCDN 1,5/13-G1-3,5 P14THR	1954045	50
14	45.50	MCDN 1,5/14-G1-3,5 P14THR	1954058	50
15	49.00	MCDN 1,5/15-G1-3,5 P14THR	1954061	50
16	52.50	MCDN 1,5/16-G1-3,5 P14THR	1954074	50
3.81 mm pitch, color: Black				
2	3.81	MCDN 1,5/ 2-G1-3,81 P14THR	1749337	50
2	7.62	MCDN 1,5/ 3-G1-3,81 P14THR	1749340	50
4	11.43	MCDN 1,5/ 4-G1-3,81 P14THR	1749353	50
5	15.24	MCDN 1,5/ 5-G1-3,81 P14THR	1749366	50
6	19.05	MCDN 1,5/ 6-G1-3,81 P14THR	1749379	50
7	22.86	MCDN 1,5/ 7-G1-3,81 P14THR	1749382	50
8	26.67	MCDN 1,5/ 8-G1-3,81 P14THR	1749395	50
9	30.48	MCDN 1,5/ 9-G1-3,81 P14THR	1749405	50
10	34.29	MCDN 1,5/10-G1-3,81 P14THR	1749418	50
11	38.10	MCDN 1,5/11-G1-3,81 P14THR	1749421	50
12	41.91	MCDN 1,5/12-G1-3,81 P14THR	1749434	50
13	45.72	MCDN 1,5/13-G1-3,81 P14THR	1749447	50
14	49.53	MCDN 1,5/14-G1-3,81 P14THR	1749450	50
15	53.34	MCDN 1,5/15-G1-3,81 P14THR	1749463	50
16	57.15	MCDN 1,5/16-G1-3,81 P14THR	1749476	50



2.6 mm pin length,
plug-in direction parallel to the PCB



1.4 mm pin length, with engagement noses,
plug-in direction parallel to the PCB



2.6 mm pin length, with engagement noses,
plug-in direction parallel to the PCB



Dimensional drawing

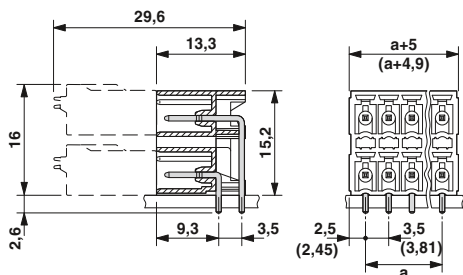

Drilling diagram

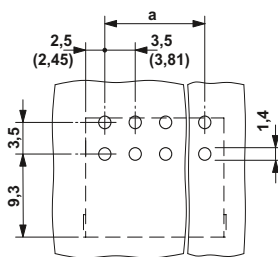

Ordering data

Type	Order No.	Pcs. / Pkt.
Pitch 3.5 mm, color: Black		
MCDN 1,5/ 2-G1-3,5 P26THR	1953716	50
MCDN 1,5/ 3-G1-3,5 P26THR	1953729	50
MCDN 1,5/ 4-G1-3,5 P26THR	1953732	50
MCDN 1,5/ 5-G1-3,5 P26THR	1953745	50
MCDN 1,5/ 6-G1-3,5 P26THR	1953758	50
MCDN 1,5/ 7-G1-3,5 P26THR	1953761	50
MCDN 1,5/ 8-G1-3,5 P26THR	1953774	50
MCDN 1,5/ 9-G1-3,5 P26THR	1953787	50
MCDN 1,5/10-G1-3,5 P26THR	1953790	50
MCDN 1,5/11-G1-3,5 P26THR	1953800	50
MCDN 1,5/12-G1-3,5 P26THR	1953813	50
MCDN 1,5/13-G1-3,5 P26THR	1953826	50
MCDN 1,5/14-G1-3,5 P26THR	1953839	50
MCDN 1,5/15-G1-3,5 P26THR	1953842	50
MCDN 1,5/16-G1-3,5 P26THR	1953855	50
3.81 mm pitch, color: Black		
MCDN 1,5/ 2-G1-3,81 P26THR	1749528	50
MCDN 1,5/ 3-G1-3,81 P26THR	1749531	50
MCDN 1,5/ 4-G1-3,81 P26THR	1749544	50
MCDN 1,5/ 5-G1-3,81 P26THR	1749557	50
MCDN 1,5/ 6-G1-3,81 P26THR	1749560	50
MCDN 1,5/ 7-G1-3,81 P26THR	1749573	50
MCDN 1,5/ 8-G1-3,81 P26THR	1749586	50
MCDN 1,5/ 9-G1-3,81 P26THR	1749599	50
MCDN 1,5/10-G1-3,81 P26THR	1749609	50
MCDN 1,5/11-G1-3,81 P26THR	1749612	50
MCDN 1,5/12-G1-3,81 P26THR	1749625	50
MCDN 1,5/13-G1-3,81 P26THR	1749638	50
MCDN 1,5/14-G1-3,81 P26THR	1749641	50
MCDN 1,5/15-G1-3,81 P26THR	1749654	50
MCDN 1,5/16-G1-3,81 P26THR	1749667	50



Dimensional drawing

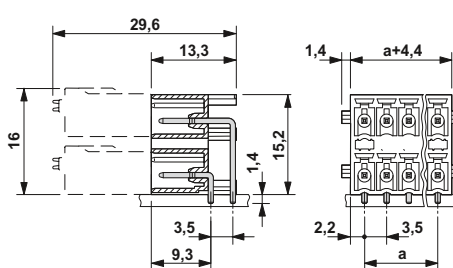

Drilling diagram

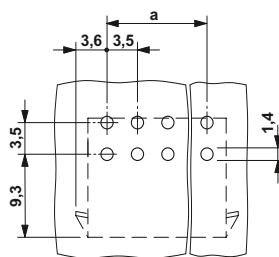

Ordering data

Type	Order No.	Pcs. / Pkt.
Pitch 3.5 mm, color: Black		
MCDN 1,5/ 2-G1-3,5 RNP14THR	1953208	50
MCDN 1,5/ 3-G1-3,5 RNP14THR	1953211	50
MCDN 1,5/ 4-G1-3,5 RNP14THR	1953224	50
MCDN 1,5/ 5-G1-3,5 RNP14THR	1953237	50
MCDN 1,5/ 6-G1-3,5 RNP14THR	1953240	50
MCDN 1,5/ 7-G1-3,5 RNP14THR	1953253	50
MCDN 1,5/ 8-G1-3,5 RNP14THR	1953266	50
MCDN 1,5/ 9-G1-3,5 RNP14THR	1953279	50
MCDN 1,5/10-G1-3,5 RNP14THR	1953282	50
MCDN 1,5/11-G1-3,5 RNP14THR	1953295	50
MCDN 1,5/12-G1-3,5 RNP14THR	1953305	50
MCDN 1,5/13-G1-3,5 RNP14THR	1953318	50
MCDN 1,5/14-G1-3,5 RNP14THR	1953321	50
MCDN 1,5/15-G1-3,5 RNP14THR	1953334	50
MCDN 1,5/16-G1-3,5 RNP14THR	1953350	50



Dimensional drawing

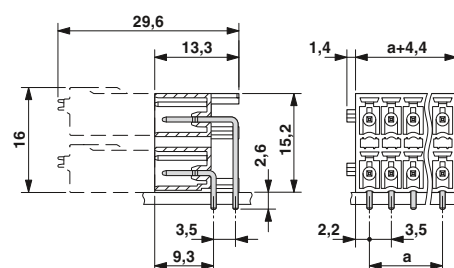

Drilling diagram

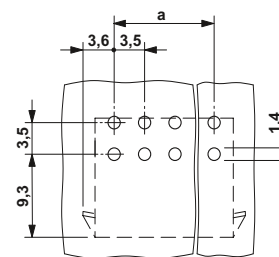

Ordering data

Type	Order No.	Pcs. / Pkt.
Pitch 3.5 mm, color: Black		
MCDN 1,5/ 2-G1-3,5 RNP26THR	1953402	50
MCDN 1,5/ 3-G1-3,5 RNP26THR	1953415	50
MCDN 1,5/ 4-G1-3,5 RNP26THR	1953428	50
MCDN 1,5/ 5-G1-3,5 RNP26THR	1953554	50
MCDN 1,5/ 6-G1-3,5 RNP26THR	1953567	50
MCDN 1,5/ 7-G1-3,5 RNP26THR	1953570	50
MCDN 1,5/ 8-G1-3,5 RNP26THR	1953583	50
MCDN 1,5/ 9-G1-3,5 RNP26THR	1953596	50
MCDN 1,5/10-G1-3,5 RNP26THR	1953606	50
MCDN 1,5/11-G1-3,5 RNP26THR	1953619	50
MCDN 1,5/12-G1-3,5 RNP26THR	1953622	50
MCDN 1,5/13-G1-3,5 RNP26THR	1953635	50
MCDN 1,5/14-G1-3,5 RNP26THR	1953648	50
MCDN 1,5/15-G1-3,5 RNP26THR	1953651	50
MCDN 1,5/16-G1-3,5 RNP26THR	1953664	50

Mini plug-in connectors with 3.5/3.81 and 5.08 mm pitch

MINI COMBICON plug-in connectors, pitches 3.5 or 3.81 and 5.08 mm

Double-level header for reflow processes

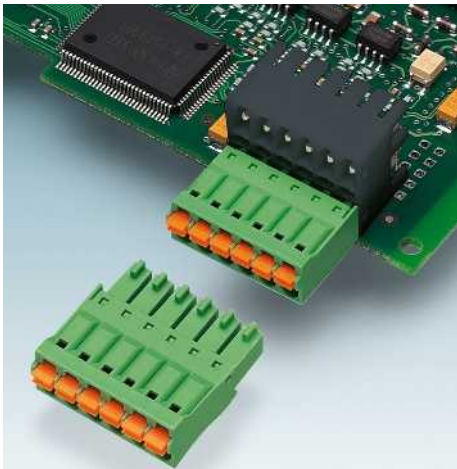



- Application in SMT reflow processes
- THR double-level pin strips with a flat design featuring compact pitches of 3.5 mm and 3.81 mm
- Alternative pin lengths 1.4 mm or 2.6 mm
- Plug-in direction vertical to the PCB
- Without a level offset, for flush installation in the front of the devices
- Versions with engagement noses for locking plugs with self-locking flanges
- Higher numbers of positions up to 20-pos. can be found at: www.phoenixcontact.net/products
- Relevant FMC 1,5/...connectors can be found on page 200

Notes:
In accordance with DIN EN 61984, COMBICON plug-in connectors have no switching power. During designated use, they must not be plugged in or disconnected when carrying voltage or under load.
COMBICON select You will find the possible plug-in connector combinations in COMBICON select at: www.phoenixcontact.net/products or starting on page 182.
Application notes and suggestions for the THR process can be found on page 27.
CP-MSTB may only be used after reflow soldering. CP-MSTB NAT HT may also be used prior to reflow soldering.



1.4 mm pin length, plug-in direction vertical to the PCB

Accessories		
For all types	Type	Page
	Coding profile CP-MSTB Order No. 1734634	38
	Marker cards SK 3,5/2,8 or SK 3,81/2,8	797



Dimensional drawing

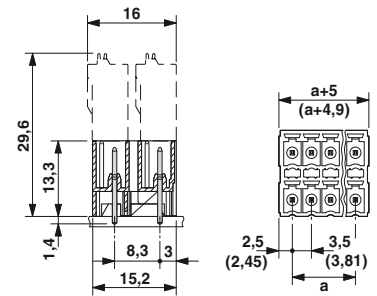

Drilling diagram

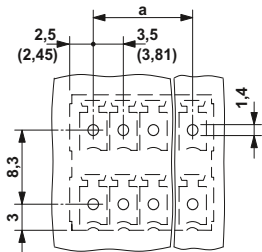

Technical data

Technical data in accordance to IEC / DIN VDE	
Rated current	[A] 8
Rated insulation voltage for pollution degree 2	[V] 200
Pitch	[mm] 3.5 / 3.81
Insulation coordination	III / 3 III / 2 II / 2
Surge voltage category / pollution degree	160 200 250
Rated insulation voltage	[V] 2.5 2.5 2.5
Rated surge voltage	[kV] B C D
Approval data (UL/CUL)	Use Group 150 - 150
Nominal voltage	[V] 8 - 8
Nominal current	[A] - - -
Connection capacity AWG	AWG - - -
Approval data (CSA)	Use Group B C D
Nominal voltage	[V] - - -
Nominal current	[A] - - -
Connection capacity AWG	AWG - - -
General data	
Type of insulation material / insulation material group	LCP / IIIa
Inflammability class according to UL 94	V0
Drill hole diameter / pin dimensions	[mm] 1.4 / 0.8 x 0.8 mm

Ordering data

No. of pos.	Dim. a [mm]	Type	Order No.	Pcs. / Pkt.
Pitch 3.5 mm, color: Black				
2	3.50	MCDNV 1,5/ 2-G1-3,5 P14THR	1952979	50
3	7.00	MCDNV 1,5/ 3-G1-3,5 P14THR	1952982	50
4	10.50	MCDNV 1,5/ 4-G1-3,5 P14THR	1952995	50
5	14.00	MCDNV 1,5/ 5-G1-3,5 P14THR	1953004	50
6	17.50	MCDNV 1,5/ 6-G1-3,5 P14THR	1953046	50
7	21.00	MCDNV 1,5/ 7-G1-3,5 P14THR	1953059	50
8	24.50	MCDNV 1,5/ 8-G1-3,5 P14THR	1953062	50
9	28.00	MCDNV 1,5/ 9-G1-3,5 P14THR	1953075	50
10	31.50	MCDNV 1,5/10-G1-3,5 P14THR	1953088	50
11	35.00	MCDNV 1,5/11-G1-3,5 P14THR	1953101	50
12	38.50	MCDNV 1,5/12-G1-3,5 P14THR	1953114	50
13	42.00	MCDNV 1,5/13-G1-3,5 P14THR	1953127	50
14	45.50	MCDNV 1,5/14-G1-3,5 P14THR	1953130	50
15	49.00	MCDNV 1,5/15-G1-3,5 P14THR	1953143	50
16	52.50	MCDNV 1,5/16-G1-3,5 P14THR	1953156	50
3.81 mm pitch, color: Black				
2	3.81	MCDNV 1,5/ 2-G1-3,81 P14THR	1750106	50
3	7.62	MCDNV 1,5/ 3-G1-3,81 P14THR	1750119	50
4	11.43	MCDNV 1,5/ 4-G1-3,81 P14THR	1750122	50
5	15.24	MCDNV 1,5/ 5-G1-3,81 P14THR	1750135	50
6	19.05	MCDNV 1,5/ 6-G1-3,81 P14THR	1750148	50
7	22.86	MCDNV 1,5/ 7-G1-3,81 P14THR	1750151	50
8	26.67	MCDNV 1,5/ 8-G1-3,81 P14THR	1750164	50
9	30.48	MCDNV 1,5/ 9-G1-3,81 P14THR	1750177	50
10	34.29	MCDNV 1,5/10-G1-3,81 P14THR	1750180	50
11	38.10	MCDNV 1,5/11-G1-3,81 P14THR	1750193	50
12	41.91	MCDNV 1,5/12-G1-3,81 P14THR	1750203	50
13	45.72	MCDNV 1,5/13-G1-3,81 P14THR	1750216	50
14	49.53	MCDNV 1,5/14-G1-3,81 P14THR	1750229	50
15	53.34	MCDNV 1,5/15-G1-3,81 P14THR	1750232	50
16	57.15	MCDNV 1,5/16-G1-3,81 P14THR	1750245	50

Mini plug-in connectors with 3.5/3.81 and 5.08 mm pitch

MINI COMBICON plug-in connectors, pitches 3.5 or 3.81 and 5.08 mm



2.6 mm pin length,
plug-in direction vertical to the PCB



1.4 mm pin length, with engagement noses,
plug-in direction vertical to the PCB



2.6 mm pin length, with engagement noses,
plug-in direction vertical to the PCB



Dimensional drawing

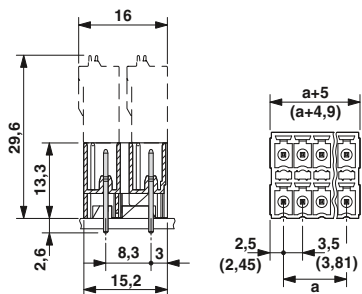

Drilling diagram

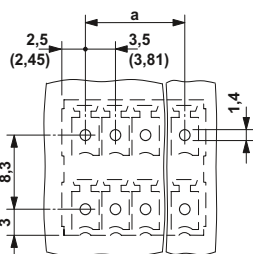

Ordering data

Type	Order No.	Pcs. / Pkt.
Pitch 3.5 mm, color: Black		
MCDNV 1,5/ 2-G1-3,5 P26THR	1952788	50
MCDNV 1,5/ 3-G1-3,5 P26THR	1952791	50
MCDNV 1,5/ 4-G1-3,5 P26THR	1952801	50
MCDNV 1,5/ 5-G1-3,5 P26THR	1952814	50
MCDNV 1,5/ 6-G1-3,5 P26THR	1952827	50
MCDNV 1,5/ 7-G1-3,5 P26THR	1952830	50
MCDNV 1,5/ 8-G1-3,5 P26THR	1952843	50
MCDNV 1,5/ 9-G1-3,5 P26THR	1952856	50
MCDNV 1,5/10-G1-3,5 P26THR	1952869	50
MCDNV 1,5/11-G1-3,5 P26THR	1952872	50
MCDNV 1,5/12-G1-3,5 P26THR	1952885	50
MCDNV 1,5/13-G1-3,5 P26THR	1952898	50
MCDNV 1,5/14-G1-3,5 P26THR	1952908	50
MCDNV 1,5/15-G1-3,5 P26THR	1952911	50
MCDNV 1,5/16-G1-3,5 P26THR	1952924	50
3.81 mm pitch, color: Black		
MCDNV 1,5/ 2-G1-3,81 P26THR	1750290	50
MCDNV 1,5/ 3-G1-3,81 P26THR	1750300	50
MCDNV 1,5/ 4-G1-3,81 P26THR	1750313	50
MCDNV 1,5/ 5-G1-3,81 P26THR	1750326	50
MCDNV 1,5/ 6-G1-3,81 P26THR	1750339	50
MCDNV 1,5/ 7-G1-3,81 P26THR	1750342	50
MCDNV 1,5/ 8-G1-3,81 P26THR	1750355	50
MCDNV 1,5/ 9-G1-3,81 P26THR	1750368	50
MCDNV 1,5/10-G1-3,81 P26THR	1750371	50
MCDNV 1,5/11-G1-3,81 P26THR	1750384	50
MCDNV 1,5/12-G1-3,81 P26THR	1750397	50
MCDNV 1,5/13-G1-3,81 P26THR	1750407	50
MCDNV 1,5/14-G1-3,81 P26THR	1750410	50
MCDNV 1,5/15-G1-3,81 P26THR	1750423	50
MCDNV 1,5/16-G1-3,81 P26THR	1750436	50



Dimensional drawing

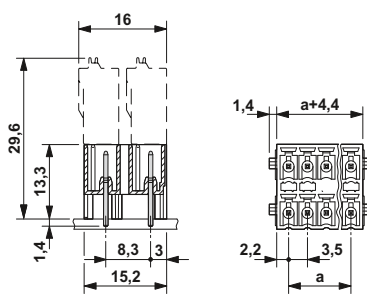

Drilling diagram

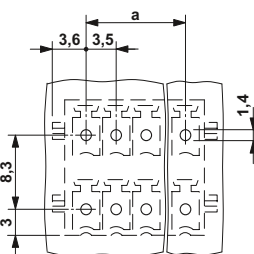

Ordering data

Type	Order No.	Pcs. / Pkt.
Pitch 3.5 mm, color: Black		
MCDNV 1,5/ 2-G1-3,5 RNP14THR	1952500	50
MCDNV 1,5/ 3-G1-3,5 RNP14THR	1952513	50
MCDNV 1,5/ 4-G1-3,5 RNP14THR	1952526	50
MCDNV 1,5/ 5-G1-3,5 RNP14THR	1952539	50
MCDNV 1,5/ 6-G1-3,5 RNP14THR	1952542	50
MCDNV 1,5/ 7-G1-3,5 RNP14THR	1952555	50
MCDNV 1,5/ 8-G1-3,5 RNP14THR	1952568	50
MCDNV 1,5/ 9-G1-3,5 RNP14THR	1952571	50
MCDNV 1,5/10-G1-3,5 RNP14THR	1952584	50
MCDNV 1,5/11-G1-3,5 RNP14THR	1952597	50
MCDNV 1,5/12-G1-3,5 RNP14THR	1952607	50
MCDNV 1,5/13-G1-3,5 RNP14THR	1952610	50
MCDNV 1,5/14-G1-3,5 RNP14THR	1952623	50
MCDNV 1,5/15-G1-3,5 RNP14THR	1952636	50
MCDNV 1,5/16-G1-3,5 RNP14THR	1952649	50



Dimensional drawing

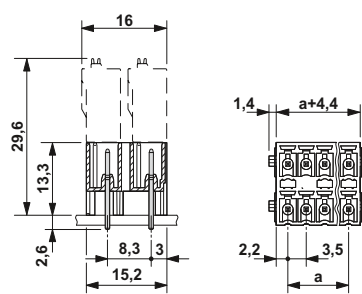

Drilling diagram

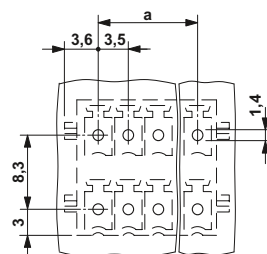

Ordering data

Type	Order No.	Pcs. / Pkt.
Pitch 3.5 mm, color: Black		
MCDNV 1,5/ 2-G1-3,5 RNP26THR	1952458	50
MCDNV 1,5/ 3-G1-3,5 RNP26THR	1952461	50
MCDNV 1,5/ 4-G1-3,5 RNP26THR	1952474	50
MCDNV 1,5/ 5-G1-3,5 RNP26THR	1952487	50
MCDNV 1,5/ 6-G1-3,5 RNP26THR	1952490	50
MCDNV 1,5/ 7-G1-3,5 RNP26THR	1952212	50
MCDNV 1,5/ 8-G1-3,5 RNP26THR	1952225	50
MCDNV 1,5/ 9-G1-3,5 RNP26THR	1952238	50
MCDNV 1,5/10-G1-3,5 RNP26THR	1952241	50
MCDNV 1,5/11-G1-3,5 RNP26THR	1952254	50
MCDNV 1,5/12-G1-3,5 RNP26THR	1952694	50
MCDNV 1,5/13-G1-3,5 RNP26THR	1952704	50
MCDNV 1,5/14-G1-3,5 RNP26THR	1952717	50
MCDNV 1,5/15-G1-3,5 RNP26THR	1952720	50
MCDNV 1,5/16-G1-3,5 RNP26THR	1952733	50

Mini plug-in connectors with 3.5/3.81 and 5.08 mm pitch

MINI COMBICON plug-in connectors, pitches 3.5 or 3.81 and 5.08 mm

Single-level header for press-in technology

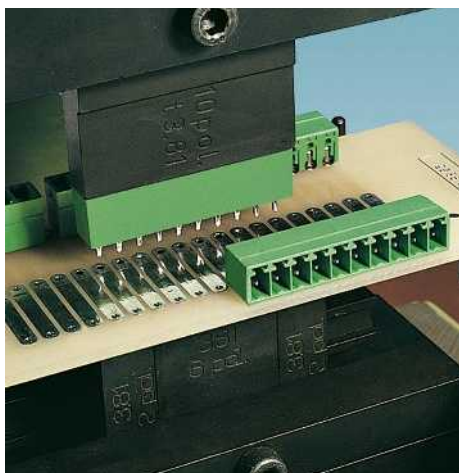

- Pin strips with flexible press-in zone ERNI-PRESS
- Plug-in direction horizontal and vertical to the PCB
- Processing as per EN 60352-5
- Press-in tools available on request
- Versions with and without a threaded flange
- You can find user notes and recommendations for the press-in technology on page 31

Notes:

In accordance with DIN EN 61984, COMBICON plug-in connectors have no switching power. During designated use, they must not be plugged in or disconnected when carrying voltage or under load.

COMBICON select

You will find the possible plug-in connector combinations in COMBICON select at: www.phoenixcontact.net/products or starting on page 182.





Mounting screws for base element with threaded flange (....GF...): sheet metal screw ISO 1481-ST 2,2x4,5 C or ISO 7049-ST 2,2x4,5 C.

For the structure of the plated bore hole for EMC 1,5/...-G(F)-... and EMCV 1,5/...-G(F)-... see page 31.



Plug-in direction parallel to the PCB

Accessories

For all types	Type	Page
	Coding profile CP-MSTB Order No. 1734634	38
	Marker cards SK 3,5/2,8 or SK 3,81/2,8	797
	Stamp holder EMC 1,5-SH Order No. 1877258	826
Only for EMCV 1,5/...-G(F)-3,81		
	Stamp set EMCV 1,5-SS 1 Order No. 1877274	826

Dimensional drawing

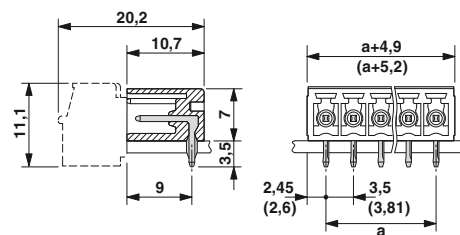

Drilling diagram

Minimum printed circuit board thickness 1.5 mm

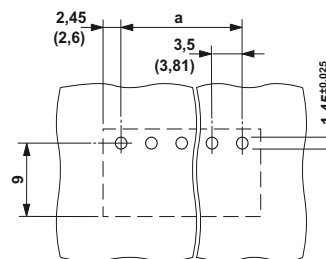

Technical data

Technical data in accordance to IEC / DIN VDE	
Rated current	[A] 8
Rated insulation voltage for pollution degree 2	[V] 160
Pitch	[mm] 3.5 / 3.81
Insulation coordination	
Surge voltage category / pollution degree	III / 3 III / 2 II / 2
Rated insulation voltage	[V] 160 160 250
Rated surge voltage	[kV] 2.5 2.5 2.5
Approval data (UL/CUL)	Use Group B C D
Nominal voltage	[V] 300 - 300
Nominal current	[A] 8 - 8
Connection capacity AWG	AWG - - -
Approval data (CSA)	Use Group B C D
Nominal voltage	[V] - - -
Nominal current	[A] - - -
Connection capacity AWG	AWG - - -
General data	
Type of insulation material / insulation material group	PBT / IIIa
Inflammability class according to UL 94	V0
Drill hole diameter / pin dimensions	[mm] 1.45 / 0,8 x 0,8 mm

Ordering data

Type	Order No.	Pcs. / Pkt.
3.5 mm pitch, color: green		
EMC 1,5/ 2-G-3,5	1897092	50
EMC 1,5/ 3-G-3,5	1897102	50
EMC 1,5/ 4-G-3,5	1897115	50
EMC 1,5/ 5-G-3,5	1897128	50
EMC 1,5/ 6-G-3,5	1897131	50
EMC 1,5/ 7-G-3,5	1897144	50
EMC 1,5/ 8-G-3,5	1897157	50
EMC 1,5/ 9-G-3,5	1897160	50
EMC 1,5/10-G-3,5	1897173	50
EMC 1,5/11-G-3,5	1897186	50
EMC 1,5/12-G-3,5	1897199	50
EMC 1,5/13-G-3,5	1897209	50
EMC 1,5/14-G-3,5	1897212	50
EMC 1,5/15-G-3,5	1897225	50
EMC 1,5/16-G-3,5	1897238	50
Pitch 3.81 mm, color: green		
EMC 1,5/ 2-G-3,81	1897801	50
EMC 1,5/ 3-G-3,81	1897814	50
EMC 1,5/ 4-G-3,81	1897827	50
EMC 1,5/ 5-G-3,81	1897830	50
EMC 1,5/ 6-G-3,81	1897843	50
EMC 1,5/ 7-G-3,81	1897856	50
EMC 1,5/ 8-G-3,81	1897869	50
EMC 1,5/ 9-G-3,81	1897872	50
EMC 1,5/10-G-3,81	1897885	50
EMC 1,5/11-G-3,81	1897898	50
EMC 1,5/12-G-3,81	1897908	50
EMC 1,5/13-G-3,81	1897911	50
EMC 1,5/14-G-3,81	1897924	50
EMC 1,5/15-G-3,81	1897937	50
EMC 1,5/16-G-3,81	1897940	50



With threaded flange,
plug-in direction parallel to the PCB



Plug-in direction vertical to the PCB



With threaded flange, plug-in direction vertical to the PCB



Dimensional drawing

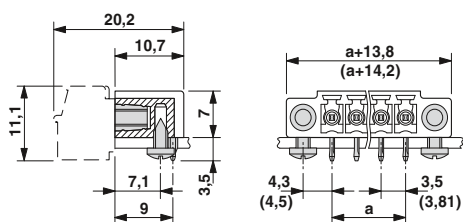

Drilling diagram

Minimum printed circuit board thickness 1.5 mm

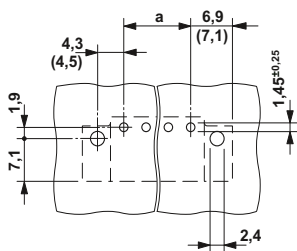

Ordering data

Type	Order No.	Pcs. / Pkt.
3.5 mm pitch, color: green		
EMC 1,5/ 2-GF-3,5	1897241	50
EMC 1,5/ 3-GF-3,5	1897254	50
EMC 1,5/ 4-GF-3,5	1897267	50
EMC 1,5/ 5-GF-3,5	1897270	50
EMC 1,5/ 6-GF-3,5	1897283	50
EMC 1,5/ 7-GF-3,5	1897296	50
EMC 1,5/ 8-GF-3,5	1897306	50
EMC 1,5/ 9-GF-3,5	1897319	50
EMC 1,5/10-GF-3,5	1897322	50
EMC 1,5/11-GF-3,5	1897335	50
EMC 1,5/12-GF-3,5	1897348	50
EMC 1,5/13-GF-3,5	1897351	50
EMC 1,5/14-GF-3,5	1897364	50
EMC 1,5/15-GF-3,5	1897377	50
EMC 1,5/16-GF-3,5	1897380	50
Pitch 3.81 mm, color: green		
EMC 1,5/ 2-GF-3,81	1896941	50
EMC 1,5/ 3-GF-3,81	1896954	50
EMC 1,5/ 4-GF-3,81	1896967	50
EMC 1,5/ 5-GF-3,81	1896970	50
EMC 1,5/ 6-GF-3,81	1896983	50
EMC 1,5/ 7-GF-3,81	1896996	50
EMC 1,5/ 8-GF-3,81	1897005	50
EMC 1,5/ 9-GF-3,81	1897018	50
EMC 1,5/10-GF-3,81	1897021	50
EMC 1,5/11-GF-3,81	1897034	50
EMC 1,5/12-GF-3,81	1897047	50
EMC 1,5/13-GF-3,81	1897050	50
EMC 1,5/14-GF-3,81	1897063	50
EMC 1,5/15-GF-3,81	1897076	50
EMC 1,5/16-GF-3,81	1897089	50



Dimensional drawing

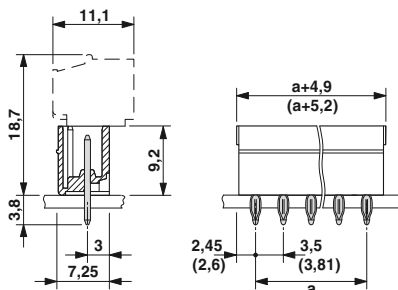

Drilling diagram

Minimum printed circuit board thickness 1.5 mm

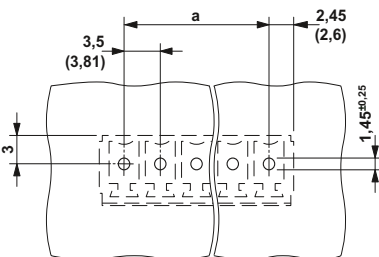

Ordering data

Type	Order No.	Pcs. / Pkt.
3.5 mm pitch, color: green		
EMCV 1,5/ 2-G-3,5	1911017	50
EMCV 1,5/ 3-G-3,5	1911020	50
EMCV 1,5/ 4-G-3,5	1911033	50
EMCV 1,5/ 5-G-3,5	1911046	50
EMCV 1,5/ 6-G-3,5	1911059	50
EMCV 1,5/ 7-G-3,5	1911062	50
EMCV 1,5/ 8-G-3,5	1911075	50
EMCV 1,5/ 9-G-3,5	1911088	50
EMCV 1,5/10-G-3,5	1911091	50
EMCV 1,5/11-G-3,5	1911101	50
EMCV 1,5/12-G-3,5	1911114	50
EMCV 1,5/13-G-3,5	1911127	50
EMCV 1,5/14-G-3,5	1911130	50
EMCV 1,5/15-G-3,5	1911143	50
EMCV 1,5/16-G-3,5	1911156	50
Pitch 3.81 mm, color: green		
EMCV 1,5/ 2-G-3,81	1860647	50
EMCV 1,5/ 3-G-3,81	1860650	50
EMCV 1,5/ 4-G-3,81	1860663	50
EMCV 1,5/ 5-G-3,81	1860676	50
EMCV 1,5/ 6-G-3,81	1860689	50
EMCV 1,5/ 7-G-3,81	1860692	50
EMCV 1,5/ 8-G-3,81	1860702	50
EMCV 1,5/ 9-G-3,81	1860715	50
EMCV 1,5/10-G-3,81	1860728	50
EMCV 1,5/11-G-3,81	1860731	50
EMCV 1,5/12-G-3,81	1860744	50
EMCV 1,5/13-G-3,81	1860757	50
EMCV 1,5/14-G-3,81	1860760	50
EMCV 1,5/15-G-3,81	1860773	50
EMCV 1,5/16-G-3,81	1860786	50



Dimensional drawing

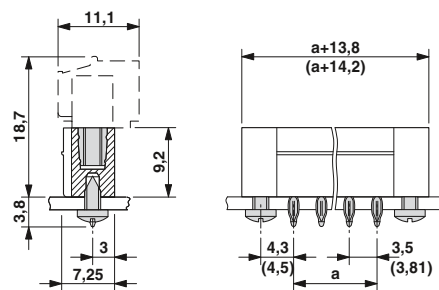

Drilling diagram

Minimum printed circuit board thickness 1.5 mm

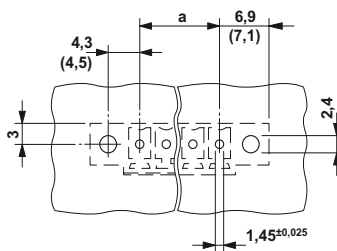

Ordering data

Type	Order No.	Pcs. / Pkt.
3.5 mm pitch, color: green		
EMCV 1,5/ 2-GF-3,5	1911169	50
EMCV 1,5/ 3-GF-3,5	1911172	50
EMCV 1,5/ 4-GF-3,5	1911185	50
EMCV 1,5/ 5-GF-3,5	1911198	50
EMCV 1,5/ 6-GF-3,5	1911208	50
EMCV 1,5/ 7-GF-3,5	1911211	50
EMCV 1,5/ 8-GF-3,5	1911224	50
EMCV 1,5/ 9-GF-3,5	1911237	50
EMCV 1,5/10-GF-3,5	1911240	50
EMCV 1,5/11-GF-3,5	1911253	50
EMCV 1,5/12-GF-3,5	1911266	50
EMCV 1,5/13-GF-3,5	1911279	50
EMCV 1,5/14-GF-3,5	1911282	50
EMCV 1,5/15-GF-3,5	1911295	50
EMCV 1,5/16-GF-3,5	1911305	50
Pitch 3.81 mm, color: green		
EMCV 1,5/ 2-GF-3,81	1879285	50
EMCV 1,5/ 3-GF-3,81	1879298	50
EMCV 1,5/ 4-GF-3,81	1879308	50
EMCV 1,5/ 5-GF-3,81	1879311	50
EMCV 1,5/ 6-GF-3,81	1879324	50
EMCV 1,5/ 7-GF-3,81	1879337	50
EMCV 1,5/ 8-GF-3,81	1879340	50
EMCV 1,5/ 9-GF-3,81	1879353	50
EMCV 1,5/10-GF-3,81	1879366	50
EMCV 1,5/11-GF-3,81	1879379	50
EMCV 1,5/12-GF-3,81	1879382	50
EMCV 1,5/13-GF-3,81	1879395	50
EMCV 1,5/14-GF-3,81	1879405	50
EMCV 1,5/15-GF-3,81	1879418	50
EMCV 1,5/16-GF-3,81	1879421	50

Mini plug-in connectors with 3.5/3.81 and 5.08 mm pitch

MINI COMBICON plug-in connectors, pitches 3.5 or 3.81 and 5.08 mm

Single-level header for the wave soldering processes

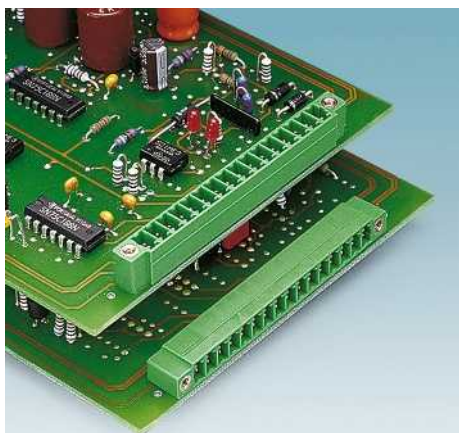

- Low-profile pin strips with compact pitches
- Plug-in direction parallel and vertical to the PCB
- Versions with and without a threaded flange
- Versions with engagement noses for locking plugs with self-locking flanges
- Versions with Lock & Release locking and threaded flange can be used with plugs with Lock & Release or with screw flange
- Individual position coding by inserting the coding profiles
- Higher numbers of positions up to 20-pos. can be found at: www.phoenixcontact.net/products

Notes:

In accordance with DIN EN 61984, COMBICON plug-in connectors have no switching power. During designated use, they must not be plugged in or disconnected when carrying voltage or under load.

COMBICON select

You will find the possible plug-in connector combinations in COMBICON select at: www.phoenixcontact.net/products or starting on page 182.

Mounting screws for base element with threaded flange (...GF...): sheet metal screw ISO 1481-ST 2,2x4,5 C or ISO 7049-ST 2,2x4,5 C. Screw connection only permitted prior to soldering.



Plug-in direction parallel to the PCB



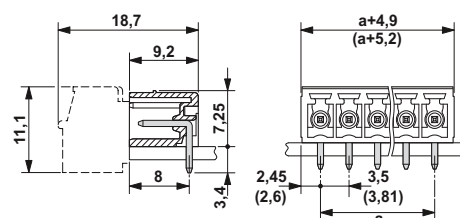

Dimensional drawing

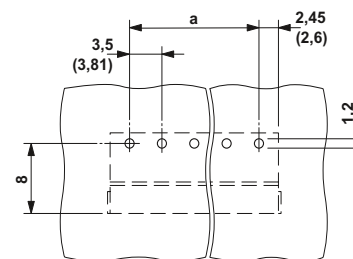

Drilling diagram



Accessories		
For all types	Type	Page
	Coding profile CP-MSTB Order No. 1734634	38
	Marker cards SK 3,5/2,8 or SK 3,81/2,8	797

Technical data

Technical data in accordance to IEC / DIN VDE	
Rated current	[A] 8
Rated insulation voltage for pollution degree 2	[V] 160
Pitch	[mm] 3.5 / 3.81
Insulation coordination	III / 3 III / 2 II / 2
Surge voltage category / pollution degree	160 160 250
Rated insulation voltage	[V] 2.5 2.5 2.5
Rated surge voltage	[kV] B C D
Approval data (UL/CUL)	Use Group 300 - 300
Nominal voltage	[V] 8 - 8
Nominal current	[A] - - -
Connection capacity AWG	AWG B C D
Approval data (CSA)	Use Group 300 - 300
Nominal voltage	[V] 8 - 8
Nominal current	[A] - - -
Connection capacity AWG	AWG
General data	
Type of insulation material / insulation material group	PBT / IIIa
Inflammability class according to UL 94	V0
Drill hole diameter / pin dimensions	[mm] 1.2 / 0,8 x 0,8 mm

Ordering data

Type	Order No.	Pcs. / Pkt.
3.5 mm pitch, color: green		
MC 1,5/ 2-G-3,5	1844210	250
MC 1,5/ 3-G-3,5	1844223	250
MC 1,5/ 4-G-3,5	1844236	250
MC 1,5/ 5-G-3,5	1844249	250
MC 1,5/ 6-G-3,5	1844252	100
MC 1,5/ 7-G-3,5	1844265	100
MC 1,5/ 8-G-3,5	1844278	100
MC 1,5/ 9-G-3,5	1844281	100
MC 1,5/10-G-3,5	1844294	100
MC 1,5/11-G-3,5	1844304	50
MC 1,5/12-G-3,5	1844317	50
MC 1,5/13-G-3,5	1844320	50
MC 1,5/14-G-3,5	1844333	50
MC 1,5/15-G-3,5	1844346	50
MC 1,5/16-G-3,5	1844359	50
Pitch 3.81 mm, color: green		
MC 1,5/ 2-G-3,81	1803277	250
MC 1,5/ 3-G-3,81	1803280	250
MC 1,5/ 4-G-3,81	1803293	250
MC 1,5/ 5-G-3,81	1803303	250
MC 1,5/ 6-G-3,81	1803316	100
MC 1,5/ 7-G-3,81	1803329	100
MC 1,5/ 8-G-3,81	1803332	100
MC 1,5/ 9-G-3,81	1803345	100
MC 1,5/10-G-3,81	1803358	100
MC 1,5/11-G-3,81	1803361	50
MC 1,5/12-G-3,81	1803374	50
MC 1,5/13-G-3,81	1803387	50
MC 1,5/14-G-3,81	1803390	50
MC 1,5/15-G-3,81	1803400	50
MC 1,5/16-G-3,81	1803413	50



With engagement noses, plug-in direction parallel to the PCB



With threaded flange, plug-in direction parallel to the PCB



With Lock & Release mechanism and threaded flange, plug-in direction parallel to the PCB



Dimensional drawing

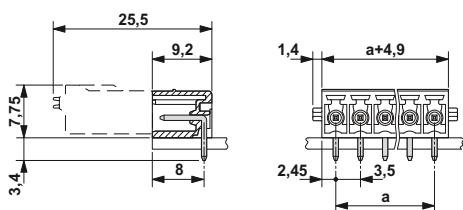

Drilling diagram

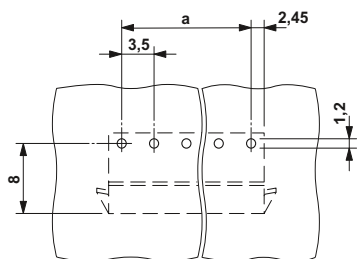

Ordering data

Type	Order No.	Pcs. / Pkt.
3.5 mm pitch, color: green		
MC 1,5/ 2-G-3,5-RN	1731675	50
MC 1,5/ 3-G-3,5-RN	1731688	50
MC 1,5/ 4-G-3,5-RN	1731691	50
MC 1,5/ 5-G-3,5-RN	1731701	50
MC 1,5/ 6-G-3,5-RN	1731714	50
MC 1,5/ 7-G-3,5-RN	1731727	50
MC 1,5/ 8-G-3,5-RN	1731730	50
MC 1,5/ 9-G-3,5-RN	1731743	50
MC 1,5/10-G-3,5-RN	1731756	50
MC 1,5/11-G-3,5-RN	1731769	50
MC 1,5/12-G-3,5-RN	1731772	50
MC 1,5/13-G-3,5-RN	1731785	50
MC 1,5/14-G-3,5-RN	1731798	50
MC 1,5/15-G-3,5-RN	1731808	50
MC 1,5/16-G-3,5-RN	1731811	50



Dimensional drawing

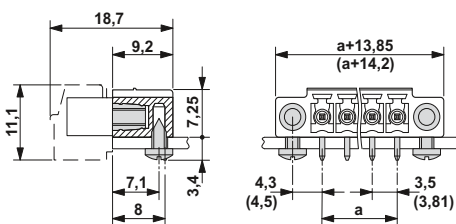

Drilling diagram

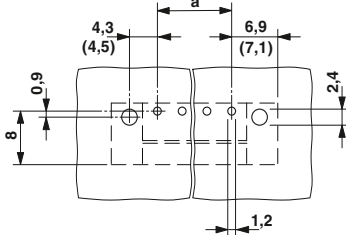

Ordering data

Type	Order No.	Pcs. / Pkt.
3.5 mm pitch, color: green		
MC 1,5/ 2-GF-3,5	1843790	250
MC 1,5/ 3-GF-3,5	1843800	250
MC 1,5/ 4-GF-3,5	1843813	250
MC 1,5/ 5-GF-3,5	1843826	250
MC 1,5/ 6-GF-3,5	1843839	100
MC 1,5/ 7-GF-3,5	1843842	100
MC 1,5/ 8-GF-3,5	1843855	100
MC 1,5/ 9-GF-3,5	1843868	100
MC 1,5/10-GF-3,5	1843871	100
MC 1,5/11-GF-3,5	1843884	50
MC 1,5/12-GF-3,5	1843897	50
MC 1,5/13-GF-3,5	1843907	50
MC 1,5/14-GF-3,5	1843910	50
MC 1,5/15-GF-3,5	1843923	50
MC 1,5/16-GF-3,5	1843936	50
Pitch 3.81 mm, color: green		
MC 1,5/ 2-GF-3,81	1827868	250
MC 1,5/ 3-GF-3,81	1827871	250
MC 1,5/ 4-GF-3,81	1827884	250
MC 1,5/ 5-GF-3,81	1827897	250
MC 1,5/ 6-GF-3,81	1827907	100
MC 1,5/ 7-GF-3,81	1827910	100
MC 1,5/ 8-GF-3,81	1827923	100
MC 1,5/ 9-GF-3,81	1827936	100
MC 1,5/10-GF-3,81	1827949	100
MC 1,5/11-GF-3,81	1827952	50
MC 1,5/12-GF-3,81	1827965	50
MC 1,5/13-GF-3,81	1827978	50
MC 1,5/14-GF-3,81	1827981	50
MC 1,5/15-GF-3,81	1827994	50
MC 1,5/16-GF-3,81	1828003	50

Dimensional drawing

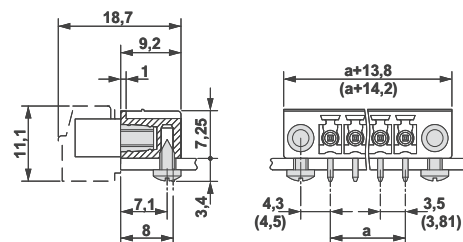

Drilling diagram

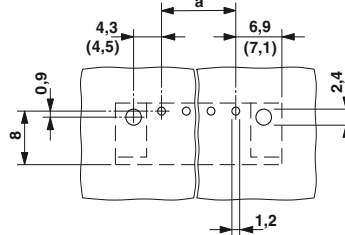

Ordering data

Type	Order No.	Pcs. / Pkt.
3.5 mm pitch, color: green		
MC 1,5/ 2-GF-3,5-LR	1817615	50
MC 1,5/ 3-GF-3,5-LR	1817628	50
MC 1,5/ 4-GF-3,5-LR	1817631	50
MC 1,5/ 5-GF-3,5-LR	1817644	50
MC 1,5/ 6-GF-3,5-LR	1817657	50
MC 1,5/ 7-GF-3,5-LR	1817660	50
MC 1,5/ 8-GF-3,5-LR	1817673	50
MC 1,5/ 9-GF-3,5-LR	1817686	50
MC 1,5/10-GF-3,5-LR	1817699	50
MC 1,5/11-GF-3,5-LR	1817709	50
MC 1,5/12-GF-3,5-LR	1817712	50
MC 1,5/13-GF-3,5-LR	1817725	50
MC 1,5/14-GF-3,5-LR	1817738	50
MC 1,5/15-GF-3,5-LR	1817741	50
MC 1,5/16-GF-3,5-LR	1817754	50
Pitch 3.81 mm, color: green		
MC 1,5/ 2-GF-3,81-LR	1817806	50
MC 1,5/ 3-GF-3,81-LR	1817819	50
MC 1,5/ 4-GF-3,81-LR	1817822	50
MC 1,5/ 5-GF-3,81-LR	1817835	50
MC 1,5/ 6-GF-3,81-LR	1817848	50
MC 1,5/ 7-GF-3,81-LR	1817851	50
MC 1,5/ 8-GF-3,81-LR	1817864	50
MC 1,5/ 9-GF-3,81-LR	1817877	50
MC 1,5/10-GF-3,81-LR	1817880	50
MC 1,5/11-GF-3,81-LR	1817893	50
MC 1,5/12-GF-3,81-LR	1817903	50
MC 1,5/13-GF-3,81-LR	1817916	50
MC 1,5/14-GF-3,81-LR	1817929	50
MC 1,5/15-GF-3,81-LR	1817932	50
MC 1,5/16-GF-3,81-LR	1817945	50

Mini plug-in connectors with 3.5/3.81 and 5.08 mm pitch

MINI COMBICON plug-in connectors, pitches 3.5 or 3.81 and 5.08 mm

Single-level header for the wave soldering processes

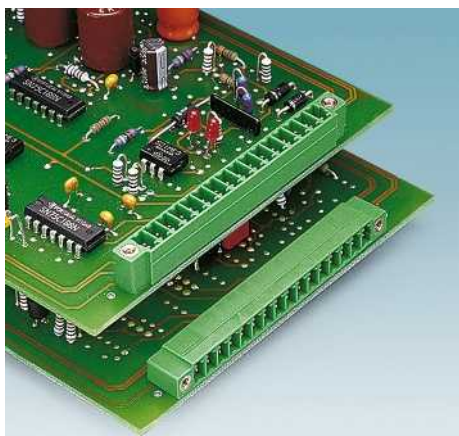

- Low-profile pin strips with compact pitches
- Plug-in direction vertical to the PCB
- Versions with and without a threaded flange
- Versions with engagement noses for locking plugs with self-locking flanges
- Versions with Lock & Release locking and threaded flange can be used with plugs with Lock & Release or with screw flange

Notes:

In accordance with DIN EN 61984, COMBICON plug-in connectors have no switching power. During designated use, they must not be plugged in or disconnected when carrying voltage or under load.

COMBICON select

You will find the possible plug-in connector combinations in COMBICON select at: www.phoenixcontact.net/products or starting on page 182.



Mounting screws for base element with threaded flange (...GF...): sheet metal screw ISO 1481-ST 2,2x4,5 C or ISO 7049-ST 2,2x4,5 C. Screw connection only permitted prior to soldering.



Plug-in direction vertical to the PCB



Accessories

For all types	Type	Page
	Coding profile CP-MSTB Order No. 1734634	38
	Marker cards SK 3,81/2,8	797

Dimensional drawing

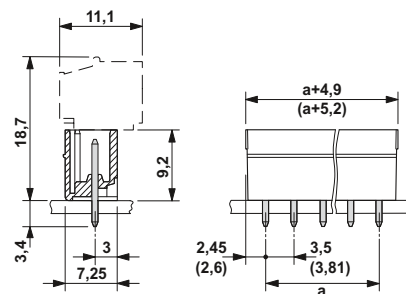

Drilling diagram

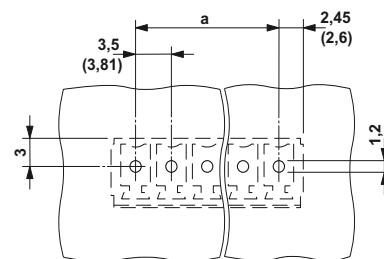

Technical data

Technical data in accordance to IEC / DIN VDE

Rated current	[A]	8
Rated insulation voltage for pollution degree 2	[V]	160
Pitch	[mm]	3.5 / 3.81
Insulation coordination		
Surge voltage category / pollution degree		III / 3 III / 2 II / 2
Rated insulation voltage	[V]	160 160 250
Rated surge voltage	[kV]	2.5 2.5 2.5
Approval data (UL/CUL)	Use Group	B C D
Nominal voltage	[V]	300 - 300
Nominal current	[A]	8 - 8
Connection capacity AWG	AWG	- - -
Approval data (CSA)	Use Group	B C D
Nominal voltage	[V]	300 - 300
Nominal current	[A]	8 - 8
Connection capacity AWG	AWG	- - -
General data		
Type of insulation material / insulation material group		PBT / IIIa
Inflammability class according to UL 94		V0
Drill hole diameter / pin dimensions	[mm]	1.2 / 0,8 x 0,8 mm

Ordering data

No. of pos.	Dim. a [mm]	Type	Order No.	Pcs. / Pkt.
3.5 mm pitch, color: green				
2	3.50	MCV 1,5/ 2-G-3,5	1843606	250
3	7.00	MCV 1,5/ 3-G-3,5	1843619	250
4	10.50	MCV 1,5/ 4-G-3,5	1843622	250
5	14.00	MCV 1,5/ 5-G-3,5	1843635	250
6	17.50	MCV 1,5/ 6-G-3,5	1843648	100
7	21.00	MCV 1,5/ 7-G-3,5	1843651	100
8	24.50	MCV 1,5/ 8-G-3,5	1843664	100
9	28.00	MCV 1,5/ 9-G-3,5	1843677	100
10	31.50	MCV 1,5/10-G-3,5	1843680	100
11	35.00	MCV 1,5/11-G-3,5	1843693	50
12	38.50	MCV 1,5/12-G-3,5	1843703	50
13	42.00	MCV 1,5/13-G-3,5	1843716	50
14	45.50	MCV 1,5/14-G-3,5	1843729	50
15	49.00	MCV 1,5/15-G-3,5	1843732	50
16	52.50	MCV 1,5/16-G-3,5	1843745	50
Pitch 3.81 mm, color: green				
2	3.81	MCV 1,5/ 2-G-3,81	1803426	250
3	7.62	MCV 1,5/ 3-G-3,81	1803439	250
4	11.43	MCV 1,5/ 4-G-3,81	1803442	250
5	15.24	MCV 1,5/ 5-G-3,81	1803455	250
6	19.05	MCV 1,5/ 6-G-3,81	1803468	100
7	22.86	MCV 1,5/ 7-G-3,81	1803471	100
8	26.67	MCV 1,5/ 8-G-3,81	1803484	100
9	30.48	MCV 1,5/ 9-G-3,81	1803497	100
10	34.29	MCV 1,5/10-G-3,81	1803507	100
11	38.10	MCV 1,5/11-G-3,81	1803510	50
12	41.91	MCV 1,5/12-G-3,81	1803523	50
13	45.72	MCV 1,5/13-G-3,81	1803536	50
14	49.53	MCV 1,5/14-G-3,81	1803549	50
15	53.34	MCV 1,5/15-G-3,81	1803552	50
16	57.15	MCV 1,5/16-G-3,81	1803565	50

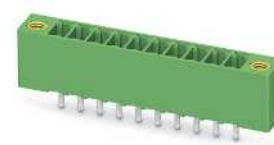
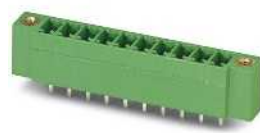

With engagement noses, plug-in direction vertical to the PCB

With threaded flange, plug-in direction vertical to the PCB

With Lock & Release mechanism and threaded flange, plug-in direction parallel to the PCB



Dimensional drawing

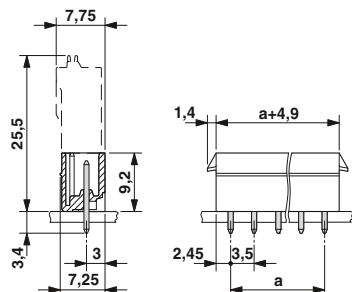

Drilling diagram

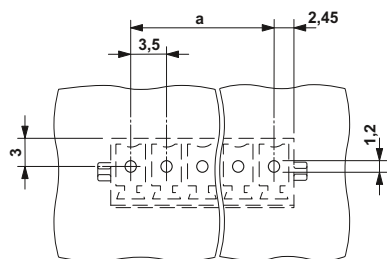

Ordering data

Type	Order No.	Pcs. / Pkt.
3.5 mm pitch, color: green		
MCV 1,5/ 2-G-3,5-RN	1731471	50
MCV 1,5/ 3-G-3,5-RN	1731484	50
MCV 1,5/ 4-G-3,5-RN	1731497	50
MCV 1,5/ 5-G-3,5-RN	1731510	50
MCV 1,5/ 6-G-3,5-RN	1731523	50
MCV 1,5/ 7-G-3,5-RN	1731536	50
MCV 1,5/ 8-G-3,5-RN	1731549	50
MCV 1,5/ 9-G-3,5-RN	1731552	50
MCV 1,5/10-G-3,5-RN	1731565	50
MCV 1,5/11-G-3,5-RN	1731578	50
MCV 1,5/12-G-3,5-RN	1731581	50
MCV 1,5/13-G-3,5-RN	1731594	50
MCV 1,5/14-G-3,5-RN	1731604	50
MCV 1,5/15-G-3,5-RN	1731617	50
MCV 1,5/16-G-3,5-RN	1731620	50

Dimensional drawing

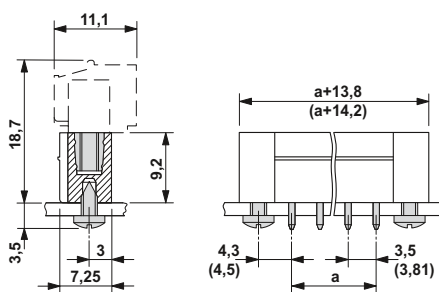

Drilling diagram

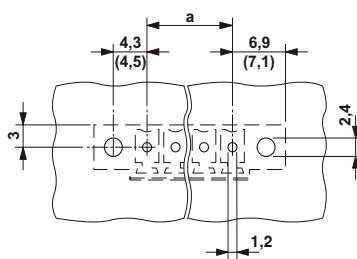

Ordering data

Type	Order No.	Pcs. / Pkt.
3.5 mm pitch, color: green		
MCV 1,5/ 2-GF-3,5	1843224	250
MCV 1,5/ 3-GF-3,5	1843237	250
MCV 1,5/ 4-GF-3,5	1843240	250
MCV 1,5/ 5-GF-3,5	1843253	250
MCV 1,5/ 6-GF-3,5	1843266	100
MCV 1,5/ 7-GF-3,5	1843279	100
MCV 1,5/ 8-GF-3,5	1843282	100
MCV 1,5/ 9-GF-3,5	1843295	100
MCV 1,5/10-GF-3,5	1843305	100
MCV 1,5/11-GF-3,5	1843318	50
MCV 1,5/12-GF-3,5	1843321	50
MCV 1,5/13-GF-3,5	1843334	50
MCV 1,5/14-GF-3,5	1843347	50
MCV 1,5/15-GF-3,5	1843350	50
MCV 1,5/16-GF-3,5	1843363	50
Pitch 3.81 mm, color: green		
MCV 1,5/ 2-GF-3,81	1830596	250
MCV 1,5/ 3-GF-3,81	1830606	250
MCV 1,5/ 4-GF-3,81	1830619	250
MCV 1,5/ 5-GF-3,81	1830622	250
MCV 1,5/ 6-GF-3,81	1830635	100
MCV 1,5/ 7-GF-3,81	1830648	100
MCV 1,5/ 8-GF-3,81	1830651	100
MCV 1,5/ 9-GF-3,81	1830664	100
MCV 1,5/10-GF-3,81	1830677	100
MCV 1,5/11-GF-3,81	1830680	50
MCV 1,5/12-GF-3,81	1830693	50
MCV 1,5/13-GF-3,81	1830703	50
MCV 1,5/14-GF-3,81	1830716	50
MCV 1,5/15-GF-3,81	1830729	50
MCV 1,5/16-GF-3,81	1830732	50

Dimensional drawing

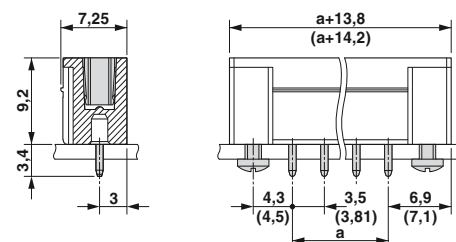

Drilling diagram

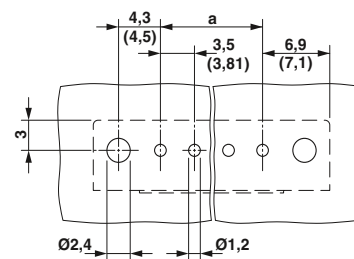

Ordering data

Type	Order No.	Pcs. / Pkt.
3.5 mm pitch, color: green		
MCV 1,5/ 2-GF-3,5-LR	1817990	50
MCV 1,5/ 3-GF-3,5-LR	1818009	50
MCV 1,5/ 4-GF-3,5-LR	1818012	50
MCV 1,5/ 5-GF-3,5-LR	1818025	50
MCV 1,5/ 6-GF-3,5-LR	1818038	50
MCV 1,5/ 7-GF-3,5-LR	1818041	50
MCV 1,5/ 8-GF-3,5-LR	1818054	50
MCV 1,5/ 9-GF-3,5-LR	1818067	50
MCV 1,5/10-GF-3,5-LR	1818070	50
MCV 1,5/11-GF-3,5-LR	1818083	50
MCV 1,5/12-GF-3,5-LR	1818096	50
MCV 1,5/13-GF-3,5-LR	1818106	50
MCV 1,5/14-GF-3,5-LR	1818119	50
MCV 1,5/15-GF-3,5-LR	1818122	50
MCV 1,5/16-GF-3,5-LR	1818135	50
Pitch 3.81 mm, color: green		
MCV 1,5/ 2-GF-3,81-LR	1818180	50
MCV 1,5/ 3-GF-3,81-LR	1818193	50
MCV 1,5/ 4-GF-3,81-LR	1818203	50
MCV 1,5/ 5-GF-3,81-LR	1818216	50
MCV 1,5/ 6-GF-3,81-LR	1818229	50
MCV 1,5/ 7-GF-3,81-LR	1818232	50
MCV 1,5/ 8-GF-3,81-LR	1818245	50
MCV 1,5/ 9-GF-3,81-LR	1818258	50
MCV 1,5/10-GF-3,81-LR	1818261	50
MCV 1,5/11-GF-3,81-LR	1818274	50
MCV 1,5/12-GF-3,81-LR	1818287	50
MCV 1,5/13-GF-3,81-LR	1818290	50
MCV 1,5/14-GF-3,81-LR	1818300	50
MCV 1,5/15-GF-3,81-LR	1818313	50
MCV 1,5/16-GF-3,81-LR	1818326	50

Mini plug-in connectors with 3.5/3.81 and 5.08 mm pitch

MINI COMBICON plug-in connectors, pitches 3.5 or 3.81 and 5.08 mm

Single-level header for the wave soldering processes

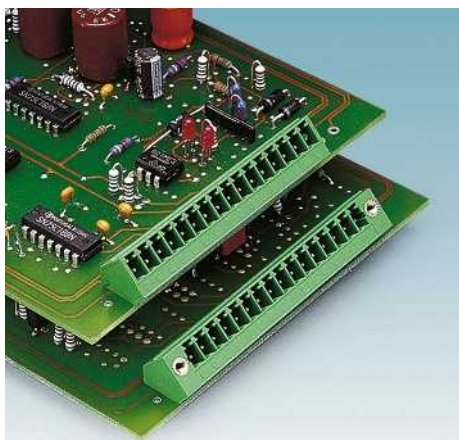

- Low-profile pin strips with compact pitches
- Plug-in direction at an angle of 45° to the PCB
- 45° angle makes it easier to plug in the connector in restricted spaces
- Versions with and without a threaded flange

Notes:

In accordance with DIN EN 61984, COMBICON plug-in connectors have no switching power. During designated use, they must not be plugged in or disconnected when carrying voltage or under load.

COMBICON select



You will find the possible plug-in connector combinations in COMBICON select at: www.phoenixcontact.net/products or starting on page 182.



Plug-in direction 45° to the PCB



Accessories

For all types	Type	Page
	Coding profile CP-MSTB Order No. 1734634	38
	Marker cards SK 3,81/2,8	797

Dimensional drawing

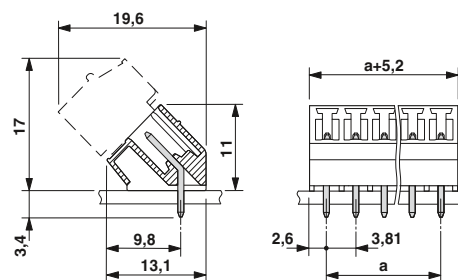

Drilling diagram

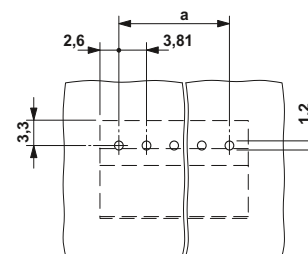

Technical data

Technical data in accordance to IEC / DIN VDE

Rated current	[A]	8
Rated insulation voltage for pollution degree 2	[V]	160
Pitch	[mm]	3.81
Insulation coordination		
Surge voltage category / pollution degree		III / 3 III / 2 II / 2
Rated insulation voltage	[V]	160 160 320
Rated surge voltage	[kV]	2.5 2.5 2.5
Approval data (UL/CUL)	Use Group	B C D
Nominal voltage	[V]	300 - 300
Nominal current	[A]	8 - 8
Connection capacity AWG	AWG	- - -
Approval data (CSA)	Use Group	B C D
Nominal voltage	[V]	300 - 300
Nominal current	[A]	8 - 8
Connection capacity AWG	AWG	- - -
General data		
Type of insulation material / insulation material group		PA / I
Inflammability class according to UL 94		V0
Drill hole diameter / pin dimensions	[mm]	1.2 / 0,8 x 0,8 mm

Ordering data

No. of pos.	Dim. a [mm]	Type	Order No.	Pcs. / Pkt.
Pitch 3.81 mm, color: green				
2	3.81	SMC 1,5/ 2-G-3,81	1827279	50
3	7.62	SMC 1,5/ 3-G-3,81	1827282	50
4	11.43	SMC 1,5/ 4-G-3,81	1827295	50
5	15.24	SMC 1,5/ 5-G-3,81	1827305	50
6	19.05	SMC 1,5/ 6-G-3,81	1827318	50
7	22.86	SMC 1,5/ 7-G-3,81	1827321	50
8	26.67	SMC 1,5/ 8-G-3,81	1827334	50
9	30.48	SMC 1,5/ 9-G-3,81	1827347	50
10	34.29	SMC 1,5/10-G-3,81	1827350	50
11	38.10	SMC 1,5/11-G-3,81	1827363	50
12	41.91	SMC 1,5/12-G-3,81	1827376	50
13	45.72	SMC 1,5/13-G-3,81	1827389	50
14	49.53	SMC 1,5/14-G-3,81	1827392	50
15	53.34	SMC 1,5/15-G-3,81	1827402	50
16	57.15	SMC 1,5/16-G-3,81	1827415	50



With threaded flange, plug-in direction 45° to the PCB



Dimensional drawing

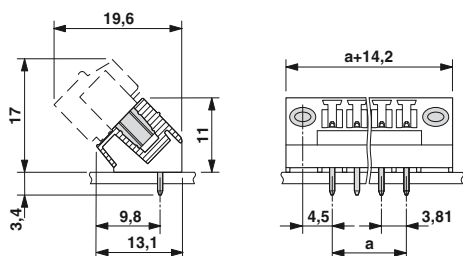

Drilling diagram

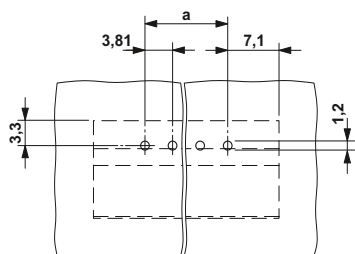

Ordering data

Type	Order No.	Pcs. / Pkt.
Pitch 3.81 mm, color: green		
SMC 1,5/ 2-GF-3,81	1827428	50
SMC 1,5/ 3-GF-3,81	1827431	50
SMC 1,5/ 4-GF-3,81	1827444	50
SMC 1,5/ 5-GF-3,81	1827457	50
SMC 1,5/ 6-GF-3,81	1827460	50
SMC 1,5/ 7-GF-3,81	1827473	50
SMC 1,5/ 8-GF-3,81	1827486	50
SMC 1,5/ 9-GF-3,81	1827499	50
SMC 1,5/10-GF-3,81	1827509	50
SMC 1,5/11-GF-3,81	1827512	50
SMC 1,5/12-GF-3,81	1827525	50
SMC 1,5/13-GF-3,81	1827538	50
SMC 1,5/14-GF-3,81	1827541	50
SMC 1,5/15-GF-3,81	1827554	50
SMC 1,5/16-GF-3,81	1827567	50

Mini plug-in connectors with 3.5/3.81 and 5.08 mm pitch

MINI COMBICON plug-in connectors, pitches 3.5 or 3.81 and 5.08 mm

Single-level header for the wave soldering processes

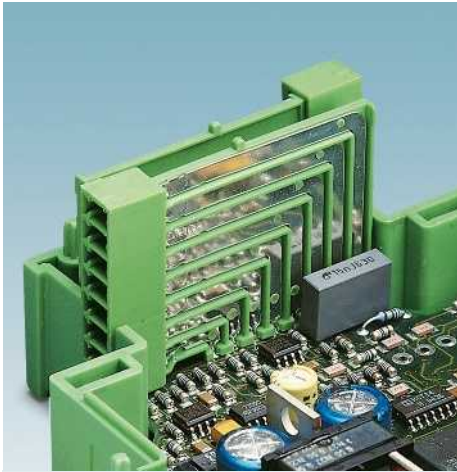

- Space-saving header
- Pin strip perpendicular (orthogonal) to the PCB
- Pitch: 3.81 mm

MCO 1,5/...-GL

- The PCB is to the left of the header

MCO 1,5/...-GR

- The PCB is to the right of the header

Notes:

In accordance with DIN EN 61984, COMBICON plug-in connectors have no switching power. During designated use, they must not be plugged in or disconnected when carrying voltage or under load.

Dimension b:

3-pos. = 7.00 mm
 4-pos. = 10.50 mm
 5-pos. = 14.00 mm
 6-pos. = 17.50 mm
 7-pos. = 21.00 mm
 8-pos. = 24.50 mm
 9-pos. = 28.00 mm
 10-pos. = 31.50 mm



Pin strip leading off at a right angle
 "PCB on the left"



Dimensional drawing

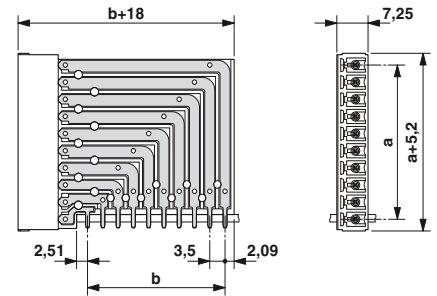

Drilling diagram

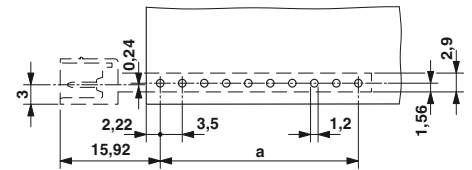

Accessories		
For all types	Type	Page
	Coding profile CP-MSTB Order No. 1734634	38

Technical data

Technical data in accordance to IEC / DIN VDE

Rated current	[A]	8
Rated insulation voltage for pollution degree 2	[V]	160
Pitch	[mm]	3.81
Insulation coordination		
Surge voltage category / pollution degree		III / 3 III / 2 II / 2
Rated insulation voltage	[V]	125 160 200
Rated surge voltage	[kV]	2.5 2.5 2.5
Approval data (UL/CUL)	Use Group	B C D
Nominal voltage	[V]	300 - 300
Nominal current	[A]	8 - 8
Connection capacity AWG	AWG	- - -
Approval data (CSA)	Use Group	B C D
Nominal voltage	[V]	- - -
Nominal current	[A]	- - -
Connection capacity AWG	AWG	- - -
General data		
Type of insulation material / insulation material group		PA (PBT) / IIIa
Inflammability class according to UL 94		V0
Drill hole diameter / pin dimensions	[mm]	1 / 0,9 x 0,32 mm

Ordering data

No. of pos.	Dim. a [mm]	Type	Order No.	Pcs. / Pkt.
Pitch 3.81 mm, color: green				
3	7.62	MCO 1,5/ 3-GL-3,81	1861730	50
4	11.43	MCO 1,5/ 4-GL-3,81	1861743	50
5	15.24	MCO 1,5/ 5-GL-3,81	1861756	50
6	19.05	MCO 1,5/ 6-GL-3,81	1861769	50
7	22.86	MCO 1,5/ 7-GL-3,81	1861772	50
8	26.67	MCO 1,5/ 8-GL-3,81	1861785	50
9	30.48	MCO 1,5/ 9-GL-3,81	1861798	50
10	34.29	MCO 1,5/10-GL-3,81	1861808	50



Pin strip leading off at a right angle
 "PCB on the right"



Dimensional drawing

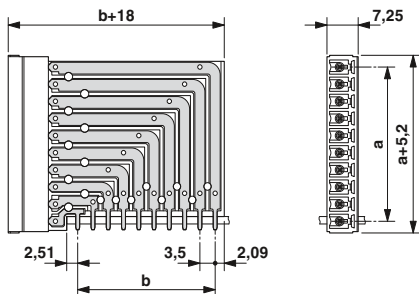

Drilling diagram

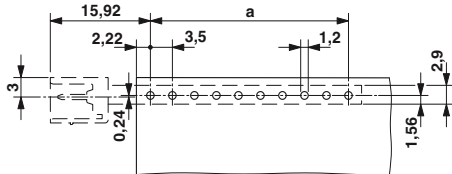

Ordering data

Type	Order No.	Pcs. / Pkt.
Pitch 3.81 mm, color: green		
MCO 1,5/ 3-GR-3,81	1861659	50
MCO 1,5/ 4-GR-3,81	1861662	50
MCO 1,5/ 5-GR-3,81	1861675	50
MCO 1,5/ 6-GR-3,81	1861688	50
MCO 1,5/ 7-GR-3,81	1861691	50
MCO 1,5/ 8-GR-3,81	1861701	50
MCO 1,5/ 9-GR-3,81	1861714	50
MCO 1,5/10-GR-3,81	1861727	50

Mini plug-in connectors with 3.5/3.81 and 5.08 mm pitch

MINI COMBICON plug-in connectors, pitches 3.5 or 3.81 and 5.08 mm

Orthogonal headers for wave soldering processes



- Headers for ME and ME MAX electronic housings
- Plug-in direction orthogonal to the PCB
- Pitch: 3.5 mm
- “Left” and “right” design
- Number of positions between 3 and 5

Notes:

In accordance with DIN EN 61984, COMBICON plug-in connectors have no switching power. During designated use, they must not be plugged in or disconnected when carrying voltage or under load.

COMBICON select

You will find the possible plug-in connector combinations in COMBICON select at: www.phoenixcontact.net/products or starting on page 182.



Pin strip leading off at a right angle “left”



Accessories

For all types	Type	Page
	Coding section CR-MSTBO G1 Order No. 2199618	38

Dimensional drawing

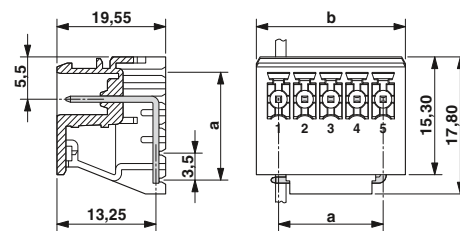

Drilling diagram

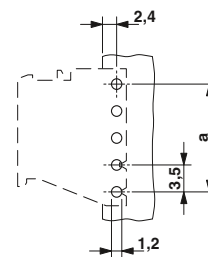

Technical data

Technical data in accordance to IEC / DIN VDE

Rated current	[A]	8
Rated insulation voltage for pollution degree 2	[V]	160
Pitch	[mm]	3.5
Insulation coordination		
Surge voltage category / pollution degree		III / 3 III / 2 II / 2
Rated insulation voltage	[V]	160 160 320
Rated surge voltage	[kV]	2.5 2.5 2.5
Approval data (UL/CUL)	Use Group	B C D
Nominal voltage	[V]	300 - 300
Nominal current	[A]	8 - 8
Connection capacity AWG	AWG	- - -
Approval data (CSA)	Use Group	B C D
Nominal voltage	[V]	- - -
Nominal current	[A]	- - -
Connection capacity AWG	AWG	- - -
General data		
Type of insulation material / insulation material group		PA / I
Inflammability class according to UL 94		V0
Drill hole diameter / pin dimensions	[mm]	1.2 / 0,8 x 0,8 mm

Ordering data

No. of pos.	Dim. a [mm]	Type	Order No.	Pcs. / Pkt.
		COMBICON headers, left, pitch: 3.5 mm,color: light gray		
3	7.00	MCO 1,5/ 3-G1L-3,5 KMGY	2278319	50
4	10.50	MCO 1,5/ 4-G1L-3,5 KMGY	2278364	50
5	14.00	MCO 1,5/ 5-G1L-3,5 KMGY	2278380	50



Pin strip leading off at a right angle
 "right"



Dimensional drawing

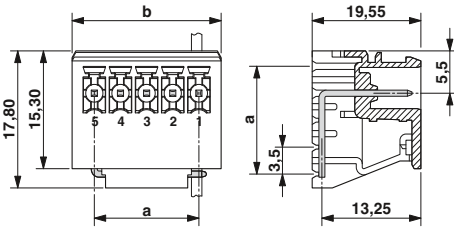

Drilling diagram

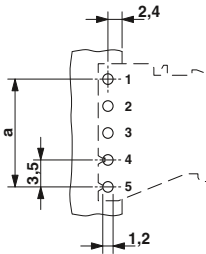

Ordering data

Type	Order No.	Pcs. / Pkt.
COMBICON headers, right, pitch: 3.5 mm, color: light gray		
MCO 1,5/ 3-G1R-3,5 KMGY	2278322	50
MCO 1,5/ 4-G1R-3,5 KMGY	2278377	50
MCO 1,5/ 5-G1R-3,5 KMGY	2278351	50

Mini plug-in connectors with 3.5/3.81 and 5.08 mm pitch

MINI COMBICON plug-in connectors, pitches 3.5 or 3.81 and 5.08 mm

Double-level header for the wave soldering processes

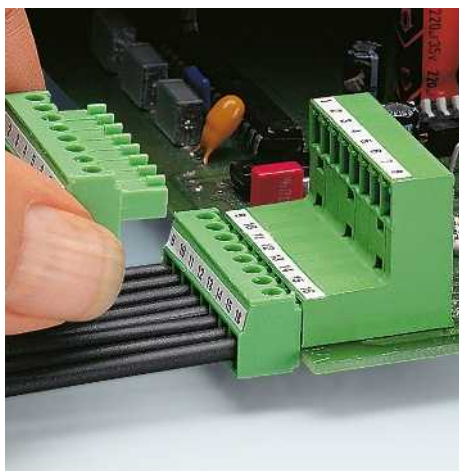

- Low-profile double-level headers with high contact density
- Plug-in direction parallel to the PCB
- Versions with and without a threaded flange

MCD 1,5/...-G-3,81

- With offset levels
- Improved view and accessibility to the lower level

MCD 1,5/...-G1-3,81

- Without a level offset, for flush installation in the front of the devices

Notes:

In accordance with DIN EN 61984, COMBICON plug-in connectors have no switching power. During designated use, they must not be plugged in or disconnected when carrying voltage or under load.

COMBICON select



You will find the possible plug-in connector combinations in COMBICON select at: www.phoenixcontact.net/products or starting on page 182.



With offset levels



Accessories

For all types	Type	Page
	Coding profile CP-MSTB Order No. 1734634	38
	Marker cards SK 3,81/2,8	797

Dimensional drawing

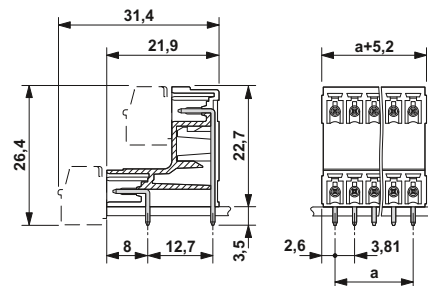

Drilling diagram

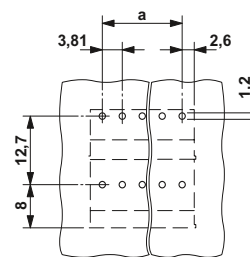

Technical data

Technical data in accordance to IEC / DIN VDE	
Rated current	[A] 8
Rated insulation voltage for pollution degree 2	[V] 160
Pitch	[mm] 3.81
Insulation coordination	
Surge voltage category / pollution degree	III / 3 III / 2 II / 2
Rated insulation voltage	[V] 160 160 250
Rated surge voltage	[kV] 2.5 2.5 2.5
Approval data (UL/CUL)	Use Group B C D
Nominal voltage	[V] 300 - 300
Nominal current	[A] 8 - 8
Connection capacity AWG	AWG - - -
Approval data (CSA)	Use Group B C D
Nominal voltage	[V] 300 - 300
Nominal current	[A] 8 - 8
Connection capacity AWG	AWG - - -
General data	
Type of insulation material / insulation material group	PA / I
Inflammability class according to UL 94	V0
Drill hole diameter / pin dimensions	[mm] 1.2 / 0,8 x 0,8 mm

Ordering data

No. of pos.	Dim. a [mm]	Type	Order No.	Pcs. / Pkt.
Pitch 3.81 mm, color: green				
2	3.81	MCD 1,5/ 2-G-3,81	1829950	50
3	7.62	MCD 1,5/ 3-G-3,81	1829963	50
4	11.43	MCD 1,5/ 4-G-3,81	1829976	50
5	15.24	MCD 1,5/ 5-G-3,81	1829989	50
6	19.05	MCD 1,5/ 6-G-3,81	1829992	50
7	22.86	MCD 1,5/ 7-G-3,81	1830004	50
8	26.67	MCD 1,5/ 8-G-3,81	1830017	50
9	30.48	MCD 1,5/ 9-G-3,81	1830020	50
10	34.29	MCD 1,5/10-G-3,81	1830033	50
11	38.10	MCD 1,5/11-G-3,81	1830046	50
12	41.91	MCD 1,5/12-G-3,81	1830059	50
13	45.72	MCD 1,5/13-G-3,81	1830062	50
14	49.53	MCD 1,5/14-G-3,81	1830075	50
15	53.34	MCD 1,5/15-G-3,81	1830088	50
16	57.15	MCD 1,5/16-G-3,81	1830091	50



With offset levels and threaded flange



Without offset levels



Without offset levels, with threaded flange



Dimensional drawing

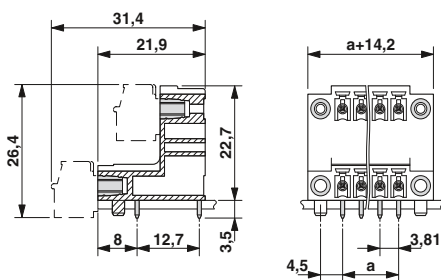

Drilling diagram

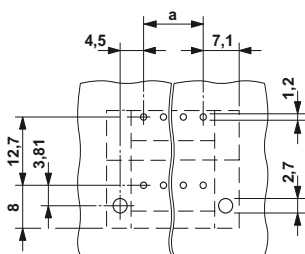

Ordering data

Type	Order No.	Pcs. / Pkt.
Pitch 3.81 mm, color: green		
MCD 1,5/ 2-GF-3,81	1830101	50
MCD 1,5/ 3-GF-3,81	1830114	50
MCD 1,5/ 4-GF-3,81	1830127	50
MCD 1,5/ 5-GF-3,81	1830130	50
MCD 1,5/ 6-GF-3,81	1830143	50
MCD 1,5/ 7-GF-3,81	1830156	50
MCD 1,5/ 8-GF-3,81	1830169	50
MCD 1,5/ 9-GF-3,81	1830172	50
MCD 1,5/10-GF-3,81	1830185	50
MCD 1,5/11-GF-3,81	1830198	50
MCD 1,5/12-GF-3,81	1830208	50
MCD 1,5/13-GF-3,81	1830211	50
MCD 1,5/14-GF-3,81	1830224	50
MCD 1,5/15-GF-3,81	1830237	50
MCD 1,5/16-GF-3,81	1830240	50



Dimensional drawing

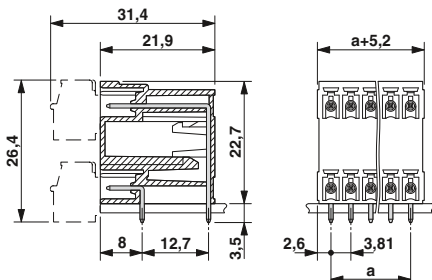

Drilling diagram

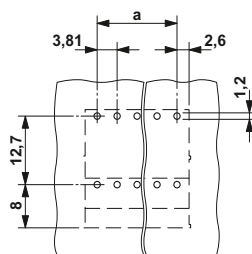

Ordering data

Type	Order No.	Pcs. / Pkt.
Pitch 3.81 mm, color: green		
MCD 1,5/ 2-G1-3,81	1843075	50
MCD 1,5/ 3-G1-3,81	1843088	50
MCD 1,5/ 4-G1-3,81	1843091	50
MCD 1,5/ 5-G1-3,81	1843101	50
MCD 1,5/ 6-G1-3,81	1843114	50
MCD 1,5/ 7-G1-3,81	1843127	50
MCD 1,5/ 8-G1-3,81	1843130	50
MCD 1,5/ 9-G1-3,81	1843143	50
MCD 1,5/10-G1-3,81	1843156	50
MCD 1,5/11-G1-3,81	1843169	50
MCD 1,5/12-G1-3,81	1843172	50
MCD 1,5/13-G1-3,81	1843185	50
MCD 1,5/14-G1-3,81	1843198	50
MCD 1,5/15-G1-3,81	1843208	50
MCD 1,5/16-G1-3,81	1843211	50



Dimensional drawing

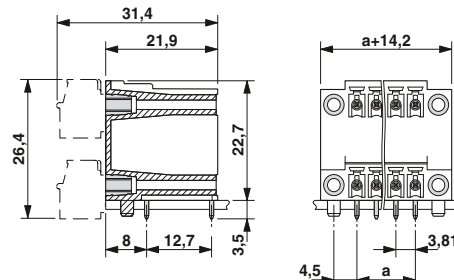

Drilling diagram

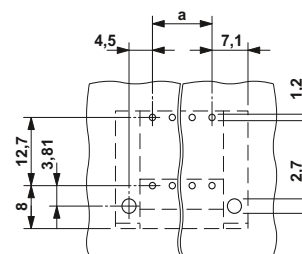

Ordering data

Type	Order No.	Pcs. / Pkt.
Pitch 3.81 mm, color: green		
MCD 1,5/ 2-G1F-3,81	1842911	50
MCD 1,5/ 3-G1F-3,81	1842924	50
MCD 1,5/ 4-G1F-3,81	1842937	50
MCD 1,5/ 5-G1F-3,81	1842940	50
MCD 1,5/ 6-G1F-3,81	1842953	50
MCD 1,5/ 7-G1F-3,81	1842966	50
MCD 1,5/ 8-G1F-3,81	1842979	50
MCD 1,5/ 9-G1F-3,81	1842982	50
MCD 1,5/10-G1F-3,81	1842995	50
MCD 1,5/11-G1F-3,81	1843004	50
MCD 1,5/12-G1F-3,81	1843017	50
MCD 1,5/13-G1F-3,81	1843033	50
MCD 1,5/14-G1F-3,81	1843046	50
MCD 1,5/15-G1F-3,81	1843059	50
MCD 1,5/16-G1F-3,81	1843062	50

Mini plug-in connectors with 3.5/3.81 and 5.08 mm pitch

MINI COMBICON plug-in connectors, pitches 3.5 or 3.81 and 5.08 mm

Double-level header for the wave soldering processes

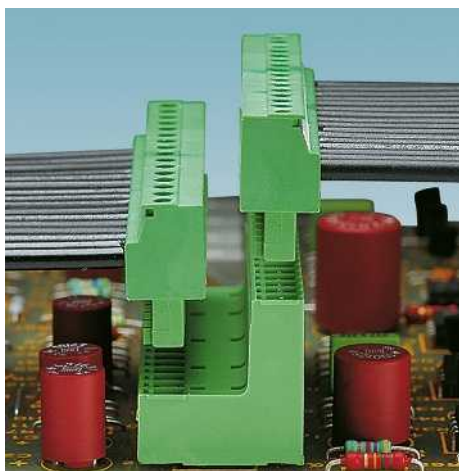

- Low-profile double-level headers with high contact density
- Plug-in direction vertical to the PCB
- Versions with and without a threaded flange

MCDV 1,5/...-G-3,81

- With offset levels
- Improved view and accessibility to the lower level

MCDV 1,5/...-G1-3,81

- Without a level offset, for flush installation in the front of the devices

Notes:

In accordance with DIN EN 61984, COMBICON plug-in connectors have no switching power. During designated use, they must not be plugged in or disconnected when carrying voltage or under load.

COMBICON select

You will find the possible plug-in connector combinations in COMBICON select at: www.phoenixcontact.net/products or starting on page 182.



Mounting screws for base element with threaded flange (...GF...): sheet metal screw ISO 1481-ST 2,2x6,5 C or ISO 7049-ST 2,2x6,5 C. Screw connection only permitted prior to soldering.



With offset levels



Accessories

For all types	Type	Page
	Coding profile CP-MSTB Order No. 1734634	38
	Marker cards SK 3,81/2,8	797

Dimensional drawing

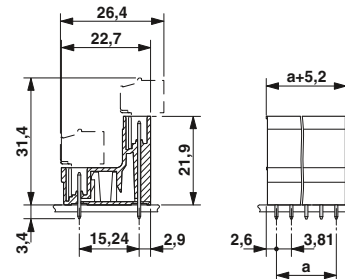

Drilling diagram

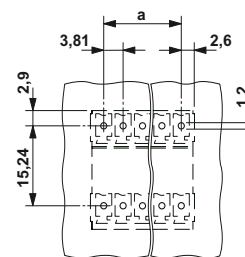

Technical data

Technical data in accordance to IEC / DIN VDE

Rated current	[A]	8
Rated insulation voltage for pollution degree 2	[V]	160
Pitch	[mm]	3.81
Insulation coordination		
Surge voltage category / pollution degree		III / 3 III / 2 II / 2
Rated insulation voltage	[V]	160 160 250
Rated surge voltage	[kV]	2.5 2.5 2.5
Approval data (UL/CUL)	Use Group	B C D
Nominal voltage	[V]	300 - 300
Nominal current	[A]	8 - 8
Connection capacity AWG	AWG	- - -
Approval data (CSA)	Use Group	B C D
Nominal voltage	[V]	300 - 300
Nominal current	[A]	8 - 8
Connection capacity AWG	AWG	- - -
General data		
Type of insulation material / insulation material group		PA / I
Inflammability class according to UL 94		V0
Drill hole diameter / pin dimensions	[mm]	1.2 / 0,8 x 0,8 mm

Ordering data

No. of pos.	Dim. a [mm]	Type	Order No.	Pcs. / Pkt.
		Pitch 3.81 mm, color: green		
2	3.81	MCDV 1,5/ 2-G-3,81	1830402	50
3	7.62	MCDV 1,5/ 3-G-3,81	1830415	50
4	11.43	MCDV 1,5/ 4-G-3,81	1830428	50
5	15.24	MCDV 1,5/ 5-G-3,81	1830431	50
6	19.05	MCDV 1,5/ 6-G-3,81	1830444	50
7	22.86	MCDV 1,5/ 7-G-3,81	1830457	50
8	26.67	MCDV 1,5/ 8-G-3,81	1830460	50
9	30.48	MCDV 1,5/ 9-G-3,81	1830473	50
10	34.29	MCDV 1,5/10-G-3,81	1830486	50
11	38.10	MCDV 1,5/11-G-3,81	1830499	50
12	41.91	MCDV 1,5/12-G-3,81	1830509	50
13	45.72	MCDV 1,5/13-G-3,81	1830512	50
14	49.53	MCDV 1,5/14-G-3,81	1830525	50
15	53.34	MCDV 1,5/15-G-3,81	1830538	50
16	57.15	MCDV 1,5/16-G-3,81	1830541	50



With offset levels and threaded flange



Without offset levels



Without offset levels, with threaded flange



Dimensional drawing

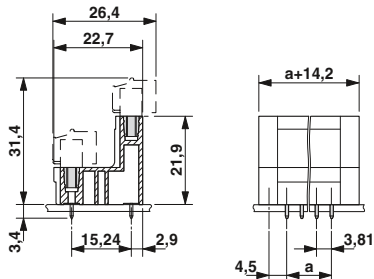

Drilling diagram

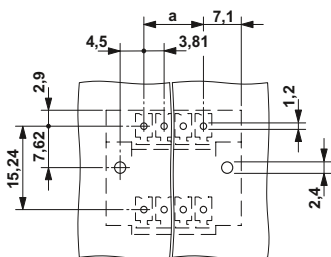

Ordering data

Type	Order No.	Pcs. / Pkt.
Pitch 3.81 mm, color: green		
MCDV 1,5/ 2-GF-3,81	1830253	50
MCDV 1,5/ 3-GF-3,81	1830266	50
MCDV 1,5/ 4-GF-3,81	1830279	50
MCDV 1,5/ 5-GF-3,81	1830282	50
MCDV 1,5/ 6-GF-3,81	1830295	50
MCDV 1,5/ 7-GF-3,81	1830305	50
MCDV 1,5/ 8-GF-3,81	1830318	50
MCDV 1,5/ 9-GF-3,81	1830321	50
MCDV 1,5/10-GF-3,81	1830334	50
MCDV 1,5/11-GF-3,81	1830347	50
MCDV 1,5/12-GF-3,81	1830350	50
MCDV 1,5/13-GF-3,81	1830363	50
MCDV 1,5/14-GF-3,81	1830376	50
MCDV 1,5/15-GF-3,81	1830389	50
MCDV 1,5/16-GF-3,81	1830392	50



Dimensional drawing

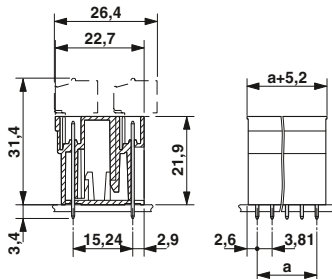

Drilling diagram

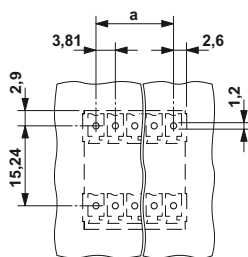

Ordering data

Type	Order No.	Pcs. / Pkt.
Pitch 3.81 mm, color: green		
MCDV 1,5/ 2-G1-3,81	1847725	50
MCDV 1,5/ 3-G1-3,81	1847738	50
MCDV 1,5/ 4-G1-3,81	1847741	50
MCDV 1,5/ 5-G1-3,81	1847754	50
MCDV 1,5/ 6-G1-3,81	1847767	50
MCDV 1,5/ 7-G1-3,81	1847783	50
MCDV 1,5/ 8-G1-3,81	1847796	50
MCDV 1,5/ 9-G1-3,81	1847806	50
MCDV 1,5/10-G1-3,81	1847819	50
MCDV 1,5/11-G1-3,81	1847822	50
MCDV 1,5/12-G1-3,81	1847835	50
MCDV 1,5/13-G1-3,81	1847848	50
MCDV 1,5/14-G1-3,81	1847851	50
MCDV 1,5/15-G1-3,81	1847864	50
MCDV 1,5/16-G1-3,81	1847877	50



Dimensional drawing

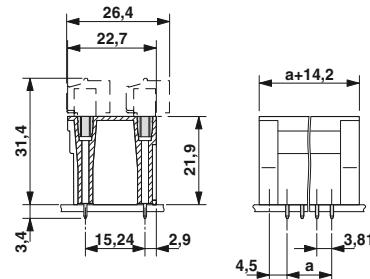

Drilling diagram

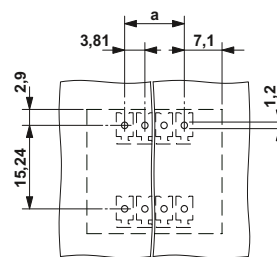

Ordering data

Type	Order No.	Pcs. / Pkt.
Pitch 3.81 mm, color: green		
MCDV 1,5/ 2-G1F-3,81	1842762	50
MCDV 1,5/ 3-G1F-3,81	1842775	50
MCDV 1,5/ 4-G1F-3,81	1842788	50
MCDV 1,5/ 5-G1F-3,81	1842791	50
MCDV 1,5/ 6-G1F-3,81	1842801	50
MCDV 1,5/ 7-G1F-3,81	1842814	50
MCDV 1,5/ 8-G1F-3,81	1842827	50
MCDV 1,5/ 9-G1F-3,81	1842830	50
MCDV 1,5/10-G1F-3,81	1842843	50
MCDV 1,5/11-G1F-3,81	1842856	50
MCDV 1,5/12-G1F-3,81	1842869	50
MCDV 1,5/13-G1F-3,81	1842872	50
MCDV 1,5/14-G1F-3,81	1842885	50
MCDV 1,5/15-G1F-3,81	1842898	50
MCDV 1,5/16-G1F-3,81	1842908	50

Mini plug-in connectors with 3.5/3.81 and 5.08 mm pitch

MINI COMBICON plug-in connectors, pitches 3.5 or 3.81 and 5.08 mm

Inverted header for the wave soldering processes

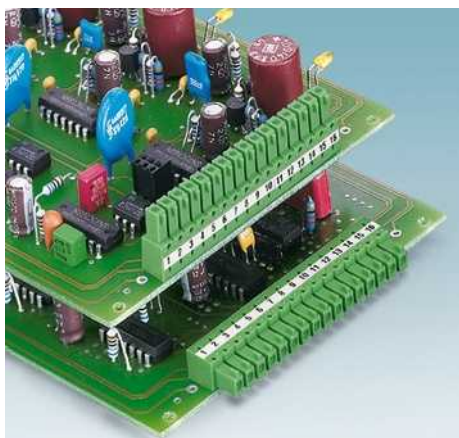

- Use in contact protected applications
- Plug-in direction horizontal and vertical to the PCB
- Combination with MC 1,5 pin strips for primary/secondary/PCB connection
- Clear separation of PCB inputs/outputs
- Individual position coding by removing the coding tab and by connecting the coding profile to the counterpart

Notes:

In accordance with DIN EN 61984, COMBICON plug-in connectors have no switching power. During designated use, they must not be plugged in or disconnected when carrying voltage or under load.

COMBICON select

You will find the possible plug-in connector combinations in COMBICON select at: www.phoenixcontact.net/products or starting on page 182.



Plug-in direction parallel to the PCB



Dimensional drawing

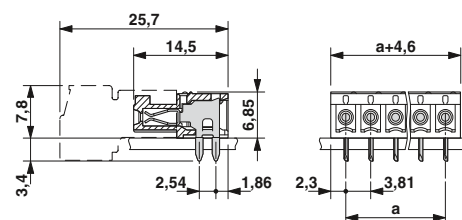

Drilling diagram

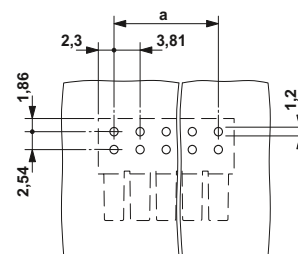

Accessories		
For all types	Type	Page
	Marker cards SK 3,81/2,8	797

Technical data

Technical data in accordance to IEC / DIN VDE

Rated current	[A]	8
Rated insulation voltage for pollution degree 2	[V]	160
Pitch	[mm]	3.81
Insulation coordination		
Surge voltage category / pollution degree		III / 3 III / 2 II / 2
Rated insulation voltage	[V]	160 160 320
Rated surge voltage	[kV]	2.5 2.5 2.5
Approval data (UL/CUL)	Use Group	B C D
Nominal voltage	[V]	300 - 300
Nominal current	[A]	8 - 8
Connection capacity AWG	AWG	- - -
Approval data (CSA)	Use Group	B C D
Nominal voltage	[V]	- - -
Nominal current	[A]	- - -
Connection capacity AWG	AWG	- - -
General data		
Type of insulation material / insulation material group		PA / I
Inflammability class according to UL 94		V0
Drill hole diameter / pin dimensions	[mm]	1.2 / 0,8 x 0,8 mm

Ordering data

No. of pos.	Dim. a [mm]	Type	Order No.	Pcs. / Pkt.
Pitch 3.81 mm, color: green				
2	3.81	IMC 1,5/ 2-G-3,81	1862577	50
3	7.62	IMC 1,5/ 3-G-3,81	1862580	50
4	11.43	IMC 1,5/ 4-G-3,81	1862593	50
5	15.24	IMC 1,5/ 5-G-3,81	1862603	50
6	19.05	IMC 1,5/ 6-G-3,81	1862616	50
7	22.86	IMC 1,5/ 7-G-3,81	1862629	50
8	26.67	IMC 1,5/ 8-G-3,81	1862632	50
9	30.48	IMC 1,5/ 9-G-3,81	1862645	50
10	34.29	IMC 1,5/10-G-3,81	1862658	50
11	38.10	IMC 1,5/11-G-3,81	1862661	50
12	41.91	IMC 1,5/12-G-3,81	1862674	50
13	45.72	IMC 1,5/13-G-3,81	1862687	50
14	49.53	IMC 1,5/14-G-3,81	1862690	50
15	53.34	IMC 1,5/15-G-3,81	1862700	50
16	57.15	IMC 1,5/16-G-3,81	1862713	50

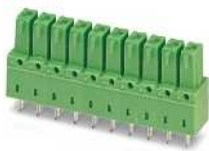

Plug-in direction vertical to the PCB



Dimensional drawing

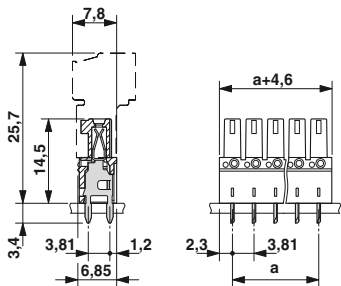

Drilling diagram

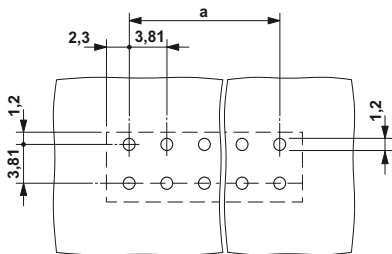

Ordering data

Type	Order No.	Pcs. / Pkt.
Pitch 3.81 mm, color: green		
IMCV 1,5/ 2-G-3,81	1875425	50
IMCV 1,5/ 3-G-3,81	1875438	50
IMCV 1,5/ 4-G-3,81	1875441	50
IMCV 1,5/ 5-G-3,81	1875454	50
IMCV 1,5/ 6-G-3,81	1875467	50
IMCV 1,5/ 7-G-3,81	1875470	50
IMCV 1,5/ 8-G-3,81	1875483	50
IMCV 1,5/ 9-G-3,81	1875496	50
IMCV 1,5/10-G-3,81	1875506	50
IMCV 1,5/11-G-3,81	1875519	50
IMCV 1,5/12-G-3,81	1875522	50
IMCV 1,5/13-G-3,81	1875535	50
IMCV 1,5/14-G-3,81	1875548	50
IMCV 1,5/15-G-3,81	1875551	50
IMCV 1,5/16-G-3,81	1875564	50

Mini plug-in connectors with 3.5/3.81 and 5.08 mm pitch

MINI COMBICON plug-in connectors, pitches 3.5 or 3.81 and 5.08 mm

Header for panel feed-throughs



- Header for assembly in a device/housing panel
- Outer plug-in connection for corresponding connectors with 3.81 mm pitch
- Internal optional solder or 2.8 mm slip-on connection
- Separate screw connection with the device/housing wall

Notes:

In accordance with DIN EN 61984, COMBICON plug-in connectors have no switching power. During designated use, they must not be plugged in or disconnected when carrying voltage or under load.

COMBICON select

You will find the possible plug-in connector combinations in COMBICON select at: www.phoenixcontact.net/products or starting on page 182.

Sheet metal cutout dimensions b and c, refer to page 838.



With threaded flange, with solder or slip-on connection for housing walls 0.5 to 4 mm thick



Accessories

For all types	Type	Page
	Coding profile CP-MSTB Order No. 1734634	38
	Marker cards SK 3,81/2,8	797
	Screwdriver SZS 0,4 x 2,5 Order No. 1205037	
	M2 x 8 mm screw set DFK-MC-SS Order No. 0710015	

Dimensional drawing

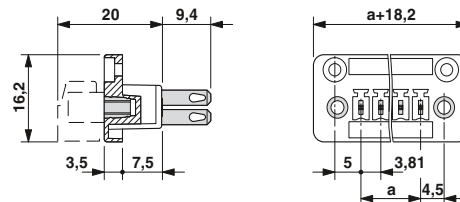
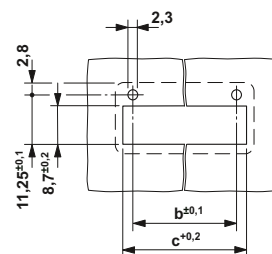

Plate cutout

Dimension b: 6.19 mm + (no. of pos. x 3.81 mm)
Dimension c: Dim. b + 4.7 mm



Technical data

Technical data in accordance to IEC / DIN VDE	
Rated current / conductor cross section	[A] / [mm ²]
Rated insulation voltage for pollution degree 2	[V]
Pitch	[mm]
Insulation coordination	
Surge voltage category / pollution degree	
Rated insulation voltage	[V]
Rated surge voltage	[kV]
Approval data (UL/CUL)	Use Group
Nominal voltage	[V]
Nominal current	[A]
Connection capacity AWG	AWG
Approval data (CSA)	Use Group
Nominal voltage	[V]
Nominal current	[A]
Connection capacity AWG	AWG
General data	
Type of insulation material / insulation material group	
Inflammability class according to UL 94	
Slip-on connection (DIN 46249-1)	[A]/[mm]

8 / 1.5		
160		
3.81		
III / 3	III / 2	II / 2
160	160	320
2.5	2.5	2.5
B	C	D
300	-	300
8	-	8
-	-	-
B	C	D
150	-	150
8	-	8
28 - 16	-	28 - 16
PA / I		
V0		
- / 2,8 x 0,8 mm		

No. of pos.	Dim. a [mm]
2	3.81
3	7.62
4	11.43
5	15.24
6	19.05
7	22.86
8	26.67
9	30.48
10	34.29
11	38.10
12	41.91
13	45.72
14	49.53
15	53.34
16	57.15

Ordering data

Type	Order No.	Pcs. / Pkt.
Pitch 3.81 mm, color: green		
DFK-MC 1,5/ 2-GF-3,81	1829345	50
DFK-MC 1,5/ 3-GF-3,81	1829358	50
DFK-MC 1,5/ 4-GF-3,81	1829361	50
DFK-MC 1,5/ 5-GF-3,81	1829374	50
DFK-MC 1,5/ 6-GF-3,81	1829387	50
DFK-MC 1,5/ 7-GF-3,81	1829390	50
DFK-MC 1,5/ 8-GF-3,81	1827596	50
DFK-MC 1,5/ 9-GF-3,81	1829400	50
DFK-MC 1,5/10-GF-3,81	1829413	50
DFK-MC 1,5/11-GF-3,81	1829426	50
DFK-MC 1,5/12-GF-3,81	1829439	50
DFK-MC 1,5/13-GF-3,81	1829442	50
DFK-MC 1,5/14-GF-3,81	1829455	50
DFK-MC 1,5/15-GF-3,81	1829468	50
DFK-MC 1,5/16-GF-3,81	1829471	50

Header for direct mounting

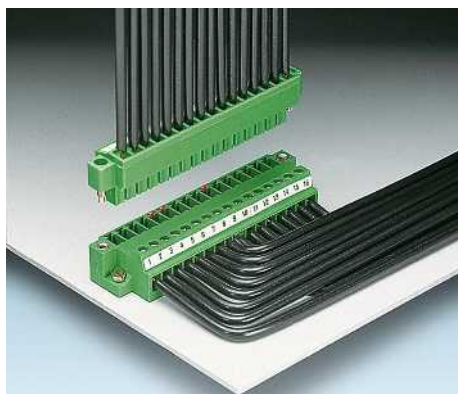

- Direct plug-in block with mounting flanges for screw connection on mounting plates or unit housings
- Shock-proof connection block in combination with MC plug-in system
- Design with a threaded flange

Notes:

In accordance with DIN EN 61984, COMBICON plug-in connectors have no switching power. During designated use, they must not be plugged in or disconnected when carrying voltage or under load.

COMBICON select
You will find the possible plug-in connector combinations in COMBICON select at: www.phoenixcontact.net/products or starting on page 182.



With threaded flange and flange for direct mounting



Dimensional drawing

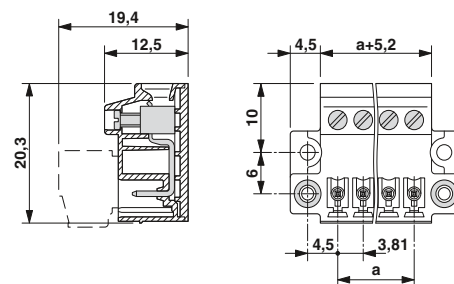

Drilling diagram

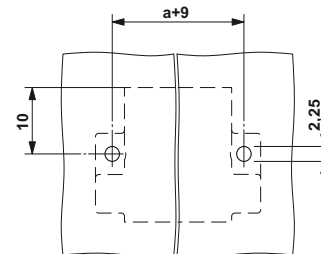

Accessories		
For all types	Type	Page
	Coding profile CP-MSTB Order No. 1734634	38
	Marker cards SK 3,81/2,8	797
	Screwdriver SZS 0,4 x 2,5 Order No. 1205037	

Technical data

Technical data in accordance to IEC / DIN VDE		
Rated current / conductor cross section	[A] / [mm ²]	8 / 1.5
Rated insulation voltage for pollution degree 2	[V]	160
Pitch	[mm]	3.81
Connection capacity		
Solid / stranded	[mm ²] / [mm ²] / AWG	0.14 - 1.5 / 0.14 - 1.5 / 28 - 16
Stranded with ferrules without plastic sleeve	[mm ²]	0.25 - 1.5
Stranded with ferrules with plastic sleeve	[mm ²]	0.25 - 0.5
Multi-conductor connection capacity (two conductors with the same cross section)		
Solid / stranded	[mm ²]	0.14 - 0.5 / 0.14 - 0.75
Stranded with ferrules without plastic sleeve	[mm ²]	0.25 - 0.34
Stranded with TWIN ferrule with plastic sleeve	[mm ²]	0.5 - 0.5
Insulation coordination		
Surge voltage category / pollution degree		III / 3 III / 2 II / 2
Rated insulation voltage	[V]	160 160 320
Rated surge voltage	[kV]	2.5 2.5 2.5
Approval data (UL/CUL)	Use Group	B C D
Nominal voltage	[V]	300 - 300
Nominal current	[A]	8 - 8
Connection capacity AWG	AWG	30 - 14 - 30 - 14
Approval data (CSA)	Use Group	B C D
Nominal voltage	[V]	300 - 300
Nominal current	[A]	8 - 8
Connection capacity AWG	AWG	28 - 16 - 28 - 16
General data		
Stripping length	[mm]	7
Screw thread		M2
Tightening torque	[Nm]	0.22 - 0.25
Type of insulation material / insulation material group		PA / I
Inflammability class according to UL 94		V0

Ordering data

Type	Order No.	Pcs. / Pkt.
Pitch 3.81 mm, color: green		
MCVU 1,5/ 2-GFD-3,81	1833027	50
MCVU 1,5/ 3-GFD-3,81	1833030	50
MCVU 1,5/ 4-GFD-3,81	1833043	50
MCVU 1,5/ 5-GFD-3,81	1833056	50
MCVU 1,5/ 6-GFD-3,81	1833069	50
MCVU 1,5/ 7-GFD-3,81	1833072	50
MCVU 1,5/ 8-GFD-3,81	1833085	50
MCVU 1,5/ 9-GFD-3,81	1833098	50
MCVU 1,5/10-GFD-3,81	1833108	50
MCVU 1,5/11-GFD-3,81	1833111	50
MCVU 1,5/12-GFD-3,81	1833124	50
MCVU 1,5/13-GFD-3,81	1833137	50
MCVU 1,5/14-GFD-3,81	1833140	50
MCVU 1,5/15-GFD-3,81	1833153	50
MCVU 1,5/16-GFD-3,81	1833166	50

Mini plug-in connectors with 3.5/3.81 and 5.08 mm pitch

MINI COMBICON plug-in connectors, pitches 3.5 or 3.81 and 5.08 mm

Cable housings



- For MC or IMC plugs with and without flange, with 3.81 mm pitch
- Complete snap-locking of the two half shells of the cable housing
- Cable strain relief using cable binder or cable clamp
- Straight cable outlet for aligning multiple cable housings
- Easier plugging and unplugging processes
- Incl. cable binders and marker strips for all numbers of positions
- Incl. transparent label carriers from 6- to 16-pos.

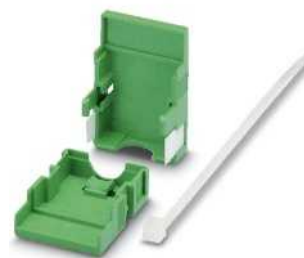

2- to 5-pos., for cable diameters up to 5 mm
with 2-pos. housings, up to 8.5 mm with
3- to 5-pos. housings



Accessories

For all types	Type	Page
	Simplex marking card SBS 10:Unprinted Order No. 1007248	
Only for KGG-MC 1,5/...		
	Transparent marker carrier KGG-MC 1,5/DST Order No. 1839050	

Dimensional drawing

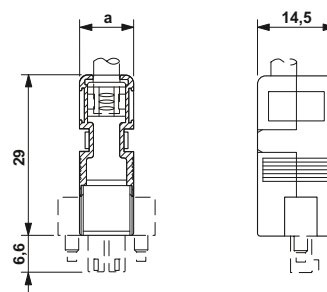

Technical data

Technical data in accordance to IEC / DIN VDE	
Rated current / conductor cross section	[A] / [mm ²]
Rated insulation voltage for pollution degree 2	[V]
Pitch	[mm]
Insulation coordination	
Surge voltage category / pollution degree	
Rated insulation voltage	[V]
Rated surge voltage	[kV]
General data	
Type of insulation material / insulation material group	
Inflammability class according to UL 94	

- / -
-
3.81
III / 3 III / 2 II / 2
ABS / I
HB

Ordering data

No. of pos.	Dim. a [mm]	Type	Order No.	Pcs. / Pkt.
Pitch 3.81 mm, color: green				
2	10.01	KGG-MC 1,5/ 2	1834343	10
3	13.82	KGG-MC 1,5/ 3	1834356	10
4	17.63	KGG-MC 1,5/ 4	1834369	10
5	21.44	KGG-MC 1,5/ 5	1834372	10
6	25.25			
7	29.09			
8	32.87			
9	36.68			
10	40.49			
11	44.30			
12	48.11			
13	51.92			
14	55.73			
15	59.54			
16	63.35			



6- to 16-pos., for cable diameters of 4 - 11 mm



Dimensional drawing

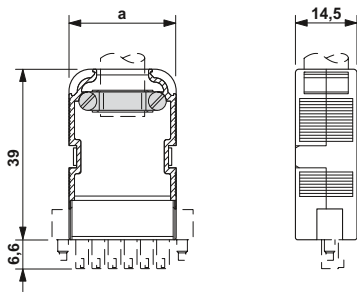

Ordering data

Type	Order No.	Pcs. / Pkt.
Pitch 3.81 mm, color: green		
KGG-MC 1,5/ 6	1834385	10
KGG-MC 1,5/ 7	1834398	10
KGG-MC 1,5/ 8	1834408	10
KGG-MC 1,5/ 9	1834411	10
KGG-MC 1,5/10	1834424	10
KGG-MC 1,5/11	1834437	10
KGG-MC 1,5/12	1834440	10
KGG-MC 1,5/13	1834453	10
KGG-MC 1,5/14	1834466	10
KGG-MC 1,5/15	1834479	10
KGG-MC 1,5/16	1834482	10

Mini plug-in connectors with 3.5/3.81 and 5.08 mm pitch

MINI COMBICON plug-in connectors, pitches 3.5 or 3.81 and 5.08 mm

Fiber optics for headers

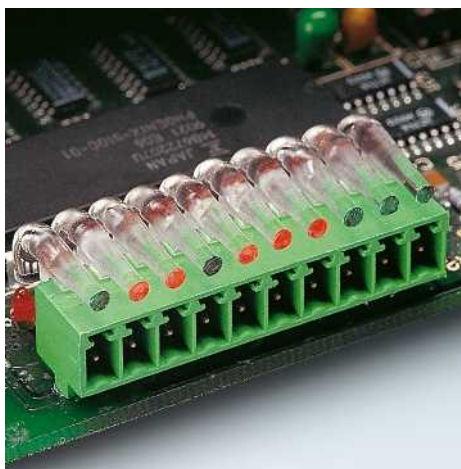

- "Bending" the light of the flat SMD LEDs by 90°. This is thus visible from the front
- Snap-locking on the back side of the standard MC header
- 10-pos., can be separated for small numbers of positions
- Pitch: 3.5 and 3.81 mm
- Distance of 1.5, 2.3 and 4.0 mm from the PCB for a possible use of all conventional SMD LEDs



3.5 mm pitch, snapped onto the rear of the MC header



Dimensional drawing

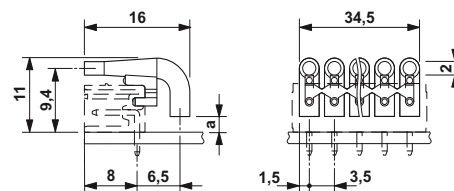

Technical data

Technical data in accordance to IEC / DIN VDE	
Rated current / conductor cross section	[A] / [mm ²]
Rated insulation voltage for pollution degree 2	[V]
Pitch	[mm]
Insulation coordination	
Surge voltage category / pollution degree	
Rated insulation voltage	[V]
Rated surge voltage	[kV]
Approval data (UL/CUL)	Use Group
Nominal voltage	[V]
Nominal current	[A]
Connection capacity AWG	AWG
Approval data (CSA)	Use Group
Nominal voltage	[V]
Nominal current	[A]
Connection capacity AWG	AWG
General data	
Type of insulation material / insulation material group	
Inflammability class according to UL 94	

	- / -
	-
	3.5 / 3.81
	III / 3 III / 2 II / 2
	B C D
	- - -
	- - -
	B C D
	- - -
	- - -
	- - -
	- / -
	-

Ordering data

No. of pos.	Dim. a [mm]	Type	Order No.	Pcs. / Pkt.
		Pitch 3.5 mm, color: Transparent		
10	1.50	MC 1,5/10-LWL 1,5-3,5	1841161	50
10	2.30	MC 1,5/10-LWL 2,3-3,5	1841187	50
10	4.00	MC 1,5/10-LWL 4-3,5	1841200	50



3.81 mm pitch, snapped onto the rear of the
 MC header



Dimensional drawing

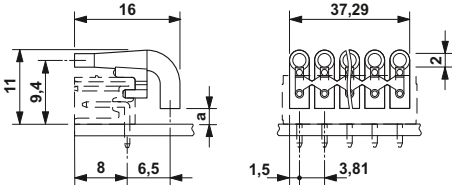

Ordering data

Type	Order No.	Pcs. / Pkt.
Pitch 3.81 mm, color: Transparent		
MC 1,5/10-LWL 1,5-3,81	1841174	50
MC 1,5/10-LWL 2,3-3,81	1841190	50
MC 1,5/10-LWL 4-3,81	1841213	50

Mini plug-in connectors with 3.5/3.81 and 5.08 mm pitch

MINI COMBICON plug-in connectors, pitches 3.5 or 3.81 and 5.08 mm

Plugs with screw connection, pitch 5.08 mm

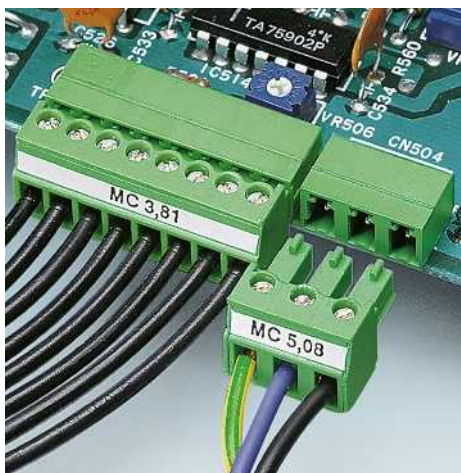

- High dielectric strength up to 320 V in acc. with III/2
- Flat design of the MC 1,5 plug range
- Plug-in direction parallel to the conductor axis
- Versions with and without a screw flange
- Individual position coding by removing the coding tab and connecting the coding profile to the header
- ST1 version with a plug-in zone with downward offset, locks flush with the lower edge of the housing

Notes:

In accordance with DIN EN 61984, COMBICON plug-in connectors have no switching power. During designated use, they must not be plugged in or disconnected when carrying voltage or under load.

COMBICON select

You will find the possible plug-in connector combinations in COMBICON select at: www.phoenixcontact.net/products or starting on page 182.

The maximum torque for the screw flange is 0.3 Nm.



¹⁾ Please observe the derating curves. Derating curves of further combination options on request.

²⁾ CSA data for MC 1,5/...-ST(F)-5,08 on request.



With connection area moved to the bottom

Accessories

For all types	Type	Page
	Screwdriver SZS 0,4 x 2,5 Order No. 1205037	
	Marker cards SK 5,08/2,8	797



Dimensional drawing

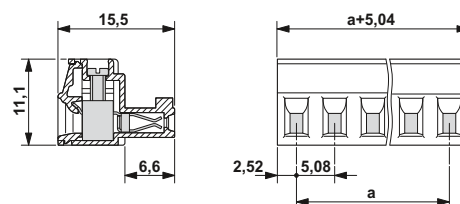

Note derating curves

Derating curves, determined as per DIN EN 61984 (VDE 0627):2002-09
Representation based on DIN EN 60512-5-2:2003-01
Connected conductor cross section = 1.5 mm²
Reduction factor = 0.8
Number of positions = see diagram

Technical data

Technical data in accordance to IEC / DIN VDE	
Rated current / conductor cross section	[A] / [mm ²]
Rated insulation voltage for pollution degree 2	[V]
Pitch	[mm]
Connection capacity	
Solid / stranded	[mm ²] / [mm ²] / AWG
Stranded with ferrules without plastic sleeve	[mm ²]
Stranded with ferrules with plastic sleeve	[mm ²]
Multi-conductor connection capacity (two conductors with the same cross section)	
Solid / stranded	[mm ²]
Stranded with ferrules without plastic sleeve	[mm ²]
Stranded with TWIN ferrule with plastic sleeve	[mm ²]
Insulation coordination	
Surge voltage category / pollution degree	
Rated insulation voltage	[V]
Rated surge voltage	[kV]
Approval data (UL/CUL)	Use Group
Nominal voltage	[V]
Nominal current	[A]
Connection capacity AWG	AWG
Approval data (CSA)	Use Group
Nominal voltage	[V]
Nominal current	[A]
Connection capacity AWG	AWG
General data	
Stripping length	[mm]
Screw thread	
Tightening torque	[Nm]
Type of insulation material / insulation material group	
Inflammability class according to UL 94	

8 ¹⁾ / 1.5		
320		
5.08		
0.14 - 1.5 / 0.14 - 1.5 / 28 - 16		
0.25 - 1.5		
0.25 - 0.5		
0.08 - 0.5 / 0.08 - 0.75		
0.25 - 0.34		
0.5 - 0.5		
III / 3	III / 2	II / 2
250	320	630
4	4	4
B	C	D
300	-	300
8	-	8
30 - 14	-	30 - 14
B	C	D
-	-	-
-	-	-
-	-	-
7		
M2		
0.22 - 0.25		
PA / I		
V0		

Ordering data

No. of pos.	Dim. a [mm]	Type	Order No.	Pcs. / Pkt.
5.08 mm pitch, color: green				
2	5.08	MC 1,5/ 2-ST1-5,08	1900772	50
3	10.16	MC 1,5/ 3-ST1-5,08	1900785	50
4	15.24	MC 1,5/ 4-ST1-5,08	1900798	50
5	20.32	MC 1,5/ 5-ST1-5,08	1900808	50
6	25.40	MC 1,5/ 6-ST1-5,08	1900811	50
7	30.48	MC 1,5/ 7-ST1-5,08	1900824	50
8	35.56	MC 1,5/ 8-ST1-5,08	1900837	50
9	40.64	MC 1,5/ 9-ST1-5,08	1900840	50
10	45.72	MC 1,5/10-ST1-5,08	1900853	50
11	50.80	MC 1,5/11-ST1-5,08	1900866	50
12	55.88	MC 1,5/12-ST1-5,08	1900879	50

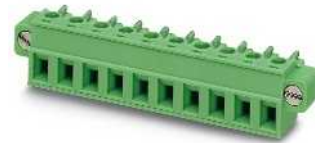
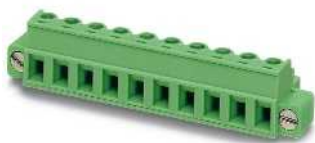

With connection area moved to the bottom, with screw flange

Standard plug

With screw flange



Dimensional drawing

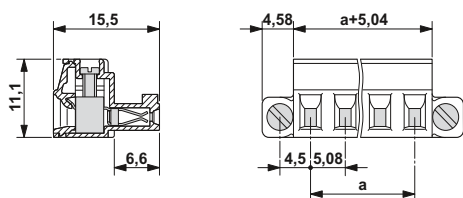

Dimensional drawing

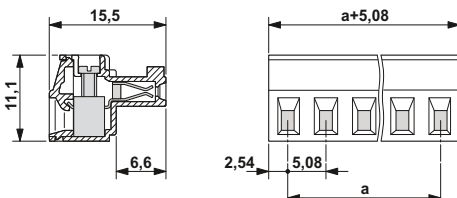

Dimensional drawing

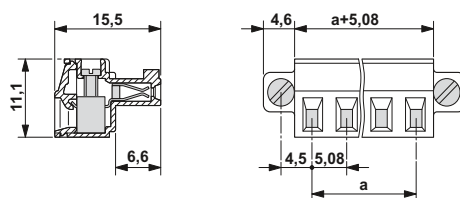

Representative derating curves of the above-mentioned plugs

Type: MC 1,5/...-ST1-5,08 with MC 1,5/...-G-5,08

Type: MC 1,5/...-ST-5,08 with MC 1,5/...-G-5,08

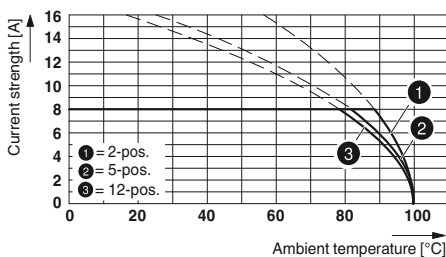
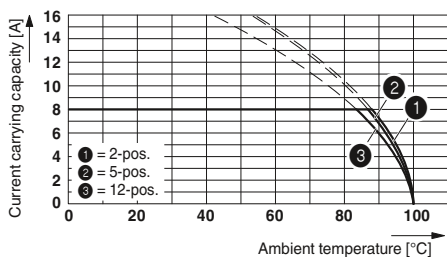

Ordering data

Type	Order No.	Pcs. / Pkt.
5.08 mm pitch, color: green		
MC 1,5/ 2-ST1F-5,08	1900882	50
MC 1,5/ 3-ST1F-5,08	1900895	50
MC 1,5/ 4-ST1F-5,08	1900905	50
MC 1,5/ 5-ST1F-5,08	1900918	50
MC 1,5/ 6-ST1F-5,08	1900921	50
MC 1,5/ 7-ST1F-5,08	1900934	50
MC 1,5/ 8-ST1F-5,08	1900947	50
MC 1,5/ 9-ST1F-5,08	1900950	50
MC 1,5/10-ST1F-5,08	1900963	50
MC 1,5/11-ST1F-5,08	1900976	50
MC 1,5/12-ST1F-5,08	1900989	50

Ordering data

Type	Order No.	Pcs. / Pkt.
5.08 mm pitch, color: green		
MC 1,5/ 2-ST-5,08	1836079	50
MC 1,5/ 3-ST-5,08	1836082	50
MC 1,5/ 4-ST-5,08	1836095	50
MC 1,5/ 5-ST-5,08	1836105	50
MC 1,5/ 6-ST-5,08	1836118	50
MC 1,5/ 7-ST-5,08	1836121	50
MC 1,5/ 8-ST-5,08	1836134	50
MC 1,5/ 9-ST-5,08	1836147	50
MC 1,5/10-ST-5,08	1836150	50
MC 1,5/11-ST-5,08	1836163	50
MC 1,5/12-ST-5,08	1836176	50

Ordering data

Type	Order No.	Pcs. / Pkt.
5.08 mm pitch, color: green		
MC 1,5/ 2-STF-5,08	1847356	50
MC 1,5/ 3-STF-5,08	1847369	50
MC 1,5/ 4-STF-5,08	1847372	50
MC 1,5/ 5-STF-5,08	1847385	50
MC 1,5/ 6-STF-5,08	1847398	50
MC 1,5/ 7-STF-5,08	1847408	50
MC 1,5/ 8-STF-5,08	1847411	50
MC 1,5/ 9-STF-5,08	1847424	50
MC 1,5/10-STF-5,08	1847437	50
MC 1,5/11-STF-5,08	1847440	50
MC 1,5/12-STF-5,08	1847453	50

Mini plug-in connectors with 3.5/3.81 and 5.08 mm pitch

MINI COMBICON plug-in connectors, pitches 3.5 or 3.81 and 5.08 mm

A header with a 5.08 mm pitch for wave soldering processes

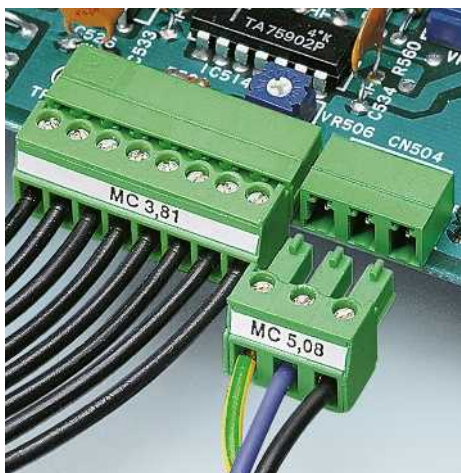

- High dielectric strength up to 320 V in acc. with III/2
- Low-profile header
- Plug-in direction parallel and vertical to the PCB
- Versions with and without a threaded flange
- Individual position coding by inserting the coding profiles

Notes:

In accordance with DIN EN 61984, COMBICON plug-in connectors have no switching power. During designated use, they must not be plugged in or disconnected when carrying voltage or under load.

Mounting screws for MCV 1,5/...-GF-5,08: sheet metal screw ISO 1481-ST 2,2x4,5 C or ISO 7049-ST 2,2x4,5 C. Screw connection only permitted prior to soldering.

COMBICON select

You will find the possible plug-in connector combinations in COMBICON select at: www.phoenixcontact.net/products or starting on page 182.



Plug-in direction parallel to the PCB



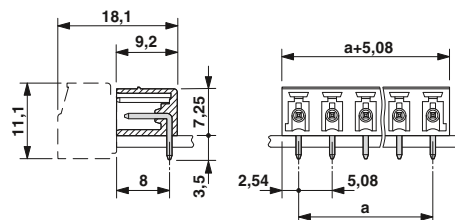

Dimensional drawing

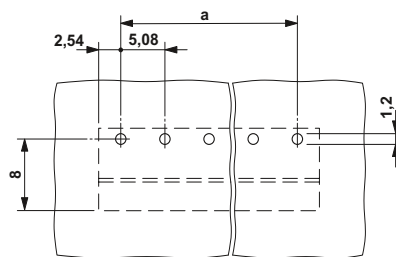

Drilling diagram



Accessories		
For all types	Type	Page
	Coding profile CP-MSTB Order No. 1734634	38
	Marker cards SK 5,08/2,8	797

Technical data

Technical data in accordance to IEC / DIN VDE

Rated current	[A]	8
Rated insulation voltage for pollution degree 2	[V]	320
Pitch	[mm]	5.08
Insulation coordination		
Surge voltage category / pollution degree		III / 3 III / 2 II / 2
Rated insulation voltage	[V]	250 320 400
Rated surge voltage	[kV]	4 4 4
Approval data (UL/CUL)	Use Group	B C D
Nominal voltage	[V]	300 - 300
Nominal current	[A]	8 - 8
Connection capacity AWG	AWG	- - -
Approval data (CSA)	Use Group	B C D
Nominal voltage	[V]	300 - 300
Nominal current	[A]	8 - 8
Connection capacity AWG	AWG	- - -
General data		
Type of insulation material / insulation material group		PBT / IIIa
Inflammability class according to UL 94		V0
Drill hole diameter / pin dimensions	[mm]	1.2 / 0,8 x 0,8 mm

No. of pos.	Dim. a [mm]
2	5.08
3	10.16
4	15.24
5	20.32
6	25.40
7	30.48
8	35.56
9	40.64
10	45.72
11	50.80
12	55.88

Ordering data

Type	Order No.	Pcs. / Pkt.
5.08 mm pitch, color: green		
MC 1,5/ 2-G-5,08	1836189	50
MC 1,5/ 3-G-5,08	1836192	50
MC 1,5/ 4-G-5,08	1836202	50
MC 1,5/ 5-G-5,08	1836215	50
MC 1,5/ 6-G-5,08	1836228	50
MC 1,5/ 7-G-5,08	1836231	50
MC 1,5/ 8-G-5,08	1836244	50
MC 1,5/ 9-G-5,08	1836257	50
MC 1,5/10-G-5,08	1836260	50
MC 1,5/11-G-5,08	1836273	50
MC 1,5/12-G-5,08	1836286	50



Plug-in direction vertical to the PCB

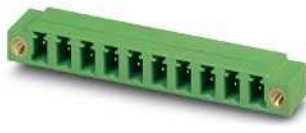

With threaded flange,
plug-in direction parallel to the PCB



With threaded flange, plug-in direction vertical to the PCB



Dimensional drawing

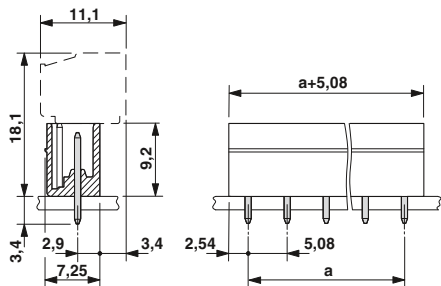

Drilling diagram

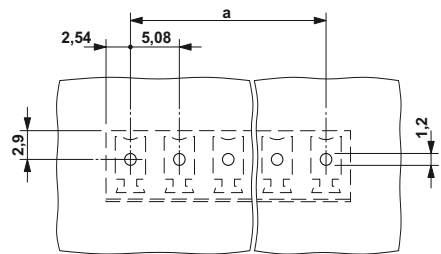

Dimensional drawing

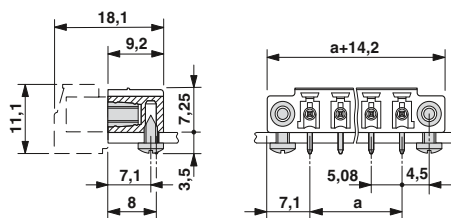

Drilling diagram

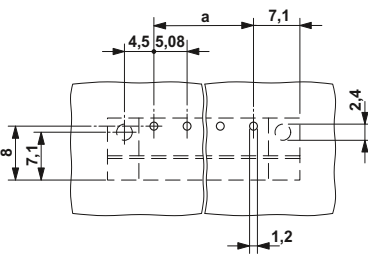

Dimensional drawing

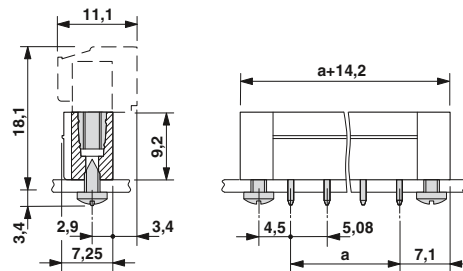

Drilling diagram

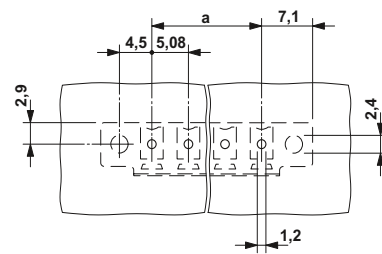

Ordering data

Type	Order No.	Pcs. / Pkt.
5.08 mm pitch, color: green		
MCV 1,5/ 2-G-5,08	1836299	50
MCV 1,5/ 3-G-5,08	1836309	50
MCV 1,5/ 4-G-5,08	1836312	50
MCV 1,5/ 5-G-5,08	1836325	50
MCV 1,5/ 6-G-5,08	1836338	50
MCV 1,5/ 7-G-5,08	1836341	50
MCV 1,5/ 8-G-5,08	1836354	50
MCV 1,5/ 9-G-5,08	1836367	50
MCV 1,5/10-G-5,08	1836370	50
MCV 1,5/11-G-5,08	1836383	50
MCV 1,5/12-G-5,08	1836396	50

Ordering data

Type	Order No.	Pcs. / Pkt.
5.08 mm pitch, color: green		
MC 1,5/ 2-GF-5,08	1847466	50
MC 1,5/ 3-GF-5,08	1847479	50
MC 1,5/ 4-GF-5,08	1847482	50
MC 1,5/ 5-GF-5,08	1847495	50
MC 1,5/ 6-GF-5,08	1847505	50
MC 1,5/ 7-GF-5,08	1847518	50
MC 1,5/ 8-GF-5,08	1847521	50
MC 1,5/ 9-GF-5,08	1847534	50
MC 1,5/10-GF-5,08	1847547	50
MC 1,5/11-GF-5,08	1847550	50
MC 1,5/12-GF-5,08	1847563	50

Ordering data

Type	Order No.	Pcs. / Pkt.
5.08 mm pitch, color: green		
MCV 1,5/ 2-GF-5,08	1847615	50
MCV 1,5/ 3-GF-5,08	1847628	50
MCV 1,5/ 4-GF-5,08	1847631	50
MCV 1,5/ 5-GF-5,08	1847644	50
MCV 1,5/ 6-GF-5,08	1847657	50
MCV 1,5/ 7-GF-5,08	1847660	50
MCV 1,5/ 8-GF-5,08	1847673	50
MCV 1,5/ 9-GF-5,08	1847686	50
MCV 1,5/10-GF-5,08	1847699	50
MCV 1,5/11-GF-5,08	1847709	50
MCV 1,5/12-GF-5,08	1847712	50

Mini plug-in connectors with 3.5/3.81 and 5.08 mm pitch

Special designs

SUBCON header with MINI COMBICON connection

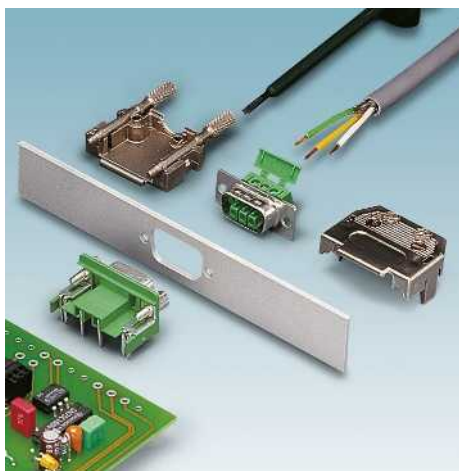

- A combination of MINI-COMBICON plug-in connectors and the good shielding properties and the geometry of D-SUB plug-in connectors
- 3-pos. POWER SUBCON in the shape of the 9-pos. D-SUB
- 5-pos. POWER SUBCON in the shape of the 15-pos. D-SUB
- Can be used in a conventional D-SUB housing

Notes:

In accordance with DIN EN 61984, COMBICON plug-in connectors have no switching power. During designated use, they must not be plugged in or disconnected when carrying voltage or under load.

When used in metal or metal-plated housing, SELV protection must be used with AC = 25 V and DC = 60 V.

For assembly cutout drawings see page 840.

Accessories

For all types	Type	Page
For PSC 1,5/3-M		
	Coding profile CP-MSTB Order No. 1734634	38

Technical data

Technical data in accordance to IEC / DIN VDE	
Rated current / conductor cross section	[A] / [mm ²]
Rated insulation voltage for pollution degree 2	[V]
Pitch	[mm]
Connection capacity	
Solid / stranded	[mm ²] / [mm ²] / AWG
Stranded with ferrules without plastic sleeve	[mm ²]
Stranded with ferrules with plastic sleeve	[mm ²]
Multi-conductor connection capacity (two conductors with the same cross section)	
Solid / stranded	[mm ²]
Stranded with ferrules without plastic sleeve	[mm ²]
Stranded with TWIN ferrule with plastic sleeve	[mm ²]
Insulation coordination	
Surge voltage category / pollution degree	
Rated insulation voltage	[V]
Rated surge voltage	[kV]
Approval data (UL/CUL)	Use Group
Nominal voltage	[V]
Nominal current	[A]
Connection capacity AWG	AWG
Approval data (CSA)	Use Group
Nominal voltage	[V]
Nominal current	[A]
Connection capacity AWG	AWG
General data	
Screw thread	
Tightening torque	[Nm]
Type of insulation material / insulation material group	
Inflammability class according to UL 94	

PSC 1,5/ 3-F

Rated current / conductor cross section			8 / 1.5
Rated insulation voltage for pollution degree 2			-
Pitch			3.5
Connection capacity			
Solid / stranded			0.14 - 1.5 / 0.14 - 1.5 / 28 - 16
Stranded with ferrules without plastic sleeve			0.25 - 1.5
Stranded with ferrules with plastic sleeve			0.25 - 1.5
Multi-conductor connection capacity (two conductors with the same cross section)			
Solid / stranded			- / -
Stranded with ferrules without plastic sleeve			-
Stranded with TWIN ferrule with plastic sleeve			-
Insulation coordination			
Surge voltage category	III / 3	III / 2	II / 2
Rated insulation voltage	250		
Rated surge voltage			
Approval data (UL/CUL)	B	C	D
Nominal voltage	300	-	300
Nominal current	8	-	8
Connection capacity AWG	30 - 14	-	30 - 14
Approval data (CSA)	B	C	D
Nominal voltage	300	-	300
Nominal current	8	-	8
Connection capacity AWG	28 - 16	-	28 - 16
Screw thread	M2		
Tightening torque	0.22 - 0.25		
Type of insulation material / insulation material group	PA / I		
Inflammability class according to UL 94	V0		

PSC 1,5/ 5-F

Rated current / conductor cross section			8 / 1.5
Rated insulation voltage for pollution degree 2			-
Pitch			3.5
Connection capacity			
Solid / stranded			0.14 - 1.5 / 0.14 - 1.5 / 28 - 16
Stranded with ferrules without plastic sleeve			0.25 - 1.5
Stranded with ferrules with plastic sleeve			0.25 - 1.5
Multi-conductor connection capacity (two conductors with the same cross section)			
Solid / stranded			- / -
Stranded with ferrules without plastic sleeve			-
Stranded with TWIN ferrule with plastic sleeve			-
Insulation coordination			
Surge voltage category	III / 3	III / 2	II / 2
Rated insulation voltage	250		
Rated surge voltage			
Approval data (UL/CUL)	B	C	D
Nominal voltage	300	-	300
Nominal current	8	-	8
Connection capacity AWG	30 - 14	-	30 - 14
Approval data (CSA)	B	C	D
Nominal voltage	300	-	300
Nominal current	8	-	8
Connection capacity AWG	28 - 16	-	28 - 16
Screw thread	M2		
Tightening torque	0.22 - 0.25		
Type of insulation material / insulation material group	PA / I		
Inflammability class according to UL 94	V0		

PSC 1,5/ 3-M

Rated current / conductor cross section			8
Rated insulation voltage for pollution degree 2			-
Pitch			3.5
Connection capacity			
Solid / stranded			- / - / -
Stranded with ferrules without plastic sleeve			-
Stranded with ferrules with plastic sleeve			-
Multi-conductor connection capacity (two conductors with the same cross section)			
Solid / stranded			- / -
Stranded with ferrules without plastic sleeve			-
Stranded with TWIN ferrule with plastic sleeve			-
Insulation coordination			
Surge voltage category	III / 3	III / 2	II / 2
Rated insulation voltage	250		
Rated surge voltage			
Approval data (UL/CUL)	B	C	D
Nominal voltage	300	-	300
Nominal current	8	-	8
Connection capacity AWG	-	-	-
Approval data (CSA)	B	C	D
Nominal voltage	300	-	300
Nominal current	8	-	8
Connection capacity AWG	-	-	-
Screw thread	-		
Tightening torque	-		
Type of insulation material / insulation material group	PA / I		
Inflammability class according to UL 94	V0		

No. of pos.	Dim. a [mm]
3	7.00
5	14.00



Shielded POWER SUBCON plug with screw connection and cover cap



Shielded POWER SUBCON plug with screw connection and cover cap



Shielded POWER SUBCON header, for wall thicknesses of up to 4.5 mm, 4-40 UNC fastening thread



Dimensional drawing

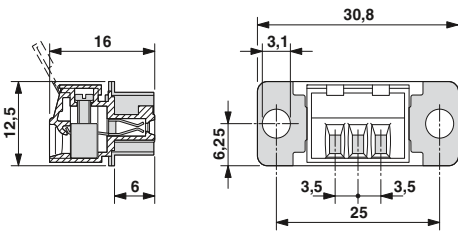

Dimensional drawing

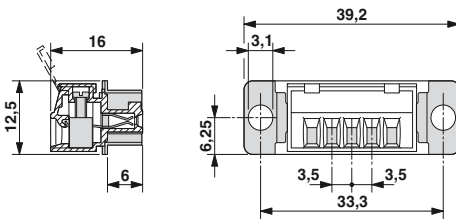

Dimensional drawing

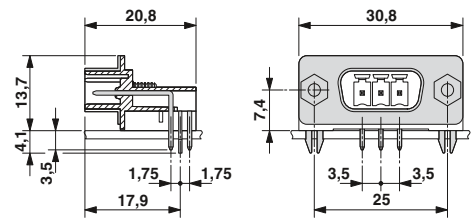

Drilling diagram

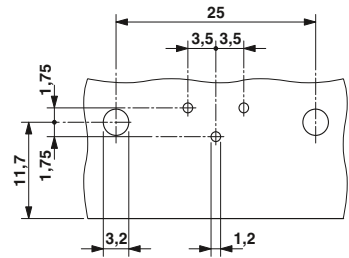

Ordering data

Type	Order No.	Pcs. / Pkt.
Color: green		
PSC 1,5/ 3-F	1841909	50

Ordering data

Type	Order No.	Pcs. / Pkt.
Color: green		
PSC 1,5/ 5-F	1841912	50

Ordering data

Type	Order No.	Pcs. / Pkt.
Color: green		
PSC 1,5/ 3-M	1841857	50

Mini plug-in connectors with 3.5/3.81 and 5.08 mm pitch

Special designs

SUBCON header with MINI COMBICON connection



- A combination of MINI-COMBICON plug-in connectors and the good shielding properties and the geometry of D-SUB plug-in connectors
- 3-pos. POWER SUBCON in the shape of the 9-pos. D-SUB
- 5-pos. POWER SUBCON in the shape of the 15-pos. D-SUB
- Can be used in a conventional D-SUB housing
- PSC 1,5/...-M-PE version with leading, medium PE contact

Notes:

In accordance with DIN EN 61984, COMBICON plug-in connectors have no switching power. During designated use, they must not be plugged in or disconnected when carrying voltage or under load.

When used in metal or metal-plated housing, SELV protection must be used with AC = 25 V and DC = 60 V.

For assembly cutout drawings see page 840.

Accessories

For all types	Type	Page
	Coding profile CP-MSTB Order No. 1734634	38

Technical data

Technical data in accordance to IEC / DIN VDE

Rated current	[A]			
Rated insulation voltage for pollution degree 2	[V]			
Pitch	[mm]			
Insulation coordination				
Surge voltage category / pollution degree				
Rated insulation voltage	[V]			
Rated surge voltage	[kV]			
Approval data (UL/CUL)	Use Group			
Nominal voltage	[V]			
Nominal current	[A]			
Connection capacity AWG	AWG			
Approval data (CSA)	Use Group			
Nominal voltage	[V]			
Nominal current	[A]			
Connection capacity AWG	AWG			
General data				
Type of insulation material / insulation material group				
Inflammability class according to UL 94				

PSC 1,5/ 5-M

Rated current	8		
Rated insulation voltage for pollution degree 2	-		
Pitch	3.5		
Insulation coordination			
Surge voltage category / pollution degree	III / 3 III / 2 II / 2		
Rated insulation voltage	250		
Rated surge voltage			
Approval data (UL/CUL)	B C D		
Nominal voltage	300 - 300		
Nominal current	8 - 8		
Connection capacity AWG	- - -		
Approval data (CSA)	B C D		
Nominal voltage	300 - 300		
Nominal current	8 - 8		
Connection capacity AWG	- - -		
Type of insulation material / insulation material group	PA / I		
Inflammability class according to UL 94	V0		

PSC 1,5/ 3-M-PE

Rated current	8		
Rated insulation voltage for pollution degree 2	-		
Pitch	3.5		
Insulation coordination			
Surge voltage category / pollution degree	III / 3 III / 2 II / 2		
Rated insulation voltage	250		
Rated surge voltage			
Approval data (UL/CUL)	B C D		
Nominal voltage	300 - 300		
Nominal current	8 - 8		
Connection capacity AWG	- - -		
Approval data (CSA)	B C D		
Nominal voltage	300 - 300		
Nominal current	8 - 8		
Connection capacity AWG	- - -		
Type of insulation material / insulation material group	PA / I		
Inflammability class according to UL 94	V0		

PSC 1,5/ 5-M-PE

Rated current	8		
Rated insulation voltage for pollution degree 2	-		
Pitch	3.5		
Insulation coordination			
Surge voltage category / pollution degree	III / 3 III / 2 II / 2		
Rated insulation voltage	250		
Rated surge voltage			
Approval data (UL/CUL)	B C D		
Nominal voltage	300 - 300		
Nominal current	8 - 8		
Connection capacity AWG	- - -		
Approval data (CSA)	B C D		
Nominal voltage	300 - 300		
Nominal current	8 - 8		
Connection capacity AWG	- - -		
Type of insulation material / insulation material group	PA / I		
Inflammability class according to UL 94	V0		

No. of pos.	Dim. a [mm]
3	7.00
5	14.00



Shielded POWER SUBCON header for wall thicknesses of up to 4.5 mm, 4-40 UNC fastening thread



Dimensional drawing

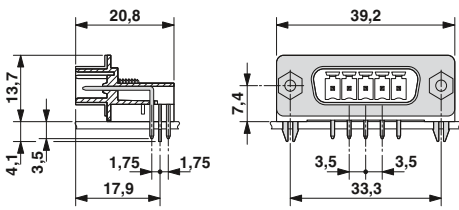

Drilling diagram

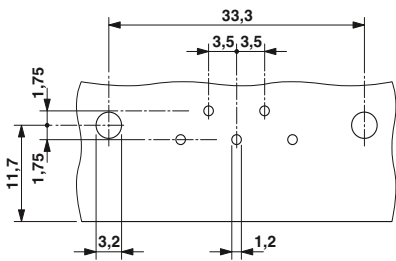

Ordering data

Type	Order No.	Pcs. / Pkt.
Color: green		
PSC 1,5/ 5-M	1841899	50



Shielded POWER SUBCON header for wall thicknesses of up to 4.5 mm, 4-40 UNC fastening thread, with leading medium PE contact



Dimensional drawing

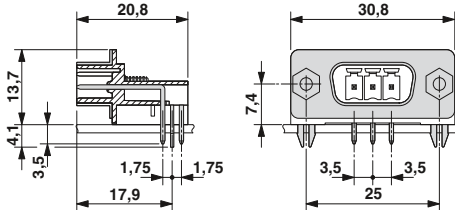

Drilling diagram

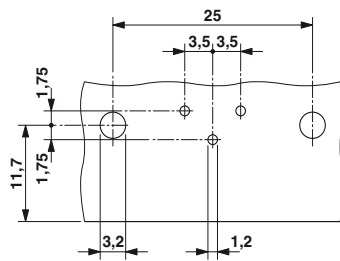

Ordering data

Type	Order No.	Pcs. / Pkt.
Color: green		
PSC 1,5/ 3-M-PE	1848122	50



Shielded POWER SUBCON header for wall thicknesses of up to 4.5 mm, 4-40 UNC fastening thread, with leading medium PE contact



Dimensional drawing

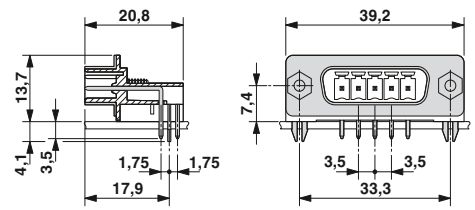

Drilling diagram

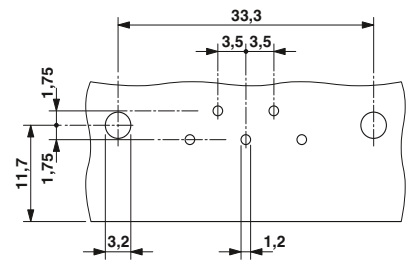

Ordering data

Type	Order No.	Pcs. / Pkt.
Color: green		
PSC 1,5/ 5-M-PE	1848135	50

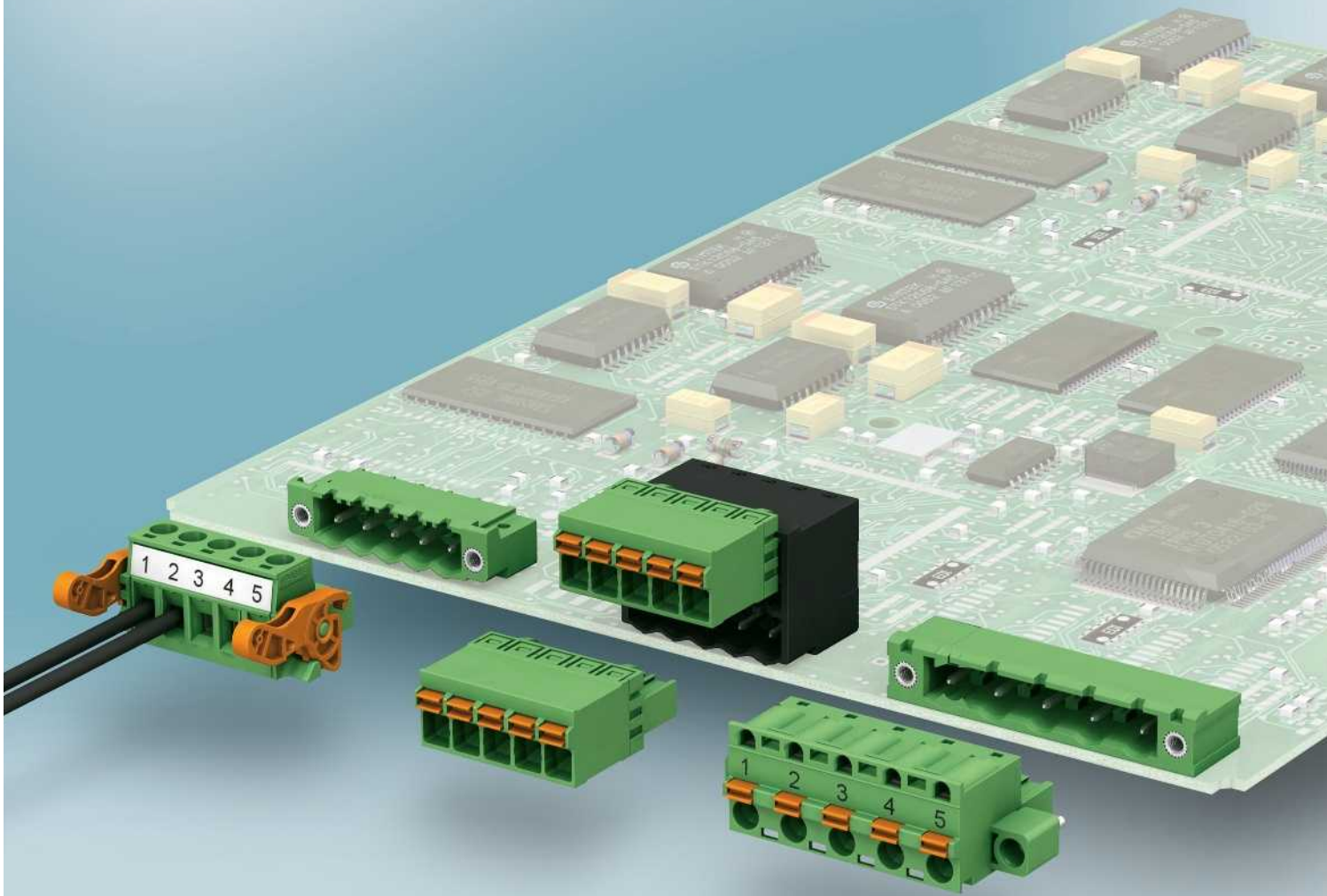

Plug-in connector systems with 5.0 to 7.62 mm pitch

COMBICON plug-in connectors have established themselves as the worldwide standard in industrial electronics.

A wide range of plugs and headers are available with 5.0/5.08 and 7.5/7.62 mm pitch.

Choose from screw, push-in spring, crimp or displacement connection for conductor contacting. Horizontal, vertical, and inverted plug and header designs enable plug-in PCB connections, PCB pairing with PCB or free-hanging connections.

Customer-specific versions complete the range of services. In addition to the standard green housing, a further 20 colors are available on request. The headers and plugs can be labeled individually for clear identification of each terminal point. For external device connections or harsh operating conditions such as vibrations, additional locking of the plug and header is advisable. This can be achieved with the particularly user-friendly Lock & Release connection, a self-locking flange connection or proven screw flanges.

When using several plug-in connections in an application, clear assignment of the plugs and headers is possible by means of individual coding.

General	256
COMBICON control cross-reference list	259
CLASSIC COMBICON plug-in connectors Pitch 5.0/5.08 mm up to 12 A	262
Plugs with screw connection	262
Inverted plugs with screw connection	272
Plugs with push-in spring connection	274
Inverted plugs with push-in spring connection	286
Plugs with displacement connection	290
Plugs with crimp connection	294
Inverted connectors with crimp connection	296
Headers for reflow processes	298
Headers for press-in technology	310
Headers for wave soldering processes	312
Inverted headers for wave soldering processes	332
CLASSIC COMBICON plug-in connectors Pitch 7.5/7.62 mm up to 12 A	334
Plugs with screw connection	334
Inverted plugs with screw connection	338
Plugs with push-in spring connection	340
Inverted plugs with push-in spring connection	341
Headers for wave soldering processes	342
Inverted headers for wave soldering processes	346
Special designs	348
Cable housing	348
Feed-through headers and assembly frames	350
Plug-in blocks for direct mounting	356
Plug-in blocks for DIN rail mounting	358
ZEC series - direct plug-in connectors	365
MINI-COMBICON for D-SUB	251
CLASSIC COMBICON plug-in connectors for the Ex area with 5.08 and 7.62 mm pitch	369
Plugs with screw connection with 5.08 mm pitch	369
Plugs with push-in spring connection	371
Inverted plugs with 5.08 mm pitch	373
Headers for wave soldering processes	369
Inverted headers for wave soldering processes	377
Plugs with screw connection with 7.62 mm pitch	379
Headers for wave soldering processes with 7.62 mm pitch	383

Classic plug-in connector with 5.0 to 7.62 mm pitch

General

Customer-specific standard plug-in connectors

Customer-specific requirements and requests can also be taken into account when producing plug-in connectors. Usually plug-in connectors are available as partially assembled versions and in various colors.

Standard plug-in connectors with special pins

Individual processing of pin strips in the soldering process as well as the special environmental requirements are taken into consideration in many product ranges, which is why solder pins of different lengths and with different surfaces (e.g., tin or gold) are available for these pins.

Test connections

Test connections or touch connections are integrated in many plugs for measurement and test purposes.



Partially assembled pin strip

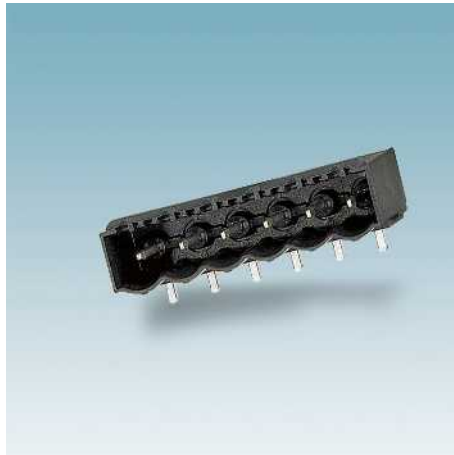

Version with tin-plated pins

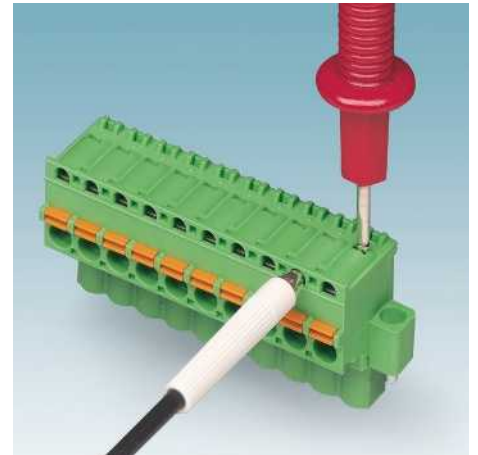

Integrated test connections



Color options



Version with partially gold-plated pins

COMBICON plug-in connectors

In accordance with DIN EN 61984, COMBICON plug-in connectors have no switching power. When used as intended, they may not be connected or disconnected while they are live or under load.

Encoding

If plugs from a series with the same number of positions are used in an application, clear assignment of the plugs and headers is possible by means of individual coding. The coding can be implemented later on site or is provided in pre-assembled versions.

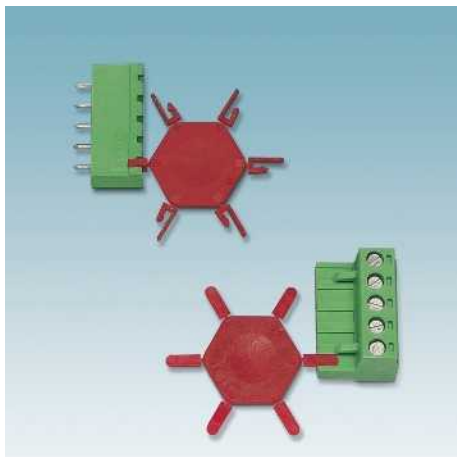

Coding with coding section and coding profile

Bridges

In addition to conventional TWIN plug-in connectors, standard plug-in connectors can also be used for potential distribution by means of separate bridges. The fixed bridge is connected directly in the connection area, if necessary, with a supply conductor.



Separate fixed bridges

Marking

For marking individual terminal points, marker cards (SK strips with consecutive numbers 1 - 10, 11 - 20) are available with 2.5 to 7.62 mm pitch. Alternatively, the terminal blocks can also be supplied with individual marking.

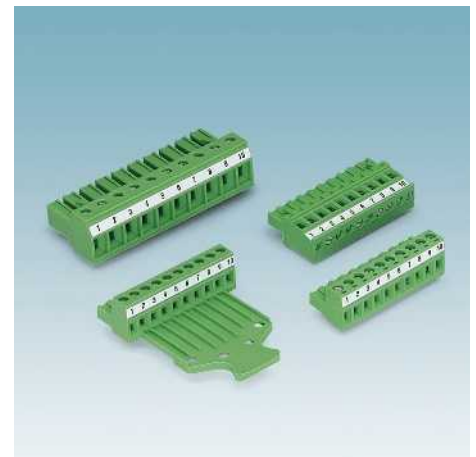

SK marker strips



Example for combination that cannot be plugged in



Separate fixed bridges

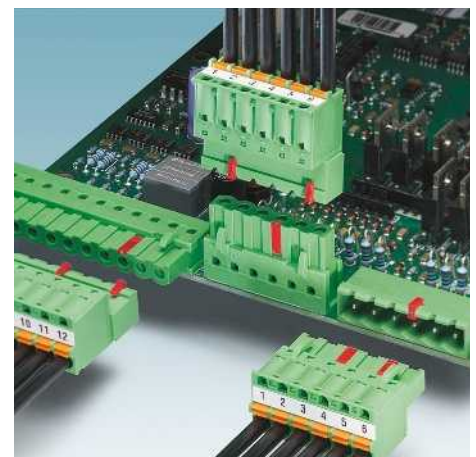

















Coding/printing

Note:

Since the installation environment of the entire PCB cannot be influenced, the specified nominal voltage of all COMBICON plug-in connectors refers to the "as-delivered" state. For more detailed information on the dimensioning of air and creepage distances of PCBs, see page 849.















Classic plug-in connector with 5.0 to 7.62 mm pitch















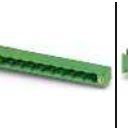



COMBICON control cross-reference list

CLASSIC COMBICON plugs	Type	CLASSIC COMBICON headers	CLASSIC COMBICON headers						
			IC...ST(F) Page 272	IC...STGF Page 273	FKIC(S)...ST(F) Page 273 288 5.0 5.08	FKIC(S)...ST(D)...RN Page 287	ICC...STZ(F) Page 296	CC(A)...G CCV(A)...G Page 298 300	CC...GF CCV...GF Page 299 301
	Pitch		5.08	5.08	5.08	5.08	5.08	5.08	5.08
	QC 1...ST Page 290 QC 1...STF Page 291	5.08	•	•	•		•	•	•
	QC 1,5...ST Page 292 QC 1,5...STF Page 293	5.0		•	•				•
	MSTB(T)...ST Page 262 MSTB(T)...STF Page 265	5.0 5.08 5.0 5.08	•		•		•	•	•
	SMSTB...ST Page 268 SMSTB...STF Page 269	5.0 5.08 5.0 5.08	•		•		•	•	•
	MVSTBR(W)...ST Page 266 MVSTBR(W)...STF Page 267	5.0 5.08 5.0 5.08	•		•		•	•	•
	FRONT-MSTB...ST Page 269 FRONT-MSTB...STF Page 269	5.0 5.08 5.0 5.08	•		•		•	•	•
	TMSTBP...ST Page 270 TMSTBP...STF Page 271	5.08 5.08	•		•		•	•	•
	TVMSTB...ST Page 271 TVMSTB...STF Page 271	5.08 5.08	•		•		•	•	•
	FKC(S)...ST Page 274 FKC(S)...STF Page 275	5.0 5.08 5.0 5.08	•		•		•	•	•
	FKC...ST...RF Page 275	5.0 5.08				•	•		
	FKCT...ST Page 277 FKCT...STF Page 277	5.0 5.08 5.0 5.08	•		•		•	•	•
	FKCN...ST Page 278 FKCN...STF Page 279	5.0 5.08 5.0 5.08	•		•		•	•	•
	FKCVR(W)...ST Page 280 FKCVR(W)...STF Page 281	5.0 5.08 5.0 5.08	•		•		•	•	•
	TVFKC...ST Page 282 TVFKC...STF Page 283	5.0 5.0			•				
	TFKC...ST Page 284 TFKC...STF Page 284	5.08 5.08	•		•		•	•	•
	MSTBC...ST(Z) Page 294 MSTBC...STZF Page 295 MSTBC...STZ...R Page 295	5.08 5.08 5.08	•		•		•	•	•
	IC(V)...G Page 332 IC(V)...GF Page 333	5.08 5.08	•		•		•	•	•

Classic plug-in connector with 5.0 to 7.62 mm pitch

COMBICON control cross-reference list

CLASSIC COMBICON plugs	Type	Pitch	CLASSIC COMBICON headers						
			CC...GF...LR THR CCV...GF...LR THR THR Page 299 301	MDSTB(A)...G MDSTBW...G MDSTBV(A)...G 326 / 329 / 320	MDSTB...GF MDSTBV...GF Page 327 331	MDSTB...G1 MDSTBV...G1 Page 329 329	DFK-MSTB...G DFK-MSTB(V)A...G Page 352 354	DFK-MSTB...GF DFK-MSTB(V)A...GF Page 353 355	MVSTBU...GB MVSTBU...GFB Page 357
	QC 1...ST Page 290 QC 1...STF Page 291	5.08		•	•	•	•	•	
	QC 1,5...ST Page 292 QC 1,5...STF Page 293	5.0		•	•	•	•	•	
	MSTB(T)...ST Page 262 MSTB(T)...STF Page 265	5.0 5.08 5.0 5.08		• • •	• • •	• • •	• • •	• • •	
	SMSTB...ST Page 268 SMSTB...STF Page 269	5.0 5.08 5.0 5.08		• • •	• • •	• • •	• • •	• • •	
	MVSTBR(W)...ST Page 266 MVSTBR(W)...STF Page 267	5.0 5.08 5.0 5.08		• • •	• • •	• • •	• • •	• • •	
	FRONT-MSTB...ST Page 267 FRONT-MSTB...STF Page 269	5.0 5.08 5.0 5.08		• • •	• • •	• • •	• • •	• • •	
	TMSTBP...ST Page 270 TMSTBP...STF Page 271	5.08 5.08		• •			• •		
	TVMSTB...ST Page 271 TVMSTB...STF Page 271	5.08 5.08		• •			• •		
	FKC(S)...ST Page 274 FKC(S)...STF Page 274	5.0 5.08 5.0 5.08		• • •	• •	• •	• •	• •	
	MSTB...ST...LR Page 263 FKC...ST...LR Page 275	5.08 5.08		• •					
	FKCT...ST Page 277 FKCT...STF Page 277	5.0 5.08 5.0 5.08		• • •	• •	• •	• •	• •	
	FKCN...ST Page 278 FKCN...STF Page 279	5.0 5.08 5.0 5.08		• • •	• •	• •	• •	• •	
	FKCVR(W)...ST Page 280 FKCVR(W)...STF Page 281	5.0 5.08 5.0 5.08		• • •			• • •	• • •	
	TVFKC...ST Page 282 TVFKCL...ST Page 283	5.0 5.0					• •		
	TFKC...ST Page 284 TFKC...STF Page 285	5.08 5.08		• •			• •		
	MSTBC...ST(Z) Page 294 MSTBC...STZF Page 295 MSTBC...STZ...R Page 295	5.08 5.08 5.08		• • •	•	•	• • •	• • •	
	IC(V)...G Page 332 IC(V)...GF Page 333	5.08 5.08		• •		•	• •	• •	

CLASSIC COMBICON plugs	CLASSIC COMBICON headers								
	Type	Pitch	GIC... ST Page 338	GIC... STF Page 339	GIC... STGF Page 339	GFKIC... ST Page 341	GMSTB...G GMSTBA...G Page 343 / 342	GMSTB...GF GMSTBV...GF Page 343 345	GMSTBV...G GMSTBVA...G Page 344
	GMSTB...ST Page 334	7.5 7.62	•			•	• •		• •
	GMSTB...STF Page 335	7.62			•			•	
	FRONT-GMSTB...ST Page 335	7.62	•			•	•		•
	FRONT-GMSTB...STF Page 335	7.62			•			•	
	GMVSTBR(W)...ST Page 336	7.5 7.62	•			•	• •		• •
	GMVSTBR(W)...STF Page 337	7.62			•			•	
	GFKC...ST Page 340	7.5 7.62	•			•	• •		• •
	GFKC...STF Page 341	7.62			•			•	
	GIC...G Page 346	7.62	•			•	•		•
	GIC...GF Page 347	7.62			•				
	GICV...G Page 347	7.62	•			•	•		•
	GICV...GF Page 347	7.62			•				

Classic plug-in connector with 5.0 to 7.62 mm pitch

CLASSIC COMBICON plug-in connectors, pitches 5.0 or 5.08 mm

Plug with a screw connection

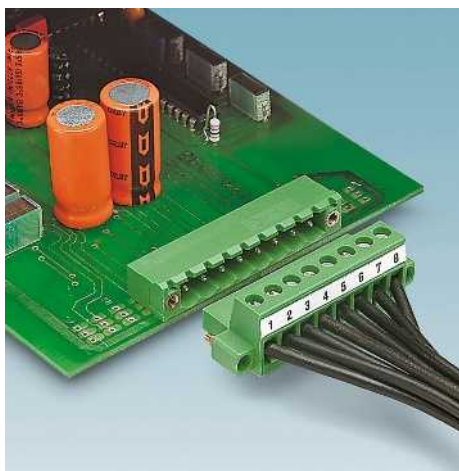

- Standard plug-in system for 320 V (III/2)
- Plug-in direction parallel to the conductor axis
- Versions with screw flange, pull-out aid, and Lock & Release levers
- Individual position coding by inserting the coding profiles
- Higher numbers of positions up to 24-pos. can be found at:
www.phoenixcontact.net/products

Notes:

In accordance with DIN EN 61984, COMBICON plug-in connectors have no switching power. During designated use, they must not be plugged in or disconnected when carrying voltage or under load.

MSTB 2,5/...-STZ

	Dimension b [mm]	Dimension c [mm]
2- to 4-pos.	9.9	46
5- to 8-pos.	19.9	46
From 9-pos. onwards	39.9	55.6

The maximum torque for the screw flange is 0.3 Nm.

1) Please observe the derating curves. Derating curves of further combination options on request.



Plug with screw connection



Dimensional drawing

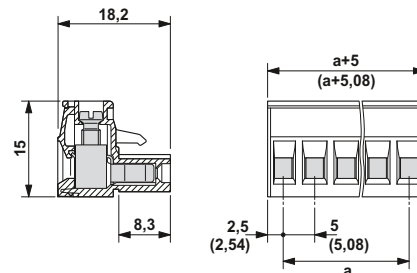

Note derating curves

Derating curves, determined as per DIN EN 61984 (VDE 0627):2002-09
Representation based on DIN EN 60512-5-2:2003-01
Connected conductor cross section = 2.5 mm²
Reduction factor = 0.8
Number of positions = see diagram

Accessories

For all types	Type	Page
	Marker cards SK 5/3,8 or SK 5,08/3,8	798
	Screwdriver SZS 0,6 x 3,5 Order No. 1205053	
	Coding profile CP-MSTB Order No. 1734634	38
	Insertion bridge EBP...-5	829

Technical data

Technical data in accordance to IEC / DIN VDE	
Rated current / conductor cross section	[A] / [mm ²]
Rated insulation voltage for pollution degree 2	[V]
Pitch	[mm]
Connection capacity	
Solid / stranded	[mm ²] / [mm ²] / AWG
Stranded with ferrules without plastic sleeve	[mm ²]
Stranded with ferrules with plastic sleeve	[mm ²]
Multi-conductor connection capacity (two conductors with the same cross section)	
Solid / stranded	[mm ²]
Stranded with ferrules without plastic sleeve	[mm ²]
Stranded with TWIN ferrule with plastic sleeve	[mm ²]
Insulation coordination	
Surge voltage category / pollution degree	III / 3 III / 2 II / 2
Rated insulation voltage	[V]
Rated surge voltage	[kV]
Approval data (UL/CUL)	Use Group
Nominal voltage	[V]
Nominal current	[A]
Connection capacity AWG	AWG
Approval data (CSA)	Use Group
Nominal voltage	[V]
Nominal current	[A]
Connection capacity AWG	AWG
General data	
Stripping length	[mm]
Screw thread	
Tightening torque	[Nm]
Type of insulation material / insulation material group	
Inflammability class according to UL 94	

	12 ¹⁾ / 2.5
	320
	5 / 5.08
	0.2 - 2.5 / 0.2 - 2.5 / 24 - 12
	0.25 - 2.5
	0.25 - 2.5
	0.2 - 1 / 0.2 - 1.5
	0.25 - 1
	0.5 - 1.5
	III / 3 III / 2 II / 2
	250 320 630
	4 4 4
	B C D
	300 - 300
	15 - 15
	30 - 12 - 30 - 12
	B C D
	300 - 300
	10 - 10
	28 - 12 - 28 - 12
	7
	M3
	0.5 - 0.6
	PA / I
	V0

Ordering data

No. of pos.	Dim. a [mm]	Type	Order No.	Pcs. / Pkt.
5.0 mm pitch, color: green				
2	5.00	MSTB 2,5/ 2-ST	1754449	50
3	10.00	MSTB 2,5/ 3-ST	1754465	50
4	15.00	MSTB 2,5/ 4-ST	1754481	50
5	20.00	MSTB 2,5/ 5-ST	1754504	50
6	25.00	MSTB 2,5/ 6-ST	1754520	50
7	30.00	MSTB 2,5/ 7-ST	1754546	50
8	35.00	MSTB 2,5/ 8-ST	1754562	50
9	40.00	MSTB 2,5/ 9-ST	1754588	50
10	45.00	MSTB 2,5/10-ST	1754601	50
11	50.00	MSTB 2,5/11-ST	1754627	50
12	55.00	MSTB 2,5/12-ST	1754643	50
13	60.00	MSTB 2,5/13-ST	1754669	50
14	65.00	MSTB 2,5/14-ST	1754685	50
15	70.00	MSTB 2,5/15-ST	1754708	50
16	75.00	MSTB 2,5/16-ST	1754724	50
5.08 mm pitch, color: green				
2	5.08	MSTB 2,5/ 2-ST-5,08	1757019	50
3	10.16	MSTB 2,5/ 3-ST-5,08	1757022	50
4	15.24	MSTB 2,5/ 4-ST-5,08	1757035	50
5	20.32	MSTB 2,5/ 5-ST-5,08	1757048	50
6	25.40	MSTB 2,5/ 6-ST-5,08	1757051	50
7	30.48	MSTB 2,5/ 7-ST-5,08	1757064	50
8	35.56	MSTB 2,5/ 8-ST-5,08	1757077	50
9	40.64	MSTB 2,5/ 9-ST-5,08	1757080	50
10	45.72	MSTB 2,5/10-ST-5,08	1757093	50
11	50.80	MSTB 2,5/11-ST-5,08	1757103	50
12	55.88	MSTB 2,5/12-ST-5,08	1757116	50
13	60.96	MSTB 2,5/13-ST-5,08	1757129	50
14	66.04	MSTB 2,5/14-ST-5,08	1757132	50
15	71.12	MSTB 2,5/15-ST-5,08	1757145	50
16	76.20	MSTB 2,5/16-ST-5,08	1757158	50

Classic plug-in connector with 5.0 to 7.62 mm pitch

CLASSIC COMBICON plug-in connectors, pitches 5.0 or 5.08 mm

N



With screw flange



With pull-out aid



With Lock & Release levers for locking and releasing



Dimensional drawing

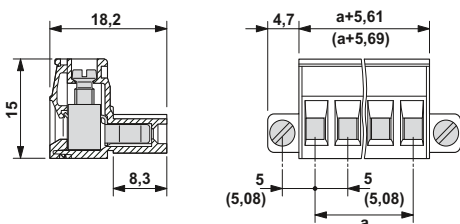

Dimensional drawing

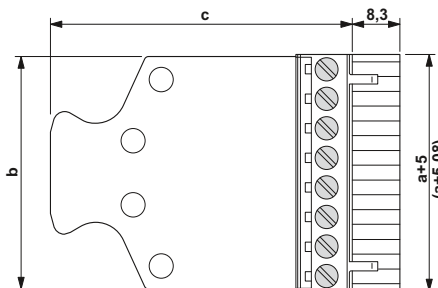

Dimensional drawing

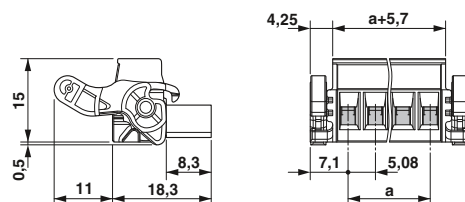

Representative derating curves of the above-mentioned plugs

Type: MSTB 2,5/...-ST(-5,08) with MSTBA 2,5/...-G(-5,08)

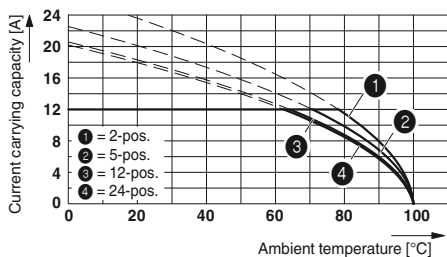

Type: MSTB 2,5/...-5,08 with CC 2,5/...-G-5,08 P26THR

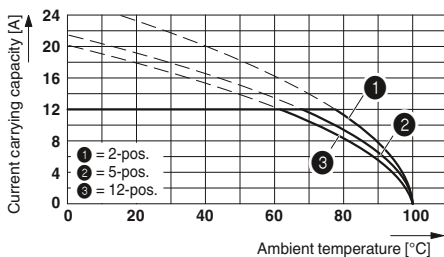

Type: MSTB 2,5/...-ST with MDSTB 2,5/...-G1

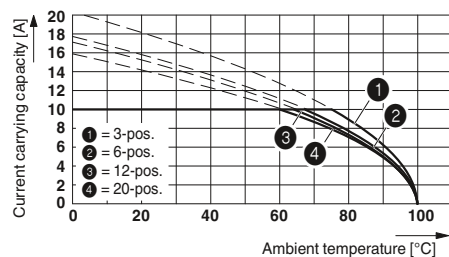

Ordering data

Type	Order No.	Pcs. / Pkt.
5.0 mm pitch, color: green		
MSTB 2,5/ 2-STF	1786831	50
MSTB 2,5/ 3-STF	1786844	50
MSTB 2,5/ 4-STF	1786857	50
MSTB 2,5/ 5-STF	1786860	50
MSTB 2,5/ 6-STF	1786873	50
MSTB 2,5/ 7-STF	1786886	50
MSTB 2,5/ 8-STF	1786899	50
MSTB 2,5/ 9-STF	1786909	50
MSTB 2,5/10-STF	1786912	50
MSTB 2,5/11-STF	1786925	50
MSTB 2,5/12-STF	1786938	50
MSTB 2,5/13-STF	1786941	50
MSTB 2,5/14-STF	1786954	50
MSTB 2,5/15-STF	1786967	50
MSTB 2,5/16-STF	1786970	50
5.08 mm pitch, color: green		
MSTB 2,5/ 2-STF-5,08	1777989	50
MSTB 2,5/ 3-STF-5,08	1777992	50
MSTB 2,5/ 4-STF-5,08	1778001	50
MSTB 2,5/ 5-STF-5,08	1778014	50
MSTB 2,5/ 6-STF-5,08	1778027	50
MSTB 2,5/ 7-STF-5,08	1778030	50
MSTB 2,5/ 8-STF-5,08	1778043	50
MSTB 2,5/ 9-STF-5,08	1778056	50
MSTB 2,5/10-STF-5,08	1778069	50
MSTB 2,5/11-STF-5,08	1778072	50
MSTB 2,5/12-STF-5,08	1778085	50
MSTB 2,5/13-STF-5,08	1778098	50
MSTB 2,5/14-STF-5,08	1778108	50
MSTB 2,5/15-STF-5,08	1778111	50
MSTB 2,5/16-STF-5,08	1778124	50

Ordering data

Type	Order No.	Pcs. / Pkt.
5.0 mm pitch, color: green		
MSTB 2,5/ 4-STZ	1739114	50
MSTB 2,5/ 8-STZ	1758982	50
MSTB 2,5/ 9-STZ	1758995	50
MSTB 2,5/10-STZ	1759004	50
MSTB 2,5/11-STZ	1759347	50
MSTB 2,5/12-STZ	1759350	50
MSTB 2,5/13-STZ	1759363	50
MSTB 2,5/14-STZ	1759376	50
MSTB 2,5/15-STZ	1759389	50
MSTB 2,5/16-STZ	1759392	50
5.08 mm pitch, color: green		
MSTB 2,5/ 2-STZ-5,08	1709791	50
MSTB 2,5/ 3-STZ-5,08	1776168	50
MSTB 2,5/ 4-STZ-5,08	1776155	50
MSTB 2,5/ 5-STZ-5,08	1776142	50
MSTB 2,5/ 6-STZ-5,08	1776126	50
MSTB 2,5/ 7-STZ-5,08	1776113	50
MSTB 2,5/ 8-STZ-5,08	1764235	50
MSTB 2,5/ 9-STZ-5,08	1764316	50
MSTB 2,5/10-STZ-5,08	1764303	50
MSTB 2,5/11-STZ-5,08	1764293	50
MSTB 2,5/12-STZ-5,08	1764280	50
MSTB 2,5/13-STZ-5,08	1764277	50
MSTB 2,5/14-STZ-5,08	1764264	50
MSTB 2,5/15-STZ-5,08	1764251	50
MSTB 2,5/16-STZ-5,08	1764248	50

Ordering data

Type	Order No.	Pcs. / Pkt.
5.08 mm pitch, color: green		
MSTB 2,5/ 2-ST-5,08-LR	1808886	50
MSTB 2,5/ 3-ST-5,08-LR	1808899	50
MSTB 2,5/ 4-ST-5,08-LR	1808909	50
MSTB 2,5/ 5-ST-5,08-LR	1808912	50
MSTB 2,5/ 6-ST-5,08-LR	1808925	50
MSTB 2,5/ 7-ST-5,08-LR	1808938	50
MSTB 2,5/ 8-ST-5,08-LR	1808941	50
MSTB 2,5/ 9-ST-5,08-LR	1808954	50
MSTB 2,5/10-ST-5,08-LR	1808967	50
MSTB 2,5/11-ST-5,08-LR	1808970	50
MSTB 2,5/12-ST-5,08-LR	1808983	50
MSTB 2,5/13-ST-5,08-LR	1808996	50
MSTB 2,5/14-ST-5,08-LR	1809005	50
MSTB 2,5/15-ST-5,08-LR	1809018	50
MSTB 2,5/16-ST-5,08-LR	1809021	50

Classic plug-in connector with 5.0 to 7.62 mm pitch

CLASSIC COMBICON plug-in connectors, pitches 5.0 or 5.08 mm

Plug with a screw connection

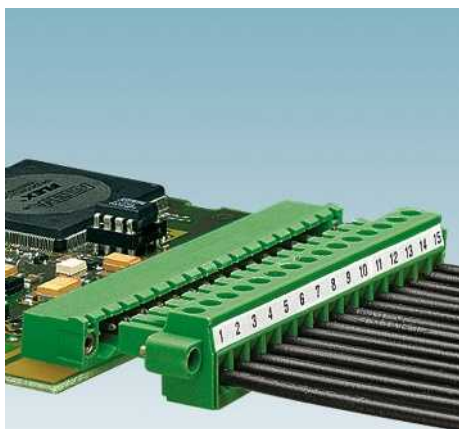

- Versions with and without a screw flange
- Higher numbers of positions up to 24-pos. can be found at: www.phoenixcontact.net/products
- Plug-in direction parallel to the conductor axis

MSTBP 2,5/...

- Test connection for MPS plugs

MSTBT 2,5/...

- The cable connection area of the MSTBT 2,5/... is located deeper than that of the MSTB 2,5/...

Notes:

In accordance with DIN EN 61984, COMBICON plug-in connectors have no switching power. During designated use, they must not be plugged in or disconnected when carrying voltage or under load.

COMBICON select

You will find the possible plug-in connector combinations in COMBICON select at: www.phoenixcontact.net/products or starting on page 259.

The maximum torque for the screw flange is 0.3 Nm.

¹⁾ Please observe the derating curves. Derating curves of further combination options on request.



With a test connection



Dimensional drawing

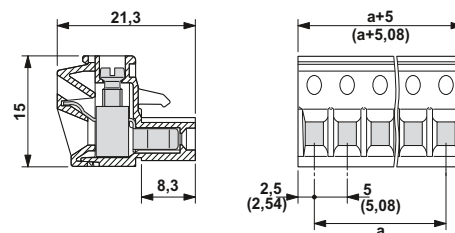

Note derating curves

Derating curves, determined as per DIN EN 61984 (VDE 0627):2002-09
Representation based on DIN EN 60512-5-2:2003-01
Connected conductor cross section = 2.5 mm²
Reduction factor = 0.8
Number of positions = see diagram

Accessories		
For all types	Type	Page
	Coding profile CP-MSTB Order No. 1734634	38
	Marker cards SK 5/3,8 or SK 5,08/3,8	798
	Screwdriver SZS 0,6 x 3,5 Order No. 1205053	
	Insertion bridge EBP...-5	829
Only for MSTBP 2,5/ ... -ST		
	Test plug MPS	831

Technical data

Technical data in accordance to IEC / DIN VDE	
Rated current / conductor cross section	[A] / [mm ²]
Rated insulation voltage for pollution degree 2	[V]
Pitch	[mm]
Connection capacity	
Solid / stranded	[mm ²] / [mm ²] / AWG
Stranded with ferrules without plastic sleeve	[mm ²]
Stranded with ferrules with plastic sleeve	[mm ²]
Multi-conductor connection capacity (two conductors with the same cross section)	
Solid / stranded	[mm ²]
Stranded with ferrules without plastic sleeve	[mm ²]
Stranded with TWIN ferrule with plastic sleeve	[mm ²]
Insulation coordination	
Surge voltage category / pollution degree	III / 3 III / 2 II / 2
Rated insulation voltage	[V]
Rated surge voltage	[kV]
Approval data (UL/CUL)	Use Group
Nominal voltage	[V]
Nominal current	[A]
Connection capacity AWG	AWG
Approval data (CSA)	Use Group
Nominal voltage	[V]
Nominal current	[A]
Connection capacity AWG	AWG
General data	
Stripping length	[mm]
Screw thread	
Tightening torque	[Nm]
Type of insulation material / insulation material group	
Inflammability class according to UL 94	

		12 ¹⁾ / 2.5
		320
		5 / 5.08
		0.2 - 2.5 / 0.2 - 2.5 / 24 - 12
		0.25 - 2.5
		0.25 - 2.5
		0.2 - 1 / 0.2 - 1.5
		0.25 - 1
		0.5 - 1.5
	III / 3	III / 2
	250	320
	4	4
	B	C
	300	-
	15	-
	30 - 12	-
	B	C
	300	-
	10	-
	28 - 12	-
		7
		M3
		0.5 - 0.6
		PA / I
		V0

No. of pos.	Dim. a [mm]
2	5.00
3	10.00
4	15.00
5	20.00
6	25.00
7	30.00
8	35.00
9	40.00
10	45.00
11	50.00
12	55.00
13	60.00
14	65.00
15	70.00
16	75.00

Ordering data

Type	Order No.	Pcs. / Pkt.
5.0 mm pitch, color: green		
MSTBP 2,5/ 2-ST	1765771	50
MSTBP 2,5/ 3-ST	1765784	50
MSTBP 2,5/ 4-ST	1765797	50
MSTBP 2,5/ 5-ST	1765807	50
MSTBP 2,5/ 6-ST	1765810	50
MSTBP 2,5/ 7-ST	1765823	50
MSTBP 2,5/ 8-ST	1765836	50
MSTBP 2,5/ 9-ST	1765849	50
MSTBP 2,5/10-ST	1765852	50
MSTBP 2,5/11-ST	1765865	50
MSTBP 2,5/12-ST	1765878	50
MSTBP 2,5/13-ST	1765881	50
MSTBP 2,5/14-ST	1765894	50
MSTBP 2,5/15-ST	1765904	50
MSTBP 2,5/16-ST	1765917	50
5.08 mm pitch, color: green		
MSTBP 2,5/ 2-ST-5,08	1769010	50
MSTBP 2,5/ 3-ST-5,08	1769023	50
MSTBP 2,5/ 4-ST-5,08	1769036	50
MSTBP 2,5/ 5-ST-5,08	1769049	50
MSTBP 2,5/ 6-ST-5,08	1769052	50
MSTBP 2,5/ 7-ST-5,08	1769065	50
MSTBP 2,5/ 8-ST-5,08	1769078	50
MSTBP 2,5/ 9-ST-5,08	1769081	50
MSTBP 2,5/10-ST-5,08	1769094	50
MSTBP 2,5/11-ST-5,08	1769104	50
MSTBP 2,5/12-ST-5,08	1769117	50
MSTBP 2,5/13-ST-5,08	1769120	50
MSTBP 2,5/14-ST-5,08	1769133	50
MSTBP 2,5/15-ST-5,08	1769146	50
MSTBP 2,5/16-ST-5,08	1769159	50



With connection area moved to the top



With connection area moved to the top and screw flange



Dimensional drawing

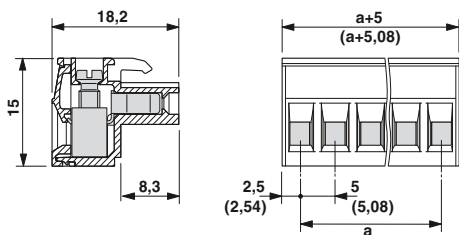

Dimensional drawing

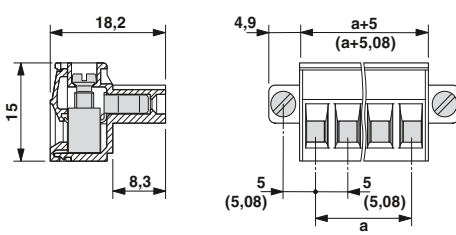

Representative derating curve

Type: MSTBT 2,5/...-ST with MSTBA 2,5/...-G

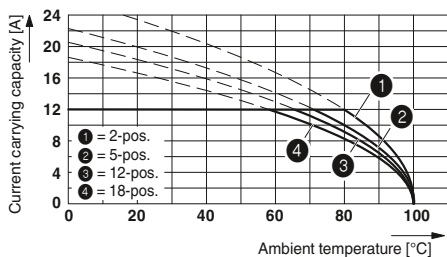

Ordering data

Type	Order No.	Pcs. / Pkt.
COMBICON screw connectors, 5.0 mm pitch, color: green		
MSTBT 2,5/ 2-ST	1779835	50
MSTBT 2,5/ 3-ST	1779848	50
MSTBT 2,5/ 4-ST	1779851	50
MSTBT 2,5/ 5-ST	1779864	50
MSTBT 2,5/ 6-ST	1779877	50
MSTBT 2,5/ 7-ST	1779880	50
MSTBT 2,5/ 8-ST	1779893	50
MSTBT 2,5/ 9-ST	1779903	50
MSTBT 2,5/10-ST	1779916	50
MSTBT 2,5/11-ST	1779929	50
MSTBT 2,5/12-ST	1779932	50
MSTBT 2,5/13-ST	1779945	50
MSTBT 2,5/14-ST	1779958	50
MSTBT 2,5/15-ST	1779961	50
MSTBT 2,5/16-ST	1779974	50
5.08 mm pitch, color: green		
MSTBT 2,5/ 2-ST-5,08	1779987	50
MSTBT 2,5/ 3-ST-5,08	1779990	50
MSTBT 2,5/ 4-ST-5,08	1780002	50
MSTBT 2,5/ 5-ST-5,08	1781014	50
MSTBT 2,5/ 6-ST-5,08	1781027	50
MSTBT 2,5/ 7-ST-5,08	1781030	50
MSTBT 2,5/ 8-ST-5,08	1781043	50
MSTBT 2,5/ 9-ST-5,08	1734207	50
MSTBT 2,5/10-ST-5,08	1781069	50
MSTBT 2,5/11-ST-5,08	1781072	50
MSTBT 2,5/12-ST-5,08	1781085	50
MSTBT 2,5/13-ST-5,08	1781098	50
MSTBT 2,5/14-ST-5,08	1781108	50
MSTBT 2,5/15-ST-5,08	1781111	50
MSTBT 2,5/16-ST-5,08	1781124	50

Ordering data

Type	Order No.	Pcs. / Pkt.
5.0 mm pitch, color: green		
MSTBT 2,5/ 2-STF	1919718	50
MSTBT 2,5/ 3-STF	1919721	50
MSTBT 2,5/ 4-STF	1919734	50
MSTBT 2,5/ 5-STF	1919747	50
MSTBT 2,5/ 6-STF	1919750	50
MSTBT 2,5/ 7-STF	1919763	50
MSTBT 2,5/ 8-STF	1919776	50
MSTBT 2,5/ 9-STF	1919789	50
MSTBT 2,5/10-STF	1919792	50
MSTBT 2,5/11-STF	1919802	50
MSTBT 2,5/12-STF	1919815	50
MSTBT 2,5/13-STF	1919828	50
MSTBT 2,5/14-STF	1919831	50
MSTBT 2,5/15-STF	1919844	50
MSTBT 2,5/16-STF	1919857	50
5.08 mm pitch, color: green		
MSTBT 2,5/ 2-STF-5,08	1805301	50
MSTBT 2,5/ 3-STF-5,08	1805314	50
MSTBT 2,5/ 4-STF-5,08	1805327	50
MSTBT 2,5/ 5-STF-5,08	1805330	50
MSTBT 2,5/ 6-STF-5,08	1805343	50
MSTBT 2,5/ 7-STF-5,08	1805356	50
MSTBT 2,5/ 8-STF-5,08	1804661	50
MSTBT 2,5/ 9-STF-5,08	1805369	50
MSTBT 2,5/10-STF-5,08	1805372	50
MSTBT 2,5/11-STF-5,08	1805385	50
MSTBT 2,5/12-STF-5,08	1805398	50
MSTBT 2,5/13-STF-5,08	1805408	50
MSTBT 2,5/14-STF-5,08	1805411	50
MSTBT 2,5/15-STF-5,08	1805424	50
MSTBT 2,5/16-STF-5,08	1805437	50

Classic plug-in connector with 5.0 to 7.62 mm pitch

CLASSIC COMBICON plug-in connectors, pitches 5.0 or 5.08 mm

Plug with a screw connection

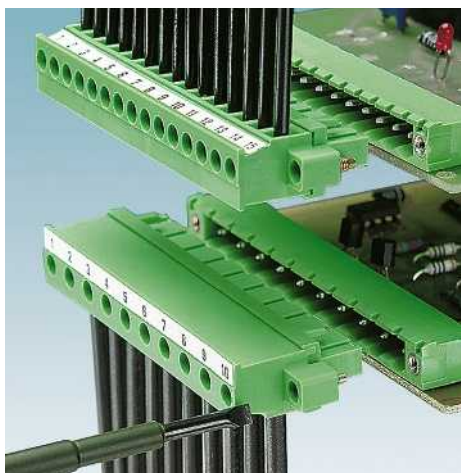

- MSTB plugs for vertical plug-in direction
- Versions with and without a screw flange

MVSTBR 2,5...-ST(-5,08)

- Conductor entry on the coded side of the connector

MVSTBW 2,5...-ST(-5,08)

- Conductor entry on the rippled side of the connector

Notes:

In accordance with DIN EN 61984, COMBICON plug-in connectors have no switching power. During designated use, they must not be plugged in or disconnected when carrying voltage or under load.

COMBICON select

You will find the possible plug-in connector combinations in COMBICON select at: www.phoenixcontact.net/products or starting on page 259.

The maximum torque for the screw flange is 0.3 Nm.

¹⁾ Please observe the derating curves. Derating curves of further combination options on request.



Conductor entry facing coding side



Dimensional drawing

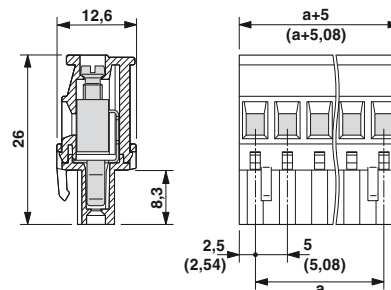

Note derating curves

Derating curves, determined as per
DIN EN 61984 (VDE 0627):2002-09
Representation based on DIN EN 60512-5-2:2003-01
Connected conductor cross section = 2.5 mm²
Reduction factor = 0.8
Number of positions = see diagram

Accessories

For all types	Type	Page
	Coding profile CP-MSTB Order No. 1734634	38
	Marker cards SK 5/3,8 or SK 5,08/3,8	798
	Screwdriver SZS 0,6 x 3,5 Order No. 1205053	
	Insertion bridge EBP...-5	829

Technical data

Technical data in accordance to IEC / DIN VDE	
Rated current / conductor cross section	[A] / [mm ²]
Rated insulation voltage for pollution degree 2	[V]
Pitch	[mm]
Connection capacity	
Solid / stranded	[mm ²] / [mm ²] / AWG
Stranded with ferrules without plastic sleeve	[mm ²]
Stranded with ferrules with plastic sleeve	[mm ²]
Multi-conductor connection capacity (two conductors with the same cross section)	
Solid / stranded	[mm ²]
Stranded with ferrules without plastic sleeve	[mm ²]
Stranded with TWIN ferrule with plastic sleeve	[mm ²]
Insulation coordination	
Surge voltage category / pollution degree	III / 3 III / 2 II / 2
Rated insulation voltage	[V]
Rated surge voltage	[kV]
Approval data (UL/CUL)	Use Group
Nominal voltage	[V]
Nominal current	[A]
Connection capacity AWG	AWG
Approval data (CSA)	Use Group
Nominal voltage	[V]
Nominal current	[A]
Connection capacity AWG	AWG
General data	
Stripping length	[mm]
Screw thread	M3
Tightening torque	[Nm]
Type of insulation material / insulation material group	PA / I
Inflammability class according to UL 94	V0

		12 ¹⁾ / 2.5
		320
		5 / 5.08
		0.2 - 2.5 / 0.2 - 2.5 / 24 - 12
		0.25 - 2.5
		0.25 - 2.5
		0.2 - 1 / 0.2 - 1.5
		0.25 - 1
		0.5 - 1.5
	III / 3	III / 2
	250	320
	4	4
	B	C
	300	-
	15	-
	30 - 12	-
	B	C
	300	-
	10	-
	28 - 12	-
		7
		M3
		0.5 - 0.6
		PA / I
		V0

Ordering data

No. of pos.	Dim. a [mm]	Type	Order No.	Pcs. / Pkt.
5.0 mm pitch, color: green				
2	5.00	MVSTBR 2,5/ 2-ST	1792016	50
3	10.00	MVSTBR 2,5/ 3-ST	1792029	50
4	15.00	MVSTBR 2,5/ 4-ST	1792032	50
5	20.00	MVSTBR 2,5/ 5-ST	1792045	50
6	25.00	MVSTBR 2,5/ 6-ST	1792058	50
7	30.00	MVSTBR 2,5/ 7-ST	1792061	50
8	35.00	MVSTBR 2,5/ 8-ST	1792074	50
9	40.00	MVSTBR 2,5/ 9-ST	1792087	50
10	45.00	MVSTBR 2,5/10-ST	1792090	50
11	50.00	MVSTBR 2,5/11-ST	1792100	50
12	55.00	MVSTBR 2,5/12-ST	1792113	50
13	60.00	MVSTBR 2,5/13-ST	1792126	50
14	65.00	MVSTBR 2,5/14-ST	1792139	50
15	70.00	MVSTBR 2,5/15-ST	1792142	50
16	75.00	MVSTBR 2,5/16-ST	1792155	50
5.08 mm pitch, color: green				
2	5.08	MVSTBR 2,5/ 2-ST-5,08	1792249	50
3	10.16	MVSTBR 2,5/ 3-ST-5,08	1792252	50
4	15.24	MVSTBR 2,5/ 4-ST-5,08	1792265	50
5	20.32	MVSTBR 2,5/ 5-ST-5,08	1792278	50
6	25.40	MVSTBR 2,5/ 6-ST-5,08	1792281	50
7	30.48	MVSTBR 2,5/ 7-ST-5,08	1792294	50
8	35.56	MVSTBR 2,5/ 8-ST-5,08	1792304	50
9	40.64	MVSTBR 2,5/ 9-ST-5,08	1792317	50
10	45.72	MVSTBR 2,5/10-ST-5,08	1792320	50
11	50.80	MVSTBR 2,5/11-ST-5,08	1792333	50
12	55.88	MVSTBR 2,5/12-ST-5,08	1792346	50
13	60.96	MVSTBR 2,5/13-ST-5,08	1792359	50
14	66.04	MVSTBR 2,5/14-ST-5,08	1792362	50
15	71.12	MVSTBR 2,5/15-ST-5,08	1792375	50
16	76.20	MVSTBR 2,5/16-ST-5,08	1792388	50

Classic plug-in connector with 5.0 to 7.62 mm pitch

CLASSIC COMBICON plug-in connectors, pitches 5.0 or 5.08 mm

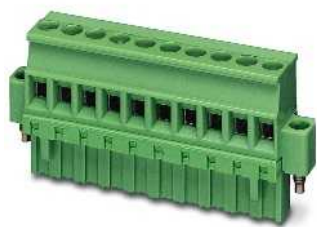

Conductor entry facing coding side, with screw flange



Conductor entry facing rippled side



Conductor entry facing rippled side, with screw flange



Dimensional drawing

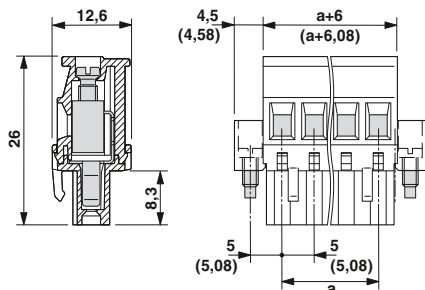

Dimensional drawing

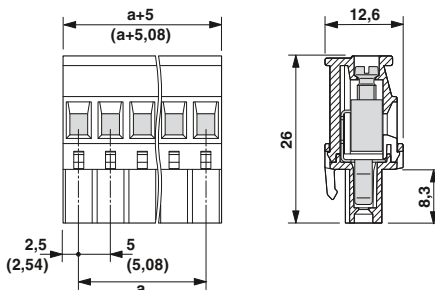

Dimensional drawing

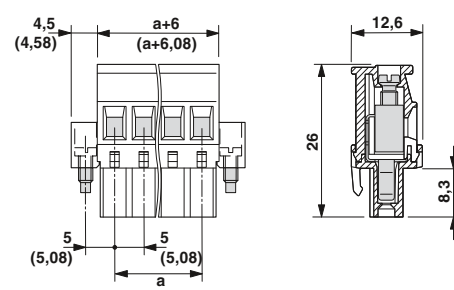

Representative derating curves of the above-mentioned plugs

Type: MVSTBR 2,5/...-ST(5,08) with MSTBA 2,5/...-G(-5,08)

Type: MVSTBW 2,5/...-ST-5,08 with (U)MSTBVK 2,5/...-G-5,08

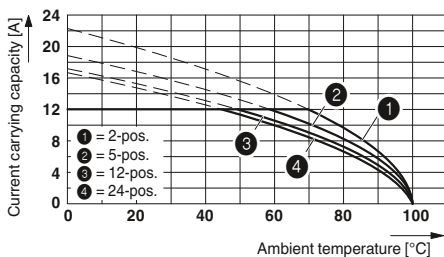
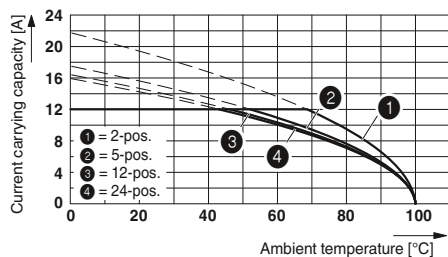

Ordering data

Type	Order No.	Pcs. / Pkt.
5.0 mm pitch, color: green		
MVSTBR 2,5/ 2-STF	1835478	50
MVSTBR 2,5/ 3-STF	1835481	50
MVSTBR 2,5/ 4-STF	1835494	50
MVSTBR 2,5/ 5-STF	1835504	50
MVSTBR 2,5/ 6-STF	1835517	50
MVSTBR 2,5/ 7-STF	1835520	50
MVSTBR 2,5/ 8-STF	1835533	50
MVSTBR 2,5/ 9-STF	1835546	50
MVSTBR 2,5/10-STF	1835559	50
MVSTBR 2,5/11-STF	1835562	50
MVSTBR 2,5/12-STF	1835575	50
MVSTBR 2,5/13-STF	1835588	50
MVSTBR 2,5/14-STF	1835591	50
MVSTBR 2,5/15-STF	1835601	50
MVSTBR 2,5/16-STF	1835614	50
5.08 mm pitch, color: green		
MVSTBR 2,5/ 2-STF-5,08	1835096	50
MVSTBR 2,5/ 3-STF-5,08	1835106	50
MVSTBR 2,5/ 4-STF-5,08	1835119	50
MVSTBR 2,5/ 5-STF-5,08	1835122	50
MVSTBR 2,5/ 6-STF-5,08	1835135	50
MVSTBR 2,5/ 7-STF-5,08	1835148	50
MVSTBR 2,5/ 8-STF-5,08	1835151	50
MVSTBR 2,5/ 9-STF-5,08	1835164	50
MVSTBR 2,5/10-STF-5,08	1835177	50
MVSTBR 2,5/11-STF-5,08	1835180	50
MVSTBR 2,5/12-STF-5,08	1835193	50
MVSTBR 2,5/13-STF-5,08	1835203	50
MVSTBR 2,5/14-STF-5,08	1835216	50
MVSTBR 2,5/15-STF-5,08	1835229	50
MVSTBR 2,5/16-STF-5,08	1835232	50

Ordering data

Type	Order No.	Pcs. / Pkt.
5.0 mm pitch, color: green		
MVSTBW 2,5/ 2-ST	1792524	50
MVSTBW 2,5/ 3-ST	1792537	50
MVSTBW 2,5/ 4-ST	1792540	50
MVSTBW 2,5/ 5-ST	1792553	50
MVSTBW 2,5/ 6-ST	1792566	50
MVSTBW 2,5/ 7-ST	1792579	50
MVSTBW 2,5/ 8-ST	1792582	50
MVSTBW 2,5/ 9-ST	1792595	50
MVSTBW 2,5/10-ST	1792605	50
MVSTBW 2,5/11-ST	1792618	50
MVSTBW 2,5/12-ST	1792621	50
MVSTBW 2,5/13-ST	1792634	50
MVSTBW 2,5/14-ST	1792647	50
MVSTBW 2,5/15-ST	1792650	50
MVSTBW 2,5/16-ST	1792663	50
5.08 mm pitch, color: green		
MVSTBW 2,5/ 2-ST-5,08	1792757	50
MVSTBW 2,5/ 3-ST-5,08	1792760	50
MVSTBW 2,5/ 4-ST-5,08	1792773	50
MVSTBW 2,5/ 5-ST-5,08	1792786	50
MVSTBW 2,5/ 6-ST-5,08	1792799	50
MVSTBW 2,5/ 7-ST-5,08	1792809	50
MVSTBW 2,5/ 8-ST-5,08	1792812	50
MVSTBW 2,5/ 9-ST-5,08	1792825	50
MVSTBW 2,5/10-ST-5,08	1792838	50
MVSTBW 2,5/11-ST-5,08	1792841	50
MVSTBW 2,5/12-ST-5,08	1792854	50
MVSTBW 2,5/13-ST-5,08	1792867	50
MVSTBW 2,5/14-ST-5,08	1792870	50
MVSTBW 2,5/15-ST-5,08	1792883	50
MVSTBW 2,5/16-ST-5,08	1792896	50

Ordering data

Type	Order No.	Pcs. / Pkt.
5.0 mm pitch, color: green		
MVSTBW 2,5/ 2-STF	1835287	50
MVSTBW 2,5/ 3-STF	1835290	50
MVSTBW 2,5/ 4-STF	1835300	50
MVSTBW 2,5/ 5-STF	1835313	50
MVSTBW 2,5/ 6-STF	1835326	50
MVSTBW 2,5/ 7-STF	1835339	50
MVSTBW 2,5/ 8-STF	1835342	50
MVSTBW 2,5/ 9-STF	1835355	50
MVSTBW 2,5/10-STF	1835368	50
MVSTBW 2,5/11-STF	1835371	50
MVSTBW 2,5/12-STF	1835384	50
MVSTBW 2,5/13-STF	1835397	50
MVSTBW 2,5/14-STF	1835407	50
MVSTBW 2,5/15-STF	1835410	50
MVSTBW 2,5/16-STF	1835423	50
5.08 mm pitch, color: green		
MVSTBW 2,5/ 2-STF-5,08	1834903	50
MVSTBW 2,5/ 3-STF-5,08	1834916	50
MVSTBW 2,5/ 4-STF-5,08	1834929	50
MVSTBW 2,5/ 5-STF-5,08	1834932	50
MVSTBW 2,5/ 6-STF-5,08	1834945	50
MVSTBW 2,5/ 7-STF-5,08	1834958	50
MVSTBW 2,5/ 8-STF-5,08	1834961	50
MVSTBW 2,5/ 9-STF-5,08	1834974	50
MVSTBW 2,5/10-STF-5,08	1834987	50
MVSTBW 2,5/11-STF-5,08	1834990	50
MVSTBW 2,5/12-STF-5,08	1835009	50
MVSTBW 2,5/13-STF-5,08	1835012	50
MVSTBW 2,5/14-STF-5,08	1835025	50
MVSTBW 2,5/15-STF-5,08	1835038	50
MVSTBW 2,5/16-STF-5,08	1835041	50

Classic plug-in connector with 5.0 to 7.62 mm pitch

CLASSIC COMBICON plug-in connectors, pitches 5.0 or 5.08 mm

Plugs with a screw connection

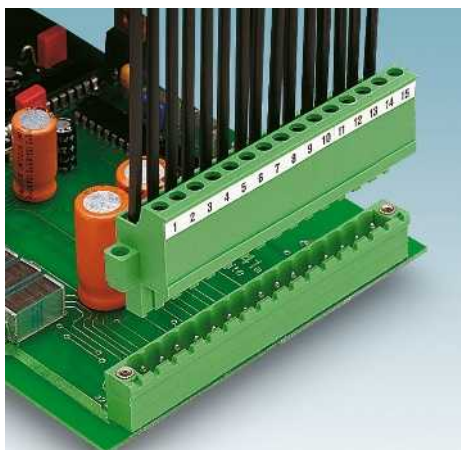

- Versions with and without a screw flange
- Higher numbers of positions up to 24-pos. can be found at: www.phoenixcontact.net/products

FRONT-MSTB 2,5/...-ST(F)...

- With front screw connection
- Plug-in direction parallel to the conductor axis

SMSTB 2,5/...

- Angled connection direction to the conductor axis

Notes:

In accordance with DIN EN 61984, COMBICON plug-in connectors have no switching power. During designated use, they must not be plugged in or disconnected when carrying voltage or under load.

COMBICON select

You will find the possible plug-in connector combinations in COMBICON select at: www.phoenixcontact.net/products or starting on page 259.

The maximum torque for the screw flange is 0.3 Nm.

1) Please observe the derating curves. Derating curves of further combination options on request.

2) Diverging data with FRONT-MSTB 2,5/... = stripping length 10 mm



Plug-in direction 45° to the conductor axis



Dimensional drawing

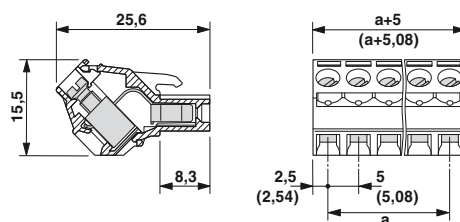

Note derating curves

Derating curves, determined as per DIN EN 61984 (VDE 0627):2002-09
Representation based on DIN EN 60512-5-2:2003-01
Connected conductor cross section = 2.5 mm²
Reduction factor = 0.8
Number of positions = see diagram

Accessories

For all types	Type	Page
	Coding profile CP-MSTB Order No. 1734634	38
	Marker cards SK 5/3,8 or SK 5,08/3,8	798
	Screwdriver SZS 0,6 x 3,5 Order No. 1205053	
Only for FRONT-MSTB 2,5/...-ST(STF)		
	Pullout aid for connectors arranged one after the other, width: 30 mm FRONT-MSTB-EW Order No. 1763058	

Technical data

Technical data in accordance to IEC / DIN VDE			
Rated current / conductor cross section	[A] / [mm ²]	12 ¹⁾ / 2.5	
Rated insulation voltage for pollution degree 2	[V]	320	
Pitch	[mm]	5 / 5.08	
Connection capacity			
Solid / stranded	[mm ²] / [mm ²] / AWG	0.2 - 2.5 / 0.2 - 2.5 / 24 - 12	
Stranded with ferrules without plastic sleeve	[mm ²]	0.25 - 2.5	
Stranded with ferrules with plastic sleeve	[mm ²]	0.25 - 2.5	
Multi-conductor connection capacity (two conductors with the same cross section)			
Solid / stranded	[mm ²]	0.2 - 1 / 0.2 - 1.5	
Stranded with ferrules without plastic sleeve	[mm ²]	0.25 - 1	
Stranded with TWIN ferrule with plastic sleeve	[mm ²]	0.5 - 1.5	
Insulation coordination			
Surge voltage category / pollution degree		III / 3	III / 2
Rated insulation voltage	[V]	250	320
Rated surge voltage	[kV]	4	4
Approval data (UL/CUL)	Use Group	B	C
Nominal voltage	[V]	300	300
Nominal current	[A]	15	10
Connection capacity AWG	AWG	30 - 12	30 - 12
Approval data (CSA)	Use Group	B	C
Nominal voltage	[V]	300	300
Nominal current	[A]	10	10
Connection capacity AWG	AWG	28 - 12	28 - 12
General data			
Stripping length	[mm]	7 ²⁾	
Screw thread		M3	
Tightening torque	[Nm]	0.5 - 0.6	
Type of insulation material / insulation material group		PA / I	
Inflammability class according to UL 94		V0	

Ordering data

No. of pos.	Dim. a [mm]	Type	Order No.	Pcs. / Pkt.
5.0 mm pitch, color: green				
2	5.00	SMSTB 2,5/ 2-ST	1768765	50
3	10.00	SMSTB 2,5/ 3-ST	1768778	50
4	15.00	SMSTB 2,5/ 4-ST	1768781	50
5	20.00	SMSTB 2,5/ 5-ST	1768794	50
6	25.00	SMSTB 2,5/ 6-ST	1768804	50
7	30.00	SMSTB 2,5/ 7-ST	1768817	50
8	35.00	SMSTB 2,5/ 8-ST	1768848	50
9	40.00	SMSTB 2,5/ 9-ST	1768820	50
10	45.00	SMSTB 2,5/10-ST	1768833	50
11	50.00	SMSTB 2,5/11-ST	1768846	50
12	55.00	SMSTB 2,5/12-ST	1768859	50
13	60.00	SMSTB 2,5/13-ST	1768862	50
14	65.00	SMSTB 2,5/14-ST	1768875	50
15	70.00	SMSTB 2,5/15-ST	1768888	50
16	75.00	SMSTB 2,5/16-ST	1768891	50
5.08 mm pitch, color: green				
2	5.08	SMSTB 2,5/ 2-ST-5,08	1826283	50
3	10.16	SMSTB 2,5/ 3-ST-5,08	1826296	50
4	15.24	SMSTB 2,5/ 4-ST-5,08	1826306	50
5	20.32	SMSTB 2,5/ 5-ST-5,08	1826319	50
6	25.40	SMSTB 2,5/ 6-ST-5,08	1826322	50
7	30.48	SMSTB 2,5/ 7-ST-5,08	1826335	50
8	35.56	SMSTB 2,5/ 8-ST-5,08	1826348	50
9	40.64	SMSTB 2,5/ 9-ST-5,08	1826351	50
10	45.72	SMSTB 2,5/10-ST-5,08	1826364	50
11	50.80	SMSTB 2,5/11-ST-5,08	1826377	50
12	55.88	SMSTB 2,5/12-ST-5,08	1826380	50
13	60.96	SMSTB 2,5/13-ST-5,08	1826393	50
14	66.04	SMSTB 2,5/14-ST-5,08	1826403	50
15	71.12	SMSTB 2,5/15-ST-5,08	1826416	50
16	76.20	SMSTB 2,5/16-ST-5,08	1826429	50

Classic plug-in connector with 5.0 to 7.62 mm pitch

CLASSIC COMBICON plug-in connectors, pitches 5.0 or 5.08 mm



Plug-in direction 45° to the conductor axis, with screw flange



With front screw connection, plug-in direction parallel to the conductor axis



With front screw connection and screw flange, plug-in direction parallel to the conductor axis



Dimensional drawing

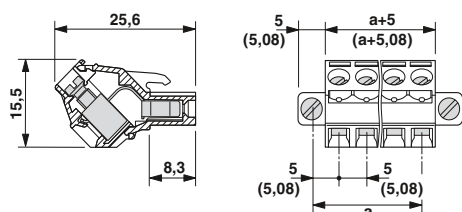

Dimensional drawing

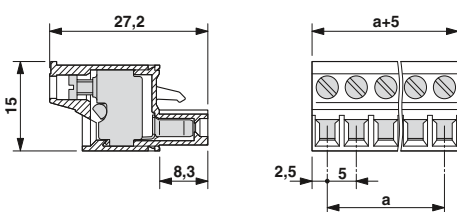

Dimensional drawing

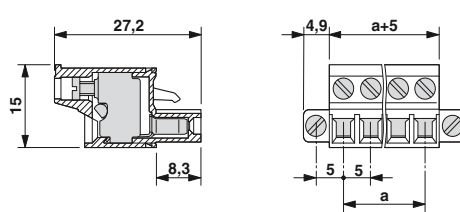

Representative derating curves of the above-mentioned plugs

Type: SMSTB 2,5/...-ST with MSTBA 2,5/...-G

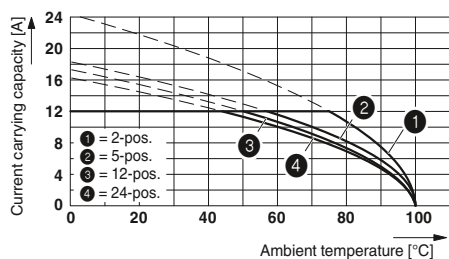

Type: SMSTB 2,5/...-ST with SMSTBA 2,5/...-G

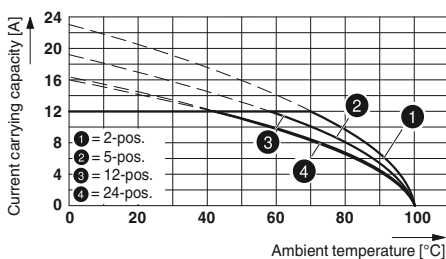

Type: FRONT-MSTB 2,5/...-ST(-5,08) with MSTBA 2,5/...-G(-5,08)

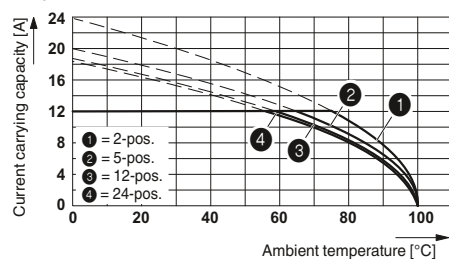

Ordering data

Type	Order No.	Pcs. / Pkt.
5.0 mm pitch, color: green		
SMSTB 2,5/ 2-STF	1970870	50
SMSTB 2,5/ 3-STF	1970883	50
SMSTB 2,5/ 4-STF	1970896	50
SMSTB 2,5/ 5-STF	1970906	50
SMSTB 2,5/ 6-STF	1970919	50
SMSTB 2,5/ 7-STF	1970922	50
SMSTB 2,5/ 8-STF	1970935	50
SMSTB 2,5/ 9-STF	1970948	50
SMSTB 2,5/10-STF	1970951	50
SMSTB 2,5/11-STF	1970964	50
SMSTB 2,5/12-STF	1970977	50
SMSTB 2,5/13-STF	1970980	50
SMSTB 2,5/14-STF	1970993	50
SMSTB 2,5/15-STF	1971002	50
SMSTB 2,5/16-STF	1971015	50
5.08 mm pitch, color: green		
SMSTB 2,5/ 2-STF-5,08	1971060	50
SMSTB 2,5/ 3-STF-5,08	1971073	50
SMSTB 2,5/ 4-STF-5,08	1971086	50
SMSTB 2,5/ 5-STF-5,08	1971099	50
SMSTB 2,5/ 6-STF-5,08	1971109	50
SMSTB 2,5/ 7-STF-5,08	1971112	50
SMSTB 2,5/ 8-STF-5,08	1971125	50
SMSTB 2,5/ 9-STF-5,08	1971138	50
SMSTB 2,5/10-STF-5,08	1971141	50
SMSTB 2,5/11-STF-5,08	1971154	50
SMSTB 2,5/12-STF-5,08	1971167	50
SMSTB 2,5/13-STF-5,08	1971170	50
SMSTB 2,5/14-STF-5,08	1971183	50
SMSTB 2,5/15-STF-5,08	1971196	50
SMSTB 2,5/16-STF-5,08	1971206	50

Ordering data

Type	Order No.	Pcs. / Pkt.
5.0 mm pitch, color: green		
FRONT-MSTB 2,5/ 2-ST	1779411	50
FRONT-MSTB 2,5/ 3-ST	1779424	50
FRONT-MSTB 2,5/ 4-ST	1779437	50
FRONT-MSTB 2,5/ 5-ST	1779440	50
FRONT-MSTB 2,5/ 6-ST	1779453	50
FRONT-MSTB 2,5/ 7-ST	1779466	50
FRONT-MSTB 2,5/ 8-ST	1779479	50
FRONT-MSTB 2,5/ 9-ST	1779482	50
FRONT-MSTB 2,5/10-ST	1779495	50
FRONT-MSTB 2,5/11-ST	1779505	50
FRONT-MSTB 2,5/12-ST	1779518	50
FRONT-MSTB 2,5/13-ST	1779521	50
FRONT-MSTB 2,5/14-ST	1779534	50
FRONT-MSTB 2,5/15-ST	1779547	50
FRONT-MSTB 2,5/16-ST	1779550	50
5.08 mm pitch, color: green		
FRONT-MSTB 2,5/ 2-ST-5,08	1777280	50
FRONT-MSTB 2,5/ 3-ST-5,08	1777293	50
FRONT-MSTB 2,5/ 4-ST-5,08	1777303	50
FRONT-MSTB 2,5/ 5-ST-5,08	1777316	50
FRONT-MSTB 2,5/ 6-ST-5,08	1777329	50
FRONT-MSTB 2,5/ 7-ST-5,08	1777332	50
FRONT-MSTB 2,5/ 8-ST-5,08	1777345	50
FRONT-MSTB 2,5/ 9-ST-5,08	1777358	50
FRONT-MSTB 2,5/10-ST-5,08	1777361	50
FRONT-MSTB 2,5/11-ST-5,08	1777374	50
FRONT-MSTB 2,5/12-ST-5,08	1777387	50
FRONT-MSTB 2,5/13-ST-5,08	1777390	50
FRONT-MSTB 2,5/14-ST-5,08	1777400	50
FRONT-MSTB 2,5/15-ST-5,08	1777413	50
FRONT-MSTB 2,5/16-ST-5,08	1777426	50

Ordering data

Type	Order No.	Pcs. / Pkt.
5.0 mm pitch, color: green		
FRONT-MSTB 2,5/ 2-STF	1779644	50
FRONT-MSTB 2,5/ 3-STF	1779657	50
FRONT-MSTB 2,5/ 4-STF	1779660	50
FRONT-MSTB 2,5/ 5-STF	1779673	50
FRONT-MSTB 2,5/ 6-STF	1779686	50
FRONT-MSTB 2,5/ 7-STF	1779699	50
FRONT-MSTB 2,5/ 8-STF	1779709	50
FRONT-MSTB 2,5/ 9-STF	1779712	50
FRONT-MSTB 2,5/10-STF	1779725	50
FRONT-MSTB 2,5/11-STF	1779738	50
FRONT-MSTB 2,5/12-STF	1779741	50
FRONT-MSTB 2,5/13-STF	1779754	50
FRONT-MSTB 2,5/14-STF	1779767	50
FRONT-MSTB 2,5/15-STF	1779770	50
FRONT-MSTB 2,5/16-STF	1779783	50
5.08 mm pitch, color: green		
FRONT-MSTB 2,5/ 2-STF-5,08	1777808	50
FRONT-MSTB 2,5/ 3-STF-5,08	1777811	50
FRONT-MSTB 2,5/ 4-STF-5,08	1777824	50
FRONT-MSTB 2,5/ 5-STF-5,08	1777837	50
FRONT-MSTB 2,5/ 6-STF-5,08	1777840	50
FRONT-MSTB 2,5/ 7-STF-5,08	1777853	50
FRONT-MSTB 2,5/ 8-STF-5,08	1777798	50
FRONT-MSTB 2,5/ 9-STF-5,08	1777866	50
FRONT-MSTB 2,5/10-STF-5,08	1777879	50
FRONT-MSTB 2,5/11-STF-5,08	1777882	50
FRONT-MSTB 2,5/12-STF-5,08	1777895	50
FRONT-MSTB 2,5/13-STF-5,08	1777905	50
FRONT-MSTB 2,5/14-STF-5,08	1777918	50
FRONT-MSTB 2,5/15-STF-5,08	1777921	50
FRONT-MSTB 2,5/16-STF-5,08	1777934	50

Classic plug-in connector with 5.0 to 7.62 mm pitch

CLASSIC COMBICON plug-in connectors, pitches 5.0 or 5.08 mm

TWIN screw plugs with connection cross section of up to 2.5 mm²

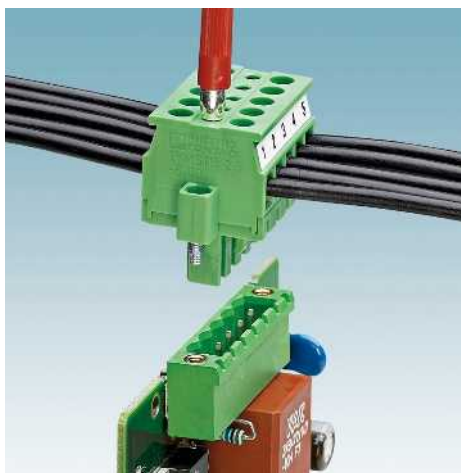

- Convenient double conductor connection for potential / signal distribution directly in the device
- Retaining the function of the following devices when unplugging individual connectors within a device series
- Versions with and without a screw flange
- 2.3 mm Ø test connection

TMSTBP 2,5....:

- For the DeviceNet-compliant version with gold-plated contact system, visit www.phoenixcontact.com

TVMSTB 2,5....:

- Compact TWIN plug
- Conductor exits perpendicular to the plug-in direction

Notes:

In accordance with DIN EN 61984, COMBICON plug-in connectors have no switching power. During designated use, they must not be plugged in or disconnected when carrying voltage or under load.

COMBICON select

You will find the possible plug-in connector combinations in COMBICON select at: www.phoenixcontact.net/products or starting on page 259.

The maximum torque for the screw flange is 0.3 Nm.

¹⁾ Please observe the derating curves and laboratory data sheets. Derating curves of further combination options on request.



With double screw connection and test connection, plug-in direction parallel to the conductor axis



Accessories

For all types	Type	Page
	Coding profile CP-MSTB Order No. 1734634	38
	Marker cards SK 5,08/3,8	798
	Test plug MPS	831
	Screwdriver SZS 0,6 x 3,5 Order No. 1205053	

Dimensional drawing

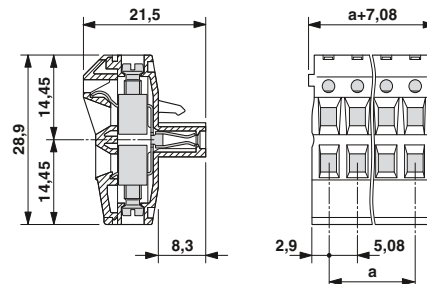

Note derating curves

Derating curves, determined as per
DIN EN 61984 (VDE 0627):2002-09
Representation based on DIN EN 60512-5-2:2003-01
Connected conductor cross section = 2.5 mm²
Reduction factor = 0.8
Number of positions = see diagram

Technical data

Technical data in accordance to IEC / DIN VDE

Rated current / conductor cross section [A] / [mm²]

Rated insulation voltage for pollution degree 2 [V]

Pitch [mm]

Connection capacity

Solid / stranded [mm²] / [mm²] / AWG

Stranded with ferrules without plastic sleeve [mm²]

Stranded with ferrules with plastic sleeve [mm²]

Multi-conductor connection capacity (two conductors with the same cross section)

Solid / stranded [mm²]

Stranded with ferrules without plastic sleeve [mm²]

Stranded with TWIN ferrule with plastic sleeve [mm²]

Insulation coordination

Surge voltage category / pollution degree

Rated insulation voltage [V]

Rated surge voltage [kV]

Approval data (UL/CUL) Use Group

Nominal voltage [V]

Nominal current [A]

Connection capacity AWG AWG

Approval data (CSA) Use Group

Nominal voltage [V]

Nominal current [A]

Connection capacity AWG AWG

General data

Stripping length [mm]

Screw thread

Tightening torque [Nm]

Type of insulation material / insulation material group

Inflammability class according to UL 94

		12 / 2.5
		320
		5.08
		0.2 - 2.5 / 0.2 - 2.5 / 24 - 12
		0.25 - 2.5
		0.25 - 2.5
		0.2 - 1 / 0.2 - 1.5
		0.25 - 1
		0.5 - 1.5
	III / 3	III / 2
	II / 2	
	250	320
	630	
	4	4
	4	4
	B	C
	D	
	300	-
	300	300
	15	-
	15	15
	30 - 12	-
	30 - 12	
	B	C
	D	
	300	-
	300	300
	10	-
	10	10
	28 - 12	-
	28 - 12	
		7
		M3
		0.5 - 0.6
		PA / I
		V0

Ordering data

No. of pos.

Dim. a [mm]

2 5.08

3 10.16

4 15.24

5 20.32

6 25.40

7 30.48

8 35.56

9 40.64

10 45.72

Type
5.08 mm pitch, color: green

Order No.

Pcs. / Pkt.

TMSTBP 2,5/ 2-ST-5,08

1853010

50

TMSTBP 2,5/ 3-ST-5,08

1853023

50

TMSTBP 2,5/ 4-ST-5,08

1853036

50

TMSTBP 2,5/ 5-ST-5,08

1853049

50

TMSTBP 2,5/ 6-ST-5,08

1853052

50

TMSTBP 2,5/ 7-ST-5,08

1853065

50

TMSTBP 2,5/ 8-ST-5,08

1853078

50

TMSTBP 2,5/ 9-ST-5,08

1853081

50

TMSTBP 2,5/10-ST-5,08

1853094

50

Classic plug-in connector with 5.0 to 7.62 mm pitch

CLASSIC COMBICON plug-in connectors, pitches 5.0 or 5.08 mm



With double screw connection
Test connection and screw flange, plug-in direction parallel to the conductor axis



With double screw connection and test connection, plug-in direction vertical to the conductor axis



With double screw connection
Screw flange and test connection, plug-in direction vertical to the conductor axis



Dimensional drawing

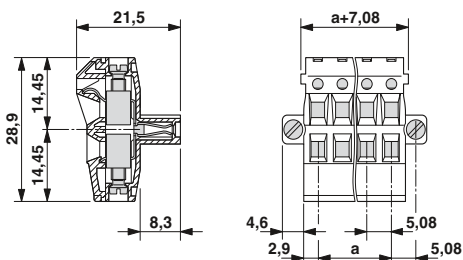

Dimensional drawing

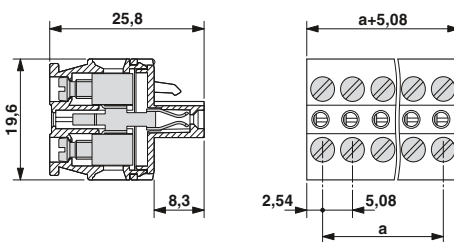

Dimensional drawing

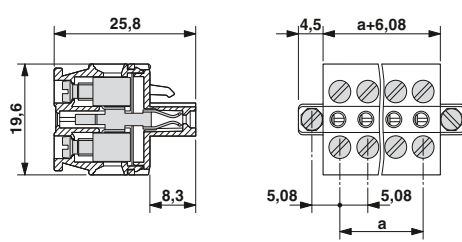

Representative derating curves of the above-mentioned plugs

Type: TMSTBP 2,5/...-STF-5,08 with MSTBA 2,5/...-GF-5,08

Type: TVMSTB 2,5/...-ST-5,08 with MSTBVA 2,5/...-G-5,08

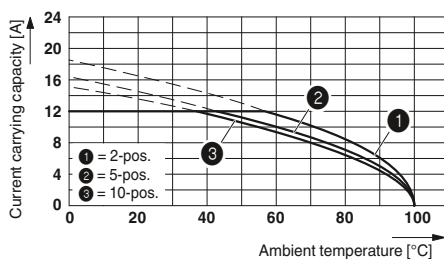
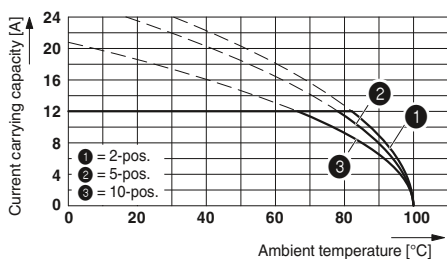

Ordering data

Type	Order No.	Pcs. / Pkt.
5.08 mm pitch, color: green		
TMSTBP 2,5/ 2-STF-5,08	1853104	50
TMSTBP 2,5/ 3-STF-5,08	1853117	50
TMSTBP 2,5/ 4-STF-5,08	1853120	50
TMSTBP 2,5/ 5-STF-5,08	1853133	50
TMSTBP 2,5/ 6-STF-5,08	1853146	50
TMSTBP 2,5/ 7-STF-5,08	1853159	50
TMSTBP 2,5/ 8-STF-5,08	1853162	50
TMSTBP 2,5/ 9-STF-5,08	1853175	50
TMSTBP 2,5/10-STF-5,08	1853188	50

Ordering data

Type	Order No.	Pcs. / Pkt.
5.08 mm pitch, color: green		
TVMSTB 2,5/ 2-ST-5,08	1719008	50
TVMSTB 2,5/ 3-ST-5,08	1719011	50
TVMSTB 2,5/ 4-ST-5,08	1719024	50
TVMSTB 2,5/ 5-ST-5,08	1719037	50
TVMSTB 2,5/ 6-ST-5,08	1719040	50
TVMSTB 2,5/ 7-ST-5,08	1719053	50
TVMSTB 2,5/ 8-ST-5,08	1719066	50
TVMSTB 2,5/ 9-ST-5,08	1719079	50
TVMSTB 2,5/10-ST-5,08	1719082	50

Ordering data

Type	Order No.	Pcs. / Pkt.
5.08 mm pitch, color: green		
TVMSTB 2,5/ 2-STF-5,08	1719095	50
TVMSTB 2,5/ 3-STF-5,08	1719105	50
TVMSTB 2,5/ 4-STF-5,08	1719118	50
TVMSTB 2,5/ 5-STF-5,08	1719121	50
TVMSTB 2,5/ 6-STF-5,08	1719134	50
TVMSTB 2,5/ 7-STF-5,08	1719147	50
TVMSTB 2,5/ 8-STF-5,08	1719150	50
TVMSTB 2,5/ 9-STF-5,08	1719163	50
TVMSTB 2,5/10-STF-5,08	1719176	50

Classic plug-in connector with 5.0 to 7.62 mm pitch

CLASSIC COMBICON plug-in connectors, pitches 5.0 or 5.08 mm

Inverted plugs with a screw connection

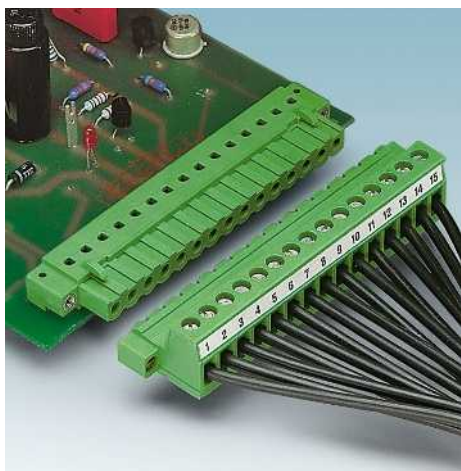

- Connectors with inverted contact system (pin contact)
- Can be combined with inverted headers and connectors for shock-proof applications
- Versions with and without a screw flange
- Higher numbers of positions up to 24-pos. can be found at: www.phoenixcontact.net/products
- The IC 2,5/...-STGF-5,08 becomes a panel feed-through terminal block in combination with the IC-DFR assembly frame, see page 350

Notes:

In accordance with DIN EN 61984, COMBICON plug-in connectors have no switching power. During designated use, they must not be plugged in or disconnected when carrying voltage or under load.

The inverted contact system is explained on page 34.

COMBICON select

You will find the possible plug-in connector combinations in COMBICON select at: www.phoenixcontact.net/products or starting on page 259.

The maximum torque for the screw flange is 0.3 Nm.

¹⁾ Please observe the derating curves. Derating curves of further combination options on request.

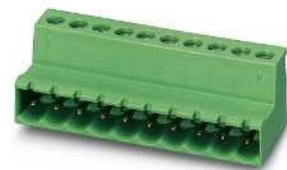

Inverted plugs with screw connection



Dimensional drawing

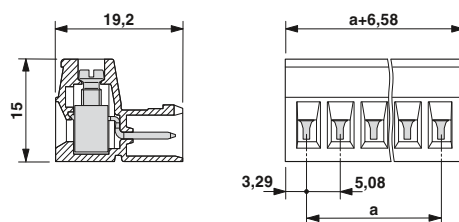

Note derating curves

Derating curves, determined as per DIN EN 61984 (VDE 0627):2002-09
Representation based on DIN EN 60512-5-2:2003-01
Connected conductor cross section = 2.5 mm²
Reduction factor = 0.8
Number of positions = see diagram

Accessories

For all types	Type	Page
	Marker cards SK 5,08/3,8	798
	Screwdriver SZS 0,6 x 3,5 Order No. 1205053	
	Coding section CR-MSTB Order No. 1734401	38
	Insertion bridge EBP...-5	829
Only for IC 2,5/...-STGF-5,08		
	Feed-through assembly frame IC-DFR...	350

Technical data

Technical data in accordance to IEC / DIN VDE	
Rated current / conductor cross section	[A] / [mm ²]
Rated insulation voltage for pollution degree 2	[V]
Pitch	[mm]
Connection capacity	
Solid / stranded	[mm ²] / [mm ²] / AWG
Stranded with ferrules without plastic sleeve	[mm ²]
Stranded with ferrules with plastic sleeve	[mm ²]
Multi-conductor connection capacity (two conductors with the same cross section)	
Solid / stranded	[mm ²]
Stranded with ferrules without plastic sleeve	[mm ²]
Stranded with TWIN ferrule with plastic sleeve	[mm ²]
Insulation coordination	
Surge voltage category / pollution degree	
Rated insulation voltage	[V]
Rated surge voltage	[kV]
Approval data (UL/CUL)	Use Group
Nominal voltage	[V]
Nominal current	[A]
Connection capacity AWG	AWG
Approval data (CSA)	Use Group
Nominal voltage	[V]
Nominal current	[A]
Connection capacity AWG	AWG
General data	
Stripping length	[mm]
Screw thread	
Tightening torque	[Nm]
Type of insulation material / insulation material group	
Inflammability class according to UL 94	

12 ¹⁾ / 2.5		
320		
5.08		
0.2 - 2.5 / 0.2 - 2.5 / 24 - 12		
0.25 - 2.5		
0.25 - 2.5		
0.2 - 1 / 0.2 - 1.5		
0.25 - 1		
0.5 - 1.5		
III / 3	III / 2	II / 2
250	320	630
4	4	4
B	C	D
250	-	300
12	-	10
30 - 12	-	30 - 12
B	C	D
300	-	300
10	-	10
28 - 12	-	28 - 12
7		
M3		
0.5 - 0.6		
PA / I		
V0		

Ordering data

No. of pos.	Dim. a [mm]	Type	Order No.	Pcs. / Pkt.
5.08 mm pitch, color: green				
2	5.08	IC 2,5/ 2-ST-5,08	1786174	50
3	10.16	IC 2,5/ 3-ST-5,08	1786187	50
4	15.24	IC 2,5/ 4-ST-5,08	1786190	50
5	20.32	IC 2,5/ 5-ST-5,08	1786200	50
6	25.40	IC 2,5/ 6-ST-5,08	1786213	50
7	30.48	IC 2,5/ 7-ST-5,08	1786226	50
8	35.56	IC 2,5/ 8-ST-5,08	1786239	50
9	40.64	IC 2,5/ 9-ST-5,08	1786242	50
10	45.72	IC 2,5/10-ST-5,08	1786255	50
11	50.80	IC 2,5/11-ST-5,08	1786268	50
12	55.88	IC 2,5/12-ST-5,08	1786271	50
13	60.96	IC 2,5/13-ST-5,08	1786284	50
14	66.04	IC 2,5/14-ST-5,08	1786297	50
15	71.12	IC 2,5/15-ST-5,08	1786307	50
16	76.20	IC 2,5/16-ST-5,08	1786310	50

Classic plug-in connector with 5.0 to 7.62 mm pitch

CLASSIC COMBICON plug-in connectors, pitches 5.0 or 5.08 mm



With screw flange, for screw connection using inverted headers



With threaded flange for screw connection using MSTB plugs with screw flange



Dimensional drawing

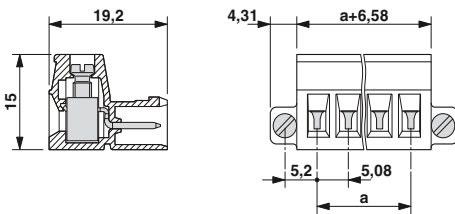

Dimensional drawing

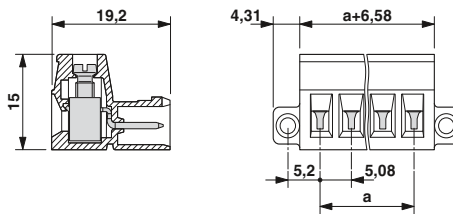

Representative derating curves of the above-mentioned plugs

Type: MSTB 2,5/...-ST-5,08 with IC 2,5/...-ST-5,08

Type: IC 2,5/...-ST-5,08 with IC 2,5/...-G-5,08

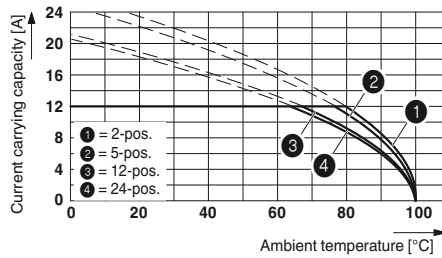
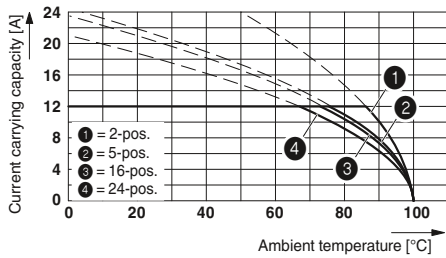

Ordering data

Type	Order No.	Pcs. / Pkt.
5.08 mm pitch, color: green		
IC 2,5/ 2-STF-5,08	1825310	50
IC 2,5/ 3-STF-5,08	1825323	50
IC 2,5/ 4-STF-5,08	1825336	50
IC 2,5/ 5-STF-5,08	1825349	50
IC 2,5/ 6-STF-5,08	1825352	50
IC 2,5/ 7-STF-5,08	1825365	50
IC 2,5/ 8-STF-5,08	1825378	50
IC 2,5/ 9-STF-5,08	1825381	50
IC 2,5/10-STF-5,08	1825394	50
IC 2,5/11-STF-5,08	1825404	50
IC 2,5/12-STF-5,08	1825417	50
IC 2,5/13-STF-5,08	1825420	50
IC 2,5/14-STF-5,08	1825433	50
IC 2,5/15-STF-5,08	1825446	50
IC 2,5/16-STF-5,08	1825459	50

Ordering data

Type	Order No.	Pcs. / Pkt.
5.08 mm pitch, color: green		
IC 2,5/ 2-STGF-5,08	1825501	50
IC 2,5/ 3-STGF-5,08	1825514	50
IC 2,5/ 4-STGF-5,08	1825527	50
IC 2,5/ 5-STGF-5,08	1825530	50
IC 2,5/ 6-STGF-5,08	1825543	50
IC 2,5/ 7-STGF-5,08	1825556	50
IC 2,5/ 8-STGF-5,08	1825569	50
IC 2,5/ 9-STGF-5,08	1825572	50
IC 2,5/10-STGF-5,08	1825585	50
IC 2,5/11-STGF-5,08	1825598	50
IC 2,5/12-STGF-5,08	1825608	50
IC 2,5/13-STGF-5,08	1825611	50
IC 2,5/14-STGF-5,08	1825624	50
IC 2,5/15-STGF-5,08	1825637	50
IC 2,5/16-STGF-5,08	1825640	50

Classic plug-in connector with 5.0 to 7.62 mm pitch

CLASSIC COMBICON plug-in connectors, pitches 5.0 or 5.08 mm

Plugs with push-in spring connection

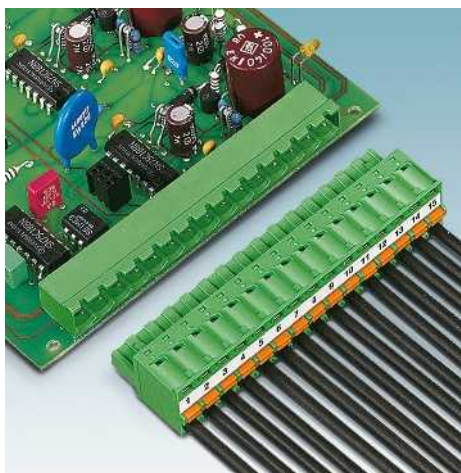

- Fast conductor connection, thanks to push-in spring connection
- Can be combined with the MSTB 2',5 range
- Contacting of solid or stranded conductors with a ferrule without operating the opening lever directly in the terminal point
- Two test connections to accommodate 2 mm Ø test pins or 2.3 mm Ø test plugs
- Versions with and without a screw flange, with a self-locking flange, and with Lock & Release levers
- Higher numbers of positions up to 24-pos. can be found at: www.phoenixcontact.net/products

Notes:

In accordance with DIN EN 61984, COMBICON plug-in connectors have no switching power. During designated use, they must not be plugged in or disconnected when carrying voltage or under load.

COMBICON select

You will find the possible plug-in connector combinations in COMBICON select at: www.phoenixcontact.net/products or starting on page 259.

The maximum torque for the screw flange is 0.3 Nm.

¹⁾ Please observe the derating curves. Derating curves of further combination options on request.



With a test connection



Dimensional drawing

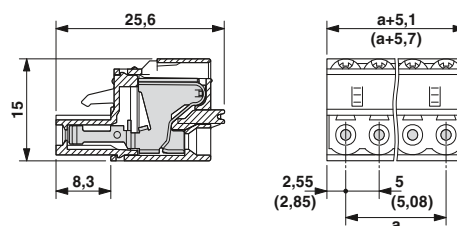

Note derating curves

Derating curves, determined as per DIN EN 61984 (VDE 0627):2002-09
Representation based on DIN EN 60512-5-2:2003-01
Connected conductor cross section = 2.5 mm²
Reduction factor = 0.8
Number of positions = see diagram

Accessories		
For all types	Type	Page
	Marker cards SK 5/3,8 or SK 5,08/3,8	798
	Coding profile CP-MSTB Order No. 1734634	38
	Strain relief STZ ...FKC-5,08	837
	Ferrules with and without plastic sleeve	834
	Crimping pliers for 0.25 to 6 mm ² CRIMPFOX 6 Order No. 1212034	
	Test plug MPS	831

Technical data

Technical data in accordance to IEC / DIN VDE	
Rated current / conductor cross section	[A] / [mm ²]
Rated insulation voltage for pollution degree 2	[V]
Pitch	[mm]
Connection capacity	
Solid / stranded	[mm ²] / [mm ²] / AWG
Stranded with ferrules without plastic sleeve	[mm ²]
Stranded with ferrules with plastic sleeve	[mm ²]
Multi-conductor connection capacity (two conductors with the same cross section)	
Solid / stranded	[mm ²]
Stranded with ferrules without plastic sleeve	[mm ²]
Stranded with TWIN ferrule with plastic sleeve	[mm ²]
Insulation coordination	
Surge voltage category / pollution degree	III / 3 III / 2 II / 2
Rated insulation voltage	[V]
Rated surge voltage	[kV]
Approval data (UL/CUL)	Use Group
Nominal voltage	[V]
Nominal current	[A]
Connection capacity AWG	AWG
Approval data (CSA)	Use Group
Nominal voltage	[V]
Nominal current	[A]
Connection capacity AWG	AWG
General data	
Stripping length	[mm]
Type of insulation material / insulation material group	PA / I
Inflammability class according to UL 94	V0

		12 ¹⁾ / 2.5
		320
		5 / 5.08
		0.2 - 2.5 / 0.2 - 2.5 / 24 - 12
		0.25 - 2.5
		- / -
		-
		0.5 - 1
		III / 3 III / 2 II / 2
		250 320 630
		4 4 4
		B C D
		300 - 300
		10 - 10
		26 - 12 - 26 - 12
		B C D
		300 - 300
		12 - 10
		24 - 12 - 24 - 12
		10
		PA / I
		V0

No. of pos.	Dim. a [mm]
2	5.00
3	10.00
4	15.00
5	20.00
6	25.00
7	30.00
8	35.00
9	40.00
10	45.00
11	50.00
12	55.00
13	60.00
14	65.00
15	70.00
16	75.00

Ordering data

Type	Order No.	Pcs. / Pkt.
5.0 mm pitch, color: green		
FKC 2,5/ 2-ST	1910351	50
FKC 2,5/ 3-ST	1910364	50
FKC 2,5/ 4-ST	1910377	50
FKC 2,5/ 5-ST	1910380	50
FKC 2,5/ 6-ST	1910393	50
FKC 2,5/ 7-ST	1910403	50
FKC 2,5/ 8-ST	1910416	50
FKC 2,5/ 9-ST	1910429	50
FKC 2,5/10-ST	1910432	50
FKC 2,5/11-ST	1910445	50
FKC 2,5/12-ST	1910458	50
FKC 2,5/13-ST	1910461	50
FKC 2,5/14-ST	1910474	50
FKC 2,5/15-ST	1910487	50
FKC 2,5/16-ST	1910490	50
5.08 mm pitch, color: green		
FKC 2,5/ 2-ST-5,08	1873058	50
FKC 2,5/ 3-ST-5,08	1873061	50
FKC 2,5/ 4-ST-5,08	1873074	50
FKC 2,5/ 5-ST-5,08	1873087	50
FKC 2,5/ 6-ST-5,08	1873090	50
FKC 2,5/ 7-ST-5,08	1873100	50
FKC 2,5/ 8-ST-5,08	1873113	50
FKC 2,5/ 9-ST-5,08	1873126	50
FKC 2,5/10-ST-5,08	1873139	50
FKC 2,5/11-ST-5,08	1873142	50
FKC 2,5/12-ST-5,08	1873155	50
FKC 2,5/13-ST-5,08	1873168	50
FKC 2,5/14-ST-5,08	1873171	50
FKC 2,5/15-ST-5,08	1873184	50
FKC 2,5/16-ST-5,08	1873197	50

Classic plug-in connector with 5.0 to 7.62 mm pitch

CLASSIC COMBICON plug-in connectors, pitches 5.0 or 5.08 mm

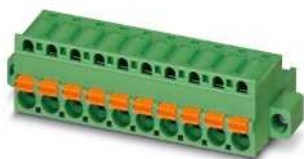

With test connection and screw flange

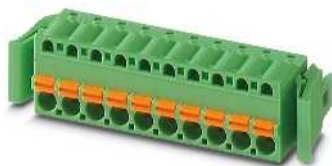

With test connection and self-locking flange

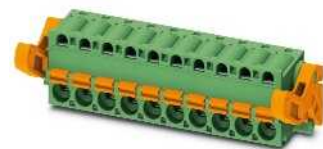

With test connection and Lock & Release levers for snapping on and ejecting



Dimensional drawing

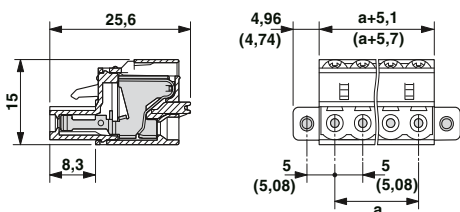

Dimensional drawing

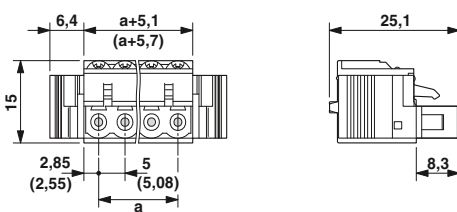

Dimensional drawing

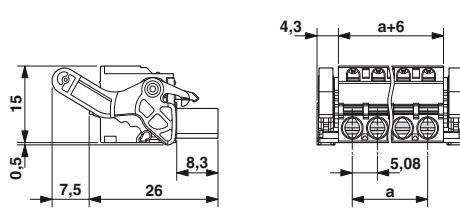

Representative derating curves of the above-mentioned plugs

Type: FKC 2,5/...-ST with MSTBA 2,5/...-G

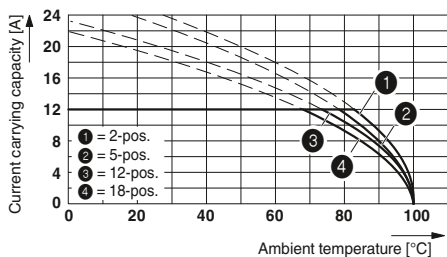

Type: FKC 2,5/...-ST with FKIC 2,5/...-ST

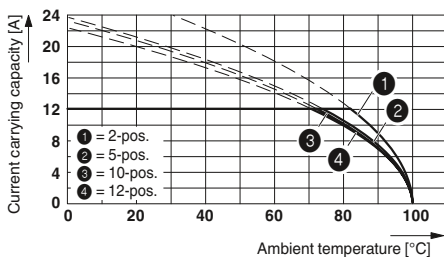

Ordering data

Type	Order No.	Pcs. / Pkt.
5.0 mm pitch, color: green		
FKC 2,5/ 2-STF	1910526	50
FKC 2,5/ 3-STF	1910539	50
FKC 2,5/ 4-STF	1910542	50
FKC 2,5/ 5-STF	1910555	50
FKC 2,5/ 6-STF	1910568	50
FKC 2,5/ 7-STF	1910571	50
FKC 2,5/ 8-STF	1910584	50
FKC 2,5/ 9-STF	1910597	50
FKC 2,5/10-STF	1910607	50
FKC 2,5/11-STF	1910610	50
FKC 2,5/12-STF	1910623	50
FKC 2,5/13-STF	1910636	50
FKC 2,5/14-STF	1910649	50
FKC 2,5/15-STF	1910652	50
FKC 2,5/16-STF	1910665	50
5.08 mm pitch, color: green		
FKC 2,5/ 2-STF-5,08	1873207	50
FKC 2,5/ 3-STF-5,08	1873210	50
FKC 2,5/ 4-STF-5,08	1873223	50
FKC 2,5/ 5-STF-5,08	1873236	50
FKC 2,5/ 6-STF-5,08	1873249	50
FKC 2,5/ 7-STF-5,08	1873252	50
FKC 2,5/ 8-STF-5,08	1873265	50
FKC 2,5/ 9-STF-5,08	1873278	50
FKC 2,5/10-STF-5,08	1873281	50
FKC 2,5/11-STF-5,08	1873294	50
FKC 2,5/12-STF-5,08	1873304	50
FKC 2,5/13-STF-5,08	1873317	50
FKC 2,5/14-STF-5,08	1873320	50
FKC 2,5/15-STF-5,08	1873333	50
FKC 2,5/16-STF-5,08	1873346	50

Ordering data

Type	Order No.	Pcs. / Pkt.
5.0 mm pitch, color: green		
FKC 2,5/ 2-ST-RF	1947052	50
FKC 2,5/ 3-ST-RF	1947065	50
FKC 2,5/ 4-ST-RF	1947078	50
FKC 2,5/ 5-ST-RF	1947081	50
FKC 2,5/ 6-ST-RF	1947094	50
FKC 2,5/ 7-ST-RF	1947104	50
FKC 2,5/ 8-ST-RF	1947117	50
FKC 2,5/ 9-ST-RF	1947120	50
FKC 2,5/10-ST-RF	1947133	50
FKC 2,5/11-ST-RF	1947146	50
FKC 2,5/12-ST-RF	1947159	50
FKC 2,5/13-ST-RF	1947162	50
FKC 2,5/14-ST-RF	1947175	50
FKC 2,5/15-ST-RF	1947188	50
FKC 2,5/16-ST-RF	1947191	50
5.08 mm pitch, color: green		
FKC 2,5/ 2-ST-5,08-RF	1925692	50
FKC 2,5/ 3-ST-5,08-RF	1925702	50
FKC 2,5/ 4-ST-5,08-RF	1925715	50
FKC 2,5/ 5-ST-5,08-RF	1925728	50
FKC 2,5/ 6-ST-5,08-RF	1925731	50
FKC 2,5/ 7-ST-5,08-RF	1925744	50
FKC 2,5/ 8-ST-5,08-RF	1925757	50
FKC 2,5/ 9-ST-5,08-RF	1925760	50
FKC 2,5/10-ST-5,08-RF	1925773	50
FKC 2,5/11-ST-5,08-RF	1925786	50
FKC 2,5/12-ST-5,08-RF	1925799	50
FKC 2,5/13-ST-5,08-RF	1925809	50
FKC 2,5/14-ST-5,08-RF	1925812	50
FKC 2,5/15-ST-5,08-RF	1925825	50
FKC 2,5/16-ST-5,08-RF	1925838	50

Ordering data

Type	Order No.	Pcs. / Pkt.
5.08 mm pitch, color: green		
FKC 2,5/ 2-ST-5,08-LR	1792517	50
FKC 2,5/ 3-ST-5,08-LR	1792520	50
FKC 2,5/ 4-ST-5,08-LR	1792533	50
FKC 2,5/ 5-ST-5,08-LR	1792546	50
FKC 2,5/ 6-ST-5,08-LR	1792559	50
FKC 2,5/ 7-ST-5,08-LR	1792562	50
FKC 2,5/ 8-ST-5,08-LR	1792575	50
FKC 2,5/ 9-ST-5,08-LR	1792588	50
FKC 2,5/10-ST-5,08-LR	1792591	50
FKC 2,5/11-ST-5,08-LR	1792601	50
FKC 2,5/12-ST-5,08-LR	1792614	50
FKC 2,5/13-ST-5,08-LR	1810900	50
FKC 2,5/14-ST-5,08-LR	1810913	50
FKC 2,5/15-ST-5,08-LR	1810926	50
FKC 2,5/16-ST-5,08-LR	1810939	50

Classic plug-in connector with 5.0 to 7.62 mm pitch

CLASSIC COMBICON plug-in connectors, pitches 5.0 or 5.08 mm

Plugs with push-in spring connection

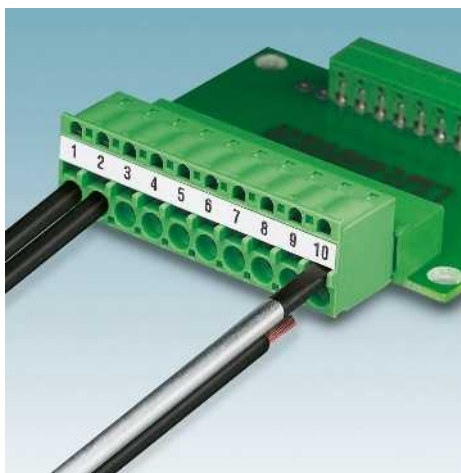

- Fast conductor connection, thanks to push-in spring connection
- Versions with and without a screw flange
- Higher numbers of positions up to 20-pos. can be found at: www.phoenixcontact.net/products

FKCS 2,5/...-ST(F)-...

- With actuation shaft for screwdriver, comfortable “two-hand operation”

FKCT 2,5/...-ST(F)-....

- The cable connection area of the FKCT 2,5/... is located deeper than that of the FK 2,5/... or the FKCS 2,5/...

Notes:

In accordance with DIN EN 61984, COMBICON plug-in connectors have no switching power. During designated use, they must not be plugged in or disconnected when carrying voltage or under load.

COMBICON select

You will find the possible plug-in connector combinations in COMBICON select at: www.phoenixcontact.net/products or starting on page 259.

The maximum torque for the screw flange is 0.3 Nm.

¹⁾ Please observe the derating curves. Derating curves of further combination options on request.

²⁾ CSA data for FKCT 2,5/...-ST(F) on request.



With screwdriver actuation shaft and test connection



Dimensional drawing

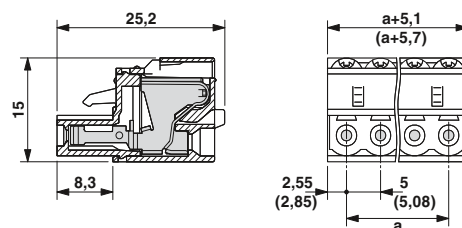

Note derating curves

Derating curves, determined as per DIN EN 61984 (VDE 0627):2002-09
Representation based on DIN EN 60512-5-2:2003-01
Connected conductor cross section = 2.5 mm²
Reduction factor = 0.8
Number of positions = see diagram

Accessories		
For all types	Type	Page
	Marker cards SK 5/3,8 or SK 5,08/3,8	798
	Strain relief STZ ...-FKC-5,08	837
	Coding profile CP-MSTB Order No. 1734634	38
	Ferrules with and without plastic sleeve	834
	Crimping pliers for 0.25 to 6 mm ² CRIMPFox 6 Order No. 1212034	
	Test plug MPS	831

Technical data

Technical data in accordance to IEC / DIN VDE	
Rated current / conductor cross section	[A] / [mm ²]
Rated insulation voltage for pollution degree 2	[V]
Pitch	[mm]
Connection capacity	
Solid / stranded	[mm ²] / [mm ²] / AWG
Stranded with ferrules without plastic sleeve	[mm ²]
Stranded with ferrules with plastic sleeve	[mm ²]
Multi-conductor connection capacity (two conductors with the same cross section)	
Solid / stranded	[mm ²]
Stranded with ferrules without plastic sleeve	[mm ²]
Stranded with TWIN ferrule with plastic sleeve	[mm ²]
Insulation coordination	
Surge voltage category / pollution degree	III / 3 III / 2 II / 2
Rated insulation voltage	[V]
Rated surge voltage	[kV]
Approval data (UL/CUL)	Use Group
Nominal voltage	[V]
Nominal current	[A]
Connection capacity AWG	AWG
Approval data (CSA)	Use Group
Nominal voltage	[V]
Nominal current	[A]
Connection capacity AWG	AWG
General data	
Stripping length	[mm]
Type of insulation material / insulation material group	
Inflammability class according to UL 94	

	12 ¹⁾ / 2.5
	320
	5 / 5.08
	0.2 - 2.5 / 0.2 - 2.5 / 24 - 12
	0.25 - 2.5
	0.25 - 2.5
	- / -
	-
	0.5 - 1
	III / 3 III / 2 II / 2
	250 320 630
	4 4 4
	B C D
	300 - 300
	10 - 10
	26 - 12 - 26 - 12
	B C D
	- - -
	- - -
	- - -
	10
	PA / I
	V0

No. of pos.	Dim. a [mm]
2	5.00
3	10.00
4	15.00
5	20.00
6	25.00
7	30.00
8	35.00
9	40.00
10	45.00
11	50.00
12	55.00
13	60.00
14	65.00
15	70.00
16	75.00

Ordering data

Type	Order No.	Pcs. / Pkt.
5.0 mm pitch, color: green		
FKCS 2,5/ 2-ST	1974737	50
FKCS 2,5/ 3-ST	1974740	50
FKCS 2,5/ 4-ST	1974753	50
FKCS 2,5/ 5-ST	1974766	50
FKCS 2,5/ 6-ST	1974779	50
FKCS 2,5/ 7-ST	1974782	50
FKCS 2,5/ 8-ST	1974795	50
FKCS 2,5/ 9-ST	1974805	50
FKCS 2,5/10-ST	1974818	50
FKCS 2,5/11-ST	1974821	50
FKCS 2,5/12-ST	1974834	50
FKCS 2,5/13-ST	1974847	50
FKCS 2,5/14-ST	1974850	50
FKCS 2,5/15-ST	1974863	50
FKCS 2,5/16-ST	1974876	50
5.08 mm pitch, color: green		
FKCS 2,5/ 2-ST-5,08	1975079	50
FKCS 2,5/ 3-ST-5,08	1975082	50
FKCS 2,5/ 4-ST-5,08	1975095	50
FKCS 2,5/ 5-ST-5,08	1975105	50
FKCS 2,5/ 6-ST-5,08	1975118	50
FKCS 2,5/ 7-ST-5,08	1975121	50
FKCS 2,5/ 8-ST-5,08	1975134	50
FKCS 2,5/ 9-ST-5,08	1975147	50
FKCS 2,5/10-ST-5,08	1975150	50
FKCS 2,5/11-ST-5,08	1975163	50
FKCS 2,5/12-ST-5,08	1975176	50
FKCS 2,5/13-ST-5,08	1975189	50
FKCS 2,5/14-ST-5,08	1975192	50
FKCS 2,5/15-ST-5,08	1975202	50
FKCS 2,5/16-ST-5,08	1975215	50

Classic plug-in connector with 5.0 to 7.62 mm pitch

CLASSIC COMBICON plug-in connectors, pitches 5.0 or 5.08 mm



With screwdriver actuation shaft, test connection and screw flange



With connection area moved to the top and test connection

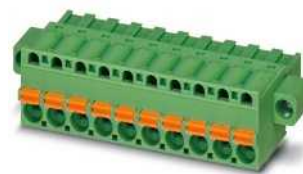

With connection area moved to the top, test connection and screw flange



Dimensional drawing

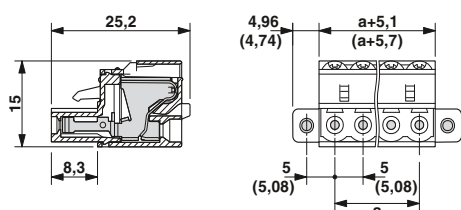

Dimensional drawing

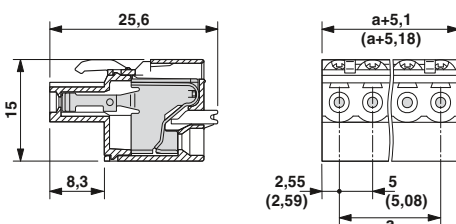

Dimensional drawing

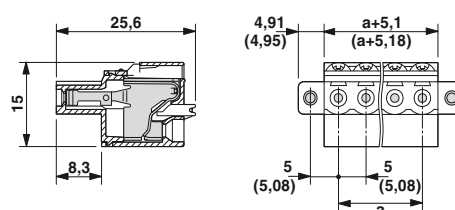

Representative derating curves of the above-mentioned plugs

Type: FKCT 2,5/...-ST with MSTB 2,5/...-G

Type: FKCT 2,5/...-ST with MSTBO 2,5/...-G1L(R)

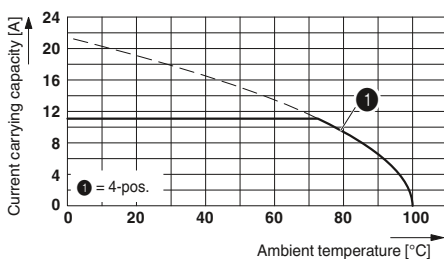
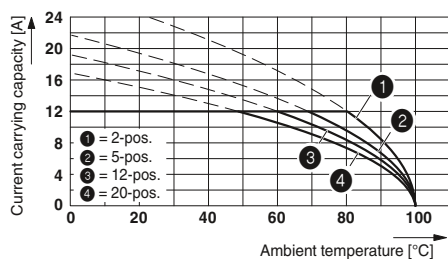

Ordering data

Type	Order No.	Pcs. / Pkt.
5.0 mm pitch, color: green		
FKCS 2,5/ 2-STF	1974928	50
FKCS 2,5/ 3-STF	1974931	50
FKCS 2,5/ 4-STF	1974944	50
FKCS 2,5/ 5-STF	1974957	50
FKCS 2,5/ 6-STF	1974960	50
FKCS 2,5/ 7-STF	1974973	50
FKCS 2,5/ 8-STF	1974986	50
FKCS 2,5/ 9-STF	1974999	50
FKCS 2,5/10-STF	1975008	50
FKCS 2,5/11-STF	1975011	50
FKCS 2,5/12-STF	1975024	50
FKCS 2,5/13-STF	1975037	50
FKCS 2,5/14-STF	1975040	50
FKCS 2,5/15-STF	1975053	50
FKCS 2,5/16-STF	1975066	50
5.08 mm pitch, color: green		
FKCS 2,5/ 2-STF-5,08	1975260	50
FKCS 2,5/ 3-STF-5,08	1975273	50
FKCS 2,5/ 4-STF-5,08	1975286	50
FKCS 2,5/ 5-STF-5,08	1975299	50
FKCS 2,5/ 6-STF-5,08	1975309	50
FKCS 2,5/ 7-STF-5,08	1975312	50
FKCS 2,5/ 8-STF-5,08	1975325	50
FKCS 2,5/ 9-STF-5,08	1975338	50
FKCS 2,5/10-STF-5,08	1975341	50
FKCS 2,5/11-STF-5,08	1975354	50
FKCS 2,5/12-STF-5,08	1975367	50
FKCS 2,5/13-STF-5,08	1975370	50
FKCS 2,5/14-STF-5,08	1975383	50
FKCS 2,5/15-STF-5,08	1975396	50
FKCS 2,5/16-STF-5,08	1975406	50

Ordering data

Type	Order No.	Pcs. / Pkt.
5.0 mm pitch, color: green		
FKCT 2,5/ 2-ST	1909210	50
FKCT 2,5/ 3-ST	1909223	50
FKCT 2,5/ 4-ST	1909236	50
FKCT 2,5/ 5-ST	1909249	50
FKCT 2,5/ 6-ST	1909252	50
FKCT 2,5/ 7-ST	1909265	50
FKCT 2,5/ 8-ST	1909278	50
FKCT 2,5/ 9-ST	1909281	50
FKCT 2,5/10-ST	1909294	50
FKCT 2,5/11-ST	1909304	50
FKCT 2,5/12-ST	1909317	50
FKCT 2,5/13-ST	1909320	50
FKCT 2,5/14-ST	1909333	50
FKCT 2,5/15-ST	1909346	50
FKCT 2,5/16-ST	1909359	50
5.08 mm pitch, color: green		
FKCT 2,5/ 2-ST-5,08	1902110	50
FKCT 2,5/ 3-ST-5,08	1902123	50
FKCT 2,5/ 4-ST-5,08	1902136	50
FKCT 2,5/ 5-ST-5,08	1902149	50
FKCT 2,5/ 6-ST-5,08	1902152	50
FKCT 2,5/ 7-ST-5,08	1902165	50
FKCT 2,5/ 8-ST-5,08	1902178	50
FKCT 2,5/ 9-ST-5,08	1902181	50
FKCT 2,5/10-ST-5,08	1902194	50
FKCT 2,5/11-ST-5,08	1902204	50
FKCT 2,5/12-ST-5,08	1902217	50
FKCT 2,5/13-ST-5,08	1902220	50
FKCT 2,5/14-ST-5,08	1902233	50
FKCT 2,5/15-ST-5,08	1902246	50
FKCT 2,5/16-ST-5,08	1902259	50

Ordering data

Type	Order No.	Pcs. / Pkt.
5.0 mm pitch, color: green		
FKCT 2,5/ 2-STF	1909401	50
FKCT 2,5/ 3-STF	1909414	50
FKCT 2,5/ 4-STF	1909427	50
FKCT 2,5/ 5-STF	1909430	50
FKCT 2,5/ 6-STF	1909443	50
FKCT 2,5/ 7-STF	1909456	50
FKCT 2,5/ 8-STF	1909469	50
FKCT 2,5/ 9-STF	1909472	50
FKCT 2,5/10-STF	1909485	50
FKCT 2,5/11-STF	1909498	50
FKCT 2,5/12-STF	1909508	50
FKCT 2,5/13-STF	1909511	50
FKCT 2,5/14-STF	1909524	50
FKCT 2,5/15-STF	1909537	50
FKCT 2,5/16-STF	1909540	50
5.08 mm pitch, color: green		
FKCT 2,5/ 2-STF-5,08	1902301	50
FKCT 2,5/ 3-STF-5,08	1902314	50
FKCT 2,5/ 4-STF-5,08	1902327	50
FKCT 2,5/ 5-STF-5,08	1902330	50
FKCT 2,5/ 6-STF-5,08	1902343	50
FKCT 2,5/ 7-STF-5,08	1902356	50
FKCT 2,5/ 8-STF-5,08	1902369	50
FKCT 2,5/ 9-STF-5,08	1902372	50
FKCT 2,5/10-STF-5,08	1902385	50
FKCT 2,5/11-STF-5,08	1902398	50
FKCT 2,5/12-STF-5,08	1902408	50
FKCT 2,5/13-STF-5,08	1902411	50
FKCT 2,5/14-STF-5,08	1902424	50
FKCT 2,5/15-STF-5,08	1902437	50
FKCT 2,5/16-STF-5,08	1902440	50

Classic plug-in connector with 5.0 to 7.62 mm pitch

CLASSIC COMBICON plug-in connectors, pitches 5.0 or 5.08 mm

Plugs with push-in spring connection

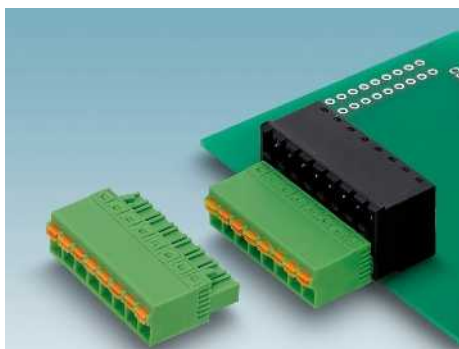

- Extremely flat design of just 10.9 mm
- Connection space for conductor cross sections of up to 2.5 mm²
- Maximum contact and packing density in combination with double-level CCDN 2,5 headers
- Fast conductor connection, thanks to push-in spring connection
- Convenient operation of the terminal point using a screwdriver
- Versions with and without a screw flange
- Higher numbers of positions up to 18-pos. can be found at: www.phoenixcontact.net/products

Notes:

In accordance with DIN EN 61984, COMBICON plug-in connectors have no switching power. During designated use, they must not be plugged in or disconnected when carrying voltage or under load.

COMBICON select

You will find the possible plug-in connector combinations in COMBICON select at: www.phoenixcontact.net/products or starting on page 259.

The maximum torque for the screw flange is 0.3 Nm.

1) Please observe the derating curves. Derating curves of further combination options on request.

2) UL/CUL on request.

3) The insulation material type of the 5.08 mm pitch is Pa and the insulation material group is I.



Plug with flat design

Accessories

For all types	Type	Page
	Coding profile CP-MSTB Order No. 1734634	38
	Marker cards SK 5/3,8	798
	Screwdriver SZF 1-0,6 x 3,5 Order No. 1204517	
	Ferrules with and without plastic sleeve	834
	Crimping pliers for 0.25 to 6 mm ² CRIMPFIX 6 Order No. 1212034	



Dimensional drawing

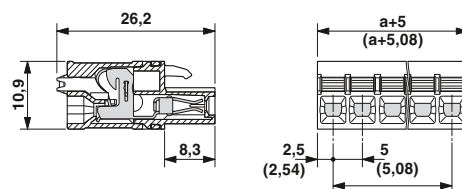

Note derating curves

Derating curves, determined as per
DIN EN 61984 (VDE 0627):2002-09
Representation based on DIN EN 60512-5-2:2003-01
Connected conductor cross section = 2.5 mm²
Reduction factor = 0.8
Number of positions = see diagram

Technical data

Technical data in accordance to IEC / DIN VDE	
Rated current / conductor cross section	[A] / [mm ²]
Rated insulation voltage for pollution degree 2	[V]
Pitch	[mm]
Connection capacity	
Solid / stranded	[mm ²] / [mm ²] / AWG
Stranded with ferrules without plastic sleeve	[mm ²]
Stranded with ferrules with plastic sleeve	[mm ²]
Multi-conductor connection capacity (two conductors with the same cross section)	
Solid / stranded	[mm ²]
Stranded with ferrules without plastic sleeve	[mm ²]
Stranded with TWIN ferrule with plastic sleeve	[mm ²]
Insulation coordination	
Surge voltage category / pollution degree	III / 3 III / 2 II / 2
Rated insulation voltage	[V]
Rated surge voltage	[kV]
Approval data (UL/CUL)	Use Group
Nominal voltage	[V]
Nominal current	[A]
Connection capacity AWG	AWG
Approval data (CSA)	Use Group
Nominal voltage	[V]
Nominal current	[A]
Connection capacity AWG	AWG
General data	
Stripping length	[mm]
Type of insulation material / insulation material group	
Inflammability class according to UL 94	

	12 ¹⁾ / 1.5
	320
	5 / 5.08
	0.2 - 1.5 / 0.2 - 2.5 / 24 - 16
	0.25 - 1.5
	0.25 - 1.5
	- / -
	-
	-
	III / 3 III / 2 II / 2
	320 320 630
	4 4 4
	B C D
	- - -
	- - -
	B C D
	- - -
	- - -
	- - -
	10
	PBT / I ³⁾
	V0

Ordering data

No. of pos.	Dim. a [mm]	Type	Order No.	Pcs. / Pkt.
5.0 mm pitch, color: green				
2	5.00	FKCN 2,5/ 2-ST	1732742	50
3	10.00	FKCN 2,5/ 3-ST	1732755	50
4	15.00	FKCN 2,5/ 4-ST	1732768	50
5	20.00	FKCN 2,5/ 5-ST	1732771	50
6	25.00	FKCN 2,5/ 6-ST	1732784	50
7	30.00	FKCN 2,5/ 7-ST	1732797	50
8	35.00	FKCN 2,5/ 8-ST	1732807	50
9	40.00	FKCN 2,5/ 9-ST	1732810	50
10	45.00	FKCN 2,5/10-ST	1732823	50
11	50.00	FKCN 2,5/11-ST	1732833	50
12	55.00	FKCN 2,5/12-ST	1732836	50
13	60.00	FKCN 2,5/13-ST	1732849	50
14	65.00	FKCN 2,5/14-ST	1732852	50
15	70.00	FKCN 2,5/15-ST	1732865	50
16	75.00	FKCN 2,5/16-ST	1732878	50
5.08 mm pitch, color: green				
2	5.08	FKCN 2,5/ 2-ST-5,08	1754568	50
3	10.16	FKCN 2,5/ 3-ST-5,08	1754571	50
4	15.24	FKCN 2,5/ 4-ST-5,08	1754584	50
5	20.32	FKCN 2,5/ 5-ST-5,08	1754597	50
6	25.40	FKCN 2,5/ 6-ST-5,08	1754607	50
7	30.48	FKCN 2,5/ 7-ST-5,08	1754610	50
8	35.56	FKCN 2,5/ 8-ST-5,08	1754623	50
9	40.64	FKCN 2,5/ 9-ST-5,08	1754636	50
10	45.72	FKCN 2,5/10-ST-5,08	1754649	50
11	50.80	FKCN 2,5/11-ST-5,08	1754652	50
12	55.88	FKCN 2,5/12-ST-5,08	1754665	50
13	60.96	FKCN 2,5/13-ST-5,08	1754678	50
14	66.04	FKCN 2,5/14-ST-5,08	1754681	50
15	71.12	FKCN 2,5/15-ST-5,08	1754694	50
16	76.20	FKCN 2,5/16-ST-5,08	1754704	50

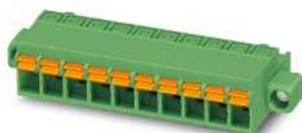

With screw flange



Dimensional drawing

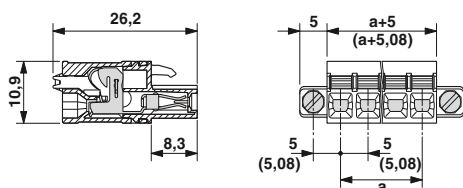

Representative derating curve

Type: FKCN 2,5/...-ST with CCDN 2,5/...-G1 P26 THR

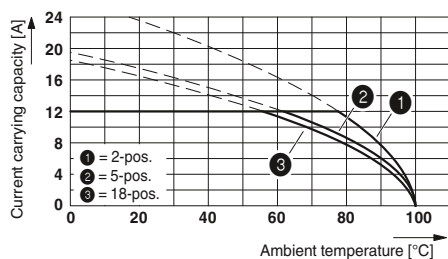

Ordering data

Type	Order No.	Pcs. / Pkt.
5.0 mm pitch, color: green		
FKCN 2,5/ 2-STF	1732962	50
FKCN 2,5/ 3-STF	1732975	50
FKCN 2,5/ 4-STF	1732988	50
FKCN 2,5/ 5-STF	1732991	50
FKCN 2,5/ 6-STF	1733000	50
FKCN 2,5/ 7-STF	1733013	50
FKCN 2,5/ 8-STF	1733026	50
FKCN 2,5/ 9-STF	1733039	50
FKCN 2,5/10-STF	1733042	50
FKCN 2,5/11-STF	1733050	50
FKCN 2,5/12-STF	1733055	50
FKCN 2,5/13-STF	1733068	50
FKCN 2,5/14-STF	1733071	50
FKCN 2,5/15-STF	1733084	50
FKCN 2,5/16-STF	1733097	50
5.08 mm pitch, color: green		
FKCN 2,5/ 2-STF-5,08	1754791	50
FKCN 2,5/ 3-STF-5,08	1754801	50
FKCN 2,5/ 4-STF-5,08	1754814	50
FKCN 2,5/ 5-STF-5,08	1754827	50
FKCN 2,5/ 6-STF-5,08	1754830	50
FKCN 2,5/ 7-STF-5,08	1754843	50
FKCN 2,5/ 8-STF-5,08	1754856	50
FKCN 2,5/ 9-STF-5,08	1754869	50
FKCN 2,5/10-STF-5,08	1754872	50
FKCN 2,5/11-STF-5,08	1754885	50
FKCN 2,5/12-STF-5,08	1754898	50
FKCN 2,5/13-STF-5,08	1754908	50
FKCN 2,5/14-STF-5,08	1754911	50
FKCN 2,5/15-STF-5,08	1754924	50
FKCN 2,5/16-STF-5,08	1754937	50

Classic plug-in connector with 5.0 to 7.62 mm pitch

CLASSIC COMBICON plug-in connectors, pitches 5.0 or 5.08 mm

Plug with push-in spring connection

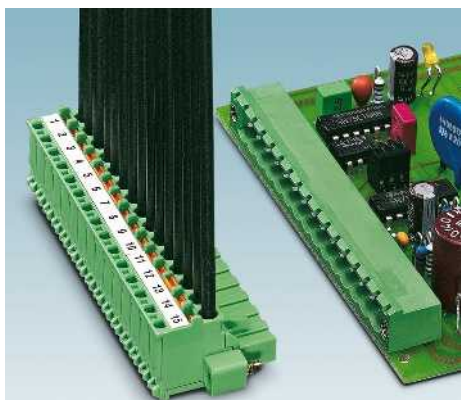

- Fast conductor connection, thanks to push-in spring connection
- Two test connections to accommodate 2 mm Ø test pins or 2.3 mm Ø test connectors
- Versions with and without a screw flange
- You can find higher numbers of positions under:

www.phoenixcontact.net/products

FKCVR 2,5/...-ST...

- Conductor entry on the coded side of the connector

FKCVW 2,5/...-ST...

- Conductor entry on the rippled side of the connector

Notes:

In accordance with DIN EN 61984, COMBICON plug-in connectors have no switching power. During designated use, they must not be plugged in or disconnected when carrying voltage or under load.

COMBICON select

You will find the possible plug-in connector combinations in COMBICON select at: www.phoenixcontact.net/products or starting on page 259.

The maximum torque for the screw flange is 0.3 Nm.

¹⁾ Please observe the derating curves. Derating curves of further combination options on request.



Conductor entry facing coding side



Dimensional drawing

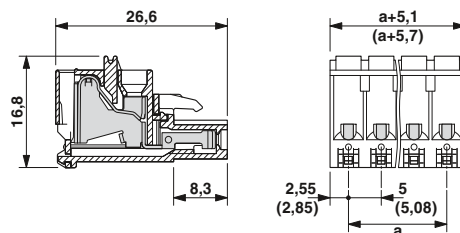

Note derating curves

Derating curves, determined as per DIN EN 61984 (VDE 0627):2002-09
Representation based on DIN EN 60512-5-2:2003-01
Connected conductor cross section = 2.5 mm²
Reduction factor = 0.8
Number of positions = see diagram

Accessories		
For all types	Type	Page
	Marker cards SK 5/3,8 or SK 5,08/3,8	798
	Screwdriver SZS 0,6 x 3,5 Order No. 1205053	
	Coding profile CP-MSTB Order No. 1734634	38
	Ferrules with and without plastic sleeve	834
	Crimping pliers for 0.25 to 6 mm ² CRIMPFOX 6 Order No. 1212034	
	Test plug MPS	831

Technical data

Technical data in accordance to IEC / DIN VDE	
Rated current / conductor cross section	[A] / [mm ²]
Rated insulation voltage for pollution degree 2	[V]
Pitch	[mm]
Connection capacity	
Solid / stranded	[mm ²] / [mm ²] / AWG
Stranded with ferrules without plastic sleeve	[mm ²]
Stranded with ferrules with plastic sleeve	[mm ²]
Multi-conductor connection capacity (two conductors with the same cross section)	
Solid / stranded	[mm ²]
Stranded with ferrules without plastic sleeve	[mm ²]
Stranded with TWIN ferrule with plastic sleeve	[mm ²]
Insulation coordination	
Surge voltage category / pollution degree	III / 3 III / 2 II / 2
Rated insulation voltage	[V]
Rated surge voltage	[kV]
Approval data (UL/CUL)	Use Group
Nominal voltage	[V]
Nominal current	[A]
Connection capacity AWG	AWG
Approval data (CSA)	Use Group
Nominal voltage	[V]
Nominal current	[A]
Connection capacity AWG	AWG
General data	
Stripping length	[mm]
Type of insulation material / insulation material group	
Inflammability class according to UL 94	

	12 ¹⁾ / 2.5
	320
	5 / 5.08
	0.2 - 2.5 / 0.2 - 2.5 / 24 - 12
	0.25 - 2.5
	0.25 - 2.5
	- / -
	-
	0.5 - 1.5
	III / 3 III / 2 II / 2
	250 320 630
	4 4 4
	B C D
	300 - 300
	10 - 10
	26 - 12 - 26 - 12
	B C D
	- - -
	- - -
	- - -
	10
	PA / I
	V0

No. of pos.	Dim. a [mm]
2	5.00
3	10.00
4	15.00
5	20.00
7	30.00
8	35.00
9	40.00
10	45.00
11	50.00
12	55.00
13	60.00
14	65.00
15	70.00
16	75.00

Ordering data

Type	Order No.	Pcs. / Pkt.
5.0 mm pitch, color: green		
FKCVR 2,5/ 2-ST	1909715	50
FKCVR 2,5/ 3-ST	1909728	50
FKCVR 2,5/ 4-ST	1909731	50
FKCVR 2,5/ 5-ST	1909744	50
FKCVR 2,5/ 7-ST	1909760	50
FKCVR 2,5/ 8-ST	1909773	50
FKCVR 2,5/ 9-ST	1909786	50
FKCVR 2,5/10-ST	1909799	50
FKCVR 2,5/11-ST	1909809	50
FKCVR 2,5/12-ST	1909812	50
FKCVR 2,5/13-ST	1909825	50
FKCVR 2,5/14-ST	1909838	50
FKCVR 2,5/15-ST	1909841	50
FKCVR 2,5/16-ST	1909854	50
5.08 mm pitch, color: green		
FKCVR 2,5/ 2-ST-5,08	1873951	50
FKCVR 2,5/ 3-ST-5,08	1873964	50
FKCVR 2,5/ 4-ST-5,08	1873977	50
FKCVR 2,5/ 5-ST-5,08	1873980	50
FKCVR 2,5/ 6-ST-5,08	1873993	50
FKCVR 2,5/ 7-ST-5,08	1874002	50
FKCVR 2,5/ 8-ST-5,08	1874015	50
FKCVR 2,5/ 9-ST-5,08	1874028	50
FKCVR 2,5/10-ST-5,08	1874031	50
FKCVR 2,5/11-ST-5,08	1874044	50
FKCVR 2,5/12-ST-5,08	1874057	50
FKCVR 2,5/13-ST-5,08	1874060	50
FKCVR 2,5/14-ST-5,08	1874073	50
FKCVR 2,5/15-ST-5,08	1874086	50
FKCVR 2,5/16-ST-5,08	1874099	50

Classic plug-in connector with 5.0 to 7.62 mm pitch

CLASSIC COMBICON plug-in connectors, pitches 5.0 or 5.08 mm



Conductor entry facing coding side, with screw flange



Conductor entry facing rippled side

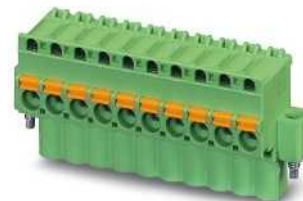

Conductor entry facing rippled side, with screw flange



Dimensional drawing

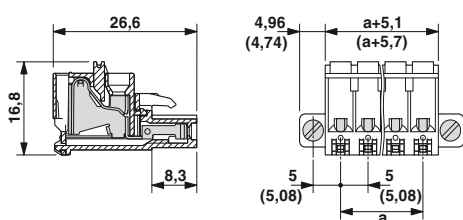

Dimensional drawing

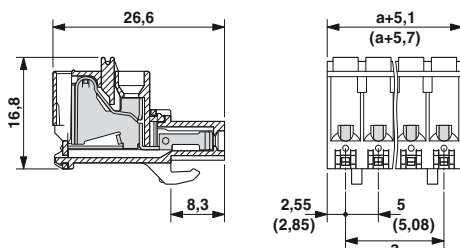

Dimensional drawing

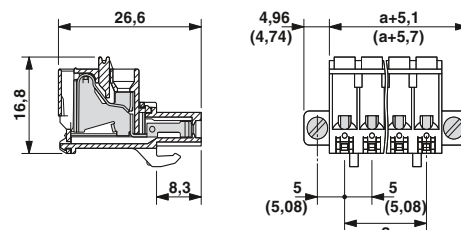

Representative derating curve

Type: FKCVR 2,5/...-ST(-5,08) with MSTBA 2,5/...-G(-5,08)

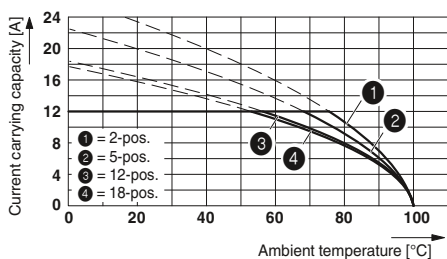

Ordering data

Type	Order No.	Pcs. / Pkt.
5.0 mm pitch, color: green		
FKCVR 2,5/ 2-STF	1909883	50
FKCVR 2,5/ 3-STF	1909896	50
FKCVR 2,5/ 4-STF	1909906	50
FKCVR 2,5/ 5-STF	1909919	50
FKCVR 2,5/ 7-STF	1909935	50
FKCVR 2,5/ 8-STF	1909948	50
FKCVR 2,5/ 9-STF	1909951	50
FKCVR 2,5/10-STF	1909964	50
FKCVR 2,5/11-STF	1909977	50
FKCVR 2,5/12-STF	1909980	50
FKCVR 2,5/13-STF	1909993	50
FKCVR 2,5/14-STF	1910005	50
FKCVR 2,5/15-STF	1910018	50
FKCVR 2,5/16-STF	1910021	50
5.08 mm pitch, color: green		
FKCVR 2,5/ 2-STF-5,08	1874109	50
FKCVR 2,5/ 3-STF-5,08	1874112	50
FKCVR 2,5/ 4-STF-5,08	1874125	50
FKCVR 2,5/ 5-STF-5,08	1874138	50
FKCVR 2,5/ 6-STF-5,08	1874141	50
FKCVR 2,5/ 7-STF-5,08	1874154	50
FKCVR 2,5/ 8-STF-5,08	1874167	50
FKCVR 2,5/ 9-STF-5,08	1874170	50
FKCVR 2,5/10-STF-5,08	1874183	50
FKCVR 2,5/11-STF-5,08	1874196	50
FKCVR 2,5/12-STF-5,08	1874206	50
FKCVR 2,5/13-STF-5,08	1874219	50
FKCVR 2,5/14-STF-5,08	1874222	50
FKCVR 2,5/15-STF-5,08	1874235	50
FKCVR 2,5/16-STF-5,08	1874248	50

Ordering data

Type	Order No.	Pcs. / Pkt.
5.0 mm pitch, color: green		
FKCVW 2,5/ 2-ST	1910034	50
FKCVW 2,5/ 3-ST	1910047	50
FKCVW 2,5/ 4-ST	1910050	50
FKCVW 2,5/ 5-ST	1910063	50
FKCVW 2,5/ 7-ST	1910089	50
FKCVW 2,5/ 8-ST	1910092	50
FKCVW 2,5/ 9-ST	1910102	50
FKCVW 2,5/10-ST	1910115	50
FKCVW 2,5/11-ST	1910128	50
FKCVW 2,5/12-ST	1910131	50
FKCVW 2,5/13-ST	1910144	50
FKCVW 2,5/14-ST	1910157	50
FKCVW 2,5/15-ST	1910160	50
FKCVW 2,5/16-ST	1910173	50
5.08 mm pitch, color: green		
FKCVW 2,5/ 2-ST-5,08	1873650	50
FKCVW 2,5/ 3-ST-5,08	1873663	50
FKCVW 2,5/ 4-ST-5,08	1873676	50
FKCVW 2,5/ 5-ST-5,08	1873689	50
FKCVW 2,5/ 6-ST-5,08	1873692	50
FKCVW 2,5/ 7-ST-5,08	1873702	50
FKCVW 2,5/ 8-ST-5,08	1873715	50
FKCVW 2,5/ 9-ST-5,08	1873728	50
FKCVW 2,5/10-ST-5,08	1873731	50
FKCVW 2,5/11-ST-5,08	1873744	50
FKCVW 2,5/12-ST-5,08	1873757	50
FKCVW 2,5/13-ST-5,08	1873760	50
FKCVW 2,5/14-ST-5,08	1873773	50
FKCVW 2,5/15-ST-5,08	1873786	50
FKCVW 2,5/16-ST-5,08	1873799	50

Ordering data

Type	Order No.	Pcs. / Pkt.
5.0 mm pitch, color: green		
FKCVW 2,5/ 2-STF	1910209	50
FKCVW 2,5/ 3-STF	1910212	50
FKCVW 2,5/ 4-STF	1910225	50
FKCVW 2,5/ 5-STF	1910238	50
FKCVW 2,5/ 7-STF	1910254	50
FKCVW 2,5/ 8-STF	1910267	50
FKCVW 2,5/ 9-STF	1910270	50
FKCVW 2,5/10-STF	1910283	50
FKCVW 2,5/11-STF	1910296	50
FKCVW 2,5/12-STF	1910306	50
FKCVW 2,5/13-STF	1910319	50
FKCVW 2,5/14-STF	1910322	50
FKCVW 2,5/15-STF	1910335	50
FKCVW 2,5/16-STF	1910348	50
5.08 mm pitch, color: green		
FKCVW 2,5/ 2-STF-5,08	1873809	50
FKCVW 2,5/ 3-STF-5,08	1873812	50
FKCVW 2,5/ 4-STF-5,08	1873825	50
FKCVW 2,5/ 5-STF-5,08	1873838	50
FKCVW 2,5/ 6-STF-5,08	1873841	50
FKCVW 2,5/ 7-STF-5,08	1873854	50
FKCVW 2,5/ 8-STF-5,08	1873867	50
FKCVW 2,5/ 9-STF-5,08	1873870	50
FKCVW 2,5/10-STF-5,08	1873883	50
FKCVW 2,5/11-STF-5,08	1873896	50
FKCVW 2,5/12-STF-5,08	1873906	50
FKCVW 2,5/13-STF-5,08	1873919	50
FKCVW 2,5/14-STF-5,08	1873922	50
FKCVW 2,5/15-STF-5,08	1873935	50
FKCVW 2,5/16-STF-5,08	1873948	50

Classic plug-in connector with 5.0 to 7.62 mm pitch

CLASSIC COMBICON plug-in connectors, pitches 5.0 or 5.08 mm

Plug with push-in spring connection



- Front TWIN connection for 1.5 mm²
- Additional actuation option of 90° in relation to the conductor axis
- For 90° actuation in relation to the conductor axis, the TVFKCL 1.5 extended design is required in the lower level of the ME housing

Notes:

In accordance with DIN EN 61984, COMBICON plug-in connectors have no switching power. During designated use, they must not be plugged in or disconnected when carrying voltage or under load.

COMBICON select

You will find the possible plug-in connector combinations in COMBICON select at: www.phoenixcontact.net/products or starting on page 259.

1) Please observe the derating curves. Derating curves of further combination options on request.

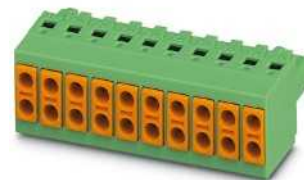

With double connection, short design



Dimensional drawing

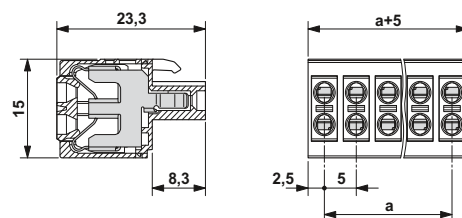

Note derating curves

Derating curves, determined as per
DIN EN 61984 (VDE 0627):2002-09
Representation based on DIN EN 60512-5-2:2003-01
Connected conductor cross section = 1.5 mm²
Reduction factor = 0.8
Number of positions = see diagram

Accessories

For all types	Type	Page
	Coding profile CP-MSTB Order No. 1734634	38
	Screwdriver SZF 0-0,4 x 2,5 Order No. 1204504	
	Marker cards SK 5/3,8	798
	Ferrules with and without plastic sleeve	834
	Crimping pliers for 0.25 to 6 mm ² CRIMPFOX 6 Order No. 1212034	

Technical data

Technical data in accordance to IEC / DIN VDE	
Rated current / conductor cross section	[A] / [mm ²]
Rated insulation voltage for pollution degree 2	[V]
Pitch	[mm]
Connection capacity	
Solid / stranded	[mm ²] / [mm ²] / AWG
Stranded with ferrules without plastic sleeve	[mm ²]
Stranded with ferrules with plastic sleeve	[mm ²]
Multi-conductor connection capacity (two conductors with the same cross section)	
Solid / stranded	[mm ²]
Stranded with ferrules without plastic sleeve	[mm ²]
Stranded with TWIN ferrule with plastic sleeve	[mm ²]
Insulation coordination	
Surge voltage category / pollution degree	III / 3 III / 2 II / 2
Rated insulation voltage	[V]
Rated surge voltage	[kV]
Approval data (UL/CUL)	Use Group
Nominal voltage	[V]
Nominal current	[A]
Connection capacity AWG	AWG
Approval data (CSA)	Use Group
Nominal voltage	[V]
Nominal current	[A]
Connection capacity AWG	AWG
General data	
Stripping length	[mm]
Type of insulation material / insulation material group	
Inflammability class according to UL 94	

10 ¹) / 1.5		
320		
5		
0.2 - 1.5 / 0.2 - 1.5 / 24 - 16		
0.25 - 1.5		
0.25 - 1.5		
- / -		
-		
-		
III / 3 III / 2 II / 2		
250 320 630		
4 4 4		
B C D		
300 - 300		
8 - 8		
24 - 16 - 24 - 16		
B C D		
- - -		
- - -		
- - -		
8		
PA / I		
V0		

Ordering data

No. of pos.	Dim. a [mm]	Type	Order No.	Pcs. / Pkt.
5.0 mm pitch, color: green				
2	5.00	TVFKC 1,5/ 2-ST	1713839	50
3	10.00	TVFKC 1,5/ 3-ST	1713842	50
4	15.00	TVFKC 1,5/ 4-ST	1713855	50
5	20.00	TVFKC 1,5/ 5-ST	1713868	50
6	25.00	TVFKC 1,5/ 6-ST	1713871	50
7	30.00	TVFKC 1,5/ 7-ST	1713884	50
8	35.00	TVFKC 1,5/ 8-ST	1713897	50
9	40.00	TVFKC 1,5/ 9-ST	1713907	50
10	45.00	TVFKC 1,5/10-ST	1713910	50

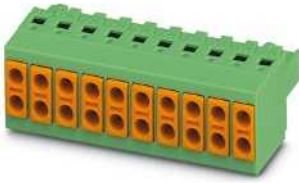

With double connection, long design



Dimensional drawing

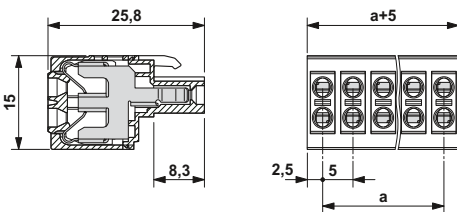

Representative derating curve

Type: TVFKC 1,5/...-ST with MSTBA 2,5/...-G

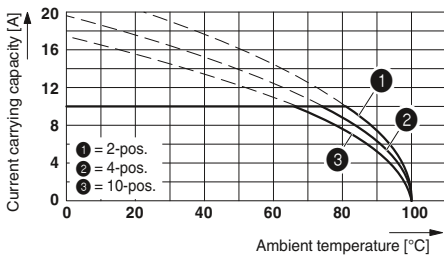

Ordering data

Type	Order No.	Pcs. / Pkt.
5.0 mm pitch, color: green		
TVFKCL 1,5/ 2-ST	1715921	50
TVFKCL 1,5/ 3-ST	1715934	50
TVFKCL 1,5/ 4-ST	1715947	50
TVFKCL 1,5/ 5-ST	1715950	50
TVFKCL 1,5/ 6-ST	1715963	50
TVFKCL 1,5/ 7-ST	1715976	50
TVFKCL 1,5/ 8-ST	1715989	50
TVFKCL 1,5/ 9-ST	1715992	50
TVFKCL 1,5/10-ST	1716001	50

Classic plug-in connector with 5.0 to 7.62 mm pitch

CLASSIC COMBICON plug-in connectors, pitches 5.0 or 5.08 mm

Plugs with push-in spring connection

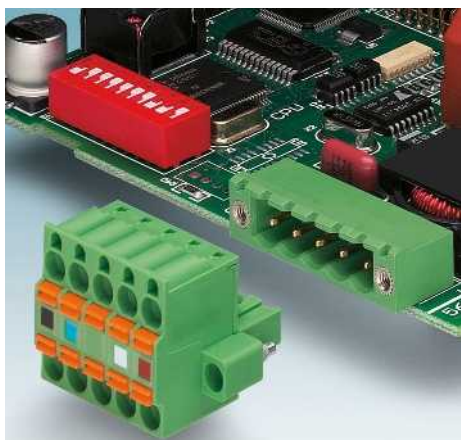

- Front TWIN connection for 2.5 mm²
- Integrated 2.3 mm Ø test connection
- DeviceNet-compliant design with a gold-plated contact system
- SK marking strips for DeviceNet color coding: SK 5,08/3,8 DN / order no. 1965458

Notes:

In accordance with DIN EN 61984, COMBICON plug-in connectors have no switching power. During designated use, they must not be plugged in or disconnected when carrying voltage or under load.

COMBICON select

You will find the possible plug-in connector combinations in COMBICON select at: www.phoenixcontact.net/products or starting on page 259.

The maximum torque for the screw flange is 0.3 Nm.

¹⁾ Please observe the derating curves. Derating curves of further combination options on request.

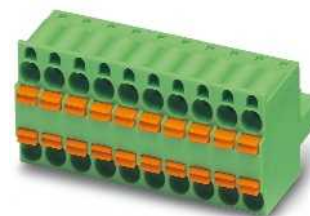

With double connection



Dimensional drawing

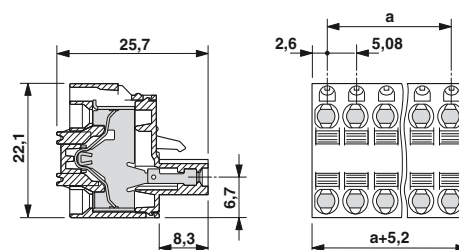

Note derating curves

Derating curves, determined as per DIN EN 61984 (VDE 0627):2002-09
Representation based on DIN EN 60512-5-2:2003-01
Connected conductor cross section = 2.5 mm²
Reduction factor = 0.8
Number of positions = see diagram

Accessories		
For all types	Type	Page
	Marking card, 4-color, for DeviceNet applications SK 5,08/3,8 DN Order No. 1965458	
	Screwdriver SZS 0,6 x 3,5 Order No. 1205053	
	Coding profile CP-MSTB Order No. 1734634	38
	Ferrules with and without plastic sleeve	834
	Crimping pliers for 0.25 to 6 mm ² CRIMPFOX 6 Order No. 1212034	
	Test plug MPS	831

Technical data

Technical data in accordance to IEC / DIN VDE	
Rated current / conductor cross section	[A] / [mm ²]
Rated insulation voltage for pollution degree 2	[V]
Pitch	[mm]
Connection capacity	
Solid / stranded	[mm ²] / [mm ²] / AWG
Stranded with ferrules without plastic sleeve	[mm ²]
Stranded with ferrules with plastic sleeve	[mm ²]
Multi-conductor connection capacity (two conductors with the same cross section)	
Solid / stranded	[mm ²]
Stranded with ferrules without plastic sleeve	[mm ²]
Stranded with TWIN ferrule with plastic sleeve	[mm ²]
Insulation coordination	
Surge voltage category / pollution degree	
Rated insulation voltage	[V]
Rated surge voltage	[kV]
Approval data (UL/CUL)	Use Group
Nominal voltage	[V]
Nominal current	[A]
Connection capacity AWG	AWG
Approval data (CSA)	Use Group
Nominal voltage	[V]
Nominal current	[A]
Connection capacity AWG	AWG
General data	
Stripping length	[mm]
Type of insulation material / insulation material group	
Inflammability class according to UL 94	

12 ¹⁾ / 2.5		
320		
5.08		
0.2 - 2.5 / 0.2 - 2.5 / 24 - 12		
0.25 - 2.5		
0.25 - 1.5		
- / -		
-		
0.5 - 1		
III / 3	III / 2	II / 2
320	320	630
4	4	4
B	C	D
300	-	300
10	-	10
26 - 12	-	26 - 12
B	C	D
-	-	-
-	-	-
-	-	-
10		
PA / I		
V0		

No. of pos.	Dim. a [mm]
2	5.08
3	10.16
4	15.24
5	20.32
6	25.40
7	30.48
8	35.56
9	40.64
10	45.72
5	20.32
7	30.48
8	35.56

Ordering data

Type	Order No.	Pcs. / Pkt.
5.08 mm pitch, color: green		
TFKC 2,5/ 2-ST-5,08	1962600	50
TFKC 2,5/ 3-ST-5,08	1962613	50
TFKC 2,5/ 4-ST-5,08	1962626	50
TFKC 2,5/ 5-ST-5,08	1962639	50
TFKC 2,5/ 6-ST-5,08	1962642	50
TFKC 2,5/ 7-ST-5,08	1962655	50
TFKC 2,5/ 8-ST-5,08	1962668	50
TFKC 2,5/ 9-ST-5,08	1962671	50
TFKC 2,5/10-ST-5,08	1962684	50
5.08 mm pitch, color: green, contact system: Gold-plated		
TFKC 2,5/ 5-ST-5,08 AU	1965461	50

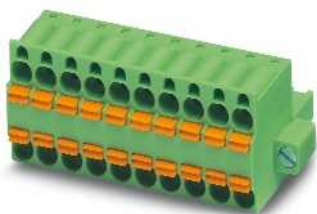

With double connection and screw flange



Dimensional drawing

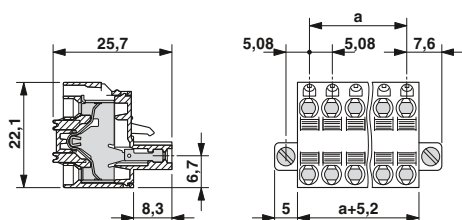

Representative derating curve

Type: TFKC 2,5/...-ST-5,08 with MSTBA 2,5/...-G-5,08

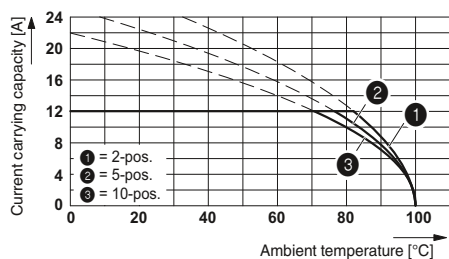

Ordering data

Type	Order No.	Pcs. / Pkt.
5.08 mm pitch, color: green		
TFKC 2,5/ 2-STF-5,08	1962697	50
TFKC 2,5/ 3-STF-5,08	1962707	50
TFKC 2,5/ 4-STF-5,08	1962710	50
TFKC 2,5/ 5-STF-5,08	1962723	50
TFKC 2,5/ 6-STF-5,08	1962736	50
TFKC 2,5/ 7-STF-5,08	1962749	50
TFKC 2,5/ 8-STF-5,08	1962752	50
TFKC 2,5/ 9-STF-5,08	1962765	50
TFKC 2,5/10-STF-5,08	1962778	50
5.08 mm pitch, color: green, contact system: Gold-plated		
TFKC 2,5/ 5-STF-5,08 AU	1962590	50
TFKC 2,5/ 7-STF-5,08 AU	1765748	50
TFKC 2,5/ 8-STF-5,08 AU	1710272	50

Classic plug-in connector with 5.0 to 7.62 mm pitch

CLASSIC COMBICON plug-in connectors, pitches 5.0 or 5.08 mm

Inverted plugs with push-in spring connection

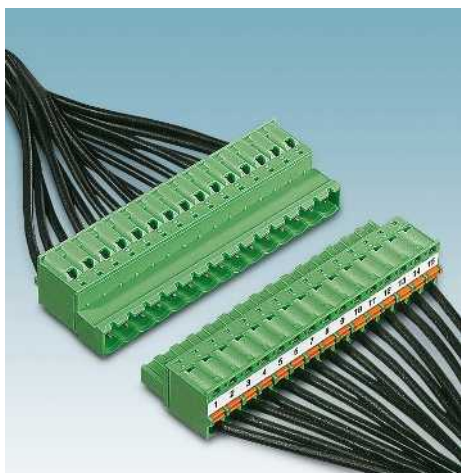

- Connectors with inverted contact system (pin contact)
- Can be combined with inverted headers and plugs for shock-proof applications
- Versions with and without a screw flange
- Versions with engagement noses for locking plugs with self-locking flanges
- SK 5/3,8 or SK 5,08/3,8 marker cards can be found on page 798

Notes:

In accordance with DIN EN 61984, COMBICON plug-in connectors have no switching power. During designated use, they must not be plugged in or disconnected when carrying voltage or under load.

The inverted contact system is explained on page 34.

COMBICON select

You will find the possible plug-in connector combinations in COMBICON select at: www.phoenixcontact.net/products or starting on page 259.

The maximum torque for the screw flange is 0.3 Nm.

¹⁾ Please observe the derating curves. Derating curves of further combination options on request.

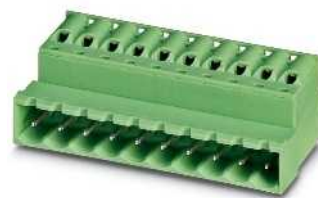

Inverted plug with push-in spring connection



Dimensional drawing

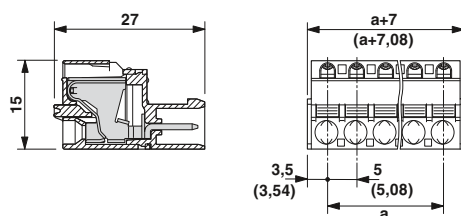

Note derating curves

Derating curves, determined as per DIN EN 61984 (VDE 0627):2002-09
Representation based on DIN EN 60512-5-2:2003-01
Connected conductor cross section = 2.5 mm²
Reduction factor = 0.8
Number of positions = see diagram

Accessories

For all types	Type	Page
	Coding section CR-MSTB Order No. 1734401	38
	Strain relief STZ ...FKC-5,08	837
	Screwdriver SZS 0,6 x 3,5 Order No. 1205053	
	Ferrules with and without plastic sleeve	834
	Crimping pliers for 0.25 to 6 mm ² CRIMPFOX 6 Order No. 1212034	
	Test plug MPS	831

Technical data

Technical data in accordance to IEC / DIN VDE	
Rated current / conductor cross section	[A] / [mm ²]
Rated insulation voltage for pollution degree 2	[V]
Pitch	[mm]
Connection capacity	
Solid / stranded	[mm ²] / [mm ²] / AWG
Stranded with ferrules without plastic sleeve	[mm ²]
Stranded with ferrules with plastic sleeve	[mm ²]
Multi-conductor connection capacity (two conductors with the same cross section)	
Solid / stranded	[mm ²]
Stranded with ferrules without plastic sleeve	[mm ²]
Stranded with TWIN ferrule with plastic sleeve	[mm ²]
Insulation coordination	
Surge voltage category / pollution degree	III / 3 III / 2 II / 2
Rated insulation voltage	[V]
Rated surge voltage	[kV]
Approval data (UL/CUL)	Use Group
Nominal voltage	[V]
Nominal current	[A]
Connection capacity AWG	AWG
Approval data (CSA)	Use Group
Nominal voltage	[V]
Nominal current	[A]
Connection capacity AWG	AWG
General data	
Stripping length	[mm]
Type of insulation material / insulation material group	
Inflammability class according to UL 94	

		12 ¹⁾ / 2.5
		320
		5 / 5.08
		0.2 - 2.5 / 0.2 - 2.5 / 24 - 12
		0.25 - 2.5
		- / -
		-
		0.5 - 1
		III / 3 III / 2 II / 2
		320 320 630
		4 4 4
		B C D
		300 - 300
		10 - 10
		26 - 12 - 26 - 12
		B C D
		- - -
		- - -
		- - -
		10
		PA / I
		V0

No. of pos.	Dim. a [mm]
2	5.00
3	10.00
4	15.00
5	20.00
6	25.00
7	30.00
8	35.00
9	40.00
10	45.00
11	50.00
12	55.00
13	60.00
14	65.00
15	70.00
16	75.00

Ordering data

Type	Order No.	Pcs. / Pkt.
5.0 mm pitch, color: green		
FKIC 2,5/ 2-ST	1910678	50
FKIC 2,5/ 3-ST	1910681	50
FKIC 2,5/ 4-ST	1910694	50
FKIC 2,5/ 5-ST	1910704	50
FKIC 2,5/ 6-ST	1910717	50
FKIC 2,5/ 7-ST	1910720	50
FKIC 2,5/ 8-ST	1910733	50
FKIC 2,5/ 9-ST	1910746	50
FKIC 2,5/10-ST	1910759	50
FKIC 2,5/ 11-ST	1910762	50
FKIC 2,5/12-ST	1910775	50
FKIC 2,5/13-ST	1910788	50
FKIC 2,5/14-ST	1910791	50
FKIC 2,5/15-ST	1910801	50
FKIC 2,5/16-ST	1910814	50
5.08 mm pitch, color: green		
FKIC 2,5/ 2-ST-5,08	1873359	50
FKIC 2,5/ 3-ST-5,08	1873362	50
FKIC 2,5/ 4-ST-5,08	1873375	50
FKIC 2,5/ 5-ST-5,08	1873388	50
FKIC 2,5/ 6-ST-5,08	1873391	50
FKIC 2,5/ 7-ST-5,08	1873401	50
FKIC 2,5/ 8-ST-5,08	1873414	50
FKIC 2,5/ 9-ST-5,08	1873427	50
FKIC 2,5/10-ST-5,08	1873430	50
FKIC 2,5/11-ST-5,08	1873443	50
FKIC 2,5/12-ST-5,08	1873456	50
FKIC 2,5/13-ST-5,08	1873469	50
FKIC 2,5/14-ST-5,08	1873472	50
FKIC 2,5/15-ST-5,08	1873485	50
FKIC 2,5/16-ST-5,08	1873498	50

Classic plug-in connector with 5.0 to 7.62 mm pitch

CLASSIC COMBICON plug-in connectors, pitches 5.0 or 5.08 mm



With screw flange, for screw connection using inverted headers

With engagement nose for snapping onto connectors with a self-locking flange



Dimensional drawing

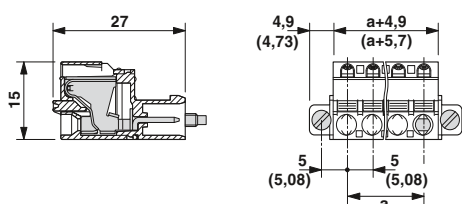

Dimensional drawing

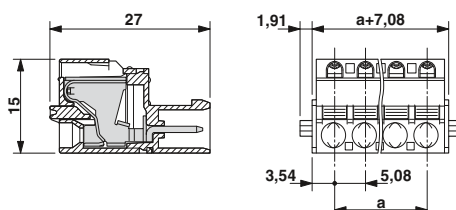

Representative derating curve

Type: FKIC 2,5/...-ST with FKIC 2,5/...-ST

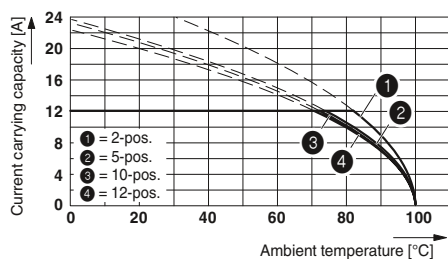

Ordering data

Type	Order No.	Pcs. / Pkt.
5.0 mm pitch, color: green		
FKIC 2,5/ 2-STF	1910827	50
FKIC 2,5/ 3-STF	1910830	50
FKIC 2,5/ 4-STF	1910843	50
FKIC 2,5/ 5-STF	1910856	50
FKIC 2,5/ 6-STF	1910869	50
FKIC 2,5/ 7-STF	1910872	50
FKIC 2,5/ 8-STF	1910885	50
FKIC 2,5/ 9-STF	1910898	50
FKIC 2,5/10-STF	1910908	50
FKIC 2,5/11-STF	1910911	50
FKIC 2,5/12-STF	1910924	50
FKIC 2,5/13-STF	1910937	50
FKIC 2,5/14-STF	1910940	50
FKIC 2,5/15-STF	1910953	50
FKIC 2,5/16-STF	1910966	50
5.08 mm pitch, color: green		
FKIC 2,5/ 2-STF-5,08	1873508	50
FKIC 2,5/ 3-STF-5,08	1873511	50
FKIC 2,5/ 4-STF-5,08	1873524	50
FKIC 2,5/ 5-STF-5,08	1873537	50
FKIC 2,5/ 6-STF-5,08	1873540	50
FKIC 2,5/ 7-STF-5,08	1873553	50
FKIC 2,5/ 8-STF-5,08	1873566	50
FKIC 2,5/ 9-STF-5,08	1873579	50
FKIC 2,5/10-STF-5,08	1873582	50
FKIC 2,5/11-STF-5,08	1873595	50
FKIC 2,5/12-STF-5,08	1873605	50
FKIC 2,5/13-STF-5,08	1873618	50
FKIC 2,5/14-STF-5,08	1873621	50
FKIC 2,5/15-STF-5,08	1873634	50
FKIC 2,5/16-STF-5,08	1873647	50

Ordering data

Type	Order No.	Pcs. / Pkt.
5.08 mm pitch, color: green		
FKIC 2,5/ 2-ST-5,08-RN	1925867	50
FKIC 2,5/ 3-ST-5,08-RN	1925870	50
FKIC 2,5/ 4-ST-5,08-RN	1925883	50
FKIC 2,5/ 5-ST-5,08-RN	1925896	50
FKIC 2,5/ 6-ST-5,08-RN	1925906	50
FKIC 2,5/ 7-ST-5,08-RN	1925919	50
FKIC 2,5/ 8-ST-5,08-RN	1925922	50
FKIC 2,5/ 9-ST-5,08-RN	1925935	50
FKIC 2,5/10-ST-5,08-RN	1925948	50
FKIC 2,5/11-ST-5,08-RN	1925951	50
FKIC 2,5/12-ST-5,08-RN	1925964	50
FKIC 2,5/13-ST-5,08-RN	1925977	50
FKIC 2,5/14-ST-5,08-RN	1925980	50
FKIC 2,5/15-ST-5,08-RN	1925993	50
FKIC 2,5/16-ST-5,08-RN	1926002	50

Classic plug-in connector with 5.0 to 7.62 mm pitch

CLASSIC COMBICON plug-in connectors, pitches 5.0 or 5.08 mm

Inverted plugs with push-in spring connection

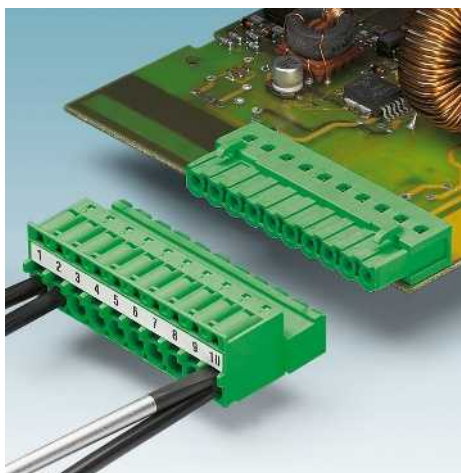

- Plugs with inverted contact system (pin contact)
- Can be combined with inverted headers and connectors for shock-proof applications
- With actuation shaft for screwdriver, user-friendly “two-hand operation”
- Versions with and without a screw flange
- SK 5/3,8 or SK 5,08/3,8 marker cards can be found on page 798

Notes:

In accordance with DIN EN 61984, COMBICON plug-in connectors have no switching power. During designated use, they must not be plugged in or disconnected when carrying voltage or under load.

COMBICON select

You will find the possible plug-in connector combinations in COMBICON select at: www.phoenixcontact.net/products or starting on page 259.

The inverted contact system is explained on page 34.

The maximum torque for the screw flange is 0.3 Nm.

1) Please observe the derating curves. Derating curves of further combination options on request.

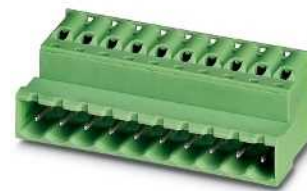

Inverted plug with push-in spring connection, with screwdriver actuation shaft, and test connection



Dimensional drawing

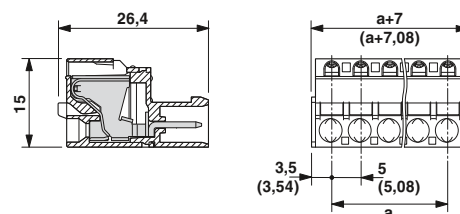

Note derating curves

Derating curves, determined as per DIN EN 61984 (VDE 0627):2002-09
Representation based on DIN EN 60512-5-2:2003-01
Connected conductor cross section = 2.5 mm²
Reduction factor = 0.8
Number of positions = see diagram

Accessories

For all types	Type	Page
	Coding section CR-MSTB Order No. 1734401	38
	Strain relief STZ ...-FKC-5,08	837
	Screwdriver SZS 0,6 x 3,5 Order No. 1205053	
	Ferrules with and without plastic sleeve	834
	Crimping pliers for 0.25 to 6 mm ² CRIMPFOX 6 Order No. 1212034	
	Test plug MPS	831

Technical data

Technical data in accordance to IEC / DIN VDE	
Rated current / conductor cross section	[A] / [mm ²]
Rated insulation voltage for pollution degree 2	[V]
Pitch	[mm]
Connection capacity	
Solid / stranded	[mm ²] / [mm ²] / AWG
Stranded with ferrules without plastic sleeve	[mm ²]
Stranded with ferrules with plastic sleeve	[mm ²]
Multi-conductor connection capacity (two conductors with the same cross section)	
Solid / stranded	[mm ²]
Stranded with ferrules without plastic sleeve	[mm ²]
Stranded with TWIN ferrule with plastic sleeve	[mm ²]
Insulation coordination	
Surge voltage category / pollution degree	III / 3 III / 2 II / 2
Rated insulation voltage	[V]
Rated surge voltage	[kV]
Approval data (UL/CUL)	Use Group
Nominal voltage	[V]
Nominal current	[A]
Connection capacity AWG	AWG
Approval data (CSA)	Use Group
Nominal voltage	[V]
Nominal current	[A]
Connection capacity AWG	AWG
General data	
Stripping length	[mm]
Type of insulation material / insulation material group	
Inflammability class according to UL 94	

		12 ¹⁾ / 2.5
		320
		5 / 5.08
		0.2 - 2.5 / 0.2 - 2.5 / 24 - 12
		0.25 - 2.5
		0.25 - 2.5
		- / -
		-
		0.5 - 1
		III / 3 III / 2 II / 2
		320 320 630
		4 4 4
		B C D
		300 - 300
		10 - 10
		26 - 12 - 26 - 12
		B C D
		- - -
		- - -
		- - -
		10
		PA / I
		V0

No. of pos.	Dim. a [mm]
2	5.00
3	10.00
4	15.00
5	20.00
6	25.00
7	30.00
8	35.00
9	40.00
10	45.00
11	50.00
12	55.00
13	60.00
14	65.00
15	70.00
16	75.00

Ordering data

Type	Order No.	Pcs. / Pkt.
5.0 mm pitch, color: green		
FKICS 2,5/ 2-ST	1981445	50
FKICS 2,5/ 3-ST	1981458	50
FKICS 2,5/ 4-ST	1981461	50
FKICS 2,5/ 5-ST	1981474	50
FKICS 2,5/ 6-ST	1981487	50
FKICS 2,5/ 7-ST	1981490	50
FKICS 2,5/ 8-ST	1981500	50
FKICS 2,5/ 9-ST	1981513	50
FKICS 2,5/10-ST	1981526	50
FKICS 2,5/11-ST	1981539	50
FKICS 2,5/12-ST	1981542	50
FKICS 2,5/13-ST	1981555	50
FKICS 2,5/14-ST	1981568	50
FKICS 2,5/15-ST	1981571	50
FKICS 2,5/16-ST	1981584	50
5.08 mm pitch, color: green		
FKICS 2,5/ 2-ST-5,08	1981746	50
FKICS 2,5/ 3-ST-5,08	1981759	50
FKICS 2,5/ 4-ST-5,08	1981762	50
FKICS 2,5/ 5-ST-5,08	1981775	50
FKICS 2,5/ 6-ST-5,08	1981788	50
FKICS 2,5/ 7-ST-5,08	1981791	50
FKICS 2,5/ 8-ST-5,08	1981801	50
FKICS 2,5/ 9-ST-5,08	1981814	50
FKICS 2,5/10-ST-5,08	1981827	50
FKICS 2,5/11-ST-5,08	1981830	50
FKICS 2,5/12-ST-5,08	1981843	50
FKICS 2,5/13-ST-5,08	1981856	50
FKICS 2,5/14-ST-5,08	1981869	50
FKICS 2,5/15-ST-5,08	1981872	50
FKICS 2,5/16-ST-5,08	1981885	50

Classic plug-in connector with 5.0 to 7.62 mm pitch

CLASSIC COMBICON plug-in connectors, pitches 5.0 or 5.08 mm

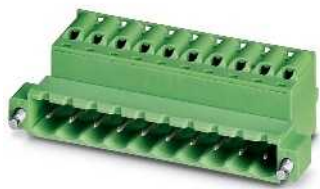

With screw flange, for screw connection using inverted headers



Inverted plug with push-in spring connection, engagement noses and flanges for direct fixing



Dimensional drawing

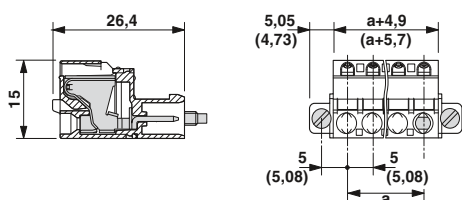

Dimensional drawing

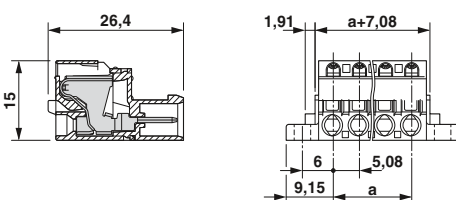

Representative derating curve

Type: FKIC 2,5/...-ST with FKIC 2,5/...-ST

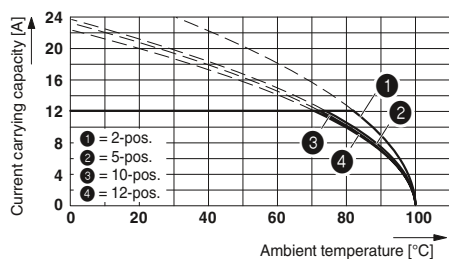

Ordering data

Type	Order No.	Pcs. / Pkt.
5.0 mm pitch, color: green		
FKICS 2,5/ 2-STF	1981597	50
FKICS 2,5/ 3-STF	1981607	50
FKICS 2,5/ 4-STF	1981610	50
FKICS 2,5/ 5-STF	1981623	50
FKICS 2,5/ 6-STF	1981636	50
FKICS 2,5/ 7-STF	1981649	50
FKICS 2,5/ 8-STF	1981652	50
FKICS 2,5/ 9-STF	1981665	50
FKICS 2,5/10-STF	1981678	50
FKICS 2,5/11-STF	1981681	50
FKICS 2,5/12-STF	1981694	50
FKICS 2,5/13-STF	1981704	50
FKICS 2,5/14-STF	1981717	50
FKICS 2,5/15-STF	1981720	50
FKICS 2,5/16-STF	1981733	50
5.08 mm pitch, color: green		
FKICS 2,5/ 2-STF-5,08	1981898	50
FKICS 2,5/ 3-STF-5,08	1981908	50
FKICS 2,5/ 4-STF-5,08	1981911	50
FKICS 2,5/ 5-STF-5,08	1981924	50
FKICS 2,5/ 6-STF-5,08	1981937	50
FKICS 2,5/ 7-STF-5,08	1981940	50
FKICS 2,5/ 8-STF-5,08	1981953	50
FKICS 2,5/ 9-STF-5,08	1981966	50
FKICS 2,5/10-STF-5,08	1981979	50
FKICS 2,5/11-STF-5,08	1981982	50
FKICS 2,5/12-STF-5,08	1981995	50
FKICS 2,5/13-STF-5,08	1982004	50
FKICS 2,5/14-STF-5,08	1982017	50
FKICS 2,5/15-STF-5,08	1982020	50
FKICS 2,5/16-STF-5,08	1982033	50

Ordering data

Type	Order No.	Pcs. / Pkt.
5.08 mm pitch, color: green		
FKICS 2,5/ 2-STD-5,08-RN	1808721	50
FKICS 2,5/ 3-STD-5,08-RN	1808734	50
FKICS 2,5/ 4-STD-5,08-RN	1808747	50
FKICS 2,5/ 5-STD-5,08-RN	1808750	50
FKICS 2,5/ 6-STD-5,08-RN	1808763	50
FKICS 2,5/ 7-STD-5,08-RN	1808776	50
FKICS 2,5/ 8-STD-5,08-RN	1808789	50
FKICS 2,5/ 9-STD-5,08-RN	1808792	50
FKICS 2,5/10-STD-5,08-RN	1808802	50
FKICS 2,5/11-STD-5,08-RN	1808815	50
FKICS 2,5/12-STD-5,08-RN	1808828	50
FKICS 2,5/13-STD-5,08-RN	1808831	50
FKICS 2,5/14-STD-5,08-RN	1808844	50
FKICS 2,5/15-STD-5,08-RN	1808857	50
FKICS 2,5/16-STD-5,08-RN	1808860	50

Classic plug-in connector with 5.0 to 7.62 mm pitch

CLASSIC COMBICON plug-in connectors, pitches 5.0 or 5.08 mm

Plug with displacement connection

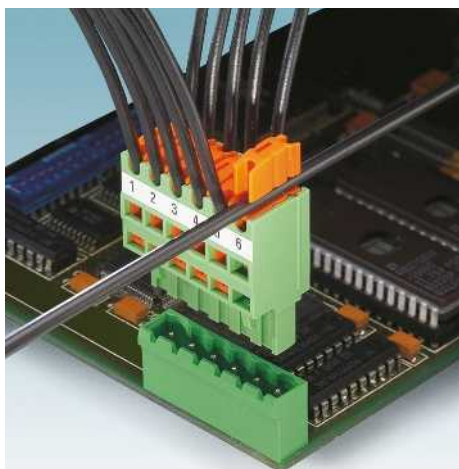

- Reduced wiring time since pretreatment of the conductor is no longer necessary
- For stranded conductors with PVC or PE insulation
- Connection as per EN 60352-4
- Integrated 1.2 mm Ø test connection
- Bus plug version
- Higher numbers of positions up to 18-pos. can be found at: www.phoenixcontact.net/products
- User notes and recommendations for the insulation displacement technology can be found on page 22

Notes:

In accordance with DIN EN 61984, COMBICON plug-in connectors have no switching power. During designated use, they must not be plugged in or disconnected when carrying voltage or under load.

COMBICON select

You will find the possible plug-in connector combinations in COMBICON select at: www.phoenixcontact.net/products or starting on page 259.



The maximum torque for the screw flange is 0.3 Nm.

¹⁾ Please observe the derating curves. Derating curves of further combination options on request.



Plug with displacement connection

Accessories

For all types	Type	Page
	Coding profile CP-MSTB Order No. 1734634	38
	Screwdriver SZF 0-0,4 x 2,5 Order No. 1204504	
	Marker cards SK 5,08/3,8	798



Dimensional drawing

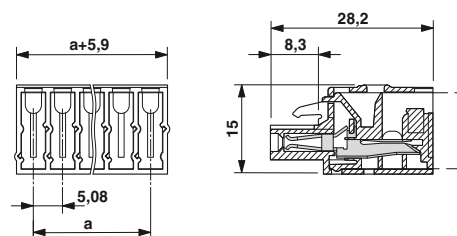

Note derating curves

Derating curves, determined as per
DIN EN 61984 (VDE 0627):2002-09
Representation based on DIN EN 60512-5-2:2003-01
Connected conductor cross section = 1 mm²
Reduction factor = 0.8
Number of positions = see diagram

Technical data

Technical data in accordance to IEC / DIN VDE	
Rated current / conductor cross section	[A] / [mm ²]
Rated insulation voltage for pollution degree 2	[V]
Pitch	[mm]
Connection capacity	
Solid / stranded	[mm ²] / [mm ²] / AWG
Stranded with ferrules without plastic sleeve	[mm ²]
Stranded with ferrules with plastic sleeve	[mm ²]
Multi-conductor connection capacity (two conductors with the same cross section)	
Solid / stranded	[mm ²]
Stranded with ferrules without plastic sleeve	[mm ²]
Stranded with TWIN ferrule with plastic sleeve	[mm ²]
Insulation coordination	
Surge voltage category / pollution degree	III / 3 III / 2 II / 2
Rated insulation voltage	[V] 500 630 1000
Rated surge voltage	[kV] 6 6 6
Approval data (UL/CUL)	Use Group B C D
Nominal voltage	[V] 300 - 300
Nominal current	[A] 10 - 10
Connection capacity AWG	AWG 22 - 18 - 22 - 18
Approval data (CSA)	Use Group B C D
Nominal voltage	[V] - - -
Nominal current	[A] - - -
Connection capacity AWG	AWG - - -
General data	
Type of insulation material / insulation material group	PA / I
Inflammability class according to UL 94	V0

Ordering data

Type	Order No.	Pcs. / Pkt.
No. of pos.	Dim. a [mm]	
2	5.00	
3	10.00	
4	15.00	
5	20.00	
6	25.00	
5.08 mm pitch, color: green		
2	5.08	QC 1/ 2-ST-5,08 1883255 50
3	10.16	QC 1/ 3-ST-5,08 1883268 50
4	15.24	QC 1/ 4-ST-5,08 1883271 50
5	20.32	QC 1/ 5-ST-5,08 1883284 50
6	25.40	QC 1/ 6-ST-5,08 1883297 50
7	30.48	QC 1/ 7-ST-5,08 1883307 50
8	35.56	QC 1/ 8-ST-5,08 1883310 50
9	40.64	QC 1/ 9-ST-5,08 1883323 50
10	45.72	QC 1/10-ST-5,08 1883336 50
11	50.80	QC 1/11-ST-5,08 1883349 50
12	55.88	QC 1/12-ST-5,08 1883705 50
13	60.96	QC 1/13-ST-5,08 1883815 50
14	66.04	QC 1/14-ST-5,08 1883828 50
15	71.12	QC 1/15-ST-5,08 1883831 50
16	76.20	QC 1/16-ST-5,08 1883844 50

Classic plug-in connector with 5.0 to 7.62 mm pitch

CLASSIC COMBICON plug-in connectors, pitches 5.0 or 5.08 mm



With screw flange



BUS connector for the looping through of conductors



Dimensional drawing

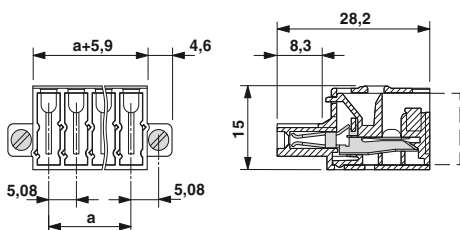

Dimensional drawing

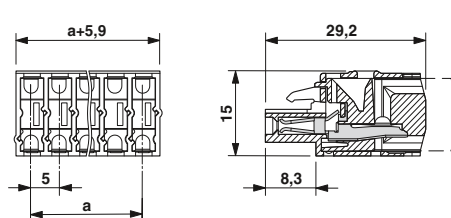

Representative derating curve

Type: QC 1/...-ST-5,08 with MSTBA 2,5/...-G-5,08

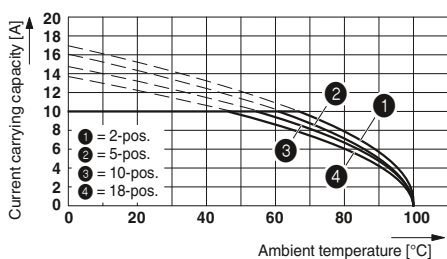

Ordering data

Type	Order No.	Pcs. / Pkt.
5.08 mm pitch, color: green		
QC 1/ 2-STF-5,08	1883352	50
QC 1/ 3-STF-5,08	1883365	50
QC 1/ 4-STF-5,08	1883378	50
QC 1/ 5-STF-5,08	1883381	50
QC 1/ 6-STF-5,08	1883394	50
QC 1/ 7-STF-5,08	1883404	50
QC 1/ 8-STF-5,08	1883417	50
QC 1/ 9-STF-5,08	1883420	50
QC 1/10-STF-5,08	1883433	50
QC 1/11-STF-5,08	1883446	50
QC 1/12-STF-5,08	1883459	50
QC 1/13-STF-5,08	1883857	50
QC 1/14-STF-5,08	1883860	50
QC 1/15-STF-5,08	1883886	50
QC 1/16-STF-5,08	1883899	50

Ordering data

Type	Order No.	Pcs. / Pkt.
5.0 mm pitch, color: green		
QC 1/ 2-ST-BUS	1921670	50
QC 1/ 3-ST-BUS	1921683	50
QC 1/ 4-ST-BUS	1921696	50
QC 1/ 5-ST-BUS	1921706	50
QC 1/ 6-ST-BUS	1921719	50

Classic plug-in connector with 5.0 to 7.62 mm pitch

CLASSIC COMBICON plug-in connectors, pitches 5.0 or 5.08 mm

Plug with displacement connection

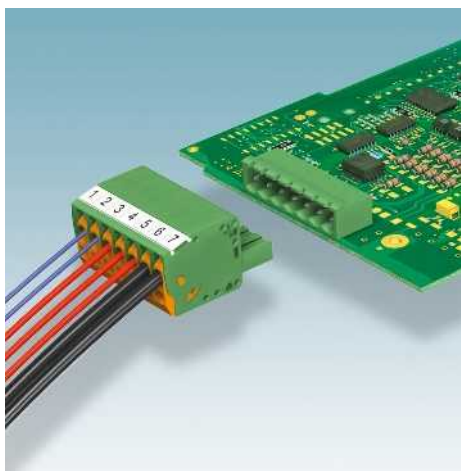

- Easy operation through IDC displacement connection
- Plug-in direction parallel to the conductor axis
- Versions with and without a screw flange
- This connection technology is suitable for cables with PVC and PE insulation
- User notes and recommendations for the insulation displacement technology can be found on page 22

Notes:

In accordance with DIN EN 61984, COMBICON plug-in connectors have no switching power. During designated use, they must not be plugged in or disconnected when carrying voltage or under load.

COMBICON select

You will find the possible plug-in connector combinations in COMBICON select at: www.phoenixcontact.net/products or starting on page 259.

The maximum torque for the screw flange is 0.3 Nm.

¹⁾ Please observe the derating curves. Derating curves of further combination options on request.

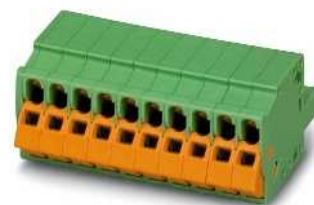

With displacement connection

Accessories

For all types	Type	Page
	Coding profile CP-MSTB Order No. 1734634	38
	Marker cards SK 5/3,8	798
	Screwdriver SZF 1-0,6 x 3,5 Order No. 1204517	
	Zack marker strip, flat ZBF 5/...	806



Dimensional drawing

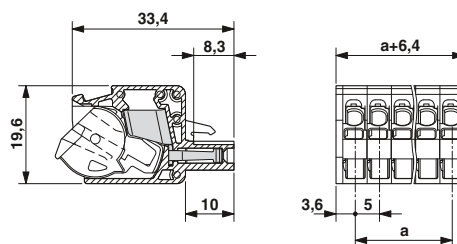

Note derating curves

Derating curves, determined as per
DIN EN 61984 (VDE 0627):2002-09
Representation based on DIN EN 60512-5-2:2003-01
Connected conductor cross section = AWG 16
Reduction factor = 0.8
Number of positions = see diagram

Technical data

Technical data in accordance to IEC / DIN VDE			
Rated current / conductor cross section	[A] / [mm ²]	12 ¹⁾ / 1.5	
Rated insulation voltage for pollution degree 2	[V]	630	
Pitch	[mm]	5	
Connection capacity			
Solid / stranded	[mm ²] / [mm ²] / AWG	0.2 - 1.5 / 0.2 - 1.5 / 24 - 16	
Stranded with ferrules without plastic sleeve	[mm ²]	-	
Stranded with ferrules with plastic sleeve	[mm ²]	-	
Multi-conductor connection capacity (two conductors with the same cross section)			
Solid / stranded	[mm ²]	- / -	
Stranded with ferrules without plastic sleeve	[mm ²]	-	
Stranded with TWIN ferrule with plastic sleeve	[mm ²]	-	
Insulation coordination			
Surge voltage category / pollution degree		III / 3	III / 2
Rated insulation voltage	[V]	500	630
Rated surge voltage	[kV]	6	6
Approval data (UL/CUL)	Use Group	B	C
Nominal voltage	[V]	300	300
Nominal current	[A]	10	10
Connection capacity AWG	AWG	24 - 16	24 - 16
Approval data (CSA)	Use Group	B	C
Nominal voltage	[V]	-	-
Nominal current	[A]	-	-
Connection capacity AWG	AWG	-	-
General data			
Type of insulation material / insulation material group		PA / I	
Inflammability class according to UL 94		V0	

Ordering data

No. of pos.	Dim. a [mm]	Type	Order No.	Pcs. / Pkt.
5.0 mm pitch, color: green				
2	5.00	QC 1,5/ 2-ST	1717961	50
3	10.00	QC 1,5/ 3-ST	1717974	50
4	15.00	QC 1,5/ 4-ST	1717987	50
5	20.00	QC 1,5/ 5-ST	1717990	50
6	25.00	QC 1,5/ 6-ST	1718009	50
7	30.00	QC 1,5/ 7-ST	1718012	50
8	35.00	QC 1,5/ 8-ST	1718025	50
9	40.00	QC 1,5/ 9-ST	1718038	50
10	45.00	QC 1,5/10-ST	1718041	50
11	50.00	QC 1,5/11-ST	1718054	50
12	55.00	QC 1,5/12-ST	1718067	50
13	60.00	QC 1,5/13-ST	1718070	50
14	65.00	QC 1,5/14-ST	1718083	50
15	70.00	QC 1,5/15-ST	1718096	50
16	75.00	QC 1,5/16-ST	1718106	50

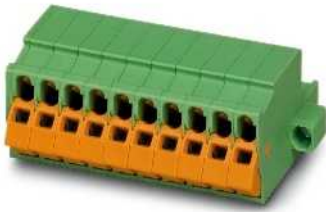

With screw flange



Dimensional drawing

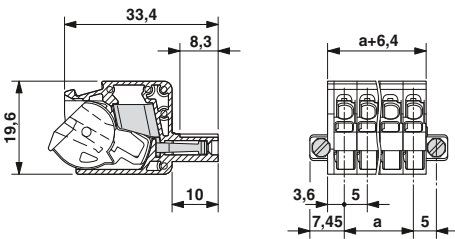

Representative derating curve

Type: QC 1,5/...-ST-5,0 with MSTBVA 2,5 HC/...G

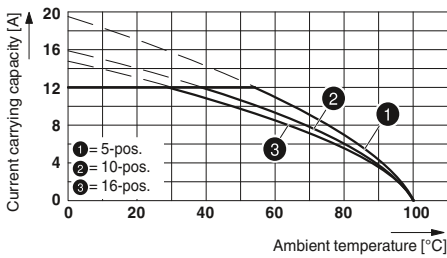

Ordering data

Type	Order No.	Pcs. / Pkt.
5.0 mm pitch, color: green		
QC 1,5/ 2-STF	1718119	50
QC 1,5/ 3-STF	1718122	50
QC 1,5/ 4-STF	1718135	50
QC 1,5/ 5-STF	1718148	50
QC 1,5/ 6-STF	1718151	50
QC 1,5/ 7-STF	1718164	50
QC 1,5/ 8-STF	1718177	50
QC 1,5/ 9-STF	1718180	50
QC 1,5/10-STF	1718193	50
QC 1,5/11-STF	1718203	50
QC 1,5/12-STF	1718216	50
QC 1,5/13-STF	1718229	50
QC 1,5/14-STF	1718232	50
QC 1,5/15-STF	1718245	50
QC 1,5/16-STF	1718258	50

Classic plug-in connector with 5.0 to 7.62 mm pitch

CLASSIC COMBICON plug-in connectors, pitches 5.0 or 5.08 mm

Connectors with crimp connection



- Flat design of the MSTBC 2,5 connector range
- Plug-in direction parallel to the conductor axis
- Versions with and without a screw flange or a self-locking flange
- Versions with and without a snap-lock option for pullout aid
- Compatible with MSTB 2,5 headers, IC 2,5 and ICC 2,5 plugs

MSTBC-MT 0,5-1,0

- For conductor cross sections of 0.5 to 1.0 mm² (AWG 20-18) and currents of up to 10 A

MSTBC-MT 1,5-2,5

- For conductor cross sections of 1.5 to 2.5 mm² (AWG 16-14) and currents of up to 12 A

Notes:

In accordance with DIN EN 61984, COMBICON plug-in connectors have no switching power. During designated use, they must not be plugged in or disconnected when carrying voltage or under load.

COMBICON select

You will find the possible plug-in connector combinations in COMBICON select at: www.phoenixcontact.net/products or starting on page 259.

Larger numbers of positions up to 24-pos. and additional technical information can be found at www.phoenixcontact.com

The maximum torque for the screw flange is 0.3 Nm.

¹⁾ Please observe the derating curves. Derating curves of further combination options on request.



Flat plug for crimp contacts



Dimensional drawing

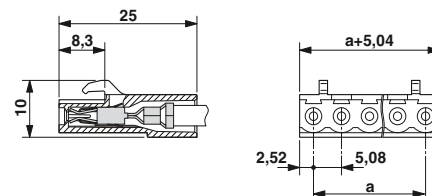

Note derating curves

Derating curves, determined as per DIN EN 61984 (VDE 0627):2002-09
Representation based on DIN EN 60512-5-2:2003-01
Connected conductor cross section = 2.5 mm²
Reduction factor = 0.8
Number of positions = see diagram

Accessories		
For all types	Type	Page
	Coding profile CP-MSTB Order No. 1734634	38
	Marker cards SK 5,08/3,8	798
	Screwdriver SZS 0,4 x 2,5 Order No. 1205037	
	Module socket contact MSTBC-MT...	827
	Crimping pliers for 0.5 to 2.5 mm ² CRIMPFOX MT 2,5 Order No. 1204038	
Only for MSTBC 2,5/...STZ....		
	Pullout aid STZ...MSTBC-5,08	828

Technical data

Technical data in accordance to IEC / DIN VDE	
Rated current / conductor cross section	[A] / [mm ²]
Rated insulation voltage for pollution degree 2	[V]
Pitch	[mm]
Connection capacity	
Solid / stranded	[mm ²] / [mm ²] / AWG
Stranded with ferrules without plastic sleeve	[mm ²]
Stranded with ferrules with plastic sleeve	[mm ²]
Multi-conductor connection capacity (two conductors with the same cross section)	
Solid / stranded	[mm ²]
Stranded with ferrules without plastic sleeve	[mm ²]
Stranded with TWIN ferrule with plastic sleeve	[mm ²]
Insulation coordination	
Surge voltage category / pollution degree	III / 3 III / 2 II / 2
Rated insulation voltage	[V]
Rated surge voltage	[kV]
Approval data (UL/CUL)	Use Group
Nominal voltage	[V]
Nominal current	[A]
Connection capacity AWG	AWG
Approval data (CSA)	Use Group
Nominal voltage	[V]
Nominal current	[A]
Connection capacity AWG	AWG
General data	
Type of insulation material / insulation material group	PA / I
Inflammability class according to UL 94	V0

No. of pos.	Dim. a [mm]
2	5.08
3	10.16
4	15.24
5	20.32
6	25.40
7	30.48
8	35.56
9	40.64
10	45.72
11	50.80
12	55.88
13	60.96
14	66.04
15	71.12
16	76.20

Ordering data

Type	Order No.	Pcs. / Pkt.
5.08 mm pitch, color: green		
MSTBC 2,5/ 2-ST-5,08	1808816	50
MSTBC 2,5/ 3-ST-5,08	1808829	50
MSTBC 2,5/ 4-ST-5,08	1808832	50
MSTBC 2,5/ 5-ST-5,08	1808845	50
MSTBC 2,5/ 6-ST-5,08	1808858	50
MSTBC 2,5/ 7-ST-5,08	1808861	50
MSTBC 2,5/ 8-ST-5,08	1808874	50
MSTBC 2,5/ 9-ST-5,08	1808887	50
MSTBC 2,5/10-ST-5,08	1808890	50
MSTBC 2,5/11-ST-5,08	1808900	50
MSTBC 2,5/12-ST-5,08	1808913	50
MSTBC 2,5/13-ST-5,08	1808926	50
MSTBC 2,5/14-ST-5,08	1808939	50
MSTBC 2,5/15-ST-5,08	1808942	50
MSTBC 2,5/16-ST-5,08	1808955	50

Classic plug-in connector with 5.0 to 7.62 mm pitch

CLASSIC COMBICON plug-in connectors, pitches 5.0 or 5.08 mm



With snap-lock option for pull-out aid

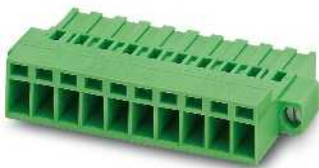

With screw flange and snap-lock option for pull-out aid



With self-locking flange and snap-lock option for pull-out aid



Dimensional drawing

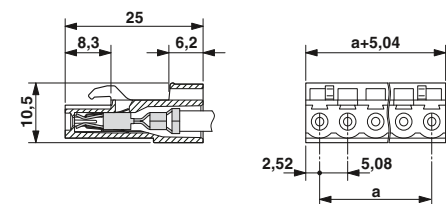

Dimensional drawing

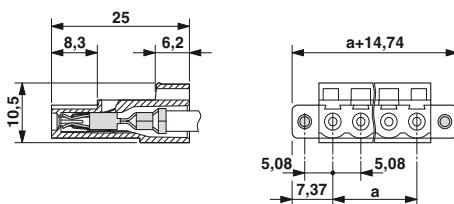

Dimensional drawing

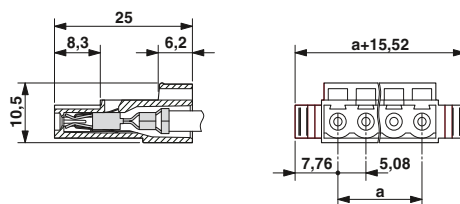

Representative derating curve

Type: MSTBC 2,5/...-ST-5,08 with MSTBA 2,5/...-G-5,08; contact: MSTBC-MT 1,5 - 2,5

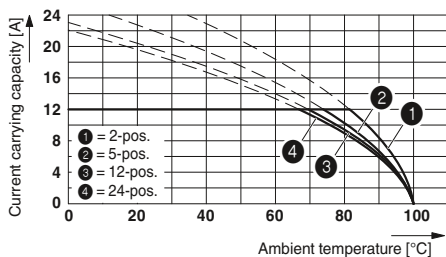

Ordering data

Type	Order No.	Pcs. / Pkt.
5.08 mm pitch, color: green		
MSTBC 2,5/ 2-STZ-5,08	1809501	50
MSTBC 2,5/ 3-STZ-5,08	1809514	50
MSTBC 2,5/ 4-STZ-5,08	1809527	50
MSTBC 2,5/ 5-STZ-5,08	1809530	50
MSTBC 2,5/ 6-STZ-5,08	1809543	50
MSTBC 2,5/ 7-STZ-5,08	1809556	50
MSTBC 2,5/ 8-STZ-5,08	1809569	50
MSTBC 2,5/ 9-STZ-5,08	1809572	50
MSTBC 2,5/10-STZ-5,08	1809585	50
MSTBC 2,5/11-STZ-5,08	1809598	50
MSTBC 2,5/12-STZ-5,08	1809608	50
MSTBC 2,5/13-STZ-5,08	1809611	50
MSTBC 2,5/14-STZ-5,08	1809624	50
MSTBC 2,5/15-STZ-5,08	1809637	50
MSTBC 2,5/16-STZ-5,08	1809640	50

Ordering data

Type	Order No.	Pcs. / Pkt.
5.08 mm pitch, color: green		
MSTBC 2,5/ 2-STZF-5,08	1809734	50
MSTBC 2,5/ 3-STZF-5,08	1809747	50
MSTBC 2,5/ 4-STZF-5,08	1809750	50
MSTBC 2,5/ 5-STZF-5,08	1809763	50
MSTBC 2,5/ 6-STZF-5,08	1809776	50
MSTBC 2,5/ 7-STZF-5,08	1809789	50
MSTBC 2,5/ 8-STZF-5,08	1809792	50
MSTBC 2,5/ 9-STZF-5,08	1809802	50
MSTBC 2,5/10-STZF-5,08	1809815	50
MSTBC 2,5/11-STZF-5,08	1809828	50
MSTBC 2,5/12-STZF-5,08	1809831	50
MSTBC 2,5/13-STZF-5,08	1809844	50
MSTBC 2,5/14-STZF-5,08	1809857	50
MSTBC 2,5/15-STZF-5,08	1809860	50
MSTBC 2,5/16-STZF-5,08	1809873	50

Ordering data

Type	Order No.	Pcs. / Pkt.
5.08 mm pitch, color: green		
MSTBC 2,5/ 2-STZ-5,08-R	1809048	50
MSTBC 2,5/ 3-STZ-5,08-R	1809051	50
MSTBC 2,5/ 4-STZ-5,08-R	1809064	50
MSTBC 2,5/ 5-STZ-5,08-R	1809077	50
MSTBC 2,5/ 6-STZ-5,08-R	1809080	50
MSTBC 2,5/ 7-STZ-5,08-R	1809093	50
MSTBC 2,5/ 8-STZ-5,08-R	1809103	50
MSTBC 2,5/ 9-STZ-5,08-R	1809116	50
MSTBC 2,5/10-STZ-5,08-R	1809129	50
MSTBC 2,5/11-STZ-5,08-R	1809132	50
MSTBC 2,5/12-STZ-5,08-R	1809145	50
MSTBC 2,5/13-STZ-5,08-R	1809158	50
MSTBC 2,5/14-STZ-5,08-R	1809161	50
MSTBC 2,5/15-STZ-5,08-R	1809174	50
MSTBC 2,5/16-STZ-5,08-R	1809187	50

Classic plug-in connector with 5.0 to 7.62 mm pitch

CLASSIC COMBICON plug-in connectors, pitches 5.0 or 5.08 mm

Inverted plugs with a crimp connection

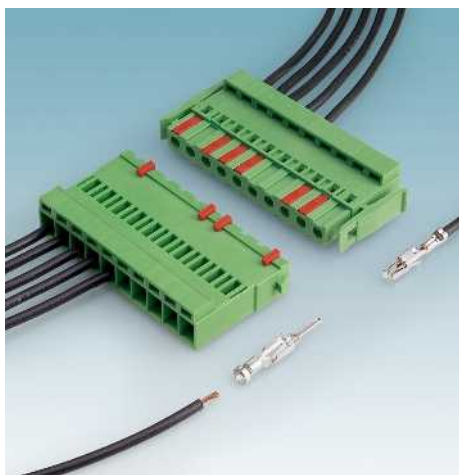

- Plugs with inverted contact system (pin contact)
- With snap-lock option for pullout aid
- ICC 2,5/...-STZ-5,08 with engagement noses for MSTBC 2,5/...-ST-... and for snapping on with MSTBC 2,5/...-STZ-5,08-R
- ICC 2,5/...-STZF-5,08 are, among other things, compatible with the IC 2,5/...-GF-5,08 inverted base strips

ICC-MT 0,5-1,0

- for conductor cross sections of 0.5 to 1.0 mm² (AWG 20-18) and currents of up to 10 A

ICC-MT 1,5-2,5

- for conductor cross sections of 1.5 to 2.5 mm² (AWG 16-14) and currents of up to 12 A

Notes:
In accordance with DIN EN 61984, COMBICON plug-in connectors have no switching power. During designated use, they must not be plugged in or disconnected when carrying voltage or under load.
Larger numbers of positions up to 24-pos. and additional technical information can be found at www.phoenixcontact.com
COMBICON select You will find the possible plug-in connector combinations in COMBICON select at: www.phoenixcontact.net/products or starting on page 259.
The maximum torque for the screw flange is 0.3 Nm.
¹⁾ Please observe the derating curves. Derating curves of further combination options on request.



Featuring engagement noses for locking with plugs with a self-locking flange



Dimensional drawing



Note derating curves

Derating curves, determined as per DIN EN 61984 (VDE 0627):2002-09
Representation based on DIN EN 60512-5-2:2003-01
Connected conductor cross section = 2.5 mm²
Reduction factor = 0.8
Number of positions = see diagram

Accessories		
For all types	Type	Page
	Coding section CR-MSTB Order No. 1734401	38
	Marker cards SK 5,08/3,8	798
	Screwdriver SZS 0,4 x 2,5 Order No. 1205037	
	Module pin contact ICC-MT...	827
	Crimping pliers for 0.5 to 2.5 mm ² CRIMPFOX MT 2,5 Order No. 1204038	
	Pullout aid STZ...MSTBC-5,08	828

Technical data

Technical data in accordance to IEC / DIN VDE	
Rated current / conductor cross section	[A] / [mm ²]
Rated insulation voltage for pollution degree 2	[V]
Pitch	[mm]
Connection capacity	
Solid / stranded	[mm ²] / [mm ²] / AWG
Stranded with ferrules without plastic sleeve	[mm ²]
Stranded with ferrules with plastic sleeve	[mm ²]
Multi-conductor connection capacity (two conductors with the same cross section)	
Solid / stranded	[mm ²]
Stranded with ferrules without plastic sleeve	[mm ²]
Stranded with TWIN ferrule with plastic sleeve	[mm ²]
Insulation coordination	
Surge voltage category / pollution degree	III / 3 III / 2 II / 2
Rated insulation voltage	[V] 250 320 630
Rated surge voltage	[kV] 4 4 4
Approval data (UL/CUL)	Use Group B C D
Nominal voltage	[V] 250 - 300
Nominal current	[A] 10 - 10
Connection capacity AWG	AWG 20 - 14 - 20 - 14
Approval data (CSA)	Use Group B C D
Nominal voltage	[V] - - -
Nominal current	[A] - - -
Connection capacity AWG	AWG - - -
General data	
Type of insulation material / insulation material group	PA / I
Inflammability class according to UL 94	V0

Ordering data

Type	Order No.	Pcs. / Pkt.
5.08 mm pitch, color: green		
ICC 2,5/ 2-STZ-5,08	1823846	50
ICC 2,5/ 3-STZ-5,08	1823859	50
ICC 2,5/ 4-STZ-5,08	1823862	50
ICC 2,5/ 5-STZ-5,08	1823875	50
ICC 2,5/ 6-STZ-5,08	1823888	50
ICC 2,5/ 7-STZ-5,08	1823891	50
ICC 2,5/ 8-STZ-5,08	1823901	50
ICC 2,5/ 9-STZ-5,08	1823914	50
ICC 2,5/10-STZ-5,08	1823927	50
ICC 2,5/11-STZ-5,08	1823930	50
ICC 2,5/12-STZ-5,08	1823943	50
ICC 2,5/13-STZ-5,08	1823956	50
ICC 2,5/14-STZ-5,08	1823969	50
ICC 2,5/15-STZ-5,08	1823972	50
ICC 2,5/16-STZ-5,08	1823985	50

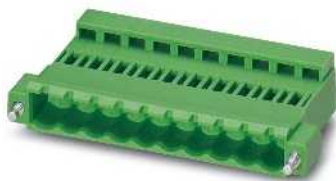

With screw flange, for screw connection using inverted headers



Dimensional drawing

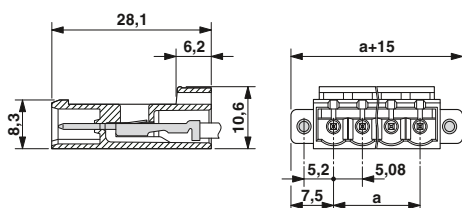

Representative derating curve

Type: ICC 2,5/...-ST-5,08 with IC 2,5/...-G-5,08

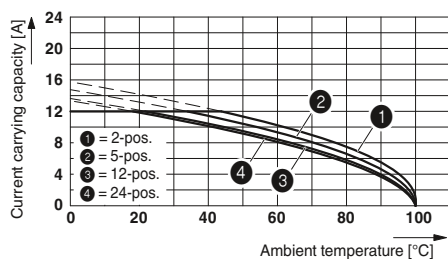

Ordering data

Type	Order No.	Pcs. / Pkt.
5.08 mm pitch, color: green		
ICC 2,5/ 2-STZF-5,08	1823383	50
ICC 2,5/ 3-STZF-5,08	1823396	50
ICC 2,5/ 4-STZF-5,08	1823406	50
ICC 2,5/ 5-STZF-5,08	1823419	50
ICC 2,5/ 6-STZF-5,08	1823422	50
ICC 2,5/ 7-STZF-5,08	1823435	50
ICC 2,5/ 8-STZF-5,08	1823448	50
ICC 2,5/ 9-STZF-5,08	1823451	50
ICC 2,5/10-STZF-5,08	1823464	50
ICC 2,5/11-STZF-5,08	1823477	50
ICC 2,5/12-STZF-5,08	1823480	50
ICC 2,5/13-STZF-5,08	1823493	50
ICC 2,5/14-STZF-5,08	1823503	50
ICC 2,5/15-STZF-5,08	1823516	50
ICC 2,5/16-STZF-5,08	1823529	50

Classic plug-in connector with 5.0 to 7.62 mm pitch

CLASSIC COMBICON plug-in connectors, pitches 5.0 or 5.08 mm

Single-level header for reflow processes



- Application in SMT reflow processes
- Delivery form: Box packaging; bulk for small series
- 2.6 mm standard pin length, other pin lengths available on request
- Versions with engagement noses for locking plugs with self-locking flanges
- Versions with a Lock & Release mechanism and threaded flange can either be used with connectors with Lock & Release or with a screw flange
- You can find user notes and recommendations for THR procedure on page 27

Notes:

In accordance with DIN EN 61984, COMBICON plug-in connectors have no switching power. During designated use, they must not be plugged in or disconnected when carrying voltage or under load.

COMBICON select

You will find the possible plug-in connector combinations in COMBICON select at: www.phoenixcontact.net/products or starting on page 259.

CR-MSTB may only be used after reflow soldering. CR-MSTB NAT HT may also be used prior to reflow soldering.

Headers can also be used in combination with MSTB(T) 2,5 HC, MVSTB(R)(W) 2,5 HC, and FKC 2,5 HC plugs



With side panels, plug-in direction parallel to the PCB

Accessories

For all types	Type	Page
	Coding section CR-MSTB Order No. 1734401	38
	Coding section CR-MSTB NAT HT Order No. 1954362	38
	Marker cards SK 5,08/3,8	798



Dimensional drawing

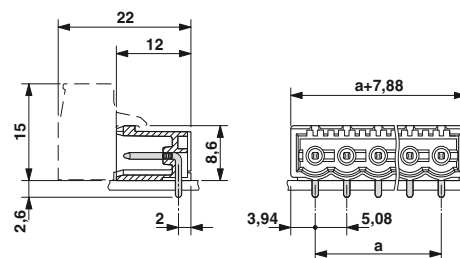

Drilling diagram

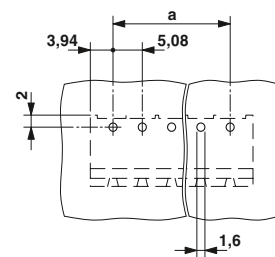

Technical data

Technical data in accordance to IEC / DIN VDE

Rated current	[A]	12
Rated insulation voltage for pollution degree 2	[V]	320
Pitch	[mm]	5.08
Insulation coordination		
Surge voltage category / pollution degree		III / 3 III / 2 II / 2
Rated insulation voltage	[V]	250 320 400
Rated surge voltage	[kV]	4 4 4
Approval data (UL/CUL)	Use Group	B C D
Nominal voltage	[V]	250 - 300
Nominal current	[A]	10 - 10
Connection capacity AWG	AWG	- - -
Approval data (CSA)	Use Group	B C D
Nominal voltage	[V]	- - -
Nominal current	[A]	- - -
Connection capacity AWG	AWG	- - -
General data		
Type of insulation material / insulation material group		LCP / IIIa
Inflammability class according to UL 94		V0
Drill hole diameter / pin dimensions	[mm]	1.6 / 1 x 1 mm

No. of pos.	Dim. a [mm]
2	5.08
3	10.16
4	15.24
5	20.32
6	25.40
7	30.48
8	35.56
9	40.64
10	45.72
11	50.80
12	55.88

Ordering data

Type	Order No.	Pcs. / Pkt.
Headers, 5.08 mm pitch, color: Black		
CCA 2,5/ 2-G-5,08 P26THR	1954919	50
CCA 2,5/ 3-G-5,08 P26THR	1954922	50
CCA 2,5/ 4-G-5,08 P26THR	1954935	50
CCA 2,5/ 5-G-5,08 P26THR	1954948	50
CCA 2,5/ 6-G-5,08 P26THR	1954951	50
CCA 2,5/ 7-G-5,08 P26THR	1954977	50
CCA 2,5/ 8-G-5,08 P26THR	1954980	50
CCA 2,5/ 9-G-5,08 P26THR	1954993	50
CCA 2,5/10-G-5,08 P26THR	1955002	50
CCA 2,5/11-G-5,08 P26THR	1955015	50
CCA 2,5/12-G-5,08 P26THR	1955028	50

Classic plug-in connector with 5.0 to 7.62 mm pitch

CLASSIC COMBICON plug-in connectors, pitches 5.0 or 5.08 mm



With engagement noses,
plug-in direction parallel to the PCB



With threaded flange,
plug-in direction parallel to the PCB



With Lock & Release mechanism and threaded
flange, plug-in direction parallel to the PCB



Dimensional drawing

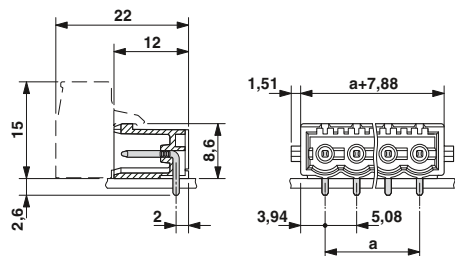

Drilling diagram

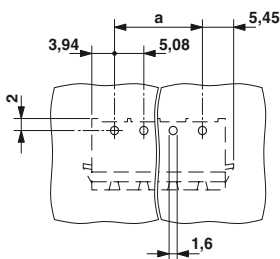

Ordering data

Type	Order No.	Pcs. / Pkt.
Headers, 5.08 mm pitch, color: Black		
CCA 2,5/ 2-G-5,08 RNP26THR	1955167	50
CCA 2,5/ 3-G-5,08 RNP26THR	1955170	50
CCA 2,5/ 4-G-5,08 RNP26THR	1955183	50
CCA 2,5/ 5-G-5,08 RNP26THR	1955196	50
CCA 2,5/ 6-G-5,08 RNP26THR	1955206	50
CCA 2,5/ 7-G-5,08 RNP26THR	1955219	50
CCA 2,5/ 8-G-5,08 RNP26THR	1955222	50
CCA 2,5/ 9-G-5,08 RNP26THR	1955235	50
CCA 2,5/10-G-5,08 RNP26THR	1955248	50
CCA 2,5/11-G-5,08 RNP26THR	1955251	50
CCA 2,5/12-G-5,08 RNP26THR	1955264	50



Dimensional drawing

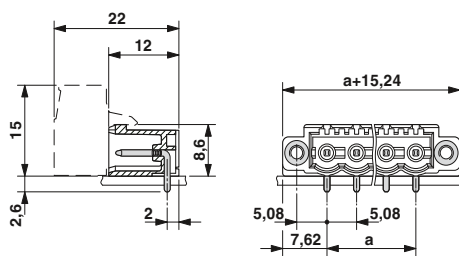

Drilling diagram

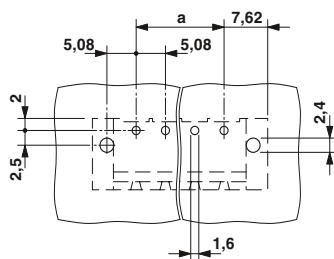

Ordering data

Type	Order No.	Pcs. / Pkt.
Headers, 5.08 mm pitch, color: Black		
CC 2,5/ 2-GF-5,08 P26THR	1954692	50
CC 2,5/ 3-GF-5,08 P26THR	1954702	50
CC 2,5/ 4-GF-5,08 P26THR	1954715	50
CC 2,5/ 5-GF-5,08 P26THR	1954728	50
CC 2,5/ 6-GF-5,08 P26THR	1954731	50
CC 2,5/ 7-GF-5,08 P26THR	1954744	50
CC 2,5/ 8-GF-5,08 P26THR	1954757	50
CC 2,5/ 9-GF-5,08 P26THR	1954760	50
CC 2,5/10-GF-5,08 P26THR	1954773	50
CC 2,5/11-GF-5,08 P26THR	1954786	50
CC 2,5/12-GF-5,08 P26THR	1954799	50



Dimensional drawing

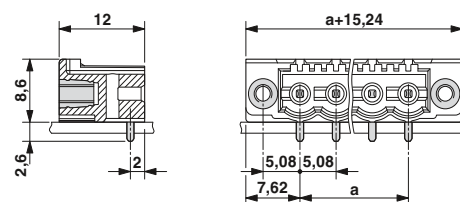

Drilling diagram

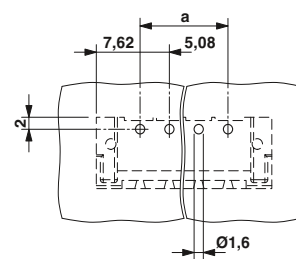

Ordering data

Type	Order No.	Pcs. / Pkt.
Headers, 5.08 mm pitch, color: Black		
CC 2,5/ 2-GF-5,08-LR P26THR	1792627	50
CC 2,5/ 3-GF-5,08-LR P26THR	1792630	50
CC 2,5/ 4-GF-5,08-LR P26THR	1792643	50
CC 2,5/ 5-GF-5,08-LR P26THR	1792656	50
CC 2,5/ 6-GF-5,08-LR P26THR	1792669	50
CC 2,5/ 7-GF-5,08-LR P26THR	1792672	50
CC 2,5/ 8-GF-5,08-LR P26THR	1792685	50
CC 2,5/ 9-GF-5,08-LR P26THR	1792698	50
CC 2,5/10-GF-5,08-LR P26THR	1792708	50
CC 2,5/11-GF-5,08-LR P26THR	1792711	50
CC 2,5/12-GF-5,08-LR P26THR	1792724	50

Classic plug-in connector with 5.0 to 7.62 mm pitch

CLASSIC COMBICON plug-in connectors, pitches 5.0 or 5.08 mm

Single-level header for reflow processes



- Application in SMT reflow processes
- Delivery form: box packaging; bulk for small series
- 2.6 mm standard pin length, other pin lengths available on request
- Versions with engagement noses for locking plugs with self-locking flanges
- Versions with a Lock & Release mechanism and threaded flange can either be used with connectors with Lock & Release or with a screw flange
- You can find user notes and recommendations for THR procedure on page 27

Notes:

In accordance with DIN EN 61984, COMBICON plug-in connectors have no switching power. During designated use, they must not be plugged in or disconnected when carrying voltage or under load.

COMBICON select

You will find the possible plug-in connector combinations in COMBICON select at: www.phoenixcontact.net/products or starting on page 259.

CR-MSTB may only be used after reflow soldering. CR-MSTB NAT HT may also be used prior to reflow soldering.

Headers can also be used in combination with MSTB(T) 2,5 HC, MVSTB(R)(W) 2,5 HC, and FKC 2,5 HC plugs



With side panels,
plug-in direction vertical to the PCB

Accessories

For all types	Type	Page
	Coding section CR-MSTB Order No. 1734401	38
	Coding section CR-MSTB NAT HT Order No. 1954362	38
	Marker cards SK 5,08/3,8	798



Dimensional drawing

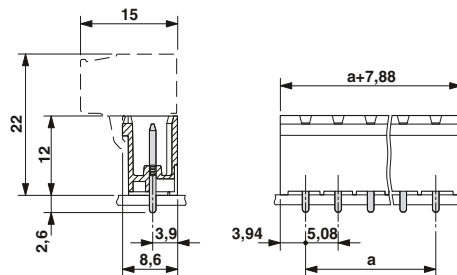

Drilling diagram

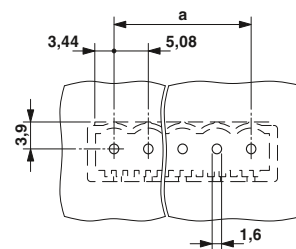

Technical data

Technical data in accordance to IEC / DIN VDE

Rated current	[A]	12
Rated insulation voltage for pollution degree 2	[V]	320
Pitch	[mm]	5.08
Insulation coordination		
Surge voltage category / pollution degree		III / 3 III / 2 II / 2
Rated insulation voltage	[V]	250 320 400
Rated surge voltage	[kV]	4 4 4
Approval data (UL/CUL)	Use Group	B C D
Nominal voltage	[V]	250 - 300
Nominal current	[A]	10 - 10
Connection capacity AWG	AWG	- - -
Approval data (CSA)	Use Group	B C D
Nominal voltage	[V]	- - -
Nominal current	[A]	- - -
Connection capacity AWG	AWG	- - -
General data		
Type of insulation material / insulation material group		LCP / IIIa
Inflammability class according to UL 94		V0
Drill hole diameter / pin dimensions	[mm]	1.6 / 1 x 1 mm

Ordering data

No. of pos.	Dim. a [mm]	Type	Order No.	Pcs. / Pkt.
Headers, 5.08 mm pitch, color: Black				
2	5.08	CCVA 2,5/ 2-G-5,08 P26THR	1955853	50
3	10.16	CCVA 2,5/ 3-G-5,08 P26THR	1955866	50
4	15.24	CCVA 2,5/ 4-G-5,08 P26THR	1955879	50
5	20.32	CCVA 2,5/ 5-G-5,08 P26THR	1955882	50
6	25.40	CCVA 2,5/ 6-G-5,08 P26THR	1955895	50
7	30.48	CCVA 2,5/ 7-G-5,08 P26THR	1955905	50
8	35.56	CCVA 2,5/ 8-G-5,08 P26THR	1955918	50
9	40.64	CCVA 2,5/ 9-G-5,08 P26THR	1955921	50
10	45.72	CCVA 2,5/10-G-5,08 P26THR	1955934	50
11	50.80	CCVA 2,5/11-G-5,08 P26THR	1955947	50
12	55.88	CCVA 2,5/12-G-5,08 P26THR	1955950	50

Classic plug-in connector with 5.0 to 7.62 mm pitch

CLASSIC COMBICON plug-in connectors, pitches 5.0 or 5.08 mm



With engagement noses,
plug-in direction vertical to the PCB



With threaded flange,
plug-in direction vertical to the PCB



With Lock & Release mechanism and threaded
flange, plug-in direction vertical to the PCB



Dimensional drawing

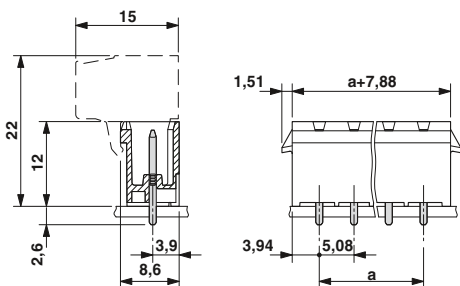

Drilling diagram

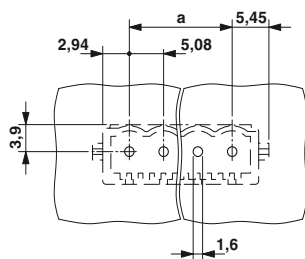

Dimensional drawing

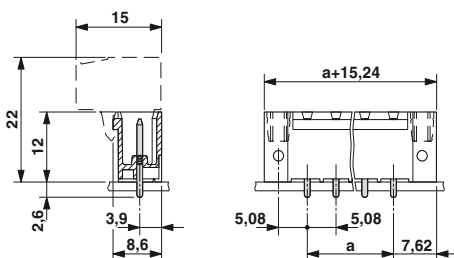

Drilling diagram

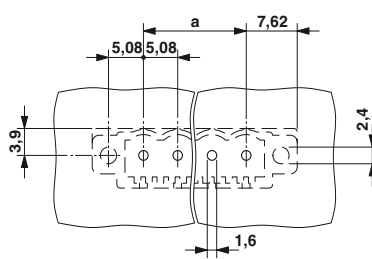

Dimensional drawing

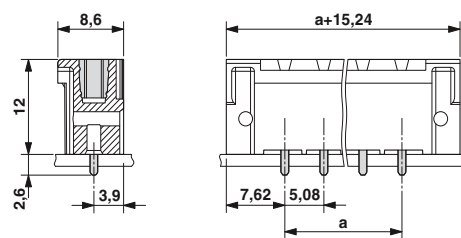

Drilling diagram

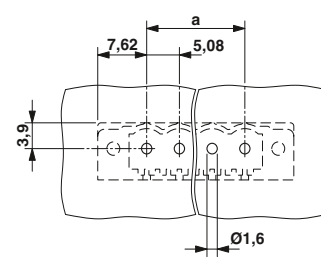

Ordering data

Type	Order No.	Pcs. / Pkt.
Headers, 5.08 mm pitch, color: Black		
CCVA 2,5/ 2-G-5,08 RNP26THR	1956085	50
CCVA 2,5/ 3-G-5,08 RNP26THR	1956098	50
CCVA 2,5/ 4-G-5,08 RNP26THR	1956108	50
CCVA 2,5/ 5-G-5,08 RNP26THR	1956111	50
CCVA 2,5/ 6-G-5,08 RNP26THR	1956124	50
CCVA 2,5/ 7-G-5,08 RNP26THR	1956137	50
CCVA 2,5/ 8-G-5,08 RNP26THR	1956140	50
CCVA 2,5/ 9-G-5,08 RNP26THR	1956153	50
CCVA 2,5/10-G-5,08 RNP26THR	1956166	50
CCVA 2,5/11-G-5,08 RNP26THR	1956179	50
CCVA 2,5/12-G-5,08 RNP26THR	1956182	50

Ordering data

Type	Order No.	Pcs. / Pkt.
Headers, 5.08 mm pitch, color: Black		
CCV 2,5/ 2-GF-5,08 P26THR	1955633	50
CCV 2,5/ 3-GF-5,08 P26THR	1955646	50
CCV 2,5/ 4-GF-5,08 P26THR	1955659	50
CCV 2,5/ 5-GF-5,08 P26THR	1955662	50
CCV 2,5/ 6-GF-5,08 P26THR	1955675	50
CCV 2,5/ 7-GF-5,08 P26THR	1955688	50
CCV 2,5/ 8-GF-5,08 P26THR	1955691	50
CCV 2,5/ 9-GF-5,08 P26THR	1955701	50
CCV 2,5/10-GF-5,08 P26THR	1955714	50
CCV 2,5/11-GF-5,08 P26THR	1955727	50
CCV 2,5/12-GF-5,08 P26THR	1955730	50

Ordering data

Type	Order No.	Pcs. / Pkt.
Headers, 5.08 mm pitch, color: Black		
CCV 2,5/ 2-GF-5,08-LR P26THR	1792737	50
CCV 2,5/ 3-GF-5,08-LR P26THR	1792740	50
CCV 2,5/ 4-GF-5,08-LR P26THR	1792753	50
CCV 2,5/ 5-GF-5,08-LR P26THR	1792766	50
CCV 2,5/ 6-GF-5,08-LR P26THR	1792779	50
CCV 2,5/ 7-GF-5,08-LR P26THR	1792782	50
CCV 2,5/ 8-GF-5,08-LR P26THR	1792795	50
CCV 2,5/ 9-GF-5,08-LR P26THR	1792805	50
CCV 2,5/10-GF-5,08-LR P26THR	1792818	50
CCV 2,5/11-GF-5,08-LR P26THR	1792821	50
CCV 2,5/12-GF-5,08-LR P26THR	1792834	50

Classic plug-in connector with 5.0 to 7.62 mm pitch

CLASSIC COMBICON plug-in connectors, pitches 5.0 or 5.08 mm

Single-level header for reflow processes

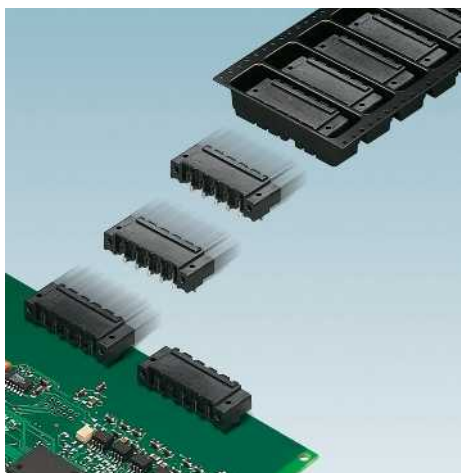

- Application in SMT reflow processes
- Delivery form: taped packaging in accordance with IEC 60286-3 for automatic assembly; coil diameter 330 mm; design width of the tape adjusted as per the corresponding number of positions of the product
- Versions with a threaded flange
- Versions with engagement noses for locking plugs with self-locking flanges
- 2.6 mm standard pin length, other pin lengths available on request
- You can find user notes and recommendations for THR procedure on page 27

Notes:

COMBICON select

You will find the possible plug-in connector combinations in COMBICON select at: www.phoenixcontact.net/products or starting on page 259.

Pick and place pads for taped THR articles usually protrude beyond the components. The PCB layout must ensure that collisions are avoided when components are assembled. Dimensional drawings of tape reels and place pads can be found online at www.phoenixcontact.net/products.

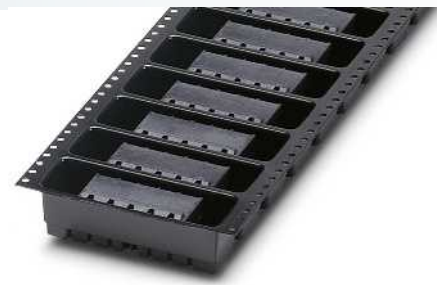

CR-MSTB may only be used after reflow soldering. CR-MSTB NAT HT may also be used prior to reflow soldering.

Headers can also be used in combination with MSTB(T) 2,5 HC, MVSTB(R)(W) 2,5 HC, and FKZ 2,5 HC plugs



Taped headers with side panels, plug-in direction parallel to the PCB

Accessories

For all types	Type	Page
	Coding section CR-MSTB Order No. 1734401	38
	Coding section CR-MSTB NAT HT Order No. 1954362	38
	Marker cards SK 5,08/3,8	798



Dimensional drawing

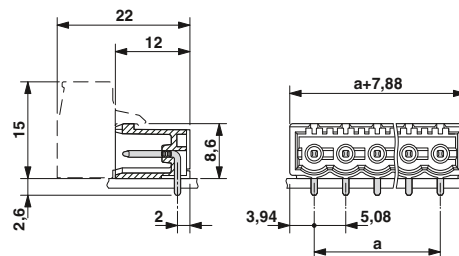

Drilling diagram

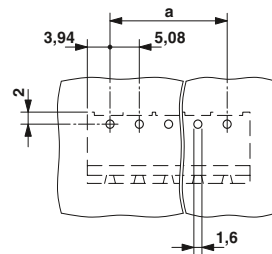

Technical data

Technical data in accordance to IEC / DIN VDE

Rated current	[A]	12
Rated insulation voltage for pollution degree 2	[V]	320
Pitch	[mm]	5.08
Insulation coordination		
Surge voltage category / pollution degree		III / 3 III / 2 II / 2
Rated insulation voltage	[V]	250 320 400
Rated surge voltage	[kV]	4 4 4
Approval data (UL/CUL)	Use Group	B C D
Nominal voltage	[V]	250 - 300
Nominal current	[A]	10 - 10
Connection capacity AWG	AWG	- - -
Approval data (CSA)	Use Group	B C D
Nominal voltage	[V]	- - -
Nominal current	[A]	- - -
Connection capacity AWG	AWG	- - -
General data		
Type of insulation material / insulation material group		LCP / IIIa
Inflammability class according to UL 94		V0
Drill hole diameter / pin dimensions	[mm]	1.6 / 1 x 1 mm

No. of pos.	Dim. a [mm]
2	5.08
3	10.16
4	15.24
5	20.32
6	25.40
7	30.48
8	35.56
9	40.64
10	45.72
11	50.80
12	55.88

Ordering data

Type	Order No.	Pcs. / Pkt.
Headers, 5.08 mm pitch, color: Black		
CCA 2,5/ 2-G-5,08 P26THRR32	1955031	330
CCA 2,5/ 3-G-5,08 P26THRR32	1955044	330
CCA 2,5/ 4-G-5,08 P26THRR56	1955057	330
CCA 2,5/ 5-G-5,08 P26THRR56	1955060	330
CCA 2,5/ 6-G-5,08 P26THRR56	1955073	330
CCA 2,5/ 7-G-5,08 P26THRR56	1955086	330
CCA 2,5/ 8-G-5,08 P26THRR56	1955099	330
CCA 2,5/ 9-G-5,08 P26THRR88	1955109	240
CCA 2,5/10-G-5,08 P26THRR88	1955112	240
CCA 2,5/11-G-5,08 P26THRR88	1955125	240
CCA 2,5/12-G-5,08 P26THRR88	1955138	240

Classic plug-in connector with 5.0 to 7.62 mm pitch

CLASSIC COMBICON plug-in connectors, pitches 5.0 or 5.08 mm



Taped headers with engagement noses, plug-in direction parallel to the PCB



Taped headers with threaded flange, plug-in direction parallel to the PCB



Dimensional drawing

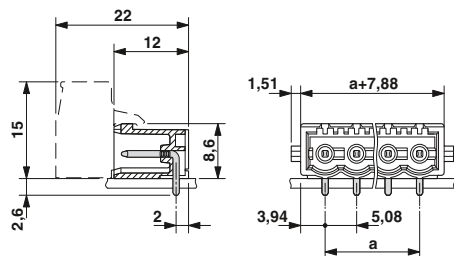

Drilling diagram

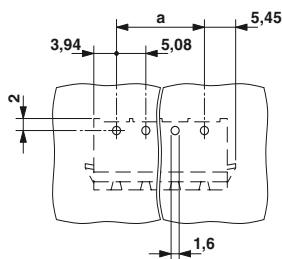

Dimensional drawing

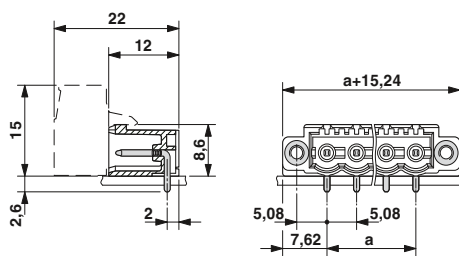

Drilling diagram

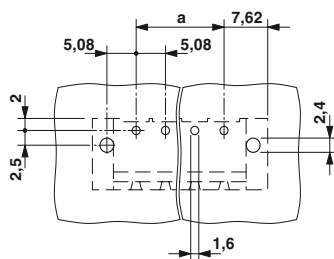

Ordering data

Type	Order No.	Pcs. / Pkt.
Headers, 5.08 mm pitch, color: Black		
CCA 2,5/ 2-G-5,08 RNP26THRR32	1955277	330
CCA 2,5/ 3-G-5,08 RNP26THRR32	1955280	330
CCA 2,5/ 4-G-5,08 RNP26THRR56	1955293	330
CCA 2,5/ 5-G-5,08 RNP26THRR56	1955303	330
CCA 2,5/ 6-G-5,08 RNP26THRR56	1955316	330
CCA 2,5/ 7-G-5,08 RNP26THRR56	1955329	330
CCA 2,5/ 8-G-5,08 RNP26THRR88	1955332	240
CCA 2,5/ 9-G-5,08 RNP26THRR88	1955345	240
CCA 2,5/10-G-5,08 RNP26THRR88	1955358	240
CCA 2,5/11-G-5,08 RNP26THRR88	1955361	240
CCA 2,5/12-G-5,08 RNP26THRR88	1955374	240

Ordering data

Type	Order No.	Pcs. / Pkt.
Headers, 5.08 mm pitch, color: Black		
CC 2,5/ 2-GF-5,08 P26THRR32	1954809	330
CC 2,5/ 3-GF-5,08 P26THRR56	1954812	330
CC 2,5/ 4-GF-5,08 P26THRR56	1954825	330
CC 2,5/ 5-GF-5,08 P26THRR56	1954838	330
CC 2,5/ 6-GF-5,08 P26THRR56	1954841	330
CC 2,5/ 7-GF-5,08 P26THRR88	1954854	240
CC 2,5/ 8-GF-5,08 P26THRR88	1954867	240
CC 2,5/ 9-GF-5,08 P26THRR88	1954870	240
CC 2,5/10-GF-5,08 P26THRR88	1954883	240
CC 2,5/11-GF-5,08 P26THRR88	1954896	240
CC 2,5/12-GF-5,08 P26THRR88	1954906	240

Classic plug-in connector with 5.0 to 7.62 mm pitch

CLASSIC COMBICON plug-in connectors, pitches 5.0 or 5.08 mm

Single-level header for reflow processes

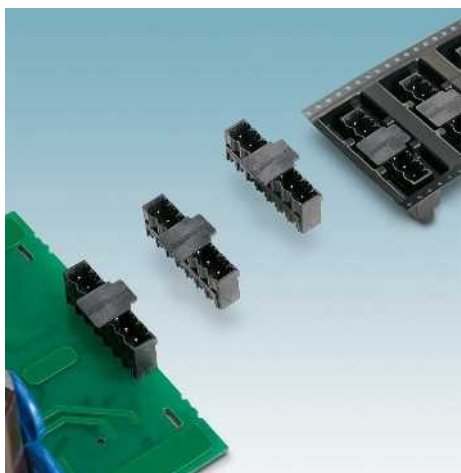

- Application in SMT reflow processes
- Delivery form: taped packaging in accordance with IEC 60286-3 for automatic assembly; coil diameter 330 mm; design width of the tape adjusted as per the corresponding number of positions of the product
- Versions with a threaded flange
- Versions with engagement noses for locking plugs with self-locking flanges
- 2.6 mm standard pin length, other pin lengths available on request
- You can find user notes and recommendations for THR procedure on page 27

Notes:

COMBICON select

You will find the possible plug-in connector combinations in COMBICON select at: www.phoenixcontact.net/products or starting on page 259.

Pick and place pads for taped THR articles usually protrude beyond the components. The PCB layout must ensure that collisions are avoided when components are assembled. Dimensional drawings of tape reels and place pads can be found online at www.phoenixcontact.net/products.

CR-MSTB may only be used after reflow soldering. CR-MSTB NAT HT may also be used prior to reflow soldering.

Headers can also be used in combination with MSTB(T) 2,5 HC, MVSTB(R)(W) 2,5 HC, and FKC 2,5 HC plugs.



Taped headers with side panels, plug-in direction vertical to the PCB



Dimensional drawing

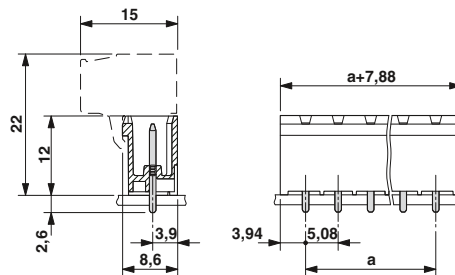

Drilling diagram

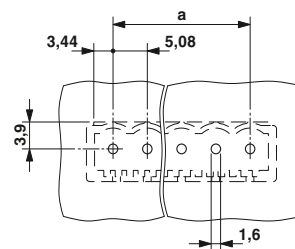

Accessories

For all types	Type	Page
	Coding section CR-MSTB Order No. 1734401	38
	Coding section CR-MSTB NAT HT Order No. 1954362	38
	Marker cards SK 5,08/3,8	798

Technical data

Technical data in accordance to IEC / DIN VDE

Rated current	[A]	12
Rated insulation voltage for pollution degree 2	[V]	320
Pitch	[mm]	5.08
Insulation coordination		
Surge voltage category / pollution degree		III / 3 III / 2 II / 2
Rated insulation voltage	[V]	250 320 400
Rated surge voltage	[kV]	4 4 4
Approval data (UL/CUL)	Use Group	B C D
Nominal voltage	[V]	250 - 300
Nominal current	[A]	10 - 10
Connection capacity AWG	AWG	- - -
Approval data (CSA)	Use Group	B C D
Nominal voltage	[V]	- - -
Nominal current	[A]	- - -
Connection capacity AWG	AWG	- - -
General data		
Type of insulation material / insulation material group		LCP / IIIa
Inflammability class according to UL 94		V0
Drill hole diameter / pin dimensions	[mm]	1.6 / 1 x 1 mm

Ordering data

No. of pos.	Dim. a [mm]	Type	Order No.	Pcs. / Pkt.
Headers, 5.08 mm pitch, color: Black				
2	5.08	CCVA 2,5/ 2-G-5,08 P26THRR32	1955963	140
3	10.16	CCVA 2,5/ 3-G-5,08 P26THRR32	1955976	140
4	15.24	CCVA 2,5/ 4-G-5,08 P26THRR56	1955989	140
5	20.32	CCVA 2,5/ 5-G-5,08 P26THRR56	1955992	140
6	25.40	CCVA 2,5/ 6-G-5,08 P26THRR56	1956001	140
7	30.48	CCVA 2,5/ 7-G-5,08 P26THRR56	1956014	140
8	35.56	CCVA 2,5/ 8-G-5,08 P26THRR56	1956027	140
9	40.64	CCVA 2,5/ 9-G-5,08 P26THRR88	1956030	140
10	45.72	CCVA 2,5/10-G-5,08 P26THRR88	1956043	140
11	50.80	CCVA 2,5/11-G-5,08 P26THRR88	1956056	140
12	55.88	CCVA 2,5/12-G-5,08 P26THRR88	1956069	140

Classic plug-in connector with 5.0 to 7.62 mm pitch

CLASSIC COMBICON plug-in connectors, pitches 5.0 or 5.08 mm



Taped headers with engagement noses,
plug-in direction vertical to the PCB



Taped headers with threaded flange,
plug-in direction vertical to the PCB



Dimensional drawing

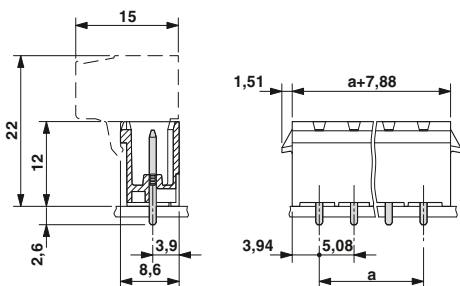

Drilling diagram

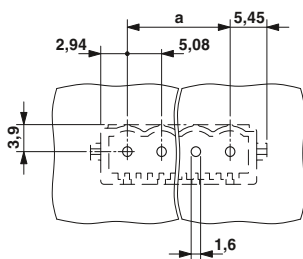

Ordering data

Type	Order No.	Pcs. / Pkt.
Headers, 5.08 mm pitch, color: Black		
CCVA 2,5/ 2-G-5,08RNP26THRR32	1956195	140
CCVA 2,5/ 3-G-5,08RNP26THRR32	1956205	140
CCVA 2,5/ 4-G-5,08RNP26THRR56	1956218	140
CCVA 2,5/ 5-G-5,08RNP26THRR56	1956221	140
CCVA 2,5/ 6-G-5,08RNP26THRR56	1956234	140
CCVA 2,5/ 7-G-5,08RNP26THRR56	1956247	140
CCVA 2,5/ 8-G-5,08RNP26THRR88	1956250	140
CCVA 2,5/ 9-G-5,08RNP26THRR88	1956263	140
CCVA 2,5/10-G-5,08RNP26THRR88	1956276	140
CCVA 2,5/11-G-5,08RNP26THRR88	1956289	140
CCVA 2,5/12-G-5,08RNP26THRR88	1956292	140



Dimensional drawing

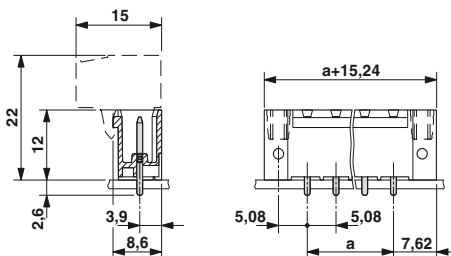

Drilling diagram

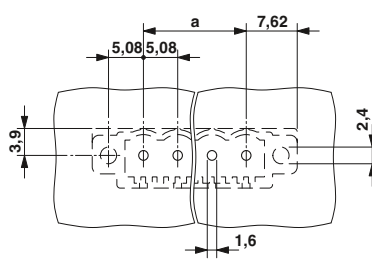

Ordering data

Type	Order No.	Pcs. / Pkt.
Headers, 5.08 mm pitch, color: Black		
CCV 2,5/ 2-GF-5,08 P26THRR32	1955743	140
CCV 2,5/ 3-GF-5,08 P26THRR56	1955756	140
CCV 2,5/ 4-GF-5,08 P26THRR56	1955769	140
CCV 2,5/ 5-GF-5,08 P26THRR56	1955772	140
CCV 2,5/ 6-GF-5,08 P26THRR56	1955785	140
CCV 2,5/ 7-GF-5,08 P26THRR88	1955798	140
CCV 2,5/ 8-GF-5,08 P26THRR88	1955808	140
CCV 2,5/ 9-GF-5,08 P26THRR88	1955811	140
CCV 2,5/10-GF-5,08 P26THRR88	1955824	140
CCV 2,5/11-GF-5,08 P26THRR88	1955837	140
CCV 2,5/12-GF-5,08 P26THRR88	1955840	140

Classic plug-in connector with 5.0 to 7.62 mm pitch

CLASSIC COMBICON plug-in connectors, pitches 5.0 or 5.08 mm

Double-level header for reflow processes

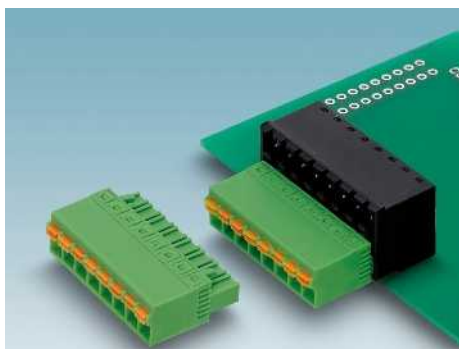

- Application in SMT reflow processes
- Double-level base strip without offset levels
- Less space requirements on the PCB
- Plug-in direction parallel to the PCB
- Versions with and without a threaded flange
- Can be combined particularly with the FKCN 2,5 compact spring-cage plug component
- 2.6 mm standard pin length
- Higher numbers of positions up to 18-pos. can be found at: www.phoenixcontact.net/products

Notes:

In accordance with DIN EN 61984, COMBICON plug-in connectors have no switching power. During designated use, they must not be plugged in or disconnected when carrying voltage or under load.

COMBICON select

You will find the possible plug-in connector combinations in COMBICON select at: www.phoenixcontact.net/products or starting on page 259.

Application notes and suggestions for the THR process can be found on page 27.

CR-MSTB may only be used after reflow soldering. CR-MSTB NAT HT may also be used prior to reflow soldering.

¹⁾ UL/CUL on request.

Accessories

For all types	Type	Page
	Coding section CR-MSTB Order No. 1734401	38
	Coding section CR-MSTB NAT HT Order No. 1954362	38
	Marker cards SK 5/3,8 or SK 5,08/3,8	798



Double-level header, plug-in direction parallel to the PCB



Dimensional drawing

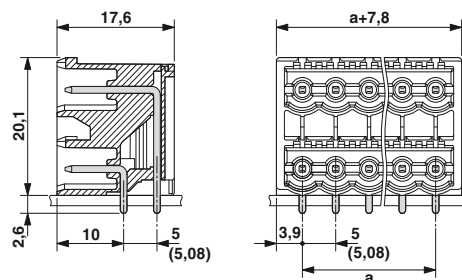

Drilling diagram

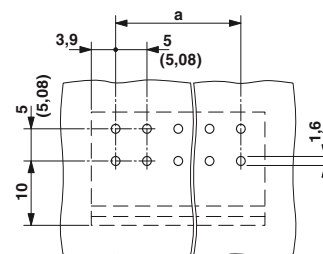

Technical data

Technical data in accordance to IEC / DIN VDE	
Rated current	[A] 12
Rated insulation voltage for pollution degree 2	[V] 400
Pitch	[mm] 5 / 5.08
Insulation coordination	
Surge voltage category / pollution degree	III / 3 III / 2 II / 2
Rated insulation voltage	[V] 320 400 400
Rated surge voltage	[kV] 4 4 4
Approval data (UL/CUL)	Use Group B C D
Nominal voltage	[V] - - -
Nominal current	[A] - - -
Connection capacity AWG	AWG - - -
Approval data (CSA)	Use Group B C D
Nominal voltage	[V] - - -
Nominal current	[A] - - -
Connection capacity AWG	AWG - - -
General data	
Type of insulation material / insulation material group	LCP / IIIa
Inflammability class according to UL 94	V0
Drill hole diameter / pin dimensions	[mm] 1.6 / 1 x 1

Ordering data

No. of pos.	Dim. a [mm]	Type	Order No.	Pcs. / Pkt.
Pitch 5.0 mm, color: Black				
2	5.00	CCDN 2,5/ 2-G1 P26 THR	1734280	50
3	10.00	CCDN 2,5/ 3-G1 P26 THR	1734287	50
4	15.00	CCDN 2,5/ 4-G1 P26 THR	1734290	50
5	20.00	CCDN 2,5/ 5-G1 P26 THR	1734300	50
6	25.00	CCDN 2,5/ 6-G1 P26 THR	1734313	50
7	30.00	CCDN 2,5/ 7-G1 P26 THR	1734326	50
8	35.00	CCDN 2,5/ 8-G1 P26 THR	1734339	50
9	40.00	CCDN 2,5/ 9-G1 P26 THR	1734342	50
10	45.00	CCDN 2,5/10-G1 P26 THR	1734355	50
11	50.00	CCDN 2,5/11-G1 P26 THR	1734368	50
12	55.00	CCDN 2,5/12-G1 P26 THR	1734371	50
13	60.00	CCDN 2,5/13-G1 P26 THR	1734384	50
14	65.00	CCDN 2,5/14-G1 P26 THR	1734397	50
15	70.00	CCDN 2,5/15-G1 P26 THR	1734407	50
16	75.00	CCDN 2,5/16-G1 P26 THR	1734410	50
Headers, 5.08 mm pitch, color: Black				
2	5.08	CCDN 2,5/ 2-G1-5,08 P26 THR	1753132	50
3	10.16	CCDN 2,5/ 3-G1-5,08 P26 THR	1753145	50
4	15.24	CCDN 2,5/ 4-G1-5,08 P26 THR	1753158	50
5	20.32	CCDN 2,5/ 5-G1-5,08 P26 THR	1753161	50
6	25.40	CCDN 2,5/ 6-G1-5,08 P26 THR	1753174	50
7	30.48	CCDN 2,5/ 7-G1-5,08 P26 THR	1753187	50
8	35.56	CCDN 2,5/ 8-G1-5,08 P26 THR	1753190	50
9	40.64	CCDN 2,5/ 9-G1-5,08 P26 THR	1753200	50
10	45.72	CCDN 2,5/10-G1-5,08 P26 THR	1753213	50
11	50.80	CCDN 2,5/11-G1-5,08 P26 THR	1753226	50
12	55.88	CCDN 2,5/12-G1-5,08 P26 THR	1753239	50
13	60.96	CCDN 2,5/13-G1-5,08 P26 THR	1753242	50
14	66.04	CCDN 2,5/14-G1-5,08 P26 THR	1753255	50
15	71.12	CCDN 2,5/15-G1-5,08 P26 THR	1753268	50
16	76.20	CCDN 2,5/16-G1-5,08 P26 THR	1753271	50



Double-level header, with threaded flange,
 plug-in direction parallel to the PCB



Dimensional drawing

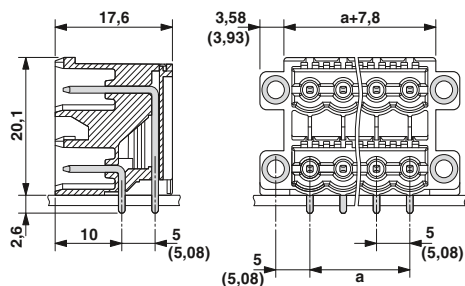

Drilling diagram

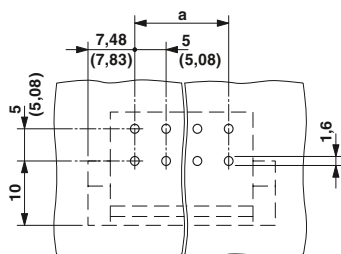

Ordering data

Type	Order No.	Pcs. / Pkt.
Pitch 5.0 mm, color: Black		
CCDN 2,5/ 2-G1F P26 THR	1734449	50
CCDN 2,5/ 3-G1F P26 THR	1734452	50
CCDN 2,5/ 4-G1F P26 THR	1734465	50
CCDN 2,5/ 5-G1F P26 THR	1734478	50
CCDN 2,5/ 6-G1F P26 THR	1734481	50
CCDN 2,5/ 7-G1F P26 THR	1734494	50
CCDN 2,5/ 8-G1F P26 THR	1734504	50
CCDN 2,5/ 9-G1F P26 THR	1734517	50
CCDN 2,5/10-G1F P26 THR	1734520	50
CCDN 2,5/11-G1F P26 THR	1734533	50
CCDN 2,5/12-G1F P26 THR	1734546	50
CCDN 2,5/13-G1F P26 THR	1734559	50
CCDN 2,5/14-G1F P26 THR	1734562	50
CCDN 2,5/15-G1F P26 THR	1734575	50
CCDN 2,5/16-G1F P26 THR	1734588	50
Headers, 5.08 mm pitch, color: Black		
CCDN 2,5/ 2-G1F-5,08 P26 THR	1753307	50
CCDN 2,5/ 3-G1F-5,08 P26 THR	1753310	50
CCDN 2,5/ 4-G1F-5,08 P26 THR	1753323	50
CCDN 2,5/ 5-G1F-5,08 P26 THR	1753336	50
CCDN 2,5/ 6-G1F-5,08 P26 THR	1753349	50
CCDN 2,5/ 7-G1F-5,08 P26 THR	1753352	50
CCDN 2,5/ 8-G1F-5,08 P26 THR	1753365	50
CCDN 2,5/ 9-G1F-5,08 P26 THR	1753378	50
CCDN 2,5/10-G1F-5,08 P26 THR	1753381	50
CCDN 2,5/11-G1F-5,08 P26 THR	1753394	50
CCDN 2,5/12-G1F-5,08 P26 THR	1753404	50
CCDN 2,5/13-G1F-5,08 P26 THR	1753417	50
CCDN 2,5/14-G1F-5,08 P26 THR	1753420	50
CCDN 2,5/15-G1F-5,08 P26 THR	1753433	50
CCDN 2,5/16-G1F-5,08 P26 THR	1753446	50

Classic plug-in connector with 5.0 to 7.62 mm pitch

CLASSIC COMBICON plug-in connectors, pitches 5.0 or 5.08 mm

Orthogonal header for reflow processes



- Orthogonal headers for the through-hole reflow process
- Made of highly temperature-resistant polyamide for use in lead-free solder processes
- Integrated suction surface for Pick and Place
- Standard form of delivery: taped, loose as an option
- For ME/ME MAX electronic housing
- Plug-in direction orthogonal to the PCB
- 2-, 3- and 4-pos.
- Pitch 5 mm
- Connection cross section of up to 2.5 mm²

Notes:

In accordance with DIN EN 61984, COMBICON plug-in connectors have no switching power. During designated use, they must not be plugged in or disconnected when carrying voltage or under load.

COMBICON select

You will find the possible plug-in connector combinations in COMBICON select at: www.phoenixcontact.net/products or starting on page 259.



Pin strip leading off at a right angle "left"

Accessories

For all types	Type	Page
	Coding section CR-MSTB NAT HT Order No. 1954362	38



Dimensional drawing

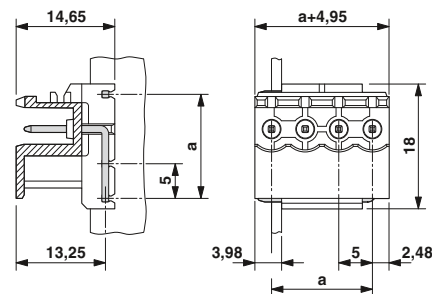

Drilling diagram

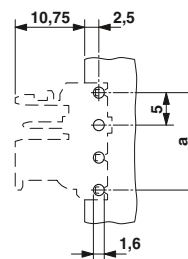

Technical data

Technical data in accordance to IEC / DIN VDE

Rated current	[A]	16
Rated insulation voltage for pollution degree 2	[V]	320
Pitch	[mm]	5
Insulation coordination		
Surge voltage category / pollution degree		III / 3 III / 2 II / 2
Rated insulation voltage	[V]	250 320 400
Rated surge voltage	[kV]	4 4 4
Approval data (UL/CUL)	Use Group	B C D
Nominal voltage	[V]	300 - 300
Nominal current	[A]	12 - 10
Connection capacity AWG	AWG	- - -
Approval data (CSA)	Use Group	B C D
Nominal voltage	[V]	- - -
Nominal current	[A]	- - -
Connection capacity AWG	AWG	- - -
General data		
Type of insulation material / insulation material group		PA / I
Inflammability class according to UL 94		V0
Drill hole diameter / pin dimensions	[mm]	1.6 / 1 x 1

Ordering data

Type	Order No.	Pcs. / Pkt.
Pitch 5.0 mm, color: Black		
MSTBO 2,5/ 2-G1L THRR32 BK	2200251	230
MSTBO 2,5/ 3 G1L THRR44 BK	2915216	170
MSTBO 2,5/ 4-G1L THRR44 BK	2697194	100



Pin strip leading off at a right angle
 "right"



Dimensional drawing

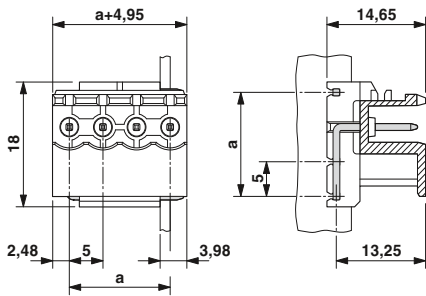

Drilling diagram

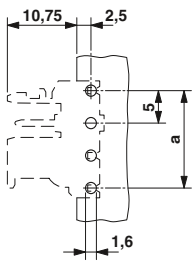

Ordering data

Type	Order No.	Pcs. / Pkt.
Pitch 5.0 mm, color: Black		
MSTBO 2,5/ 2-G1R THRR32 BK	2200252	230
MSTBO 2,5/ 3 G1R THRR44 BK	2915229	170
MSTBO 2,5/ 4-G1R THRR44 BK	2697204	100

Classic plug-in connector with 5.0 to 7.62 mm pitch

CLASSIC COMBICON plug-in connectors, pitches 5.0 or 5.08 mm

Single-level header for press-in technology

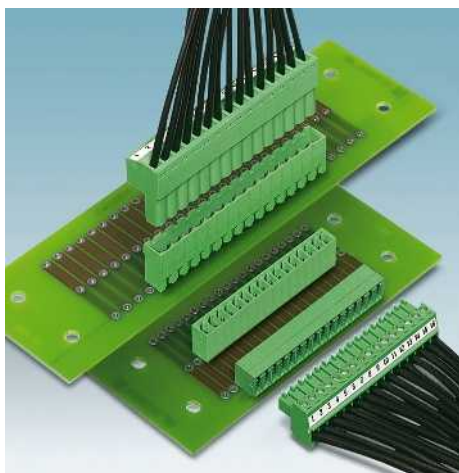

- Pin strips with flexible press-in zone ERNI-PRESS
- Processing as per EN 60352-5
- Press-in tools available on request
- Versions with and without a threaded flange
- Higher numbers of positions up to 24-pos. can be found at: www.phoenixcontact.net/products

Notes:

In accordance with DIN EN 61984, COMBICON plug-in connectors have no switching power. During designated use, they must not be plugged in or disconnected when carrying voltage or under load.

Press-in technology and the structure of the metal-plated hole are explained on page 31.

Mounting screws for base element with threaded flange (...GF...): sheet metal screw ISO 1481-ST 2,2x6,5 C or ISO 7049-ST 2,2x6,5 C.

COMBICON select

You will find the possible plug-in connector combinations in COMBICON select at: www.phoenixcontact.net/products or starting on page 259.





1) EMSTBVA 2,5/...-G from 2- to 12-pos., insulation material/insulation material group: PAI



With side panels,
plug-in direction parallel to the PCB



Accessories

For all types	Type	Page
	Marker cards SK 5/3,8 or SK 5,08/3,8	798
	Coding section CR-MSTB Order No. 1734401	38
	Coding tab MSTB-BL Order No. 1755477	837
	Stamp holder EMSTB 2,5-SH Order No. 1877203	826
Only for EMSTBVA 2,5/...-G and EMSTBV 2,5/...-GF		
	Stamp set EMSTBVA 2,5_SS-... Order No. 1877216	826

Dimensional drawing

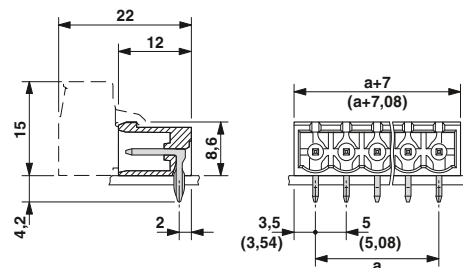

Drilling diagram

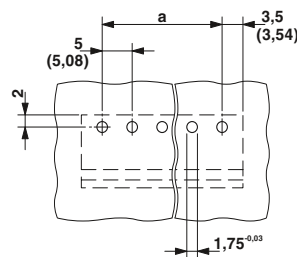

Technical data

Technical data in accordance to IEC / DIN VDE	
Rated current	[A]
Rated insulation voltage for pollution degree 2	[V]
Pitch	[mm]
Insulation coordination	
Surge voltage category / pollution degree	
Rated insulation voltage	[V]
Rated surge voltage	[kV]
Approval data (UL/CUL)	Use Group
Nominal voltage	[V]
Nominal current	[A]
Connection capacity AWG	AWG
Approval data (CSA)	Use Group
Nominal voltage	[V]
Nominal current	[A]
Connection capacity AWG	AWG
General data	
Type of insulation material / insulation material group	
Inflammability class according to UL 94	
Drill hole diameter / pin dimensions	[mm]

12		
320		
5 / 5.08		
III / 3	III / 2	II / 2
250	320	400
4	4	4
B	C	D
300	-	300
15	-	15
-	-	-
B	C	D
-	-	-
-	-	-
-	-	-
PBT / IIIa ¹⁾		
V0		
1.75 / 1.7 mm		

Ordering data

No. of pos.	Dim. a [mm]	Type	Order No.	Pcs. / Pkt.
5.0 mm pitch, color: green				
2	5.00	EMSTBA 2,5/ 2-G	1899841	50
3	10.00	EMSTBA 2,5/ 3-G	1899854	50
4	15.00	EMSTBA 2,5/ 4-G	1899867	50
5	20.00	EMSTBA 2,5/ 5-G	1899870	50
6	25.00	EMSTBA 2,5/ 6-G	1899883	50
7	30.00	EMSTBA 2,5/ 7-G	1899896	50
8	35.00	EMSTBA 2,5/ 8-G	1899906	50
9	40.00	EMSTBA 2,5/ 9-G	1899919	50
10	45.00	EMSTBA 2,5/10-G	1899922	50
11	50.00	EMSTBA 2,5/11-G	1899935	50
12	55.00	EMSTBA 2,5/12-G	1899948	50
13	60.00	EMSTBA 2,5/13-G	1899951	50
14	65.00	EMSTBA 2,5/14-G	1899964	50
15	70.00	EMSTBA 2,5/15-G	1899977	50
16	75.00	EMSTBA 2,5/16-G	1899980	50
5.08 mm pitch, color: green				
2	5.08	EMSTBA 2,5/ 2-G-5,08	1880300	50
3	10.16	EMSTBA 2,5/ 3-G-5,08	1880313	50
4	15.24	EMSTBA 2,5/ 4-G-5,08	1880326	50
5	20.32	EMSTBA 2,5/ 5-G-5,08	1880339	50
6	25.40	EMSTBA 2,5/ 6-G-5,08	1880342	50
7	30.48	EMSTBA 2,5/ 7-G-5,08	1880355	50
8	35.56	EMSTBA 2,5/ 8-G-5,08	1880368	50
9	40.64	EMSTBA 2,5/ 9-G-5,08	1880371	50
10	45.72	EMSTBA 2,5/10-G-5,08	1880384	50
11	50.80	EMSTBA 2,5/11-G-5,08	1880397	50
12	55.88	EMSTBA 2,5/12-G-5,08	1880407	50
13	60.96	EMSTBA 2,5/13-G-5,08	1880410	50
14	66.04	EMSTBA 2,5/14-G-5,08	1880423	50
15	71.12	EMSTBA 2,5/15-G-5,08	1880436	50
16	76.20	EMSTBA 2,5/16-G-5,08	1880449	50

Classic plug-in connector with 5.0 to 7.62 mm pitch

CLASSIC COMBICON plug-in connectors, pitches 5.0 or 5.08 mm



With threaded flange,
plug-in direction parallel to the PCB



With side panels,
plug-in direction vertical to the PCB



With threaded flange,
plug-in direction vertical to the PCB



Dimensional drawing

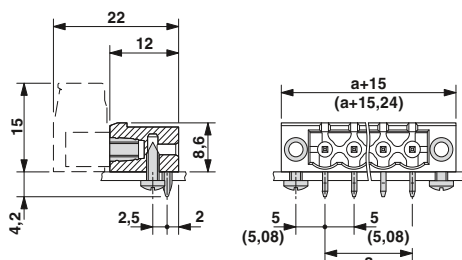

Drilling diagram

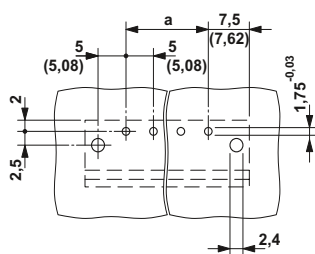

Dimensional drawing

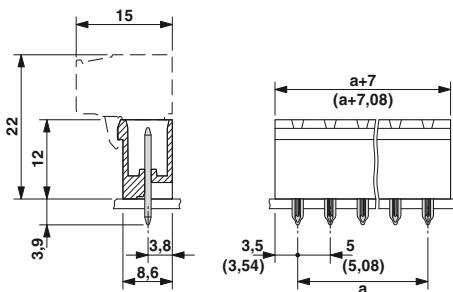

Drilling diagram

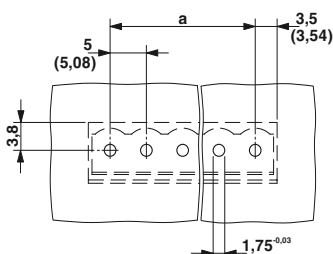

Dimensional drawing

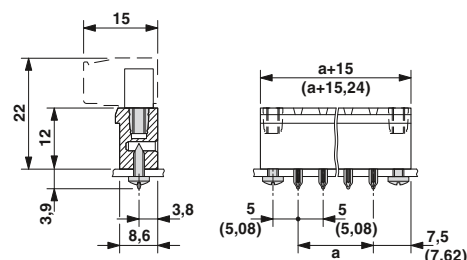

Drilling diagram

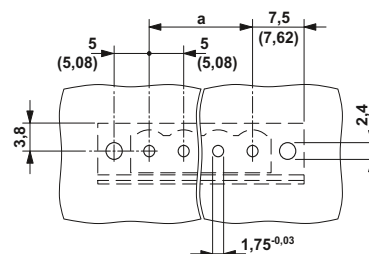

Ordering data

Type	Order No.	Pcs. / Pkt.
5.0 mm pitch, color: green		
EMSTB 2,5/ 2-GF	1900073	50
EMSTB 2,5/ 3-GF	1900086	50
EMSTB 2,5/ 4-GF	1900099	50
EMSTB 2,5/ 5-GF	1900109	50
EMSTB 2,5/ 6-GF	1900112	50
EMSTB 2,5/ 7-GF	1900125	50
EMSTB 2,5/ 8-GF	1900138	50
EMSTB 2,5/ 9-GF	1900141	50
EMSTB 2,5/10-GF	1900154	50
EMSTB 2,5/11-GF	1900167	50
EMSTB 2,5/12-GF	1900170	50
EMSTB 2,5/13-GF	1900183	50
EMSTB 2,5/14-GF	1900196	50
EMSTB 2,5/15-GF	1900206	50
EMSTB 2,5/16-GF	1900219	50
5.08 mm pitch, color: green		
EMSTB 2,5/ 2-GF-5,08	1899618	50
EMSTB 2,5/ 3-GF-5,08	1899621	50
EMSTB 2,5/ 4-GF-5,08	1899634	50
EMSTB 2,5/ 5-GF-5,08	1899647	50
EMSTB 2,5/ 6-GF-5,08	1899650	50
EMSTB 2,5/ 7-GF-5,08	1899663	50
EMSTB 2,5/ 8-GF-5,08	1899676	50
EMSTB 2,5/ 9-GF-5,08	1899689	50
EMSTB 2,5/10-GF-5,08	1899692	50
EMSTB 2,5/11-GF-5,08	1899702	50
EMSTB 2,5/12-GF-5,08	1899715	50
EMSTB 2,5/13-GF-5,08	1899728	50
EMSTB 2,5/14-GF-5,08	1899731	50
EMSTB 2,5/15-GF-5,08	1899744	50
EMSTB 2,5/16-GF-5,08	1899757	50

Ordering data

Type	Order No.	Pcs. / Pkt.
5.0 mm pitch, color: green		
EMSTBVA 2,5/ 2-G	1914852	50
EMSTBVA 2,5/ 3-G	1914865	50
EMSTBVA 2,5/ 4-G	1914878	50
EMSTBVA 2,5/ 5-G	1914881	50
EMSTBVA 2,5/ 6-G	1914894	50
EMSTBVA 2,5/ 7-G	1914904	50
EMSTBVA 2,5/ 8-G	1914917	50
EMSTBVA 2,5/ 9-G	1914920	50
EMSTBVA 2,5/10-G	1914933	50
EMSTBVA 2,5/11-G	1914946	50
EMSTBVA 2,5/12-G	1914959	50
EMSTBVA 2,5/13-G	1914962	50
EMSTBVA 2,5/14-G	1914975	50
EMSTBVA 2,5/15-G	1914988	50
EMSTBVA 2,5/16-G	1914991	50
5.08 mm pitch, color: green		
EMSTBVA 2,5/ 2-G-5,08	1859519	50
EMSTBVA 2,5/ 3-G-5,08	1859522	50
EMSTBVA 2,5/ 4-G-5,08	1859535	50
EMSTBVA 2,5/ 5-G-5,08	1859548	50
EMSTBVA 2,5/ 6-G-5,08	1859551	50
EMSTBVA 2,5/ 7-G-5,08	1859564	50
EMSTBVA 2,5/ 8-G-5,08	1859577	50
EMSTBVA 2,5/ 9-G-5,08	1859580	50
EMSTBVA 2,5/10-G-5,08	1859593	50
EMSTBVA 2,5/11-G-5,08	1859603	50
EMSTBVA 2,5/12-G-5,08	1859616	50
EMSTBVA 2,5/13-G-5,08	1859629	50
EMSTBVA 2,5/14-G-5,08	1859632	50
EMSTBVA 2,5/15-G-5,08	1859645	50
EMSTBVA 2,5/16-G-5,08	1859658	50

Ordering data

Type	Order No.	Pcs. / Pkt.
5.0 mm pitch, color: green		
EMSTBV 2,5/ 2-GF	1914055	50
EMSTBV 2,5/ 3-GF	1914068	50
EMSTBV 2,5/ 4-GF	1914071	50
EMSTBV 2,5/ 5-GF	1914084	50
EMSTBV 2,5/ 6-GF	1915107	50
EMSTBV 2,5/ 7-GF	1915110	50
EMSTBV 2,5/ 8-GF	1915123	50
EMSTBV 2,5/ 9-GF	1915136	50
EMSTBV 2,5/10-GF	1915149	50
EMSTBV 2,5/11-GF	1915152	50
EMSTBV 2,5/12-GF	1915165	50
EMSTBV 2,5/13-GF	1915178	50
EMSTBV 2,5/14-GF	1915181	50
EMSTBV 2,5/15-GF	1915194	50
EMSTBV 2,5/16-GF	1915204	50
5.08 mm pitch, color: green		
EMSTBV 2,5/ 2-GF-5,08	1915217	50
EMSTBV 2,5/ 3-GF-5,08	1898648	50
EMSTBV 2,5/ 4-GF-5,08	1915233	50
EMSTBV 2,5/ 5-GF-5,08	1915246	50
EMSTBV 2,5/ 6-GF-5,08	1915259	50
EMSTBV 2,5/ 7-GF-5,08	1915262	50
EMSTBV 2,5/ 8-GF-5,08	1915275	50
EMSTBV 2,5/ 9-GF-5,08	1915288	50
EMSTBV 2,5/10-GF-5,08	1915291	50
EMSTBV 2,5/11-GF-5,08	1915301	50
EMSTBV 2,5/12-GF-5,08	1915314	50
EMSTBV 2,5/13-GF-5,08	1915327	50
EMSTBV 2,5/14-GF-5,08	1915330	50
EMSTBV 2,5/15-GF-5,08	1915343	50
EMSTBV 2,5/16-GF-5,08	1915356	50

Classic plug-in connector with 5.0 to 7.62 mm pitch

CLASSIC COMBICON plug-in connectors, pitches 5.0 or 5.08 mm

Single-level header for the wave soldering processes

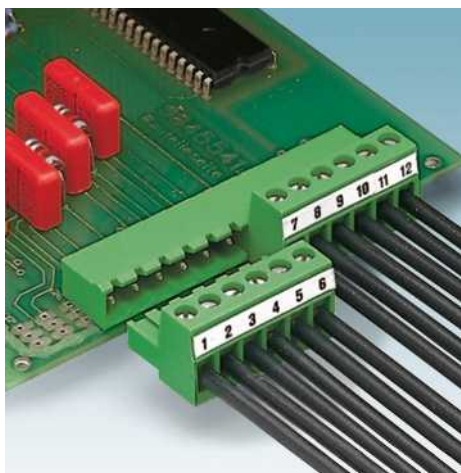

- Standard pin strip for 320 V (III/2)
- Plug-in direction parallel to the conductor axis
- Designs with and without side panel
- W-type with stand-off
- Versions with engagement noses for locking plugs with self-locking flanges
- Other pin lengths available on request
- Higher numbers of positions up to 24-pos. can be found at: www.phoenixcontact.net/products

Notes:

In accordance with DIN EN 61984, COMBICON plug-in connectors have no switching power. During designated use, they must not be plugged in or disconnected when carrying voltage or under load.

COMBICON select

You will find the possible plug-in connector combinations in COMBICON select at: www.phoenixcontact.net/products or starting on page 259.

Mounting screws for MSTB 2,5/...-GF(-5,08): sheet metal screw ISO 1481-ST 2,2x6,5 C or ISO 7049-ST 2,2x6,5 C. Screw connection only permitted prior to soldering.

1) MSTB 2,5/...-G and MSTBA 2,5/...-G from 2- to 12-pos.: insulation material/insulation material group = PA/I, more than 12-pos.: insulation material/insulation material group = PBT/IIIa.



Without side panels,
plug-in direction parallel to the PCB



Dimensional drawing

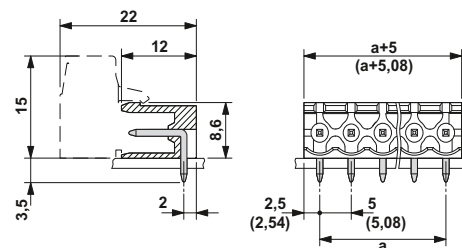

Drilling diagram

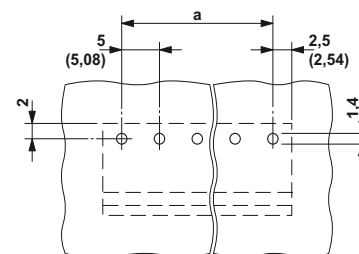

Accessories		
For all types	Type	Page
	Marker cards SK 5/3,8 or SK 5,08/3,8	798
	Coding section CR-MSTB Order No. 1734401	38
	Coding tab MSTB-BL Order No. 1755477	837
Only for MSTB 2,5/...-G		
	Mounting flange MSTB-BF Order No. 1759981	836

Technical data

Technical data in accordance to IEC / DIN VDE	
Rated current	[A] 12
Rated insulation voltage for pollution degree 2	[V] 320
Pitch	[mm] 5 / 5.08
Insulation coordination	
Surge voltage category / pollution degree	III / 3 III / 2 II / 2
Rated insulation voltage	[V] 250 320 400
Rated surge voltage	[kV] 4 4 4
Approval data (UL/CUL)	Use Group B C D
Nominal voltage	[V] 300 - 300
Nominal current	[A] 15 - 15
Connection capacity AWG	AWG - - -
Approval data (CSA)	Use Group B C D
Nominal voltage	[V] 300 - 300
Nominal current	[A] 10 - 10
Connection capacity AWG	AWG - - -
General data	
Type of insulation material / insulation material group	PBT / IIIa ¹⁾
Inflammability class according to UL 94	V0
Drill hole diameter / pin dimensions	[mm] 1.4 / 1 x 1 mm

Ordering data

No. of pos.	Dim. a [mm]	Type	Order No.	Pcs. / Pkt.
5.0 mm pitch, color: green				
2	5.00	MSTB 2,5/ 2-G	1754436	250
3	10.00	MSTB 2,5/ 3-G	1754452	250
4	15.00	MSTB 2,5/ 4-G	1754478	250
5	20.00	MSTB 2,5/ 5-G	1754494	250
6	25.00	MSTB 2,5/ 6-G	1754517	100
7	30.00	MSTB 2,5/ 7-G	1754533	100
8	35.00	MSTB 2,5/ 8-G	1754559	100
9	40.00	MSTB 2,5/ 9-G	1754575	100
10	45.00	MSTB 2,5/10-G	1754591	100
11	50.00	MSTB 2,5/11-G	1754614	50
12	55.00	MSTB 2,5/12-G	1754630	50
13	60.00	MSTB 2,5/13-G	1754656	50
14	65.00	MSTB 2,5/14-G	1754672	50
15	70.00	MSTB 2,5/15-G	1754698	50
16	75.00	MSTB 2,5/16-G	1754711	50
5.08 mm pitch, color: green				
2	5.08	MSTB 2,5/ 2-G-5,08	1759017	250
3	10.16	MSTB 2,5/ 3-G-5,08	1759020	250
4	15.24	MSTB 2,5/ 4-G-5,08	1759033	250
5	20.32	MSTB 2,5/ 5-G-5,08	1759046	250
6	25.40	MSTB 2,5/ 6-G-5,08	1759059	100
7	30.48	MSTB 2,5/ 7-G-5,08	1759062	100
8	35.56	MSTB 2,5/ 8-G-5,08	1759075	100
9	40.64	MSTB 2,5/ 9-G-5,08	1759088	100
10	45.72	MSTB 2,5/10-G-5,08	1759091	100
11	50.80	MSTB 2,5/11-G-5,08	1759101	50
12	55.88	MSTB 2,5/12-G-5,08	1759114	50
13	60.96	MSTB 2,5/13-G-5,08	1759127	50
14	66.04	MSTB 2,5/14-G-5,08	1759130	50
15	71.12	MSTB 2,5/15-G-5,08	1759143	50
16	76.20	MSTB 2,5/16-G-5,08	1759156	50

Classic plug-in connector with 5.0 to 7.62 mm pitch

CLASSIC COMBICON plug-in connectors, pitches 5.0 or 5.08 mm



Without side panels, with stand-off, plug-in direction parallel to the PCB



With side panels, plug-in direction parallel to the PCB



With engagement noses, plug-in direction parallel to the PCB



Dimensional drawing

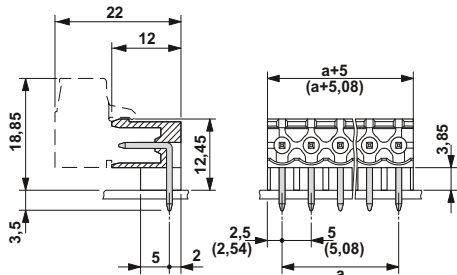

Drilling diagram

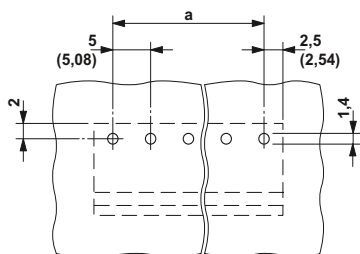

Ordering data

Type	Order No.	Pcs. / Pkt.
5.0 mm pitch, color: green		
MSTBW 2,5/ 2-G	1736111	50
MSTBW 2,5/ 3-G	1736108	50
MSTBW 2,5/ 4-G	1736098	50
MSTBW 2,5/ 5-G	1736085	50
MSTBW 2,5/ 6-G	1736072	50
MSTBW 2,5/ 7-G	1736069	50
MSTBW 2,5/ 8-G	1736056	50
MSTBW 2,5/ 9-G	1736043	50
MSTBW 2,5/10-G	1736030	50
MSTBW 2,5/11-G	1736027	50
MSTBW 2,5/12-G	1736014	50
MSTBW 2,5/13-G	1736001	50
MSTBW 2,5/14-G	1735992	50
MSTBW 2,5/15-G	1735989	50
MSTBW 2,5/16-G	1735976	50
5.08 mm pitch, color: green		
MSTBW 2,5/ 2-G-5,08	1735882	50
MSTBW 2,5/ 3-G-5,08	1735879	50
MSTBW 2,5/ 4-G-5,08	1735866	50
MSTBW 2,5/ 5-G-5,08	1735853	50
MSTBW 2,5/ 6-G-5,08	1735840	50
MSTBW 2,5/ 7-G-5,08	1735837	50
MSTBW 2,5/ 8-G-5,08	1735824	50
MSTBW 2,5/ 9-G-5,08	1735811	50
MSTBW 2,5/10-G-5,08	1735808	50
MSTBW 2,5/11-G-5,08	1735798	50
MSTBW 2,5/12-G-5,08	1735785	50
MSTBW 2,5/13-G-5,08	1735772	50
MSTBW 2,5/14-G-5,08	1735769	50
MSTBW 2,5/15-G-5,08	1735756	50
MSTBW 2,5/16-G-5,08	1735743	50



Dimensional drawing

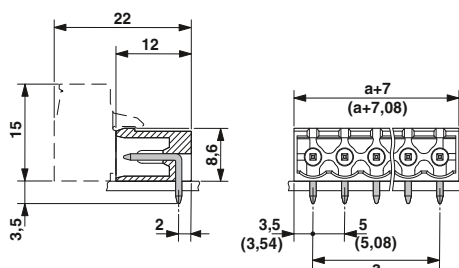

Drilling diagram

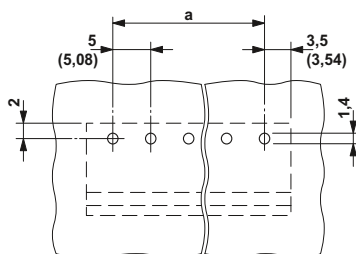

Ordering data

Type	Order No.	Pcs. / Pkt.
5.0 mm pitch, color: green		
MSTBA 2,5/ 2-G	1757475	250
MSTBA 2,5/ 3-G	1757488	250
MSTBA 2,5/ 4-G	1757491	250
MSTBA 2,5/ 5-G	1757501	250
MSTBA 2,5/ 6-G	1757514	100
MSTBA 2,5/ 7-G	1755493	100
MSTBA 2,5/ 8-G	1757527	100
MSTBA 2,5/ 9-G	1757530	100
MSTBA 2,5/10-G	1757543	100
MSTBA 2,5/11-G	1757556	50
MSTBA 2,5/12-G	1757569	50
MSTBA 2,5/13-G	1757572	50
MSTBA 2,5/14-G	1757585	50
MSTBA 2,5/15-G	1757598	50
MSTBA 2,5/16-G	1757608	50
5.08 mm pitch, color: green		
MSTBA 2,5/ 2-G-5,08	1757242	250
MSTBA 2,5/ 3-G-5,08	1757255	250
MSTBA 2,5/ 4-G-5,08	1757268	250
MSTBA 2,5/ 5-G-5,08	1757271	250
MSTBA 2,5/ 6-G-5,08	1757284	100
MSTBA 2,5/ 7-G-5,08	1757297	100
MSTBA 2,5/ 8-G-5,08	1757307	100
MSTBA 2,5/ 9-G-5,08	1757310	100
MSTBA 2,5/10-G-5,08	1757323	100
MSTBA 2,5/11-G-5,08	1757336	50
MSTBA 2,5/12-G-5,08	1757349	50
MSTBA 2,5/13-G-5,08	1757352	50
MSTBA 2,5/14-G-5,08	1757365	50
MSTBA 2,5/15-G-5,08	1757378	50
MSTBA 2,5/16-G-5,08	1757381	50

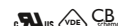

Dimensional drawing

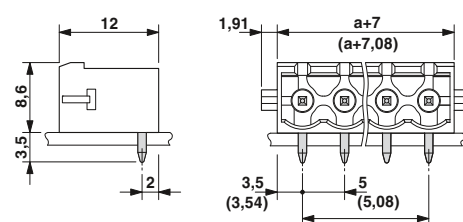

Drilling diagram

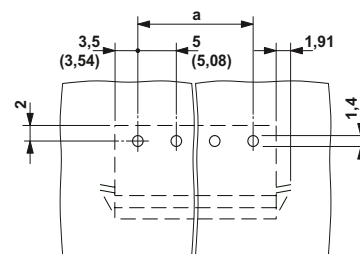

Ordering data

Type	Order No.	Pcs. / Pkt.
5.0 mm pitch, color: green		
MSTBA 2,5/ 2-G-RN	1944783	50
MSTBA 2,5/ 3-G-RN	1944796	50
MSTBA 2,5/ 4-G-RN	1944806	50
MSTBA 2,5/ 4-G-5,08-RN	1944819	50
MSTBA 2,5/ 6-G-RN	1944822	50
MSTBA 2,5/ 7-G-RN	1944835	50
MSTBA 2,5/ 8-G-RN	1944848	50
MSTBA 2,5/ 9-G-RN	1944851	50
MSTBA 2,5/10-G-RN	1944864	50
MSTBA 2,5/11-G-RN	1944877	50
MSTBA 2,5/12-G-RN	1944880	50
MSTBA 2,5/13-G-RN	1944893	50
MSTBA 2,5/14-G-RN	1944903	50
MSTBA 2,5/15-G-RN	1944916	50
MSTBA 2,5/16-G-RN	1944929	50
5.08 mm pitch, color: green		
MSTBA 2,5/ 2-G-5,08-RN	1926015	50
MSTBA 2,5/ 3-G-5,08-RN	1926028	50
MSTBA 2,5/ 4-G-5,08-RN	1926031	50
MSTBA 2,5/ 5-G-5,08-RN	1926044	50
MSTBA 2,5/ 6-G-5,08-RN	1926057	50
MSTBA 2,5/ 7-G-5,08-RN	1926060	50
MSTBA 2,5/ 8-G-5,08-RN	1926073	50
MSTBA 2,5/ 9-G-5,08-RN	1926086	50
MSTBA 2,5/10-G-5,08-RN	1926099	50
MSTBA 2,5/11-G-5,08-RN	1926109	50
MSTBA 2,5/12-G-5,08-RN	1926112	50
MSTBA 2,5/13-G-5,08-RN	1926125	50
MSTBA 2,5/14-G-5,08-RN	1926138	50
MSTBA 2,5/15-G-5,08-RN	1926141	50
MSTBA 2,5/16-G-5,08-RN	1926154	50

Classic plug-in connector with 5.0 to 7.62 mm pitch

CLASSIC COMBICON plug-in connectors, pitches 5.0 or 5.08 mm

Single-level header for the wave soldering processes

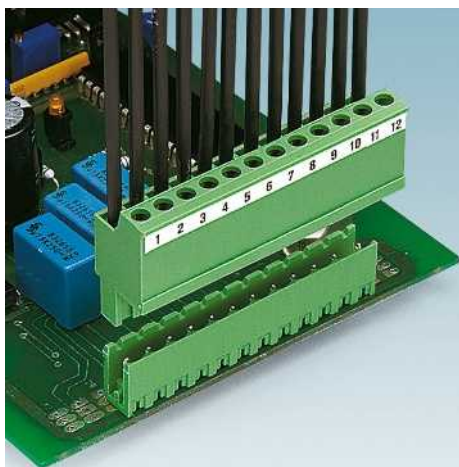

- Standard pin strip for 320 V (III/2)
- Plug-in direction parallel and vertical to the PCB
- Designs with and without side panel
- Versions with a threaded flange
- Versions with Lock & Release locking
- Other pin lengths available on request
- Higher numbers of positions up to 24-pos. can be found at:

www.phoenixcontact.net/products

Notes:

In accordance with DIN EN 61984, COMBICON plug-in connectors have no switching power. During designated use, they must not be plugged in or disconnected when carrying voltage or under load.

COMBICON select

You will find the possible plug-in connector combinations in COMBICON select at: www.phoenixcontact.net/products or starting on page 259.

Mounting screws for MSTB 2,5/...-GF(-5,08): sheet metal screw ISO 1481-ST 2,2x6,5 C or ISO 7049-ST 2,2x6,5 C. Screw connection only permitted prior to soldering.

1) MSTB 2,5/...-G and MSTBA 2,5/...-G from 2- to 12-pos.: insulation material/insulation material group = PA/I, more than 12-pos.: insulation material/insulation material group = PBT/IIIa

2) MSTBV(A) 2,5/ has 12 A in Use Group B.



With threaded flange, plug-in direction parallel to the PCB



Dimensional drawing

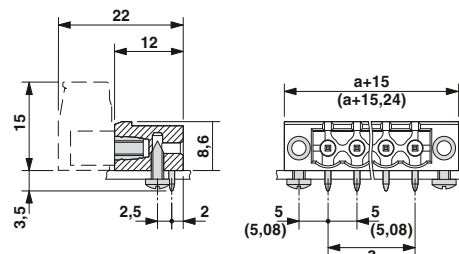

Drilling diagram

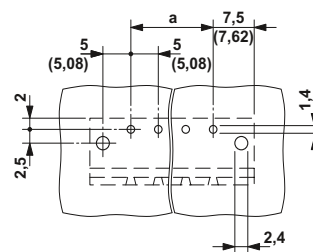

Accessories		
For all types	Type	Page
	Marker cards SK 5/3,8 or SK 5,08/3,8	798
	Coding section CR-MSTB Order No. 1734401	38
	Coding tab MSTB-BL Order No. 1755477	837
Nur für MSTBV 2,5/...-G		
	Mounting flange MSTB-BF Order No. 1759981	836

Technical data

Technical data in accordance to IEC / DIN VDE	
Rated current	[A]
Rated insulation voltage for pollution degree 2	[V]
Pitch	[mm]
Insulation coordination	
Surge voltage category / pollution degree	
Rated insulation voltage	[V]
Rated surge voltage	[kV]
Approval data (UL/CUL)	Use Group
Nominal voltage	[V]
Nominal current	[A]
Connection capacity AWG	AWG
Approval data (CSA)	Use Group
Nominal voltage	[V]
Nominal current	[A]
Connection capacity AWG	AWG
General data	
Type of insulation material / insulation material group	
Inflammability class according to UL 94	
Drill hole diameter / pin dimensions	[mm]

12			
320			
5 / 5.08			
III / 3	III / 2	II / 2	
250	320	400	
4	4	4	
B	C	D	
300	-	300	
15 ²⁾	-	15	
-	-	-	
B	C	D	
300	-	300	
10	-	10	
-	-	-	
PBT / IIIa ¹⁾			
V0			
1.4 / 1 x 1 mm			

No. of pos.	Dim. a [mm]
2	5.00
3	10.00
4	15.00
5	20.00
6	25.00
7	30.00
8	35.00
9	40.00
10	45.00
11	50.00
12	55.00
13	60.00
14	65.00
15	70.00
16	75.00

Ordering data

Type	Order No.	Pcs. / Pkt.
5.0 mm pitch, color: green		
MSTB 2,5/ 2-GF	1776692	250
MSTB 2,5/ 3-GF	1776702	250
MSTB 2,5/ 4-GF	1776715	250
MSTB 2,5/ 5-GF	1776728	250
MSTB 2,5/ 6-GF	1776731	100
MSTB 2,5/ 7-GF	1776744	100
MSTB 2,5/ 8-GF	1776757	100
MSTB 2,5/ 9-GF	1776760	100
MSTB 2,5/10-GF	1776773	100
MSTB 2,5/11-GF	1776786	50
MSTB 2,5/12-GF	1776799	50
MSTB 2,5/13-GF	1776809	50
MSTB 2,5/14-GF	1776812	50
MSTB 2,5/15-GF	1776825	50
MSTB 2,5/16-GF	1776838	50
5.08 mm pitch, color: green		
MSTB 2,5/ 2-GF-5,08	1776508	250
MSTB 2,5/ 3-GF-5,08	1776511	250
MSTB 2,5/ 4-GF-5,08	1776524	250
MSTB 2,5/ 5-GF-5,08	1776537	250
MSTB 2,5/ 6-GF-5,08	1776540	100
MSTB 2,5/ 7-GF-5,08	1776553	100
MSTB 2,5/ 8-GF-5,08	1776566	100
MSTB 2,5/ 9-GF-5,08	1776579	100
MSTB 2,5/10-GF-5,08	1776582	100
MSTB 2,5/11-GF-5,08	1776595	50
MSTB 2,5/12-GF-5,08	1776605	50
MSTB 2,5/13-GF-5,08	1776618	50
MSTB 2,5/14-GF-5,08	1776621	50
MSTB 2,5/15-GF-5,08	1776634	50
MSTB 2,5/16-GF-5,08	1776647	50

Classic plug-in connector with 5.0 to 7.62 mm pitch

CLASSIC COMBICON plug-in connectors, pitches 5.0 or 5.08 mm

Z



Lock & Release locking, plug-in direction parallel to the PCB

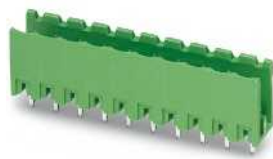

Without side panels, plug-in direction vertical to the PCB

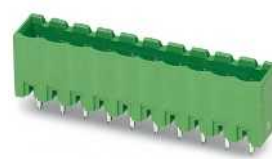

With side panels, plug-in direction vertical to the PCB



Dimensional drawing

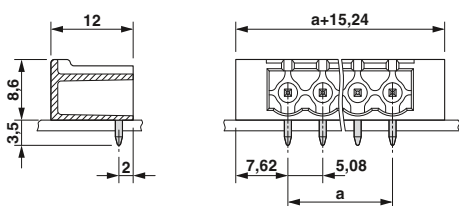

Drilling diagram

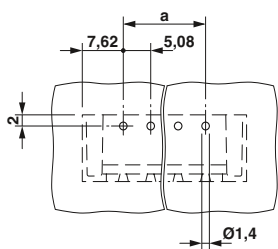

Dimensional drawing

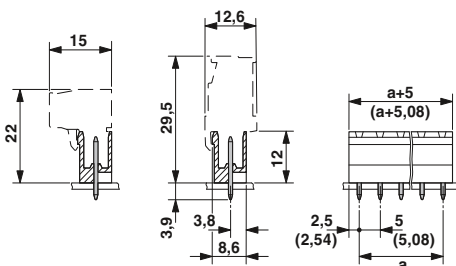

Drilling diagram

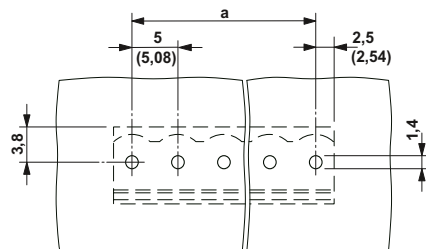

Dimensional drawing

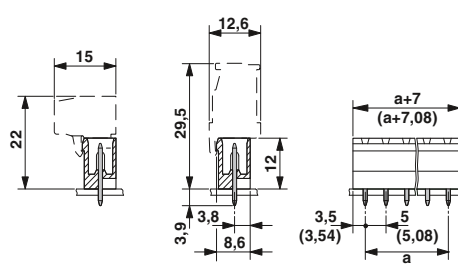

Drilling diagram

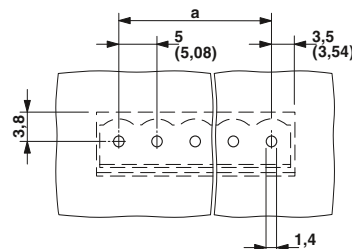

Ordering data

Type	Order No.	Pcs. / Pkt.
5.0 mm pitch, color: green		
MSTBA 2,5/ 2-G-5,08-LR	1809076	50
MSTBA 2,5/ 3-G-5,08-LR	1809089	50
MSTBA 2,5/ 4-G-5,08-LR	1809092	50
MSTBA 2,5/ 5-G-5,08-LR	1809102	50
MSTBA 2,5/ 6-G-5,08-LR	1809115	50
MSTBA 2,5/ 7-G-5,08-LR	1809128	50
MSTBA 2,5/ 8-G-5,08-LR	1809131	50
MSTBA 2,5/ 9-G-5,08-LR	1809144	50
MSTBA 2,5/10-G-5,08-LR	1809157	50
MSTBA 2,5/11-G-5,08-LR	1809160	50
MSTBA 2,5/12-G-5,08-LR	1809173	50
MSTBA 2,5/13-G-5,08-LR	1809186	50
MSTBA 2,5/14-G-5,08-LR	1809199	50
MSTBA 2,5/15-G-5,08-LR	1809209	50
MSTBA 2,5/16-G-5,08-LR	1809212	50
5.08 mm pitch, color: green		
MSTBA 2,5/ 2-G-5,08	1758018	250
MSTBA 2,5/ 3-G-5,08	1758021	250
MSTBA 2,5/ 4-G-5,08	1758034	250
MSTBA 2,5/ 5-G-5,08	1758047	250
MSTBA 2,5/ 6-G-5,08	1758050	100
MSTBA 2,5/ 7-G-5,08	1758063	100
MSTBA 2,5/ 8-G-5,08	1758076	100
MSTBA 2,5/ 9-G-5,08	1758089	100
MSTBA 2,5/10-G-5,08	1758092	100
MSTBA 2,5/11-G-5,08	1758102	50
MSTBA 2,5/12-G-5,08	1758115	50
MSTBA 2,5/13-G-5,08	1758128	50
MSTBA 2,5/14-G-5,08	1758131	50
MSTBA 2,5/15-G-5,08	1758144	50
MSTBA 2,5/16-G-5,08	1758157	50

Ordering data

Type	Order No.	Pcs. / Pkt.
5.0 mm pitch, color: green		
MSTBV 2,5/ 2-G	1753437	250
MSTBV 2,5/ 3-G	1753453	250
MSTBV 2,5/ 4-G	1753479	250
MSTBV 2,5/ 5-G	1753495	250
MSTBV 2,5/ 6-G	1753518	100
MSTBV 2,5/ 7-G	1753534	100
MSTBV 2,5/ 8-G	1753550	100
MSTBV 2,5/ 9-G	1753576	100
MSTBV 2,5/10-G	1753592	100
MSTBV 2,5/11-G	1753615	50
MSTBV 2,5/12-G	1753631	50
MSTBV 2,5/13-G	1753657	50
MSTBV 2,5/14-G	1753673	50
MSTBV 2,5/15-G	1753699	50
MSTBV 2,5/16-G	1753712	50
5.08 mm pitch, color: green		
MSTBV 2,5/ 2-G-5,08	1758018	250
MSTBV 2,5/ 3-G-5,08	1758021	250
MSTBV 2,5/ 4-G-5,08	1758034	250
MSTBV 2,5/ 5-G-5,08	1758047	250
MSTBV 2,5/ 6-G-5,08	1758050	100
MSTBV 2,5/ 7-G-5,08	1758063	100
MSTBV 2,5/ 8-G-5,08	1758076	100
MSTBV 2,5/ 9-G-5,08	1758089	100
MSTBV 2,5/10-G-5,08	1758092	100
MSTBV 2,5/11-G-5,08	1758102	50
MSTBV 2,5/12-G-5,08	1758115	50
MSTBV 2,5/13-G-5,08	1758128	50
MSTBV 2,5/14-G-5,08	1758131	50
MSTBV 2,5/15-G-5,08	1758144	50
MSTBV 2,5/16-G-5,08	1758157	50

Ordering data

Type	Order No.	Pcs. / Pkt.
5.0 mm pitch, color: green		
MSTBVA 2,5/ 2-G	1755516	250
MSTBVA 2,5/ 3-G	1755529	250
MSTBVA 2,5/ 4-G	1755532	250
MSTBVA 2,5/ 5-G	1755545	250
MSTBVA 2,5/ 6-G	1755558	100
MSTBVA 2,5/ 7-G	1755561	100
MSTBVA 2,5/ 8-G	1755574	100
MSTBVA 2,5/ 9-G	1755587	100
MSTBVA 2,5/10-G	1755503	100
MSTBVA 2,5/11-G	1755590	50
MSTBVA 2,5/12-G	1755600	50
MSTBVA 2,5/13-G	1755613	50
MSTBVA 2,5/14-G	1755626	50
MSTBVA 2,5/15-G	1755639	50
MSTBVA 2,5/16-G	1755642	50
5.08 mm pitch, color: green		
MSTBVA 2,5/ 2-G-5,08	1755736	250
MSTBVA 2,5/ 3-G-5,08	1755749	250
MSTBVA 2,5/ 4-G-5,08	1755752	250
MSTBVA 2,5/ 5-G-5,08	1755765	250
MSTBVA 2,5/ 6-G-5,08	1755778	100
MSTBVA 2,5/ 7-G-5,08	1755781	100
MSTBVA 2,5/ 8-G-5,08	1755794	100
MSTBVA 2,5/ 9-G-5,08	1755804	100
MSTBVA 2,5/10-G-5,08	1755817	100
MSTBVA 2,5/11-G-5,08	1755820	50
MSTBVA 2,5/12-G-5,08	1755833	50
MSTBVA 2,5/13-G-5,08	1755846	50
MSTBVA 2,5/14-G-5,08	1755859	50
MSTBVA 2,5/15-G-5,08	1755862	50
MSTBVA 2,5/16-G-5,08	1755875	50

Classic plug-in connector with 5.0 to 7.62 mm pitch

CLASSIC COMBICON plug-in connectors, pitches 5.0 or 5.08 mm

Single-level header for the wave soldering processes

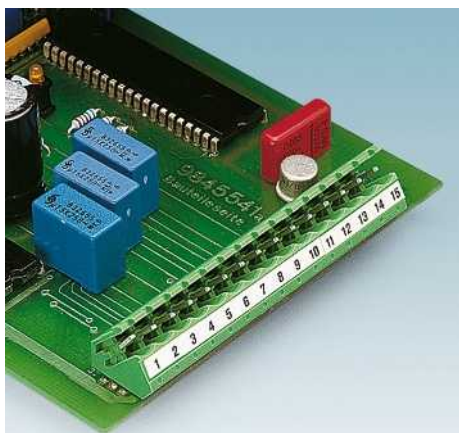

- You can find higher numbers of positions under:
www.phoenixcontact.net/products
- Versions with a threaded flange
- Versions with engagement noses for locking plugs with self-locking flanges
- Versions for Lock & Release locking
- Version with release aid

Notes:

In accordance with DIN EN 61984, COMBICON plug-in connectors have no switching power. During designated use, they must not be plugged in or disconnected when carrying voltage or under load.

COMBICON select

You will find the possible plug-in connector combinations in COMBICON select at: www.phoenixcontact.net/products or starting on page 259.



Mounting screws for MSTB 2,5/...-GF(-5,08): sheet metal screw ISO 1481-ST 2,2x6,5 C or ISO 7049-ST 2,2x6,5 C. Screw connection only permitted prior to soldering.



With engagement nose,
plug-in direction vertical to the PCB



Accessories

For all types	Type	Page
	Marker cards SK 5/3,8 or SK 5,08/3,8	798
	Coding section CR-MSTB Order No. 1734401	38
	Coding tab MSTB-BL Order No. 1755477	837

Dimensional drawing

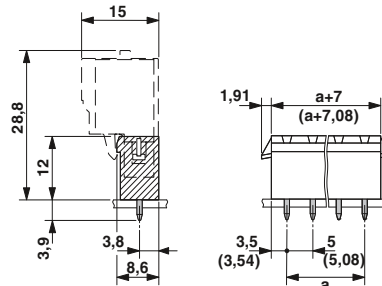

Drilling diagram

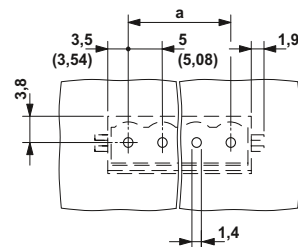

Technical data

Technical data in accordance to IEC / DIN VDE	
Rated current	[A] 12
Rated insulation voltage for pollution degree 2	[V] 320
Pitch	[mm] 5 / 5.08
Insulation coordination	
Surge voltage category / pollution degree	III / 3 III / 2 II / 2
Rated insulation voltage	[V] 250 320 400
Rated surge voltage	[kV] 4 4 4
Approval data (UL/CUL)	Use Group B C D
Nominal voltage	[V] 300 - 300
Nominal current	[A] 12 - 12
Connection capacity AWG	AWG - - -
Approval data (CSA)	Use Group B C D
Nominal voltage	[V] - - -
Nominal current	[A] - - -
Connection capacity AWG	AWG - - -
General data	
Type of insulation material / insulation material group	- / I
Inflammability class according to UL 94	V0

Ordering data

No. of pos.	Dim. a [mm]	Type	Order No.	Pcs. / Pkt.
5.0 mm pitch, color: green				
2	5.00	MSTBVA 2,5/ 2-G-RN	1944592	50
3	10.00	MSTBVA 2,5/ 3-G-RN	1944602	50
4	15.00	MSTBVA 2,5/ 4-G-RN	1944615	50
5	20.00	MSTBVA 2,5/ 5-G-RN	1944628	50
6	25.00	MSTBVA 2,5/ 6-G-RN	1944631	50
7	30.00	MSTBVA 2,5/ 7-G-RN	1944644	50
8	35.00	MSTBVA 2,5/ 8-G-RN	1944657	50
9	40.00	MSTBVA 2,5/ 9-G-RN	1944660	50
10	45.00	MSTBVA 2,5/10-G-RN	1944673	50
11	50.00	MSTBVA 2,5/11-G-RN	1944686	50
12	55.00	MSTBVA 2,5/12-G-RN	1944699	50
13	60.00	MSTBVA 2,5/13-G-RN	1944709	50
14	65.00	MSTBVA 2,5/14-G-RN	1944712	50
15	70.00	MSTBVA 2,5/15-G-RN	1944725	50
16	75.00	MSTBVA 2,5/16-G-RN	1944738	50
5.08 mm pitch, color: green				
2	10.16	MSTBVA 2,5/ 2-G-5,08-RN	1936018	50
3	10.16	MSTBVA 2,5/ 3-G-5,08-RN	1936021	50
4	15.24	MSTBVA 2,5/ 4-G-5,08-RN	1936034	50
5	20.32	MSTBVA 2,5/ 5-G-5,08-RN	1936047	50
6	25.40	MSTBVA 2,5/ 6-G-5,08-RN	1936050	50
7	30.48	MSTBVA 2,5/ 7-G-5,08-RN	1936063	50
8	35.56	MSTBVA 2,5/ 8-G-5,08-RN	1936076	50
9	40.64	MSTBVA 2,5/ 9-G-5,08-RN	1936089	50
10	45.72	MSTBVA 2,5/10-G-5,08-RN	1936092	50
11	50.80	MSTBVA 2,5/11-G-5,08-RN	1936102	50
12	55.88	MSTBVA 2,5/12-G-5,08-RN	1936115	50
13	60.96	MSTBVA 2,5/13-G-5,08-RN	1936128	50
14	66.04	MSTBVA 2,5/14-G-5,08-RN	1936131	50
15	71.12	MSTBVA 2,5/15-G-5,08-RN	1936144	50
16	76.20	MSTBVA 2,5/16-G-5,08-RN	1936157	50

Classic plug-in connector with 5.0 to 7.62 mm pitch

CLASSIC COMBICON plug-in connectors, pitches 5.0 or 5.08 mm

N

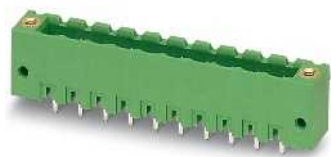

With threaded flange,
plug-in direction vertical to the PCB

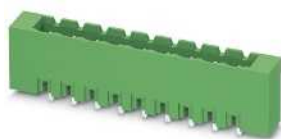

For Lock & Release locking,
plug-in direction vertical to the PCB

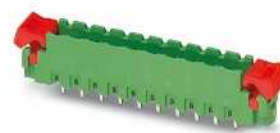

With release aid,
plug-in direction vertical to the PCB



Dimensional drawing

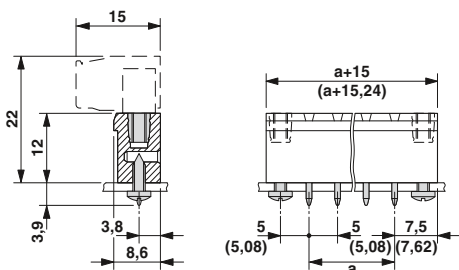

Drilling diagram

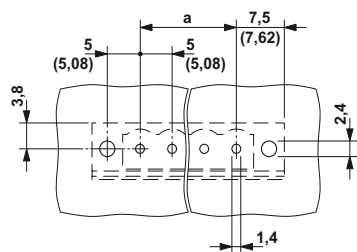

Dimensional drawing

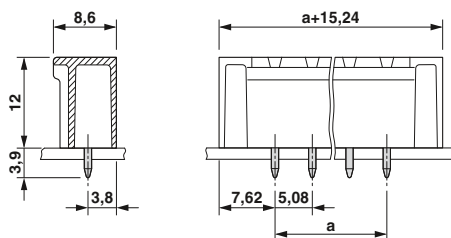

Drilling diagram

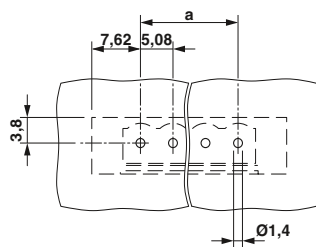

Dimensional drawing

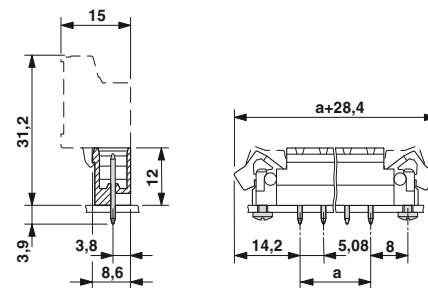

Drilling diagram

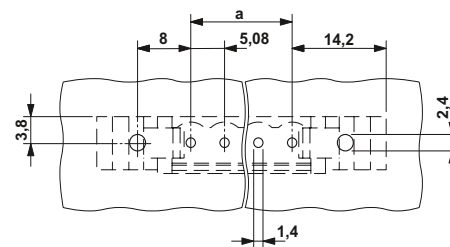

Ordering data

Type	Order No.	Pcs. / Pkt.
5.0 mm pitch, color: green		
MSTBV 2,5/ 2-GF	1776883	250
MSTBV 2,5/ 3-GF	1776896	250
MSTBV 2,5/ 4-GF	1776906	250
MSTBV 2,5/ 5-GF	1776919	250
MSTBV 2,5/ 6-GF	1776922	100
MSTBV 2,5/ 7-GF	1776935	100
MSTBV 2,5/ 8-GF	1776948	100
MSTBV 2,5/ 9-GF	1776951	100
MSTBV 2,5/10-GF	1776964	100
MSTBV 2,5/11-GF	1776977	50
MSTBV 2,5/12-GF	1776980	50
MSTBV 2,5/13-GF	1776993	50
MSTBV 2,5/14-GF	1777002	50
MSTBV 2,5/15-GF	1777015	50
MSTBV 2,5/16-GF	1777028	50
5.08 mm pitch, color: green		
MSTBV 2,5/ 2-GF-5,08	1777073	250
MSTBV 2,5/ 3-GF-5,08	1777086	250
MSTBV 2,5/ 4-GF-5,08	1777099	250
MSTBV 2,5/ 5-GF-5,08	1777109	250
MSTBV 2,5/ 6-GF-5,08	1777112	100
MSTBV 2,5/ 7-GF-5,08	1777125	100
MSTBV 2,5/ 8-GF-5,08	1777138	100
MSTBV 2,5/ 9-GF-5,08	1777141	100
MSTBV 2,5/10-GF-5,08	1777154	100
MSTBV 2,5/11-GF-5,08	1777167	50
MSTBV 2,5/12-GF-5,08	1777170	50
MSTBV 2,5/13-GF-5,08	1777183	50
MSTBV 2,5/14-GF-5,08	1777196	50
MSTBV 2,5/15-GF-5,08	1777206	50
MSTBV 2,5/16-GF-5,08	1777219	50

Ordering data

Type	Order No.	Pcs. / Pkt.
5.08 mm pitch, color: green		
MSTBVA 2,5/ 2-G-5,08-LR	1809267	50
MSTBVA 2,5/ 3-G-5,08-LR	1809270	50
MSTBVA 2,5/ 4-G-5,08-LR	1809283	50
MSTBVA 2,5/ 5-G-5,08-LR	1809296	50
MSTBVA 2,5/ 6-G-5,08-LR	1809306	50
MSTBVA 2,5/ 7-G-5,08-LR	1809319	50
MSTBVA 2,5/ 8-G-5,08-LR	1809322	50
MSTBVA 2,5/ 9-G-5,08-LR	1809335	50
MSTBVA 2,5/10-G-5,08-LR	1809348	50
MSTBVA 2,5/11-G-5,08-LR	1809351	50
MSTBVA 2,5/12-G-5,08-LR	1809364	50
MSTBVA 2,5/13-G-5,08-LR	1809377	50
MSTBVA 2,5/14-G-5,08-LR	1809380	50
MSTBVA 2,5/15-G-5,08-LR	1809393	50
MSTBVA 2,5/16-G-5,08-LR	1809403	50

Ordering data

Type	Order No.	Pcs. / Pkt.
5.08 mm pitch, color: green		
MSTBV 2,5/ 2-GEH-5,08	1808463	50
MSTBV 2,5/ 3-GEH-5,08	1808476	50
MSTBV 2,5/ 4-GEH-5,08	1808489	50
MSTBV 2,5/ 5-GEH-5,08	1808492	50
MSTBV 2,5/ 6-GEH-5,08	1808502	50
MSTBV 2,5/ 7-GEH-5,08	1808515	50
MSTBV 2,5/ 8-GEH-5,08	1808528	50
MSTBV 2,5/ 9-GEH-5,08	1808531	50
MSTBV 2,5/10-GEH-5,08	1808544	50
MSTBV 2,5/11-GEH-5,08	1808557	50
MSTBV 2,5/12-GEH-5,08	1808560	50
MSTBV 2,5/13-GEH-5,08	1808573	50
MSTBV 2,5/14-GEH-5,08	1808586	50
MSTBV 2,5/15-GEH-5,08	1808599	50
MSTBV 2,5/16-GEH-5,08	1808609	50

Classic plug-in connector with 5.0 to 7.62 mm pitch

CLASSIC COMBICON plug-in connectors, pitches 5.0 or 5.08 mm

Single-level header for the wave soldering processes

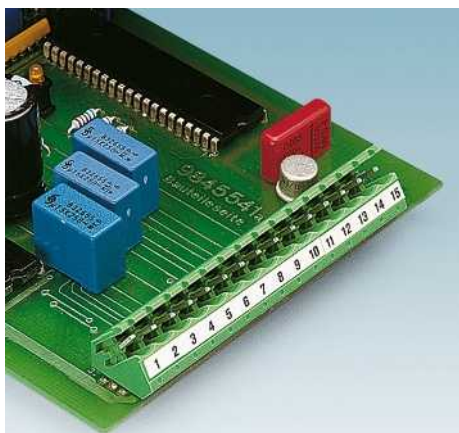

- You can find higher numbers of positions under:
www.phoenixcontact.net/products
- Plug-in direction 45° to the PCB
- Used in cases of restricted overhead space
- Designs with and without side panel

Notes:

In accordance with DIN EN 61984, COMBICON plug-in connectors have no switching power. During designated use, they must not be plugged in or disconnected when carrying voltage or under load.

COMBICON select



You will find the possible plug-in connector combinations in COMBICON select at: www.phoenixcontact.net/products or starting on page 259.



Without side panels,
plug-in direction 45° to the PCB



Accessories

For all types	Type	Page
	Marker cards SK 5/3,8 or SK 5,08/3,8	798
	Coding section CR-MSTB Order No. 1734401	38
	Coding tab MSTB-BL Order No. 1755477	837

Dimensional drawing

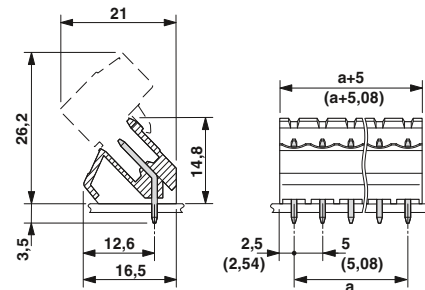

Drilling diagram

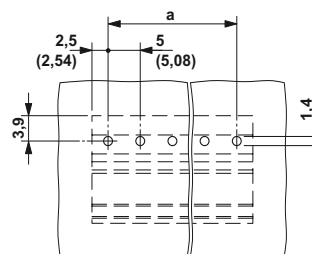

Technical data

Technical data in accordance to IEC / DIN VDE	
Rated current	[A] 12
Rated insulation voltage for pollution degree 2	[V] 320
Pitch	[mm] 5 / 5.08
Insulation coordination	
Surge voltage category / pollution degree	III / 3 III / 2 II / 2
Rated insulation voltage	[V] 250 320 400
Rated surge voltage	[kV] 4 4 4
Approval data (UL/CUL)	Use Group B C D
Nominal voltage	[V] 300 - 300
Nominal current	[A] 15 - 10
Connection capacity AWG	AWG - - -
Approval data (CSA)	Use Group B C D
Nominal voltage	[V] 300 - 300
Nominal current	[A] 10 - 10
Connection capacity AWG	AWG - - -
General data	
Type of insulation material / insulation material group	PA / I
Inflammability class according to UL 94	V0
Drill hole diameter / pin dimensions	[mm] 1.4 / 1 x 1 mm

Ordering data

No. of pos.	Dim. a [mm]	Type	Order No.	Pcs. / Pkt.
5.0 mm pitch, color: green				
2	5.00	SMSTB 2,5/ 2-G	1769230	50
3	10.00	SMSTB 2,5/ 3-G	1769243	50
4	15.00	SMSTB 2,5/ 4-G	1769256	50
5	20.00	SMSTB 2,5/ 5-G	1769269	50
6	25.00	SMSTB 2,5/ 6-G	1769272	50
7	30.00	SMSTB 2,5/ 7-G	1769285	50
8	35.00	SMSTB 2,5/ 8-G	1769298	50
9	40.00	SMSTB 2,5/ 9-G	1769308	50
10	45.00	SMSTB 2,5/10-G	1769311	50
11	50.00	SMSTB 2,5/11-G	1769324	50
12	55.00	SMSTB 2,5/12-G	1769337	50
13	60.00	SMSTB 2,5/13-G	1769340	50
14	65.00	SMSTB 2,5/14-G	1769353	50
15	70.00	SMSTB 2,5/15-G	1769366	50
16	75.00	SMSTB 2,5/16-G	1769379	50
5.08 mm pitch, color: green				
2	5.08	SMSTB 2,5/ 2-G-5,08	1769463	50
3	10.16	SMSTB 2,5/ 3-G-5,08	1769476	50
4	15.24	SMSTB 2,5/ 4-G-5,08	1769489	50
5	20.32	SMSTB 2,5/ 5-G-5,08	1769492	50
6	25.40	SMSTB 2,5/ 6-G-5,08	1769502	50
7	30.48	SMSTB 2,5/ 7-G-5,08	1769515	50
8	35.56	SMSTB 2,5/ 8-G-5,08	1769528	50
9	40.64	SMSTB 2,5/ 9-G-5,08	1769531	50
10	45.72	SMSTB 2,5/10-G-5,08	1769544	50
11	50.80	SMSTB 2,5/11-G-5,08	1769557	50
12	55.88	SMSTB 2,5/12-G-5,08	1769560	50
13	60.96	SMSTB 2,5/13-G-5,08	1769573	50
14	66.04	SMSTB 2,5/14-G-5,08	1769586	50
15	71.12	SMSTB 2,5/15-G-5,08	1769599	50
16	76.20	SMSTB 2,5/16-G-5,08	1769609	50



With side panels,
 plug-in direction 45° to the PCB



Dimensional drawing

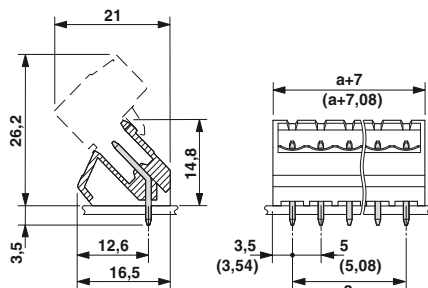

Drilling diagram

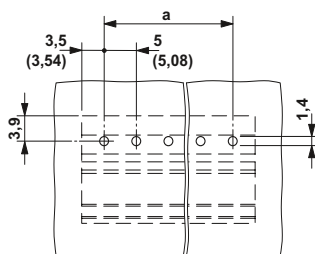

Ordering data

Type	Order No.	Pcs. / Pkt.
5.0 mm pitch, color: green		
SMSTBA 2,5/ 2-G	1769803	50
SMSTBA 2,5/ 3-G	1769816	50
SMSTBA 2,5/ 4-G	1769829	50
SMSTBA 2,5/ 5-G	1769832	50
SMSTBA 2,5/ 6-G	1769845	50
SMSTBA 2,5/ 7-G	1769858	50
SMSTBA 2,5/ 8-G	1769861	50
SMSTBA 2,5/ 9-G	1769874	50
SMSTBA 2,5/10-G	1769887	50
SMSTBA 2,5/11-G	1769890	50
SMSTBA 2,5/12-G	1769900	50
SMSTBA 2,5/13-G	1769913	50
SMSTBA 2,5/14-G	1769926	50
SMSTBA 2,5/15-G	1769939	50
SMSTBA 2,5/16-G	1769942	50
5.08 mm pitch, color: green		
SMSTBA 2,5/ 2-G-5,08	1767371	50
SMSTBA 2,5/ 3-G-5,08	1767384	50
SMSTBA 2,5/ 4-G-5,08	1767397	50
SMSTBA 2,5/ 5-G-5,08	1767407	50
SMSTBA 2,5/ 6-G-5,08	1767410	50
SMSTBA 2,5/ 7-G-5,08	1767423	50
SMSTBA 2,5/ 8-G-5,08	1767436	50
SMSTBA 2,5/ 9-G-5,08	1767449	50
SMSTBA 2,5/10-G-5,08	1767452	50
SMSTBA 2,5/11-G-5,08	1767465	50
SMSTBA 2,5/12-G-5,08	1767478	50
SMSTBA 2,5/13-G-5,08	1767481	50
SMSTBA 2,5/14-G-5,08	1767494	50
SMSTBA 2,5/15-G-5,08	1767504	50
SMSTBA 2,5/16-G-5,08	1767517	50

Classic plug-in connector with 5.0 to 7.62 mm pitch

CLASSIC COMBICON plug-in connectors, pitches 5.0 or 5.08 mm

Orthogonal headers for wave soldering processes

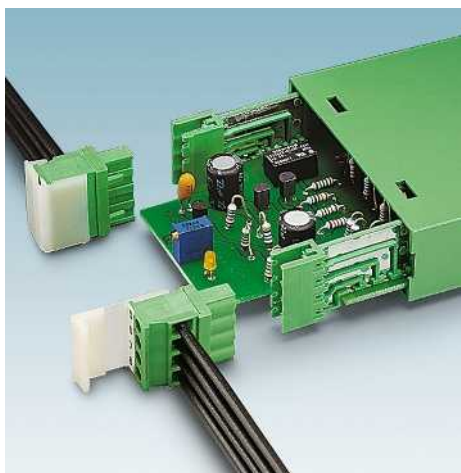

- Space-saving header
- Header perpendicular (orthogonal) to the PCB

MSTBO 2,5/...-GL

- The PCB is to the left of the header

MSTBO 2,5/...-GR

- The PCB is to the right of the header

Notes:

In accordance with DIN EN 61984, COMBICON plug-in connectors have no switching power. During designated use, they must not be plugged in or disconnected when carrying voltage or under load.

COMBICON select

You will find the possible plug-in connector combinations in COMBICON select at: www.phoenixcontact.net/products or starting on page 259.



Pin strip leading off at a right angle
"PCB on the left"



Dimensional drawing

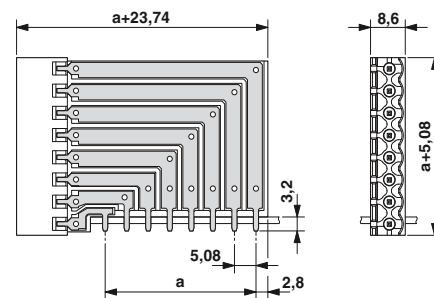

Drilling diagram

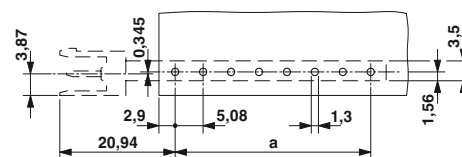

Accessories		
For all types	Type	Page
	Coding section CR-MSTB Order No. 1734401	38
	Coding tab MSTB-BL Order No. 1755477	837

Technical data

Technical data in accordance to IEC / DIN VDE

Rated current	[A]	8
Rated insulation voltage for pollution degree 2	[V]	320
Pitch	[mm]	5.08
Insulation coordination		
Surge voltage category / pollution degree		III / 3 III / 2 II / 2
Rated insulation voltage	[V]	250 320 630
Rated surge voltage	[kV]	4 4 4
Approval data (UL/CUL)	Use Group	B C D
Nominal voltage	[V]	250 - 300
Nominal current	[A]	8 - 8
Connection capacity AWG	AWG	- - -
Approval data (CSA)	Use Group	B C D
Nominal voltage	[V]	300 - 300
Nominal current	[A]	6.5 - 6.5
Connection capacity AWG	AWG	- - -
General data		
Type of insulation material / insulation material group		PA / I
Inflammability class according to UL 94		V0
Drill hole diameter / pin dimensions	[mm]	1.3 / 1,2 x 0,32 mm

No. of pos.	Dim. a [mm]
3	10.16
4	15.24
5	20.32
6	25.40
7	30.48
8	35.56

Ordering data

Type	Order No.	Pcs. / Pkt.
5.08 mm pitch, color: green		
MSTBO 2,5/ 3-GL-5,08	1850440	50
MSTBO 2,5/ 4-GL-5,08	1850453	50
MSTBO 2,5/ 5-GL-5,08	1850466	50
MSTBO 2,5/ 6-GL-5,08	1850479	50
MSTBO 2,5/ 7-GL-5,08	1850482	50
MSTBO 2,5/ 8-GL-5,08	1850495	50



Pin strip leading off at a right angle
 "PCB on the right"



Dimensional drawing

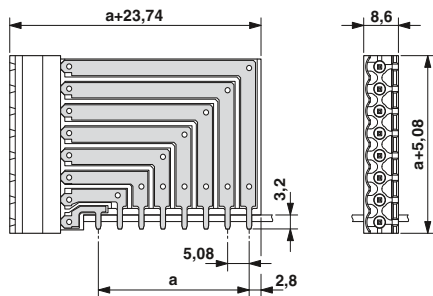

Drilling diagram

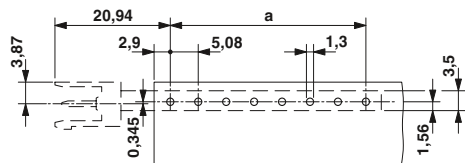

Ordering data

Type	Order No.	Pcs. / Pkt.
5.08 mm pitch, color: green		
MSTBO 2,5/ 3-GR-5,08	1847110	50
MSTBO 2,5/ 4-GR-5,08	1847123	50
MSTBO 2,5/ 5-GR-5,08	1847136	50
MSTBO 2,5/ 6-GR-5,08	1847149	50
MSTBO 2,5/ 7-GR-5,08	1847152	50
MSTBO 2,5/ 8-GR-5,08	1847165	50

Classic plug-in connector with 5.0 to 7.62 mm pitch

CLASSIC COMBICON plug-in connectors, pitches 5.0 or 5.08 mm



Pin strip leading off at a right angle
"right", color: green



Pin strip leading off at a right angle
"left", color: gray



Pin strip leading off at a right angle
"right", color: gray



Dimensional drawing

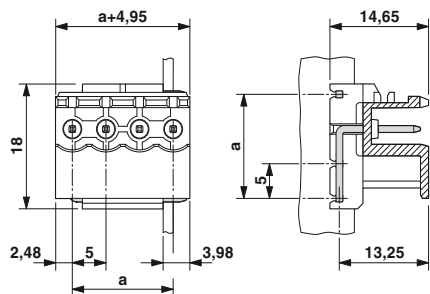

Drilling diagram

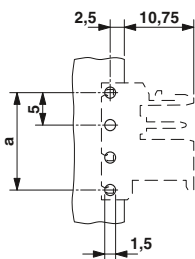

Ordering data

Type	Order No.	Pcs. / Pkt.
COMBICON header, right, 5 mm pitch, color: green		
MSTBO 2,5/ 2-G1R	1861044	50
MSTBO 2,5/ 3-G1R	1861031	50
MSTBO 2,5/ 4-G1R	1861073	50



Dimensional drawing

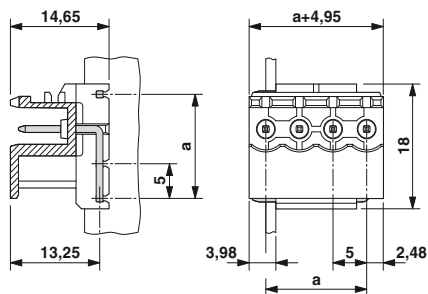

Drilling diagram



Ordering data

Type	Order No.	Pcs. / Pkt.
COMBICON header, 5 mm pitch, color: light gray		
MSTBO 2,5/ 2-G1L KMGY	2854788	50
MSTBO 2,5/ 3-G1L KMGY	2853750	50
MSTBO 2,5/ 4-G1L KMGY	2907774	50



Dimensional drawing

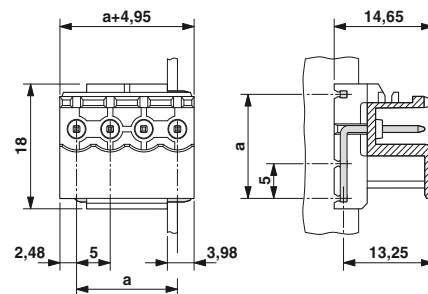

Drilling diagram

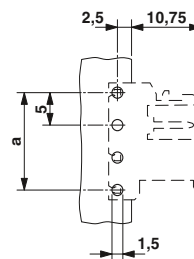

Ordering data

Type	Order No.	Pcs. / Pkt.
COMBICON header, right, 5 mm pitch, color: light gray		
MSTBO 2,5/ 2-G1R KMGY	2854791	50
MSTBO 2,5/ 3-G1R KMGY	2853763	50
MSTBO 2,5/ 4-G1R KMGY	2907787	50

Classic plug-in connector with 5.0 to 7.62 mm pitch

CLASSIC COMBICON plug-in connectors, pitches 5.0 or 5.08 mm

Orthogonal headers for wave soldering processes

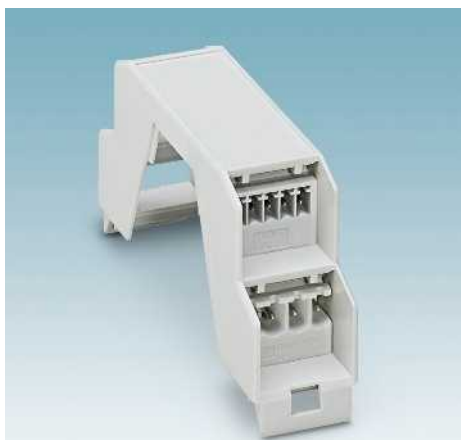



- Header and plug for ME and ME MAX electronic housings
- Touch proof
- Plug-in direction orthogonal to the PCB
- Design version “left” and “right”
- Number of positions between 2 and 4
- Pitch 5 mm
- Connection cross section of up to 2.5 mm²

Notes:

In accordance with DIN EN 61984, COMBICON plug-in connectors have no switching power. During designated use, they must not be plugged in or disconnected when carrying voltage or under load.

1) Please observe the derating curves. Derating curves of further combination options on request.

Accessories

For all types	Type	Page
	Marker cards SK 5/3,8	798
Only for MSTBO 2,5...G1...		
	Coding section CR-MSTBO G1 Order No. 2199618	38

Technical data

Technical data in accordance to IEC / DIN VDE	
Rated current / conductor cross section	[A] / [mm ²]
Rated insulation voltage for pollution degree 2	[V]
Pitch	[mm]
Connection capacity	
Solid / stranded	[mm ²] / [mm ²] / AWG
Stranded with ferrules without plastic sleeve	[mm ²]
Stranded with ferrules with plastic sleeve	[mm ²]
Multi-conductor connection capacity (two conductors with the same cross section)	
Solid / stranded	[mm ²]
Stranded with ferrules without plastic sleeve	[mm ²]
Stranded with TWIN ferrule with plastic sleeve	[mm ²]
Insulation coordination	
Surge voltage category / pollution degree	
Rated insulation voltage	[V]
Rated surge voltage	[kV]
Approval data (UL/CUL)	Use Group
Nominal voltage	[V]
Nominal current	[A]
Connection capacity AWG	AWG
Approval data (CSA)	Use Group
Nominal voltage	[V]
Nominal current	[A]
Connection capacity AWG	AWG
General data	
Stripping length	[mm]
Screw thread	
Tightening torque	[Nm]
Type of insulation material / insulation material group	
Inflammability class according to UL 94	

MSTBT 2,5 HC/ ...-STP GY7035

Rated current / conductor cross section			16 ¹⁾ / 2.5
Rated insulation voltage for pollution degree 2			320
Pitch			5
Connection capacity			
Solid / stranded			0.2 - 2.5 / 0.2 - 2.5 / 24 - 12
Stranded with ferrules without plastic sleeve			0.25 - 2.5
Stranded with ferrules with plastic sleeve			0.25 - 2.5
Multi-conductor connection capacity (two conductors with the same cross section)			
Solid / stranded			0.2 - 1 / 0.2 - 1.5
Stranded with ferrules without plastic sleeve			0.25 - 1
Stranded with TWIN ferrule with plastic sleeve			0.5 - 1.5
Insulation coordination			
Surge voltage category / pollution degree			III / 3 III / 2 II / 2
Rated insulation voltage			250 320 630
Rated surge voltage			4 4 4
Approval data (UL/CUL)			B C D
Nominal voltage			300 - - 300
Nominal current			16 - - 15
Connection capacity AWG			30 - 12 - - 30 - 12
Approval data (CSA)			B C D
Nominal voltage			- - -
Nominal current			- - -
Connection capacity AWG			- - -
General data			
Stripping length			7
Screw thread			M3
Tightening torque			0.5 - 0.6
Type of insulation material / insulation material group			PA / I
Inflammability class according to UL 94			V0

MSTBO 2,5/ ...-G1PR GY7035

Rated current / conductor cross section			16
Rated insulation voltage for pollution degree 2			320
Pitch			5
Connection capacity			
Solid / stranded			- / - / -
Stranded with ferrules without plastic sleeve			-
Stranded with ferrules with plastic sleeve			-
Multi-conductor connection capacity (two conductors with the same cross section)			
Solid / stranded			- / -
Stranded with ferrules without plastic sleeve			-
Stranded with TWIN ferrule with plastic sleeve			-
Insulation coordination			
Surge voltage category / pollution degree			III / 3 III / 2 II / 2
Rated insulation voltage			250 320 400
Rated surge voltage			4 4 4
Approval data (UL/CUL)			B C D
Nominal voltage			300 - - 300
Nominal current			15 - - 15
Connection capacity AWG			- - -
Approval data (CSA)			B C D
Nominal voltage			- - -
Nominal current			- - -
Connection capacity AWG			- - -
General data			
Stripping length			-
Screw thread			-
Tightening torque			-
Type of insulation material / insulation material group			PA / I
Inflammability class according to UL 94			V0

MSTBO 2,5/ ...-G1PL GY7035

Rated current / conductor cross section			16
Rated insulation voltage for pollution degree 2			320
Pitch			5
Connection capacity			
Solid / stranded			- / - / -
Stranded with ferrules without plastic sleeve			-
Stranded with ferrules with plastic sleeve			-
Multi-conductor connection capacity (two conductors with the same cross section)			
Solid / stranded			- / -
Stranded with ferrules without plastic sleeve			-
Stranded with TWIN ferrule with plastic sleeve			-
Insulation coordination			
Surge voltage category / pollution degree			III / 3 III / 2 II / 2
Rated insulation voltage			250 320 400
Rated surge voltage			4 4 4
Approval data (UL/CUL)			B C D
Nominal voltage			300 - - 300
Nominal current			15 - - 15
Connection capacity AWG			- - -
Approval data (CSA)			B C D
Nominal voltage			- - -
Nominal current			- - -
Connection capacity AWG			- - -
General data			
Stripping length			-
Screw thread			-
Tightening torque			-
Type of insulation material / insulation material group			PA / I
Inflammability class according to UL 94			V0

No. of pos.	Dim. a [mm]
2	5.00
3	10.00
4	15.00

Classic plug-in connector with 5.0 to 7.62 mm pitch

CLASSIC COMBICON plug-in connectors, pitches 5.0 or 5.08 mm



Connector for touch-proof header, color: gray, pitch 5 mm



Touch-proof, with "right" pin strip leading off at a right angle, color: gray



Touch-proof, with "left" pin strip leading off at a right angle, color: gray



Dimensional drawing

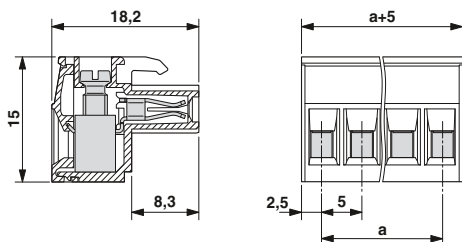

Dimensional drawing

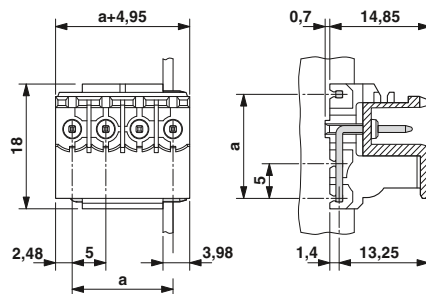

Dimensional drawing

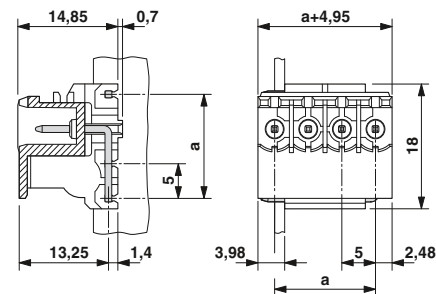

Drilling diagram

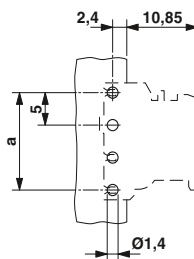

Drilling diagram

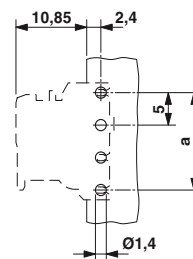

Ordering data

Type	Order No.	Pcs. / Pkt.
COMBICON screw connector, pitch 5 mm, for touch-proof header, color: gray		
MSTBT 2,5 HC/ 2-STP GY7035	2200334	50
MSTBT 2,5 HC/ 3-STP GY7035	2200333	50
MSTBT 2,5 HC/ 4-STP GY7035	2200332	50

Ordering data

Type	Order No.	Pcs. / Pkt.
COMBICON header,, pitch 5 mm, touch-proof, color: light gray		
MSTBO 2,5/ 2-G1PR GY7035	2200331	50
MSTBO 2,5/ 3-G1PR GY7035	2200329	50
MSTBO 2,5/ 4-G1PR GY7035	2200326	50

Ordering data

Type	Order No.	Pcs. / Pkt.
COMBICON header,, pitch 5 mm, touch-proof, color: light gray		
MSTBO 2,5/ 2-G1PL GY7035	2200330	50
MSTBO 2,5/ 3-G1PL GY7035	2200328	50
MSTBO 2,5/ 4-G1PL GY7035	2200325	50

Classic plug-in connector with 5.0 to 7.62 mm pitch

CLASSIC COMBICON plug-in connectors, pitches 5.0 or 5.08 mm

Double-level header for the wave soldering processes

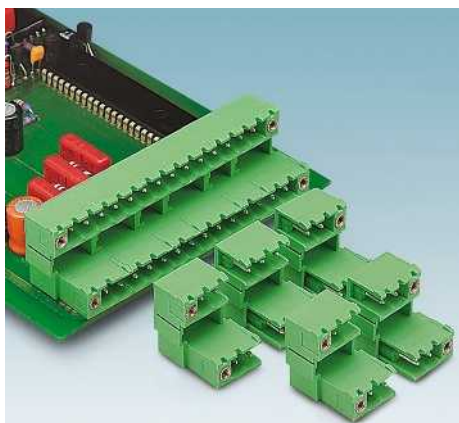

- Double-level header with offset levels
- Plug-in direction parallel to the PCB
- Improved view and accessibility to the lower level
- High contact density
- Versions with and without side panel, as well as with and without screw flange
- Ejectors as an add-on for high-pos. connectors must be mounted on the left and the right side
- Versions with right and left side panel and higher numbers of positions up to 20-pos. can be found at: www.phoenixcontact.net/products

Notes:

In accordance with DIN EN 61984, COMBICON plug-in connectors have no switching power. During designated use, they must not be plugged in or disconnected when carrying voltage or under load.

COMBICON select

You will find the possible plug-in connector combinations in COMBICON select at: www.phoenixcontact.net/products or starting on page 259.



Without side panels, with offset levels, plug-in direction parallel to the PCB





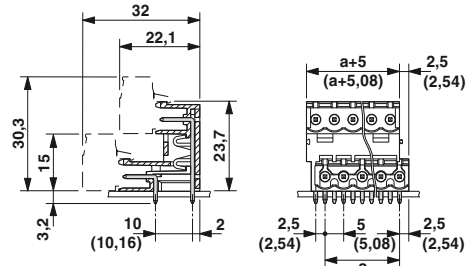

Dimensional drawing

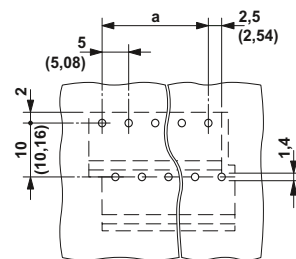

Drilling diagram



Accessories		
For all types	Type	Page
	Marker cards SK 5/3,8 or SK 5,08/3,8	798
	Coding section CR-MSTB Order No. 1734401	38
	Coding tab MSTB-BL Order No. 1755477	837
Only for MDSTB 2,5/...-G		
	Side element for MDSTB(V); width 2,54 mm MDSTB-SE Order No. 1786679	
	Ejectors for high-pos. plugs MDSTB 2,5-AS Order No. 1806588	

Technical data

Technical data in accordance to IEC / DIN VDE

Rated current	[A]	10
Rated insulation voltage for pollution degree 2	[V]	320
Pitch	[mm]	5 / 5.08
Insulation coordination		
Surge voltage category / pollution degree		III / 3 III / 2 II / 2
Rated insulation voltage	[V]	250 320 400
Rated surge voltage	[kV]	4 4 4
Approval data (UL/CUL)	Use Group	B C D
Nominal voltage	[V]	300 - 300
Nominal current	[A]	15 - 15
Connection capacity AWG	AWG	- - -
Approval data (CSA)	Use Group	B C D
Nominal voltage	[V]	300 - 300
Nominal current	[A]	10 - 10
Connection capacity AWG	AWG	- - -
General data		
Type of insulation material / insulation material group		PBT / IIIa
Inflammability class according to UL 94		V0
Drill hole diameter / pin dimensions	[mm]	1.4 / 1 x 1 mm

No. of pos.	Dim. a [mm]
2	5.00
3	10.00
4	20.00
5	20.00
6	25.00
7	30.00
8	35.00
9	40.00
10	45.00
11	50.00
12	55.00

Ordering data

Type	Order No.	Pcs. / Pkt.
5.0 mm pitch, color: green		
MDSTB 2,5/ 2-G	1762046	50
MDSTB 2,5/ 3-G	1762059	50
MDSTB 2,5/ 4-G	1846386	50
MDSTB 2,5/ 5-G	1837133	50
MDSTB 2,5/ 6-G	1846409	50
MDSTB 2,5/ 7-G	1846412	50
MDSTB 2,5/ 8-G	1846425	50
MDSTB 2,5/ 9-G	1846438	50
MDSTB 2,5/10-G	1846441	50
MDSTB 2,5/11-G	1846454	50
MDSTB 2,5/12-G	1846467	50
5.08 mm pitch, color: green		
MDSTB 2,5/ 2-G-5,08	1762062	50
MDSTB 2,5/ 3-G-5,08	1762075	50
MDSTB 2,5/ 4-G-5,08	1842539	50
MDSTB 2,5/ 5-G-5,08	1842542	50
MDSTB 2,5/ 6-G-5,08	1844977	50
MDSTB 2,5/ 7-G-5,08	1842568	50
MDSTB 2,5/ 8-G-5,08	1840052	50
MDSTB 2,5/ 9-G-5,08	1842584	50
MDSTB 2,5/10-G-5,08	1842597	50
MDSTB 2,5/11-G-5,08	1842607	50
MDSTB 2,5/12-G-5,08	1842610	50

Classic plug-in connector with 5.0 to 7.62 mm pitch

CLASSIC COMBICON plug-in connectors, pitches 5.0 or 5.08 mm



With side panels and offset levels,
plug-in direction parallel to the PCB

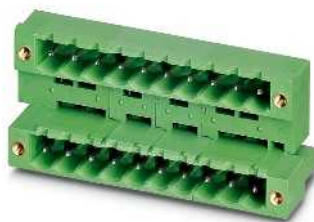

With threaded flange and offset levels,
plug-in direction parallel to the PCB



Dimensional drawing

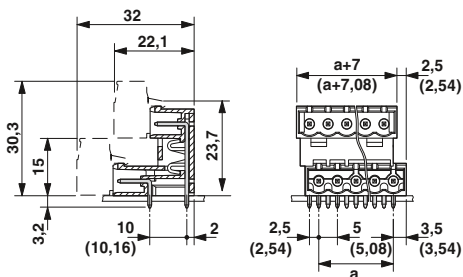

Drilling diagram

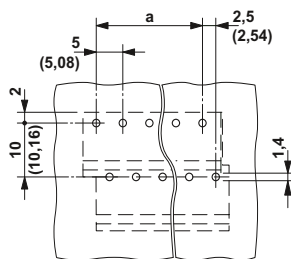

Ordering data

Type	Order No.	Pcs. / Pkt.
5.0 mm pitch, color: green		
MDSTBA 2,5/ 2-G	1846519	50
MDSTBA 2,5/ 3-G	1846522	50
MDSTBA 2,5/ 4-G	1846535	50
MDSTBA 2,5/ 5-G	1846548	50
MDSTBA 2,5/ 6-G	1846551	50
MDSTBA 2,5/ 7-G	1846564	50
MDSTBA 2,5/ 8-G	1846577	50
MDSTBA 2,5/ 9-G	1846580	50
MDSTBA 2,5/10-G	1846593	50
MDSTBA 2,5/11-G	1846603	50
MDSTBA 2,5/12-G	1846616	50
5.08 mm pitch, color: green		
MDSTBA 2,5/ 2-G-5,08	1842063	50
MDSTBA 2,5/ 3-G-5,08	1842076	50
MDSTBA 2,5/ 4-G-5,08	1842089	50
MDSTBA 2,5/ 5-G-5,08	1842092	50
MDSTBA 2,5/ 6-G-5,08	1842102	50
MDSTBA 2,5/ 7-G-5,08	1842115	50
MDSTBA 2,5/ 8-G-5,08	1842128	50
MDSTBA 2,5/ 9-G-5,08	1842131	50
MDSTBA 2,5/10-G-5,08	1842144	50
MDSTBA 2,5/11-G-5,08	1842157	50
MDSTBA 2,5/12-G-5,08	1842160	50



Dimensional drawing

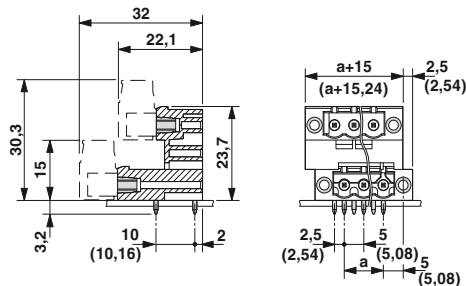

Drilling diagram

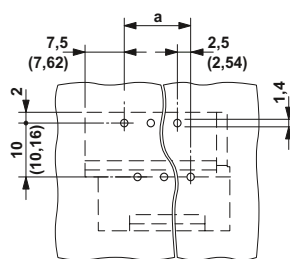

Ordering data

Type	Order No.	Pcs. / Pkt.
5.0 mm pitch, color: green		
MDSTB 2,5/ 2-GF	1846690	50
MDSTB 2,5/ 3-GF	1846700	50
MDSTB 2,5/ 4-GF	1846713	50
MDSTB 2,5/ 5-GF	1846726	50
MDSTB 2,5/ 6-GF	1846739	50
MDSTB 2,5/ 7-GF	1846742	50
MDSTB 2,5/ 8-GF	1846755	50
MDSTB 2,5/ 9-GF	1846768	50
MDSTB 2,5/10-GF	1846771	50
MDSTB 2,5/11-GF	1846784	50
MDSTB 2,5/12-GF	1846797	50
5.08 mm pitch, color: green		
MDSTB 2,5/ 2-GF-5,08	1842364	50
MDSTB 2,5/ 3-GF-5,08	1842377	50
MDSTB 2,5/ 4-GF-5,08	1842380	50
MDSTB 2,5/ 5-GF-5,08	1842393	50
MDSTB 2,5/ 6-GF-5,08	1842403	50
MDSTB 2,5/ 7-GF-5,08	1842416	50
MDSTB 2,5/ 8-GF-5,08	1842429	50
MDSTB 2,5/ 9-GF-5,08	1842432	50
MDSTB 2,5/10-GF-5,08	1842445	50
MDSTB 2,5/11-GF-5,08	1842458	50
MDSTB 2,5/12-GF-5,08	1842461	50

Classic plug-in connector with 5.0 to 7.62 mm pitch

CLASSIC COMBICON plug-in connectors, pitches 5.0 or 5.08 mm

Double-level header for the wave soldering processes

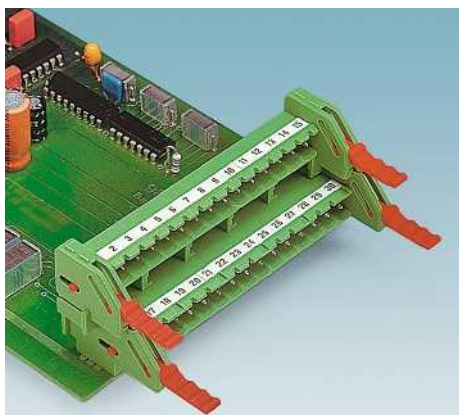

- MDSTBW 2,5/...-G with stand-off
- Ejectors as an add-on for high-pos. connectors must be mounted on the left and the right side
- G1-types without a level offset, for flush installation in the front of the devices
- Horizontal and vertical design
- Higher numbers of positions up to 20-pos. can be found at:
www.phoenixcontact.net/products

Notes:

In accordance with DIN EN 61984, COMBICON PLUG-IN connectors have no switching power. During designated use, they must not be plugged in or disconnected when carrying voltage or under load.

COMBICON select

You will find the possible plug-in connector combinations in COMBICON select at: www.phoenixcontact.net/products or starting on page 259.

Accessories

For all types	Type	Page
	Marker cards SK 5/3,8 or SK 5,08/3,8	798
	Coding section CR-MSTB Order No. 1734401	38
	Coding tab MSTB-BL Order No. 1755477	837
Only for MDSTBW 2,5/...-G		
	Ejectors MDSTBW 2,5-AS Order No. 1767766	

Technical data

Technical data in accordance to IEC / DIN VDE

Rated current	[A]	10
Rated insulation voltage for pollution degree 2	[V]	320
Pitch	[mm]	5 / 5.08
Insulation coordination		
Surge voltage category / pollution degree		III / 3 III / 2 II / 2
Rated insulation voltage	[V]	250 320 400
Rated surge voltage	[kV]	4 4 4
Approval data (UL/CUL)	Use Group	B C D
Nominal voltage	[V]	300 - 300
Nominal current	[A]	15 - 15
Connection capacity AWG	AWG	- - -
Approval data (CSA)	Use Group	B C D
Nominal voltage	[V]	300 - 300
Nominal current	[A]	10 - 10
Connection capacity AWG	AWG	- - -
General data		
Type of insulation material / insulation material group		PBT / IIIa
Inflammability class according to UL 94		V0
Drill hole diameter / pin dimensions	[mm]	1.4 / 1 x 1 mm

MDSTBW 2,5/ ...-G

Rated current	10
Rated insulation voltage for pollution degree 2	320
Pitch	5 / 5.08
Surge voltage category / pollution degree	III / 3 III / 2 II / 2
Rated insulation voltage	250 320 400
Rated surge voltage	4 4 4
Approval data (UL/CUL)	B C D
Nominal voltage	300 - 300
Nominal current	15 - 15
Connection capacity AWG	- - -
Approval data (CSA)	B C D
Nominal voltage	300 - 300
Nominal current	10 - 10
Connection capacity AWG	- - -
Type of insulation material / insulation material group	PBT / IIIa
Inflammability class according to UL 94	V0
Drill hole diameter / pin dimensions	1.4 / 1 x 1 mm

MDSTB 2,5/ ...-G1

Rated current	10
Rated insulation voltage for pollution degree 2	320
Pitch	5 / 5.08
Surge voltage category / pollution degree	III / 3 III / 2 II / 2
Rated insulation voltage	250 320 630
Rated surge voltage	4 4 4
Approval data (UL/CUL)	B C D
Nominal voltage	300 - 300
Nominal current	15 - 15
Connection capacity AWG	- - -
Approval data (CSA)	B C D
Nominal voltage	300 - 300
Nominal current	10 - 10
Connection capacity AWG	- - -
Type of insulation material / insulation material group	PA / I
Inflammability class according to UL 94	V0
Drill hole diameter / pin dimensions	1.4 / 1 x 1 mm

MDSTBV 2,5/...-G1

Rated current	10
Rated insulation voltage for pollution degree 2	320
Pitch	5 / 5.08
Surge voltage category / pollution degree	III / 3 III / 2 II / 2
Rated insulation voltage	250 320 630
Rated surge voltage	4 4 4
Approval data (UL/CUL)	B C D
Nominal voltage	300 - 300
Nominal current	12 - 12
Connection capacity AWG	- - -
Approval data (CSA)	B C D
Nominal voltage	300 - 300
Nominal current	10 - 10
Connection capacity AWG	- - -
Type of insulation material / insulation material group	PA / I
Inflammability class according to UL 94	V0
Drill hole diameter / pin dimensions	1.4 / 1 x 1 mm

No. of pos.	Dim. a [mm]
2	5.00
3	10.00
4	15.00
5	20.00
6	25.00
7	30.00
8	35.00
9	40.00
10	45.00
11	50.00
12	55.00
13	60.00
14	65.00
15	70.00
16	75.00
2	5.08
3	10.16
4	15.24
5	20.32
6	25.40
7	30.48
8	35.56
9	40.64
10	45.72
11	50.80
12	55.88
13	60.96
14	66.04
15	71.12
16	76.20

Classic plug-in connector with 5.0 to 7.62 mm pitch

CLASSIC COMBICON PLUG-IN connectors, pitches 5.0 or 5.08 mm



With stand-off,
without side panels, with offset levels,
plug-in direction parallel to the PCB



With side panels, without offset levels,
plug-in direction parallel to the PCB

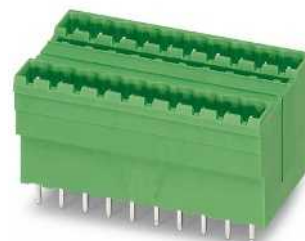

With side panels, without offset levels,
plug-in direction vertical to the PCB



Dimensional drawing

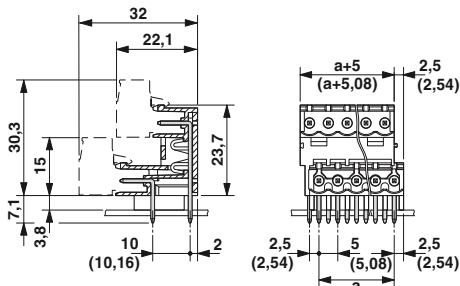

Drilling diagram

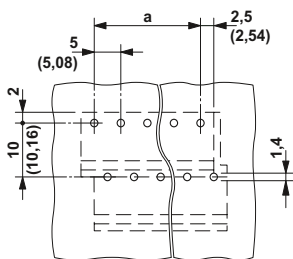

Ordering data

Type	Order No.	Pcs. / Pkt.
5.0 mm pitch, color: green		
MDSTBW 2,5/ 2-G	1802443	50
MDSTBW 2,5/ 3-G	1802427	50
MDSTBW 2,5/ 4-G	1846836	50
MDSTBW 2,5/ 5-G	1846849	50
MDSTBW 2,5/ 6-G	1846852	50
MDSTBW 2,5/ 7-G	1846865	50
MDSTBW 2,5/ 8-G	1846878	50
MDSTBW 2,5/ 9-G	1846881	50
MDSTBW 2,5/10-G	1846894	50
MDSTBW 2,5/11-G	1846904	50
MDSTBW 2,5/12-G	1846917	50
5.08 mm pitch, color: green		
MDSTBW 2,5/ 2-G-5,08	1802430	50
MDSTBW 2,5/ 3-G-5,08	1802414	50
MDSTBW 2,5/ 4-G-5,08	1842238	50
MDSTBW 2,5/ 5-G-5,08	1840010	50
MDSTBW 2,5/ 6-G-5,08	1842254	50
MDSTBW 2,5/ 7-G-5,08	1842267	50
MDSTBW 2,5/ 8-G-5,08	1842270	50
MDSTBW 2,5/ 9-G-5,08	1842283	50
MDSTBW 2,5/10-G-5,08	1842296	50
MDSTBW 2,5/11-G-5,08	1842306	50
MDSTBW 2,5/12-G-5,08	1842319	50



Dimensional drawing

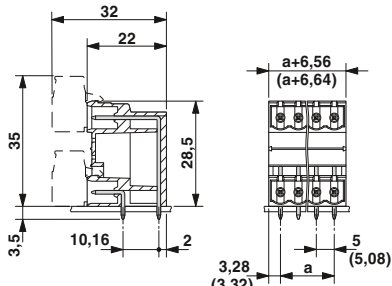

Drilling diagram

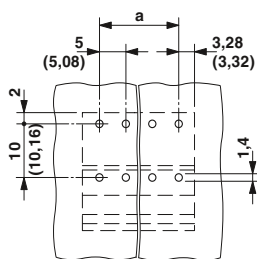

Ordering data

Type	Order No.	Pcs. / Pkt.
5.0 mm pitch, color: green		
MDSTB 2,5/ 3-G1	1736687	50
MDSTB 2,5/ 4-G1	1736690	50
MDSTB 2,5/ 6-G1	1762732	50
MDSTB 2,5/ 7-G1	1762745	50
MDSTB 2,5/ 8-G1	1762758	50
MDSTB 2,5/ 9-G1	1762761	50
MDSTB 2,5/10-G1	1762774	50
MDSTB 2,5/11-G1	1762787	50
MDSTB 2,5/12-G1	1762790	50
MDSTB 2,5/13-G1	1762800	50
MDSTB 2,5/14-G1	1762813	50
MDSTB 2,5/15-G1	1762826	50
MDSTB 2,5/16-G1	1762839	50
5.08 mm pitch, color: green		
MDSTB 2,5/ 3-G1-5,08	1762376	50
MDSTB 2,5/ 4-G1-5,08	1736713	50
MDSTB 2,5/ 5-G1-5,08	1938951	50
MDSTB 2,5/ 6-G1-5,08	1762415	50
MDSTB 2,5/ 7-G1-5,08	1762428	50
MDSTB 2,5/ 8-G1-5,08	1762431	50
MDSTB 2,5/ 9-G1-5,08	1762444	50
MDSTB 2,5/10-G1-5,08	1762457	50
MDSTB 2,5/11-G1-5,08	1762460	50
MDSTB 2,5/12-G1-5,08	1762703	50
MDSTB 2,5/13-G1-5,08	1762473	50
MDSTB 2,5/14-G1-5,08	1762486	50
MDSTB 2,5/15-G1-5,08	1762499	50
MDSTB 2,5/16-G1-5,08	1762509	50



Dimensional drawing

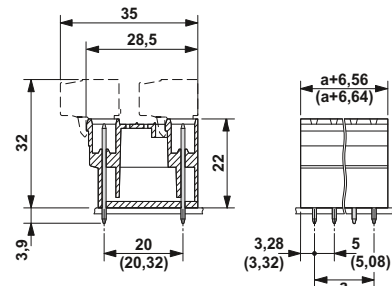

Drilling diagram

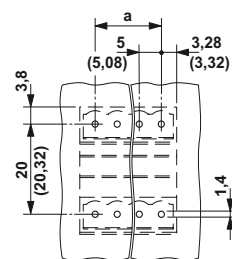

Ordering data

Type	Order No.	Pcs. / Pkt.
5.0 mm pitch, color: green		
MDSTBV 2,5/ 3-G1	1736726	50
MDSTBV 2,5/ 4-G1	1736739	50
MDSTBV 2,5/ 6-G1	1762884	50
MDSTBV 2,5/ 7-G1	1762897	50
MDSTBV 2,5/ 8-G1	1762907	50
MDSTBV 2,5/ 9-G1	1762910	50
MDSTBV 2,5/10-G1	1762923	50
MDSTBV 2,5/11-G1	1762936	50
MDSTBV 2,5/12-G1	1762949	50
MDSTBV 2,5/13-G1	1762952	50
MDSTBV 2,5/14-G1	1762965	50
MDSTBV 2,5/15-G1	1762978	50
MDSTBV 2,5/16-G1	1762981	50
5.08 mm pitch, color: green		
MDSTBV 2,5/ 3-G1-5,08	1736742	50
MDSTBV 2,5/ 4-G1-5,08	1736755	50
MDSTBV 2,5/ 6-G1-5,08	1762541	50
MDSTBV 2,5/ 7-G1-5,08	1762554	50
MDSTBV 2,5/ 8-G1-5,08	1762567	50
MDSTBV 2,5/ 9-G1-5,08	1762570	50
MDSTBV 2,5/10-G1-5,08	1762583	50
MDSTBV 2,5/11-G1-5,08	1762596	50
MDSTBV 2,5/12-G1-5,08	1762609	50
MDSTBV 2,5/13-G1-5,08	1762619	50
MDSTBV 2,5/14-G1-5,08	1762622	50
MDSTBV 2,5/15-G1-5,08	1762635	50
MDSTBV 2,5/16-G1-5,08	1762648	50

Classic plug-in connector with 5.0 to 7.62 mm pitch

CLASSIC COMBICON plug-in connectors, pitches 5.0 or 5.08 mm

Double-level header for the wave soldering processes

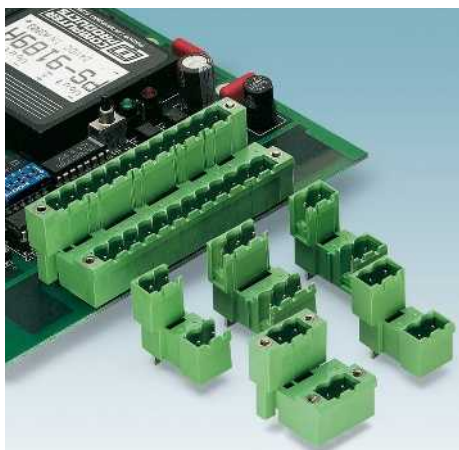

- Double-level header with offset levels
- Plug-in direction vertical to the PCB
- Improved view and accessibility to the lower level
- High contact density
- Versions with and without side panel, as well as with and without screw flange
- For versions with side panel on the right or left, visit: www.phoenixcontact.net/products

Notes:

In accordance with DIN EN 61984, COMBICON PLUG-IN connectors have no switching power. During designated use, they must not be plugged in or disconnected when carrying voltage or under load.

COMBICON select

You will find the possible plug-in connector combinations in COMBICON select at: www.phoenixcontact.net/products or starting on page 259.





Mounting screws for base element with threaded flange (...GF...): sheet metal screw ISO 1481-ST 2,2x6,5 C or ISO 7049-ST 2,2x6,5 C. Screw connection only permitted prior to soldering.



Without side panels, with offset levels, plug-in direction vertical to the PCB



Accessories

For all types	Type	Page
	Marker cards SK 5/3,8 or SK 5,08/3,8	798
	Coding section CR-MSTB Order No. 1734401	38
	Coding tab MSTB-BL Order No. 1755477	837
Only for MDSTBV 2,5/...-G		
	Side element for MD-STB(V); width 2.54 mm MDSTB-SE Order No. 1786679	

Dimensional drawing

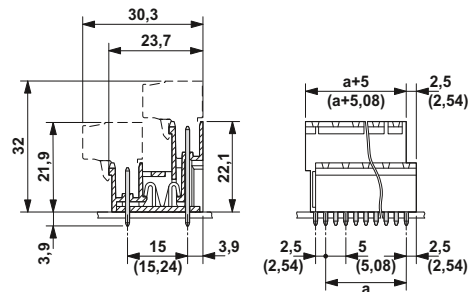

Drilling diagram

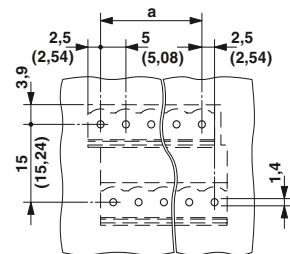

Technical data

Technical data in accordance to IEC / DIN VDE	
Rated current	[A] 10
Rated insulation voltage for pollution degree 2	[V] 320
Pitch	[mm] 5 / 5.08
Insulation coordination	
Surge voltage category / pollution degree	III / 3 III / 2 II / 2
Rated insulation voltage	[V] 250 320 400
Rated surge voltage	[kV] 4 4 4
Approval data (UL/CUL)	Use Group B C D
Nominal voltage	[V] 300 - 300
Nominal current	[A] 12 - 12
Connection capacity AWG	AWG - - -
Approval data (CSA)	Use Group B C D
Nominal voltage	[V] 300 - 300
Nominal current	[A] 10 - 10
Connection capacity AWG	AWG - - -
General data	
Type of insulation material / insulation material group	PBT / IIIa
Inflammability class according to UL 94	V0
Drill hole diameter / pin dimensions	[mm] 1.4 / 1 x 1 mm

Ordering data

No. of pos.	Dim. a [mm]	Type	Order No.	Pcs. / Pkt.
5.0 mm pitch, color: green				
2	5.00	MDSTBV 2,5/ 2-G	1763032	50
3	10.00	MDSTBV 2,5/ 3-G	1763045	50
4	15.00	MDSTBV 2,5/ 4-G	1845950	50
5	20.00	MDSTBV 2,5/ 5-G	1845963	50
6	25.00	MDSTBV 2,5/ 6-G	1845976	50
7	30.00	MDSTBV 2,5/ 7-G	1845989	50
8	35.00	MDSTBV 2,5/ 8-G	1845992	50
9	40.00	MDSTBV 2,5/ 9-G	1846001	50
10	45.00	MDSTBV 2,5/10-G	1846014	50
11	50.00	MDSTBV 2,5/11-G	1846027	50
12	55.00	MDSTBV 2,5/12-G	1846030	50
5.08 mm pitch, color: green				
2	5.08	MDSTBV 2,5/ 2-G-5,08	1763074	50
3	10.16	MDSTBV 2,5/ 3-G-5,08	1763087	50
4	15.24	MDSTBV 2,5/ 4-G-5,08	1845507	50
5	20.32	MDSTBV 2,5/ 5-G-5,08	1762004	50
6	25.40	MDSTBV 2,5/ 6-G-5,08	1845523	50
7	30.48	MDSTBV 2,5/ 7-G-5,08	1845536	50
8	35.56	MDSTBV 2,5/ 8-G-5,08	1845549	50
9	40.64	MDSTBV 2,5/ 9-G-5,08	1845552	50
10	45.72	MDSTBV 2,5/10-G-5,08	1845565	50
11	50.80	MDSTBV 2,5/11-G-5,08	1845578	50
12	55.88	MDSTBV 2,5/12-G-5,08	1845581	50

Classic plug-in connector with 5.0 to 7.62 mm pitch

CLASSIC COMBICON PLUG-IN connectors, pitches 5.0 or 5.08 mm



With side panels and offset levels,
plug-in direction vertical to the PCB

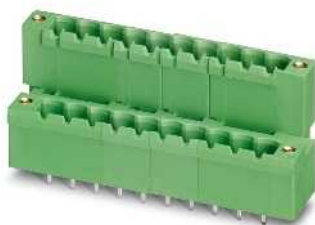

With threaded flange and offset levels,
plug-in direction vertical to the PCB



Dimensional drawing

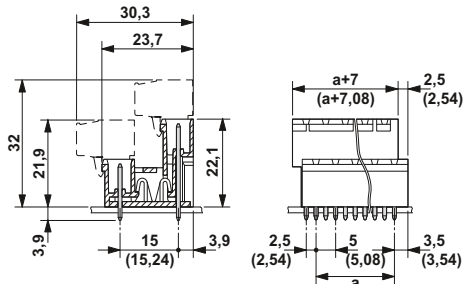

Drilling diagram

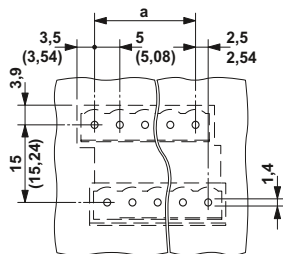

Ordering data

Type	Order No.	Pcs. / Pkt.
5.0 mm pitch, color: green		
MDSTBVA 2,5/ 2-G	1845785	50
MDSTBVA 2,5/ 3-G	1845798	50
MDSTBVA 2,5/ 4-G	1845808	50
MDSTBVA 2,5/ 5-G	1845811	50
MDSTBVA 2,5/ 6-G	1845824	50
MDSTBVA 2,5/ 7-G	1845837	50
MDSTBVA 2,5/ 8-G	1845840	50
MDSTBVA 2,5/ 9-G	1845853	50
MDSTBVA 2,5/10-G	1845866	50
MDSTBVA 2,5/11-G	1845879	50
MDSTBVA 2,5/12-G	1845882	50
5.08 mm pitch, color: green		
MDSTBVA 2,5/ 2-G-5,08	1845332	50
MDSTBVA 2,5/ 3-G-5,08	1845345	50
MDSTBVA 2,5/ 4-G-5,08	1845358	50
MDSTBVA 2,5/ 5-G-5,08	1845361	50
MDSTBVA 2,5/ 6-G-5,08	1845374	50
MDSTBVA 2,5/ 7-G-5,08	1845387	50
MDSTBVA 2,5/ 8-G-5,08	1845390	50
MDSTBVA 2,5/ 9-G-5,08	1845400	50
MDSTBVA 2,5/10-G-5,08	1845413	50
MDSTBVA 2,5/11-G-5,08	1845426	50
MDSTBVA 2,5/12-G-5,08	1845439	50



Dimensional drawing

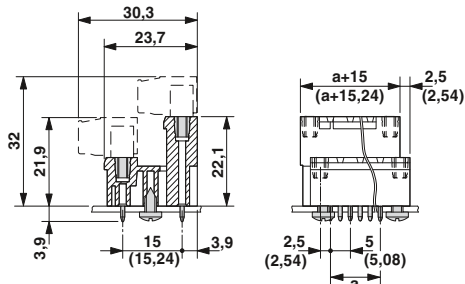

Drilling diagram

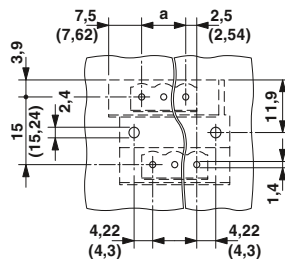

Ordering data

Type	Order No.	Pcs. / Pkt.
5.0 mm pitch, color: green		
MDSTBV 2,5/ 2-GF	1846085	50
MDSTBV 2,5/ 3-GF	1846098	50
MDSTBV 2,5/ 4-GF	1846108	50
MDSTBV 2,5/ 5-GF	1846111	50
MDSTBV 2,5/ 6-GF	1846124	50
MDSTBV 2,5/ 7-GF	1846137	50
MDSTBV 2,5/ 8-GF	1846140	50
MDSTBV 2,5/ 9-GF	1846153	50
MDSTBV 2,5/10-GF	1846166	50
MDSTBV 2,5/11-GF	1846179	50
MDSTBV 2,5/12-GF	1846182	50
5.08 mm pitch, color: green		
MDSTBV 2,5/ 2-GF-5,08	1845633	50
MDSTBV 2,5/ 3-GF-5,08	1845646	50
MDSTBV 2,5/ 4-GF-5,08	1845659	50
MDSTBV 2,5/ 5-GF-5,08	1845662	50
MDSTBV 2,5/ 6-GF-5,08	1845675	50
MDSTBV 2,5/ 7-GF-5,08	1845688	50
MDSTBV 2,5/ 8-GF-5,08	1845691	50
MDSTBV 2,5/ 9-GF-5,08	1845701	50
MDSTBV 2,5/10-GF-5,08	1845714	50
MDSTBV 2,5/11-GF-5,08	1845727	50
MDSTBV 2,5/12-GF-5,08	1845730	50

Classic plug-in connector with 5.0 to 7.62 mm pitch

CLASSIC COMBICON plug-in connectors, pitches 5.0 or 5.08 mm

Inverted header for the wave soldering processes

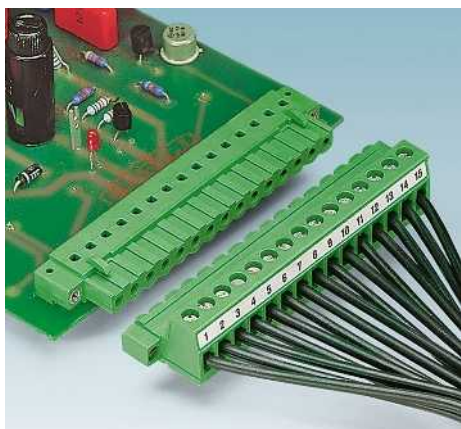

- Use in contact protected applications
- Horizontal and vertical design
- Versions with and without a threaded flange
- Pairs of guide rails can be used as a 90° board to board connection
- Combination with MSTB 2,5 headers for primary/secondary/PCB connection
- Clear separation of PCB inputs/outputs
- Higher numbers of positions up to 24-pos. can be found at: www.phoenixcontact.net/products
- For various combination options with the MSTB 2,5 plug-in system, refer to page 34

Notes:

In accordance with DIN EN 61984, COMBICON PLUG-IN connectors have no switching power. During designated use, they must not be plugged in or disconnected when carrying voltage or under load.

The inverted contact system is explained on page 34

Dimensional drawing of FLRP-ICV and PCB cutout can be found on page 838.

Mounting screws for base element with threaded flange (...GF...): sheet metal screw ISO 1481-ST 2,2x6,5 C or ISO 7049-ST 2,2x6,5 C. Screw connection only permitted prior to soldering.



Plug-in direction parallel to the PCB



Dimensional drawing

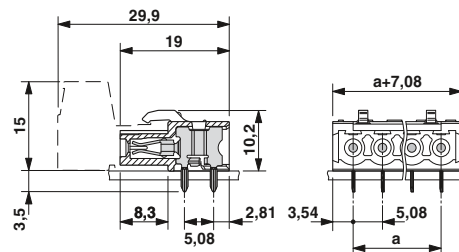

Drilling diagram

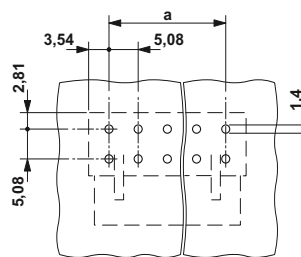

Accessories		
For all types	Type	Page
	Coding profile CP-MSTB Order No. 1734634	38
	Reducing plug RPS Order No. 0201647	831
	Test plug MPS	831
	Marker cards SK 5,08/3,8	798
Only for ICV 2,5/...-G-5,08		
	Pair of guide rails for a PCB FLRP-ICV 80 Order No. 1808353	837

Technical data

Technical data in accordance to IEC / DIN VDE

Rated current	[A]	12
Rated insulation voltage for pollution degree 2	[V]	320
Pitch	[mm]	5.08
Insulation coordination		
Surge voltage category / pollution degree		III / 3 III / 2 II / 2
Rated insulation voltage	[V]	320 320 630
Rated surge voltage	[kV]	4 4 4
Approval data (UL/CUL)	Use Group	B C D
Nominal voltage	[V]	250 - 300
Nominal current	[A]	12 - 10
Connection capacity AWG	AWG	- - -
Approval data (CSA)	Use Group	B C D
Nominal voltage	[V]	300 - 300
Nominal current	[A]	10 - 10
Connection capacity AWG	AWG	- - -
General data		
Type of insulation material / insulation material group		PA / I
Inflammability class according to UL 94		V0
Drill hole diameter / pin dimensions	[mm]	1.4 / 1,2 x 0,5

Ordering data

No. of pos.	Dim. a [mm]	Type	Order No.	Pcs. / Pkt.
5.08 mm pitch, color: green				
2	5.08	IC 2,5/ 2-G-5,08	1786404	50
3	10.16	IC 2,5/ 3-G-5,08	1786417	50
4	15.24	IC 2,5/ 4-G-5,08	1786420	50
5	20.32	IC 2,5/ 5-G-5,08	1786433	50
6	25.40	IC 2,5/ 6-G-5,08	1786446	50
7	30.48	IC 2,5/ 7-G-5,08	1786459	50
8	35.56	IC 2,5/ 8-G-5,08	1786462	50
9	40.64	IC 2,5/ 9-G-5,08	1786475	50
10	45.72	IC 2,5/10-G-5,08	1786488	50
11	50.80	IC 2,5/11-G-5,08	1786491	50
12	55.88	IC 2,5/12-G-5,08	1786501	50
13	60.96	IC 2,5/13-G-5,08	1786514	50
14	66.04	IC 2,5/14-G-5,08	1786527	50
15	71.12	IC 2,5/15-G-5,08	1786530	50
16	76.20	IC 2,5/16-G-5,08	1786543	50

Classic plug-in connector with 5.0 to 7.62 mm pitch

CLASSIC COMBICON PLUG-IN connectors, pitches 5.0 or 5.08 mm



With threaded flange,
plug-in direction parallel to the PCB



Plug-in direction vertical to the PCB



With threaded flange,
plug-in direction vertical to the PCB



Dimensional drawing

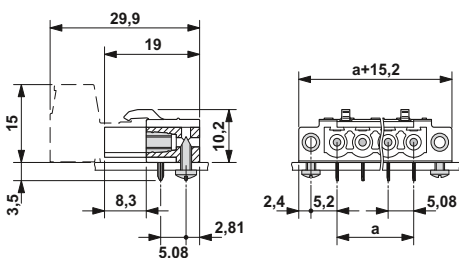

Drilling diagram

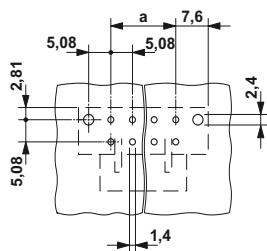

Dimensional drawing

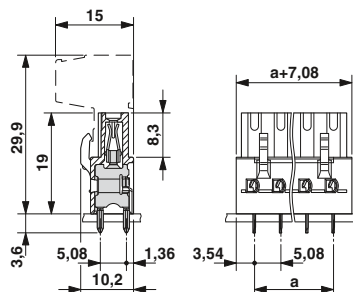

Drilling diagram

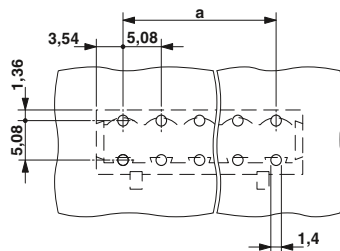

Dimensional drawing

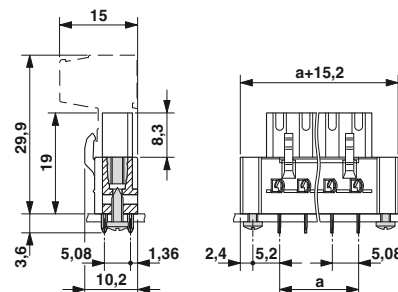

Drilling diagram

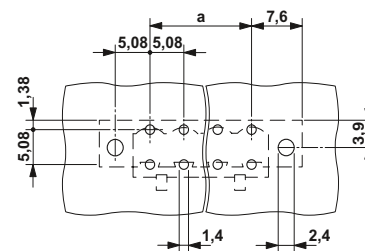

Ordering data

Type	Order No.	Pcs. / Pkt.
5.08 mm pitch, color: green		
IC 2,5/ 2-GF-5,08	1825129	50
IC 2,5/ 3-GF-5,08	1825132	50
IC 2,5/ 4-GF-5,08	1825145	50
IC 2,5/ 5-GF-5,08	1825158	50
IC 2,5/ 6-GF-5,08	1825161	50
IC 2,5/ 7-GF-5,08	1825174	50
IC 2,5/ 8-GF-5,08	1825187	50
IC 2,5/ 9-GF-5,08	1825190	50
IC 2,5/10-GF-5,08	1825200	50
IC 2,5/11-GF-5,08	1825213	50
IC 2,5/12-GF-5,08	1825226	50
IC 2,5/13-GF-5,08	1825239	50
IC 2,5/14-GF-5,08	1825242	50
IC 2,5/15-GF-5,08	1825255	50
IC 2,5/16-GF-5,08	1825268	50

Ordering data

Type	Order No.	Pcs. / Pkt.
5.08 mm pitch, color: green		
ICV 2,5/ 2-G-5,08	1785942	50
ICV 2,5/ 3-G-5,08	1785955	50
ICV 2,5/ 4-G-5,08	1785968	50
ICV 2,5/ 5-G-5,08	1785971	50
ICV 2,5/ 6-G-5,08	1785984	50
ICV 2,5/ 7-G-5,08	1785997	50
ICV 2,5/ 8-G-5,08	1786006	50
ICV 2,5/ 9-G-5,08	1786019	50
ICV 2,5/10-G-5,08	1786022	50
ICV 2,5/11-G-5,08	1786035	50
ICV 2,5/12-G-5,08	1786048	50
ICV 2,5/13-G-5,08	1786051	50
ICV 2,5/14-G-5,08	1786064	50
ICV 2,5/15-G-5,08	1786077	50
ICV 2,5/16-G-5,08	1786080	50

Ordering data

Type	Order No.	Pcs. / Pkt.
5.08 mm pitch, color: green		
ICV 2,5/ 2-GF-5,08	1825695	50
ICV 2,5/ 3-GF-5,08	1825705	50
ICV 2,5/ 4-GF-5,08	1825718	50
ICV 2,5/ 5-GF-5,08	1825721	50
ICV 2,5/ 6-GF-5,08	1825734	50
ICV 2,5/ 7-GF-5,08	1825747	50
ICV 2,5/ 8-GF-5,08	1825750	50
ICV 2,5/ 9-GF-5,08	1825763	50
ICV 2,5/10-GF-5,08	1825776	50
ICV 2,5/11-GF-5,08	1825789	50
ICV 2,5/12-GF-5,08	1825792	50
ICV 2,5/13-GF-5,08	1825802	50
ICV 2,5/14-GF-5,08	1825815	50
ICV 2,5/15-GF-5,08	1825828	50
ICV 2,5/16-GF-5,08	1825831	50

Classic plug-in connector with 5.0 to 7.62 mm pitch

CLASSIC COMBICON plug-in connectors, pitches 7.5 or 7.62 mm

Plug with a screw connection

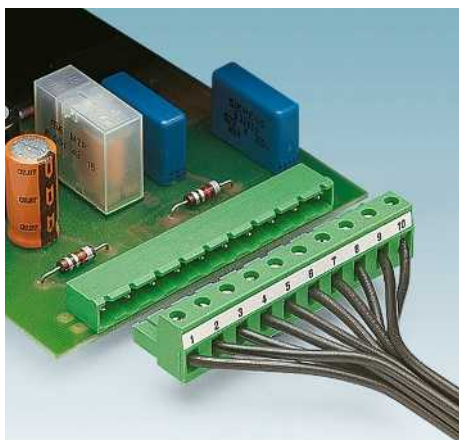

- Plug components for 630 V applications (III/2)
- Plug-in direction parallel to the conductor axis
- Versions with and without a screw flange
- FRONT-GMSTB 2,5 plug, with front screw connection

Notes:

In accordance with DIN EN 61984, COMBICON PLUG-IN connectors have no switching power. During designated use, they must not be plugged in or disconnected when carrying voltage or under load.

COMBICON select

You will find the possible plug-in connector combinations in COMBICON select at: www.phoenixcontact.net/products or starting on page 259.

The maximum torque for the screw flange is 0.3 Nm.

¹⁾ Please observe the derating curves. Derating curves of further combination options on request.



Plug with screw connection



Dimensional drawing

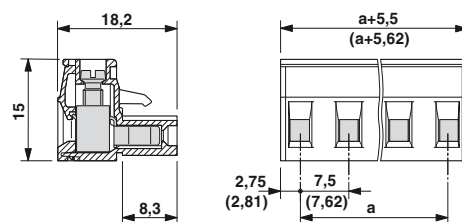

Note derating curves

Derating curves, determined as per DIN EN 61984 (VDE 0627):2002-09
Representation based on DIN EN 60512-5-2:2003-01
Connected conductor cross section = 2.5 mm²
Reduction factor = 0.8
Number of positions = see diagram

Accessories

For all types	Type	Page
	Marker cards SK 7,5/3,8 or SK 7,62/3,8	799
	Coding profile CP-MSTB Order No. 1734634	38
	Screwdriver SZS 0,6 x 3,5 Order No. 1205053	
Only for FRONT-GMSTB 2,5/...-...		
	Pullout aid for plugs arranged one after the other, width: 30 mm FRONT-MSTB-EW Order No. 1763058	

Technical data

Technical data in accordance to IEC / DIN VDE	
Rated current / conductor cross section	[A] / [mm ²]
Rated insulation voltage for pollution degree 2	[V]
Pitch	[mm]
Connection capacity	
Solid / stranded	[mm ²] / [mm ²] / AWG
Stranded with ferrules without plastic sleeve	[mm ²]
Stranded with ferrules with plastic sleeve	[mm ²]
Multi-conductor connection capacity (two conductors with the same cross section)	
Solid / stranded	[mm ²]
Stranded with ferrules without plastic sleeve	[mm ²]
Stranded with TWIN ferrule with plastic sleeve	[mm ²]
Insulation coordination	
Surge voltage category / pollution degree	
Rated insulation voltage	[V]
Rated surge voltage	[kV]
Approval data (UL/CUL)	Use Group
Nominal voltage	[V]
Nominal current	[A]
Connection capacity AWG	AWG
Approval data (CSA)	Use Group
Nominal voltage	[V]
Nominal current	[A]
Connection capacity AWG	AWG
General data	
Stripping length	[mm]
Screw thread	
Tightening torque	[Nm]
Type of insulation material / insulation material group	
Inflammability class according to UL 94	

12 ¹⁾ / 2.5		
630		
7.5 / 7.62		
0.2 - 2.5 / 0.2 - 2.5 / 24 - 12		
0.25 - 2.5		
0.25 - 2.5		
0.2 - 1 / 0.2 - 1.5		
0.25 - 1		
0.5 - 1		
III / 3	III / 2	II / 2
400	630	1000
6	6	6
B	C	D
250	-	300
12	-	10
30 - 12	-	30 - 12
B	C	D
300	-	300
10	-	10
28 - 12	-	28 - 12
7		
M3		
0.5 - 0.6		
PA / I		
V0		

No. of pos.	Dim. a [mm]
2	7.50
3	15.00
4	22.50
5	30.00
6	37.50
7	45.00
8	52.50
9	60.00
10	67.50
11	75.00
12	82.50

Ordering data

Type	Order No.	Pcs. / Pkt.
7.5 mm pitch, color: green		
GMSTB 2,5/ 2-ST	1766880	50
GMSTB 2,5/ 3-ST	1766893	50
GMSTB 2,5/ 4-ST	1766903	50
GMSTB 2,5/ 5-ST	1766916	50
GMSTB 2,5/ 6-ST	1766929	50
GMSTB 2,5/ 7-ST	1766932	50
GMSTB 2,5/ 8-ST	1766945	50
GMSTB 2,5/ 9-ST	1766958	50
GMSTB 2,5/10-ST	1766961	50
GMSTB 2,5/11-ST	1766974	50
GMSTB 2,5/12-ST	1766987	50
Plugs, 7.62 mm pitch, color: green		
GMSTB 2,5/ 2-ST-7,62	1766990	50
GMSTB 2,5/ 3-ST-7,62	1767012	50
GMSTB 2,5/ 4-ST-7,62	1767025	50
GMSTB 2,5/ 5-ST-7,62	1767038	50
GMSTB 2,5/ 6-ST-7,62	1767041	50
GMSTB 2,5/ 7-ST-7,62	1767054	50
GMSTB 2,5/ 8-ST-7,62	1767067	50
GMSTB 2,5/ 9-ST-7,62	1767070	50
GMSTB 2,5/10-ST-7,62	1767083	50
GMSTB 2,5/11-ST-7,62	1767096	50
GMSTB 2,5/12-ST-7,62	1767106	50

Classic plug-in connector with 5.0 to 7.62 mm pitch

CLASSIC COMBICON plug-in connectors, pitches 7.5 or 7.62 mm

Plug with a screw connection

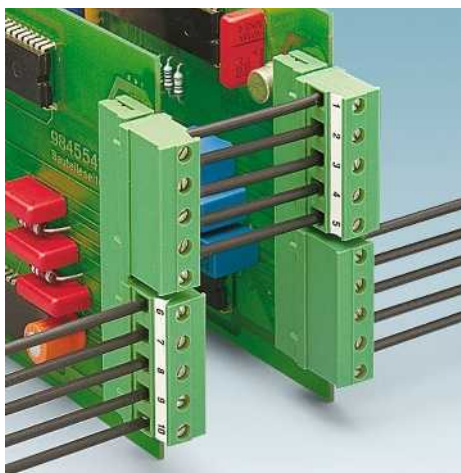

- Plug components for 630 V applications (III/2)
- Plug-in direction vertical to the conductor axis
- Versions with a screw flange and a 7.62 mm pitch

GMVSTBR 2,5/...-ST

- Conductor entry on the coded side of the connector

GMVSTBW 2,5/...-ST

- Conductor entry on the rippled side of the connector

Notes:

In accordance with DIN EN 61984, COMBICON PLUG-IN connectors have no switching power. During designated use, they must not be plugged in or disconnected when carrying voltage or under load.

COMBICON select

You will find the possible plug-in connector combinations in COMBICON select at: www.phoenixcontact.net/products or starting on page 259.

The maximum torque for the screw flange is 0.3 Nm.

¹⁾ Derating curves on request.



Conductor entry facing coding side



Dimensional drawing

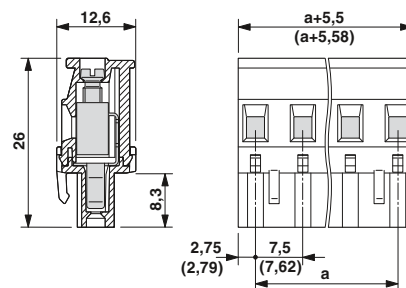

Accessories

For all types	Type	Page
	Marker cards SK 7,5/3,8 or SK 7,62/3,8	799
	Coding profile CP-MSTB Order No. 1734634	38
	Screwdriver SZS 0,6 x 3,5 Order No. 1205053	

Technical data

Technical data in accordance to IEC / DIN VDE	
Rated current / conductor cross section	[A] / [mm ²]
Rated insulation voltage for pollution degree 2	[V]
Pitch	[mm]
Connection capacity	
Solid / stranded	[mm ²] / [mm ²] / AWG
Stranded with ferrules without plastic sleeve	[mm ²]
Stranded with ferrules with plastic sleeve	[mm ²]
Multi-conductor connection capacity (two conductors with the same cross section)	
Solid / stranded	[mm ²]
Stranded with ferrules without plastic sleeve	[mm ²]
Stranded with TWIN ferrule with plastic sleeve	[mm ²]
Insulation coordination	
Surge voltage category / pollution degree	
Rated insulation voltage	[V]
Rated surge voltage	[kV]
Approval data (UL/CUL)	Use Group
Nominal voltage	[V]
Nominal current	[A]
Connection capacity AWG	AWG
Approval data (CSA)	Use Group
Nominal voltage	[V]
Nominal current	[A]
Connection capacity AWG	AWG
General data	
Stripping length	[mm]
Screw thread	
Tightening torque	[Nm]
Type of insulation material / insulation material group	
Inflammability class according to UL 94	

	12 ¹⁾ / 2.5
	630
	7.5 / 7.62
	0.2 - 2.5 / 0.2 - 2.5 / 24 - 12
	0.25 - 2.5
	0.25 - 2.5
	0.2 - 1 / 0.2 - 1.5
	0.25 - 1
	0.5 - 1
	III / 3 III / 2 II / 2
	500 630 1000
	6 6 6
	B C D
	250 - 300
	12 - 10
	30 - 12 - 30 - 12
	B C D
	300 - 300
	10 - 10
	28 - 12 - 28 - 12
	7
	M3
	0.5 - 0.6
	PA / I
	V0

No. of pos.	Dim. a [mm]
2	7.50
3	15.00
4	22.50
5	30.00
6	37.50
7	45.00
8	52.50
9	60.00
10	67.50
11	75.00
12	82.50

Ordering data

Type	Order No.	Pcs. / Pkt.
7.5 mm pitch, color: green		
GMVSTBR 2,5/ 2-ST	1737709	50
GMVSTBR 2,5/ 3-ST	1737712	50
GMVSTBR 2,5/ 4-ST	1737725	50
GMVSTBR 2,5/ 5-ST	1737738	50
GMVSTBR 2,5/ 6-ST	1737741	50
GMVSTBR 2,5/ 7-ST	1737754	50
GMVSTBR 2,5/ 8-ST	1737767	50
GMVSTBR 2,5/ 9-ST	1737770	50
GMVSTBR 2,5/10-ST	1737783	50
GMVSTBR 2,5/11-ST	1737796	50
GMVSTBR 2,5/12-ST	1737806	50
Plugs, 7.62 mm pitch, color: green		
GMVSTBR 2,5/ 2-ST-7,62	1832523	50
GMVSTBR 2,5/ 3-ST-7,62	1832536	50
GMVSTBR 2,5/ 4-ST-7,62	1832549	50
GMVSTBR 2,5/ 5-ST-7,62	1832552	50
GMVSTBR 2,5/ 6-ST-7,62	1832565	50
GMVSTBR 2,5/ 7-ST-7,62	1832578	50
GMVSTBR 2,5/ 8-ST-7,62	1832581	50
GMVSTBR 2,5/ 9-ST-7,62	1832594	50
GMVSTBR 2,5/10-ST-7,62	1832604	50
GMVSTBR 2,5/11-ST-7,62	1832617	50
GMVSTBR 2,5/12-ST-7,62	1832620	50

Classic plug-in connector with 5.0 to 7.62 mm pitch

CLASSIC COMBICON plug-in connectors, pitches 7.5 or 7.62 mm

Inverted plugs with a screw connection

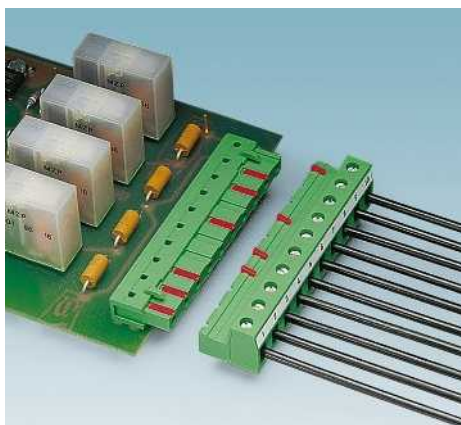

- Plug for 630 V shock-proof applications (III/2)
- Plug-in direction parallel to the conductor axis
- Versions with and without a screw flange/threaded flange
- For various combination options with GMSTB 2,5 plug-in system, refer to page 34

Notes:

In accordance with DIN EN 61984, COMBICON PLUG-IN connectors have no switching power. During designated use, they must not be plugged in or disconnected when carrying voltage or under load.

COMBICON select

You will find the possible plug-in connector combinations in COMBICON select at: www.phoenixcontact.net/products or starting on page 259.

The maximum torque for the screw flange is 0.3 Nm.

¹⁾ Please observe the derating curves. Derating curves of further combination options on request.

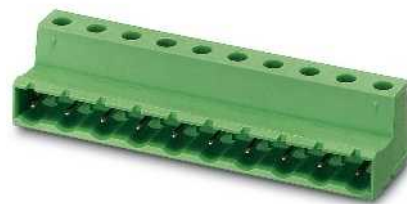

Inverted plug with screw connection





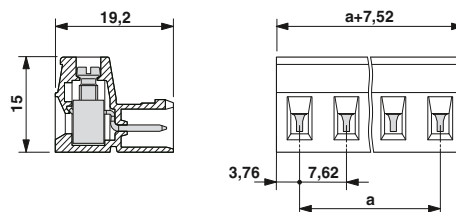

Dimensional drawing



Note derating curves

Derating curves, determined as per DIN EN 61984 (VDE 0627):2002-09
Representation based on DIN EN 60512-5-2:2003-01
Connected conductor cross section = 2.5 mm²
Reduction factor = 0.8
Number of positions = see diagram

Accessories

For all types	Type	Page
	Marker cards SK 7,62/3,8	799
	Coding section CR-MSTB Order No. 1734401	38
	Screwdriver SZS 0,6 x 3,5 Order No. 1205053	
	Coding tab MSTB-BL Order No. 1755477	837

Technical data

Technical data in accordance to IEC / DIN VDE	
Rated current / conductor cross section	[A] / [mm ²]
Rated insulation voltage for pollution degree 2	[V]
Pitch	[mm]
Connection capacity	
Solid / stranded	[mm ²] / [mm ²] / AWG
Stranded with ferrules without plastic sleeve	[mm ²]
Stranded with ferrules with plastic sleeve	[mm ²]
Multi-conductor connection capacity (two conductors with the same cross section)	
Solid / stranded	[mm ²]
Stranded with ferrules without plastic sleeve	[mm ²]
Stranded with TWIN ferrule with plastic sleeve	[mm ²]
Insulation coordination	
Surge voltage category / pollution degree	
Rated insulation voltage	[V]
Rated surge voltage	[kV]
Approval data (UL/CUL)	Use Group
Nominal voltage	[V]
Nominal current	[A]
Connection capacity AWG	AWG
Approval data (CSA)	Use Group
Nominal voltage	[V]
Nominal current	[A]
Connection capacity AWG	AWG
General data	
Stripping length	[mm]
Screw thread	
Tightening torque	[Nm]
Type of insulation material / insulation material group	
Inflammability class according to UL 94	

	12 ¹⁾ / 2.5
	630
	7.62
	0.2 - 2.5 / 0.2 - 2.5 / 24 - 12
	0.25 - 2.5
	0.25 - 2.5
	0.2 - 1 / 0.2 - 1.5
	0.25 - 1
	0.5 - 1
	III / 3 III / 2 II / 2
	400 630 1000
	6 6 6
	B C D
	250 - 300
	12 - 10
	30 - 12 - 30 - 12
	B C D
	300 - 300
	10 - 10
	28 - 12 - 28 - 12
	7
	M3
	0.5 - 0.6
	PA / I
	V0

No. of pos.	Dim. a [mm]
2	7.62
3	15.24
4	22.86
5	30.48
6	38.10
7	45.72
8	53.34
9	60.96
10	68.58
11	76.20
12	83.82

Ordering data

Type	Order No.	Pcs. / Pkt.
Pitch 7.62 mm, color: green		
GIC 2,5/ 2-ST-7,62	1828809	50
GIC 2,5/ 3-ST-7,62	1828812	50
GIC 2,5/ 4-ST-7,62	1828825	50
GIC 2,5/ 5-ST-7,62	1828838	50
GIC 2,5/ 6-ST-7,62	1828841	50
GIC 2,5/ 7-ST-7,62	1828854	50
GIC 2,5/ 8-ST-7,62	1828867	50
GIC 2,5/ 9-ST-7,62	1828870	50
GIC 2,5/10-ST-7,62	1828883	50
GIC 2,5/11-ST-7,62	1828896	50
GIC 2,5/12-ST-7,62	1828906	50

Classic plug-in connector with 5.0 to 7.62 mm pitch

CLASSIC COMBICON PLUG-IN connectors, pitches 7.5 or 7.62 mm

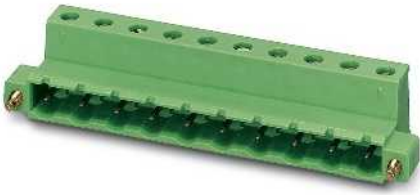

With screw flange, for screw connection using inverted headers

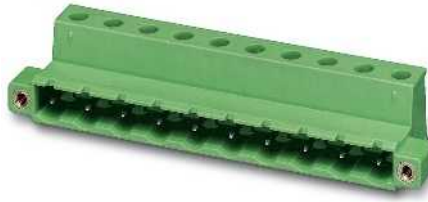

With threaded flange for screw connection using GMSTB connectors



Dimensional drawing

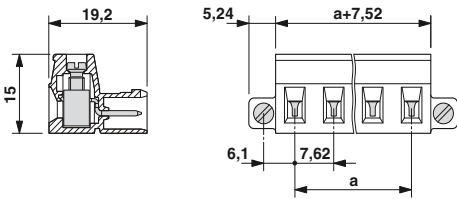

Dimensional drawing

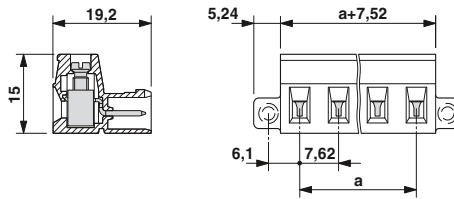

Representative derating curve

Type: GIC 2,5/...-ST-7,62 with GICV 2,5/...-G-7,62

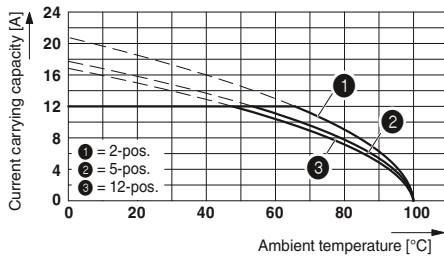

Ordering data

Type	Order No.	Pcs. / Pkt.
Pitch 7.62 mm, color: green		
GIC 2,5/ 2-STF-7,62	1858879	50
GIC 2,5/ 3-STF-7,62	1858882	50
GIC 2,5/ 4-STF-7,62	1858895	50
GIC 2,5/ 5-STF-7,62	1858905	50
GIC 2,5/ 6-STF-7,62	1858918	50
GIC 2,5/ 7-STF-7,62	1858921	50
GIC 2,5/ 8-STF-7,62	1858934	50
GIC 2,5/ 9-STF-7,62	1858947	50
GIC 2,5/10-STF-7,62	1858950	50
GIC 2,5/11-STF-7,62	1858963	50
GIC 2,5/12-STF-7,62	1858976	50

Ordering data

Type	Order No.	Pcs. / Pkt.
Pitch 7.62 mm, color: green		
GIC 2,5/ 2-STGF-7,62	1849888	50
GIC 2,5/ 3-STGF-7,62	1849891	50
GIC 2,5/ 4-STGF-7,62	1849901	50
GIC 2,5/ 5-STGF-7,62	1849914	50
GIC 2,5/ 6-STGF-7,62	1849927	50
GIC 2,5/ 7-STGF-7,62	1849930	50
GIC 2,5/ 8-STGF-7,62	1849943	50
GIC 2,5/ 9-STGF-7,62	1849956	50
GIC 2,5/10-STGF-7,62	1849969	50
GIC 2,5/11-STGF-7,62	1849972	50
GIC 2,5/12-STGF-7,62	1849985	50

Classic plug-in connector with 5.0 to 7.62 mm pitch

CLASSIC COMBICON plug-in connectors, pitches 7.5 or 7.62 mm

Plug with push-in spring connection

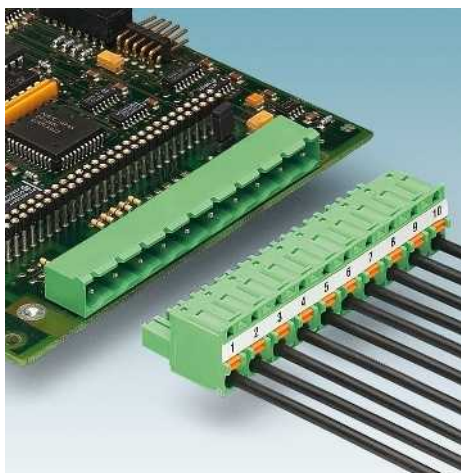

- Convenient conductor connection, thanks to push-in spring connection for 630 V applications
- Two test connections to accommodate 2 mm Ø test pins or 2.3 mm Ø test connectors

Notes:

In accordance with DIN EN 61984, COMBICON PLUG-IN connectors have no switching power. During designated use, they must not be plugged in or disconnected when carrying voltage or under load.

COMBICON select

You will find the possible plug-in connector combinations in COMBICON select at: www.phoenixcontact.net/products or starting on page 259.

The maximum torque for the screw flange is 0.3 Nm.

¹⁾ Please observe the derating curves. Derating curves of further combination options on request.



Plug with push-in spring connection



Dimensional drawing

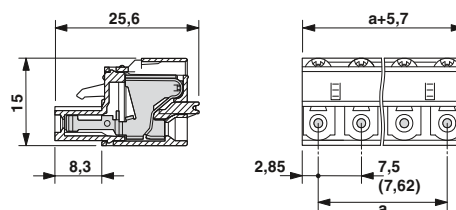

Note derating curves

Derating curves, determined as per DIN EN 61984 (VDE 0627):2002-09
Representation based on DIN EN 60512-5-2:2003-01
Connected conductor cross section = 2.5 mm²
Reduction factor = 0.8
Number of positions = see diagram

Accessories		
For all types	Type	Page
	Marker cards SK 7,5/3,8 or SK 7,62/3,8	799
	Coding profile CP-MSTB Order No. 1734634	38
	Screwdriver SZS 0,6 x 3,5 Order No. 1205053	
	Ferrules with and without plastic sleeve	834
	Crimping pliers for 0.25 to 6 mm ² CRIMPFOX 6 Order No. 1212034	
	Test plug MPS	831

Technical data

Technical data in accordance to IEC / DIN VDE	
Rated current / conductor cross section	[A] / [mm ²]
Rated insulation voltage for pollution degree 2	[V]
Pitch	[mm]
Connection capacity	
Solid / stranded	[mm ²] / [mm ²] / AWG
Stranded with ferrules without plastic sleeve	[mm ²]
Stranded with ferrules with plastic sleeve	[mm ²]
Multi-conductor connection capacity (two conductors with the same cross section)	
Solid / stranded	[mm ²]
Stranded with ferrules without plastic sleeve	[mm ²]
Stranded with TWIN ferrule with plastic sleeve	[mm ²]
Insulation coordination	
Surge voltage category / pollution degree	III / 3 III / 2 II / 2
Rated insulation voltage	[V]
Rated surge voltage	[kV]
Approval data (UL/CUL)	Use Group
Nominal voltage	[V]
Nominal current	[A]
Connection capacity AWG	AWG
Approval data (CSA)	Use Group
Nominal voltage	[V]
Nominal current	[A]
Connection capacity AWG	AWG
General data	
Stripping length	[mm]
Type of insulation material / insulation material group	
Inflammability class according to UL 94	

	12 ¹⁾ / 2.5
	630
	7.5 / 7.62
	0.2 - 2.5 / 0.2 - 2.5 / 24 - 12
	0.25 - 2.5
	0.25 - 2.5
	- / -
	-
	0.5 - 1
	III / 3 III / 2 II / 2
	400 630 1000
	6 6 6
	B C D
	250 - 300
	10 - 10
	26 - 12 - 26 - 12
	B C D
	300 - 300
	12 - 10
	24 - 12 - 24 - 12
	10
	PA / I
	V0

No. of pos.	Dim. a [mm]
2	7.50
3	15.00
4	22.50
5	30.00
6	37.50
7	45.00
8	52.50
9	60.00
10	67.50
11	75.00
12	82.50

Ordering data

Type	Order No.	Pcs. / Pkt.
7.5 mm pitch, color: green		
GFKC 2,5/ 2-ST-7,5	1939413	50
GFKC 2,5/ 3-ST-7,5	1939426	50
GFKC 2,5/ 4-ST-7,5	1939439	50
GFKC 2,5/ 5-ST-7,5	1939442	50
GFKC 2,5/ 6-ST-7,5	1939455	50
GFKC 2,5/ 7-ST-7,5	1939468	50
GFKC 2,5/ 8-ST-7,5	1939471	50
GFKC 2,5/ 9-ST-7,5	1939484	50
GFKC 2,5/10-ST-7,5	1939497	50
GFKC 2,5/11-ST-7,5	1939507	50
GFKC 2,5/12-ST-7,5	1939510	50
Pitch 7.62 mm, color: green		
GFKC 2,5/ 2-ST-7,62	1939633	50
GFKC 2,5/ 3-ST-7,62	1939646	50
GFKC 2,5/ 4-ST-7,62	1939659	50
GFKC 2,5/ 5-ST-7,62	1939662	50
GFKC 2,5/ 6-ST-7,62	1939675	50
GFKC 2,5/ 7-ST-7,62	1939688	50
GFKC 2,5/ 8-ST-7,62	1939691	50
GFKC 2,5/ 9-ST-7,62	1939701	50
GFKC 2,5/10-ST-7,62	1939714	50
GFKC 2,5/11-ST-7,62	1939727	50
GFKC 2,5/12-ST-7,62	1939730	50

Classic plug-in connector with 5.0 to 7.62 mm pitch

CLASSIC COMBICON plug-in connectors, pitches 7.5 or 7.62 mm

Single-level header for the wave soldering processes

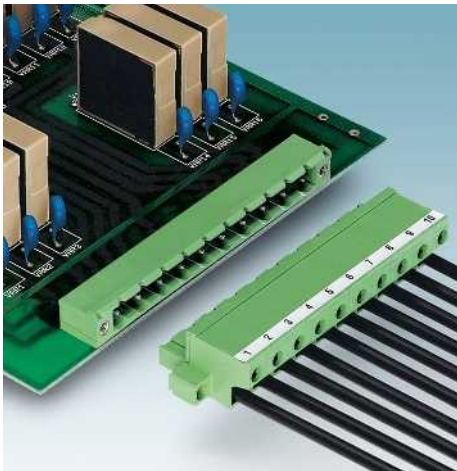

- Headers with angled solder pins for 630 V applications (III/2)
- Plug-in direction parallel to the PCB
- Versions with and without side panels
- Versions with a threaded flange and a 7.62 mm pitch
- Other pin lengths available on request

Notes:

In accordance with DIN EN 61984, COMBICON PLUG-IN connectors have no switching power. During designated use, they must not be plugged in or disconnected when carrying voltage or under load.



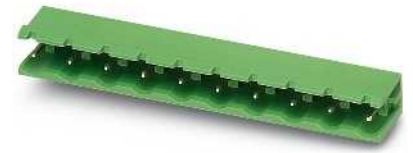

Mounting screws for base element with threaded flange (...GF...): sheet metal screw ISO 1481-ST 2,2x6,5 C or ISO 7049-ST 2,2x6,5 C. Screw connection only permitted prior to soldering.



Without side panels,
plug-in direction parallel to the PCB



Accessories

For all types	Type	Page
	Marker cards SK 7,5/3,8 or SK 7,62/3,8	799
	Coding section CR-MSTB Order No. 1734401	38
	Coding tab MSTB-BL Order No. 1755477	837
Only for GMSTB 2,5/...-G		
	Mounting flange MSTB-BF Order No. 1759981	836

Dimensional drawing

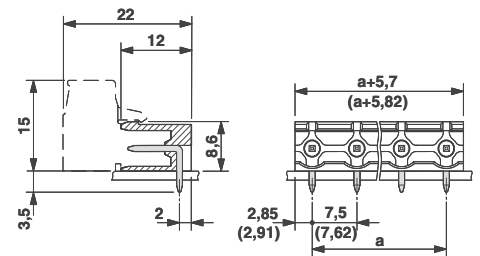

Drilling diagram

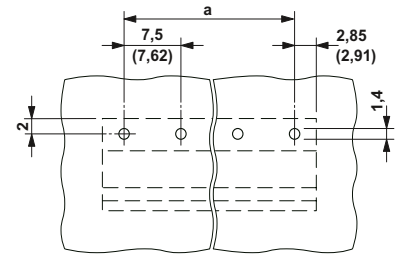

Technical data

Technical data in accordance to IEC / DIN VDE	
Rated current	[A] 12
Rated insulation voltage for pollution degree 2	[V] 630
Pitch	[mm] 7.5 / 7.62
Insulation coordination	
Surge voltage category / pollution degree	III / 3 III / 2 II / 2
Rated insulation voltage	[V] 400 630 630
Rated surge voltage	[kV] 6 6 6
Approval data (UL/CUL)	Use Group B C D
Nominal voltage	[V] 250 - 300
Nominal current	[A] 12 - 10
Connection capacity AWG	AWG - - -
Approval data (CSA)	Use Group B C D
Nominal voltage	[V] 300 - 300
Nominal current	[A] 10 - 10
Connection capacity AWG	AWG - - -
General data	
Type of insulation material / insulation material group	PA / I
Inflammability class according to UL 94	V0
Drill hole diameter / pin dimensions	[mm] 1.4 / 1 x 1 mm

Ordering data

No. of pos.	Dim. a [mm]	Type	Order No.	Pcs. / Pkt.
7.5 mm pitch, color: green				
2	7.50	GMSTB 2,5/ 2-G	1766013	50
3	15.00	GMSTB 2,5/ 3-G	1766026	50
4	22.50	GMSTB 2,5/ 4-G	1766039	50
5	30.00	GMSTB 2,5/ 5-G	1766042	50
6	37.50	GMSTB 2,5/ 6-G	1766055	50
7	45.00	GMSTB 2,5/ 7-G	1766068	50
8	52.50	GMSTB 2,5/ 8-G	1766071	50
9	60.00	GMSTB 2,5/ 9-G	1766084	50
10	67.50	GMSTB 2,5/10-G	1766097	50
11	75.00	GMSTB 2,5/11-G	1766107	50
12	82.50	GMSTB 2,5/12-G	1766110	50
Pitch 7.62 mm, color: green				
2	7.62	GMSTB 2,5/ 2-G-7,62	1766123	50
3	15.24	GMSTB 2,5/ 3-G-7,62	1766136	50
4	22.86	GMSTB 2,5/ 4-G-7,62	1766149	50
5	30.48	GMSTB 2,5/ 5-G-7,62	1766152	50
6	38.10	GMSTB 2,5/ 6-G-7,62	1766165	50
7	45.72	GMSTB 2,5/ 7-G-7,62	1766178	50
8	53.34	GMSTB 2,5/ 8-G-7,62	1766181	50
9	60.96	GMSTB 2,5/ 9-G-7,62	1766194	50
10	68.58	GMSTB 2,5/10-G-7,62	1766204	50
11	76.20	GMSTB 2,5/11-G-7,62	1766217	50
12	83.82	GMSTB 2,5/12-G-7,62	1766220	50

Classic plug-in connector with 5.0 to 7.62 mm pitch

CLASSIC COMBICON PLUG-IN connectors, pitches 7.5 or 7.62 mm

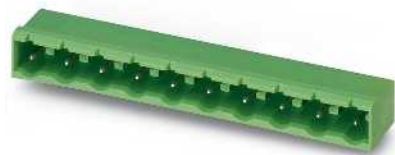

With side panels,
plug-in direction parallel to the PCB



With threaded flange,
plug-in direction parallel to the PCB



Dimensional drawing

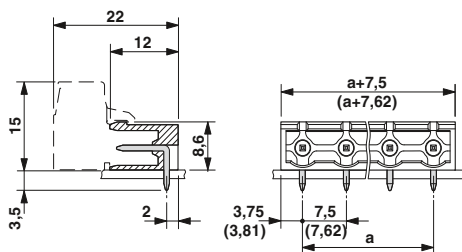

Drilling diagram

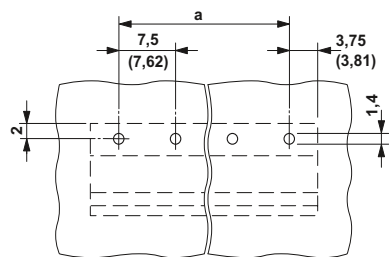

Ordering data

Type	Order No.	Pcs. / Pkt.
7.5 mm pitch, color: green		
GMSTBA 2,5/ 2-G	1766343	250
GMSTBA 2,5/ 3-G	1766356	250
GMSTBA 2,5/ 4-G	1766369	250
GMSTBA 2,5/ 5-G	1766372	250
GMSTBA 2,5/ 6-G	1766385	100
GMSTBA 2,5/ 7-G	1766398	100
GMSTBA 2,5/ 8-G	1766408	100
GMSTBA 2,5/ 9-G	1766411	100
GMSTBA 2,5/10-G	1766424	100
GMSTBA 2,5/11-G	1766437	50
GMSTBA 2,5/12-G	1766440	50
Pitch 7.62 mm, color: green		
GMSTBA 2,5/ 2-G-7,62	1766233	250
GMSTBA 2,5/ 3-G-7,62	1766246	250
GMSTBA 2,5/ 4-G-7,62	1766259	250
GMSTBA 2,5/ 5-G-7,62	1766262	250
GMSTBA 2,5/ 6-G-7,62	1766275	100
GMSTBA 2,5/ 7-G-7,62	1766288	100
GMSTBA 2,5/ 8-G-7,62	1766291	100
GMSTBA 2,5/ 9-G-7,62	1766301	100
GMSTBA 2,5/10-G-7,62	1766314	100
GMSTBA 2,5/11-G-7,62	1766327	50
GMSTBA 2,5/12-G-7,62	1766330	50



Dimensional drawing

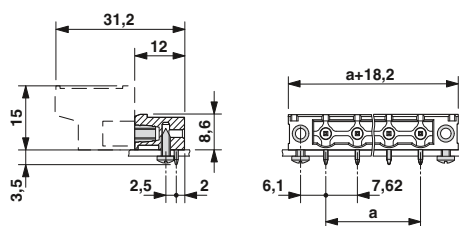

Drilling diagram

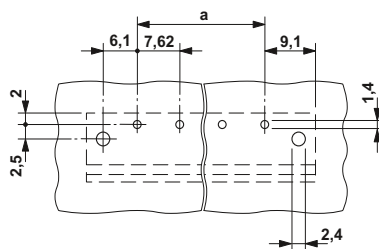

Ordering data

Type	Order No.	Pcs. / Pkt.
Pitch 7.62 mm, color: green		
GMSTB 2,5/ 2-GF-7,62	1806229	50
GMSTB 2,5/ 3-GF-7,62	1806232	50
GMSTB 2,5/ 4-GF-7,62	1806245	50
GMSTB 2,5/ 5-GF-7,62	1806258	50
GMSTB 2,5/ 6-GF-7,62	1806261	50
GMSTB 2,5/ 7-GF-7,62	1806274	50
GMSTB 2,5/ 8-GF-7,62	1806287	50
GMSTB 2,5/ 9-GF-7,62	1806290	50
GMSTB 2,5/10-GF-7,62	1806300	50
GMSTB 2,5/11-GF-7,62	1806313	50
GMSTB 2,5/12-GF-7,62	1806326	50

Classic plug-in connector with 5.0 to 7.62 mm pitch

CLASSIC COMBICON plug-in connectors, pitches 7.5 or 7.62 mm

Single-level header for the wave soldering processes

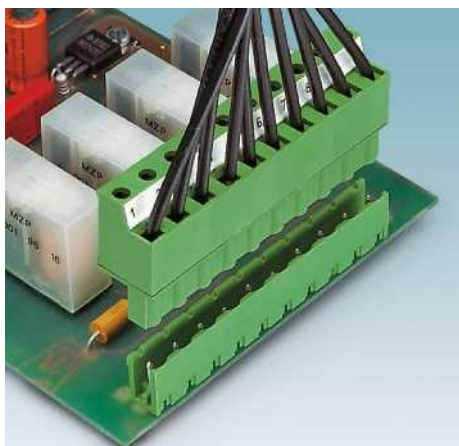

- Headers with straight solder pins for 630 V applications (III/2)
- Plug-in direction vertical to the PCB
- Versions with and without side panels, as well as with and without threaded flange
- Versions with a threaded flange and a 7.62 mm pitch
- Other pin lengths available on request

Notes:

In accordance with DIN EN 61984, COMBICON PLUG-IN connectors have no switching power. During designated use, they must not be plugged in or disconnected when carrying voltage or under load.



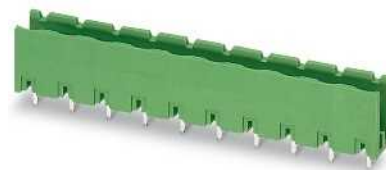

Mounting screws for base element with threaded flange (...GF...): sheet metal screw ISO 1481-ST 2,2x6,5 C or ISO 7049-ST 2,2x6,5 C. Screw connection only permitted prior to soldering.



Without side panels,
plug-in direction vertical to the PCB



Accessories

For all types	Type	Page
	Marker cards SK 7,5/3,8 or SK 7,62/3,8	799
	Coding section CR-MSTB Order No. 1734401	38
	Coding tab MSTB-BL Order No. 1755477	837
Only for GMSTBV 2,5/...-G		
	Mounting flange MSTB-BF Order No. 1759981	836

Dimensional drawing

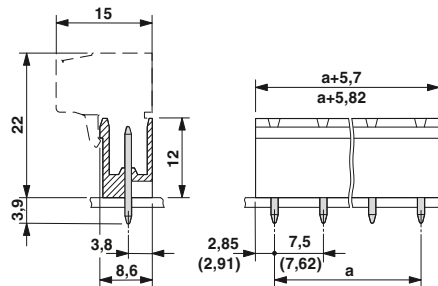

Drilling diagram

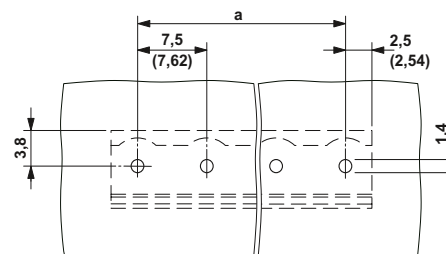

Technical data

Technical data in accordance to IEC / DIN VDE	
Rated current	[A] 12
Rated insulation voltage for pollution degree 2	[V] 630
Pitch	[mm] 7.5 / 7.62
Insulation coordination	
Surge voltage category / pollution degree	III / 3 III / 2 II / 2
Rated insulation voltage	[V] 400 630 630
Rated surge voltage	[kV] 6 6 6
Approval data (UL/CUL)	Use Group B C D
Nominal voltage	[V] 250 - 300
Nominal current	[A] 12 - 10
Connection capacity AWG	AWG - - -
Approval data (CSA)	Use Group B C D
Nominal voltage	[V] 300 - 300
Nominal current	[A] 10 - 10
Connection capacity AWG	AWG - - -
General data	
Type of insulation material / insulation material group	PA / I
Inflammability class according to UL 94	V0
Drill hole diameter / pin dimensions	[mm] 1.4 / 1 x 1 mm

Ordering data

No. of pos.	Dim. a [mm]	Type	Order No.	Pcs. / Pkt.
7.5 mm pitch, color: green				
2	7.50	GMSTBV 2,5/ 2-G	1766453	50
3	15.00	GMSTBV 2,5/ 3-G	1766466	50
4	22.50	GMSTBV 2,5/ 4-G	1766479	50
5	30.00	GMSTBV 2,5/ 5-G	1766482	50
6	37.50	GMSTBV 2,5/ 6-G	1766495	50
7	45.00	GMSTBV 2,5/ 7-G	1766505	50
8	52.50	GMSTBV 2,5/ 8-G	1766518	50
9	60.00	GMSTBV 2,5/ 9-G	1766521	50
10	67.50	GMSTBV 2,5/10-G	1766534	50
11	75.00	GMSTBV 2,5/11-G	1766547	50
12	82.50	GMSTBV 2,5/12-G	1766550	50
Headers, 7.62 mm pitch, color: green				
2	7.62	GMSTBV 2,5/ 2-G-7,62	1766563	50
3	15.24	GMSTBV 2,5/ 3-G-7,62	1766576	50
4	22.86	GMSTBV 2,5/ 4-G-7,62	1766589	50
5	30.48	GMSTBV 2,5/ 5-G-7,62	1766592	50
6	38.10	GMSTBV 2,5/ 6-G-7,62	1766602	50
7	45.72	GMSTBV 2,5/ 7-G-7,62	1766615	50
8	53.34	GMSTBV 2,5/ 8-G-7,62	1766628	50
9	60.96	GMSTBV 2,5/ 9-G-7,62	1766631	50
10	68.58	GMSTBV 2,5/10-G-7,62	1766644	50
11	76.20	GMSTBV 2,5/11-G-7,62	1766657	50
12	83.82	GMSTBV 2,5/12-G-7,62	1767119	50

Classic plug-in connector with 5.0 to 7.62 mm pitch

CLASSIC COMBICON PLUG-IN connectors, pitches 7.5 or 7.62 mm

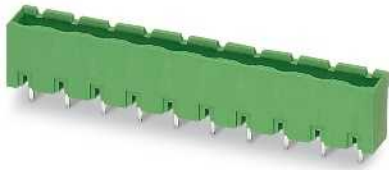

With side panels,
plug-in direction vertical to the PCB

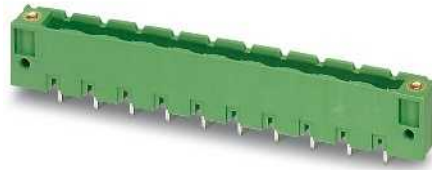

With threaded flange,
plug-in direction vertical to the PCB



Dimensional drawing

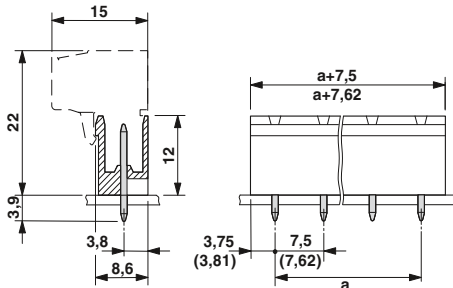

Drilling diagram

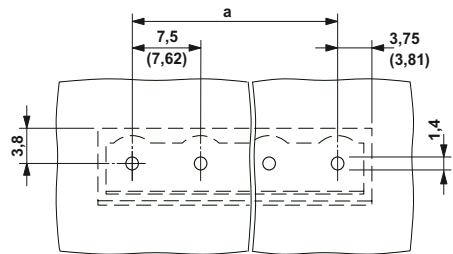

Dimensional drawing

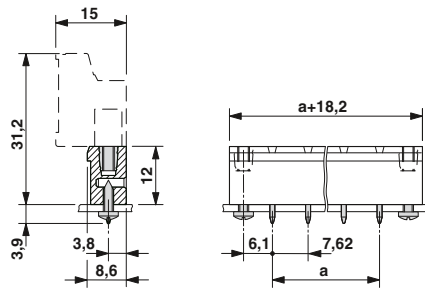

Drilling diagram

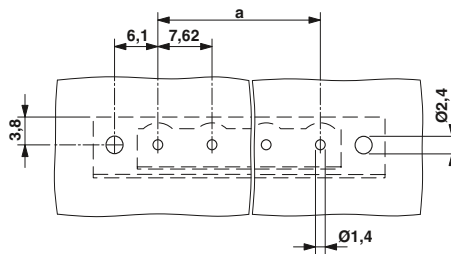

Ordering data

Type	Order No.	Pcs. / Pkt.
7.5 mm pitch, color: green		
GMSTBVA 2,5/ 2-G	1766660	250
GMSTBVA 2,5/ 3-G	1766673	250
GMSTBVA 2,5/ 4-G	1766686	250
GMSTBVA 2,5/ 5-G	1766699	250
GMSTBVA 2,5/ 6-G	1766709	100
GMSTBVA 2,5/ 7-G	1766712	100
GMSTBVA 2,5/ 8-G	1766725	100
GMSTBVA 2,5/ 9-G	1766738	100
GMSTBVA 2,5/10-G	1766741	100
GMSTBVA 2,5/11-G	1766754	50
GMSTBVA 2,5/12-G	1766767	50
Pitch 7.62 mm, color: green		
GMSTBVA 2,5/ 2-G-7,62	1766770	250
GMSTBVA 2,5/ 3-G-7,62	1766783	250
GMSTBVA 2,5/ 4-G-7,62	1766796	250
GMSTBVA 2,5/ 5-G-7,62	1766806	250
GMSTBVA 2,5/ 6-G-7,62	1766819	100
GMSTBVA 2,5/ 7-G-7,62	1766822	100
GMSTBVA 2,5/ 8-G-7,62	1766835	100
GMSTBVA 2,5/ 9-G-7,62	1766848	100
GMSTBVA 2,5/10-G-7,62	1766851	100
GMSTBVA 2,5/11-G-7,62	1766864	50
GMSTBVA 2,5/12-G-7,62	1766877	50

Ordering data

Type	Order No.	Pcs. / Pkt.
Pitch 7.62 mm, color: green		
GMSTBV 2,5/ 2-GF-7,62	1829154	50
GMSTBV 2,5/ 3-GF-7,62	1829167	50
GMSTBV 2,5/ 4-GF-7,62	1829170	50
GMSTBV 2,5/ 5-GF-7,62	1829183	50
GMSTBV 2,5/ 6-GF-7,62	1829196	50
GMSTBV 2,5/ 7-GF-7,62	1829206	50
GMSTBV 2,5/ 8-GF-7,62	1829219	50
GMSTBV 2,5/ 9-GF-7,62	1829222	50
GMSTBV 2,5/10-GF-7,62	1829235	50
GMSTBV 2,5/11-GF-7,62	1829248	50
GMSTBV 2,5/12-GF-7,62	1829251	50

Classic plug-in connector with 5.0 to 7.62 mm pitch

CLASSIC COMBICON plug-in connectors, pitches 7.5 or 7.62 mm

Inverted header for the wave soldering processes

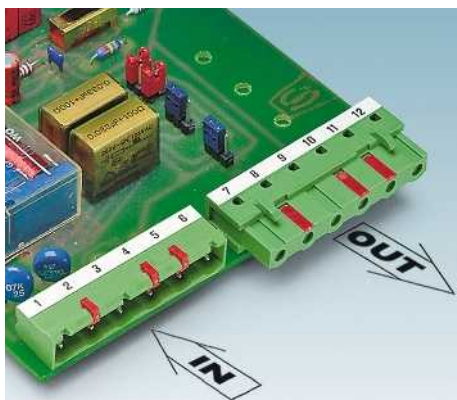

- Use in shock-proof applications up to 630 V (III/2)
- Horizontal and vertical plug-in direction
- Versions with and without a threaded flange
- Pairs of guide rails can be used as a 90° board to board connection
- Combination with GMSTB 2,5 headers for primary/secondary/PCB connection
- Clear separation of PCB inputs/outputs
- For various combination options with GMSTB 2,5 plug-in system, refer to page 34

Notes:

In accordance with DIN EN 61984, COMBICON plug-in connectors have no switching power. During designated use, they must not be plugged in or disconnected when carrying voltage or under load.

COMBICON select

You will find the possible plug-in connector combinations in COMBICON select at: www.phoenixcontact.net/products or starting on page 259.

Dimensional drawing of FLRP-ICV and PCB cutout can be found on page 838.

Mounting screws for GIC 2,5/...-GF-7,62 and GICV 2,5/...-GF-7,62: sheet metal screw ISO 1481-ST 2,2x6,5 C or ISO 7049-ST 2,2x6,5 C. Screw connection only permitted prior to soldering.



Plug-in direction parallel to the PCB

Accessories

For all types	Type	Page
	Marker cards SK 7,62/3,8	799
	Coding profile CP-MSTB Order No. 1734634	38
	Reducing plug RPS Order No. 0201647	831
	Test plug MPS	831
Only for GICV 2,5/...-G-7,62		
	Pair of guide rails for a PCB FLRP-ICV 80 Order No. 1808353	837



Dimensional drawing

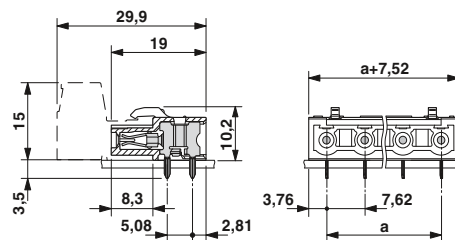

Drilling diagram

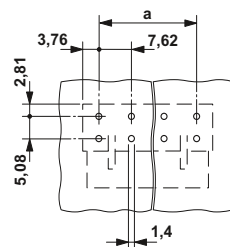

Technical data

Technical data in accordance to IEC / DIN VDE

Rated current	[A]	12
Rated insulation voltage for pollution degree 2	[V]	630
Pitch	[mm]	7.62
Insulation coordination		
Surge voltage category / pollution degree		III / 3 III / 2 II / 2
Rated insulation voltage	[V]	500 630 1000
Rated surge voltage	[kV]	6 6 6
Approval data (UL/CUL)	Use Group	B C D
Nominal voltage	[V]	250 - 300
Nominal current	[A]	12 - 10
Connection capacity AWG	AWG	- - -
Approval data (CSA)	Use Group	B C D
Nominal voltage	[V]	300 - 300
Nominal current	[A]	10 - 10
Connection capacity AWG	AWG	- - -
General data		
Type of insulation material / insulation material group		PA / I
Inflammability class according to UL 94		V0
Drill hole diameter / pin dimensions	[mm]	1.4 / 1.2 x 0.5

No. of pos.	Dim. a [mm]
2	7.62
3	15.24
4	22.86
5	30.48
6	38.10
7	45.72
8	53.34
9	60.96
10	68.58
11	76.20
12	83.82

Ordering data

Type	Order No.	Pcs. / Pkt.
Pitch 7.62 mm, color: green		
GIC 2,5/ 2-G-7,62	1828676	50
GIC 2,5/ 3-G-7,62	1828689	50
GIC 2,5/ 4-G-7,62	1828692	50
GIC 2,5/ 5-G-7,62	1828702	50
GIC 2,5/ 6-G-7,62	1828715	50
GIC 2,5/ 7-G-7,62	1828728	50
GIC 2,5/ 8-G-7,62	1828731	50
GIC 2,5/ 9-G-7,62	1828744	50
GIC 2,5/10-G-7,62	1828757	50
GIC 2,5/11-G-7,62	1828760	50
GIC 2,5/12-G-7,62	1828773	50

Classic plug-in connector with 5.0 to 7.62 mm pitch

CLASSIC COMBICON plug-in connectors, pitches 7.5 or 7.62 mm



With threaded flange,
plug-in direction parallel to the PCB



Plug-in direction vertical to the PCB



With threaded flange,
plug-in direction vertical to the PCB



Dimensional drawing

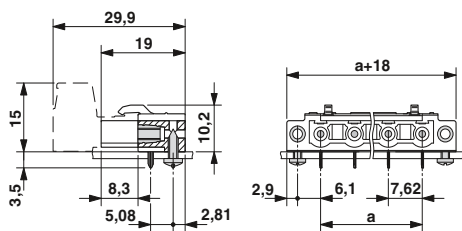

Drilling diagram

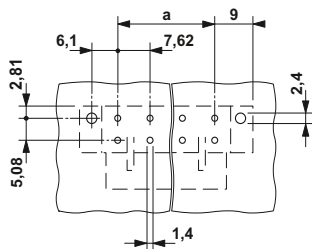

Dimensional drawing

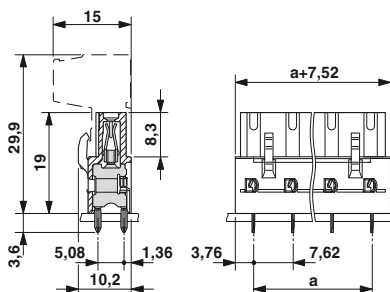

Drilling diagram

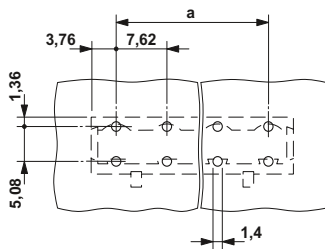

Dimensional drawing

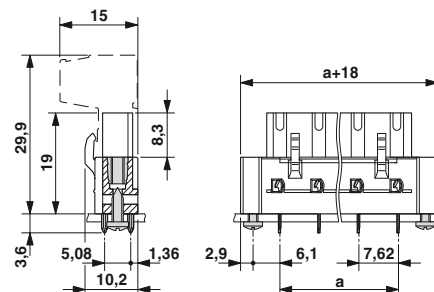

Drilling diagram

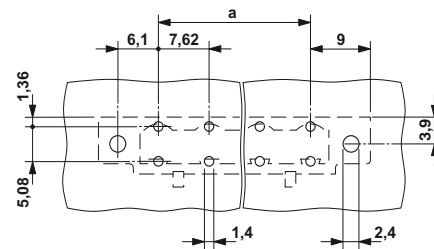

Ordering data

Type	Order No.	Pcs. / Pkt.
Pitch 7.62 mm, color: green		
GIC 2,5/ 2-GF-7,62	1858989	50
GIC 2,5/ 3-GF-7,62	1858992	50
GIC 2,5/ 4-GF-7,62	1859001	50
GIC 2,5/ 5-GF-7,62	1859014	50
GIC 2,5/ 6-GF-7,62	1859027	50
GIC 2,5/ 7-GF-7,62	1859030	50
GIC 2,5/ 8-GF-7,62	1859043	50
GIC 2,5/ 9-GF-7,62	1859056	50
GIC 2,5/10-GF-7,62	1859069	50
GIC 2,5/11-GF-7,62	1859072	50
GIC 2,5/12-GF-7,62	1859085	50

Ordering data

Type	Order No.	Pcs. / Pkt.
Pitch 7.62 mm, color: green		
GICV 2,5/ 2-G-7,62	1828919	50
GICV 2,5/ 3-G-7,62	1828922	50
GICV 2,5/ 4-G-7,62	1828935	50
GICV 2,5/ 5-G-7,62	1828948	50
GICV 2,5/ 6-G-7,62	1828951	50
GICV 2,5/ 7-G-7,62	1828964	50
GICV 2,5/ 8-G-7,62	1828977	50
GICV 2,5/ 9-G-7,62	1828980	50
GICV 2,5/10-G-7,62	1828993	50
GICV 2,5/11-G-7,62	1829002	50
GICV 2,5/12-G-7,62	1829015	50

Ordering data

Type	Order No.	Pcs. / Pkt.
Pitch 7.62 mm, color: green		
GICV 2,5/ 2-GF-7,62	1859098	50
GICV 2,5/ 3-GF-7,62	1859108	50
GICV 2,5/ 4-GF-7,62	1859111	50
GICV 2,5/ 5-GF-7,62	1859124	50
GICV 2,5/ 6-GF-7,62	1859137	50
GICV 2,5/ 7-GF-7,62	1859140	50
GICV 2,5/ 8-GF-7,62	1859153	50
GICV 2,5/ 9-GF-7,62	1859166	50
GICV 2,5/10-GF-7,62	1859179	50
GICV 2,5/11-GF-7,62	1859182	50
GICV 2,5/12-GF-7,62	1859195	50

Classic plug-in connector with 5.0 to 7.62 mm pitch

Special types

Cable housings

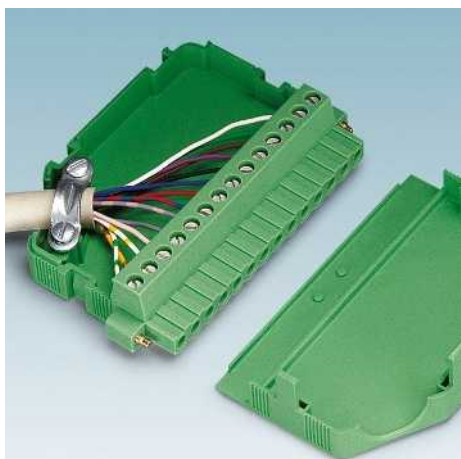

- For MSTB, IC and GMSTB plug components, with and without flange with 5.0 and 5.08 mm pitches
- Complete snap-locking of the two half shells of the cable housing
- Cable strain relief using cable binder or cable clamp
- Suitable for cables with a diameter of 4 to 13.5 mm
- Straight cable outlet for aligning multiple cable housings
- Easier plugging and unplugging processes
- Higher numbers of positions up to 24-pos. can be found at: www.phoenixcontact.net/products



Notes:

The possible combinations for cable housing with GMSTB 2,5/...-ST(-7,62) can be found on page 838



For 4 to 6 mm cable diameters, cable binders and marker strips are included, straight cable outlet

Accessories

For all types	Type	Page
	Marker strips, unprinted, 10-section SBS 2,5/7,5 Order No. 1007604	
Only for KGS-MSTB 2,5/ ...		
	Transparent marker carrier KGS-MSTB 2,5/DST Order No. 1784914	
	Bend protection sleeve KD-KGS-MSTB Order No. 1804658	

Dimensional drawing

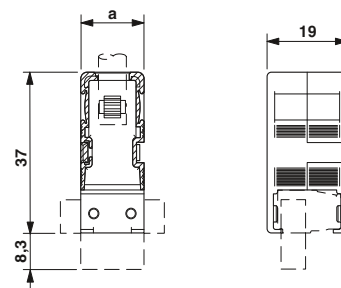

Technical data

Technical data in accordance to IEC / DIN VDE	
Rated current / conductor cross section	[A] / [mm ²]
Rated insulation voltage for pollution degree 2	[V]
Pitch	[mm]
Insulation coordination	
Surge voltage category / pollution degree	
Rated insulation voltage	[V]
Rated surge voltage	[kV]
General data	
Type of insulation material / insulation material group	
Inflammability class according to UL 94	

- / -
-
0
III / 3 III / 2 II / 2
ABS / I
HB

Ordering data

No. of pos.	Dim. a [mm]	Type	Order No.	Pcs. / Pkt.
5.0 or 5.08 mm pitch, color: green				
2	10.00	KGG-MSTB 2,5/ 2	1803934	10
3	15.00	KGG-MSTB 2,5/ 3	1803947	10
4	20.00			
5	25.00			
6	30.00			
7	35.00			
8	40.00			
9	45.00			
10	50.00			
11	55.00			
12	60.00			
13	65.00			
14	70.00			
15	75.00			
16	80.00			



For 5 to 9.5 mm cable diameters, cable clamps, screws and marker strips are included, straight cable outlet



For 6 to 13.5 mm cable diameters, marker strips and transparent label carriers are included, angled cable outlet



Dimensional drawing

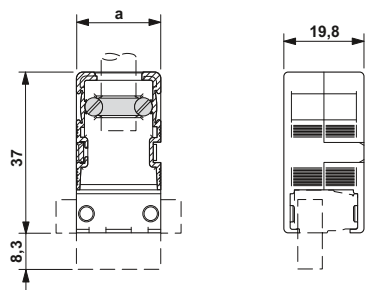

Dimensional drawing

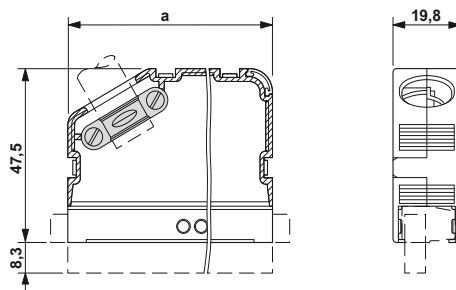

Ordering data

Type	Order No.	Pcs. / Pkt.
5.0 or 5.08 mm pitch, color: green		
KGG-MSTB 2,5/ 4	1803882	10
KGG-MSTB 2,5/ 5	1803895	10
KGG-MSTB 2,5/ 6	1803905	10
KGG-MSTB 2,5/ 7	1803918	10
KGG-MSTB 2,5/ 8	1803921	10

Ordering data

Type	Order No.	Pcs. / Pkt.
KGS-MSTB 2,5/ 8	1783779	10
KGS-MSTB 2,5/ 9	1783782	10
KGS-MSTB 2,5/10	1783740	10
KGS-MSTB 2,5/11	1783805	10
KGS-MSTB 2,5/12	1783818	10
KGS-MSTB 2,5/13	1783821	10
KGS-MSTB 2,5/14	1783834	10
KGS-MSTB 2,5/15	1783847	10
KGS-MSTB 2,5/16	1783850	10

Classic plug-in connector with 5.0 to 7.62 mm pitch

Special types

Feed-through assembly frame

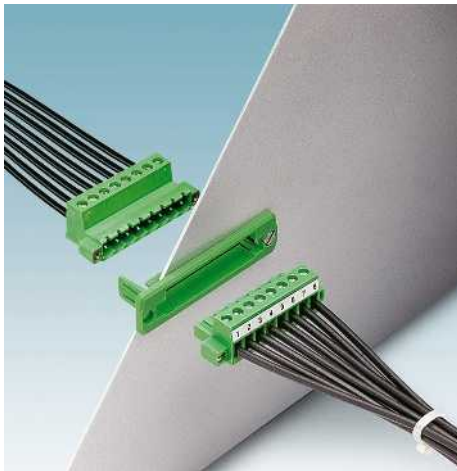

- Feed-through assembly frame for inverted IC 2,5/...-STGF-5,08 COMBICON plugs
- The frame can be inserted and screwed into the cutout
- Snap-locking the IC plug component into the frame
- Fitting the MSTB 2,5/...-STF-5,08 connector from outside
- Vibration-resistant screwing of the two plug components using a screw flange
- Up to a wall thickness of 1.5 mm, the frame can be screwed before the IC plug is mounted

Notes:

Cutout dimensions b and c can be found on page 838.

IC 2,5/...-STGF-5,08 plugs, see page 273.



For snapping in the IC 2,5/...-STGF-5,08 inverted plug, for wall thicknesses from 0.5 to 4.5 mm

Accessories

For all types	Type	Page
	One screw set M3 x 10 mm DFK-MSTB-SS Order No. 0708263	

Dimensional drawing

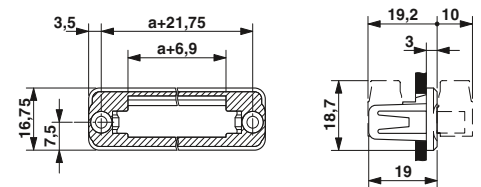

Drilling diagram

Dimension b: 10.84 mm + (no. of pos. x 5.08 mm)
Dimension c: Dim. b + 5.83 mm

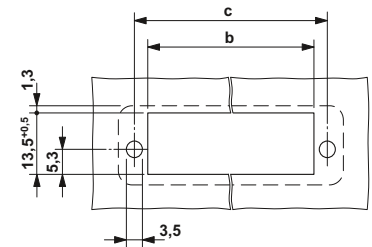

Technical data

Technical data in accordance to IEC / DIN VDE	
Rated current / conductor cross section	[A] / [mm ²]
Rated insulation voltage for pollution degree 2	[V]
Pitch	[mm]
Insulation coordination	
Surge voltage category / pollution degree	III / 3 III / 2 II / 2
Rated insulation voltage	[V]
Rated surge voltage	[kV]
General data	
Type of insulation material / insulation material group	PA / I
Inflammability class according to UL 94	V0

Ordering data

No. of pos.	Dim. a [mm]	Type	Order No.	Pcs. / Pkt.
5.08 mm pitch, color: green				
2	5.08	IC-DFR 2	1852024	50
3	10.16	IC-DFR 3	1852037	50
4	15.24	IC-DFR 4	1852040	50
5	20.32	IC-DFR 5	1852053	50
6	25.40	IC-DFR 6	1852066	50
7	30.48	IC-DFR 7	1852079	50
8	35.56	IC-DFR 8	1852082	50
9	40.64	IC-DFR 9	1852095	50
10	45.72	IC-DFR 10	1852105	50
11	50.80	IC-DFR 11	1852118	50
12	55.88	IC-DFR 12	1852121	50
13	60.96	IC-DFR 13	1852134	50
14	66.04	IC-DFR 14	1852147	50
15	71.12	IC-DFR 15	1852150	50
16	76.20	IC-DFR 16	1852163	50

Classic plug-in connector with 5.0 to 7.62 mm pitch

Special types

Feed-through housing



- Header for assembly in a device/housing panel
- Outside: plug-in connection for corresponding MSTB 2,5 or FKC 2,5 plugs
- Internally combinable solder or 2.8 mm slip-on connection
- Versions with and without a threaded flange
- Can be fixed in housing walls up to 6 mm thick using two M3 x 10 screws

Notes:

In accordance with DIN EN 61984, COMBICON plug-in connectors have no switching power. During designated use, they must not be plugged in or disconnected when carrying voltage or under load.

For cutout dimensions see page 838.

¹⁾ When using the spade connection, the rated current is 7.5 A.





For housing walls 0.5 to 4 mm thick

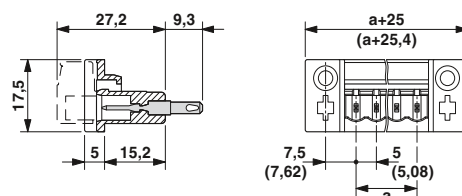

Dimensional drawing



Accessories

For all types	Type	Page
	Coding section CR-MSTB Order No. 1734401	38
	Coding tab MSTB-BL Order No. 1755477	837
	One screw set M3 x 10 mm DFK-MSTB-SS Order No. 0708263	
Only for DFK-MSTB 2,5/...-G		
	Ticks for snapping on the MSTB(T) connectors DFK-MSTB-R Order No. 5030172	

Technical data

Technical data in accordance to IEC / DIN VDE	
Rated current / conductor cross section	[A] / [mm ²]
Rated insulation voltage for pollution degree 2	[V]
Pitch	[mm]
Insulation coordination	
Surge voltage category / pollution degree	
Rated insulation voltage	[V]
Rated surge voltage	[kV]
Approval data (UL/CUL)	Use Group
Nominal voltage	[V]
Nominal current	[A]
Connection capacity AWG	AWG
Approval data (CSA)	Use Group
Nominal voltage	[V]
Nominal current	[A]
Connection capacity AWG	AWG
General data	
Type of insulation material / insulation material group	
Inflammability class according to UL 94	
Slip-on connection (DIN 46249-1)	[A]/[mm]

12 ¹⁾ / 2.5		
320		
5 / 5.08		
III / 3	III / 2	II / 2
320	320	630
4	4	4
B	C	D
300	-	300
15	-	15
-	-	-
B	C	D
300	-	300
10	-	10
-	-	-
PA / I		
V2		
- / 2.8 x 0.8 mm		

Ordering data

No. of pos.	Dim. a [mm]	Type	Order No.	Pcs. / Pkt.
5.0 mm pitch, color: green				
2	5.00	DFK-MSTB 2,5/ 2-G	0707109	50
3	10.00	DFK-MSTB 2,5/ 3-G	0707112	50
4	15.00	DFK-MSTB 2,5/ 4-G	0707125	50
5	20.00	DFK-MSTB 2,5/ 5-G	0707138	50
6	25.00	DFK-MSTB 2,5/ 6-G	0707141	50
7	30.00	DFK-MSTB 2,5/ 7-G	0707154	50
8	35.00	DFK-MSTB 2,5/ 8-G	0707060	50
9	40.00	DFK-MSTB 2,5/ 9-G	0707167	50
10	45.00	DFK-MSTB 2,5/10-G	0707170	50
11	50.00	DFK-MSTB 2,5/11-G	0707183	50
12	55.00	DFK-MSTB 2,5/12-G	0707196	50
13	60.00	DFK-MSTB 2,5/13-G	0707206	50
14	65.00	DFK-MSTB 2,5/14-G	0707219	50
15	70.00	DFK-MSTB 2,5/15-G	0707222	50
16	75.00	DFK-MSTB 2,5/16-G	0707235	50
5.08 mm pitch, color: green				
2	5.08	DFK-MSTB 2,5/ 2-G-5,08	0707248	50
3	10.16	DFK-MSTB 2,5/ 3-G-5,08	0707251	50
4	15.24	DFK-MSTB 2,5/ 4-G-5,08	0707264	50
5	20.32	DFK-MSTB 2,5/ 5-G-5,08	0707277	50
6	25.40	DFK-MSTB 2,5/ 6-G-5,08	0707280	50
7	30.48	DFK-MSTB 2,5/ 7-G-5,08	0707293	50
8	35.56	DFK-MSTB 2,5/ 8-G-5,08	0707057	50
9	40.64	DFK-MSTB 2,5/ 9-G-5,08	0707303	50
10	45.72	DFK-MSTB 2,5/10-G-5,08	0707316	50
11	50.80	DFK-MSTB 2,5/11-G-5,08	0707329	50
12	55.88	DFK-MSTB 2,5/12-G-5,08	0707332	50
13	60.96	DFK-MSTB 2,5/13-G-5,08	0707345	50
14	66.04	DFK-MSTB 2,5/14-G-5,08	0707358	50
15	71.12	DFK-MSTB 2,5/15-G-5,08	0707361	50
16	76.20	DFK-MSTB 2,5/16-G-5,08	0707374	50



For housing walls 0.5 to 4 mm thick,
with threaded flange



Dimensional drawing

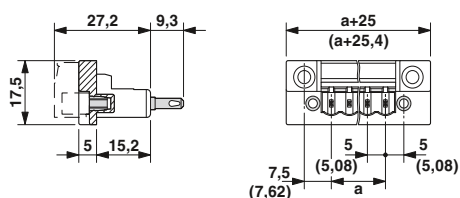

Ordering data

Type	Order No.	Pcs. / Pkt.
5.0 mm pitch, color: green		
DFK-MSTB 2,5/ 2-GF	0710028	50
DFK-MSTB 2,5/ 3-GF	0710031	50
DFK-MSTB 2,5/ 4-GF	0710044	50
DFK-MSTB 2,5/ 5-GF	0710057	1
DFK-MSTB 2,5/ 6-GF	0710060	50
DFK-MSTB 2,5/ 7-GF	0710073	50
DFK-MSTB 2,5/ 8-GF	0710086	50
DFK-MSTB 2,5/ 9-GF	0710099	50
DFK-MSTB 2,5/10-GF	0710109	50
DFK-MSTB 2,5/11-GF	0710112	50
DFK-MSTB 2,5/12-GF	0710125	50
DFK-MSTB 2,5/13-GF	0710138	50
DFK-MSTB 2,5/14-GF	0710141	50
DFK-MSTB 2,5/15-GF	0710154	50
DFK-MSTB 2,5/16-GF	0710167	50
5.08 mm pitch, color: green		
DFK-MSTB 2,5/ 2-GF-5,08	0710170	50
DFK-MSTB 2,5/ 3-GF-5,08	0710183	50
DFK-MSTB 2,5/ 4-GF-5,08	0710196	50
DFK-MSTB 2,5/ 5-GF-5,08	0710206	50
DFK-MSTB 2,5/ 6-GF-5,08	0710219	50
DFK-MSTB 2,5/ 7-GF-5,08	0710222	50
DFK-MSTB 2,5/ 8-GF-5,08	0710235	50
DFK-MSTB 2,5/ 9-GF-5,08	0710248	50
DFK-MSTB 2,5/10-GF-5,08	0710251	50
DFK-MSTB 2,5/11-GF-5,08	0710264	50
DFK-MSTB 2,5/12-GF-5,08	0710277	50
DFK-MSTB 2,5/13-GF-5,08	0710280	50
DFK-MSTB 2,5/14-GF-5,08	0710293	50
DFK-MSTB 2,5/15-GF-5,08	0710303	50
DFK-MSTB 2,5/16-GF-5,08	0710316	50

Classic plug-in connector with 5.0 to 7.62 mm pitch

Special types

Feed-through housing



- Header for assembly in a device/housing panel
- External connection for the corresponding MSTB 2,5 or FKC 2,5 plugs
- With horizontal or vertical solder connection inside
- Installation from the inside of the device through the housing panel
- Sealing the inside of the housing against dust using the enclosed seal

Notes:

In accordance with DIN EN 61984, COMBICON plug-in connectors have no switching power. During designated use, they must not be plugged in or disconnected when carrying voltage or under load.

COMBICON select

You will find the possible plug-in connector combinations in COMBICON select at: www.phoenixcontact.net/products or starting on page 259.

For cutout dimensions see page 838.



Plug-in direction parallel to the PCB



Dimensional drawing

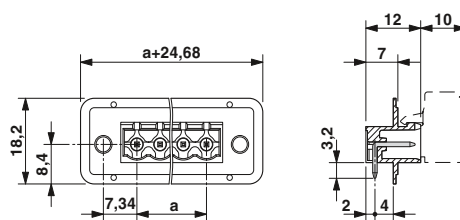

Drilling diagram

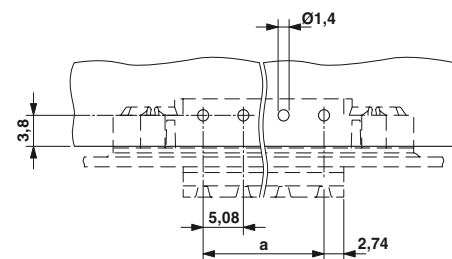

Accessories		
For all types	Type	Page
	Coding section CR-MSTB Order No. 1734401	38
	One screw set M3 x 10 mm DFK-MSTB-SS Order No. 0708263	

Technical data

Technical data in accordance to IEC / DIN VDE

Rated current	[A]	12
Rated insulation voltage for pollution degree 2	[V]	320
Pitch	[mm]	5.08
Insulation coordination		
Surge voltage category / pollution degree		III / 3 III / 2 II / 2
Rated insulation voltage	[V]	250 320 400
Rated surge voltage	[kV]	4 4 4
Approval data (UL/CUL)	Use Group	B C D
Nominal voltage	[V]	300 - 300
Nominal current	[A]	15 - 15
Connection capacity AWG	AWG	- - -
Approval data (CSA)	Use Group	B C D
Nominal voltage	[V]	- - -
Nominal current	[A]	- - -
Connection capacity AWG	AWG	- - -
General data		
Type of insulation material / insulation material group		PBT / IIIa
Inflammability class according to UL 94		V0

Ordering data

No. of pos.	Dim. a [mm]	Type	Order No.	Pcs. / Pkt.
5.08 mm pitch, color: green				
2	5.08	DFK-MSTBA 2,5/ 2-G-5,08	1898839	50
3	10.16	DFK-MSTBA 2,5/ 3-G-5,08	1898842	50
4	15.24	DFK-MSTBA 2,5/ 4-G-5,08	1898855	50
5	20.32	DFK-MSTBA 2,5/ 5-G-5,08	1898868	50
6	25.40	DFK-MSTBA 2,5/ 6-G-5,08	1898871	50
7	30.48	DFK-MSTBA 2,5/ 7-G-5,08	1898884	50
8	35.56	DFK-MSTBA 2,5/ 8-G-5,08	1898897	50
9	40.64	DFK-MSTBA 2,5/ 9-G-5,08	1898907	50
10	45.72	DFK-MSTBA 2,5/ 10-G-5,08	1898910	50
11	50.80	DFK-MSTBA 2,5/ 11-G-5,08	1898923	50
12	55.88	DFK-MSTBA 2,5/ 12-G-5,08	1898936	50
13	60.96	DFK-MSTBA 2,5/ 13-G-5,08	1898949	50
14	66.04	DFK-MSTBA 2,5/ 14-G-5,08	1898952	50
15	71.12	DFK-MSTBA 2,5/ 15-G-5,08	1898965	50
16	76.20	DFK-MSTBA 2,5/ 16-G-5,08	1898978	50



With threaded flange,
plug-in direction parallel to the PCB



Plug-in direction vertical to the PCB



With threaded flange, plug-in direction vertical to the PCB



Dimensional drawing

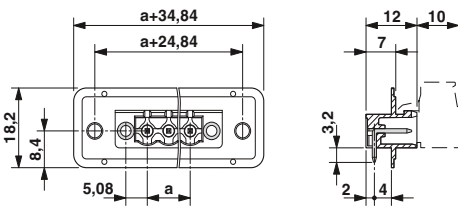

Drilling diagram

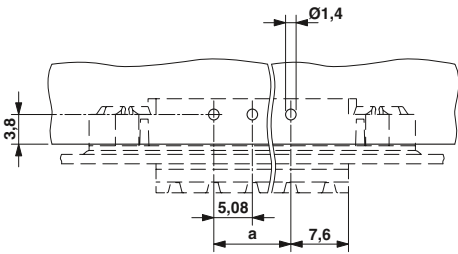

Ordering data

Type	Order No.	Pcs. / Pkt.
5.08 mm pitch, color: green		
DFK-MSTBA 2,5/ 2-GF-5,08	1898981	50
DFK-MSTBA 2,5/ 3-GF-5,08	1898994	50
DFK-MSTBA 2,5/ 4-GF-5,08	1899003	50
DFK-MSTBA 2,5/ 5-GF-5,08	1899016	50
DFK-MSTBA 2,5/ 6-GF-5,08	1899029	50
DFK-MSTBA 2,5/ 7-GF-5,08	1899032	50
DFK-MSTBA 2,5/ 8-GF-5,08	1899045	50
DFK-MSTBA 2,5/ 9-GF-5,08	1899058	50
DFK-MSTBA 2,5/10-GF-5,08	1899061	50
DFK-MSTBA 2,5/11-GF-5,08	1899074	50
DFK-MSTBA 2,5/12-GF-5,08	1899087	50
DFK-MSTBA 2,5/13-GF-5,08	1899090	50
DFK-MSTBA 2,5/14-GF-5,08	1899100	50
DFK-MSTBA 2,5/15-GF-5,08	1899113	50
DFK-MSTBA 2,5/16-GF-5,08	1899126	50



Dimensional drawing

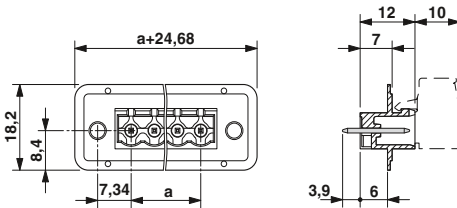

Drilling diagram

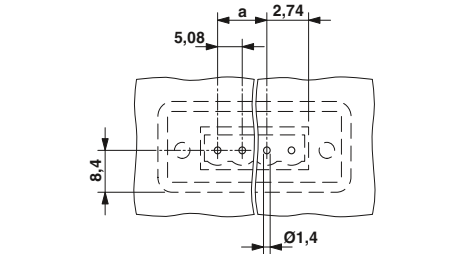

Ordering data

Type	Order No.	Pcs. / Pkt.
5.08 mm pitch, color: green		
DFK-MSTBVA 2,5/ 2-G-5,08	1899139	50
DFK-MSTBVA 2,5/ 3-G-5,08	1899142	50
DFK-MSTBVA 2,5/ 4-G-5,08	1899155	50
DFK-MSTBVA 2,5/ 5-G-5,08	1899168	50
DFK-MSTBVA 2,5/ 6-G-5,08	1899171	50
DFK-MSTBVA 2,5/ 7-G-5,08	1899184	50
DFK-MSTBVA 2,5/ 8-G-5,08	1899197	50
DFK-MSTBVA 2,5/ 9-G-5,08	1899207	50
DFK-MSTBVA 2,5/10-G-5,08	1899210	50
DFK-MSTBVA 2,5/11-G-5,08	1899223	50
DFK-MSTBVA 2,5/12-G-5,08	1899236	50
DFK-MSTBVA 2,5/13-G-5,08	1899249	50
DFK-MSTBVA 2,5/14-G-5,08	1899252	50
DFK-MSTBVA 2,5/15-G-5,08	1899265	50
DFK-MSTBVA 2,5/16-G-5,08	1899278	50



Dimensional drawing

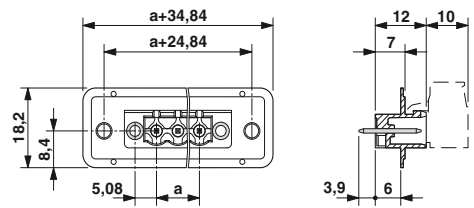

Drilling diagram

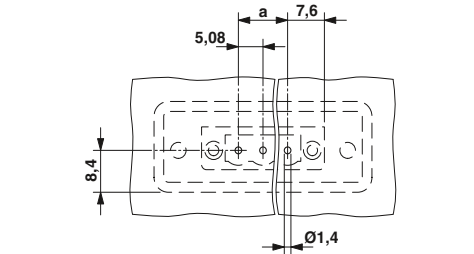

Ordering data

Type	Order No.	Pcs. / Pkt.
5.08 mm pitch, color: green		
DFK-MSTBVA 2,5/ 2-GF-5,08	1899281	50
DFK-MSTBVA 2,5/ 3-GF-5,08	1899294	50
DFK-MSTBVA 2,5/ 4-GF-5,08	1899304	50
DFK-MSTBVA 2,5/ 5-GF-5,08	1899317	50
DFK-MSTBVA 2,5/ 6-GF-5,08	1899320	50
DFK-MSTBVA 2,5/ 7-GF-5,08	1899333	50
DFK-MSTBVA 2,5/ 8-GF-5,08	1899346	50
DFK-MSTBVA 2,5/ 9-GF-5,08	1899359	50
DFK-MSTBVA 2,5/10-GF-5,08	1899362	50
DFK-MSTBVA 2,5/11-GF-5,08	1899375	50
DFK-MSTBVA 2,5/12-GF-5,08	1899388	50
DFK-MSTBVA 2,5/13-GF-5,08	1899391	50
DFK-MSTBVA 2,5/14-GF-5,08	1899401	50
DFK-MSTBVA 2,5/15-GF-5,08	1899414	50
DFK-MSTBVA 2,5/16-GF-5,08	1899427	50

Classic plug-in connector with 5.0 to 7.62 mm pitch

Special types

Plug-in blocks for direct mounting

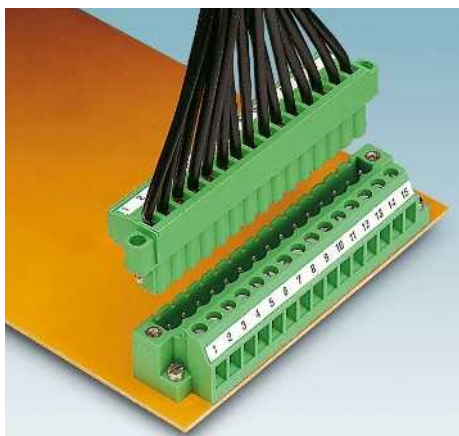

- Direct plug-in blocks with mounting flanges for screw connection on mounting plates or unit housings
- Higher numbers of positions up to 24-pos. can be found at: www.phoenixcontact.net/products

MVSTBU 2,5/...-G(F)B

- With vertical plug-in direction
- Versions with and without a threaded flange

MSTBU 2,5/...-STD-5,08

- Touch-proof connection block in combination with IC 2,5/...-ST-5,08, see page 272

Notes:

In accordance with DIN EN 61984, COMBICON plug-in connectors have no switching power. During designated use, they must not be plugged in or disconnected when carrying voltage or under load.

COMBICON select

You will find the possible plug-in connector combinations in COMBICON select at: www.phoenixcontact.net/products or starting on page 259.

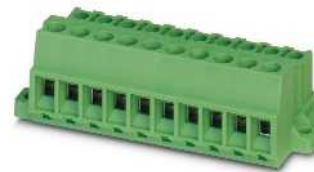

With socket contacts and flange for direct mounting



Dimensional drawing

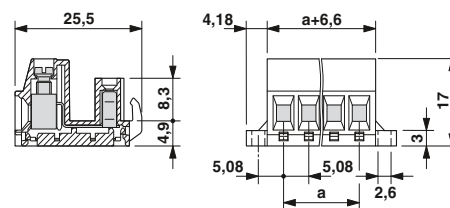

Drilling diagram

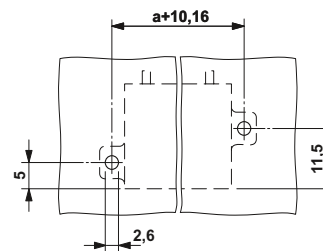

Accessories		
For all types	Type	Page
	Marker cards SK 5,08/3,8	798
	Coding section CR-MSTB Order No. 1734401	38
	Screwdriver SZS 0,6 x 3,5 Order No. 1205053	
	Insertion bridge EBP... 5	829

Technical data

Technical data in accordance to IEC / DIN VDE

Rated current / conductor cross section	[A] / [mm ²]	12 / 2.5
Rated insulation voltage for pollution degree 2	[V]	320

Pitch	[mm]	5.08
-------	------	------

Connection capacity

Solid / stranded	[mm ²] / [mm ²] / AWG	0.2 - 2.5 / 0.2 - 2.5 / 24 - 12
------------------	---	---------------------------------

Stranded with ferrules without plastic sleeve	[mm ²]	0.25 - 2.5
---	--------------------	------------

Stranded with ferrules with plastic sleeve	[mm ²]	0.25 - 2.5
--	--------------------	------------

Multi-conductor connection capacity (two conductors with the same cross section)

Solid / stranded	[mm ²]	0.2 - 1 / 0.2 - 1.5
------------------	--------------------	---------------------

Stranded with ferrules without plastic sleeve	[mm ²]	0.25 - 1
---	--------------------	----------

Stranded with TWIN ferrule with plastic sleeve	[mm ²]	0.5 - 1
--	--------------------	---------

Insulation coordination

Surge voltage category / pollution degree	III / 3	III / 2	II / 2
---	---------	---------	--------

Rated insulation voltage	[V]	320	320	630
--------------------------	-----	-----	-----	-----

Rated surge voltage	[kV]	4	4	4
---------------------	------	---	---	---

Approval data (UL/CUL)	Use Group	B	C	D
------------------------	-----------	---	---	---

Nominal voltage	[V]	250	-	300
-----------------	-----	-----	---	-----

Nominal current	[A]	12	-	10
-----------------	-----	----	---	----

Connection capacity AWG	AWG	30 - 12	-	30 - 12
-------------------------	-----	---------	---	---------

Approval data (CSA)	Use Group	B	C	D
---------------------	-----------	---	---	---

Nominal voltage	[V]	300	-	300
-----------------	-----	-----	---	-----

Nominal current	[A]	10	-	10
-----------------	-----	----	---	----

Connection capacity AWG	AWG	28 - 12	-	28 - 12
-------------------------	-----	---------	---	---------

General data

Stripping length	[mm]	7
------------------	------	---

Screw thread		M3
--------------	--	----

Tightening torque	[Nm]	0.5 - 0.6
-------------------	------	-----------

Type of insulation material / insulation material group		PA / I
---	--	--------

Inflammability class according to UL 94		V0
---	--	----

No. of pos.

Dim. a [mm]

2	5.08
3	10.16
4	15.24
5	20.32
6	25.40
7	30.48
8	35.56
9	40.64
10	45.72
11	50.80
12	55.88
13	60.96
14	66.04
15	71.12
16	76.20

Ordering data

Type

5.08 mm pitch, color: green

Order No.

Pcs. / Pkt.

MSTBU 2,5/ 2-STD-5,08	1824120	50
-----------------------	---------	----

MSTBU 2,5/ 3-STD-5,08	1824133	50
-----------------------	---------	----

MSTBU 2,5/ 4-STD-5,08	1824146	50
-----------------------	---------	----

MSTBU 2,5/ 5-STD-5,08	1824159	50
-----------------------	---------	----

MSTBU 2,5/ 6-STD-5,08	1824162	50
-----------------------	---------	----

MSTBU 2,5/ 7-STD-5,08	1824175	50
-----------------------	---------	----

MSTBU 2,5/ 8-STD-5,08	1824188	50
-----------------------	---------	----

MSTBU 2,5/ 9-STD-5,08	1824191	50
-----------------------	---------	----

MSTBU 2,5/10-STD-5,08	1824201	50
-----------------------	---------	----

MSTBU 2,5/11-STD-5,08	1824214	50
-----------------------	---------	----

MSTBU 2,5/12-STD-5,08	1824227	50
-----------------------	---------	----

MSTBU 2,5/13-STD-5,08	1824230	50
-----------------------	---------	----

MSTBU 2,5/14-STD-5,08	1824243	50
-----------------------	---------	----

MSTBU 2,5/15-STD-5,08	1824256	50
-----------------------	---------	----

MSTBU 2,5/16-STD-5,08	1824269	50
-----------------------	---------	----



With pin contacts and flange for direct mounting



With pin contacts, screw flange and flange for direct mounting



Dimensional drawing

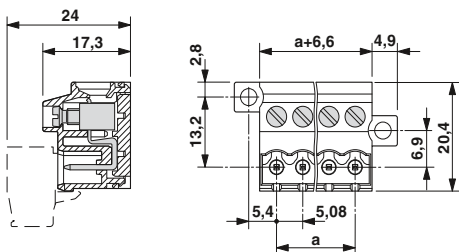

Drilling diagram

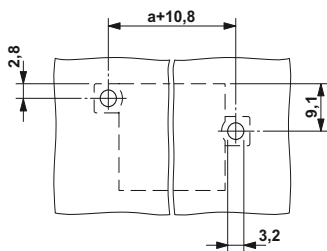

Ordering data

Type	Order No.	Pcs. / Pkt.
5.08 mm pitch, color: green		
MVSTBU 2,5/ 2-GB-5,08	1788538	50
MVSTBU 2,5/ 3-GB-5,08	1788541	50
MVSTBU 2,5/ 4-GB-5,08	1788554	50
MVSTBU 2,5/ 5-GB-5,08	1788567	50
MVSTBU 2,5/ 6-GB-5,08	1788570	50
MVSTBU 2,5/ 7-GB-5,08	1788583	50
MVSTBU 2,5/ 8-GB-5,08	1788596	50
MVSTBU 2,5/ 9-GB-5,08	1788606	50
MVSTBU 2,5/10-GB-5,08	1788619	50
MVSTBU 2,5/11-GB-5,08	1788622	50
MVSTBU 2,5/12-GB-5,08	1788635	50
MVSTBU 2,5/13-GB-5,08	1788648	50
MVSTBU 2,5/14-GB-5,08	1788651	50
MVSTBU 2,5/15-GB-5,08	1788664	50
MVSTBU 2,5/16-GB-5,08	1788677	50



Dimensional drawing

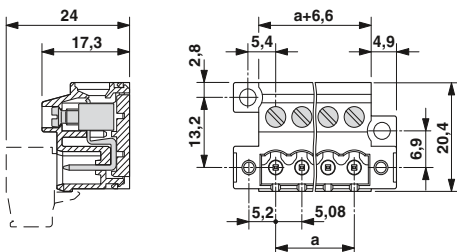

Drilling diagram

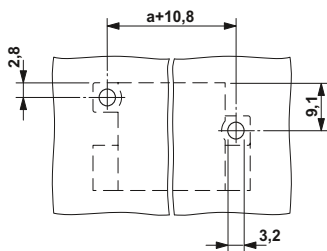

Ordering data

Type	Order No.	Pcs. / Pkt.
5.08 mm pitch, color: green		
MVSTBU 2,5/ 2-GFB-5,08	1788347	50
MVSTBU 2,5/ 3-GFB-5,08	1788350	50
MVSTBU 2,5/ 4-GFB-5,08	1788363	50
MVSTBU 2,5/ 5-GFB-5,08	1788376	50
MVSTBU 2,5/ 6-GFB-5,08	1788389	50
MVSTBU 2,5/ 7-GFB-5,08	1788392	50
MVSTBU 2,5/ 8-GFB-5,08	1788402	50
MVSTBU 2,5/ 9-GFB-5,08	1788415	50
MVSTBU 2,5/10-GFB-5,08	1788428	50
MVSTBU 2,5/11-GFB-5,08	1788431	50
MVSTBU 2,5/12-GFB-5,08	1788444	50
MVSTBU 2,5/13-GFB-5,08	1788457	50
MVSTBU 2,5/14-GFB-5,08	1788460	50
MVSTBU 2,5/15-GFB-5,08	1788473	50
MVSTBU 2,5/16-GFB-5,08	1788486	50

Classic plug-in connector with 5.0 to 7.62 mm pitch

Special types

Plug-in blocks for rail mounting

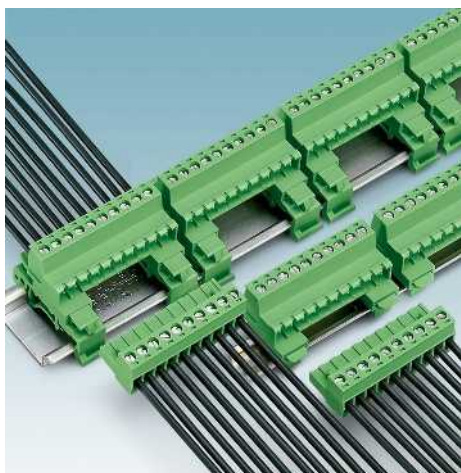

- MSTBVK 2,5 with foot element for mounting on the 15 x 5 mm DIN rail (NS15) in accordance with EN 60715-TH15
- UMSTBHK 2,5 with universal foot for mounting on NS 32 or NS 35 DIN rails
- Can be combined with plugs:
 - MSTB(P) 2,5/...-ST...
 - FRONT-MSTB 2,5/...-ST...
 - FKC(S) 2,5/...-ST...
 - FKCN 2,5/...-ST...
 - FKCVR 2,5/...-ST...
 - ICV 2,5/...-G...

Notes:

In accordance with DIN EN 61984, COMBICON plug-in connectors have no switching power. During designated use, they must not be plugged in or disconnected when carrying voltage or under load.

For DIN rails, see Catalog 5.



Inverted plug with screw connection for mounting on NS 15 DIN rail



Accessories

For all types	Type	Page
	Coding tab MSTB-BL Order No. 1755477	837
	Locking for MSTB plugs, 9.9 mm width MSTBHK 2,5/2-AH Order No. 5030185	
	Screwdriver SZS 0,6 x 3,5 Order No. 1205053	
Only for MSTBHK 2,5/10-G...		
	End clamp E/MBK Order No. 1401637	
Only for UMSTBHK 2,5/10-G		
	End clamp E/UK Order No. 1201442	

Dimensional drawing

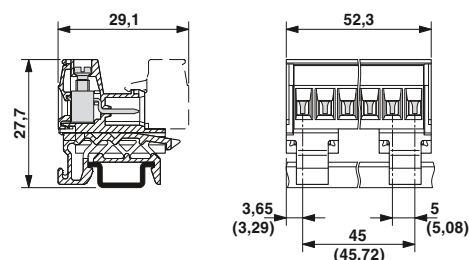

Technical data

Technical data in accordance to IEC / DIN VDE	
Rated current / conductor cross section	[A] / [mm ²]
Rated insulation voltage for pollution degree 2	[V]
Pitch	[mm]
Connection capacity	
Solid / stranded	[mm ²] / [mm ²] / AWG
Stranded with ferrules without plastic sleeve	[mm ²]
Stranded with ferrules with plastic sleeve	[mm ²]
Multi-conductor connection capacity (two conductors with the same cross section)	
Solid / stranded	[mm ²]
Stranded with ferrules without plastic sleeve	[mm ²]
Stranded with TWIN ferrule with plastic sleeve	[mm ²]
Insulation coordination	
Surge voltage category / pollution degree	III / 3 III / 2 II / 2
Rated insulation voltage	[V] 250 320 630
Rated surge voltage	[kV] 4 4 4
Approval data (UL/CUL)	Use Group B C D
Nominal voltage	[V] 250 - 300
Nominal current	[A] 12 - 10
Connection capacity AWG	AWG 30 - 12 - 30 - 12
Approval data (CSA)	Use Group B C D
Nominal voltage	[V] 300 - 300
Nominal current	[A] 10 - 10
Connection capacity AWG	AWG 28 - 12 - 28 - 12
General data	
Stripping length	[mm] 7
Screw thread	M3
Tightening torque	[Nm] 0.5 - 0.6
Type of insulation material / insulation material group	PA / I
Inflammability class according to UL 94	V0

Ordering data

Type	Order No.	Pcs. / Pkt.
5.0 mm pitch, color: green		
MSTBHK 2,5/10-G	1765085	50
5.08 mm pitch, color: green		
MSTBHK 2,5/10-G-5,08	1765030	50



Inverted plug with universal foot for mounting on NS 32 and NS 35



Dimensional drawing

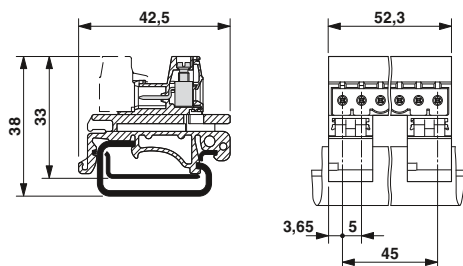

Ordering data

Type	Order No.	Pcs. / Pkt.
5.0 mm pitch, color: green		
UMSTBHK 2,5/10-G	1765768	50

Classic plug-in connector with 5.0 to 7.62 mm pitch

Special types

Plug-in blocks for rail mounting



- Can be combined with COMBICON plugs with 5.08 mm grid
- Versions with and without a threaded flange
- Higher numbers of positions up to 24-pos. can be found at:
www.phoenixcontact.net/products

MSTBVK 2,5/...-G(F)-5,08

- With a foot element for mounting on a 15 x 5 mm DIN rail (NS 15) acc. to EN 60715-TH15

UMSTBVK 2,5/...-G(F)-5,08

- With universal foot for mounting on NS 32 or NS 35 DIN rails

Notes:

In accordance with DIN EN 61984, COMBICON plug-in connectors have no switching power. During designated use, they must not be plugged in or disconnected when carrying voltage or under load.

For DIN rails, see Catalog 5.



For mounting on NS 15



Dimensional drawing

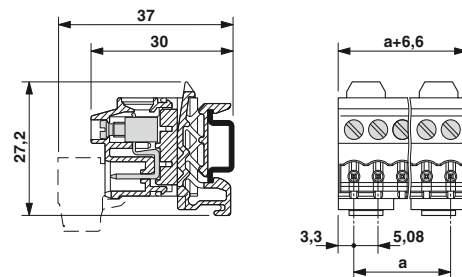

Accessories

For all types	Type	Page
	Marker cards SK 5,08/3,8	798
	Coding section CR-MSTB Order No. 1734401	38
	Screwdriver SZS 0,6 x 3,5 Order No. 1205053	
	Coding tab MSTB-BL Order No. 1755477	837
	Insertion bridge EBP...- 5	829

Technical data

Technical data in accordance to IEC / DIN VDE

Rated current / conductor cross section	[A] / [mm ²]	12 / 2.5
Rated insulation voltage for pollution degree 2	[V]	320

Pitch	[mm]	5.08
-------	------	------

Connection capacity

Solid / stranded	[mm ²] / [mm ²] / AWG	0.2 - 2.5 / 0.2 - 2.5 / 24 - 12
------------------	---	---------------------------------

Stranded with ferrules without plastic sleeve	[mm ²]	0.25 - 2.5
---	--------------------	------------

Stranded with ferrules with plastic sleeve	[mm ²]	0.25 - 2.5
--	--------------------	------------

Multi-conductor connection capacity (two conductors with the same cross section)

Solid / stranded	[mm ²]	0.2 - 1 / 0.2 - 1.5
------------------	--------------------	---------------------

Stranded with ferrules without plastic sleeve	[mm ²]	0.25 - 1
---	--------------------	----------

Stranded with TWIN ferrule with plastic sleeve	[mm ²]	0.5 - 1.5
--	--------------------	-----------

Insulation coordination

Surge voltage category / pollution degree	III / 3	III / 2	II / 2
---	---------	---------	--------

Rated insulation voltage	[V]	320	320	630
--------------------------	-----	-----	-----	-----

Rated surge voltage	[kV]	4	4	4
---------------------	------	---	---	---

Approval data (UL/CUL) Use Group

Nominal voltage	[V]	250	-	300
-----------------	-----	-----	---	-----

Nominal current	[A]	12	-	10
-----------------	-----	----	---	----

Connection capacity AWG

AWG	30 - 12	-	30 - 12
-----	---------	---	---------

Approval data (CSA) Use Group

Nominal voltage	[V]	300	-	300
-----------------	-----	-----	---	-----

Nominal current	[A]	10	-	10
-----------------	-----	----	---	----

Connection capacity AWG

AWG	28 - 12	-	28 - 12
-----	---------	---	---------

General data

Stripping length	[mm]	7
------------------	------	---

Screw thread		M3
--------------	--	----

Tightening torque	[Nm]	0.5 - 0.6
-------------------	------	-----------

Type of insulation material / insulation material group

		PA / I
--	--	--------

Inflammability class according to UL 94

		V0
--	--	----

Ordering data

Type	Order No.	Pcs. / Pkt.
5.08 mm pitch, color: green		
MSTBVK 2,5/ 2-G-5,08	1788729	50
MSTBVK 2,5/ 3-G-5,08	1788732	50
MSTBVK 2,5/ 4-G-5,08	1788745	50
MSTBVK 2,5/ 5-G-5,08	1788758	50
MSTBVK 2,5/ 6-G-5,08	1788761	50
MSTBVK 2,5/ 7-G-5,08	1788774	50
MSTBVK 2,5/ 8-G-5,08	1788787	50
MSTBVK 2,5/ 9-G-5,08	1788790	50
MSTBVK 2,5/10-G-5,08	1788800	50
MSTBVK 2,5/11-G-5,08	1788813	50
MSTBVK 2,5/12-G-5,08	1788826	50
MSTBVK 2,5/13-G-5,08	1788839	50
MSTBVK 2,5/14-G-5,08	1788842	50
MSTBVK 2,5/15-G-5,08	1788855	50
MSTBVK 2,5/16-G-5,08	1788868	50



With threaded flange for mounting on NS 15



With universal foot for mounting on NS 32 or NS 35



With threaded flange and universal foot for mounting on NS 32 or NS 35



Dimensional drawing

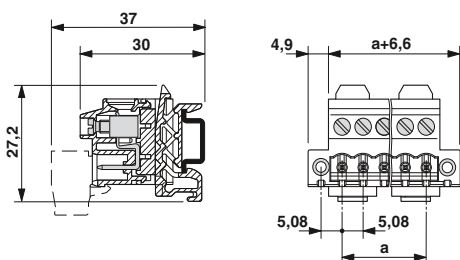

Dimensional drawing

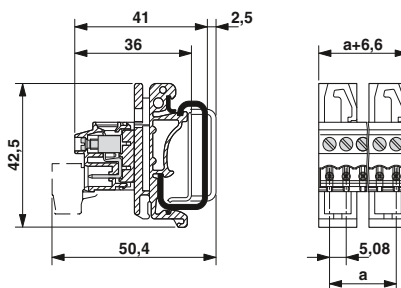

Dimensional drawing

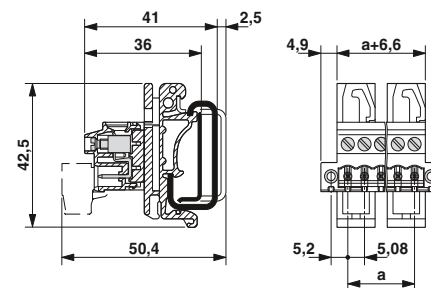

Ordering data

Type	Order No.	Pcs. / Pkt.
5.08 mm pitch, color: green		
MSTBVK 2,5/ 2-GF-5,08	1788952	50
MSTBVK 2,5/ 3-GF-5,08	1788965	50
MSTBVK 2,5/ 4-GF-5,08	1788978	50
MSTBVK 2,5/ 5-GF-5,08	1788981	50
MSTBVK 2,5/ 6-GF-5,08	1788994	50
MSTBVK 2,5/ 7-GF-5,08	1789003	50
MSTBVK 2,5/ 8-GF-5,08	1803015	50
MSTBVK 2,5/ 9-GF-5,08	1803028	50
MSTBVK 2,5/10-GF-5,08	1803031	50
MSTBVK 2,5/11-GF-5,08	1803044	50
MSTBVK 2,5/12-GF-5,08	1803057	50
MSTBVK 2,5/13-GF-5,08	1803060	50
MSTBVK 2,5/14-GF-5,08	1803073	50
MSTBVK 2,5/15-GF-5,08	1803086	50
MSTBVK 2,5/16-GF-5,08	1803099	50

Ordering data

Type	Order No.	Pcs. / Pkt.
5.08 mm pitch, color: green		
UMSTBVK 2,5/ 2-G-5,08	1788114	50
UMSTBVK 2,5/ 3-G-5,08	1788127	50
UMSTBVK 2,5/ 4-G-5,08	1788130	50
UMSTBVK 2,5/ 5-G-5,08	1788143	50
UMSTBVK 2,5/ 6-G-5,08	1788156	50
UMSTBVK 2,5/ 7-G-5,08	1788169	50
UMSTBVK 2,5/ 8-G-5,08	1788172	50
UMSTBVK 2,5/ 9-G-5,08	1788185	50
UMSTBVK 2,5/10-G-5,08	1788198	50
UMSTBVK 2,5/11-G-5,08	1788208	50
UMSTBVK 2,5/12-G-5,08	1788211	50
UMSTBVK 2,5/13-G-5,08	1788224	50
UMSTBVK 2,5/14-G-5,08	1788237	50
UMSTBVK 2,5/15-G-5,08	1788240	50
UMSTBVK 2,5/16-G-5,08	1788253	50

Ordering data

Type	Order No.	Pcs. / Pkt.
5.08 mm pitch, color: green		
UMSTBVK 2,5/ 2-GF-5,08	1787924	50
UMSTBVK 2,5/ 3-GF-5,08	1787937	50
UMSTBVK 2,5/ 4-GF-5,08	1787940	50
UMSTBVK 2,5/ 5-GF-5,08	1787953	50
UMSTBVK 2,5/ 6-GF-5,08	1787966	50
UMSTBVK 2,5/ 7-GF-5,08	1787979	50
UMSTBVK 2,5/ 8-GF-5,08	1787982	50
UMSTBVK 2,5/ 9-GF-5,08	1787995	50
UMSTBVK 2,5/10-GF-5,08	1788004	50
UMSTBVK 2,5/11-GF-5,08	1788017	50
UMSTBVK 2,5/12-GF-5,08	1788020	50
UMSTBVK 2,5/13-GF-5,08	1788033	50
UMSTBVK 2,5/14-GF-5,08	1788046	50
UMSTBVK 2,5/15-GF-5,08	1788059	50
UMSTBVK 2,5/16-GF-5,08	1788062	50

Classic plug-in connector with 5.0 to 7.62 mm pitch

Special types

Plug-in blocks for rail mounting

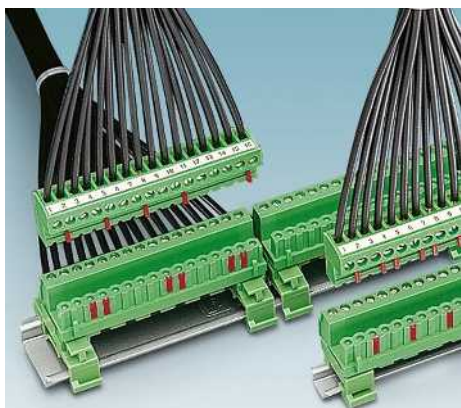

- With universal foot for mounting on NS 32 or NS 35 DIN rails
- Versions with and without a threaded flange
- Can be combined with the following plugs:
IC 2,5/...-ST(F)...
- FKIC 2,5/...-ST(F)...
- FKICS 2,5/...-ST(F)...

Notes:

In accordance with DIN EN 61984, COMBICON plug-in connectors have no switching power. During designated use, they must not be plugged in or disconnected when carrying voltage or under load.





For DIN rails, see Catalog 5.



With universal foot,
for mounting on NS 32 or NS 35



Accessories

For all types	Type	Page
	Marker cards SK 5,08/3,8	798
	Coding profile CP-MSTB Order No. 1734634	38
	Screwdriver SZS 0,6 x 3,5 Order No. 1205053	
	Insertion bridge EBP...-5	829

Dimensional drawing

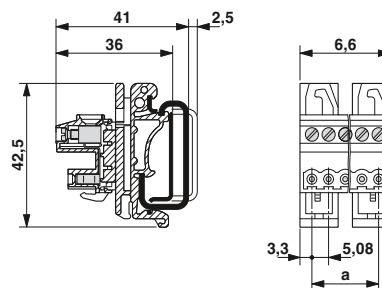

Technical data

Technical data in accordance to IEC / DIN VDE	
Rated current / conductor cross section	[A] / [mm ²]
Rated insulation voltage for pollution degree 2	[V]
Pitch	[mm]
Connection capacity	
Solid / stranded	[mm ²] / [mm ²] / AWG
Stranded with ferrules without plastic sleeve	[mm ²]
Stranded with ferrules with plastic sleeve	[mm ²]
Multi-conductor connection capacity (two conductors with the same cross section)	
Solid / stranded	[mm ²]
Stranded with ferrules without plastic sleeve	[mm ²]
Stranded with TWIN ferrule with plastic sleeve	[mm ²]
Insulation coordination	
Surge voltage category / pollution degree	
Rated insulation voltage	[V]
Rated surge voltage	[kV]
Approval data (UL/CUL)	Use Group
Nominal voltage	[V]
Nominal current	[A]
Connection capacity AWG	AWG
Approval data (CSA)	Use Group
Nominal voltage	[V]
Nominal current	[A]
Connection capacity AWG	AWG
General data	
Stripping length	[mm]
Screw thread	
Tightening torque	[Nm]
Type of insulation material / insulation material group	
Inflammability class according to UL 94	

	12 / 2.5
	320
	5.08
	0.2 - 2.5 / 0.2 - 2.5 / 24 - 12
	0.25 - 2.5
	0.25 - 2.5
	0.2 - 1 / 0.2 - 1.5
	0.25 - 1
	0.5 - 1.5
	III / 3 III / 2 II / 2
	320 320 630
	4 4 4
	B C D
	250 - 300
	12 - 10
	30 - 12 - 30 - 12
	B C D
	300 - 300
	10 - 10
	28 - 12 - 28 - 12
	7
	M3
	0.5 - 0.6
	PA / I
	V0

No. of pos.	Dim. a [mm]
5	20.32
6	25.40
7	30.48
8	35.56
9	40.64
10	45.72
11	50.80
12	55.88
13	60.96
14	66.04
15	71.12
16	76.20

Ordering data

Type	Order No.	Pcs. / Pkt.
5.08 mm pitch, color: green		
UMSTBVK 2,5/ 5-ST-5,08	1833849	50
UMSTBVK 2,5/ 6-ST-5,08	1833852	50
UMSTBVK 2,5/ 7-ST-5,08	1833865	50
UMSTBVK 2,5/ 8-ST-5,08	1833878	50
UMSTBVK 2,5/ 9-ST-5,08	1833881	50
UMSTBVK 2,5/10-ST-5,08	1833894	50
UMSTBVK 2,5/11-ST-5,08	1833904	50
UMSTBVK 2,5/12-ST-5,08	1833917	50
UMSTBVK 2,5/13-ST-5,08	1833920	50
UMSTBVK 2,5/14-ST-5,08	1833933	50
UMSTBVK 2,5/15-ST-5,08	1833946	50
UMSTBVK 2,5/16-ST-5,08	1833959	50



With screw flange and universal foot,
for mounting on NS 32 or NS 35



Dimensional drawing

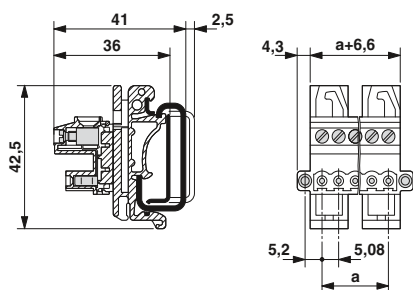

Ordering data

Type	Order No.	Pcs. / Pkt.
5.08 mm pitch, color: green		
UMSTBVK 2,5/ 5-STF-5,08	1859205	50
UMSTBVK 2,5/ 6-STF-5,08	1859218	50
UMSTBVK 2,5/ 7-STF-5,08	1859221	50
UMSTBVK 2,5/ 8-STF-5,08	1859234	50
UMSTBVK 2,5/ 9-STF-5,08	1859247	50
UMSTBVK 2,5/10-STF-5,08	1859250	50
UMSTBVK 2,5/11-STF-5,08	1859263	50
UMSTBVK 2,5/12-STF-5,08	1859276	50
UMSTBVK 2,5/13-STF-5,08	1859289	50
UMSTBVK 2,5/14-STF-5,08	1859292	50
UMSTBVK 2,5/15-STF-5,08	1859302	50
UMSTBVK 2,5/16-STF-5,08	1859315	50

Classic plug-in connector with 5.0 to 7.62 mm pitch

Special types

ZEC series plug-in connectors make contact directly on the PCB

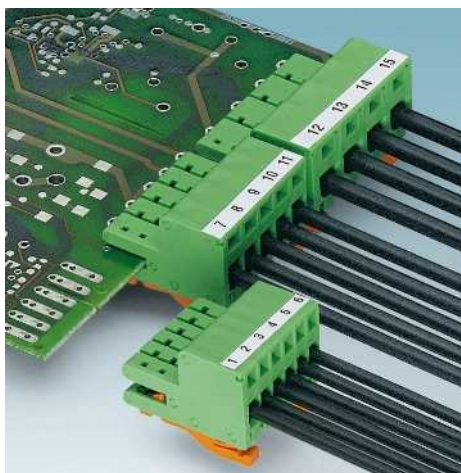

- Contact directly on a 1.6 mm thick PCB without an additional pin strip
- ZEC ST: plug-in connector with spring-cage connection
- ZEC LPV: plug-in connector for the parallel connection of two PCBs
- A mixture of 3.5/5.0/7.5 mm pitches is possible in one connector
- Larger numbers of positions on request
- Recommended surface for the contact pads: hot air level (HAL) Sn 5 up to 10 µm
- Chamfer in plug area has a positive effect on insertion and withdrawal forces/cycles
- Details about plug-in systems, see page 25

Notes:

In accordance with DIN EN 61984, COMBICON plug-in connectors have no switching power. During designated use, they must not be plugged in or disconnected when carrying voltage or under load.

1) Please observe the derating curves. Derating curves for further ZEC connectors on request.

Type key

ZEC 1,5 / 2 -ST- 5,0 C2 R1,2

Cross section

Number of positions 2)

Pitch

Coding in pos. 2³⁾

Engagement latch position, pos. 1, 2

2) Number of positions > 12 on request

3) Standard:

C 1 with a 3.5 mm pitch

C 2 with 5 and 7.5 mm pitch.

Individual coding on request.

Accessories

For all types	Type	Page
Only for ZEC 1,0/...-ST-3,5		
	Screwdriver SZF 0-0,4 x 2,5 Order No. 1204504	
	Marker cards SK 3,5/2,8	797
Only for ZEC 1,5/...-LPV-5,0		
	Screwdriver SZF 1-0,6 x 3,5 Order No. 1204517	
	Marker cards SK 5/3,8	798

Type: ZEC 1,0/...-ST-3,5

Derating curve, determined as per DIN EN 61984 (VDE 0627):2002-09

Representation based on DIN EN 60512-5-2:2003-01

Connected conductor cross section = 1 mm²

Reduction factor = 0.8

Number of positions = see diagram

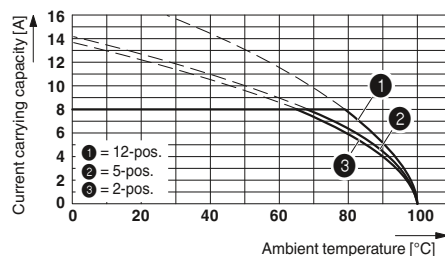

Technical data

Technical data in accordance to IEC / DIN VDE

Rated current / conductor cross section	[A] / [mm ²]
Rated insulation voltage for pollution degree 2	[V]
Pitch	[mm]
Connection capacity	
Solid / stranded	[mm ²] / [mm ²] / AWG
Stranded with ferrules without plastic sleeve	[mm ²]
Stranded with ferrules with plastic sleeve	[mm ²]
Multi-conductor connection capacity (two conductors with the same cross section)	
Solid / stranded	[mm ²]
Stranded with ferrules without plastic sleeve	[mm ²]
Stranded with TWIN ferrule with plastic sleeve	[mm ²]
Insulation coordination	
Surge voltage category / pollution degree	
Rated insulation voltage	[V]
Rated surge voltage	[kV]
Approval data (UL/CUL)	Use Group
Nominal voltage	[V]
Nominal current	[A]
Connection capacity AWG	AWG
Approval data (CSA)	Use Group
Nominal voltage	[V]
Nominal current	[A]
Connection capacity AWG	AWG
General data	
Stripping length	[mm]
Type of insulation material / insulation material group	
Inflammability class according to UL 94	

ZEC 1,0/ ...-ST-3,5 C1 R1

Rated current / conductor cross section	8 ¹⁾ / 1
Rated insulation voltage for pollution degree 2	200
Pitch	3.5
Connection capacity	
Solid / stranded	0.2 - 1 / 0.2 - 1 / 24 - 16
Stranded with ferrules without plastic sleeve	0.25 - 1
Stranded with ferrules with plastic sleeve	0.25 - 0.75
Multi-conductor connection capacity (two conductors with the same cross section)	
Solid / stranded	- / -
Stranded with ferrules without plastic sleeve	-
Stranded with TWIN ferrule with plastic sleeve	0.5 - 0.5
Insulation coordination	
Surge voltage category / pollution degree	III / 3 III / 2 II / 2
Rated insulation voltage	160 200 320
Rated surge voltage	2.5 2.5 2.5
Approval data (UL/CUL)	B C D
Nominal voltage	150 - 300
Nominal current	8 - 8
Connection capacity AWG	26 - 16 - 26 - 16
Approval data (CSA)	B C D
Nominal voltage	- - -
Nominal current	- - -
Connection capacity AWG	- - -
General data	
Stripping length	7
Type of insulation material / insulation material group	PA / I
Inflammability class according to UL 94	V0

ZEC 1,0/ ...-LPV-3,5 C1

Rated current / conductor cross section	8 ¹⁾ / 1
Rated insulation voltage for pollution degree 2	200
Pitch	3.5
Connection capacity	
Solid / stranded	- / - / -
Stranded with ferrules without plastic sleeve	-
Stranded with ferrules with plastic sleeve	-
Multi-conductor connection capacity (two conductors with the same cross section)	
Solid / stranded	- / -
Stranded with ferrules without plastic sleeve	-
Stranded with TWIN ferrule with plastic sleeve	-
Insulation coordination	
Surge voltage category / pollution degree	III / 3 III / 2 II / 2
Rated insulation voltage	160 200 320
Rated surge voltage	2.5 2.5 2.5
Approval data (UL/CUL)	B C D
Nominal voltage	150 - -
Nominal current	8 - -
Connection capacity AWG	- - -
Approval data (CSA)	B C D
Nominal voltage	- - -
Nominal current	- - -
Connection capacity AWG	- - -
General data	
Stripping length	-
Type of insulation material / insulation material group	PA / I
Inflammability class according to UL 94	V0

ZEC 1,5/ ...-ST-5,0 C2 R1,2

Rated current / conductor cross section	10 ¹⁾ / 1.5
Rated insulation voltage for pollution degree 2	320
Pitch	5
Connection capacity	
Solid / stranded	0.2 - 1.5 / 0.2 - 1.5 / 24 - 16
Stranded with ferrules without plastic sleeve	0.25 - 1.5
Stranded with ferrules with plastic sleeve	0.25 - 1.5
Multi-conductor connection capacity (two conductors with the same cross section)	
Solid / stranded	- / -
Stranded with ferrules without plastic sleeve	-
Stranded with TWIN ferrule with plastic sleeve	0.5 - 0.5
Insulation coordination	
Surge voltage category / pollution degree	III / 3 III / 2 II / 2
Rated insulation voltage	250 320 630
Rated surge voltage	4 4 4
Approval data (UL/CUL)	B C D
Nominal voltage	300 - 300
Nominal current	10 - 10
Connection capacity AWG	26 - 14 - 26 - 14
Approval data (CSA)	B C D
Nominal voltage	- - -
Nominal current	- - -
Connection capacity AWG	- - -
General data	
Stripping length	7
Type of insulation material / insulation material group	PA / I
Inflammability class according to UL 94	V0

No. of pos.	Dim. a [mm]
2	7.00
3	10.50
4	14.00
5	17.50
6	21.00
7	24.50
8	28.00
9	31.50
10	35.00
11	38.50
12	42.00



Direct plug-in connector with 3.5 mm pitch, plug-in direction parallel to the PCB



PCB connector with 3.5 mm pitch, plug-in direction parallel to the PCB



Direct plug-in connector with 5.0 mm pitch, plug-in direction parallel to the PCB



Dimensional drawing

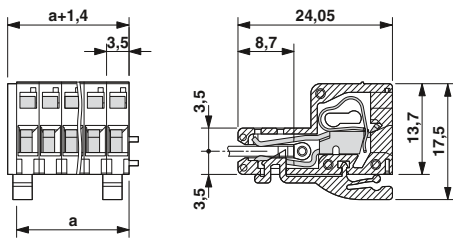

Drilling diagram

Size of the PCB: 1.6 ± 0.2 mm

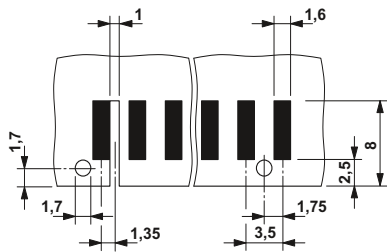

Ordering data

Type	Order No.	Pcs. / Pkt.
Direct plug connector, 3.5 mm pitch, color: green		
ZEC 1,0/ 2-ST-3,5 C1 R1	1893685	50
ZEC 1,0/ 3-ST-3,5 C1 R1,3	1893698	50
ZEC 1,0/ 4-ST-3,5 C1 R1,4	1893708	50
ZEC 1,0/ 5-ST-3,5 C1 R1,5	1893711	50
ZEC 1,0/ 6-ST-3,5 C1 R1,6	1893724	50
ZEC 1,0/ 7-ST-3,5 C1 R1,7	1893737	50
ZEC 1,0/ 8-ST-3,5 C1 R1,8	1893740	50
ZEC 1,0/ 9-ST-3,5 C1 R1,9	1893753	50
ZEC 1,0/10-ST-3,5 C1 R1,10	1893766	50
ZEC 1,0/11-ST-3,5 C1 R1,11	1893779	50
ZEC 1,0/12-ST-3,5 C1 R1,12	1893782	50



Dimensional drawing

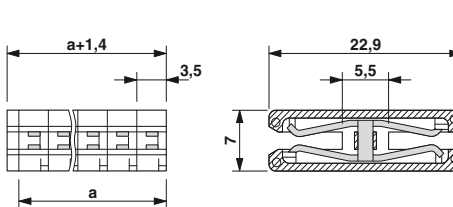

Drilling diagram

Size of the PCB: 1.6 ± 0.2 mm

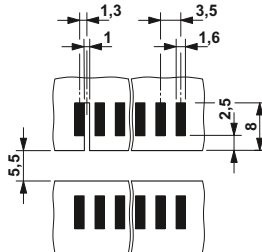

Ordering data

Type	Order No.	Pcs. / Pkt.
PCB connector, 3.5 mm pitch, color: green		
ZEC 1,0/ 2-LPV-3,5 C1	1915657	50
ZEC 1,0/ 3-LPV-3,5 C1	1915660	50
ZEC 1,0/ 4-LPV-3,5 C1	1915673	50
ZEC 1,0/ 5-LPV-3,5 C1	1915686	50
ZEC 1,0/ 6-LPV-3,5 C1	1915699	50
ZEC 1,0/ 7-LPV-3,5 C1	1915709	50
ZEC 1,0/ 8-LPV-3,5 C1	1915712	50
ZEC 1,0/ 9-LPV-3,5 C1	1915725	50
ZEC 1,0/10-LPV-3,5 C1	1915738	50
ZEC 1,0/11-LPV-3,5 C1	1915741	50
ZEC 1,0/12-LPV-3,5 C1	1915754	50



Dimensional drawing

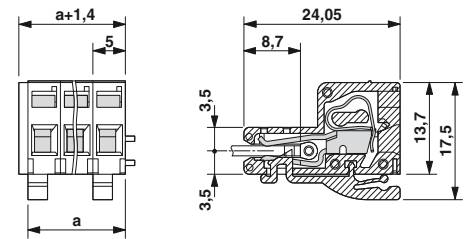

Drilling diagram

Size of the PCB: 1.6 ± 0.2 mm

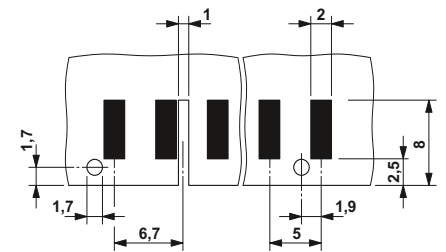

Ordering data

Type	Order No.	Pcs. / Pkt.
Direct plug connector, pitch 5.0 mm, color: green		
ZEC 1,5/ 2-ST-5,0 C2 R1,2	1883048	50
ZEC 1,5/ 3-ST-5,0 C2 R1,3	1883051	50
ZEC 1,5/ 4-ST-5,0 C2 R1,4	1883064	50
ZEC 1,5/ 5-ST-5,0 C2 R1,5	1883077	50
ZEC 1,5/ 6-ST-5,0 C2 R1,6	1883080	50
ZEC 1,5/ 7-ST-5,0 C2 R1,7	1883093	50
ZEC 1,5/ 8-ST-5,0 C2 R1,8	1883103	50
ZEC 1,5/ 9-ST-5,0 C2 R1,9	1883116	50
ZEC 1,5/10-ST-5,0 C2 R1,10	1883129	50
ZEC 1,5/11-ST-5,0 C2 R1,11	1883132	50
ZEC 1,5/12-ST-5,0 C2 R1,12	1883802	50

Classic plug-in connector with 5.0 to 7.62 mm pitch

Special types

ZEC series plug-in connectors make contact directly on the PCB

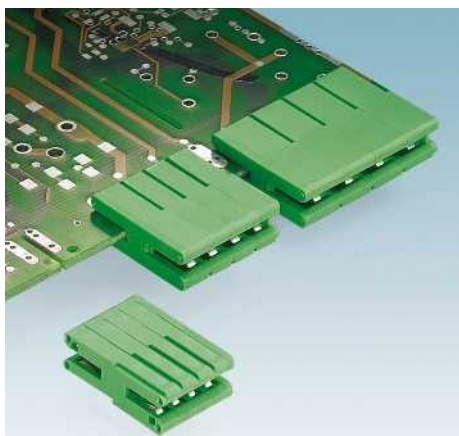

- ZEC...7,5: plug-in connectors for applications with higher voltage
- Contact directly on a 1.6 mm thick PCB without an additional pin strip
- ZEC ST: plug-in connector with spring-cage connection
- ZEC LPV: plug-in connector for the parallel connection of two PCBs
- A mixture of 3.5/5.0/7.5 mm pitches is possible in one connector
- Recommended surface for the contact pads: hot air level (HAL) Sn 5 up to 10 µm
- Chamfer in plug area has a positive effect on insertion and withdrawal forces/cycles
- Larger numbers of positions on request
- For details about plug-in systems, see page 25

Notes:

In accordance with DIN EN 61984, COMBICON plug-in connectors have no switching power. During designated use, they must not be plugged in or disconnected when carrying voltage or under load.

1) Please observe the derating curves. Derating curves for further ZEC connectors on request.

Type key

ZEC 1,5 / 2 -ST- 5,0 C2 R1,2

Cross section

Number of positions 2)

Pitch

Coding in pos. 2³⁾

Engagement latch position, pos. 1, 2

2) Number of positions > 12 on request



3) Standard:

C 1 with a 3.5 mm pitch

C 2 with 5 and 7.5 mm pitch.

Individual coding on request.

Accessories

For all types	Type	Page
Only for ZEC 1,5/...-ST-7,5 and ZEC 1,5/...-LPV-7,5		
	Screwdriver SZF 1-0,6 x 3,5 Order No. 1204517	
	Marker cards SK 7,5/3,8	799
Only for ZEC 1,5/...-ST-5,0		
	Marker cards SK 5/3,8	798

Type: ZEC 1,5/...-ST-7,5

Derating curve, determined as per DIN EN 61984 (VDE 0627):2002-09

Representation based on DIN EN 60512-5-2:2003-01

Connected conductor cross section = 1.5 mm²

Reduction factor = 0.8

Number of positions = see diagram

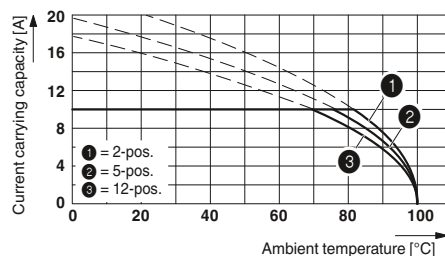

Technical data

Technical data in accordance to IEC / DIN VDE	
Rated current / conductor cross section	[A] / [mm ²]
Rated insulation voltage for pollution degree 2	[V]
Pitch	[mm]
Connection capacity	
Solid / stranded	[mm ²] / [mm ²] / AWG
Stranded with ferrules without plastic sleeve	[mm ²]
Stranded with ferrules with plastic sleeve	[mm ²]
Multi-conductor connection capacity (two conductors with the same cross section)	
Solid / stranded	[mm ²]
Stranded with ferrules without plastic sleeve	[mm ²]
Stranded with TWIN ferrule with plastic sleeve	[mm ²]
Insulation coordination	
Surge voltage category / pollution degree	
Rated insulation voltage	[V]
Rated surge voltage	[kV]
Approval data (UL/CUL)	Use Group
Nominal voltage	[V]
Nominal current	[A]
Connection capacity AWG	AWG
Approval data (CSA)	Use Group
Nominal voltage	[V]
Nominal current	[A]
Connection capacity AWG	AWG
General data	
Type of insulation material / insulation material group	
Inflammability class according to UL 94	

ZEC 1,5/ ...-LPV-5,0 C2			ZEC 1,5/ ...-ST-7,5 C2 R1,2			ZEC 1,5/ ...-LPV-7,5 C2		
10 ¹⁾ / 1.5			10 ¹⁾ / 1.5			10 ¹⁾ / 1.5		
320			630			630		
5			7.5			7.5		
- / - / -			0.2 - 1.5 / 0.2 - 1.5 / 24 - 16			- / - / -		
-			0.25 - 1.5			-		
-			0.25 - 1.5			-		
- / -			- / -			- / -		
-			-			-		
-			0.5 - 0.5			-		
III / 3	III / 2	II / 2	III / 3	III / 2	II / 2	III / 3	III / 2	II / 2
250	320	630	400	630	1000	400	630	1000
4	4	4	6	6	6	6	6	6
B	C	D	B	C	D	B	C	D
300	-	300	300	-	300	300	-	300
10	-	10	10	-	10	10	-	10
-	-	-	26 - 14	-	26 - 14	-	-	-
B	C	D	B	C	D	B	C	D
-	-	-	-	-	-	-	-	-
-	-	-	-	-	-	-	-	-
-	-	-	-	-	-	-	-	-
PA / I			PA / I			PA / I		
V0			V0			V0		

No. of pos.	Dim. a [mm]
2	10.00
3	15.00
4	20.00
5	25.00
6	30.00
7	35.00
8	40.00
2	15.00
3	22.50
4	30.00
5	37.50
6	45.00
7	52.50
8	60.00
9	67.50
10	75.00
11	82.50
12	90.00



PCB connector with 5.0 mm pitch, plug-in direction parallel to the PCB



Direct plug-in connector with 7.5 mm pitch, plug-in direction parallel to the PCB



PCB connector with 7.5 mm pitch, plug-in direction parallel to the PCB



Dimensional drawing

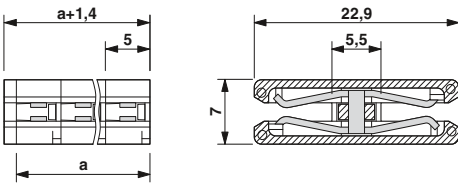

Drilling diagram

Size of the PCB: 1.6 ± 0.2 mm

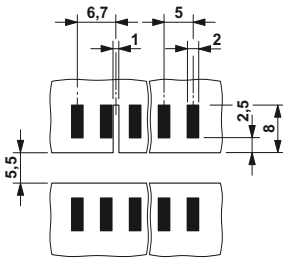

Ordering data

Type	Order No.	Pcs. / Pkt.
PCB connector, 5.0 mm pitch, color: green		
ZEC 1,5/ 2-LPV-5,0 C2	1898266	50
ZEC 1,5/ 3-LPV-5,0 C2	1898279	50
ZEC 1,5/ 4-LPV-5,0 C2	1898282	50
ZEC 1,5/ 5-LPV-5,0 C2	1898295	50
ZEC 1,5/ 6-LPV-5,0 C2	1898305	50
ZEC 1,5/ 7-LPV-5,0 C2	1898318	50
ZEC 1,5/ 8-LPV-5,0 C2	1898321	50



Dimensional drawing

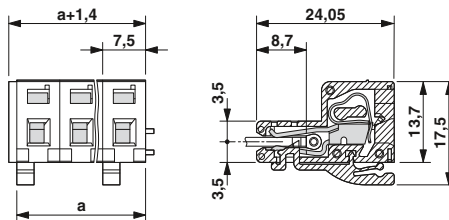

Drilling diagram

Size of the PCB: 1.6 ± 0.2 mm

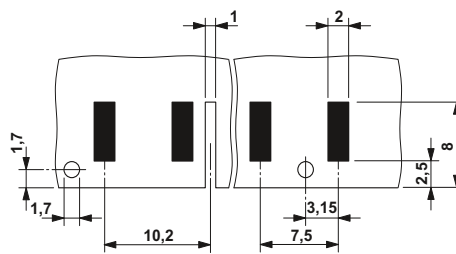

Ordering data

Type	Order No.	Pcs. / Pkt.
Direct plug connector, 7.5 mm pitch, color: green		
ZEC 1,5/ 2-ST-7,5 C2 R1,2	1883145	50
ZEC 1,5/ 3-ST-7,5 C2 R1,3	1883158	50
ZEC 1,5/ 4-ST-7,5 C2 R1,4	1883161	50
ZEC 1,5/ 5-ST-7,5 C2 R1,5	1883174	50
ZEC 1,5/ 6-ST-7,5 C2 R1,6	1883187	50
ZEC 1,5/ 7-ST-7,5 C2 R1,7	1883190	50
ZEC 1,5/ 8-ST-7,5 C2 R1,8	1883200	50
ZEC 1,5/ 9-ST-7,5 C2 R1,9	1883213	50
ZEC 1,5/ 10-ST-7,5 C2 R1,10	1883226	50
ZEC 1,5/ 11-ST-7,5 C2 R1,11	1883239	50
ZEC 1,5/ 12-ST-7,5 C2 R1,12	1883242	50



Dimensional drawing

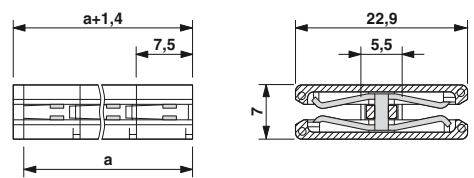

Drilling diagram

Size of the PCB: 1.6 ± 0.2 mm

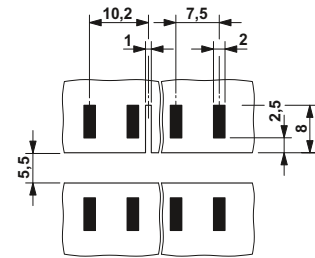

Ordering data

Type	Order No.	Pcs. / Pkt.
PCB connector, 7.5 mm pitch, color: green		
ZEC 1,5/ 2-LPV-7,5 C2	1898376	50
ZEC 1,5/ 3-LPV-7,5 C2	1898389	50
ZEC 1,5/ 4-LPV-7,5 C2	1898392	50
ZEC 1,5/ 5-LPV-7,5 C2	1898402	50
ZEC 1,5/ 6-LPV-7,5 C2	1898415	50
ZEC 1,5/ 7-LPV-7,5 C2	1898428	50
ZEC 1,5/ 8-LPV-7,5 C2	1898431	50

Classic plug-in connector with 5.0 to 7.62 mm pitch

CLASSIC COMBICON plug-in connectors for the Ex area with 5.08 and 7.62 mm pitch

Plugs with screw connection with 5.08 mm pitch

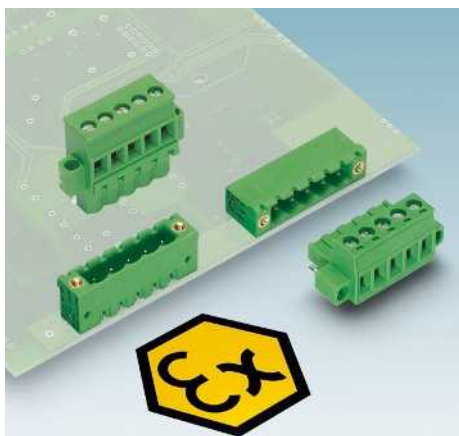



- Hazardous area approval for voltages up to 176 V
- Plug-in direction parallel and vertical to the conductor axis
- Versions with screw flange
- Can be combined with MSTB(V) 2,5/...-GF-5,08 EX
- For more application and installation instructions, please go to the hazardous area section at www.phoenixcontact.net/products and see page 40

Notes:

In accordance with DIN EN 61984, COMBICON plug-in connectors have no switching power. During designated use, they must not be plugged in or disconnected when carrying voltage or under load.

The maximum torque for the screw flange is 0.3 Nm.

Accessories

For all types	Type	Page
	Coding profile CP-MSTB Order No. 1734634	38
	Marker cards SK 5,08/3,8	798
	Screwdriver SZS 0,6 x 3,5 Order No. 1205053	

Technical data

Ex e terminal blocks as per EN/IEC 60079-0 and EN/IEC 60079-7	
Ex marking	ATEX-RL / IEC60079-0
Examination certificate	
IECEX certificate	
Rated voltage	[V]
Rated current	[A] / [2.5 mm ²]
Connection capacity	
Solid / stranded	[mm ²]
Solid / stranded	AWG
General data	
Stripping length	[mm]
Screw thread	
Tightening torque	[Nm]
Type of insulation material / insulation material group	
Inflammability class according to UL 94	
Drill hole diameter / pin dimensions	[mm]

MSTB 2,5/ ...-STF-5,08 EX

0344  II 2GD Ex e IIC Gb
KEMA 10ATEX0196 U
IECEX KEM 10.0093U
176
12
0.2 - 2.5 / 0.2 - 2.5
- / 24 - 12
7
M3
0.5 - 0.6
PA / I
V0
- / -

MVSTBR 2,5/ ...-STF-5,08 EX

0344  II 2GD Ex e IIC Gb
KEMA 10ATEX0196 U
IECEX KEM 10.0093U
176
12
0.2 - 2.5 / 0.2 - 2.5
- / 24 - 12
7
M3
0.5 - 0.6
PA / I
V0
- / -

MVSTBW 2,5/ ...-STF-5,08 EX

0344  II 2GD Ex e IIC Gb
KEMA 10ATEX0196 U
IECEX KEM 10.0093U
176
12
0.2 - 2.5 / 0.2 - 2.5
- / 24 - 12
7
M3
0.5 - 0.6
PA / I
V0
- / -

No. of pos.	Dim. a [mm]
2	5.08
3	10.16
4	15.24
5	20.32
6	25.40
7	30.48
8	35.56
9	40.64
10	45.72
11	50.80
12	55.88



With screw flange

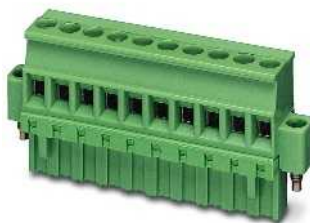

Conductor entry facing coding side, with screw flange

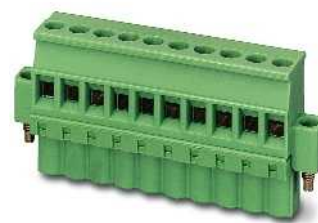

Conductor entry facing the rippled side, with screw flange

Ex:

Dimensional drawing

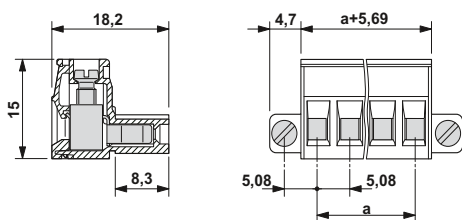

Ex:

Dimensional drawing

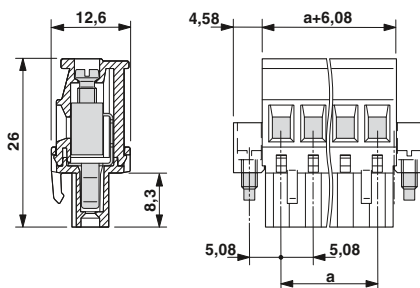

Ex:

Dimensional drawing

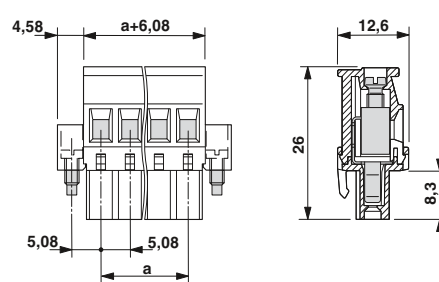

Ordering data		
Type	Order No.	Pcs. / Pkt.
5.08 mm pitch, color: green		
MSTB 2,5/ 2-STF-5,08 EX	1795556	50
MSTB 2,5/ 3-STF-5,08 EX	1795569	50
MSTB 2,5/ 4-STF-5,08 EX	1795572	50
MSTB 2,5/ 5-STF-5,08 EX	1795585	50
MSTB 2,5/ 6-STF-5,08 EX	1795598	50
MSTB 2,5/ 7-STF-5,08 EX	1795608	50
MSTB 2,5/ 8-STF-5,08 EX	1795611	50
MSTB 2,5/ 9-STF-5,08 EX	1795624	50
MSTB 2,5/10-STF-5,08 EX	1795637	50
MSTB 2,5/11-STF-5,08 EX	1795640	50
MSTB 2,5/12-STF-5,08 EX	1795653	50

Ordering data		
Type	Order No.	Pcs. / Pkt.
5.08 mm pitch, color: green		
MVSTBR 2,5/ 2-STF-5,08 EX	1809678	50
MVSTBR 2,5/ 3-STF-5,08 EX	1809681	50
MVSTBR 2,5/ 4-STF-5,08 EX	1809694	50
MVSTBR 2,5/ 5-STF-5,08 EX	1809704	50
MVSTBR 2,5/ 6-STF-5,08 EX	1809717	50
MVSTBR 2,5/ 7-STF-5,08 EX	1809720	50
MVSTBR 2,5/ 8-STF-5,08 EX	1809733	50
MVSTBR 2,5/ 9-STF-5,08 EX	1809746	50
MVSTBR 2,5/10-STF-5,08 EX	1809759	50
MVSTBR 2,5/11-STF-5,08 EX	1809762	50
MVSTBR 2,5/12-STF-5,08 EX	1809775	50

Ordering data		
Type	Order No.	Pcs. / Pkt.
5.08 mm pitch, color: green		
MVSTBW 2,5/ 2-STF-5,08 EX	1809788	50
MVSTBW 2,5/ 3-STF-5,08 EX	1809791	50
MVSTBW 2,5/ 4-STF-5,08 EX	1809801	50
MVSTBW 2,5/ 5-STF-5,08 EX	1809814	50
MVSTBW 2,5/ 6-STF-5,08 EX	1809827	50
MVSTBW 2,5/ 7-STF-5,08 EX	1809830	50
MVSTBW 2,5/ 8-STF-5,08 EX	1809843	50
MVSTBW 2,5/ 9-STF-5,08 EX	1809856	50
MVSTBW 2,5/10-STF-5,08 EX	1809869	50
MVSTBW 2,5/11-STF-5,08 EX	1809872	50
MVSTBW 2,5/12-STF-5,08 EX	1809885	50

Classic plug-in connector with 5.0 to 7.62 mm pitch

CLASSIC COMBICON plug-in connectors for the Ex area with 5.08 and 7.62 mm pitch

Plugs with push-in spring connection, 5.08 mm pitch



- Hazardous area approval for voltages up to 176 V
- Plug-in direction parallel to the conductor axis
- Versions with screw flange and self-locking flange

FKC 2,5/...-STF-5,08 EX

- Can be combined with MSTB(V) 2,5/...-GF-5,08 EX

FKC 2,5/...-ST-5,08-RF EX





- Can be combined with MSTB(V)A 2,5/...-G-5,08-RN EX
- For more application and installation instructions, please go to the hazardous area section at www.phoenixcontact.net/products and see page 40

Notes:

In accordance with DIN EN 61984, COMBICON plug-in connectors have no switching power. During designated use, they must not be plugged in or disconnected when carrying voltage or under load.

The maximum torque for the screw flange is 0.3 Nm.

Accessories

For all types	Type	Page
	Coding profile CP-MSTB Order No. 1734634	38
	Marker cards SK 5,08/3,8	798
	Strain relief STZ ...-FKC-5,08	837
	Test plug MPS	831

Technical data

Ex e terminal blocks as per EN/IEC 60079-0 and EN/IEC 60079-7	
Ex marking	ATEX-RL / IEC60079-0
Examination certificate	
IECEX certificate	
Rated voltage	[V]
Rated current	[A] / [2.5 mm ²]
Connection capacity	
Solid / stranded	[mm ²]
Solid / stranded	AWG
General data	
Stripping length	[mm]
Screw thread	
Tightening torque	[Nm]
Type of insulation material / insulation material group	
Inflammability class according to UL 94	
Drill hole diameter / pin dimensions	[mm]

FKC 2,5/ ...-STF-5,08 EX

0344  II 2GD Ex e IIC Gb
KEMA 10ATEX0196 U
IECEX KEM 10.0093U
176
12
0.2 - 2.5 / 0.2 - 2.5
- / 24 - 12
10
-
-
PA / I
V0
- / -

FKC 2,5/ ...-ST-5,08-RF EX

0344  II 2GD Ex e IIC Gb
KEMA 10ATEX0196 U
IECEX KEM 10.0093U
176
12
0.2 - 2.5 / 0.2 - 2.5
- / 24 - 12
10
-
-
PA / I
V0
- / -

No. of pos.	Dim. a [mm]
2	5.08
3	10.16
4	15.24
5	20.32
6	25.40
7	30.48
8	35.56
9	40.64
10	45.72
11	50.80
12	55.88



With screw flange

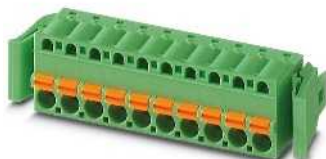

With self-locking flange

Ex:

Dimensional drawing

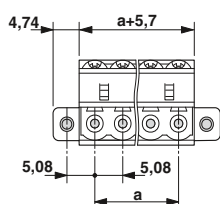
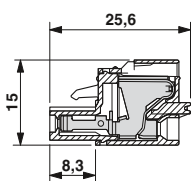

Ex:

Dimensional drawing

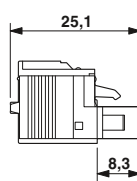
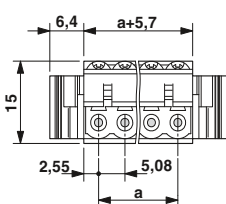

Ordering data		
Type	Order No.	Pcs. / Pkt.
5.08 mm pitch, color: green		
FKC 2,5/ 2-STF-5,08 EX	1795996	50
FKC 2,5/ 3-STF-5,08 EX	1796005	50
FKC 2,5/ 4-STF-5,08 EX	1796018	50
FKC 2,5/ 5-STF-5,08 EX	1796021	50
FKC 2,5/ 6-STF-5,08 EX	1796034	50
FKC 2,5/ 7-STF-5,08 EX	1796047	50
FKC 2,5/ 8-STF-5,08 EX	1796050	50
FKC 2,5/ 9-STF-5,08 EX	1796063	50
FKC 2,5/10-STF-5,08 EX	1796076	50
FKC 2,5/11-STF-5,08 EX	1796089	50
FKC 2,5/12-STF-5,08 EX	1796092	50

Ordering data		
Type	Order No.	Pcs. / Pkt.
5.08 mm pitch, color: green		
FKC 2,5/ 2-ST-5,08-RF EX	1796102	50
FKC 2,5/ 3-ST-5,08-RF EX	1796115	50
FKC 2,5/ 4-ST-5,08-RF EX	1796128	50
FKC 2,5/ 5-ST-5,08-RF EX	1796131	50
FKC 2,5/ 6-ST-5,08-RF EX	1796144	50
FKC 2,5/ 7-ST-5,08-RF EX	1796157	50
FKC 2,5/ 8-ST-5,08-RF EX	1796160	50
FKC 2,5/ 9-ST-5,08-RF EX	1796173	50
FKC 2,5/10-ST-5,08-RF EX	1796186	50
FKC 2,5/11-ST-5,08-RF EX	1796199	50
FKC 2,5/12-ST-5,08-RF EX	1796209	50

Classic plug-in connector with 5.0 to 7.62 mm pitch

CLASSIC COMBICON plug-in connectors for the Ex area with 5.08 and 7.62 mm pitch

Inverted plugs for the Ex area with 5.08 mm pitch

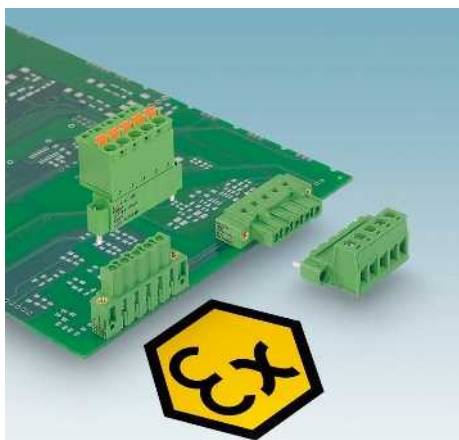

- Hazardous area approval for voltages up to 176 V
- Plug-in direction parallel to the conductor axis
- Can be combined with IC(V) 2,5/...-GF-5,08 EX
- For more application and installation instructions, please go to the hazardous area section at www.phoenixcontact.net/products and see page 40

Notes:

In accordance with DIN EN 61984, COMBICON plug-in connectors have no switching power. During designated use, they must not be plugged in or disconnected when carrying voltage or under load.

The maximum torque for the screw flange is 0.3 Nm.

Accessories

For all types	Type	Page
	Coding profile CP-MSTB Order No. 1734634	38
	Marker cards SK 5,08/3,8	798
Only for IC 2,5/...-STF-5,08 EX		
	Screwdriver SZS 0,6 x 3,5 Order No. 1205053	
Only for FKIC 2,5/...-STF-5,08 EX		
	Strain relief STZ ...-FKC-5,08	837
	Test plug MPS	831

Technical data

Ex e terminal blocks as per EN/IEC 60079-0 and EN/IEC 60079-7	
Ex marking	ATEX-RL / IEC60079-0
Examination certificate	
IECEX certificate	
Rated voltage	[V]
Rated current	[A] / [2.5 mm²]
Connection capacity	
Solid / stranded	[mm²]
Solid / stranded	AWG
General data	
Stripping length	[mm]
Screw thread	
Tightening torque	[Nm]
Type of insulation material / insulation material group	
Inflammability class according to UL 94	
Drill hole diameter / pin dimensions	[mm]

IC 2,5/ ...-STF-5,08 EX

0344  II 2GD Ex e IIC Gb
KEMA 10ATEX0196 U
IECEX KEM 10.0093U
176
12
0.2 - 2.5 / 0.2 - 2.5
- / 24 - 12
7
M3
0.5 - 0.6
PA / I
V0
- / -

FKIC 2,5/ ...-STF-5,08 EX

0344  II 2GD Ex e IIC Gb
KEMA 10ATEX0196 U
IECEX KEM 10.0093U
176
12
0.2 - 2.5 / 0.2 - 2.5
- / 24 - 12
10
-
-
PA / I
V0
- / -

No. of pos.	Dim. a [mm]
2	5.08
3	10.16
4	15.24
5	20.32
6	25.40
7	30.48
8	35.56
9	40.64
10	45.72
11	50.80
12	55.88



With screw connection and screw flange



With push-in spring connection and screw flange

Ex:

Dimensional drawing

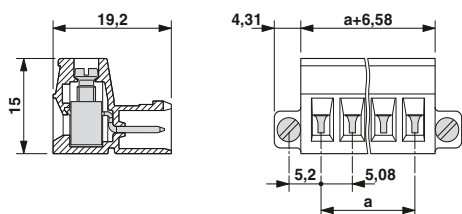

Ex:

Dimensional drawing

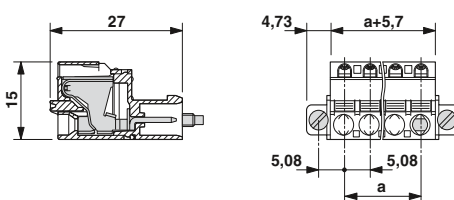

Ordering data		
Type	Order No.	Pcs. / Pkt.
5.08 mm pitch, color: green		
IC 2,5/ 2-STF-5,08 EX	1810117	50
IC 2,5/ 3-STF-5,08 EX	1810120	50
IC 2,5/ 4-STF-5,08 EX	1810133	50
IC 2,5/ 5-STF-5,08 EX	1810146	50
IC 2,5/ 6-STF-5,08 EX	1810159	50
IC 2,5/ 7-STF-5,08 EX	1810162	50
IC 2,5/ 8-STF-5,08 EX	1810175	50
IC 2,5/ 9-STF-5,08 EX	1810188	50
IC 2,5/10-STF-5,08 EX	1810191	50
IC 2,5/11-STF-5,08 EX	1810201	50
IC 2,5/12-STF-5,08 EX	1810214	50

Ordering data		
Type	Order No.	Pcs. / Pkt.
5.08 mm pitch, color: green		
FKIC 2,5/ 2-STF-5,08 EX	1810227	50
FKIC 2,5/ 3-STF-5,08 EX	1810230	50
FKIC 2,5/ 4-STF-5,08 EX	1810243	50
FKIC 2,5/ 5-STF-5,08 EX	1810256	50
FKIC 2,5/ 6-STF-5,08 EX	1810269	50
FKIC 2,5/ 7-STF-5,08 EX	1810272	50
FKIC 2,5/ 8-STF-5,08 EX	1810285	50
FKIC 2,5/ 9-STF-5,08 EX	1810298	50
FKIC 2,5/10-STF-5,08 EX	1810308	50
FKIC 2,5/11-STF-5,08 EX	1810311	50
FKIC 2,5/12-STF-5,08 EX	1810324	50

Classic plug-in connector with 5.0 to 7.62 mm pitch

CLASSIC COMBICON plug-in connectors for the Ex area with 5.08 and 7.62 mm pitch

A header with a 5.08 mm pitch for wave soldering processes

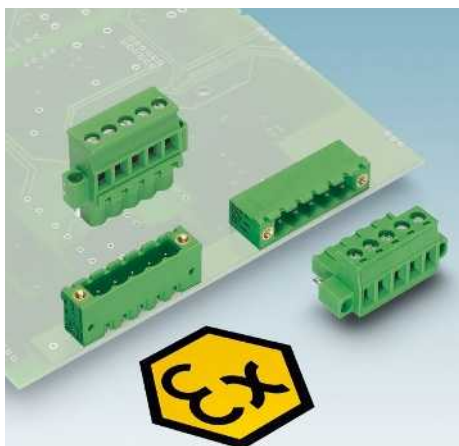

- Hazardous area approval for voltages up to 176 V
- Versions with threaded flange and engagement nose
- For more application and installation instructions, please go to the hazardous area section at www.phoenixcontact.net/products and see page 40

Notes:

In accordance with DIN EN 61984, COMBICON plug-in connectors have no switching power. During designated use, they must not be plugged in or disconnected when carrying voltage or under load.

Mounting screws for base element with threaded flange (...GF...): sheet metal screw ISO 1481-ST 2,2x6,5 C or ISO 7049-ST 2,2x6,5 C. Screw connection only permitted prior to soldering.



With threaded flange, plug-in direction parallel to the PCB

Ex:

Accessories

For all types	Type	Page
	Coding section CR-MSTB Order No. 1734401	38
	Marker cards SK 5,08/3,8	798

Dimensional drawing

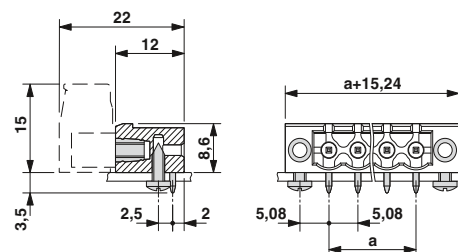

Drilling diagram

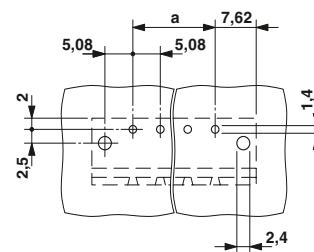

Technical data

Ex e terminal blocks as per EN/IEC 60079-0 and EN/IEC 60079-7	
Ex marking	ATEX-RL / IEC60079-0
Examination certificate	0344 II 2GD Ex e IIC Gb
IECEX certificate	KEMA 10ATEX0196 U
Rated voltage	176 [V]
Rated current	12 [A] / [2.5 mm ²]
Connection capacity	
Solid / stranded	[mm ²]
Solid / stranded	AWG
General data	
Stripping length	[mm]
Screw thread	-
Tightening torque	[Nm]
Type of insulation material / insulation material group	PA / I
Inflammability class according to UL 94	V0
Drill hole diameter / pin dimensions	[mm]

	0344 II 2GD Ex e IIC Gb
	KEMA 10ATEX0196 U
	IECEX KEM 10.0093U
	- / -
	- / -
	-
	-
	-
	PA / I
	V0
	1.4 / 1 x 1 mm

No. of pos.	Dim. a [mm]
2	5.08
3	10.16
4	15.24
5	20.32
6	25.40
7	30.48
8	35.56
9	40.64
10	45.72
11	50.80
12	55.88

Ordering data

Type	Order No.	Pcs. / Pkt.
5.08 mm pitch, color: green		
MSTB 2,5/ 2-GF-5,08 EX	1795666	50
MSTB 2,5/ 3-GF-5,08 EX	1795679	50
MSTB 2,5/ 4-GF-5,08 EX	1795682	50
MSTB 2,5/ 5-GF-5,08 EX	1795695	50
MSTB 2,5/ 6-GF-5,08 EX	1795705	50
MSTB 2,5/ 7-GF-5,08 EX	1795718	50
MSTB 2,5/ 8-GF-5,08 EX	1795721	50
MSTB 2,5/ 9-GF-5,08 EX	1795734	50
MSTB 2,5/10-GF-5,08 EX	1795747	50
MSTB 2,5/11-GF-5,08 EX	1795750	50
MSTB 2,5/12-GF-5,08 EX	1795763	50



With engagement noses, plug-in direction parallel to the PCB

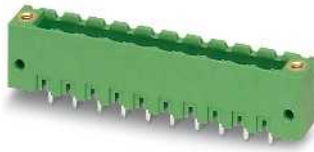

With threaded flange, plug-in direction vertical to the PCB

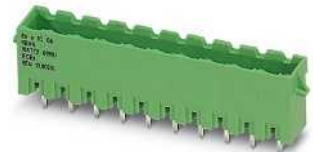

With engagement noses, plug-in direction vertical to the PCB

Ex:

Dimensional drawing

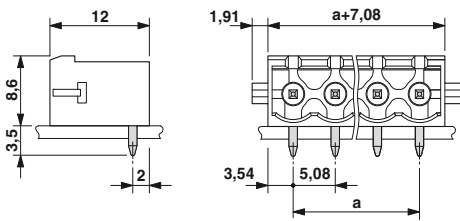

Drilling diagram

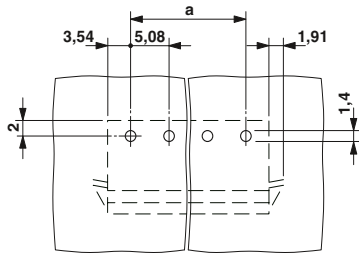

Ordering data

Type	Order No.	Pcs. / Pkt.
5.08 mm pitch, color: green		
MSTBA 2,5/ 2-G-5,08-RN EX	1796432	50
MSTBA 2,5/ 3-G-5,08-RN EX	1796445	50
MSTBA 2,5/ 4-G-5,08-RN EX	1796458	50
MSTBA 2,5/ 5-G-5,08-RN EX	1796461	50
MSTBA 2,5/ 6-G-5,08-RN EX	1796474	50
MSTBA 2,5/ 7-G-5,08-RN EX	1796487	50
MSTBA 2,5/ 8-G-5,08-RN EX	1796490	50
MSTBA 2,5/ 9-G-5,08-RN EX	1796500	50
MSTBA 2,5/10-G-5,08-RN EX	1796513	50
MSTBA 2,5/11-G-5,08-RN EX	1796526	50
MSTBA 2,5/12-G-5,08-RN EX	1796539	50

Ex:

Dimensional drawing

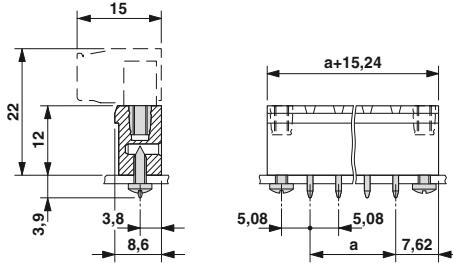

Drilling diagram

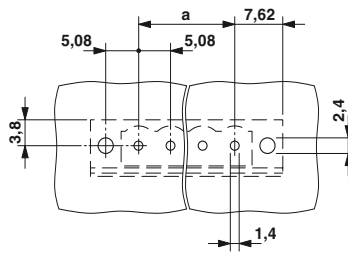

Ordering data

Type	Order No.	Pcs. / Pkt.
5.08 mm pitch, color: green		
MSTBV 2,5/ 2-GF-5,08 EX	1796322	50
MSTBV 2,5/ 3-GF-5,08 EX	1796335	50
MSTBV 2,5/ 4-GF-5,08 EX	1796348	50
MSTBV 2,5/ 5-GF-5,08 EX	1796351	50
MSTBV 2,5/ 6-GF-5,08 EX	1796364	50
MSTBV 2,5/ 7-GF-5,08 EX	1796377	50
MSTBV 2,5/ 8-GF-5,08 EX	1796380	50
MSTBV 2,5/ 9-GF-5,08 EX	1796393	50
MSTBV 2,5/10-GF-5,08 EX	1796403	50
MSTBV 2,5/11-GF-5,08 EX	1796416	50
MSTBV 2,5/12-GF-5,08 EX	1796429	50

Ex:

Dimensional drawing

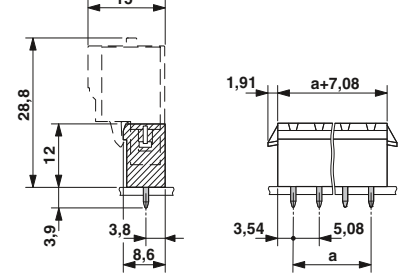

Drilling diagram

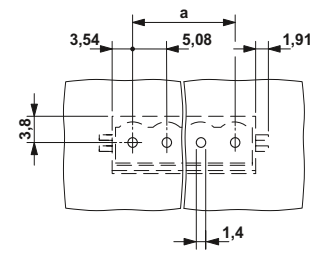

Ordering data

Type	Order No.	Pcs. / Pkt.
5.08 mm pitch, color: green		
MSTBVA 2,5/ 2-G-5,08-RN EX	1796555	50
MSTBVA 2,5/ 3-G-5,08-RN EX	1796568	50
MSTBVA 2,5/ 4-G-5,08-RN EX	1796571	50
MSTBVA 2,5/ 5-G-5,08-RN EX	1796584	50
MSTBVA 2,5/ 6-G-5,08-RN EX	1796597	50
MSTBVA 2,5/ 7-G-5,08-RN EX	1796607	50
MSTBVA 2,5/ 8-G-5,08-RN EX	1796610	50
MSTBVA 2,5/ 9-G-5,08-RN EX	1796623	50
MSTBVA 2,5/10-G-5,08-RN EX	1796636	50
MSTBVA 2,5/11-G-5,08-RN EX	1796649	50
MSTBVA 2,5/12-G-5,08-RN EX	1796652	50

Classic plug-in connector with 5.0 to 7.62 mm pitch

CLASSIC COMBICON plug-in connectors for the Ex area with 5.08 and 7.62 mm pitch

Inverted headers for wave soldering processes with 5.08 mm pitch

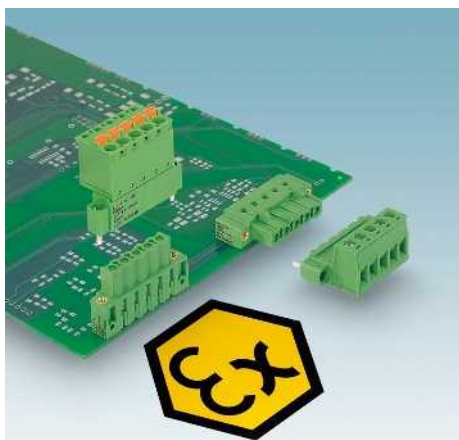





- Hazardous area approval for voltages up to 176 V
- Headers for wave soldering processes
- For more application and installation instructions, please go to the hazardous area section at www.phoenixcontact.net/products and see page 40

Notes:

In accordance with DIN EN 61984, COMBICON plug-in connectors have no switching power. During designated use, they must not be plugged in or disconnected when carrying voltage or under load.

Mounting screws for base element with threaded flange (...GF...): sheet metal screw ISO 1481-ST 2,2x6,5 C or ISO 7049-ST 2,2x6,5 C. Screw connection only permitted prior to soldering.

Accessories

For all types	Type	Page
	Coding profile CP-MSTB Order No. 1734634	38
	Marker cards SK 5,08/3,8	798
	Reducing plug RPS Order No. 0201647	831
	Test plug MPS	831

Technical data

Ex e terminal blocks as per EN/IEC 60079-0 and EN/IEC 60079-7	
Ex marking	ATEX-RL / IEC60079-0
Examination certificate	
IECEX certificate	
Rated voltage	[V] 176
Rated current	[A] / [2.5 mm ²] 12
Connection capacity	
Solid / stranded	[mm ²] - / -
Solid / stranded	AWG - / -
General data	
Stripping length	[mm] -
Screw thread	-
Tightening torque	[Nm] -
Type of insulation material / insulation material group	PA / I
Inflammability class according to UL 94	V0
Drill hole diameter / pin dimensions	[mm] 1.4 / 1.2 x 0.5

IC 2,5/ ...-GF-5,08 EX

0344  II 2GD Ex e IIC Gb
KEMA 10ATEX0196 U
IECEX KEM 10.0093U
176
12
- / -
- / -
-
-
-
PA / I
V0
1.4 / 1.2 x 0.5

ICV 2,5/ ...-GF-5,08 EX

0344  II 2GD Ex e IIC Gb
KEMA 10ATEX0196 U
IECEX KEM 10.0093U
176
12
- / -
- / -
-
-
-
PA / I
V0
1.4 / 1.2 x 0.5

No. of pos.	Dim. a [mm]
2	5.08
3	10.16
4	15.24
5	20.32
6	25.40
7	30.48
8	35.56
9	40.64
10	45.72
11	50.80
12	55.88



With threaded flange,
plug-in direction parallel to the PCB



With threaded flange,
plug-in direction vertical to the PCB

Ex:

Dimensional drawing

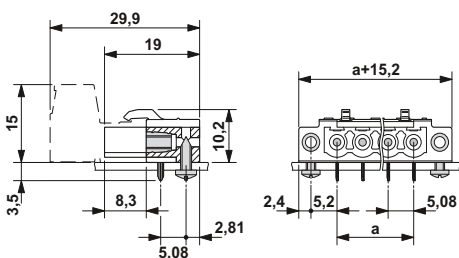

Drilling diagram

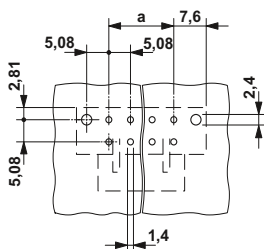

Ex:

Dimensional drawing

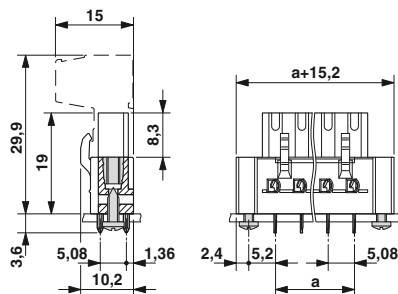

Drilling diagram

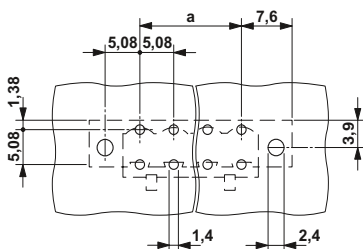

Ordering data

Type	Order No.	Pcs. / Pkt.
5.08 mm pitch, color: green		
IC 2,5/ 2-GF-5,08 EX	1810337	50
IC 2,5/ 3-GF-5,08 EX	1810340	50
IC 2,5/ 4-GF-5,08 EX	1810353	50
IC 2,5/ 5-GF-5,08 EX	1810366	50
IC 2,5/ 6-GF-5,08 EX	1810379	50
IC 2,5/ 7-GF-5,08 EX	1810382	50
IC 2,5/ 8-GF-5,08 EX	1810395	50
IC 2,5/ 9-GF-5,08 EX	1810405	50
IC 2,5/10-GF-5,08 EX	1810418	50
IC 2,5/11-GF-5,08 EX	1810421	50
IC 2,5/12-GF-5,08 EX	1810434	50

Ordering data

Type	Order No.	Pcs. / Pkt.
5.08 mm pitch, color: green		
ICV 2,5/ 2-GF-5,08 EX	1810447	50
ICV 2,5/ 3-GF-5,08 EX	1810450	50
ICV 2,5/ 4-GF-5,08 EX	1810463	50
ICV 2,5/ 5-GF-5,08 EX	1810476	50
ICV 2,5/ 6-GF-5,08 EX	1810489	50
ICV 2,5/ 7-GF-5,08 EX	1810492	50
ICV 2,5/ 8-GF-5,08 EX	1810502	50
ICV 2,5/ 9-GF-5,08 EX	1810515	50
ICV 2,5/10-GF-5,08 EX	1810528	50
ICV 2,5/11-GF-5,08 EX	1810531	50
ICV 2,5/12-GF-5,08 EX	1810544	50

Classic plug-in connector with 5.0 to 7.62 mm pitch

CLASSIC COMBICON plug-in connectors for the Ex area with 5.08 and 7.62 mm pitch

Plugs with screw connection with 7.62 mm pitch

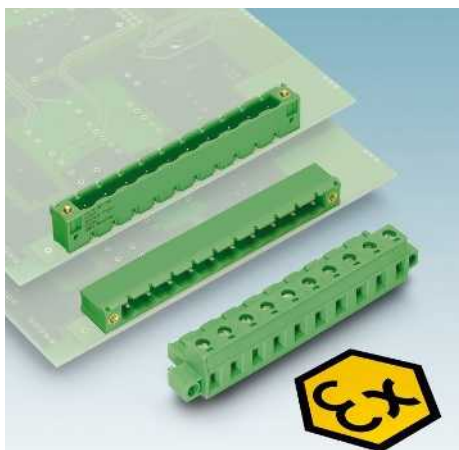



- Ex approval for voltages up to 352 V
- Plug-in direction parallel to the conductor axis
- Can be combined with GMSTB(V) 2,5/...-GF-5,08 EX
- For more application and installation instructions, please go to the hazardous area section at www.phoenixcontact.net/products and see page 40

Notes:

In accordance with DIN EN 61984, COMBICON plug-in connectors have no switching power. During designated use, they must not be plugged in or disconnected when carrying voltage or under load.

The maximum torque for the screw flange is 0.3 Nm.

Accessories

For all types	Type	Page
	Coding profile CP-MSTB Order No. 1734634	38
	Marker cards SK 7,62/5	800
	Screwdriver SZS 0,6 x 3,5 Order No. 1205053	

Technical data

Ex e terminal blocks as per EN/IEC 60079-0 and EN/IEC 60079-7	
Ex marking	ATEX-RL / IEC60079-0
Examination certificate	
IECEX certificate	
Rated voltage	[V]
Rated current	[A] / [2.5 mm ²]
Connection capacity	
Solid / stranded	[mm ²]
Solid / stranded	AWG
General data	
Stripping length	[mm]
Screw thread	
Tightening torque	[Nm]
Type of insulation material / insulation material group	
Inflammability class according to UL 94	
Drill hole diameter / pin dimensions	[mm]

GMSTB 2,5/ ...-STF-7,62 EX

0344  II 2GD Ex e IIC Gb
KEMA 10ATEX0196 U
IECEX KEM 10.0093U
352
12
0.2 - 2.5 / 0.2 - 2.5
- / 24 - 12
7
M3
0.5 - 0.6
PA / I
V0
- / -

GMVSTBR 2,5/ ...-STF-7,62 EX

0344  II 2GD Ex e IIC Gb
KEMA 10ATEX0196 U
IECEX KEM 10.0093U
352
12
0.2 - 2.5 / 0.2 - 2.5
- / 24 - 12
7
M3
0.5 - 0.6
PA / I
V0
- / -

GMVSTBW 2,5/ ...-STF-7,62 EX

0344  II 2GD Ex e IIC Gb
KEMA 10ATEX0196 U
IECEX KEM 10.0093U
352
12
0.2 - 2.5 / 0.2 - 2.5
- / 24 - 12
7
M3
0.5 - 0.6
PA / I
V0
- / -

No. of pos.	Dim. a [mm]
2	7.62
3	15.24
4	22.86
5	30.48
6	38.10
7	45.72
8	53.34
9	60.96
10	68.58
11	76.20
12	83.82



With screw flange



Conductor entry facing coding side, with screw flange



Conductor entry facing the rippled side, with screw flange

Ex:

Dimensional drawing

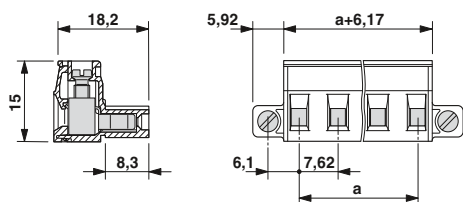

Ex:

Dimensional drawing

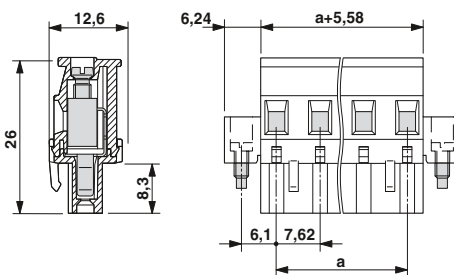

Ex:

Dimensional drawing

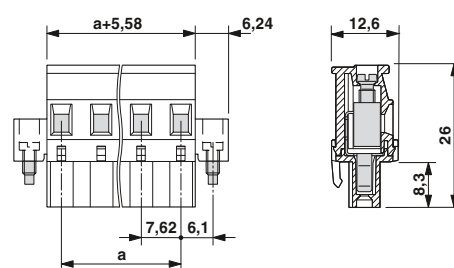

Ordering data		
Type	Order No.	Pcs. / Pkt.
Pitch 7.62 mm, color: green		
GMSTB 2,5/ 2-STF-7,62 EX	1795776	50
GMSTB 2,5/ 3-STF-7,62 EX	1795789	50
GMSTB 2,5/ 4-STF-7,62 EX	1795792	50
GMSTB 2,5/ 5-STF-7,62 EX	1795802	50
GMSTB 2,5/ 6-STF-7,62 EX	1795815	50
GMSTB 2,5/ 7-STF-7,62 EX	1795828	50
GMSTB 2,5/ 8-STF-7,62 EX	1795831	50
GMSTB 2,5/ 9-STF-7,62 EX	1795844	50
GMSTB 2,5/10-STF-7,62 EX	1795857	50
GMSTB 2,5/11-STF-7,62 EX	1795860	50
GMSTB 2,5/12-STF-7,62 EX	1795873	50

Ordering data		
Type	Order No.	Pcs. / Pkt.
Pitch 7.62 mm, color: green		
GMVSTBR 2,5/ 2-STF-7,62 EX	1809898	50
GMVSTBR 2,5/ 3-STF-7,62 EX	1809908	50
GMVSTBR 2,5/ 4-STF-7,62 EX	1809911	50
GMVSTBR 2,5/ 5-STF-7,62 EX	1809924	50
GMVSTBR 2,5/ 6-STF-7,62 EX	1809937	50
GMVSTBR 2,5/ 7-STF-7,62 EX	1809940	50
GMVSTBR 2,5/ 8-STF-7,62 EX	1809953	50
GMVSTBR 2,5/ 9-STF-7,62 EX	1809966	50
GMVSTBR 2,5/10-STF-7,62 EX	1809979	50
GMVSTBR 2,5/11-STF-7,62 EX	1809982	50
GMVSTBR 2,5/12-STF-7,62 EX	1809995	50

Ordering data		
Type	Order No.	Pcs. / Pkt.
Pitch 7.62 mm, color: green		
GMVSTBW 2,5/ 2-STF-7,62 EX	1810007	50
GMVSTBW 2,5/ 3-STF-7,62 EX	1810010	50
GMVSTBW 2,5/ 4-STF-7,62 EX	1810023	50
GMVSTBW 2,5/ 5-STF-7,62 EX	1810036	50
GMVSTBW 2,5/ 6-STF-7,62 EX	1810049	50
GMVSTBW 2,5/ 7-STF-7,62 EX	1810052	50
GMVSTBW 2,5/ 8-STF-7,62 EX	1810065	50
GMVSTBW 2,5/ 9-STF-7,62 EX	1810078	50
GMVSTBW 2,5/10-STF-7,62 EX	1810081	50
GMVSTBW 2,5/11-STF-7,62 EX	1810094	50
GMVSTBW 2,5/12-STF-7,62 EX	1810104	50

Classic plug-in connector with 5.0 to 7.62 mm pitch

CLASSIC COMBICON plug-in connectors for the Ex area with 5.08 and 7.62 mm pitch

Plugs with push-in spring connection, 7.62 mm pitch

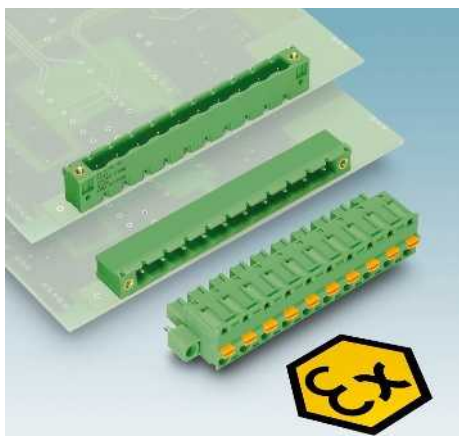



- Ex approval for voltages up to 352 V
- Plug-in direction parallel to the conductor axis
- Can be combined with GMSTB(V) 2,5/...-GF-5,08 EX
- Further application and installation instructions for plug-in connectors for the Ex area can be found online at www.phoenixcontact.net/products and on page 40

Notes:

In accordance with DIN EN 61984, COMBICON plug-in connectors have no switching power. During designated use, they must not be plugged in or disconnected when carrying voltage or under load.

The maximum torque for the screw flange is 0.3 Nm.

Accessories

For all types	Type	Page
	Coding profile CP-MSTB Order No. 1734634	38
	Marker cards SK 7,62/5	800
	Test plug MPS	831

Technical data

Ex e terminal blocks as per EN/IEC 60079-0 and EN/IEC 60079-7	
Ex marking	ATEX-RL / IEC60079-0
Examination certificate	
IECEX certificate	
Rated voltage	[V] 352
Rated current	[A] / [2.5 mm ²] 12
Connection capacity	
Solid / stranded	[mm ²] 0.2 - 2.5 / 0.2 - 2.5
Solid / stranded	AWG - / 24 - 12
General data	
Stripping length	[mm] 10
Screw thread	-
Tightening torque	[Nm] -
Type of insulation material / insulation material group	PA / I
Inflammability class according to UL 94	V0
Drill hole diameter / pin dimensions	[mm] - / -

0344  II 2GD Ex e IIC Gb
KEMA 10ATEX0196 U
IECEX KEM 10.0093U

No. of pos.	Dim. a [mm]
2	7.62
3	15.24
4	22.86
5	30.48
6	38.10
7	45.72
8	53.34
9	60.96
10	68.58
11	76.20
12	83.82



With screw flange

Ex:  

Dimensional drawing

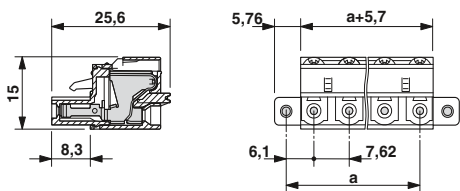

Ordering data

Type	Order No.	Pcs. / Pkt.
Pitch 7.62 mm, color: green		
GFKC 2,5/ 2-STF-7,62 EX	1796212	50
GFKC 2,5/ 3-STF-7,62 EX	1796225	50
GFKC 2,5/ 4-STF-7,62 EX	1796238	50
GFKC 2,5/ 5-STF-7,62 EX	1796241	50
GFKC 2,5/ 6-STF-7,62 EX	1796254	50
GFKC 2,5/ 7-STF-7,62 EX	1796267	50
GFKC 2,5/ 8-STF-7,62 EX	1796270	50
GFKC 2,5/ 9-STF-7,62 EX	1796283	50
GFKC 2,5/10-STF-7,62 EX	1796296	50
GFKC 2,5/11-STF-7,62 EX	1796306	50
GFKC 2,5/12-STF-7,62 EX	1796319	50

Classic plug-in connector with 5.0 to 7.62 mm pitch

CLASSIC COMBICON plug-in connectors for the Ex area with 5.08 and 7.62 mm pitch

Headers with a 7.62 mm pitch for wave soldering processes

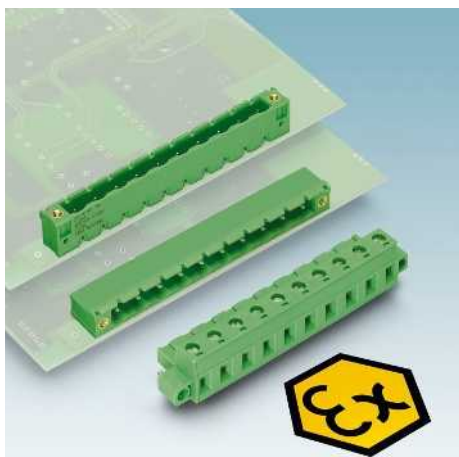



- Ex approval for voltages up to 352 V
- For more application and installation instructions, please go to the hazardous area section at www.phoenixcontact.net/products and see page 40

Notes:

In accordance with DIN EN 61984, COMBICON plug-in connectors have no switching power. During designated use, they must not be plugged in or disconnected when carrying voltage or under load.

Mounting screws for base element with threaded flange (...GF...): sheet metal screw ISO 1481-ST 2,2x6,5 C or ISO 7049-ST 2,2x6,5 C. Screw connection only permitted prior to soldering.

Accessories

For all types	Type	Page
	Coding section CR-MSTB Order No. 1734401	38
	Marker cards SK 7,62/5	800

Technical data

Ex e terminal blocks as per EN/IEC 60079-0 and EN/IEC 60079-7	
Ex marking	ATEX-RL / IEC60079-0
Examination certificate	
IECEX certificate	
Rated voltage	[V]
Rated current	[A] / [2.5 mm ²]
Connection capacity	
Solid / stranded	[mm ²]
Solid / stranded	AWG
General data	
Stripping length	[mm]
Screw thread	
Tightening torque	[Nm]
Type of insulation material / insulation material group	
Inflammability class according to UL 94	
Drill hole diameter / pin dimensions	[mm]

GMSTB 2,5/ ...-GF-7,62 EX

0344  II 2GD Ex e IIC Gb
KEMA 10ATEX0196 U
IECEX KEM 10.0093U
352
12
- / -
- / -
-
-
-
PA / I
V0
1.4 / 1 x 1 mm

GMSTBV 2,5/ ...-GF-7,62 EX

0344  II 2GD Ex e IIC Gb
KEMA 10ATEX0196 U
IECEX KEM 10.0093U
352
12
- / -
- / -
-
-
-
PA / I
V0
1.4 / 1 x 1 mm

No. of pos.	Dim. a [mm]
2	7.62
3	15.24
4	22.86
5	30.48
6	38.10
7	45.72
8	53.34
9	60.96
10	68.58
11	76.20
12	83.82



With threaded flange,
plug-in direction parallel to the PCB

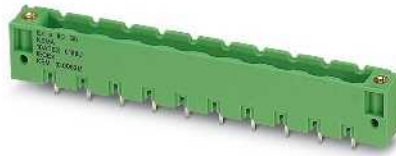

With threaded flange,
plug-in direction vertical to the PCB

Ex:

Dimensional drawing

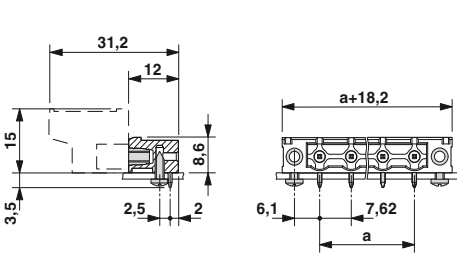

Drilling diagram

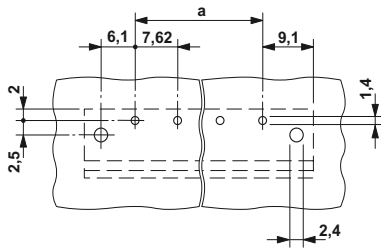

Ex:

Dimensional drawing

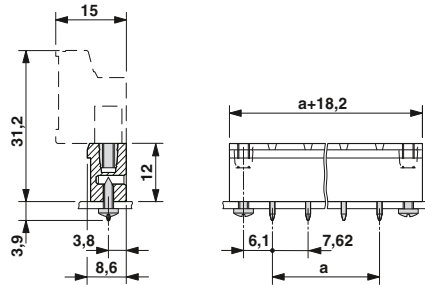

Drilling diagram

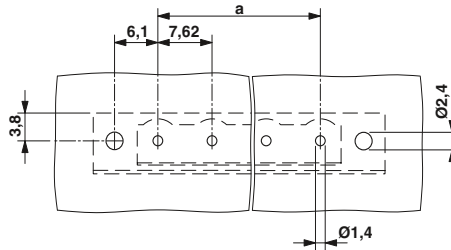

Ordering data

Type	Order No.	Pcs. / Pkt.
Pitch 7.62 mm, color: green		
GMSTB 2,5/ 2-GF-7,62 EX	1795886	50
GMSTB 2,5/ 3-GF-7,62 EX	1795899	50
GMSTB 2,5/ 4-GF-7,62 EX	1795909	50
GMSTB 2,5/ 5-GF-7,62 EX	1795912	50
GMSTB 2,5/ 6-GF-7,62 EX	1795925	50
GMSTB 2,5/ 7-GF-7,62 EX	1795938	50
GMSTB 2,5/ 8-GF-7,62 EX	1795941	50
GMSTB 2,5/ 9-GF-7,62 EX	1795954	50
GMSTB 2,5/10-GF-7,62 EX	1795967	50
GMSTB 2,5/11-GF-7,62 EX	1795970	50
GMSTB 2,5/12-GF-7,62 EX	1795983	50

Ordering data

Type	Order No.	Pcs. / Pkt.
Pitch 7.62 mm, color: green		
GMSTBV 2,5/ 2-GF-7,62 EX	1796665	50
GMSTBV 2,5/ 3-GF-7,62 EX	1796678	50
GMSTBV 2,5/ 4-GF-7,62 EX	1796681	50
GMSTBV 2,5/ 5-GF-7,62 EX	1796694	50
GMSTBV 2,5/ 6-GF-7,62 EX	1796704	50
GMSTBV 2,5/ 7-GF-7,62 EX	1796717	50
GMSTBV 2,5/ 8-GF-7,62 EX	1796720	50
GMSTBV 2,5/ 9-GF-7,62 EX	1796733	50
GMSTBV 2,5/10-GF-7,62 EX	1796746	50
GMSTBV 2,5/11-GF-7,62 EX	1796759	50
GMSTBV 2,5/12-GF-7,62 EX	1796762	50

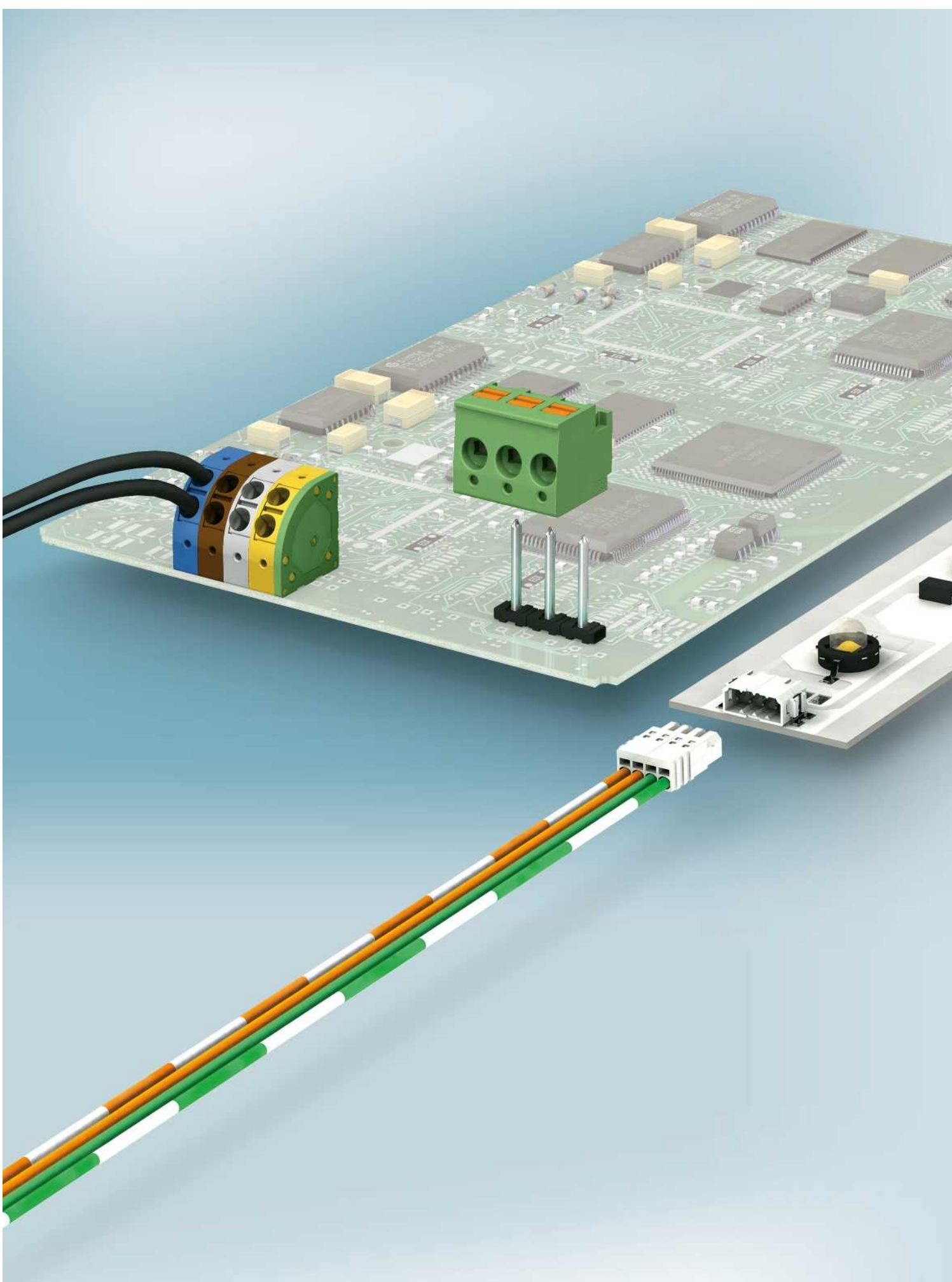

Connection technology for building and LED applications

Small, powerful and in the typical green

The COMBICON compact series consists of solutions featuring spring-cage and screw connection technology for virtually all applications in building technology and LED technology.

All of the products in the COMBICON compact series are:

- Space-saving, thanks to their compact dimensions
- Versatile with regard to the connection technology
- Functional with regard to design and choice of material

COMBICON compact with screw connection

With the PT range, Phoenix Contact provides a new series of terminal blocks with screw connection and, compared with others in its class, outstanding clamping space. A CLIP version is available for clam-shell electronics housings, which can be directly latched to the housing. The various PCB terminal blocks and connectors that can be coded are very versatile and particularly suitable for large-scale serial products and price-critical applications.

COMBICON compact with spring-cage connection

The proven and easy-to-operate spring-cage double connection is available with 3.5 and 5.0 mm pitch. While the FK-MPT series has extremely compact dimensions, the new PTDA series combines high terminal block capacity with an attractive design.

The PTS series is new. These spring-cage PCB terminal blocks and plug-in connectors offer conductor connection featuring direct plug-in technology with a release button. This means that stranded conductors can also be easily connected.

The small pitch of the PTSM series is suitable for applications where space really is at a premium, such as those found in LED lighting technology, for example. The white housing makes this miniature terminal block the ideal match for the light-colored PCBs of LED lights.

COMBICON compact pin strips

The matching pin strips for plug-in versions are made from high-temperature-resistant material and can therefore be used in the reflow soldering process (THR). A taped version for use on automatic machines is available on request.

General	386
COMBICON compact cross-reference list	388
PCB terminal blocks and plugs with 2.5 mm pitch	391
THR spring-cage PCB terminal blocks up to 0.75 mm ²	391
SMD spring-cage PCB terminal blocks up to 0.75 mm ²	393
Plugs with pierce contact up to 0.34 mm ² and spring-cage connection up to 0.75 mm ²	395
SMT and THR base strips for plugs with pierce contact or spring-cage connection	397
Inverted SMD and THR base strips	399
PTF series	
Connection terminal block for flexible PCBs	401
FK-MPT series	
PCB terminal blocks with spring-cage double connection up to 2 x 0.5 mm ²	403
PTDA series	
Angled PCB terminal blocks with spring-cage double connection up to 2 x 2.5 mm ²	407
PTSA series	
Angled spring-cage PCB terminal blocks up to 1.5 mm ²	411
PTS series	
Horizontal PCB terminal block for conductor cross sections up to 2.5 mm ²	415
Plug with spring connection for pin strips	417
PT 1,5 series	
PCB terminal blocks with screw connection up to 2.5 mm ²	419
PT 2,5 series	
PCB terminal blocks with screw connection up to 4 mm ²	431
PT 2,5 plug-in system	
Multi-plug-in system with screw connection up to 4 mm ²	431
PST series	
Pin strips for COMBICON compact plugs	432
FOPT series	
FO fast connection PCB terminal blocks FOPT 2,2-T/R	436

PCB terminal blocks

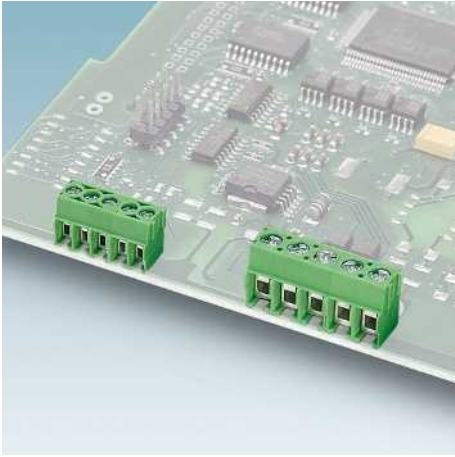

PT 1,5 PCB terminal blocks

- Screw connection
- High terminal capacity
- High current carrying capacity
- Plus/minus screw as standard
- Highly flexible wire protector



PTS 1,5 PCB terminal blocks

- Push-in spring connection
- Finger-operated release button
- Compact design
- Test connection



PTDA PCB terminal blocks

- Spring-cage double connection
- Direct plug-in method
- Compact dimensions
- Test connection

Plug-in connectors for pin strips



PT 1,5 plug-in connectors

- Screw connection with tension sleeve
- For latching in device housing
- Snap-on feet for reliable hold
- Ideal for clam-shell electronics housing

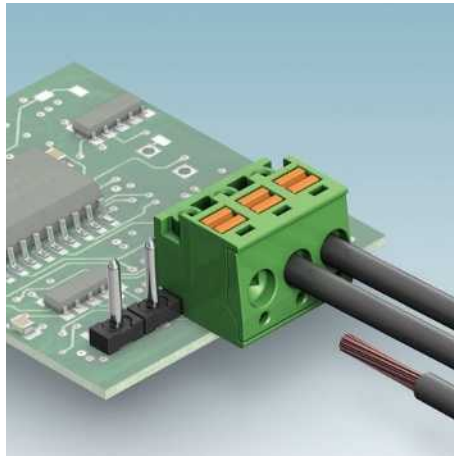

PTS plug-in connectors

- Push-in spring connection
- Safe latching when connecting the new pin-strip base strip
- Integrated release button prevents inadvertent release
- Optional coding
- Size comparable with screw solution

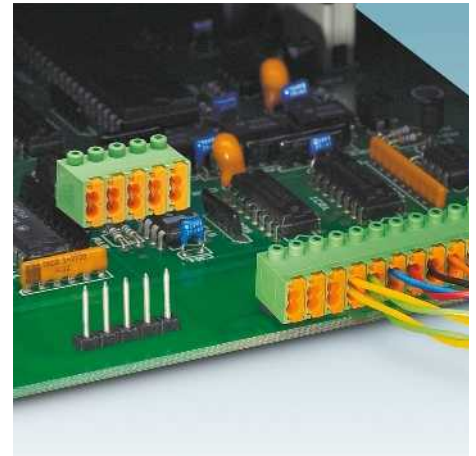

FK-MPT plug-in connectors

- Spring-cage double connection
- Direct plug-in method
- Compact dimensions
- Also available as PCB terminal block

Miniature PCB terminal blocks and plugs for LED lighting technology

- Push-in spring connection with release function
- Suitable for solid and stranded conductors
- Space-saving THR versions with two solder pins
- Robust SMD versions with edge anchor metals
- SMD soldering spots can be easily accessed for test purposes
- Compact design: 5 mm tall
- 2.5 mm pitch
- High current carrying capacity of 6 A
- Large connection capacity up to 0.75 mm²
- Available as PCB terminal block and plug-in connector
- Plug-in connectors for connections that can be separated
- Inverted base strips for board-to-board connections
- Available in white and black

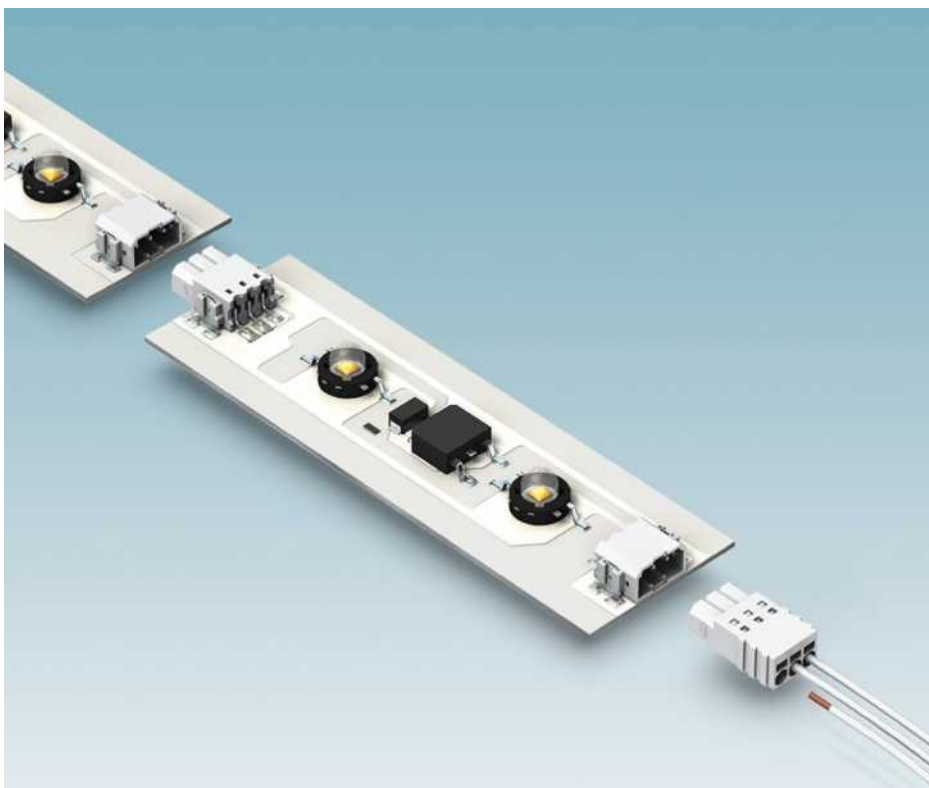

Options for COMBICON compact connection technology

Designation	Marking	Color		Partial assembly	Mech. coding	Color coding	Tape-on-reel packing	Other
		Standard	Optional					
PTSM...	● ⁵⁾	■	□	●	○	○	●	
PTSM... Plug-in	● ⁵⁾	■	□	●	○	○	●	
PTQ...	●	■	□ ²⁾	○ ²⁾	○	○	●	
PTS...	●	■	■ ³⁾	○ ²⁾	○	●	○ ²⁾	Blocks available with different pitches
PTS...PH	●	■	■ ³⁾	○ ²⁾	●	○	○	
FK-MPT	● ⁴⁾	■	■ ³⁾	●	○	○	○ ²⁾	
PTSA...	●	■	■ ³⁾	● ¹⁾	○	●	○ ²⁾	Blocks available with different pitches
PTDA...	● ⁴⁾	■	■ ³⁾	● ¹⁾	●	●	○ ²⁾	Blocks available with different pitches
PTA 1,5... PT 1,5... PT 2,5...	●	■	■ ³⁾	●	●	○	○ ²⁾	A-version can be aligned in the pitch (plug)
PST...	○	■	■ ³⁾	●	○	○	●	Various pin lengths/geometries available on request
PST...L...	○	■	○	●	●	○	○ ²⁾	
PST...SF	○	■	○	●	●	○	○ ²⁾	

● = Available

○ = Not available

¹⁾ With pitch spacer











²⁾ Available on request

³⁾ E.g., to double the pitch

⁴⁾ Two marking areas available

⁵⁾ Color marking

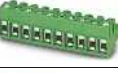
COMBICON compact cross-reference list

COMBICON compact plugs	Type	COMBICON compact pin strips	COMBICON compact pin strips						
			PST 1,0/...-3,5 Page 432	PST 1,0/...-H-3,5 Page 433	PST 1,3/...-5,0 Page 434	PST 1,3/...-H-5,0 Page 435	PST 1,3/...-5,0-SF Page 417	PST 1,3/...-LH-5,0 Page 431	PST 1,3/...-LV-5,0 Page 431
	Pitch		3.5	3.5	5.0	5.0	5.0	5.0	5.0
	PTDA 1,5/...-PH-3,5 Page 407	3.5	•	•1)					
	PTDA 1,5/...-PH-5,0 Page 409	5.0			•	•1)			
	FK-MPT 0,5/...-3,5 Page 403	3.5							
	FK-MPT 0,5/...-ST-3,5 Page 403	3.5	•	•1)					
	PTS 1,5/...-PH-5,0 Page 417	5.0			•	•	•		
	PT 1,5/...-PH-3,5 Page 423	3.5	•	•					
	PT 1,5/...-PVH-3,5 Page 423	3.5	•	•					
	PT 1,5/...-PH-5,0 Page 425	5.0			•	•			
	PT 1,5/...-PH-5,0 CLIP Page 425	5.0			•	•			
	PT 1,5/...-PVH-5,0 Page 425	5.0			•	•			
	PT 2,5/...-PVH-5,0 Page 431	5.0			•	•1)		•	•

1) Requires appropriate connection. More details available on request.

PCB terminal blocks and plugs with 2.5 mm pitch

THR spring-cage PCB terminal blocks up to 0.75 mm²

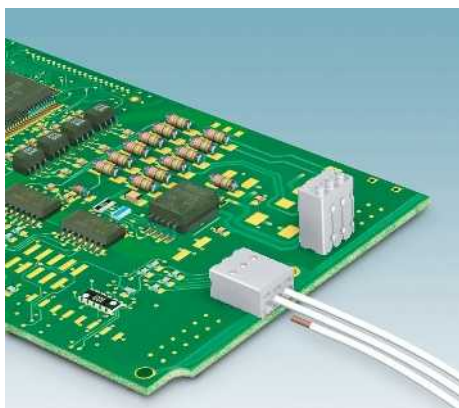

- Compact low-profile THR print terminal block, pitch 2.5 mm
- Spring-cage connection using direct plug-in method with a release button
- High current carrying capacity for high power transmission
- Double solder pins for stable hold on PCB
- Specifically designed for use in re-flow/solder processes
- Supplied in tape-on-reel packing according to IEC 60286-3 for automated mounting

Notes:

Pick and place pads for taped THR articles usually protrude beyond the components. The PCB layout must ensure that collisions are avoided when components are assembled. Dimensional drawings of tape reels and place pads can be found online at www.phoenixcontact.net/products.

PTSM is also available in black, see page 51.

Observe derating curve.

1) UL/CUL on request.

2) Stranded conductor cross section of up to 0.75 mm² supported, for a rated insulation voltage of 32 V for III/2.

3) Applies for single-phase networks.

Accessories

For all types	Type	Page
	Screwdriver SZS 0,4 X 2,0 Order No. 1205202	
	Ferrules with and without plastic sleeve	834
	Crimping pliers for 0.25 to 6 mm ² CRIMPFOX 6 Order No. 1212034	

Current carrying capacity curve

Type: PTSM 0,5/...-2,5-H- THR R...

Tested in accordance with DIN EN 60512-5-2:2003-01

Reduction factor = 1

No. of positions: 5

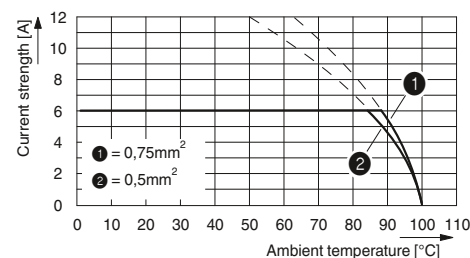

Technical data

Technical data in accordance to IEC / DIN VDE	
Rated current / conductor cross section	[A] / [mm ²]
Rated insulation voltage for pollution degree 2	[V]
Pitch	[mm]
Connection capacity	
Solid / stranded	[mm ²] / [mm ²] / AWG
Stranded with ferrules without plastic sleeve	[mm ²]
Stranded with ferrules with plastic sleeve	[mm ²]
Multi-conductor connection capacity (two conductors with the same cross section)	
Solid / stranded	[mm ²]
Stranded with ferrules without plastic sleeve	[mm ²]
Stranded with TWIN ferrule with plastic sleeve	[mm ²]
Insulation coordination	
Surge voltage category / pollution degree	
Rated insulation voltage	[V]
Rated surge voltage	[kV]
Approval data (UL/CUL)	Use Group
Nominal voltage	[V]
Nominal current	[A]
Connection capacity AWG	AWG
Approval data (CSA)	Use Group
Nominal voltage	[V]
Nominal current	[A]
Connection capacity AWG	AWG
General data	
Stripping length	[mm]
Type of insulation material / insulation material group	
Inflammability class according to UL 94	
Drill hole diameter / pin dimensions	[mm]

PTSM 0,5/ ...-2,5-H THR WH R24			PTSM 0,5/ ...-2,5-V THR WH R44		
6 / 0.5			6 / 0.5		
250 ³⁾			250 ³⁾		
2.5			2.5		
0.14 - 0.5 / 0.2 - 0.5 / 24 - 20 ²⁾			0.14 - 0.5 / 0.2 - 0.5 / 24 - 20 ²⁾		
0.25 - 0.5			0.25 - 0.5		
-			-		
-			-		
III / 3	III / 2	II / 2	III / 3	III / 2	II / 2
160	250 ³⁾	400	160	250 ³⁾	400
2.5	2.5	2.5	2.5	2.5	2.5
B	C	D	B	C	D
-	-	-	-	-	-
-	-	-	-	-	-
-	-	-	-	-	-
-	-	-	-	-	-
-	-	-	-	-	-
6			6		
PA / I			PA / I		
V0			V0		
1.2 / 0.3 x 0.8 mm			1.2 / 0.3 x 0.8 mm		

No. of pos.	Dim. a [mm]
2	2.50
3	5.00
4	7.50
5	10.00
6	12.50
7	15.00
8	17.50

N

N



Horizontal PCB terminal block for THR applications

Vertical PCB terminal block for THR applications

Dimensional drawing

Dimensional drawing

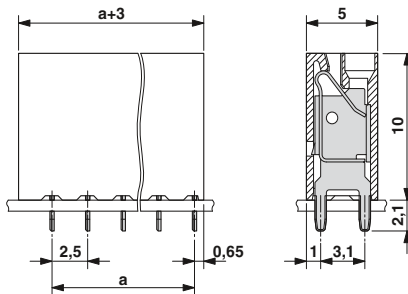
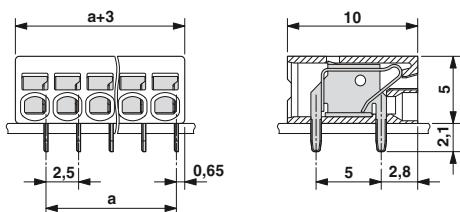

Drilling diagram

Drilling diagram

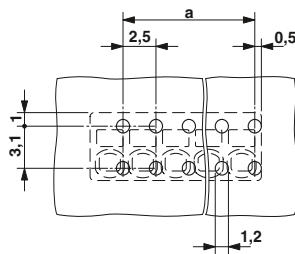
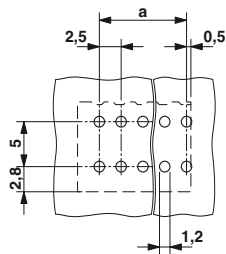

Ordering data

Ordering data

Type	Order No.	Pcs. / Pkt.
2.5 mm pitch, color: white		
PTSM 0,5/ 2-2,5-H THR WH R24	1814498	530
PTSM 0,5/ 3-2,5-H THR WH R32	1814508	530
PTSM 0,5/ 4-2,5-H THR WH R32	1814511	530
PTSM 0,5/ 5-2,5-H THR WH R32	1814524	530
PTSM 0,5/ 6-2,5-H THR WH R32	1814537	530
PTSM 0,5/ 7-2,5-H THR WH R32	1814540	530
PTSM 0,5/ 8-2,5-H THR WH R32	1814553	530

Type	Order No.	Pcs. / Pkt.
2.5 mm pitch, color: white		
PTSM 0,5/ 2-2,5-V THR WH R44	1814566	310
PTSM 0,5/ 3-2,5-V THR WH R44	1814579	310
PTSM 0,5/ 4-2,5-V THR WH R44	1814582	310
PTSM 0,5/ 5-2,5-V THR WH R44	1814595	310
PTSM 0,5/ 6-2,5-V THR WH R44	1814605	310
PTSM 0,5/ 7-2,5-V THR WH R44	1814618	310
PTSM 0,5/ 8-2,5-V THR WH R44	1814621	310

PCB terminal blocks and plugs with 2.5 mm pitch



SMD spring-cage PCB terminal blocks up to 0.75 mm²



- Compact low-profile SMD print terminal block, pitch 2.5 mm
- Spring-cage connection using direct plug-in method with a release button
- High current carrying capacity for high power transmission
- Rugged soldering anchors for safe mechanical fastening on the surface
- Specially designed to be used in pure SMT processes
- Supplied in tape-on-reel packing according to IEC 60286-3 for automated mounting

Notes:
Pick and place pads for taped THR articles usually protrude beyond the components. The PCB layout must ensure that collisions are avoided when components are assembled. Dimensional drawings of tape reels and place pads can be found online at www.phoenixcontact.net/products .
PTSM is also available in black, see page 53.
1) UL/CUL on request.
2) Stranded conductor cross section of up to 0.75 mm ² supported, for a rated insulation voltage of 32 V for III/2.
3) Applies for single-phase networks.

Accessories

For all types	Type	Page
	Screwdriver SZS 0,4 X 2,0 Order No. 1205202	
	Ferrules with and without plastic sleeve	834
	Crimping pliers for 0.25 to 6 mm ² CRIMPFOX 6 Order No. 1212034	

Current carrying capacity curve

Type: PTSM 0,5/...-2,5-H- SMD R44
Tested in accordance with DIN EN 60512-5-2:2003-01
Reduction factor = 1
No. of positions: 5

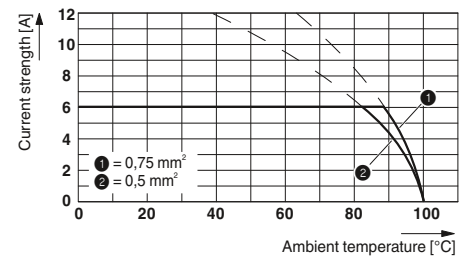

Technical data

Technical data in accordance to IEC / DIN VDE	
Rated current / conductor cross section	[A] / [mm ²]
Rated insulation voltage for pollution degree 2	[V]
Pitch	[mm]
Connection capacity	
Solid / stranded	[mm ²] / [mm ²] / AWG
Stranded with ferrules without plastic sleeve	[mm ²]
Stranded with ferrules with plastic sleeve	[mm ²]
Multi-conductor connection capacity (two conductors with the same cross section)	
Solid / stranded	[mm ²]
Stranded with ferrules without plastic sleeve	[mm ²]
Stranded with TWIN ferrule with plastic sleeve	[mm ²]
Insulation coordination	
Surge voltage category / pollution degree	
Rated insulation voltage	[V]
Rated surge voltage	[kV]
Approval data (UL/CUL)	Use Group
Nominal voltage	[V]
Nominal current	[A]
Connection capacity AWG	AWG
Approval data (CSA)	Use Group
Nominal voltage	[V]
Nominal current	[A]
Connection capacity AWG	AWG
General data	
Stripping length	[mm]
Type of insulation material / insulation material group	
Inflammability class according to UL 94	

PTSM 0,5/...-2,5-H SMD WH R24			PTSM 0,5/...-2,5-V SMD WH R44		
Rated current / conductor cross section			6 / 0.5		
Rated insulation voltage for pollution degree 2			250 ³⁾		
Pitch			2.5		
Connection capacity			2.5		
Solid / stranded			0.14 - 0.5 / 0.2 - 5 / 26 - 20 ²⁾		
Stranded with ferrules without plastic sleeve			0.25 - 0.5		
Stranded with ferrules with plastic sleeve			-		
Multi-conductor connection capacity (two conductors with the same cross section)			-		
Solid / stranded			- / -		
Stranded with ferrules without plastic sleeve			-		
Stranded with TWIN ferrule with plastic sleeve			-		
Insulation coordination					
Surge voltage category / pollution degree			III / 3 III / 2 II / 2		
Rated insulation voltage			63 250 ³⁾ 320		
Rated surge voltage			2.5 2.5 2.5		
Approval data (UL/CUL)			B C D		
Nominal voltage			-		
Nominal current			-		
Connection capacity AWG			-		
Approval data (CSA)			B C D		
Nominal voltage			-		
Nominal current			-		
Connection capacity AWG			-		
General data					
Stripping length			6		
Type of insulation material / insulation material group			PA / I		
Inflammability class according to UL 94			V0		

No. of pos.	Dim. a [mm]
2	2.50
3	5.00
4	7.50
5	10.00
6	12.50
7	15.00
8	17.50

N

N



Horizontal PCB terminal block for SMD applications

Vertical PCB terminal block for SMD applications

Dimensional drawing

Dimensional drawing

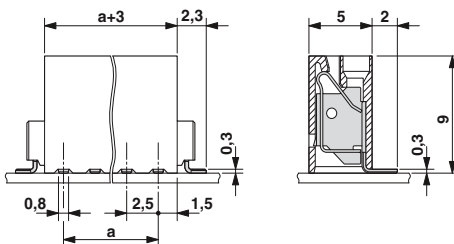
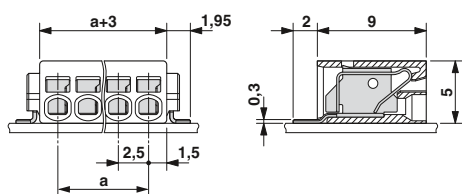

PCB layout

Dimension M: 7.7 mm

PCB layout

Dimension M: 8.4 mm

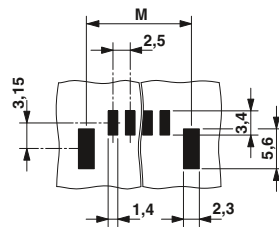
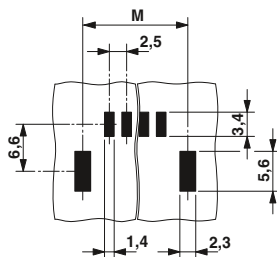

Ordering data

Type	Order No.	Pcs. / Pkt.
2.5 mm pitch, color: white		
PTSM 0,5/ 2-2,5-H SMD WH R24	1814634	770
PTSM 0,5/ 3-2,5-H SMD WH R44	1814647	770
PTSM 0,5/ 4-2,5-H SMD WH R24	1814650	770
PTSM 0,5/ 5-2,5-H SMD WH R44	1814663	770
PTSM 0,5/ 6-2,5-H SMD WH R44	1814676	770
PTSM 0,5/ 7-2,5-H SMD WH R44	1814689	770
PTSM 0,5/ 8-2,5-H SMD WH R44	1814692	770

Ordering data

Type	Order No.	Pcs. / Pkt.
2.5 mm pitch, color: white		
PTSM 0,5/ 2-2,5-V SMD WH R44	1814702	400
PTSM 0,5/ 3-2,5-V SMD WH R44	1814715	400
PTSM 0,5/ 4-2,5-V SMD WH R44	1814728	400
PTSM 0,5/ 5-2,5-V SMD WH R44	1814731	400
PTSM 0,5/ 6-2,5-V SMD WH R44	1814744	400
PTSM 0,5/ 7-2,5-V SMD WH R44	1814757	400
PTSM 0,5/ 8-2,5-V SMD WH R44	1814760	400

PCB terminal blocks and plugs with 2.5 mm pitch

Plugs with spring connection up to 0.75 mm²



- Miniature plug with 2.5 mm pitch
- Can be plugged into THR and SMD headers
- Conductor connection up to 0.75 mm²
- High current carrying capacity up to 6 A



Notes:

PTSM is also available in black, see page 55.

COMBICON select

You will find the possible plug-in connector combinations in COMBICON select at: www.phoenixcontact.net/products or starting on page 388.

Accessories

For all types	Type	Page
For PTSM connectors only		
	Screwdriver SZS 0,4 X 2,0 Order No. 1205202	
	Ferrules with and without plastic sleeve	834
	Crimping pliers for 0.25 to 6 mm ² CRIMPFOX 6 Order No. 1212034	

Technical data

Technical data in accordance to IEC / DIN VDE

Rated current / conductor cross section [A] / [mm²]

Rated insulation voltage for pollution degree 2 [V]

Pitch [mm]

Connection capacity

Solid / stranded [mm²] / [mm²] / AWG

Insulation coordination

Surge voltage category / pollution degree

Rated insulation voltage [V]

Rated surge voltage [kV]

Approval data (UL/CUL) Use Group

Nominal voltage [V]

Nominal current [A]

Connection capacity AWG AWG

Approval data (CSA) Use Group

Nominal voltage [V]

Nominal current [A]

Connection capacity AWG AWG

General data

Stripping length [mm]

Type of insulation material / insulation material group

Inflammability class according to UL 94

6 / 0.5

250

2.5

0.14 - 0.5 / 0.2 - 0.5 / 24 - 20

III / 3 III / 2 II / 2

100 250 320

2.5 2.5 2.5

B C D

150 - -

5 - -

26 - 20 - -

B C D

- - -

- - -

- - -

6

PA / I

V0

No. of pos. Dim. a [mm]

2 2.50

3 5.00

4 7.50

5 10.00

6 12.50

7 15.00

8 17.50

N



Spring-cage plug for
conductor cross sections up to 0.75 mm²



Dimensional drawing

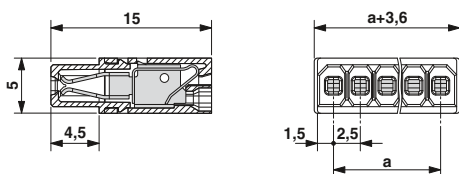

Ordering data

Type	Order No.	Pcs. / Pkt.
2.5 mm pitch, color: white		
PTSM 0,5/ 2-P-2,5 WH	1704853	250
PTSM 0,5/ 3-P-2,5 WH	1704854	250
PTSM 0,5/ 4-P-2,5 WH	1704857	250
PTSM 0,5/ 5-P-2,5 WH	1704858	100
PTSM 0,5/ 6-P-2,5 WH	1704859	100
PTSM 0,5/ 7-P-2,5 WH	1704860	100
PTSM 0,5/ 8-P-2,5 WH	1704861	100

PCB terminal blocks and plugs with 2.5 mm pitch

SMT and THR headers for pierce contact or spring-cage connectors



- Specifically designed for use in reflow and SMT processes
- High current carrying capacity of 6 A
- Robust solder anchor for secure, mechanical fixing to the surface
- Supplied in tape-on-reel packing according to IEC 60286-3 for automated mounting
- Compatible with PTSM...-/PTPM...connectors
- Versions with and without positioning pins are available
- 2.5 mm pitch

Notes:
PTSM is also available in black, see page 59.
COMBICON select You will find the possible plug-in connector combinations in COMBICON select at: www.phoenixcontact.net/products or starting on page 388.
Pick and place pads for taped THR articles usually protrude beyond the components. The PCB layout must ensure that collisions are avoided when components are assembled. Dimensional drawings of tape reels and place pads can be found online at www.phoenixcontact.net/products .
1) UL/CUL on request.
2) Current carrying dependent upon plug used.
3) Applies for single-phase networks.

Technical data

Technical data in accordance to IEC / DIN VDE	
Rated current	[A]
Rated insulation voltage for pollution degree 2	[V]
Pitch	[mm]
Insulation coordination	
Surge voltage category / pollution degree	
Rated insulation voltage	[V]
Rated surge voltage	[kV]
Approval data (UL/CUL)	Use Group
Nominal voltage	[V]
Nominal current	[A]
Connection capacity AWG	AWG
Approval data (CSA)	Use Group
Nominal voltage	[V]
Nominal current	[A]
Connection capacity AWG	AWG
General data	
Type of insulation material / insulation material group	
Inflammability class according to UL 94	
Drill hole diameter / pin dimensions	[mm]

PTSM 0,5/...-HH-2,5-THR WH R16			PTSM 0,5/ ...-HV-2,5-THR WH R32			PTSM 0,5/...-HH0-2,5-SMD WH R32		
6 ²⁾			6 ²⁾			6 ²⁾		
250 ³⁾			250 ³⁾			250 ³⁾		
2.5			2.5			2.5		
III / 3	III / 2	II / 2	III / 3	III / 2	II / 2	III / 3	III / 2	II / 2
125	250 ³⁾	320	125	250 ³⁾	320	125	250 ³⁾	320
2.5	2.5	2.5	2.5	2.5	2.5	2.5	2.5	2.5
B	C	D	B	C	D	B	C	D
-	-	-	-	-	-	-	-	-
-	-	-	-	-	-	-	-	-
-	-	-	-	-	-	-	-	-
B	C	D	B	C	D	B	C	D
-	-	-	-	-	-	-	-	-
-	-	-	-	-	-	-	-	-
-	-	-	-	-	-	-	-	-
PA / I			PA / I			PA / I		
V0			V0			V0		
1.1 / 0.6 x 0.6 mm			1.1 / 0.6 x 0.6 mm			- / -		

No. of pos.	Dim. a [mm]
2	2.50
3	5.00
4	7.50
5	10.00
6	12.50
7	15.00
8	17.50

N

N

N



Horizontal header for THR applications



Vertical header for THR applications



Horizontal header for SMD applications

Dimensional drawing

Dimensional drawing

Dimensional drawing

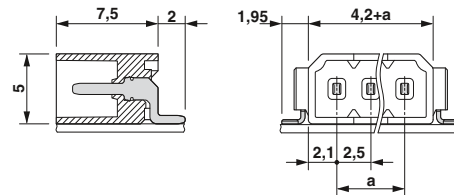
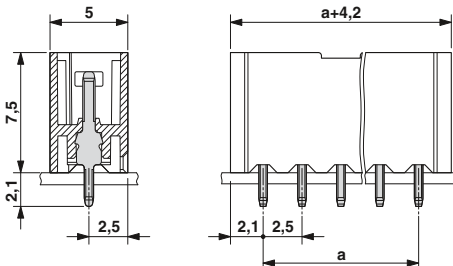
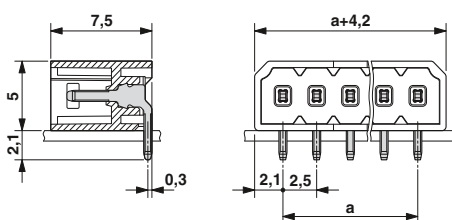

Drilling diagram

Drilling diagram

Drilling diagram

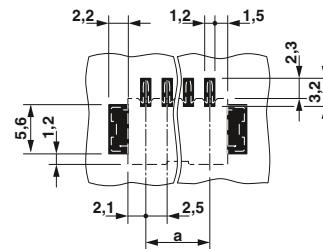
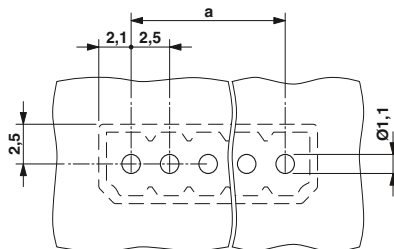
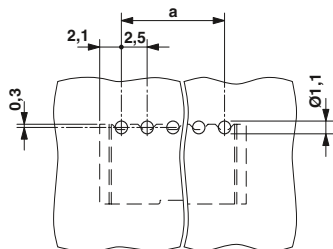

Ordering data

Ordering data

Ordering data

Type	Order No.	Pcs. / Pkt.
2.5 mm pitch, color: white, without positioning pins		
PTSM 0,5/ 2-HH-2,5-THR WH R16	1814841	500
PTSM 0,5/ 3-HH-2,5-THR WH R32	1814854	500
PTSM 0,5/ 4-HH-2,5-THR WH R32	1814867	500
PTSM 0,5/ 5-HH-2,5-THR WH R32	1814870	500
PTSM 0,5/ 6-HH-2,5-THR WH R32	1814883	500
PTSM 0,5/ 7-HH-2,5-THR WH R44	1814896	500
PTSM 0,5/ 8-HH-2,5-THR WH R44	1814906	500

Type	Order No.	Pcs. / Pkt.
2.5 mm pitch, color: white, without positioning pins		
PTSM 0,5/ 2-HV-2,5-THR WH R32	1815264	330
PTSM 0,5/ 3-HV-2,5-THR WH R32	1815277	330
PTSM 0,5/ 4-HV-2,5-THR WH R32	1815280	330
PTSM 0,5/ 5-HV-2,5-THR WH R32	1815293	330
PTSM 0,5/ 6-HV-2,5-THR WH R32	1815303	330
PTSM 0,5/ 7-HV-2,5-THR WH R44	1815316	330
PTSM 0,5/ 8-HV-2,5-THR WH R44	1815329	330

Type	Order No.	Pcs. / Pkt.
2.5 mm pitch, color: white, without positioning pins		
PTSM 0,5/ 2-HH0-2,5-SMD WH R32	1814919	600
PTSM 0,5/ 3-HH0-2,5-SMD WH R32	1814922	600
PTSM 0,5/ 4-HH0-2,5-SMD WH R32	1814935	600
PTSM 0,5/ 5-HH0-2,5-SMD WH R32	1814948	600
PTSM 0,5/ 6-HH0-2,5-SMD WH R44	1814951	600
PTSM 0,5/ 7-HH0-2,5-SMD WH R44	1814964	600
PTSM 0,5/ 8-HH0-2,5-SMD WH R44	1814977	600

PCB terminal blocks and plugs with 2.5 mm pitch

Inverted SMD and THR base strips



- Specifically designed for use in reflow and SMT processes
- High current carrying capacity of 6 A
- Rugged soldering anchors for safe mechanical fastening on the surface
- Supplied in tape-on-reel packing according to IEC 60286-3 for automated mounting
- Compatible with PTSM base strips
- Versions with and without positioning pins are available
- 2.5 mm pitch
- Robust mechanical design

Notes:
PTSM is also available in black, see page 61.
COMBICON select You will find the possible plug-in connector combinations in COMBICON select at: www.phoenixcontact.net/products or starting on page 388.
Pick and place pads for taped THR articles usually protrude beyond the components. The PCB layout must ensure that collisions are avoided when components are assembled. Dimensional drawings of tape reels and place pads can be found online at www.phoenixcontact.net/products .
1) UL/CUL on request.
2) Applies for single-phase networks.

Technical data

Technical data in accordance to IEC / DIN VDE

Rated current	[A]	6
Rated insulation voltage for pollution degree 2	[V]	250 ²⁾
Pitch	[mm]	2.5
Insulation coordination		
Surge voltage category / pollution degree		III / 3 III / 2 II / 2
Rated insulation voltage	[V]	160 250 ²⁾ 400
Rated surge voltage	[kV]	2.5 2.5 2.5
Approval data (UL/CUL)	Use Group	B C D
Nominal voltage	[V]	- 1) -
Nominal current	[A]	- 1) -
Connection capacity AWG	AWG	- - -
Approval data (CSA)	Use Group	B C D
Nominal voltage	[V]	- - -
Nominal current	[A]	- - -
Connection capacity AWG	AWG	- - -
General data		
Type of insulation material / insulation material group		PA / I
Inflammability class according to UL 94		V0
Drill hole diameter / pin dimensions	[mm]	1 / 0.6 x 0.4 mm

PTSM 0,5/...-HHI-2,5-THR WH R24

Rated current	[A]	6
Rated insulation voltage for pollution degree 2	[V]	250 ²⁾
Pitch	[mm]	2.5
Insulation coordination		
Surge voltage category / pollution degree		III / 3 III / 2 II / 2
Rated insulation voltage	[V]	160 250 ²⁾ 400
Rated surge voltage	[kV]	2.5 2.5 2.5
Approval data (UL/CUL)	Use Group	B C D
Nominal voltage	[V]	- 1) -
Nominal current	[A]	- 1) -
Connection capacity AWG	AWG	- - -
Approval data (CSA)	Use Group	B C D
Nominal voltage	[V]	- - -
Nominal current	[A]	- - -
Connection capacity AWG	AWG	- - -
General data		
Type of insulation material / insulation material group		PA / I
Inflammability class according to UL 94		V0
Drill hole diameter / pin dimensions	[mm]	1 / 0.6 x 0.4 mm

PTSM 0,5/...-HHI0-2,5-SMD WHR24

Rated current	[A]	6
Rated insulation voltage for pollution degree 2	[V]	250 ²⁾
Pitch	[mm]	2.5
Insulation coordination		
Surge voltage category / pollution degree		III / 3 III / 2 II / 2
Rated insulation voltage	[V]	160 250 ²⁾ 400
Rated surge voltage	[kV]	2.5 2.5 2.5
Approval data (UL/CUL)	Use Group	B C D
Nominal voltage	[V]	- 1) -
Nominal current	[A]	- 1) -
Connection capacity AWG	AWG	- - -
Approval data (CSA)	Use Group	B C D
Nominal voltage	[V]	- - -
Nominal current	[A]	- - -
Connection capacity AWG	AWG	- - -
General data		
Type of insulation material / insulation material group		PA / I
Inflammability class according to UL 94		V0
Drill hole diameter / pin dimensions	[mm]	- / -

No. of pos.	Dim. a [mm]
2	2.50
3	5.00
4	7.50
5	10.00
6	12.50
7	15.00
8	17.50

N

N



Horizontal inverted header, THR solderable

Horizontal inverted header, SMD solderable

Dimensional drawing

Dimensional drawing

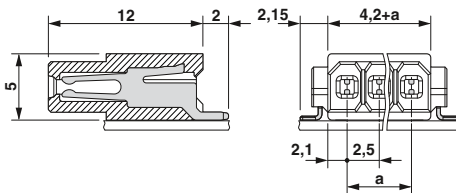
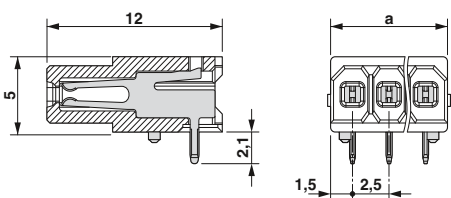

Drilling diagram

Drilling diagram

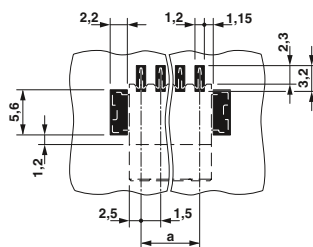
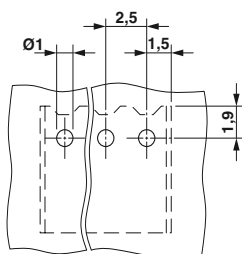

Ordering data

Ordering data

Type Order No. Pcs. / Pkt.
2.5 mm pitch, color: white, without positioning pins

Type Order No. Pcs. / Pkt.
2.5 mm pitch, color: white, without positioning pins

PTSM 0,5/ 2-HHI-2,5-THR WH R24	1814980	500
PTSM 0,5/ 3-HHI-2,5-THR WH R32	1814993	500
PTSM 0,5/ 4-HHI-2,5-THR WH R32	1815002	500
PTSM 0,5/ 5-HHI-2,5-THR WH R32	1815015	500
PTSM 0,5/ 6-HHI-2,5-THR WH R32	1815028	500
PTSM 0,5/ 7-HHI-2,5-THR WH R32	1815031	500
PTSM 0,5/ 8-HHI-2,5-THR WH R32	1815044	500

PTSM 0,5/ 2-HHI0-2,5-SMD WHR24	1815196	500
PTSM 0,5/ 3-HHI0-2,5-SMD WHR44	1815206	500
PTSM 0,5/ 4-HHI0-2,5-SMD WHR44	1815219	500
PTSM 0,5/ 5-HHI0-2,5-SMD WHR44	1815222	500
PTSM 0,5/ 6-HHI0-2,5-SMD WHR44	1815235	500
PTSM 0,5/ 7-HHI0-2,5-SMD WHR44	1815248	500
PTSM 0,5/ 8-HHI0-2,5-SMD WHR44	1815251	500

Direct plug-in and PCB connectors for flexible PCBs

Connection terminal block for flexible LED PCBs

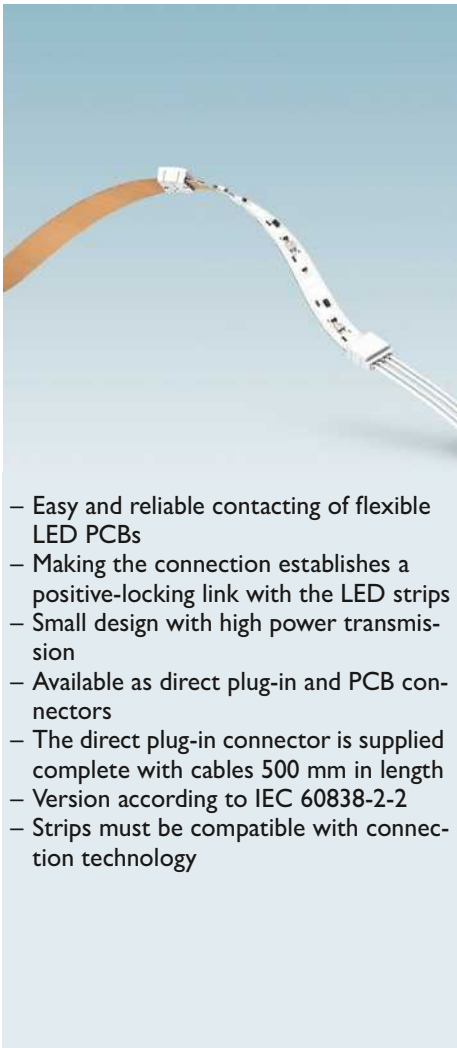

- Easy and reliable contacting of flexible LED PCBs
- Making the connection establishes a positive-locking link with the LED strips
- Small design with high power transmission
- Available as direct plug-in and PCB connectors
- The direct plug-in connector is supplied complete with cables 500 mm in length
- Version according to IEC 60838-2-2
- Strips must be compatible with connection technology

Notes:
1) UL/CUL on request.
2) Depending on the flexible PCB, a maximum of 10 A is permitted for plugs and connectors.

Technical data	PTF 0,3/ ...-BB-1,8-H			PTF 0,3/ ...-WB-1,8-H		
Technical data in accordance to IEC / DIN VDE						
Rated current / conductor cross section	10 ² / 0.34			10 ² / 0.34		
Rated insulation voltage for pollution degree 2	25			25		
Pitch	1.8			1.8		
Connection capacity						
Solid / stranded	- / - / -			- / - / -		
Insulation coordination						
Surge voltage category / pollution degree	III / 3	III / 2	II / 2	III / 3	III / 2	II / 2
Rated insulation voltage	25	25	25	25	25	25
Rated surge voltage	[kV]			[kV]		
Approval data (UL/CUL)	B	C	D	B	C	D
Nominal voltage	-	-	-	-	-	-
Nominal current	-	-	-	-	-	-
Connection capacity AWG	-	-	-	-	-	-
Approval data (CSA)	B	C	D	B	C	D
Nominal voltage	-	-	-	-	-	-
Nominal current	-	-	-	-	-	-
Connection capacity AWG	-	-	-	-	-	-
General data						
Type of insulation material / insulation material group	PBT / IIIa			PBT / IIIa		
Inflammability class according to UL 94	V0			V0		

No. of pos.	2
	4



Dimensional drawing

Dimensional drawing

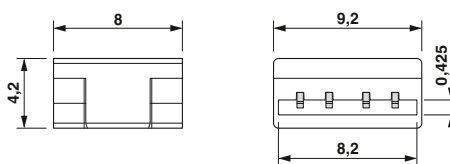
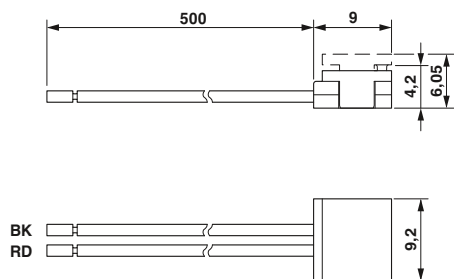

Drilling diagram

Drilling diagram

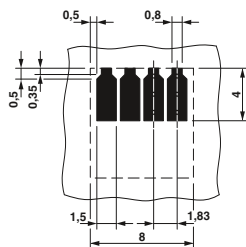
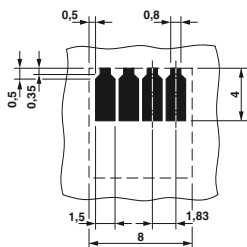

Ordering data

Ordering data

Type	Order No.	Pcs. / Pkt.
PTF 0,3/ 2-WB-1,8-H	1826091	25
PTF 0,3/ 4-WB-1,8-H	1826114	25

Type	Order No.	Pcs. / Pkt.
PTF 0,3/ 4-BB-1,8-H	1826101	25

FK-MPT series

PCB terminals with spring-cage double connection up to 2 x 0.5 mm²

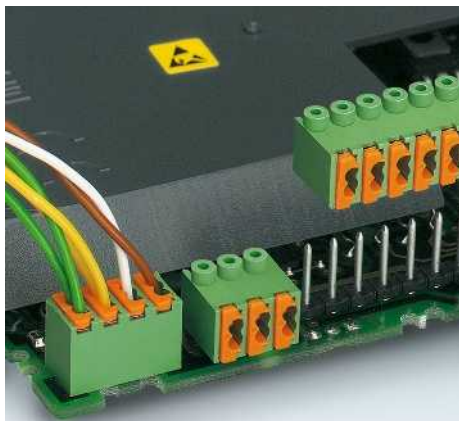

- Miniature connection terminal for solid conductors
- Pitch 3.5 mm
- Easy looping through of potentials, thanks to double connection
- Increased operating convenience, thanks to the direct plug-in method with release button
- Available as a PCB terminal block or as connector

Notes:
Larger packing units are available on request.
For PST 1,0/...-3,5 pin strips, see page 432.
COMBICON select You will find the possible plug-in connector combinations in COMBICON select at: www.phoenixcontact.net/products or starting on page 388.
1) Please observe the current carrying capacity curves. Further current carrying capacity curves on request.

Accessories		
For all types	Type	Page
	Marker cards SK 3,5/2,8	797

Current carrying capacity curve

Type: FK-MPT 0,5/5-ST-3,5
Test following DIN EN 60512-5-2:2003-01
Reduction factor = 0.8
No. of positions: 5

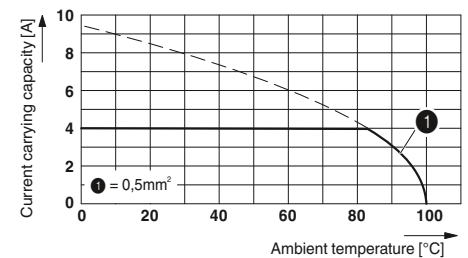

Technical data

Technical data in accordance to IEC / DIN VDE	
Rated current / conductor cross section	[A] / [mm ²]
Rated insulation voltage for pollution degree 2	[V]
Pitch	[mm]
Connection capacity	
Solid / stranded	[mm ²] / [mm ²] / AWG
Stranded with ferrules without plastic sleeve	[mm ²]
Stranded with ferrules with plastic sleeve	[mm ²]
Multi-conductor connection capacity (two conductors with the same cross section)	
Solid / stranded	[mm ²]
Stranded with ferrules without plastic sleeve	[mm ²]
Stranded with TWIN ferrule with plastic sleeve	[mm ²]
Insulation coordination	
Surge voltage category / pollution degree	
Rated insulation voltage	[V]
Rated surge voltage	[kV]
Approval data (UL/CUL)	Use Group
Nominal voltage	[V]
Nominal current	[A]
Connection capacity AWG	AWG
Approval data (CSA)	Use Group
Nominal voltage	[V]
Nominal current	[A]
Connection capacity AWG	AWG
General data	
Stripping length	[mm]
Type of insulation material / insulation material group	
Inflammability class according to UL 94	
Drill hole diameter / pin dimensions	[mm]

FK-MPT 0,5/ ...-3,5			FK-MPT 0,5/ ...-3,5-H			FK-MPT 0,5/ ...-ST-3,5		
4 ¹⁾ / 0.5			4 ¹⁾ / 0.5			4 ¹⁾ / 0.5		
250			250			250		
3.5			3.5			3.5		
0.12 - 0.5 / - / 26 - 20			0.12 - 0.5 / - / 26 - 20			0.12 - 0.5 / - / 26 - 20		
-			-			-		
-			-			-		
- / -			- / -			- / -		
-			-			-		
-			-			-		
III / 3	III / 2	II / 2	III / 3	III / 2	II / 2	III / 3	III / 2	II / 2
160	250	250	160	250	250	160	250	250
2.5	2.5	2.5	2.5	2.5	2.5	2.5	2.5	2.5
B	C	D	B	C	D	B	C	D
300	-	300	300	-	300	300	-	300
4	-	4	4	-	4	4	-	4
28 - 20	-	28 - 20	28 - 20	-	28 - 20	28 - 20	-	28 - 20
B	C	D	B	C	D	B	C	D
-	-	-	-	-	-	-	-	-
-	-	-	-	-	-	-	-	-
-	-	-	-	-	-	-	-	-
6.5			6.5			6.5		
PBT / IIIa			PBT / IIIa			PBT / IIIa		
V0			V0			V0		
1 / 0.4 x 0.9 mm			1.2 / 1 mm			- / -		

No. of pos.	Dim. a [mm]
2	3.50
3	7.00
4	10.50
5	14.00
6	17.50
7	21.00
8	24.50
9	28.00
10	31.50
11	35.00
12	38.50
13	42.00
14	45.50
15	49.00
16	52.50

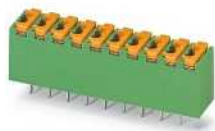

Connection direction vertical to the PCB



Connection direction parallel to the PCB



Can be plugged onto PST 1,0/...3,5 pin strip



Dimensional drawing

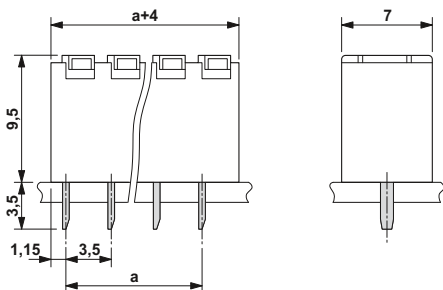

Drilling diagram

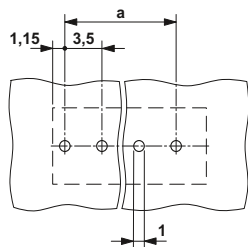

Dimensional drawing

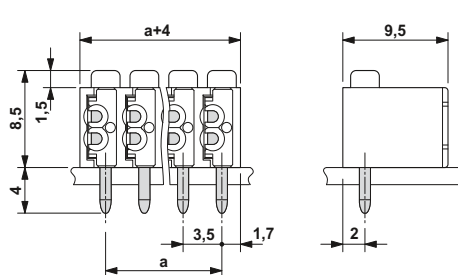

Drilling diagram

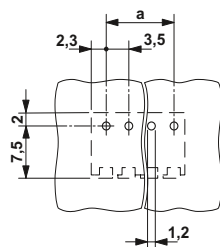

Dimensional drawing

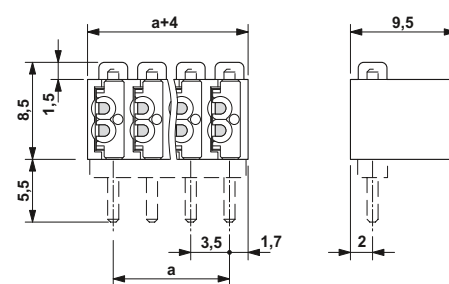

Ordering data

Type	Order No.	Pcs. / Pkt.
3.5 mm pitch, color: green		
FK-MPT 0,5/ 2-3,5	1891069	50
FK-MPT 0,5/ 3-3,5	1891072	50
FK-MPT 0,5/ 4-3,5	1891085	50
FK-MPT 0,5/ 5-3,5	1891098	50
FK-MPT 0,5/ 6-3,5	1891108	50
FK-MPT 0,5/ 7-3,5	1891111	50
FK-MPT 0,5/ 8-3,5	1891124	50
FK-MPT 0,5/ 9-3,5	1891137	50
FK-MPT 0,5/10-3,5	1891140	50
FK-MPT 0,5/11-3,5	1891153	50
FK-MPT 0,5/12-3,5	1891166	50
FK-MPT 0,5/13-3,5	1891179	50
FK-MPT 0,5/14-3,5	1891182	50
FK-MPT 0,5/15-3,5	1891195	50
FK-MPT 0,5/16-3,5	1891205	50

Ordering data

Type	Order No.	Pcs. / Pkt.
3.5 mm pitch, color: green		
FK-MPT 0,5/ 2-3,5-H	1928767	50
FK-MPT 0,5/ 3-3,5-H	1928770	50
FK-MPT 0,5/ 4-3,5-H	1928783	50
FK-MPT 0,5/ 5-3,5-H	1928796	50
FK-MPT 0,5/ 6-3,5-H	1928806	50
FK-MPT 0,5/ 7-3,5-H	1928819	50
FK-MPT 0,5/ 8-3,5-H	1928822	50
FK-MPT 0,5/ 9-3,5-H	1928835	50
FK-MPT 0,5/10-3,5-H	1928848	50
FK-MPT 0,5/11-3,5-H	1928851	50
FK-MPT 0,5/12-3,5-H	1928864	50
FK-MPT 0,5/13-3,5-H	1928877	50
FK-MPT 0,5/14-3,5-H	1928880	50
FK-MPT 0,5/15-3,5-H	1928893	50
FK-MPT 0,5/16-3,5-H	1928903	50

Ordering data

Type	Order No.	Pcs. / Pkt.
3.5 mm pitch, color: green		
FK-MPT 0,5/ 2-ST-3,5	1913921	50
FK-MPT 0,5/ 3-ST-3,5	1913934	50
FK-MPT 0,5/ 4-ST-3,5	1913947	50
FK-MPT 0,5/ 5-ST-3,5	1913950	50
FK-MPT 0,5/ 6-ST-3,5	1913963	50
FK-MPT 0,5/ 7-ST-3,5	1913976	50
FK-MPT 0,5/ 8-ST-3,5	1913989	50
FK-MPT 0,5/ 9-ST-3,5	1913992	50
FK-MPT 0,5/10-ST-3,5	1914001	50
FK-MPT 0,5/11-ST-3,5	1914027	50
FK-MPT 0,5/12-ST-3,5	1914030	50
FK-MPT 0,5/13-ST-3,5	1914043	50
FK-MPT 0,5/14-ST-3,5	1914056	50
FK-MPT 0,5/15-ST-3,5	1914069	50
FK-MPT 0,5/16-ST-3,5	1914072	50

FK-MPT series

FK-MPT 0,5/...-IC(V)A base strips for spring-miniature terminal blocks

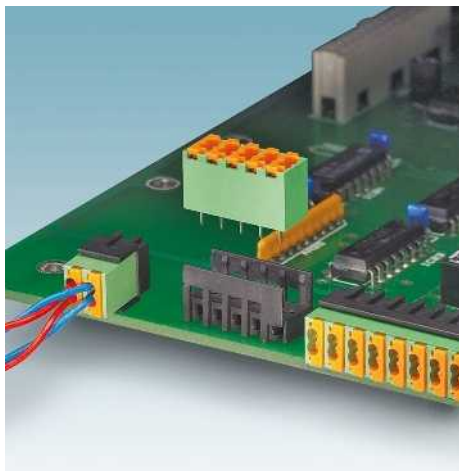

- Shock-proof header for FK-MPT PCB terminal block
- Pitch 3.5 mm
- Simple pre-assembly
- Available in vertical and horizontal versions
- With closed side panels
- Protection against mismatching due to the asymmetrical layout of sockets

Notes:

COMBICON select

You will find the possible plug-in connector combinations in COMBICON select at: www.phoenixcontact.net/products or starting on page 388.



Base strip for FK-MPT 0,5/...-3,5, plug-in direction horizontal to the PCB



Dimensional drawing

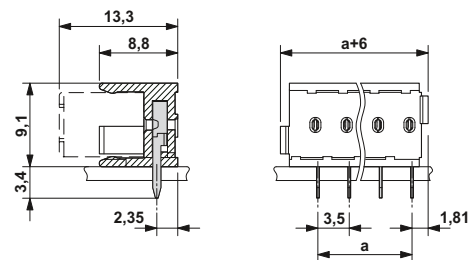

Drilling diagram

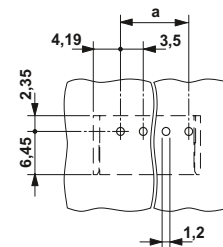

Technical data

Technical data in accordance to IEC / DIN VDE

Rated current	[A]	3		
Rated insulation voltage for pollution degree 2	[V]	250		
Pitch	[mm]	3.5		
Insulation coordination				
Surge voltage category / pollution degree		III / 3	III / 2	II / 2
Rated insulation voltage	[V]	160	250	250
Rated surge voltage	[kV]	2.5	2.5	2.5
Approval data (UL/CUL)	Use Group	B	C	D
Nominal voltage	[V]	300	-	300
Nominal current	[A]	4	-	4
Connection capacity AWG	AWG	-	-	-
Approval data (CSA)	Use Group	B	C	D
Nominal voltage	[V]	-	-	-
Nominal current	[A]	-	-	-
Connection capacity AWG	AWG	-	-	-
General data				
Type of insulation material / insulation material group		PA / IIIa		
Inflammability class according to UL 94		V0		
Drill hole diameter / pin dimensions	[mm]	1 / 0.3 x 0.9 mm		

Ordering data

No. of pos.	Dim. a [mm]	Type	Order No.	Pcs. / Pkt.
Pitch 3.5 mm, color: Black				
2	3.50	FK-MPT 0,5/ 2-ICA-3,5	1930328	50
3	7.00	FK-MPT 0,5/ 3-ICA-3,5	1930331	50
4	10.50	FK-MPT 0,5/ 4-ICA-3,5	1930344	50
5	14.00	FK-MPT 0,5/ 5-ICA-3,5	1930357	50
6	17.50	FK-MPT 0,5/ 6-ICA-3,5	1930360	50
7	21.00	FK-MPT 0,5/ 7-ICA-3,5	1930373	50
8	24.50	FK-MPT 0,5/ 8-ICA-3,5	1930386	50
9	28.00	FK-MPT 0,5/ 9-ICA-3,5	1930399	50
10	31.50	FK-MPT 0,5/10-ICA-3,5	1930409	50
11	35.00	FK-MPT 0,5/11-ICA-3,5	1930412	50
12	38.50	FK-MPT 0,5/12-ICA-3,5	1930425	50
13	42.00	FK-MPT 0,5/13-ICA-3,5	1930438	50
14	45.50	FK-MPT 0,5/14-ICA-3,5	1930441	50
15	49.00	FK-MPT 0,5/15-ICA-3,5	1930454	50
16	52.50	FK-MPT 0,5/16-ICA-3,5	1930467	50



Base strip for FK-MPT 0,5/...-3,5, plug-in direction vertical to the PCB



Dimensional drawing

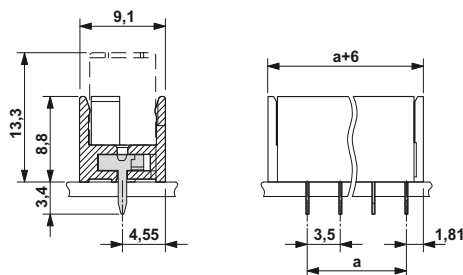

Drilling diagram

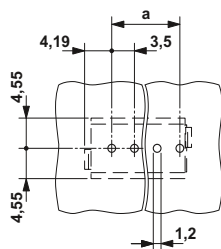

Ordering data

Type	Order No.	Pcs. / Pkt.
Pitch 3.5 mm, color: Black		
FK-MPT 0,5/ 2-ICVA-3,5	1930470	50
FK-MPT 0,5/ 3-ICVA-3,5	1930483	50
FK-MPT 0,5/ 4-ICVA-3,5	1930496	50
FK-MPT 0,5/ 5-ICVA-3,5	1930506	50
FK-MPT 0,5/ 6-ICVA-3,5	1930519	50
FK-MPT 0,5/ 7-ICVA-3,5	1930522	50
FK-MPT 0,5/ 8-ICVA-3,5	1930535	50
FK-MPT 0,5/ 9-ICVA-3,5	1930548	50
FK-MPT 0,5/10-ICVA-3,5	1930551	50
FK-MPT 0,5/11-ICVA-3,5	1930564	50
FK-MPT 0,5/12-ICVA-3,5	1930577	50
FK-MPT 0,5/13-ICVA-3,5	1930580	50
FK-MPT 0,5/14-ICVA-3,5	1930593	50
FK-MPT 0,5/15-ICVA-3,5	1930603	50
FK-MPT 0,5/16-ICVA-3,5	1930616	50

PTDA series

Angled PCB terminals with spring-cage double connection up to 2 x 1.5 mm²

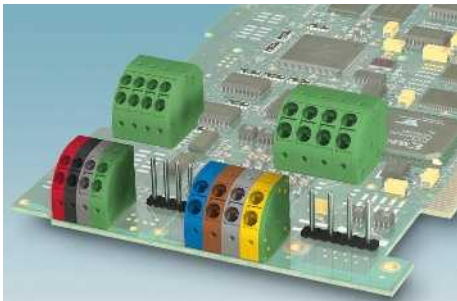

- Spring-cage double connection using direct plug-in method with a release button
- Pitch 3.5 mm
- Large terminal block capacity with compact dimensions
- Optional color coding
- Plug with optional mechanical coding
- Attractive design for connection in the field of vision
- PCB terminal block and plug-in connector available

Notes:

COMBICON select
You will find the possible plug-in connector combinations in COMBICON select at: www.phoenixcontact.net/products or starting on page 388.

PTDA 1,5/...-PH-3,5 can be plugged onto the PST 1,0/...-3,5 pin strip, see page 432.

Pitch spacers for the PTDA series are available on request. For further information, visit www.phoenixcontact.net/products.

1) Please observe the current carrying capacity curves. Further current carrying capacity curves on request.

Accessories

For all types	Type	Page
	Screwdriver SZF 0-0,4 x 2,5 Order No. 1204504	
	Coding profile CP-PTDA Order No. 1731361	38
	Marker cards SK 3,5/2,8	797
	Ferrules with and without plastic sleeve	834
	Crimping pliers for 0.25 to 6 mm ² CRIMPFOX 6 Order No. 1212034	

Representative derating curve

Type: PTDA 1,5/...-PH-3,5
Derating curve determined as per
DIN EN 61984 (VDE 0627):2002-09
Representation based on DIN EN 60512-5-2:2003-01
Reduction factor = 0.8
Conductor cross section: 1.5 mm²

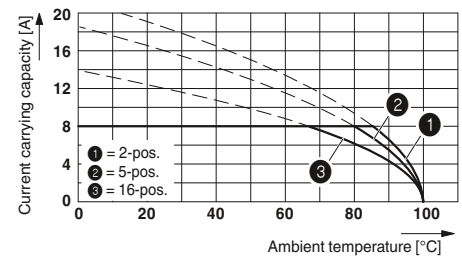

Technical data

Technical data in accordance to IEC / DIN VDE	
Rated current / conductor cross section	[A] / [mm ²]
Rated insulation voltage for pollution degree 2	[V]
Pitch	[mm]
Connection capacity	
Solid / stranded	[mm ²] / [mm ²] / AWG
Stranded with ferrules without plastic sleeve	[mm ²]
Stranded with ferrules with plastic sleeve	[mm ²]
Multi-conductor connection capacity (two conductors with the same cross section)	
Solid / stranded	[mm ²]
Stranded with ferrules without plastic sleeve	[mm ²]
Stranded with TWIN ferrule with plastic sleeve	[mm ²]
Insulation coordination	
Surge voltage category / pollution degree	
Rated insulation voltage	[V]
Rated surge voltage	[kV]
Approval data (UL/CUL)	Use Group
Nominal voltage	[V]
Nominal current	[A]
Connection capacity AWG	AWG
Approval data (CSA)	Use Group
Nominal voltage	[V]
Nominal current	[A]
Connection capacity AWG	AWG
General data	
Stripping length	[mm]
Type of insulation material / insulation material group	
Inflammability class according to UL 94	
Drill hole diameter / pin dimensions	[mm]

PTDA 1,5/ ...-3,5

PTDA 1,5/ ...-3,5			PTDA 1,5/ ...-PH-3,5		
13.5 ¹⁾ / 1.5			8 ¹⁾ / 1.5		
240			240		
3.5			3.5		
0.2 - 1.5 / 0.2 - 1.5 / 24 - 16			0.2 - 1.5 / 0.2 - 1.5 / 24 - 16		
0.5 - 1.5			0.5 - 1.5		
0.5 - 0.5			0.5 - 0.5		
0.2 - 1.5 / 0.2 - 1.5			0.2 - 1.5 / 0.2 - 1.5		
0.5 - 1.5			0.5 - 1.5		
0.5 - 0.5			0.5 - 0.5		
III / 3	III / 2	II / 2	III / 3	III / 2	II / 2
200	240	400	160	240	400
2.5	2.5	2.5	2.5	2.5	2.5
B	C	D	B	C	D
300	-	300	150	-	300
12	-	10	10	-	10
24 - 16	24 - 16	24 - 16	24 - 16	24 - 16	24 - 16
B	C	D	B	C	D
-	-	-	-	-	-
-	-	-	-	-	-
-	-	-	-	-	-
10			10		
PA / I			PA / I		
V0			V0		
1.3 / 1.0 x 0.4			- / -		

No. of pos.	Dim. a [mm]
2	3.50
3	7.00
4	10.50
5	14.00
6	17.50
7	21.00
8	24.50
9	28.00
10	31.50
11	35.00
12	38.50
13	42.00
14	45.50
15	49.00
16	52.50

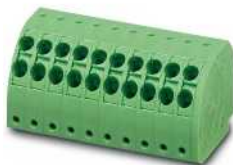

PCB terminal block with spring-cage double connection

Plug component with spring-cage double connection, can be plugged onto PST 1,0/...-3,5 pin strip



Dimensional drawing

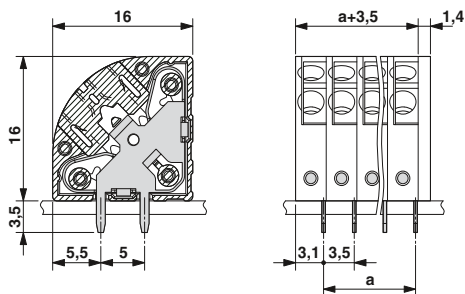

Dimensional drawing

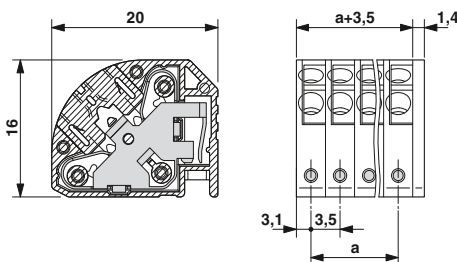

Drilling diagram

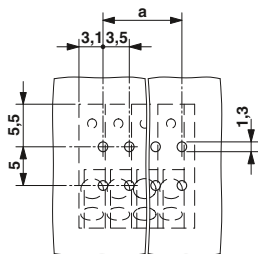

Ordering data

Type	Order No.	Pcs. / Pkt.
3.5 mm pitch, color: green		
PTDA 1,5/ 2-3,5	1724912	50
PTDA 1,5/ 3-3,5	1724925	50
PTDA 1,5/ 4-3,5	1724938	50
PTDA 1,5/ 5-3,5	1724951	50
PTDA 1,5/ 6-3,5	1724964	50
PTDA 1,5/ 7-3,5	1724977	50
PTDA 1,5/ 8-3,5	1724996	50
PTDA 1,5/ 9-3,5	1725003	50
PTDA 1,5/10-3,5	1725016	50
PTDA 1,5/11-3,5	1725029	50
PTDA 1,5/12-3,5	1725042	50
PTDA 1,5/13-3,5	1725055	50
PTDA 1,5/14-3,5	1725068	50
PTDA 1,5/15-3,5	1725081	50
PTDA 1,5/16-3,5	1725094	50

Ordering data

Type	Order No.	Pcs. / Pkt.
3.5 mm pitch, color: green		
PTDA 1,5/ 2-PH-3,5	1725107	250
PTDA 1,5/ 3-PH-3,5	1725120	250
PTDA 1,5/ 4-PH-3,5	1725133	250
PTDA 1,5/ 5-PH-3,5	1725146	100
PTDA 1,5/ 6-PH-3,5	1725159	100
PTDA 1,5/ 7-PH-3,5	1725172	100
PTDA 1,5/ 8-PH-3,5	1725185	100
PTDA 1,5/ 9-PH-3,5	1725198	100
PTDA 1,5/10-PH-3,5	1725211	100
PTDA 1,5/11-PH-3,5	1725224	50
PTDA 1,5/12-PH-3,5	1725237	50
PTDA 1,5/13-PH-3,5	1725250	50
PTDA 1,5/14-PH-3,5	1725263	50
PTDA 1,5/15-PH-3,5	1725276	50
PTDA 1,5/16-PH-3,5	1725289	50

PTDA series

Angled PCB terminals with spring-cage double connection up to 2 x 2.5 mm²

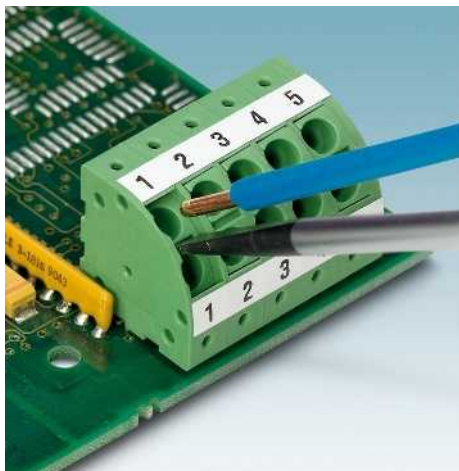

- Spring-cage double connection using direct plug-in method with a release button
- 5.0 mm pitch
- Large terminal block capacity with compact dimensions
- Optional color coding
- Plug with optional mechanical coding
- Attractive design for connection in the field of vision
- PCB terminal block and plug-in connector available

Notes:

In accordance with DIN EN 61984, COMBICON plug-in connectors have no switching power. During designated use, they must not be plugged in or disconnected when carrying voltage or under load.

COMBICON select

You will find the possible plug-in connector combinations in COMBICON select at: www.phoenixcontact.net/products or starting on page 388.

PTDA 2.5/...-PH-5,0 can be plugged onto the PST 1,3/...-5,0 pin strip, see page 434.

8 mm ferrules can be used.

Pitch spacers for the PTDA series are available on request. For further information, visit www.phoenixcontact.net/products.

¹⁾ Please observe the current carrying capacity curves. Further current carrying capacity curves on request.

Accessories

For all types	Type	Page
	Screwdriver SZF 1-0,6 x 3,5 Order No. 1204517	
	Coding profile CP-PTDA Order No. 1731361	38
	Marker cards SK 5/3,8	798
	Ferrules with and without plastic sleeve	834
	Crimping pliers for 0.25 to 6 mm ² CRIMPFOX 6 Order No. 1212034	

Representative derating curve

Type: PTDA 2,5/ 16-PH-5,0

Derating curve, determined as per DIN EN 61984 (VDE 0627):2002-09
Representation based on DIN EN 60512-5-2:2003-01
Reduction factor = 0.8
Conductor cross section: 2.5 mm²

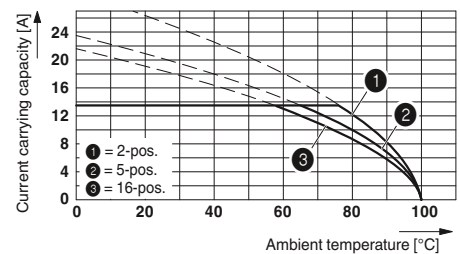

Technical data

Technical data in accordance to IEC / DIN VDE	
Rated current / conductor cross section	[A] / [mm ²]
Rated insulation voltage for pollution degree 2	[V]
Pitch	[mm]
Connection capacity	
Solid / stranded	[mm ²] / [mm ²] / AWG
Stranded with ferrules without plastic sleeve	[mm ²]
Stranded with ferrules with plastic sleeve	[mm ²]
Multi-conductor connection capacity (two conductors with the same cross section)	
Solid / stranded	[mm ²]
Stranded with ferrules without plastic sleeve	[mm ²]
Stranded with TWIN ferrule with plastic sleeve	[mm ²]
Insulation coordination	
Surge voltage category / pollution degree	
Rated insulation voltage	[V]
Rated surge voltage	[kV]
Approval data (UL/CUL)	Use Group
Nominal voltage	[V]
Nominal current	[A]
Connection capacity AWG	AWG
Approval data (CSA)	Use Group
Nominal voltage	[V]
Nominal current	[A]
Connection capacity AWG	AWG
General data	
Stripping length	[mm]
Type of insulation material / insulation material group	
Inflammability class according to UL 94	
Drill hole diameter / pin dimensions	[mm]

PTDA 2,5/ ...-5,0

PTDA 2,5/ ...-5,0			PTDA 2,5/ ...-PH-5,0		
24 ¹⁾ / 2.5			13.5 ¹⁾ / 2.5		
400			400		
5			5		
0.2 - 2.5 / 0.2 - 2.5 / 24 - 14			0.2 - 2.5 / 0.2 - 2.5 / 24 - 14		
0.5 - 2.5			0.5 - 2.5		
0.5 - 1			0.5 - 1		
0.2 - 2.5 / 0.2 - 2.5			0.2 - 2.5 / 0.2 - 2.5		
0.5 - 2.5			0.5 - 2.5		
0.5 - 1			0.5 - 1		
III / 3	III / 2	II / 2	III / 3	III / 2	II / 2
320	400	630	320	400	630
4	4	4	4	4	4
B	C	D	B	C	D
300	-	300	300	150	300
15	-	10	13.5	13.5	10
24 - 14	24 - 14	24 - 14	24 - 14	24 - 14	24 - 14
B	C	D	B	C	D
-	-	-	-	-	-
-	-	-	-	-	-
-	-	-	-	-	-
10			10		
PA / I			PA / I		
V0			V0		
1.3 / 1.0 x 0.4			- / -		

No. of pos.	Dim. a [mm]
2	5.00
3	10.00
4	15.00
5	20.00
6	25.00
7	30.00
8	35.00
9	40.00
10	45.00
11	50.00
12	55.00
13	60.00
14	65.00
15	70.00
16	75.00



PCB terminal block with spring-cage double connection



Plug component with spring-cage double connection, can be plugged onto PST 1,3/...-5,0 pin strip



Dimensional drawing

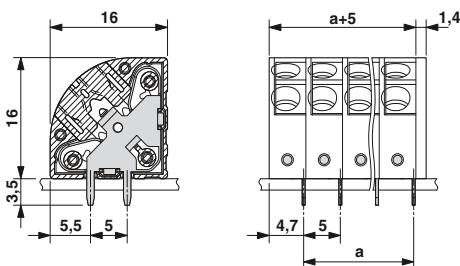

Dimensional drawing

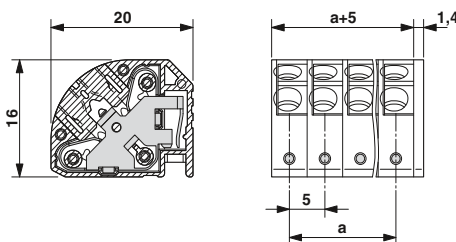

Drilling diagram

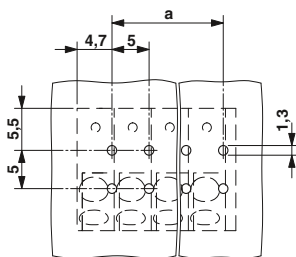

Ordering data

Type	Order No.	Pcs. / Pkt.
5.0 mm pitch, color: green		
PTDA 2,5/ 2-5,0	1725302	50
PTDA 2,5/ 3-5,0	1725315	50
PTDA 2,5/ 4-5,0	1725328	50
PTDA 2,5/ 5-5,0	1725341	50
PTDA 2,5/ 6-5,0	1725354	50
PTDA 2,5/ 7-5,0	1725367	50
PTDA 2,5/ 8-5,0	1725380	50
PTDA 2,5/ 9-5,0	1725393	50
PTDA 2,5/10-5,0	1725406	50
PTDA 2,5/11-5,0	1725419	50
PTDA 2,5/12-5,0	1725432	50
PTDA 2,5/13-5,0	1725445	50
PTDA 2,5/14-5,0	1725458	50
PTDA 2,5/15-5,0	1725471	50
PTDA 2,5/16-5,0	1725484	50

Ordering data

Type	Order No.	Pcs. / Pkt.
5.0 mm pitch, color: green		
PTDA 2,5/ 2-PH-5,0	1725497	250
PTDA 2,5/ 3-PH-5,0	1725510	250
PTDA 2,5/ 4-PH-5,0	1725523	250
PTDA 2,5/ 5-PH-5,0	1725536	100
PTDA 2,5/ 6-PH-5,0	1725549	100
PTDA 2,5/ 7-PH-5,0	1725623	100
PTDA 2,5/ 8-PH-5,0	1725636	100
PTDA 2,5/ 9-PH-5,0	1725649	100
PTDA 2,5/10-PH-5,0	1725652	100
PTDA 2,5/11-PH-5,0	1725665	50
PTDA 2,5/12-PH-5,0	1725678	50
PTDA 2,5/13-PH-5,0	1725640	50
PTDA 2,5/14-PH-5,0	1725653	50
PTDA 2,5/15-PH-5,0	1725666	50
PTDA 2,5/16-PH-5,0	1725679	50

PTSA series

Angled spring-cage PCB terminal blocks up to 0.5 mm²



- Compact type with simple operation and direct plug-in method
- 2.5 mm pitch
- Increase in the dielectric strength and the mechanical stability, thanks to zig-zag pinning. The pinning process always begins from the front right position. Special pinning available on request
- Color coding and mixed pitch as an option

Notes:

- 1) Please observe the current carrying capacity curves. Further current carrying capacity curves on request.
- 2) Only with pitch spacer.

Accessories

For all types	Type	Page
	Screwdriver SZF 0-0,4 x 2,5 Order No. 1204504	

Current carrying capacity curve

Type: PTSA 0,5/5-2,5-Z
Test following DIN EN 60512-5-2:2003-01
Reduction factor = 1
No. of positions: 5

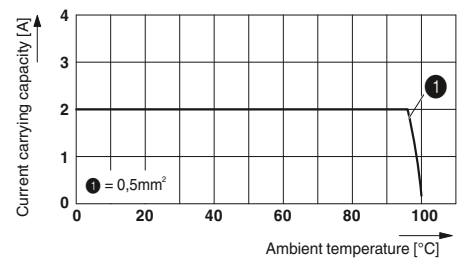

Technical data

Technical data in accordance to IEC / DIN VDE	
Rated current / conductor cross section	[A] / [mm ²]
Rated insulation voltage for pollution degree 2	[V]
Pitch	[mm]
Connection capacity	
Solid / stranded	[mm ²] / [mm ²] / AWG
Stranded with ferrules without plastic sleeve	[mm ²]
Stranded with ferrules with plastic sleeve	[mm ²]
Multi-conductor connection capacity (two conductors with the same cross section)	
Solid / stranded	[mm ²]
Stranded with ferrules without plastic sleeve	[mm ²]
Stranded with TWIN ferrule with plastic sleeve	[mm ²]
Insulation coordination	
Surge voltage category / pollution degree	
Rated insulation voltage	[V]
Rated surge voltage	[kV]
Approval data (UL/CUL)	Use Group
Nominal voltage	[V]
Nominal current	[A]
Connection capacity AWG	AWG
Approval data (CSA)	Use Group
Nominal voltage	[V]
Nominal current	[A]
Connection capacity AWG	AWG
General data	
Stripping length	[mm]
Type of insulation material / insulation material group	
Inflammability class according to UL 94	
Drill hole diameter / pin dimensions	[mm]

PTSA 0,5/ ...-2,5-Z

2 ¹⁾ / 0,5			2 ¹⁾ / 0,5		
250			250		
2.5			2.5		
0.14 - 0.5 / 0.2 - 0.5 / 24 - 20			0.14 - 0.5 / 0.2 - 0.5 / 24 - 20		
-			-		
-			-		
- / -			- / -		
-			-		
-			-		
III / 3	III / 2	II / 2	III / 3	III / 2	II / 2
160	250	400	63	250	250
2.5	2.5	2.5	2.5	2.5	2.5
B	C	D	B	C	D
300	-	300	150	-	300 ²⁾
2	-	2	2	-	2 ²⁾
26 - 20	-	26 - 20	26 - 20	-	26 - 20
B	C	D	B	C	D
-	-	-	-	-	-
-	-	-	-	-	-
-	-	-	-	-	-
9			9		
PA / I			PA / I		
V0			V0		
1 / 0.4 x 0.75			1 / 0.4 x 0.75		

PTSA 0,5/ ...-2,5-F

No. of pos.	Dim. a [mm]
2	2.50
3	5.00
4	7.50
5	10.00
6	12.50
7	15.00
8	17.50
9	20.00
10	22.50
11	25.00
12	27.50
13	30.00
14	32.50
15	35.00
16	37.50



PCB terminal blocks with 2.5 mm pitch and off-set solder pins

PCB terminal blocks with 2.5 mm pitch, solder pins at the front



Dimensional drawing

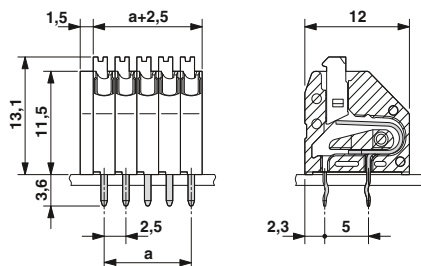

Dimensional drawing

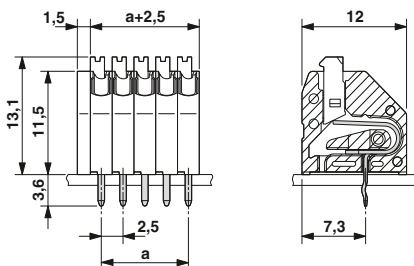

Drilling diagram

The zig-zag pinning starts at the right-hand position. Other pinning on request.

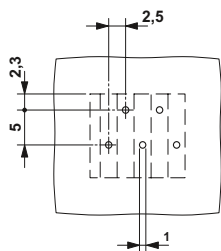

Drilling diagram

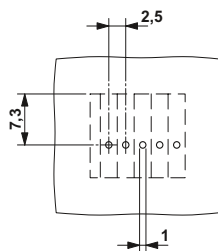

Ordering data

Type	Order No.	Pcs. / Pkt.
Pitch 2.5 mm, color: green		
PTSA 0,5/ 2-2,5-Z	1990009	250
PTSA 0,5/ 3-2,5-Z	1990012	250
PTSA 0,5/ 4-2,5-Z	1990025	250
PTSA 0,5/ 5-2,5-Z	1990038	100
PTSA 0,5/ 6-2,5-Z	1990041	100
PTSA 0,5/ 7-2,5-Z	1990054	100
PTSA 0,5/ 8-2,5-Z	1990067	100
PTSA 0,5/ 9-2,5-Z	1990070	100
PTSA 0,5/10-2,5-Z	1990083	100
PTSA 0,5/11-2,5-Z	1990096	50
PTSA 0,5/12-2,5-Z	1990106	50
PTSA 0,5/13-2,5-Z	1990119	50
PTSA 0,5/14-2,5-Z	1990122	50
PTSA 0,5/15-2,5-Z	1990135	50
PTSA 0,5/16-2,5-Z	1990148	50

Ordering data

Type	Order No.	Pcs. / Pkt.
Pitch 2.5 mm, color: green		
PTSA 0,5/ 2-2,5-F	1989748	250
PTSA 0,5/ 3-2,5-F	1989751	250
PTSA 0,5/ 4-2,5-F	1989764	250
PTSA 0,5/ 5-2,5-F	1989777	100
PTSA 0,5/ 6-2,5-F	1989780	100
PTSA 0,5/ 7-2,5-F	1989793	100
PTSA 0,5/ 8-2,5-F	1989803	100
PTSA 0,5/ 9-2,5-F	1989816	100
PTSA 0,5/10-2,5-F	1989829	100
PTSA 0,5/11-2,5-F	1989832	50
PTSA 0,5/12-2,5-F	1989845	50
PTSA 0,5/13-2,5-F	1989858	50
PTSA 0,5/14-2,5-F	1989861	50
PTSA 0,5/15-2,5-F	1989874	50
PTSA 0,5/16-2,5-F	1989887	50

PTSA series

Angled spring-cage PCB terminal blocks up to 1.5 mm²

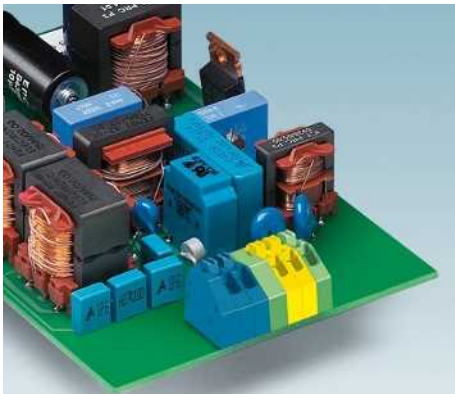



- Compact type with simple operation and direct plug-in method
- Pitch 3.5 mm
- Increase in the dielectric strength and the mechanical stability, thanks to zig-zag pinning. The pinning process always begins from the front right position. Special pinning available on request
- Color coding and mixed pitch as an option

Notes:

1) Please observe the current carrying capacity curves. Further current carrying capacity curves on request.

Accessories

For all types	Type	Page
	Screwdriver SZF 0-0,4 x 2,5 Order No. 1204504	
	Ferrules with and without plastic sleeve	834
	Crimping pliers for 0.25 to 6 mm ² CRIMPFOX 6 Order No. 1212034	

Current carrying capacity curve

Type: PTSA 1,5/5-3,5-Z
Test following DIN EN 60512-5-2:2003-01
Reduction factor = 1
No. of positions: 5

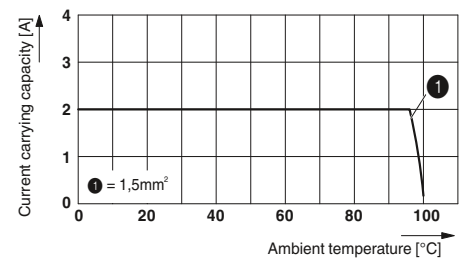

Technical data

Technical data in accordance to IEC / DIN VDE	
Rated current / conductor cross section	[A] / [mm ²]
Rated insulation voltage for pollution degree 2	[V]
Pitch	[mm]
Connection capacity	
Solid / stranded	[mm ²] / [mm ²] / AWG
Stranded with ferrules without plastic sleeve	[mm ²]
Stranded with ferrules with plastic sleeve	[mm ²]
Multi-conductor connection capacity (two conductors with the same cross section)	
Solid / stranded	[mm ²]
Stranded with ferrules without plastic sleeve	[mm ²]
Stranded with TWIN ferrule with plastic sleeve	[mm ²]
Insulation coordination	
Surge voltage category / pollution degree	
Rated insulation voltage	[V]
Rated surge voltage	[kV]
Approval data (UL/CUL)	Use Group
Nominal voltage	[V]
Nominal current	[A]
Connection capacity AWG	AWG
Approval data (CSA)	Use Group
Nominal voltage	[V]
Nominal current	[A]
Connection capacity AWG	AWG
General data	
Stripping length	[mm]
Type of insulation material / insulation material group	
Inflammability class according to UL 94	
Drill hole diameter / pin dimensions	[mm]

PTSA 1,5/ ...-3,5-Z

Rated current / conductor cross section			2 ¹⁾ / 1.5
Rated insulation voltage for pollution degree 2			400
Pitch			3.5
Connection capacity			
Solid / stranded			0.5 - 1.5 / 0.5 - 1.5 / 20 - 16
Stranded with ferrules without plastic sleeve			0.5 - 1
Stranded with ferrules with plastic sleeve			0.5 - 0.5
Multi-conductor connection capacity (two conductors with the same cross section)			
Solid / stranded			- / -
Stranded with ferrules without plastic sleeve			-
Stranded with TWIN ferrule with plastic sleeve			-
Insulation coordination			
Surge voltage category / pollution degree	III / 3	III / 2	II / 2
Rated insulation voltage	250	400	630
Rated surge voltage	4	4	4
Approval data (UL/CUL)	B	C	D
Nominal voltage	300	-	300
Nominal current	2	-	2
Connection capacity AWG	24 - 16	-	24 - 16
Approval data (CSA)	B	C	D
Nominal voltage	-	-	-
Nominal current	-	-	-
Connection capacity AWG	-	-	-
General data			
Stripping length	9		
Type of insulation material / insulation material group	PA / I		
Inflammability class according to UL 94	V0		
Drill hole diameter / pin dimensions	1 / 0.4 x 0.75 mm		

PTSA 1,5/ ...-3,5-F

Rated current / conductor cross section			2 ¹⁾ / 1.5
Rated insulation voltage for pollution degree 2			250
Pitch			3.5
Connection capacity			
Solid / stranded			0.5 - 1.5 / 0.5 - 1.5 / 20 - 16
Stranded with ferrules without plastic sleeve			0.5 - 1
Stranded with ferrules with plastic sleeve			0.5 - 0.5
Multi-conductor connection capacity (two conductors with the same cross section)			
Solid / stranded			- / -
Stranded with ferrules without plastic sleeve			-
Stranded with TWIN ferrule with plastic sleeve			-
Insulation coordination			
Surge voltage category / pollution degree	III / 3	III / 2	II / 2
Rated insulation voltage	200	250	400
Rated surge voltage	2.5	2.5	2.5
Approval data (UL/CUL)	B	C	D
Nominal voltage	300	-	300
Nominal current	2	-	2
Connection capacity AWG	24 - 16	-	24 - 16
Approval data (CSA)	B	C	D
Nominal voltage	-	-	-
Nominal current	-	-	-
Connection capacity AWG	-	-	-
General data			
Stripping length	9		
Type of insulation material / insulation material group	PA / I		
Inflammability class according to UL 94	V0		
Drill hole diameter / pin dimensions	1 / 0.4 x 0.75 mm		

No. of pos.	Dim. a [mm]
2	3.50
3	7.00
4	10.50
5	14.00
6	17.50
7	21.00
8	24.50
9	28.00
10	31.50
11	35.00
12	38.50
13	42.00
14	45.50
15	49.00
16	52.50



PCB terminal blocks with 3.5 mm pitch and off-set solder pins

PCB terminal blocks with 3.5 mm pitch, solder pins at the front



Dimensional drawing

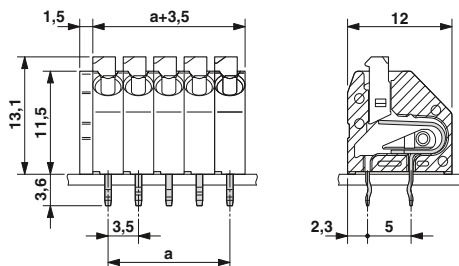

Dimensional drawing

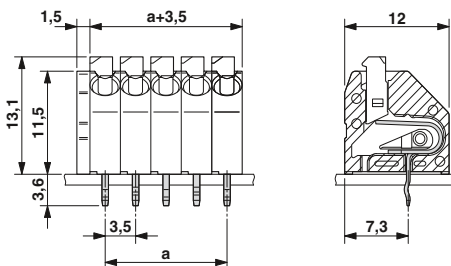

Drilling diagram

The zig-zag pinning starts at the right-hand position. Other pinning on request.

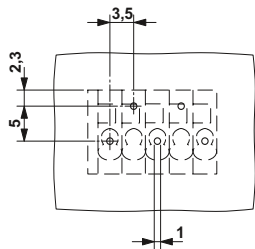

Drilling diagram

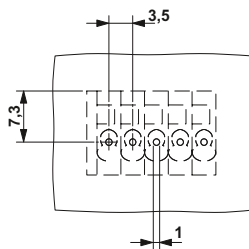

Ordering data

Type	Order No.	Pcs. / Pkt.
3.5 mm pitch, color: green		
PTSA 1,5/ 2-3,5-Z	1985195	250
PTSA 1,5/ 3-3,5-Z	1985205	250
PTSA 1,5/ 4-3,5-Z	1985218	250
PTSA 1,5/ 5-3,5-Z	1985221	100
PTSA 1,5/ 6-3,5-Z	1985234	100
PTSA 1,5/ 7-3,5-Z	1985247	100
PTSA 1,5/ 8-3,5-Z	1985250	100
PTSA 1,5/ 9-3,5-Z	1985263	100
PTSA 1,5/10-3,5-Z	1985276	100
PTSA 1,5/11-3,5-Z	1985289	50
PTSA 1,5/12-3,5-Z	1985292	50
PTSA 1,5/13-3,5-Z	1985302	50
PTSA 1,5/14-3,5-Z	1985315	50
PTSA 1,5/15-3,5-Z	1985328	50
PTSA 1,5/16-3,5-Z	1985331	50

Ordering data

Type	Order No.	Pcs. / Pkt.
3.5 mm pitch, color: green		
PTSA 1,5/ 2-3,5-F	1984963	250
PTSA 1,5/ 3-3,5-F	1984976	250
PTSA 1,5/ 4-3,5-F	1984989	250
PTSA 1,5/ 5-3,5-F	1984992	100
PTSA 1,5/ 6-3,5-F	1985001	100
PTSA 1,5/ 7-3,5-F	1985014	100
PTSA 1,5/ 8-3,5-F	1985027	100
PTSA 1,5/ 9-3,5-F	1985030	100
PTSA 1,5/10-3,5-F	1985043	100
PTSA 1,5/11-3,5-F	1985056	50
PTSA 1,5/12-3,5-F	1985069	50
PTSA 1,5/13-3,5-F	1985072	50
PTSA 1,5/14-3,5-F	1985085	50
PTSA 1,5/15-3,5-F	1985098	50
PTSA 1,5/16-3,5-F	1985108	50

PTS series

Horizontal PCB terminal block for conductor cross sections of up to 2.5 mm²

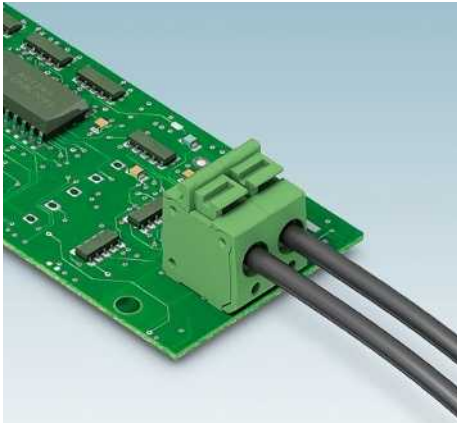

- Conductor connection with direct plug-in method
- 5.0 mm pitch
- 7.5 mm pitch available on request
- Conductor cross section up to 2.5 mm²
- Finger-operated release button
- Test connection
- Compact design



Notes:

A load current of 16 A is possible for a cable cross section of 2.5 mm².

1) For 2.5 mm² solid conductor type, please observe the installation note in the data sheet.

2) Please observe derating curve.

Accessories

For all types	Type	Page
	Screwdriver SZF 0-0,4 x 2,5 Order No. 1204504	
	Ferrules with and without plastic sleeve	834
	Crimping pliers for 0.25 to 6 mm ² CRIMPFOX 6 Order No. 1212034	

Current carrying capacity curve

Type: PTS 1,5/5-5,0-H

Tested in accordance with DIN EN 60512-5-2:2003-01

Reduction factor = 1

No. of positions: 5

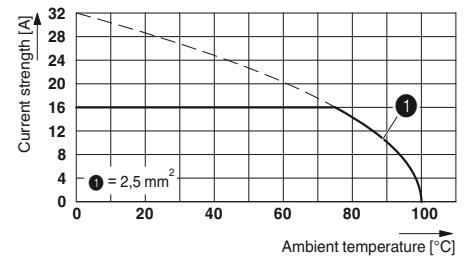

Technical data

Technical data in accordance to IEC / DIN VDE	
Rated current / conductor cross section	[A] / [mm ²]
Rated insulation voltage for pollution degree 2	[V]
Pitch	[mm]
Solid / stranded	[mm ²] / [mm ²] / AWG
Stranded with ferrules without plastic sleeve	[mm ²]
Stranded with ferrules with plastic sleeve	[mm ²]
Multi-conductor connection capacity (two conductors with the same cross section)	
Solid / stranded	[mm ²]
Stranded with ferrules without plastic sleeve	[mm ²]
Stranded with TWIN ferrule with plastic sleeve	[mm ²]
Insulation coordination	
Surge voltage category / pollution degree	
Rated insulation voltage	[V]
Rated surge voltage	[kV]
Approval data (UL/CUL)	Use Group
Nominal voltage	[V]
Nominal current	[A]
Connection capacity AWG	AWG
Approval data (CSA)	Use Group
Nominal voltage	[V]
Nominal current	[A]
Connection capacity AWG	AWG
General data	
Stripping length	[mm]
Type of insulation material / insulation material group	
Inflammability class according to UL 94	
Drill hole diameter / pin dimensions	[mm]

PTS 1,5/ ...-5,0-H

12 ²) / 2,5 ¹)			12 ²) / 2,5 ¹)		
400			630		
5			7,5		
0.14 - 2.5 ¹) / 0.14 - 2.5 / 26 - 14			0.14 - 2.5 ¹) / 0.14 - 2.5 / 26 - 14		
0.25 - 1.5			0.25 - 1.5		
0.25 - 1.5			0.25 - 1.5		
- / -			- / -		
-			-		
-			-		
III / 3	III / 2	II / 2	III / 3	III / 2	II / 2
250	400	630	400	630	1000
4	4	4	6	6	6
B	C	D	B	C	D
300	-	300	300	-	300
10	-	10	10	-	10
26 - 14	-	26 - 14	26 - 14	-	26 - 14
B	C	D	B	C	D
-	-	-	-	-	-
-	-	-	-	-	-
-	-	-	-	-	-
8			8		
PA / I			PA / I		
V0			V0		
1.2 / 0.83 x 0.5 mm			1.2 / 0.83 x 0.5 mm		

No. of pos.	Dim. a [mm]
2	5.00
3	10.00
4	15.00
5	20.00
6	25.00
7	30.00
8	35.00
9	40.00
10	45.00
11	50.00
12	55.00
2	7.50
3	15.00
4	22.50
5	30.00
6	37.50
7	45.00
8	52.50
9	60.00
10	67.50
11	75.00
12	82.50



Spring-cage PCB terminal block, 5.0 mm pitch

Spring-cage PCB terminal block, 7.5 mm pitch



Dimensional drawing

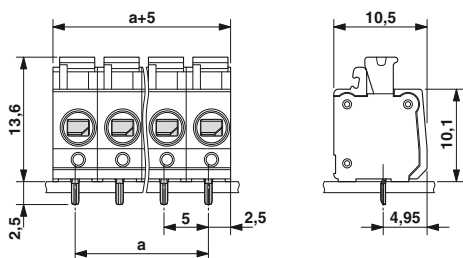

Dimensional drawing

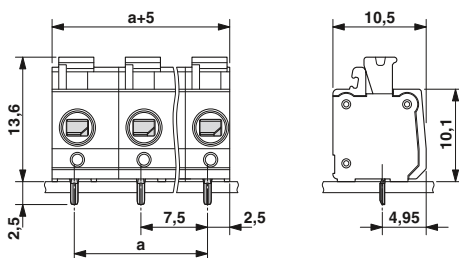

Drilling diagram

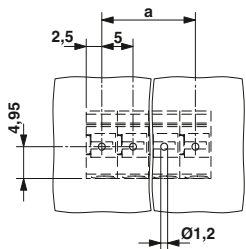

Drilling diagram

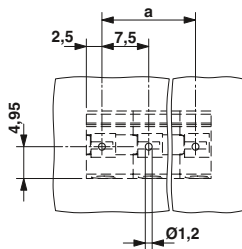

Ordering data

Type	Order No.	Pcs. / Pkt.
5.0 mm pitch, color: green		
PTS 1,5/ 2-5,0-H	1792863	250
PTS 1,5/ 3-5,0-H	1792876	250
PTS 1,5/ 4-5,0-H	1792889	250
PTS 1,5/ 5-5,0-H	1792892	100
PTS 1,5/ 6-5,0-H	1792902	100
PTS 1,5/ 7-5,0-H	1792915	100
PTS 1,5/ 8-5,0-H	1792928	100
PTS 1,5/ 9-5,0-H	1792931	100
PTS 1,5/10-5,0-H	1792944	100
PTS 1,5/11-5,0-H	1792957	50
PTS 1,5/12-5,0-H	1792960	50

Ordering data

Type	Order No.	Pcs. / Pkt.
7.5 mm pitch, color: green		
PTS 1,5/ 2-7,5-H	1703083	250
PTS 1,5/ 3-7,5-H	1703084	250
PTS 1,5/ 4-7,5-H	1703086	250
PTS 1,5/ 5-7,5-H	1703087	100
PTS 1,5/ 6-7,5-H	1703088	100
PTS 1,5/ 7-7,5-H	1703090	100
PTS 1,5/ 8-7,5-H	1703091	100
PTS 1,5/ 9-7,5-H	1703093	100
PTS 1,5/10-7,5-H	1703094	100
PTS 1,5/11-7,5-H	1703095	50
PTS 1,5/12-7,5-H	1703096	50



Spring-cage connector, can be plugged into PST 1,3/...-5,0 and PST 1,3/...-5,0-SF pin strips

Pin strip with snap-lock fitting

Dimensional drawing

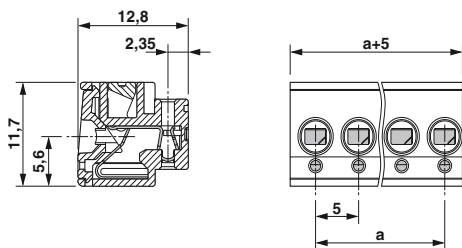

Dimensional drawing

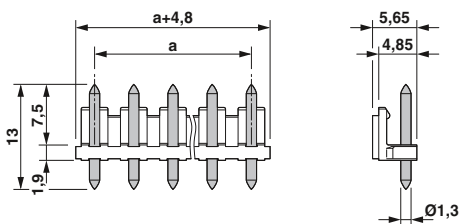

Drilling diagram

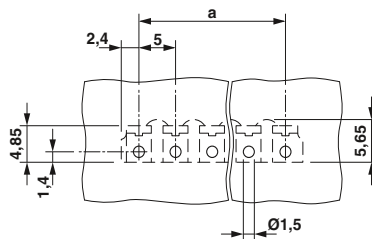

Ordering data

Type	Order No.	Pcs. / Pkt.
5.0 mm pitch, color: green		
PTS 1,5/ 2-PH-5,0	1805517	250
PTS 1,5/ 3-PH-5,0	1805520	250
PTS 1,5/ 4-PH-5,0	1805533	250
PTS 1,5/ 5-PH-5,0	1805546	100
PTS 1,5/ 6-PH-5,0	1805559	100
PTS 1,5/ 7-PH-5,0	1805562	100
PTS 1,5/ 8-PH-5,0	1805575	100
PTS 1,5/ 9-PH-5,0	1805588	100
PTS 1,5/10-PH-5,0	1805591	100
PTS 1,5/11-PH-5,0	1805601	50
PTS 1,5/12-PH-5,0	1805614	50

Ordering data

Type	Order No.	Pcs. / Pkt.
Pitch 5.0 mm, color: Black		
PST 1,3/ 2-5,0-SF	1805627	250
PST 1,3/ 3-5,0-SF	1805630	250
PST 1,3/ 4-5,0-SF	1805643	250
PST 1,3/ 5-5,0-SF	1805656	100
PST 1,3/ 6-5,0-SF	1805669	100
PST 1,3/ 7-5,0-SF	1805672	100
PST 1,3/ 8-5,0-SF	1805685	100

PCB terminal blocks with a screw connection up to 1.5 mm²

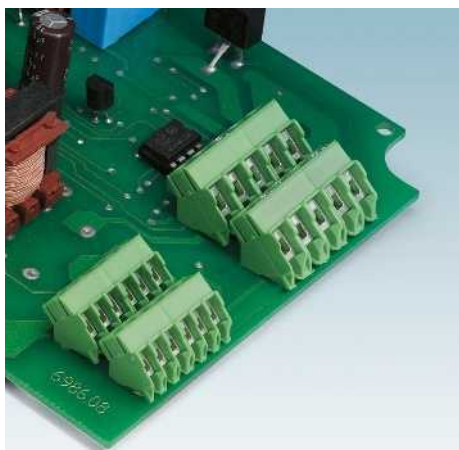

- High terminal block capacity, thanks to rectangular terminal block space
- Pitch 3.5 mm
- Highly flexible conductor protection for easy, repeated connecting
- Rugged design with high current carrying capacity
- Plus/minus screw

Notes:

- 1) Please observe the current carrying capacity curves. Further current carrying capacity curves on request.
- 2) When using ferrules, max. 125 V are only achieved in combination with surge voltage category/pollution degree II/2.

Accessories

For all types	Type	Page
	Marker cards SK 3,5/2,8	797
	Screwdriver SZS 0,4 x 2,5 Order No. 1205037	

Current carrying capacity curve

Type: PTA 1,5/5-3,5
Test following DIN EN 60512-5-2:2003-01
Reduction factor = 1
No. of positions: 5

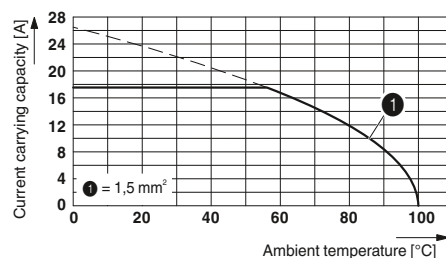

Technical data

Technical data in accordance to IEC / DIN VDE

Rated current / conductor cross section	[A] / [mm ²]
Rated insulation voltage for pollution degree 2	[V]
Pitch	[mm]
Connection capacity	
Solid / stranded	[mm ²] / [mm ²] / AWG
Stranded with ferrules without plastic sleeve	[mm ²]
Stranded with ferrules with plastic sleeve	[mm ²]
Multi-conductor connection capacity (two conductors with the same cross section)	
Solid / stranded	[mm ²]
Stranded with ferrules without plastic sleeve	[mm ²]
Stranded with TWIN ferrule with plastic sleeve	[mm ²]
Insulation coordination	
Surge voltage category / pollution degree	
Rated insulation voltage	[V]
Rated surge voltage	[kV]
Approval data (UL/CUL)	Use Group
Nominal voltage	[V]
Nominal current	[A]
Connection capacity AWG	AWG
Approval data (CSA)	Use Group
Nominal voltage	[V]
Nominal current	[A]
Connection capacity AWG	AWG
General data	
Stripping length	[mm]
Screw thread	
Tightening torque	[Nm]
Type of insulation material / insulation material group	
Inflammability class according to UL 94	
Drill hole diameter / pin dimensions	[mm]

PT 1,5/ ...-3,5-H

Rated current / conductor cross section	17.5 ¹⁾ / 1.5
Rated insulation voltage for pollution degree 2	200
Pitch	3.5
Connection capacity	
Solid / stranded	0.2 - 1.5 / 0.2 - 1.5 / 26 - 16
Stranded with ferrules without plastic sleeve	-
Stranded with ferrules with plastic sleeve	0.25 - 0.75 ²⁾
Multi-conductor connection capacity (two conductors with the same cross section)	
Solid / stranded	0.2 - 0.34 / 0.2 - 0.5
Stranded with ferrules without plastic sleeve	-
Stranded with TWIN ferrule with plastic sleeve	-
Insulation coordination	
Surge voltage category / pollution degree	III / 3 III / 2 II / 2
Rated insulation voltage	160 200 400
Rated surge voltage	2.5 2.5 2.5
Approval data (UL/CUL)	B C D
Nominal voltage	300 - 300
Nominal current	10 - 10
Connection capacity AWG	26 - 16 - 26 - 16
Approval data (CSA)	B C D
Nominal voltage	- - -
Nominal current	- - -
Connection capacity AWG	- - -
General data	
Stripping length	5
Screw thread	M2
Tightening torque	0.22 - 0.25
Type of insulation material / insulation material group	PA / I
Inflammability class according to UL 94	V0
Drill hole diameter / pin dimensions	1.2 / 0.9 mm

PT 1,5/ ...-3,5-V

Rated current / conductor cross section	17.5 ¹⁾ / 1.5
Rated insulation voltage for pollution degree 2	200
Pitch	3.5
Connection capacity	
Solid / stranded	0.2 - 1.5 / 0.2 - 1.5 / 26 - 16
Stranded with ferrules without plastic sleeve	-
Stranded with ferrules with plastic sleeve	0.25 - 0.75 ²⁾
Multi-conductor connection capacity (two conductors with the same cross section)	
Solid / stranded	0.2 - 0.34 / 0.2 - 0.5
Stranded with ferrules without plastic sleeve	-
Stranded with TWIN ferrule with plastic sleeve	-
Insulation coordination	
Surge voltage category / pollution degree	III / 3 III / 2 II / 2
Rated insulation voltage	160 200 400
Rated surge voltage	2.5 2.5 2.5
Approval data (UL/CUL)	B C D
Nominal voltage	300 - 300
Nominal current	10 - 10
Connection capacity AWG	26 - 16 - 26 - 16
Approval data (CSA)	B C D
Nominal voltage	- - -
Nominal current	- - -
Connection capacity AWG	- - -
General data	
Stripping length	5
Screw thread	M2
Tightening torque	0.22 - 0.25
Type of insulation material / insulation material group	PA / I
Inflammability class according to UL 94	V0
Drill hole diameter / pin dimensions	1.2 / 0.9 mm

PTA 1,5/ ...-3,5

Rated current / conductor cross section	17.5 ¹⁾ / 1.5
Rated insulation voltage for pollution degree 2	200
Pitch	3.5
Connection capacity	
Solid / stranded	0.14 - 1.5 / 0.14 - 1.5 / 26 - 16
Stranded with ferrules without plastic sleeve	-
Stranded with ferrules with plastic sleeve	0.25 - 0.75 ²⁾
Multi-conductor connection capacity (two conductors with the same cross section)	
Solid / stranded	0.14 - 0.5 / 0.14 - 0.5
Stranded with ferrules without plastic sleeve	-
Stranded with TWIN ferrule with plastic sleeve	-
Insulation coordination	
Surge voltage category / pollution degree	III / 3 III / 2 II / 2
Rated insulation voltage	160 200 400
Rated surge voltage	2.5 2.5 2.5
Approval data (UL/CUL)	B C D
Nominal voltage	300 - 300
Nominal current	10 - 10
Connection capacity AWG	26 - 16 - 26 - 16
Approval data (CSA)	B C D
Nominal voltage	- - -
Nominal current	- - -
Connection capacity AWG	- - -
General data	
Stripping length	5
Screw thread	M2
Tightening torque	0.22 - 0.25
Type of insulation material / insulation material group	PA / I
Inflammability class according to UL 94	V0
Drill hole diameter / pin dimensions	1.2 / 0.9 mm

No. of pos.	Dim. a [mm]
2	3.50
3	7.00
4	10.50
5	14.00
6	17.50
7	21.00
8	24.50
9	28.00
10	31.50
11	35.00
12	38.50
13	42.00
14	45.50
15	49.00
16	52.50



PCB terminal block, connection direction horizontal to the PCB



PCB terminal block, connection direction vertical to the PCB

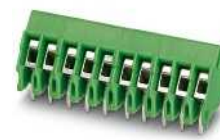

PCB terminal block with 45° angled connection



Dimensional drawing

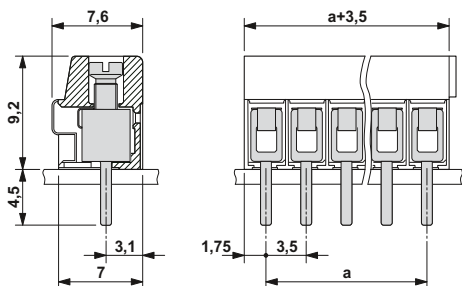

Drilling diagram

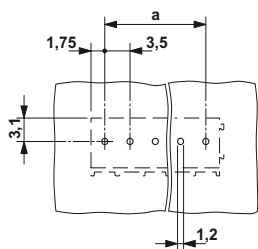

Ordering data

Type	Order No.	Pcs. / Pkt.
3.5 mm pitch, color: green		
PT 1,5/ 2-3,5-H	1984617	250
PT 1,5/ 3-3,5-H	1984620	250
PT 1,5/ 4-3,5-H	1984633	250
PT 1,5/ 5-3,5-H	1984646	100
PT 1,5/ 6-3,5-H	1984659	100
PT 1,5/ 7-3,5-H	1984662	100
PT 1,5/ 8-3,5-H	1984675	100
PT 1,5/ 9-3,5-H	1984688	100
PT 1,5/10-3,5-H	1984691	100
PT 1,5/11-3,5-H	1984701	50
PT 1,5/12-3,5-H	1984714	50
PT 1,5/13-3,5-H	1984727	50
PT 1,5/14-3,5-H	1984730	50
PT 1,5/15-3,5-H	1984743	50
PT 1,5/16-3,5-H	1984756	50



Dimensional drawing

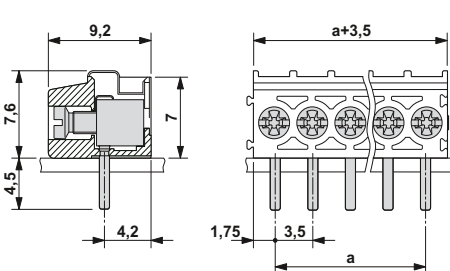

Drilling diagram

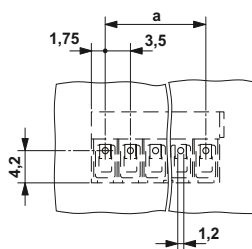

Ordering data

Type	Order No.	Pcs. / Pkt.
3.5 mm pitch, color: green		
PT 1,5/ 2-3,5-V	1984769	250
PT 1,5/ 3-3,5-V	1984772	250
PT 1,5/ 4-3,5-V	1984785	250
PT 1,5/ 5-3,5-V	1984798	100
PT 1,5/ 6-3,5-V	1984808	100
PT 1,5/ 7-3,5-V	1984811	100
PT 1,5/ 8-3,5-V	1984824	100
PT 1,5/ 9-3,5-V	1984837	100
PT 1,5/10-3,5-V	1984840	100
PT 1,5/11-3,5-V	1984853	50
PT 1,5/12-3,5-V	1984866	50
PT 1,5/13-3,5-V	1984879	50
PT 1,5/14-3,5-V	1984882	50
PT 1,5/15-3,5-V	1984895	50
PT 1,5/16-3,5-V	1984905	50



Dimensional drawing

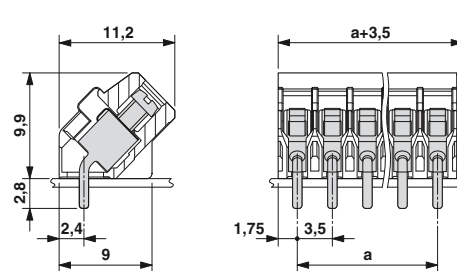

Drilling diagram

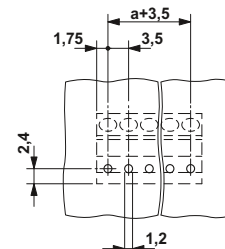

Ordering data

Type	Order No.	Pcs. / Pkt.
3.5 mm pitch, color: green		
PTA 1,5/ 2-3,5	1988956	250
PTA 1,5/ 3-3,5	1988969	250
PTA 1,5/ 4-3,5	1988972	250
PTA 1,5/ 5-3,5	1988985	100
PTA 1,5/ 6-3,5	1988998	100
PTA 1,5/ 7-3,5	1989007	100
PTA 1,5/ 8-3,5	1989010	100
PTA 1,5/ 9-3,5	1989023	100
PTA 1,5/10-3,5	1989036	100
PTA 1,5/11-3,5	1989049	50
PTA 1,5/12-3,5	1989052	50
PTA 1,5/13-3,5	1989065	50
PTA 1,5/14-3,5	1989078	50
PTA 1,5/15-3,5	1989081	50
PTA 1,5/16-3,5	1989094	50

PCB terminal blocks with a screw connection up to 2.5 mm²



- High terminal block capacity, thanks to rectangular terminal block space
- 5.0 mm pitch
- Highly flexible conductor protection for easy, repeated connecting
- Rugged design with high current carrying capacity
- Plus/minus screw

Notes:

- 1) Please observe the current carrying capacity curves. Further current carrying capacity curves on request.
- 2) When using ferrules, 250 V are only achieved in combination with surge voltage category/pollution degree II/2.

Accessories

For all types	Type	Page
	Marker cards SK 5/3,8	798
	Screwdriver SZS 0,6 x 3,5 Order No. 1205053	

Current carrying capacity curve

Type: PT 1,5/5-5,0-H
Test following DIN EN 60512-5-2:2003-01
Reduction factor = 1
No. of positions: 5

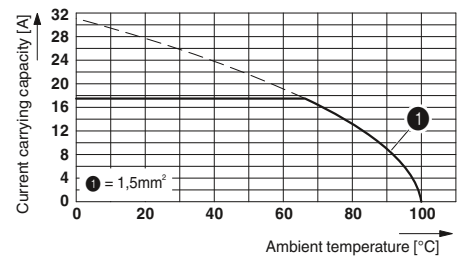

Technical data

Technical data in accordance to IEC / DIN VDE	
Rated current / conductor cross section	[A] / [mm ²]
Rated insulation voltage for pollution degree 2	[V]
Pitch	[mm]
Connection capacity	
Solid / stranded	[mm ²] / [mm ²] / AWG
Stranded with ferrules without plastic sleeve	[mm ²]
Stranded with ferrules with plastic sleeve	[mm ²]
Multi-conductor connection capacity (two conductors with the same cross section)	
Solid / stranded	[mm ²]
Stranded with ferrules without plastic sleeve	[mm ²]
Stranded with TWIN ferrule with plastic sleeve	[mm ²]
Insulation coordination	
Surge voltage category / pollution degree	
Rated insulation voltage	[V]
Rated surge voltage	[kV]
Approval data (UL/CUL)	Use Group
Nominal voltage	[V]
Nominal current	[A]
Connection capacity AWG	AWG
Approval data (CSA)	Use Group
Nominal voltage	[V]
Nominal current	[A]
Connection capacity AWG	AWG
General data	
Stripping length	[mm]
Screw thread	
Tightening torque	[Nm]
Type of insulation material / insulation material group	
Inflammability class according to UL 94	
Drill hole diameter / pin dimensions	[mm]

PT 1,5/ ...-5,0-H

Rated current / conductor cross section			17.5 ¹⁾ / 2.5		
Rated insulation voltage for pollution degree 2			400		
Pitch			5		
Connection capacity					
Solid / stranded			0.2 - 2.5 / 0.2 - 2.5 / 26 - 14		
Stranded with ferrules without plastic sleeve			0.25 - 1.5 ²⁾		
Stranded with ferrules with plastic sleeve			0.25 - 1.5 ²⁾		
Multi-conductor connection capacity (two conductors with the same cross section)					
Solid / stranded			0.2 - 0.75 / 0.2 - 0.75		
Stranded with ferrules without plastic sleeve			0.25 - 0.34 ²⁾		
Stranded with TWIN ferrule with plastic sleeve			0.5 - 0.75 ²⁾		
Insulation coordination					
Surge voltage category / pollution degree			III / 3 III / 2 II / 2		
Rated insulation voltage			250 400 630		
Rated surge voltage			4 4 4		
Approval data (UL/CUL)			B C D		
Nominal voltage			300 - 300		
Nominal current			18 - 10		
Connection capacity AWG			26 - 12 - 26 - 12		
Approval data (CSA)			B C D		
Nominal voltage			- - -		
Nominal current			- - -		
Connection capacity AWG			- - -		
General data					
Stripping length			5		
Screw thread			M2,6		
Tightening torque			0.35 - 0.4		
Type of insulation material / insulation material group			PA / I		
Inflammability class according to UL 94			V0		
Drill hole diameter / pin dimensions			1.3 / 1.0 mm		

PT 1,5/ ...-5,0-V

Rated current / conductor cross section			17.5 ¹⁾ / 2.5		
Rated insulation voltage for pollution degree 2			400		
Pitch			5		
Connection capacity					
Solid / stranded			0.2 - 2.5 / 0.2 - 2.5 / 26 - 14		
Stranded with ferrules without plastic sleeve			0.25 - 1.5 ²⁾		
Stranded with ferrules with plastic sleeve			0.25 - 1.5 ²⁾		
Multi-conductor connection capacity (two conductors with the same cross section)					
Solid / stranded			0.2 - 0.75 / 0.2 - 0.75		
Stranded with ferrules without plastic sleeve			0.25 - 0.34 ²⁾		
Stranded with TWIN ferrule with plastic sleeve			0.5 - 0.75 ²⁾		
Insulation coordination					
Surge voltage category / pollution degree			III / 3 III / 2 II / 2		
Rated insulation voltage			250 400 630		
Rated surge voltage			4 4 4		
Approval data (UL/CUL)			B C D		
Nominal voltage			300 - 300		
Nominal current			18 - 10		
Connection capacity AWG			26 - 12 - 26 - 12		
Approval data (CSA)			B C D		
Nominal voltage			- - -		
Nominal current			- - -		
Connection capacity AWG			- - -		
General data					
Stripping length			5		
Screw thread			M2,6		
Tightening torque			0.35 - 0.4		
Type of insulation material / insulation material group			PA / I		
Inflammability class according to UL 94			V0		
Drill hole diameter / pin dimensions			1.3 / 1.0 mm		

PTA 1,5/ ...-5,0

Rated current / conductor cross section			17.5 ¹⁾ / 2.5		
Rated insulation voltage for pollution degree 2			400		
Pitch			5		
Connection capacity					
Solid / stranded			0.14 - 2.5 / 0.14 - 2.5 / 26 - 14		
Stranded with ferrules without plastic sleeve			0.25 - 1.5 ²⁾		
Stranded with ferrules with plastic sleeve			0.25 - 1.5 ²⁾		
Multi-conductor connection capacity (two conductors with the same cross section)					
Solid / stranded			0.14 - 1 / 0.14 - 0.75		
Stranded with ferrules without plastic sleeve			0.25 - 0.34 ²⁾		
Stranded with TWIN ferrule with plastic sleeve			0.25 - 0.75 ²⁾		
Insulation coordination					
Surge voltage category / pollution degree			III / 3 III / 2 II / 2		
Rated insulation voltage			250 400 630		
Rated surge voltage			4 4 4		
Approval data (UL/CUL)			B C D		
Nominal voltage			300 - 300		
Nominal current			15 - 10		
Connection capacity AWG			26 - 12 - 26 - 12		
Approval data (CSA)			B C D		
Nominal voltage			- - -		
Nominal current			- - -		
Connection capacity AWG			- - -		
General data					
Stripping length			5		
Screw thread			M2,6		
Tightening torque			0.35 - 0.4		
Type of insulation material / insulation material group			PA / I		
Inflammability class according to UL 94			V0		
Drill hole diameter / pin dimensions			1.3 / 1.0 mm		

No. of pos.	Dim. a [mm]
2	5.00
3	10.00
4	15.00
5	20.00
6	25.00
7	30.00
8	35.00
9	40.00
10	45.00
11	50.00
12	55.00
13	60.00
14	65.00
15	70.00
16	75.00



PCB terminal block, connection direction horizontal to the PCB

PCB terminal block, connection direction vertical to the PCB

PCB terminal block with 45° angled connection



Dimensional drawing

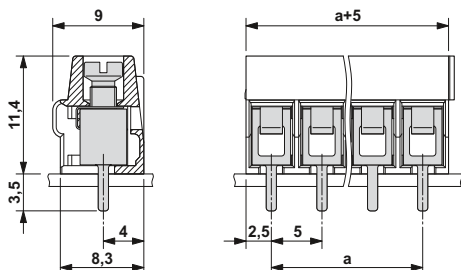

Drilling diagram

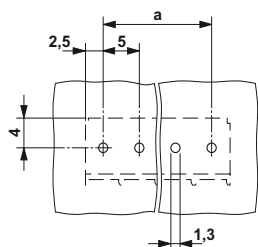

Dimensional drawing

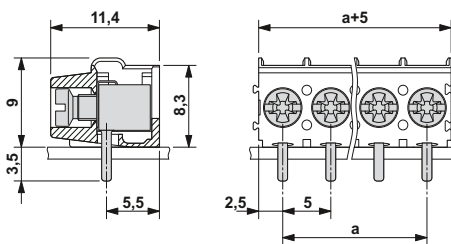

Drilling diagram

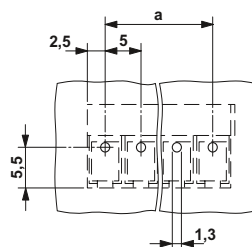

Dimensional drawing

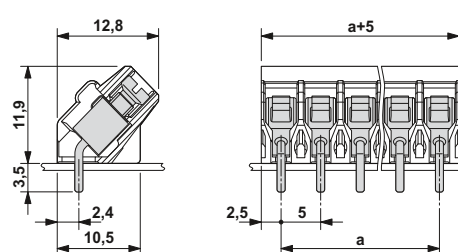

Drilling diagram

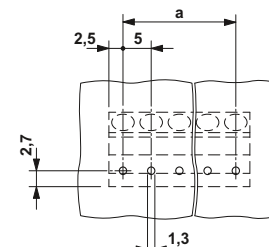

Ordering data

Type	Order No.	Pcs. / Pkt.
5.0 mm pitch, color: green		
PT 1,5/ 2-5,0-H	1935161	250
PT 1,5/ 3-5,0-H	1935174	250
PT 1,5/ 4-5,0-H	1935187	250
PT 1,5/ 5-5,0-H	1935190	100
PT 1,5/ 6-5,0-H	1935200	100
PT 1,5/ 7-5,0-H	1935213	100
PT 1,5/ 8-5,0-H	1935226	100
PT 1,5/ 9-5,0-H	1935239	100
PT 1,5/10-5,0-H	1935242	100
PT 1,5/11-5,0-H	1935255	50
PT 1,5/12-5,0-H	1935268	50
PT 1,5/13-5,0-H	1935271	50
PT 1,5/14-5,0-H	1935284	50
PT 1,5/15-5,0-H	1935297	50
PT 1,5/16-5,0-H	1935307	50

Ordering data

Type	Order No.	Pcs. / Pkt.
5.0 mm pitch, color: green		
PT 1,5/ 2-5,0-V	1935310	250
PT 1,5/ 3-5,0-V	1935323	250
PT 1,5/ 4-5,0-V	1935336	250
PT 1,5/ 5-5,0-V	1935349	100
PT 1,5/ 6-5,0-V	1935352	100
PT 1,5/ 7-5,0-V	1935365	100
PT 1,5/ 8-5,0-V	1935378	100
PT 1,5/ 9-5,0-V	1935381	100
PT 1,5/10-5,0-V	1935394	100
PT 1,5/11-5,0-V	1935404	50
PT 1,5/12-5,0-V	1935417	50
PT 1,5/13-5,0-V	1935420	50
PT 1,5/14-5,0-V	1935433	50
PT 1,5/15-5,0-V	1935446	50
PT 1,5/16-5,0-V	1935459	50

Ordering data

Type	Order No.	Pcs. / Pkt.
5.0 mm pitch, color: green		
PTA 1,5/ 2-5,0	1988804	250
PTA 1,5/ 3-5,0	1988817	250
PTA 1,5/ 4-5,0	1988820	250
PTA 1,5/ 5-5,0	1988833	100
PTA 1,5/ 6-5,0	1988846	100
PTA 1,5/ 7-5,0	1988859	100
PTA 1,5/ 8-5,0	1988862	100
PTA 1,5/ 9-5,0	1988875	100
PTA 1,5/10-5,0	1988888	100
PTA 1,5/11-5,0	1988891	50
PTA 1,5/12-5,0	1988901	50
PTA 1,5/13-5,0	1988914	50
PTA 1,5/14-5,0	1988927	50
PTA 1,5/15-5,0	1988930	50
PTA 1,5/16-5,0	1988943	50

Plugs with a screw connection of up to 1.5 mm²



- High terminal block capacity, thanks to rectangular terminal block space
- 3.5 mm and 5.0 mm pitches
- Highly flexible conductor protection for easy, repeated connecting
- Plugs with two integrated plug-in directions available, can be coded if desired
- Plus/minus screw
- Plugs with a rugged and reliable contact system
- Coding option
- Versions that can be aligned in the pitch are available on request

Notes:

In accordance with DIN EN 61984, COMBICON plug-in connectors have no switching power. During designated use, they must not be plugged in or disconnected when carrying voltage or under load.



COMBICON select

You will find the possible plug-in connector combinations in COMBICON select at: www.phoenixcontact.net/products or starting on page 388.

1) Please observe the derating curves. Derating curves of further combination options on request.

2) When using ferrules, max. 125 V are only achieved in combination with surge voltage category/pollution degree II/2.

Accessories

For all types	Type	Page
	Marker cards SK 3,5/2,8	797
	Screwdriver SZS 0,4 x 2,5 Order No. 1205037	
	Coding profile CP-PT 1,5 Order No. 1985564	38

Representative derating curve

Type: PT 1,5/...PH-3,5

Tested in accordance with DIN EN 60512-5-2:2003-01

Reduction factor = 1

No. of positions: 5

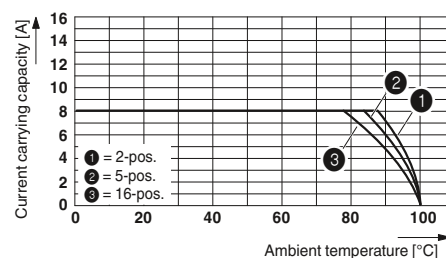

Technical data

Technical data in accordance to IEC / DIN VDE

Rated current / conductor cross section [A] / [mm²]

Rated insulation voltage for pollution degree 2 [V]

Pitch [mm]

Connection capacity

Solid / stranded [mm²] / [mm²] / AWG

Stranded with ferrules without plastic sleeve [mm²]

Stranded with ferrules with plastic sleeve [mm²]

Multi-conductor connection capacity (two conductors with the same cross section)

Solid / stranded [mm²]

Stranded with ferrules without plastic sleeve [mm²]

Stranded with TWIN ferrule with plastic sleeve [mm²]

Insulation coordination

Surge voltage category / pollution degree

Rated insulation voltage [V]

Rated surge voltage [kV]

Approval data (UL/CUL) Use Group

Nominal voltage [V]

Nominal current [A]

Connection capacity AWG AWG

Approval data (CSA) Use Group

Nominal voltage [V]

Nominal current [A]

Connection capacity AWG AWG

General data

Stripping length [mm]

Screw thread

Tightening torque [Nm]

Type of insulation material / insulation material group

Inflammability class according to UL 94

PT 1,5/ ...-PH-3,5

8¹⁾ / 1.5

200

3.5

0.2 - 1.5 / 0.2 - 1.5 / 26 - 16

-

0.25 - 0.75²⁾

0.2 - 0.34 / 0.2 - 0.5

-

-

III / 3 III / 2 II / 2

160 200 400

2.5 2.5 2.5

B C D

300 - 300

10 - 10

26 - 16 - 26 - 16

B C D

- - -

- - -

- - -

5

M2

0.22 - 0.25

PA / I

V0

PT 1,5/ ...-PVH-3,5

8¹⁾ / 1.5

200

3.5

0.2 - 1.5 / 0.2 - 1.5 / 26 - 16

-

0.25 - 0.75²⁾

0.2 - 0.34 / 0.2 - 0.5

-

-

III / 3 III / 2 II / 2

160 200 400

2.5 2.5 2.5

B C D

300 - 300

10 - 10

26 - 16 - 26 - 16

B C D

- - -

- - -

- - -

5

M2

0.22 - 0.25

PA / I

V0

No. of pos. Dim. a [mm]

2 3.50

3 7.00

4 10.50

5 14.00

6 17.50

7 21.00

8 24.50

9 28.00

10 31.50

11 35.00

12 38.50

13 42.00

14 45.50

15 49.00

16 52.50

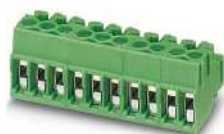

Plugs with screw connection, can be horizontally plugged onto PST 1,0/...-3,5 pin strips

Plugs with screw connection, can be horizontally and vertically plugged onto PST 1,0/...-3,5 pin strips



Dimensional drawing

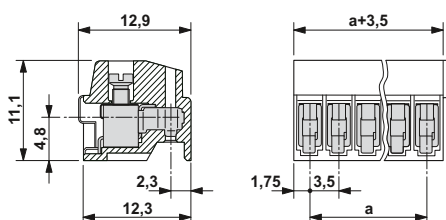

Dimensional drawing

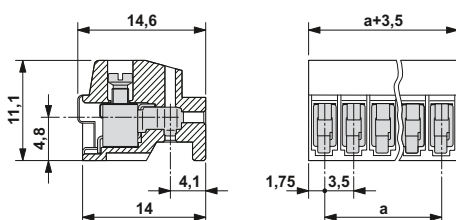

Ordering data		
Type	Order No.	Pcs. / Pkt.
3.5 mm pitch, color: green		
PT 1,5/ 2-PH-3,5	1984316	250
PT 1,5/ 3-PH-3,5	1984329	250
PT 1,5/ 4-PH-3,5	1984332	250
PT 1,5/ 5-PH-3,5	1984345	100
PT 1,5/ 6-PH-3,5	1984358	100
PT 1,5/ 7-PH-3,5	1984361	100
PT 1,5/ 8-PH-3,5	1984374	100
PT 1,5/ 9-PH-3,5	1984387	100
PT 1,5/10-PH-3,5	1984390	100
PT 1,5/11-PH-3,5	1984400	50
PT 1,5/12-PH-3,5	1984413	50
PT 1,5/13-PH-3,5	1984426	50
PT 1,5/14-PH-3,5	1984439	50
PT 1,5/15-PH-3,5	1984442	50
PT 1,5/16-PH-3,5	1984455	50

Ordering data		
Type	Order No.	Pcs. / Pkt.
3.5 mm pitch, color: green		
PT 1,5/ 2-PVH-3,5	1984015	250
PT 1,5/ 3-PVH-3,5	1984028	250
PT 1,5/ 4-PVH-3,5	1984031	250
PT 1,5/ 5-PVH-3,5	1984044	100
PT 1,5/ 6-PVH-3,5	1984057	100
PT 1,5/ 7-PVH-3,5	1984060	100
PT 1,5/ 8-PVH-3,5	1984073	100
PT 1,5/ 9-PVH-3,5	1984086	100
PT 1,5/10-PVH-3,5	1984099	100
PT 1,5/11-PVH-3,5	1984109	50
PT 1,5/12-PVH-3,5	1984112	50
PT 1,5/13-PVH-3,5	1984125	50
PT 1,5/14-PVH-3,5	1984138	50
PT 1,5/15-PVH-3,5	1984141	50
PT 1,5/16-PVH-3,5	1984154	50

PT 1.5 series

Plugs with a screw connection up to 2.5 mm²

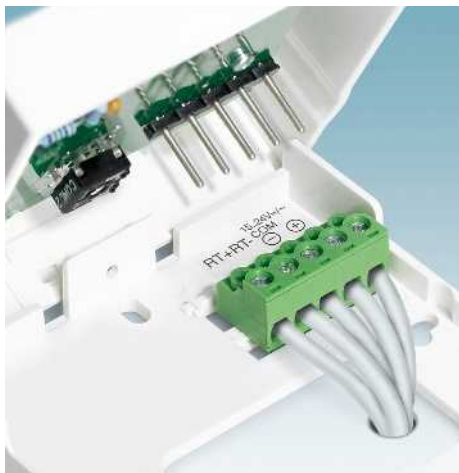

- High terminal block capacity, thanks to rectangular terminal block space
- 5.0 mm pitch
- Tension sleeve principle/Highly flexible conductor protection
- Plugs can be plugged in horizontally
- Plugs with a rugged and reliable contact system
- PH version in monoblock design
- PT 1,5/...PVH-5,0 is also available as a version that can be aligned

Notes:

In accordance with DIN EN 61984, COMBICON plug-in connectors have no switching power. During designated use, they must not be plugged in or disconnected when carrying voltage or under load.



COMBICON select

You will find the possible plug-in connector combinations in COMBICON select at: www.phoenixcontact.net/products or starting on page 388.

Recommended assembly available if required.

1) When using ferrules, 250 V are only achieved in combination with surge voltage category/pollution degree II/2.

Accessories

For all types	Type	Page
	Screwdriver SZS 0,6 x 3,5 Order No. 1205053	
Only for PT 1,5/...-PH-5,0		
	Coding profile CP-PTDA Order No. 1731361	38
Only for PT 1,5/...-PVH-5,0		
	Coding profile CP-PT 1,5	38

Representative derating curve

Type: PT 1,5/...-PH-5,0 CLIP with PST 1,3/...-5,0
Derating curve, determined according to DIN EN 61984 (VDE 0627):2002-09
Representation based on DIN EN 60512-5-2:2003-01
Connected conductor cross section = 1.5 mm²
Reduction factor = 0.8
Number of positions: See diagram

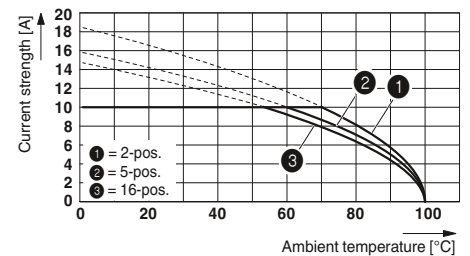

Technical data

Technical data in accordance to IEC / DIN VDE	
Rated current / conductor cross section	[A] / [mm ²]
Rated insulation voltage for pollution degree 2	[V]
Pitch	[mm]
Connection capacity	
Solid / stranded	[mm ²] / [mm ²] / AWG
Stranded with ferrules without plastic sleeve	[mm ²]
Stranded with ferrules with plastic sleeve	[mm ²]
Multi-conductor connection capacity (two conductors with the same cross section)	
Solid / stranded	[mm ²]
Stranded with ferrules without plastic sleeve	[mm ²]
Stranded with TWIN ferrule with plastic sleeve	[mm ²]
Insulation coordination	
Surge voltage category / pollution degree	
Rated insulation voltage	[V]
Rated surge voltage	[kV]
Approval data (UL/CUL)	Use Group
Nominal voltage	[V]
Nominal current	[A]
Connection capacity AWG	AWG
Approval data (CSA)	Use Group
Nominal voltage	[V]
Nominal current	[A]
Connection capacity AWG	AWG
General data	
Stripping length	[mm]
Tightening torque	[Nm]
Type of insulation material / insulation material group	
Inflammability class according to UL 94	

PT 1,5/ ...-PH-5,0			PT 1,5/ ...-PH-5,0 CLIP			PT 1,5/ ...-PVH-5,0		
10 / 2.5			10 / 1.5			12 / 2.5		
400			400			320		
5			5			5		
0.2 - 2.5 / 0.2 - 2.5 / 26 - 12			0.2 - 1.5 / 0.2 - 1.5 / 26 - 14			0.2 - 2.5 / 0.2 - 2.5 / 26 - 14		
0.25 - 1			0.25 - 1			0.25 - 1.5 ¹⁾		
0.25 - 1			0.25 - 1			0.25 - 1.5 ¹⁾		
- / -			- / -			0.2 - 0.75 / 0.2 - 0.75		
-			-			0.25 - 0.34 ¹⁾		
-			-			0.5 - 0.75 ¹⁾		
III / 3	III / 2	II / 2	III / 3	III / 2	II / 2	III / 3	III / 2	II / 2
250	400	630	250	400	630	250	320	630
4	4	4	4	4	4	4	4	4
B	C	D	B	C	D	B	C	D
300	-	300	300	-	300	300	-	300
10	-	10	10	-	10	15	-	10
28 - 14	-	28 - 14	28 - 14	-	28 - 14	26 - 12	-	26 - 12
B	C	D	B	C	D	B	C	D
300	-	300	300	-	300	-	-	-
5	-	5	5	-	5	-	-	-
26 - 14	-	26 - 14	26 - 14	-	26 - 14	-	-	-
6			6			5		
0.35 - 0.4			0.35 - 0.4			0.35 - 0.4		
PA / I			PA / I			PA / I		
V0			V0			V0		

No. of pos.	Dim. a [mm]
2	5.00
3	10.00
4	15.00
5	20.00
6	25.00
7	30.00
8	35.00
9	40.00
10	45.00
11	50.00
12	55.00
13	60.00
14	65.00
15	70.00
16	75.00



Plugs with screw connection, can be horizontally plugged onto PST 1,3/...-5,0 pin strips



Plugs for "housing assembly", can be plugged onto PST 1,3/...-5,0 pin strips

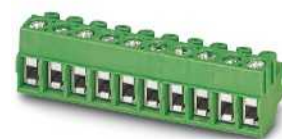

Plugs with screw connection, can be horizontally and vertically plugged onto PST 1,3/...-5,0 pin strips



Dimensional drawing

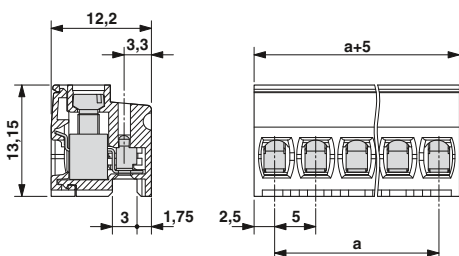

Dimensional drawing

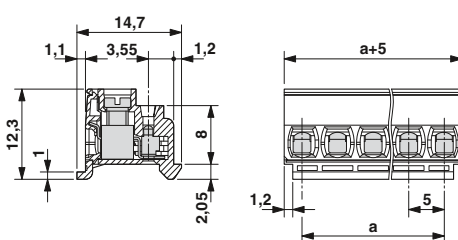

Dimensional drawing

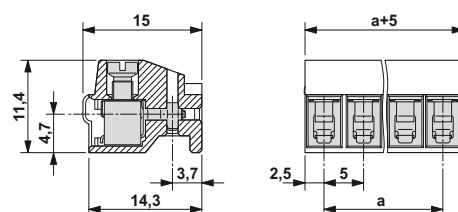

Ordering data		
Type	Order No.	Pcs. / Pkt.
5.0 mm pitch, color: green		
PT 1,5/ 2-PH-5,0	1755583	250
PT 1,5/ 3-PH-5,0	1755596	250
PT 1,5/ 4-PH-5,0	1755606	250
PT 1,5/ 5-PH-5,0	1755619	100
PT 1,5/ 6-PH-5,0	1755622	100
PT 1,5/ 7-PH-5,0	1755635	100
PT 1,5/ 8-PH-5,0	1755648	100
PT 1,5/ 9-PH-5,0	1755651	100
PT 1,5/10-PH-5,0	1755664	100
PT 1,5/11-PH-5,0	1755677	50
PT 1,5/12-PH-5,0	1755680	50
PT 1,5/13-PH-5,0	1755693	50
PT 1,5/14-PH-5,0	1755703	50
PT 1,5/15-PH-5,0	1755716	50
PT 1,5/16-PH-5,0	1755729	50

Ordering data		
Type	Order No.	Pcs. / Pkt.
5.0 mm pitch, color: green		
PT 1,5/ 2-PH-5,0 CLIP	1755732	250
PT 1,5/ 3-PH-5,0 CLIP	1755745	250
PT 1,5/ 4-PH-5,0 CLIP	1755758	250
PT 1,5/ 5-PH-5,0 CLIP	1755761	100
PT 1,5/ 6-PH-5,0 CLIP	1755774	100
PT 1,5/ 7-PH-5,0 CLIP	1755787	100
PT 1,5/ 8-PH-5,0 CLIP	1755790	100
PT 1,5/ 9-PH-5,0 CLIP	1755800	100
PT 1,5/10-PH-5,0 CLIP	1755813	100
PT 1,5/11-PH-5,0 CLIP	1755826	50
PT 1,5/12-PH-5,0 CLIP	1755839	50
PT 1,5/13-PH-5,0 CLIP	1755842	50
PT 1,5/14-PH-5,0 CLIP	1755855	50
PT 1,5/15-PH-5,0 CLIP	1755868	50
PT 1,5/16-PH-5,0 CLIP	1755871	50

Ordering data		
Type	Order No.	Pcs. / Pkt.
5.0 mm pitch, color: green		
PT 1,5/ 2-PVH-5,0	1934861	250
PT 1,5/ 3-PVH-5,0	1934874	250
PT 1,5/ 4-PVH-5,0	1934887	250
PT 1,5/ 5-PVH-5,0	1934890	100
PT 1,5/ 6-PVH-5,0	1934900	100
PT 1,5/ 7-PVH-5,0	1934913	100
PT 1,5/ 8-PVH-5,0	1934926	100
PT 1,5/ 9-PVH-5,0	1934939	100
PT 1,5/10-PVH-5,0	1934942	100
PT 1,5/11-PVH-5,0	1934955	50
PT 1,5/12-PVH-5,0	1934968	50
PT 1,5/13-PVH-5,0	1934971	50
PT 1,5/14-PVH-5,0	1934984	50
PT 1,5/15-PVH-5,0	1934997	50
PT 1,5/16-PVH-5,0	1935006	50

PT 2,5 series

PCB terminal blocks with a screw connection up to 4 mm²

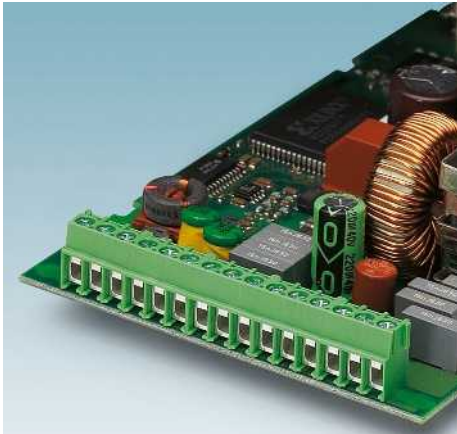

- High terminal block capacity, thanks to rectangular terminal block space
- 5.0 mm pitch
- Highly flexible conductor protection for easy, repeated connecting
- Rugged design for larger cross sections
- Plus/minus screw

Notes:
1) Please observe the current carrying capacity curves. Further current carrying capacity curves on request.
2) When using ferrules, 250 V are only achieved in combination with surge voltage category/pollution degree II/2.
3) Use a hole diameter of 1.3 - 1.6 mm

Accessories		
For all types	Type	Page
	Marker cards SK 5/3,8	798
	Screwdriver SZS 0,6 x 3,5 Order No. 1205053	

Current carrying capacity curve

Type: PT 2,5/5-5,0-H
 Test following DIN EN 60512-5-2:2003-01
 Reduction factor = 1
 No. of positions: 5

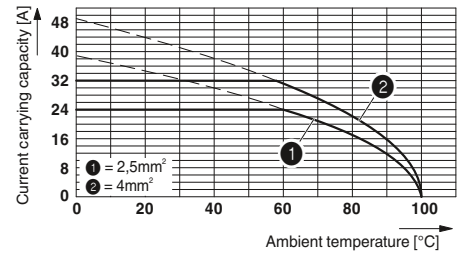

Technical data

Technical data in accordance to IEC / DIN VDE	
Rated current / conductor cross section	[A] / [mm ²]
Rated insulation voltage for pollution degree 2	[V]
Pitch	[mm]
Connection capacity	
Solid / stranded	[mm ²] / [mm ²] / AWG
Stranded with ferrules without plastic sleeve	[mm ²]
Stranded with ferrules with plastic sleeve	[mm ²]
Multi-conductor connection capacity (two conductors with the same cross section)	
Solid / stranded	[mm ²]
Stranded with ferrules without plastic sleeve	[mm ²]
Stranded with TWIN ferrule with plastic sleeve	[mm ²]
Insulation coordination	
Surge voltage category / pollution degree	
Rated insulation voltage	[V]
Rated surge voltage	[kV]
Approval data (UL/CUL)	Use Group
Nominal voltage	[V]
Nominal current	[A]
Connection capacity AWG	AWG
Approval data (CSA)	Use Group
Nominal voltage	[V]
Nominal current	[A]
Connection capacity AWG	AWG
General data	
Stripping length	[mm]
Screw thread	
Tightening torque	[Nm]
Type of insulation material / insulation material group	
Inflammability class according to UL 94	
Drill hole diameter / pin dimensions	[mm]

PT 2,5/ ...-5,0-H

Rated current / conductor cross section			32 ¹⁾ / 4
Rated insulation voltage for pollution degree 2			400
Pitch			5
Connection capacity			
Solid / stranded			0.5 - 4 / 0.5 - 4 / 20 - 10
Stranded with ferrules without plastic sleeve			0.5 - 2.5 ²⁾
Stranded with ferrules with plastic sleeve			0.5 - 2.5 ²⁾
Multi-conductor connection capacity (two conductors with the same cross section)			
Solid / stranded			0.5 - 1.5 / 0.5 - 1.5
Stranded with ferrules without plastic sleeve			0.5 - 0.75 ²⁾
Stranded with TWIN ferrule with plastic sleeve			0.5 - 1.5 ²⁾
Insulation coordination			
Surge voltage category / pollution degree			III / 3 III / 2 II / 2
Rated insulation voltage			250 400 630
Rated surge voltage			4 4 4
Approval data (UL/CUL)			B C D
Nominal voltage			300 - 300
Nominal current			20 - 10
Connection capacity AWG			20 - 12 - 20 - 12
Approval data (CSA)			B C D
Nominal voltage			- - -
Nominal current			- - -
Connection capacity AWG			- - -
General data			
Stripping length			6.5
Screw thread			M3
Tightening torque			0.45 - 0.5
Type of insulation material / insulation material group			PA / I
Inflammability class according to UL 94			V0
Drill hole diameter / pin dimensions			1.3 ³⁾ / 1.0 mm

PT 2,5/ ...-5,0-V

Rated current / conductor cross section			32 ¹⁾ / 4
Rated insulation voltage for pollution degree 2			400
Pitch			5
Connection capacity			
Solid / stranded			0.5 - 4 / 0.5 - 4 / 20 - 10
Stranded with ferrules without plastic sleeve			0.5 - 2.5 ²⁾
Stranded with ferrules with plastic sleeve			0.5 - 2.5 ²⁾
Multi-conductor connection capacity (two conductors with the same cross section)			
Solid / stranded			0.5 - 1.5 / 0.5 - 1.5
Stranded with ferrules without plastic sleeve			0.5 - 0.75 ²⁾
Stranded with TWIN ferrule with plastic sleeve			0.5 - 1.5 ²⁾
Insulation coordination			
Surge voltage category / pollution degree			III / 3 III / 2 II / 2
Rated insulation voltage			250 400 630
Rated surge voltage			4 4 4
Approval data (UL/CUL)			B C D
Nominal voltage			300 - 300
Nominal current			20 - 10
Connection capacity AWG			20 - 12 - 20 - 12
Approval data (CSA)			B C D
Nominal voltage			- - -
Nominal current			- - -
Connection capacity AWG			- - -
General data			
Stripping length			6.5
Screw thread			M3
Tightening torque			0.45 - 0.5
Type of insulation material / insulation material group			PA / I
Inflammability class according to UL 94			V0
Drill hole diameter / pin dimensions			1.3 ³⁾ / 1.0 mm

No. of pos.	Dim. a [mm]
2	5.00
3	10.00
4	15.00
5	20.00
6	25.00
7	30.00
8	35.00
9	40.00
10	45.00
11	50.00
12	55.00
13	60.00
14	65.00
15	70.00
16	75.00



PCB terminal block, connection direction horizontal to the PCB

PCB terminal block, connection direction vertical to the PCB



Dimensional drawing



Dimensional drawing

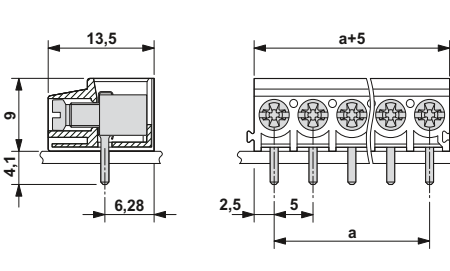
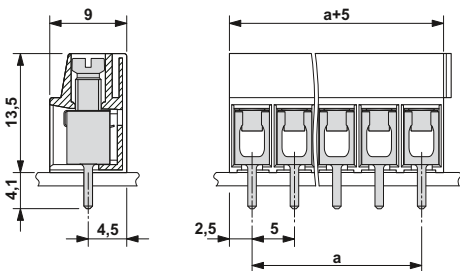

Drilling diagram

Drilling diagram

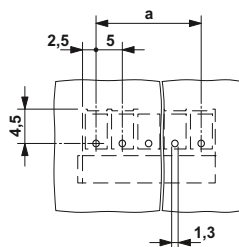
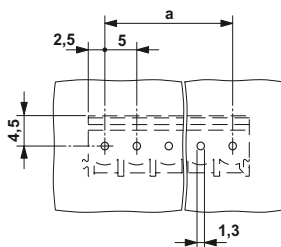

Ordering data

Ordering data

Type	Order No.	Pcs. / Pkt.
5.0 mm pitch, color: green		
PT 2,5/ 2-5,0-H	1935776	250
PT 2,5/ 3-5,0-H	1935789	250
PT 2,5/ 4-5,0-H	1935792	250
PT 2,5/ 5-5,0-H	1935802	100
PT 2,5/ 6-5,0-H	1935815	100
PT 2,5/ 7-5,0-H	1935828	100
PT 2,5/ 8-5,0-H	1935831	100
PT 2,5/ 9-5,0-H	1935844	100
PT 2,5/10-5,0-H	1935857	100
PT 2,5/11-5,0-H	1935860	50
PT 2,5/12-5,0-H	1935873	50
PT 2,5/13-5,0-H	1935886	50
PT 2,5/14-5,0-H	1935899	50
PT 2,5/15-5,0-H	1935909	50
PT 2,5/16-5,0-H	1935912	50

Type	Order No.	Pcs. / Pkt.
5.0 mm pitch, color: green		
PT 2,5/ 2-5,0-V	1987724	250
PT 2,5/ 3-5,0-V	1987737	250
PT 2,5/ 4-5,0-V	1987740	250
PT 2,5/ 5-5,0-V	1987753	100
PT 2,5/ 6-5,0-V	1987766	100
PT 2,5/ 7-5,0-V	1987779	100
PT 2,5/ 8-5,0-V	1987782	100
PT 2,5/ 9-5,0-V	1987795	100
PT 2,5/10-5,0-V	1987805	100
PT 2,5/11-5,0-V	1987818	50
PT 2,5/12-5,0-V	1987821	50
PT 2,5/13-5,0-V	1987834	50
PT 2,5/14-5,0-V	1987847	50
PT 2,5/15-5,0-V	1987850	50
PT 2,5/16-5,0-V	1987863	50

PCB terminal blocks with a screw connection up to 4 mm²

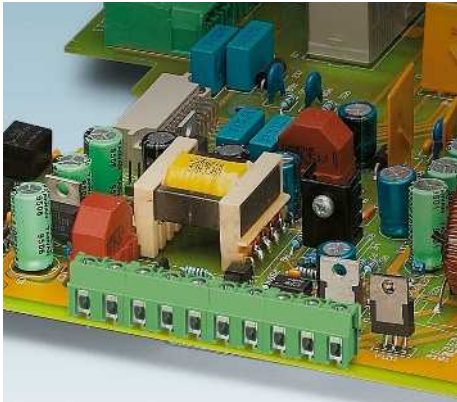



- High terminal block capacity, thanks to rectangular terminal block space
- 7.5 mm pitch
- Highly flexible conductor protection for easy, repeated connecting
- Rugged design for larger cross sections and higher voltages
- Plus/minus screw

Notes:

- 1) Please observe the current carrying capacity curves. Further current carrying capacity curves on request.
- 2) When using ferrules, 500 V are only achieved in combination with surge voltage category/pollution degree II/2.
- 3) Use a hole diameter of 1.3 - 1.6 mm

Accessories

For all types	Type	Page
	Marker cards SK 7,5/3,8	799
	Screwdriver SZS 0,6 x 3,5 Order No. 1205053	

Current carrying capacity curve

Type: PT 2,5/5-7,5-H
Test following DIN EN 60512-5-2:2003-01
Reduction factor = 1
No. of positions: 5

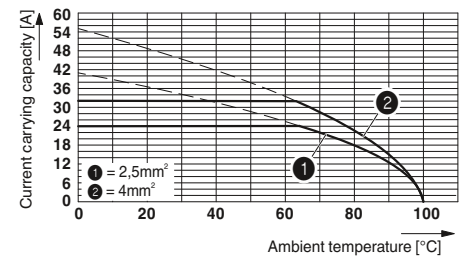

Technical data

Technical data in accordance to IEC / DIN VDE

Rated current / conductor cross section	[A] / [mm ²]
Rated insulation voltage for pollution degree 2	[V]
Pitch	[mm]
Connection capacity	
Solid / stranded	[mm ²] / [mm ²] / AWG
Stranded with ferrules without plastic sleeve	[mm ²]
Stranded with ferrules with plastic sleeve	[mm ²]
Multi-conductor connection capacity (two conductors with the same cross section)	
Solid / stranded	[mm ²]
Stranded with ferrules without plastic sleeve	[mm ²]
Stranded with TWIN ferrule with plastic sleeve	[mm ²]
Insulation coordination	
Surge voltage category / pollution degree	
Rated insulation voltage	[V]
Rated surge voltage	[kV]
Approval data (UL/CUL)	Use Group
Nominal voltage	[V]
Nominal current	[A]
Connection capacity AWG	AWG
Approval data (CSA)	Use Group
Nominal voltage	[V]
Nominal current	[A]
Connection capacity AWG	AWG
General data	
Stripping length	[mm]
Screw thread	
Tightening torque	[Nm]
Type of insulation material / insulation material group	
Inflammability class according to UL 94	
Drill hole diameter / pin dimensions	[mm]

PT 2,5/ ...-7,5-H

Rated current / conductor cross section	32 ¹⁾ / 4		
Rated insulation voltage for pollution degree 2	800		
Pitch	7.5		
Connection capacity			
Solid / stranded	0.5 - 4 / 0.5 - 4 / 20 - 10		
Stranded with ferrules without plastic sleeve	0.5 - 2.5 ²⁾		
Stranded with ferrules with plastic sleeve	0.5 - 2.5 ²⁾		
Multi-conductor connection capacity (two conductors with the same cross section)			
Solid / stranded	0.5 - 1.5 / 0.5 - 1.5		
Stranded with ferrules without plastic sleeve	0.5 - 0.75 ²⁾		
Stranded with TWIN ferrule with plastic sleeve	0.5 - 1.5 ²⁾		
Insulation coordination			
Surge voltage category / pollution degree	III / 3	III / 2	II / 2
Rated insulation voltage	500	800	1000
Rated surge voltage	6	6	6
Approval data (UL/CUL)	B	C	D
Nominal voltage	300	150	300
Nominal current	20	20	10
Connection capacity AWG	20 - 12	20 - 12	20 - 12
Approval data (CSA)	B	C	D
Nominal voltage	-	-	-
Nominal current	-	-	-
Connection capacity AWG	-	-	-
General data			
Stripping length	6.5		
Screw thread	M3		
Tightening torque	0.45 - 0.5		
Type of insulation material / insulation material group	PA / I		
Inflammability class according to UL 94	V0		
Drill hole diameter / pin dimensions	1.3 ³⁾ / 1.0 mm		

PT 2,5/ ...-7,5-V

Rated current / conductor cross section	32 ¹⁾ / 4		
Rated insulation voltage for pollution degree 2	800		
Pitch	7.5		
Connection capacity			
Solid / stranded	0.5 - 4 / 0.5 - 4 / 20 - 10		
Stranded with ferrules without plastic sleeve	0.5 - 2.5 ²⁾		
Stranded with ferrules with plastic sleeve	0.5 - 2.5 ²⁾		
Multi-conductor connection capacity (two conductors with the same cross section)			
Solid / stranded	0.5 - 1.5 / 0.5 - 1.5		
Stranded with ferrules without plastic sleeve	0.5 - 0.75 ²⁾		
Stranded with TWIN ferrule with plastic sleeve	0.5 - 1.5 ²⁾		
Insulation coordination			
Surge voltage category / pollution degree	III / 3	III / 2	II / 2
Rated insulation voltage	500	800	1000
Rated surge voltage	6	6	6
Approval data (UL/CUL)	B	C	D
Nominal voltage	300	150	300
Nominal current	20	20	10
Connection capacity AWG	20 - 12	20 - 12	20 - 12
Approval data (CSA)	B	C	D
Nominal voltage	-	-	-
Nominal current	-	-	-
Connection capacity AWG	-	-	-
General data			
Stripping length	6.5		
Screw thread	M3		
Tightening torque	0.45 - 0.5		
Type of insulation material / insulation material group	PA / I		
Inflammability class according to UL 94	V0		
Drill hole diameter / pin dimensions	1.3 ³⁾ / 1.0 mm		

No. of pos.	Dim. a [mm]
2	7.50
3	15.00
4	22.50
5	30.00
6	37.50
7	45.00
8	52.50
9	60.00
10	67.50
11	75.00
12	82.50



PCB terminal block, connection direction horizontal to the PCB

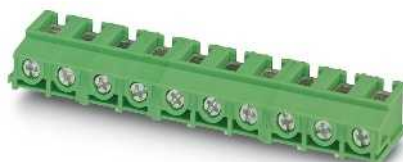

PCB terminal block, connection direction vertical to the PCB



Dimensional drawing

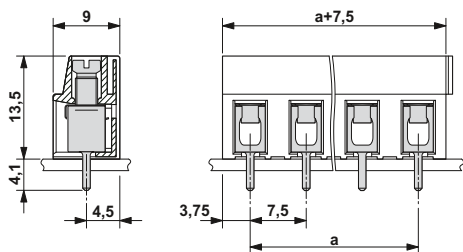

Drilling diagram

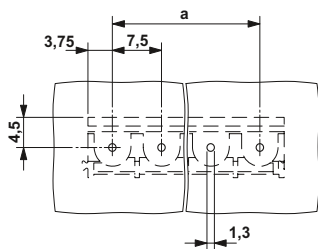

Ordering data

Type	Order No.	Pcs. / Pkt.
7.5 mm pitch, color: green		
PT 2,5/ 2-7,5-H	1988105	250
PT 2,5/ 3-7,5-H	1988118	250
PT 2,5/ 4-7,5-H	1988121	250
PT 2,5/ 5-7,5-H	1988134	100
PT 2,5/ 6-7,5-H	1988147	100
PT 2,5/ 7-7,5-H	1988150	100
PT 2,5/ 8-7,5-H	1988163	100
PT 2,5/ 9-7,5-H	1988176	100
PT 2,5/10-7,5-H	1988189	100
PT 2,5/11-7,5-H	1988192	50
PT 2,5/12-7,5-H	1988202	50



Dimensional drawing

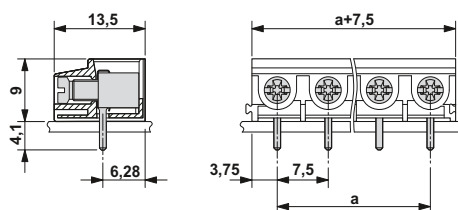

Drilling diagram

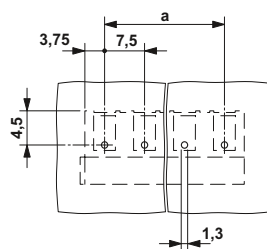

Ordering data

Type	Order No.	Pcs. / Pkt.
7.5 mm pitch, color: green		
PT 2,5/ 2-7,5-V	1987957	250
PT 2,5/ 3-7,5-V	1987960	250
PT 2,5/ 4-7,5-V	1987973	250
PT 2,5/ 5-7,5-V	1987986	100
PT 2,5/ 6-7,5-V	1987999	100
PT 2,5/ 7-7,5-V	1988008	100
PT 2,5/ 8-7,5-V	1988011	100
PT 2,5/ 9-7,5-V	1988024	100
PT 2,5/10-7,5-V	1988037	100
PT 2,5/11-7,5-V	1988040	50
PT 2,5/12-7,5-V	1988053	50

PT 2,5 plug-in system

Multi-plug-in system with a screw connection up to 4 mm²



- Plug-in system with five plug-in options in all
- 5.0 mm pitch
- Highly flexible conductor protection for easy, repeated connecting
- High stability, thanks to the L-shaped base strips
- Reliable contact system with high current carrying capacity
- Patented coding available if desired
- Compatible with standard pin strips PST 1,3...

Notes:

In accordance with DIN EN 61984, COMBICON plug-in connectors have no switching power. During designated use, they must not be plugged in or disconnected when carrying voltage or under load.



COMBICON select

You will find the possible plug-in connector combinations in COMBICON select at: www.phoenixcontact.net/products or starting on page 388.

Larger numbers of positions on request.

1) Please observe the current carrying capacity curves. Further current carrying capacity curves on request.

Accessories

For all types	Type	Page
	Coding profile CP-PT 2,5 Order No. 1733398	38
	Screwdriver SZS 0,6 x 3,5 Order No. 1205053	

Representative derating curve

Type: PT 2,5/...-PVH-5,0 with PST 1,3...-LH-5,0

Derating curve determined as per

DIN EN 61984 (VDE 0627):2002-09

Representation based on DIN EN 60512-5-2:2003-01

Reduction factor = 0.8

Conductor cross section: 4 mm²

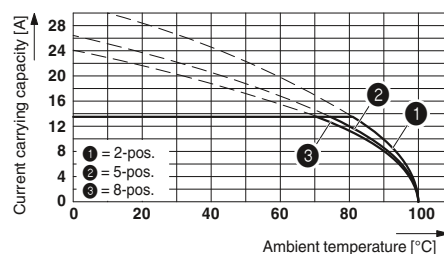

Technical data

Technical data in accordance to IEC / DIN VDE

Rated current / conductor cross section [A] / [mm²]

Rated insulation voltage for pollution degree 2 [V]

Pitch [mm]

Connection capacity

Solid / stranded [mm²] / [mm²] / AWG

Stranded with ferrules without plastic sleeve [mm²]

Stranded with ferrules with plastic sleeve [mm²]

Multi-conductor connection capacity (two conductors with the same cross section)

Solid / stranded [mm²]

Stranded with ferrules without plastic sleeve [mm²]

Stranded with TWIN ferrule with plastic sleeve [mm²]

Insulation coordination

Surge voltage category / pollution degree

Rated insulation voltage [V]

Rated surge voltage [kV]

Approval data (UL/CUL) Use Group

Nominal voltage [V]

Nominal current [A]

Connection capacity AWG AWG

Approval data (CSA) Use Group

Nominal voltage [V]

Nominal current [A]

Connection capacity AWG AWG

General data

Stripping length [mm]

Screw thread

Tightening torque [Nm]

Type of insulation material / insulation material group

Inflammability class according to UL 94

PT 2,5/ ...-PVH-5,0

13.5¹⁾ / 4

320

5

0.5 - 4 / 0.5 - 4 / 20 - 12

0.5 - 2.5

0.5 - 2.5

0.5 - 1.5 / 0.5 - 1.5

0.5 - 0.75

0.5 - 1.5

III / 3 III / 2 II / 2

250 320 630

4 4 4

B C D

300 - 300

10 - 10

26 - 12 26 - 12 26 - 12

B C D

- - -

- - -

- - -

8

M3

0.45 - 0.5

PA / I

V0

PST 1,3/ ...-LH-5,0

13.5

400

5

- / - / -

-

-

- / -

-

-

III / 3 III / 2 II / 2

250 400 400

4 4 4

B C D

300 - 300

10 - 10

- - -

- - -

- - -

- - -

- - -

-

-

-

PA / IIIb

V0

PST 1,3/ ...-LV-5,0

13.5

400

5

- / - / -

-

-

- / -

-

-

III / 3 III / 2 II / 2

250 400 400

4 4 4

B C D

300 - 300

10 - 10

- - -

- - -

- - -

- - -

- - -

-

-

-

PA / IIIb

V0

No. of pos. Dim. a [mm]

2 5.00

3 10.00

4 15.00

5 20.00

6 25.00

7 30.00

8 35.00



Plugs with screw connection, can be plugged in horizontally and vertically

Pin strip for PT 2,5 connector, Plug-in direction parallel to the PCB

Pin strip for PT 2,5 plug, Plug-in direction vertical to the PCB



Dimensional drawing

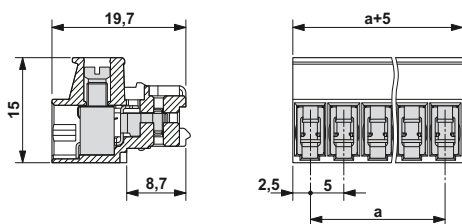

Dimensional drawing

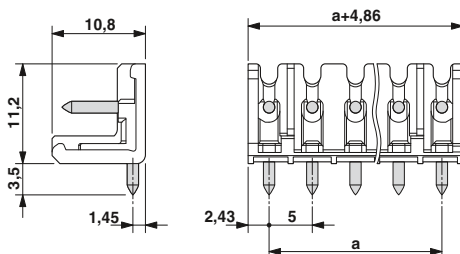

Dimensional drawing

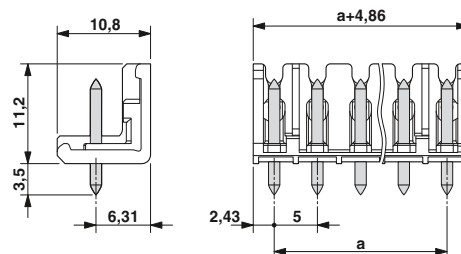

Drilling diagram

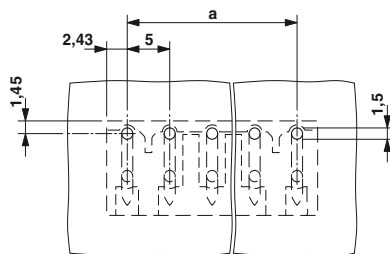

Drilling diagram

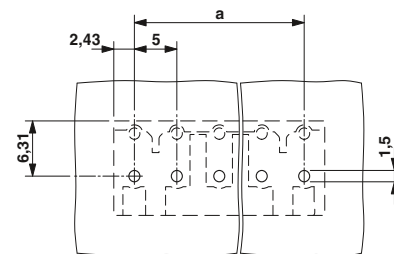

Ordering data

Type	Order No.	Pcs. / Pkt.
5.0 mm pitch, color: green		
PT 2,5/ 2-PVH-5,0	1704165	250
PT 2,5/ 3-PVH-5,0	1704178	250
PT 2,5/ 4-PVH-5,0	1704181	250
PT 2,5/ 5-PVH-5,0	1704194	100
PT 2,5/ 6-PVH-5,0	1704204	100
PT 2,5/ 7-PVH-5,0	1704217	100
PT 2,5/ 8-PVH-5,0	1704220	100

Ordering data

Type	Order No.	Pcs. / Pkt.
Pitch 5.0 mm, color: Black		
PST 1,3/ 2-LH-5,0	1704275	250
PST 1,3/ 3-LH-5,0	1704291	250
PST 1,3/ 4-LH-5,0	1704327	250
PST 1,3/ 5-LH-5,0	1704356	100
PST 1,3/ 6-LH-5,0	1704369	100
PST 1,3/ 7-LH-5,0	1704372	100
PST 1,3/ 8-LH-5,0	1704385	100

Ordering data

Type	Order No.	Pcs. / Pkt.
Pitch 5.0 mm, color: Black		
PST 1,3/ 2-LV-5,0	1704437	250
PST 1,3/ 3-LV-5,0	1704453	250
PST 1,3/ 4-LV-5,0	1704482	250
PST 1,3/ 5-LV-5,0	1704518	100
PST 1,3/ 6-LV-5,0	1704521	100
PST 1,3/ 7-LV-5,0	1704534	100
PST 1,3/ 8-LV-5,0	1704547	100

PST series

Pin strips for COMBICON compact connector



- Reflow solderable pin strip, optimized for COMBICON compact connectors
- Pitch 3.5 mm
- Pin geometry caring on the plug
- Various pin lengths and pin geometries available on request
- Pin strip available in machine-compatible packaging (tube magazine or tape)
- Pin strip with a pad for the suction pipette pushed over it for optional taped packaging

Notes:

In accordance with DIN EN 61984, COMBICON plug-in connectors have no switching power. During designated use, they must not be plugged in or disconnected when carrying voltage or under load.

COMBICON select

You will find the possible plug-in connector combinations in COMBICON select at: www.phoenixcontact.net/products or starting on page 388.

These items are also available in larger unit packs.

Pick and place pads for taped THR articles usually protrude beyond the components. The PCB layout must ensure that collisions are avoided when components are assembled. Dimensional drawings of tape reels and place pads can be found online at www.phoenixcontact.net/products.



Pin strip,
plug-in direction vertical to the PCB



Dimensional drawing

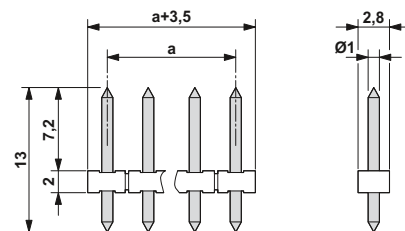

Drilling diagram

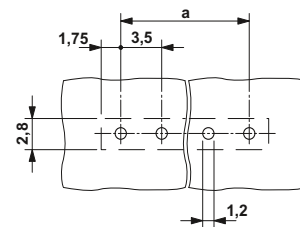

Technical data

Technical data in accordance to IEC / DIN VDE

Rated current	[A]	8
Rated insulation voltage for pollution degree 2	[V]	250
Pitch	[mm]	3.5
Insulation coordination		
Surge voltage category / pollution degree		III / 3 III / 2 II / 2
Rated insulation voltage	[V]	160 250 250
Rated surge voltage	[kV]	2.5 2.5 2.5
Approval data (UL/CUL)	Use Group	B C D
Nominal voltage	[V]	300 - -
Nominal current	[A]	10 - -
Connection capacity AWG	AWG	- - -
Approval data (CSA)	Use Group	B C D
Nominal voltage	[V]	- - -
Nominal current	[A]	- - -
Connection capacity AWG	AWG	- - -
General data		
Type of insulation material / insulation material group		PA / IIIa
Inflammability class according to UL 94		V0
Drill hole diameter / pin dimensions	[mm]	1.2 / 1 mm

Ordering data

No. of pos.	Dim. a [mm]	Type	Order No.	Pcs. / Pkt.
Pitch 3.5 mm, color: Black				
2	3.50	PST 1,0/ 2-3,5	1945096	50
3	7.00	PST 1,0/ 3-3,5	1945106	50
4	10.50	PST 1,0/ 4-3,5	1945119	50
5	14.00	PST 1,0/ 5-3,5	1945122	50
6	17.50	PST 1,0/ 6-3,5	1945135	50
7	21.00	PST 1,0/ 7-3,5	1945148	50
8	24.50	PST 1,0/ 8-3,5	1945151	50
9	28.00	PST 1,0/ 9-3,5	1945164	50
10	31.50	PST 1,0/10-3,5	1945177	50
11	35.00	PST 1,0/11-3,5	1945180	50
12	38.50	PST 1,0/12-3,5	1945193	50
13	42.00	PST 1,0/13-3,5	1945203	50
14	45.50	PST 1,0/14-3,5	1945216	50
15	49.00	PST 1,0/15-3,5	1945229	50
16	52.50	PST 1,0/16-3,5	1945232	50



Taped pin strip with 3.5 mm pitch



Pin strip, plug-in direction horizontal to the PCB



Dimensional drawing

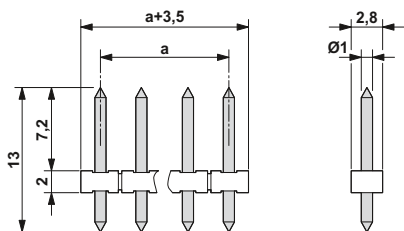

Drilling diagram

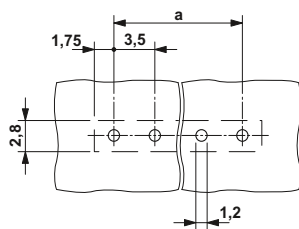

Dimensional drawing

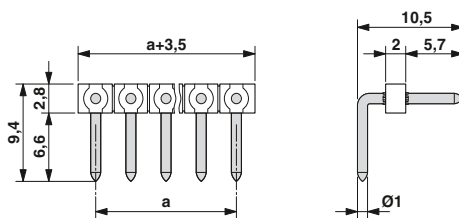

Drilling diagram

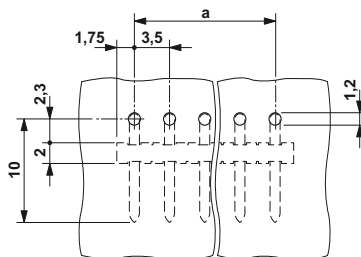

Ordering data

Type	Order No.	Pcs. / Pkt.
Pitch 3.5 mm, color: Black		
PST 1,0/ 2-3,5 R24	1720233	330
PST 1,0/ 3-3,5 R24	1720246	330
PST 1,0/ 4-3,5 R24	1995525	330
PST 1,0/ 5-3,5 R56	1720259	250
PST 1,0/ 6-3,5 R56	1720262	250
PST 1,0/ 7-3,5 R56	1995538	250
PST 1,0/ 8-3,5 R56	1720275	250
PST 1,0/ 9-3,5 R56	1995541	250
PST 1,0/10-3,5 R56	1720288	250
PST 1,0/11-3,5 R56	1720291	250

Ordering data

Type	Order No.	Pcs. / Pkt.
Pitch 3.5 mm, color: Black		
PST 1,0/ 2-H-3,5	1737019	50
PST 1,0/ 3-H-3,5	1737022	50
PST 1,0/ 4-H-3,5	1737035	50
PST 1,0/ 5-H-3,5	1737048	50
PST 1,0/ 6-H-3,5	1737051	50
PST 1,0/ 7-H-3,5	1737064	50
PST 1,0/ 8-H-3,5	1737077	50
PST 1,0/ 9-H-3,5	1737080	50
PST 1,0/10-H-3,5	1737093	50
PST 1,0/11-H-3,5	1737103	50
PST 1,0/12-H-3,5	1737116	50
PST 1,0/13-H-3,5	1737129	50
PST 1,0/14-H-3,5	1737132	50
PST 1,0/15-H-3,5	1737145	50
PST 1,0/16-H-3,5	1737158	50

PST series

Pin strips for COMBICON compact connector



- Reflow solderable pin strip, optimized for COMBICON compact connectors
- 5.0 mm pitch
- Pin geometry caring on the plug
- Various pin lengths and pin geometries available on request
- Pin strip available in machine-compatible packaging (tube magazine or tape)
- Pin strip with a pad for the suction pipette pushed over it for optional taped packaging

Notes:

In accordance with DIN EN 61984, COMBICON plug-in connectors have no switching power. During designated use, they must not be plugged in or disconnected when carrying voltage or under load.

COMBICON select

You will find the possible plug-in connector combinations in COMBICON select at: www.phoenixcontact.net/products or starting on page 388.

These items are also available in larger unit packs.

Pick and place pads for taped THR articles usually protrude beyond the components. The PCB layout must ensure that collisions are avoided when components are assembled. Dimensional drawings of tape reels and place pads can be found online at www.phoenixcontact.net/products.



Pin strip, plug-in direction vertical to the PCB



Dimensional drawing

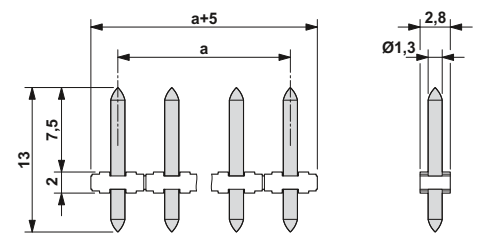

Drilling diagram

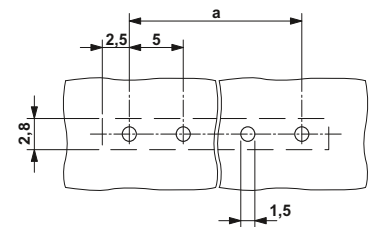

Technical data

Technical data in accordance to IEC / DIN VDE

Rated current	[A]	12
Rated insulation voltage for pollution degree 2	[V]	320
Pitch	[mm]	5
Insulation coordination		
Surge voltage category / pollution degree		III / 3 III / 2 II / 2
Rated insulation voltage	[V]	250 320 400
Rated surge voltage	[kV]	4 4 4
Approval data (UL/CUL)	Use Group	B C D
Nominal voltage	[V]	300 - 300
Nominal current	[A]	16 - 10
Connection capacity AWG	AWG	- - -
Approval data (CSA)	Use Group	B C D
Nominal voltage	[V]	300 - 300
Nominal current	[A]	5 - 5
Connection capacity AWG	AWG	- - -
General data		
Type of insulation material / insulation material group		PA / IIIa
Inflammability class according to UL 94		V0
Drill hole diameter / pin dimensions	[mm]	1.5 / 1.3 mm

Ordering data

No. of pos.	Dim. a [mm]	Type	Order No.	Pcs. / Pkt.
		Pitch 5.0 mm, color: Black		
2	5.00	PST 1,3/ 2-5,0	1933189	50
3	10.00	PST 1,3/ 3-5,0	1933192	50
4	15.00	PST 1,3/ 4-5,0	1933202	50
5	20.00	PST 1,3/ 5-5,0	1933215	50
6	25.00	PST 1,3/ 6-5,0	1933228	50
7	30.00	PST 1,3/ 7-5,0	1933231	50
8	35.00	PST 1,3/ 8-5,0	1933244	50
9	40.00	PST 1,3/ 9-5,0	1933257	50
10	45.00	PST 1,3/10-5,0	1933260	50
11	50.00	PST 1,3/11-5,0	1933273	50
12	55.00	PST 1,3/12-5,0	1933286	50
13	60.00	PST 1,3/13-5,0	1933299	50
14	65.00	PST 1,3/14-5,0	1933309	50
15	70.00	PST 1,3/15-5,0	1933312	50
16	75.00	PST 1,3/16-5,0	1933325	50



Taped pin strip with 5.0 mm pitch



Pin strip, plug-in direction horizontal to the PCB



Dimensional drawing

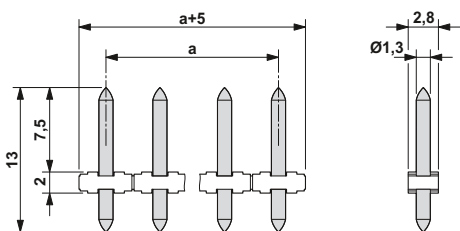

Drilling diagram

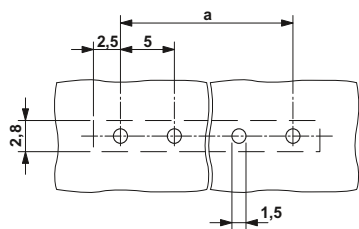

Dimensional drawing

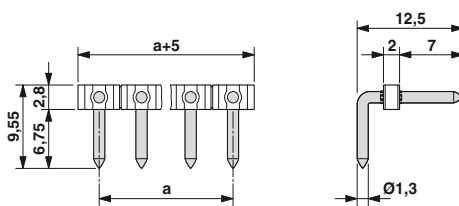

Drilling diagram

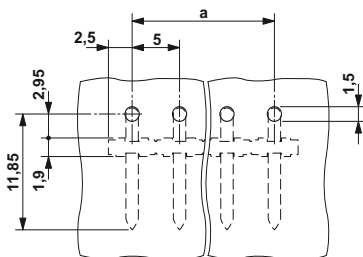

Ordering data

Type	Order No.	Pcs. / Pkt.
Pitch 5.0 mm, color: Black		
PST 1,3/ 2-5,0 R24	1720301	330
PST 1,3/ 3-5,0 R24	1713169	330
PST 1,3/ 4-5,0 R56	1720314	250
PST 1,3/ 5-5,0 R56	1720327	250
PST 1,3/ 6-5,0 R56	1720330	250
PST 1,3/ 7-5,0 R56	1720343	250
PST 1,3/ 8-5,0 R56	1720356	250

Ordering data

Type	Order No.	Pcs. / Pkt.
PST 1,3/ 2-H-5,0	1995635	250
PST 1,3/ 3-H-5,0	1705478	250
PST 1,3/ 4-H-5,0	1705481	100
PST 1,3/ 5-H-5,0	1705494	100
PST 1,3/ 6-H-5,0	1705504	100
PST 1,3/ 7-H-5,0	1717301	100
PST 1,3/ 8-H-5,0	1717314	100
PST 1,3/ 9-H-5,0	1717327	100
PST 1,3/10-H-5,0	1717330	100
PST 1,3/11-H-5,0	1717343	50
PST 1,3/12-H-5,0	1717356	50
PST 1,3/13-H-5,0	1717369	50
PST 1,3/14-H-5,0	1717372	50
PST 1,3/15-H-5,0	1717385	50
PST 1,3/16-H-5,0	1717398	50

FOPT series

FOPT 2,2-T/R FO fast connect PCB terminal blocks

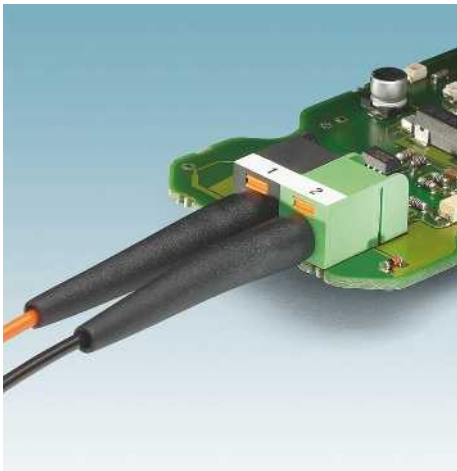

- Integrated transmit or receive diode
- Connection without fiber pretreatment, easily cut to length with fiber cutter IBS RL FOC
- Increased operating convenience, thanks to the direct plug-in method with release button
- Stability through additional strain relief
- Bend protection sleeve included in delivery

Notes:
If the coupled optical power is ≥ -21.6 dBm, data output switches to LOW (inversion of optical data signal).

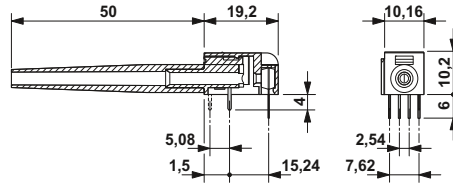

FO fast connection for PCB term. blocks with receive diode



Technical data

Technical data	
Data rate	5,00 Mbps
Transmission length	to 50 m
Ambient temperature (operation)	0 °C ... 70 °C
Ambient temperature (storage/transport)	-25 °C ... 85 °C
Transmitter	
Optical transmission capacity (at 60 mA and 25°C)	-
Forward current	-
Forward voltage (with 60 mA forward current)	-
Optical peak wavelength (0 to 70°C)	-
Receiver	
Optical receiver sensitivity (0 to 70°C)	-21.60 dBm
Optical overdrive threshold (0 to 70°C)	-2 dBm
Supply voltage	4.75 V DC ... 5.25 V DC
Connection capacity	
Polymer fiber (in acc. with IEC 60 793-2 type A4a)	980/1000 μ m
Diameter of outer sheath	2.2 mm \pm 0.07 mm

Ordering data

FO PCB terminal block with receive diode		
Color: Black		
FO PCB terminal block with transmit diode		
Color: green		
FOPT 2,2-R	1907924	10

Accessories

Bend protection sleeve	-	
Fiber cutter , for quick and easy mounting of fiber optic cables with the Ruggedline connector	-	
KST-POF	1933011	10
IBS RL FOC	2725147	1

Recommended wiring

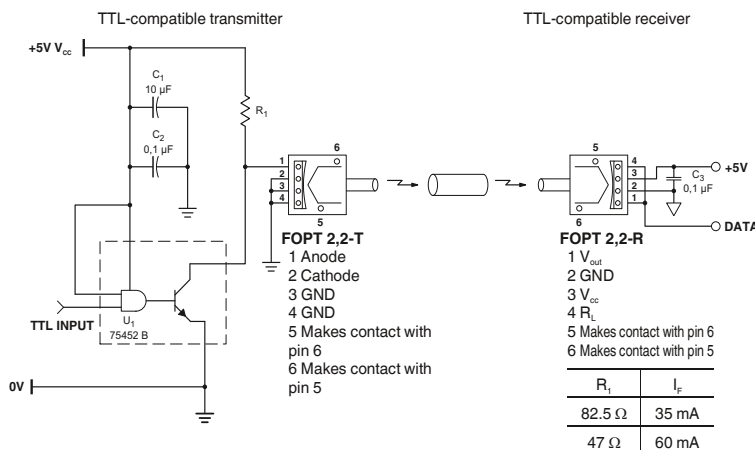



FO fast connection for PCB term. blocks with transm. diode



Technical data

5.00 Mbps
to 50 m
0 °C ... 70 °C
-25 °C ... 85 °C

-5.3 dBm ... -0.5 dBm
max. 60 mA
1.8 V
≤ 660 mm

980/1000 μm
2.2 mm ±0.07 mm

Ordering data

FOPT 2,2-T	1907911	10
------------	---------	----

Accessories

KST-POF	1933011	10
IBS RL FOC	2725147	1

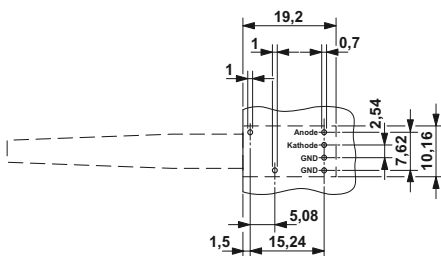

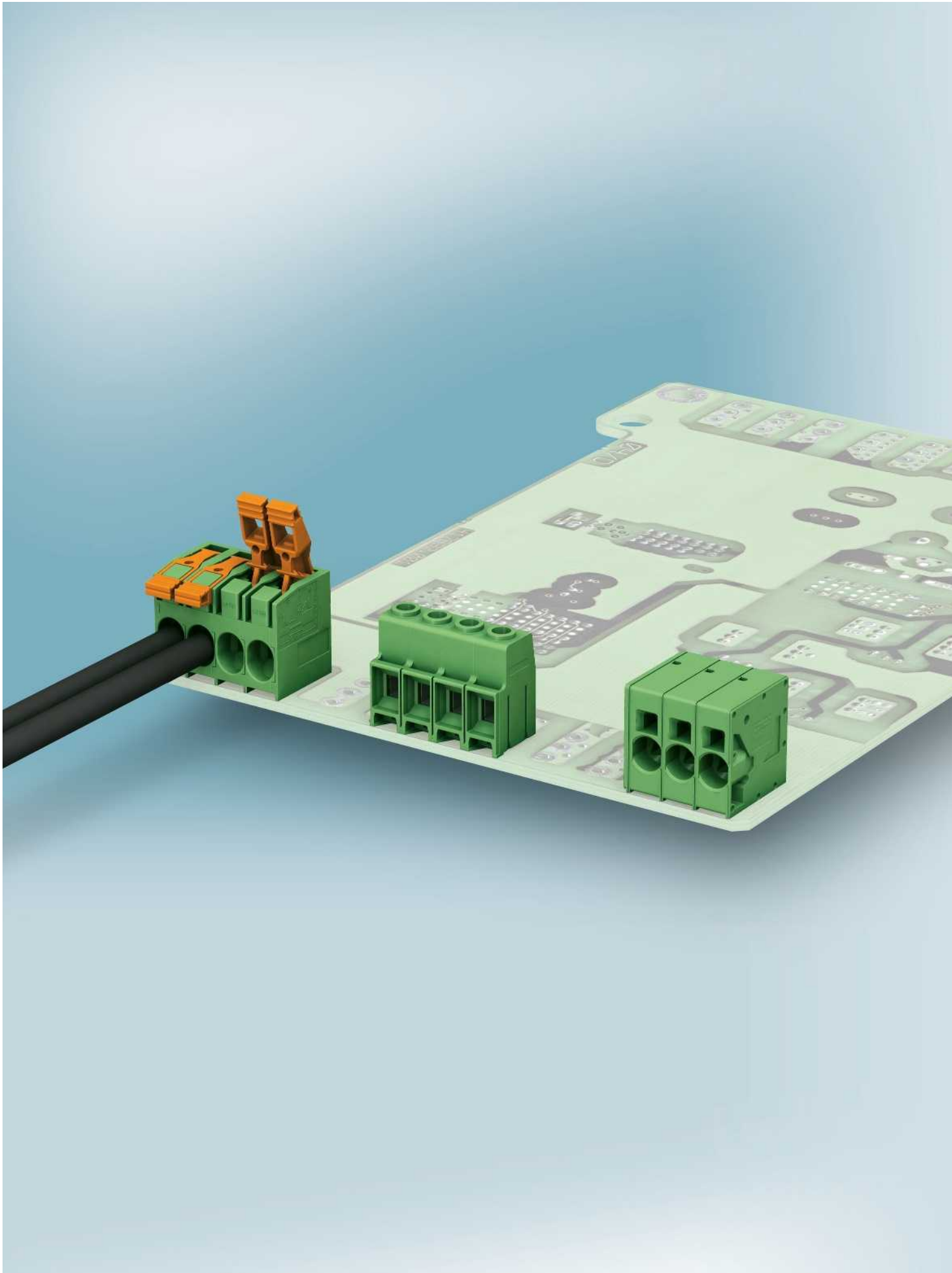

PCB terminal blocks for power electronics with pitch from 6.35 to 15.0 mm

PCB terminal blocks

High-performance PCB terminal blocks provide connection options for conductors with cross sections of 0.2 to 35 mm². The conductors are easily connected using the tension sleeve principle or the spring-cage method. This, therefore, eliminates the need for complex and costly auxiliary constructions with ring cable lugs, upstream DIN rails or modular terminal block packages.

The particularly powerful screw PCB terminal block, MKDSP 25, is designed for currents up to 125 A and has unlimited UL approval up to 600 V or 1000 V according to IEC/DIN VDE. It is connected quickly and reliably to the PCB by means of wave soldering.

The PCB terminal blocks with push-in spring connection in the SPT series (Spring Print Terminal) enable quick and user-friendly conductor connection. Stranded conductors with ferrules or solid conductors can be inserted directly into the terminal point quickly and without tools.

General	440
PCB terminal blocks with screw connection, MKDS 5 series up to 41 A/6 mm²	443
Horizontal connection direction, pitch 6.35/7.62/9.52 mm	443
600 V-UL, horizontal connection direction, pitch 6.35/9.52 mm	445
Angled connection direction, pitch 6.35/9.52 mm	447
Double-level design, pitch 6.35/9.52 mm	449
PCB terminal blocks with screw connection, MKDS 10 series up to 76 A/16 mm²	451
Horizontal connection direction, pitch 10.16/12.7 mm	451
600 V-UL, horizontal connection direction, pitch 10.16/12.7 mm	453
PCB terminal blocks with screw connection, MKDSP 25 series, up to 125 A/35 mm²	453
Horizontal connection direction, pitch 15 mm	453
Special designs with screw connection, KDS 10, Front 4 series, up to 76 A, 32 A/16 mm², 4 mm²	453
Feed-through PCB terminal blocks, pitch 10 mm	453
Front PCB terminal blocks, pitch 6.35/7.62 mm	459
PCB terminal blocks with push-in spring connection, SPT series, up to 41 A/6 mm², 16 mm²	463
Horizontal and vertical connection direction, pitch 7.5 mm	463
Horizontal and vertical connection direction, pitch 10 mm	465
PCB terminal blocks with push-lock spring connection, PL series, up to 41 A, 76 A/6 mm², 16 mm²	470
Horizontal and angled connection direction, pitch 7.5 mm	470
Horizontal design up to 10 mm pitch	473
PCB terminal blocks with push-lock spring connection for the reflow process, PTSPL series up to 41 A/6 mm²	475
Horizontal design without insulating housing	475
PCB terminal blocks with spring-cage connection, ZFKDS series up to 41 A, 76 A/6 mm², 16 mm²	477
Angled connection direction, pitch 7.5 mm	477
Angled connection direction, pitch 10 mm	479

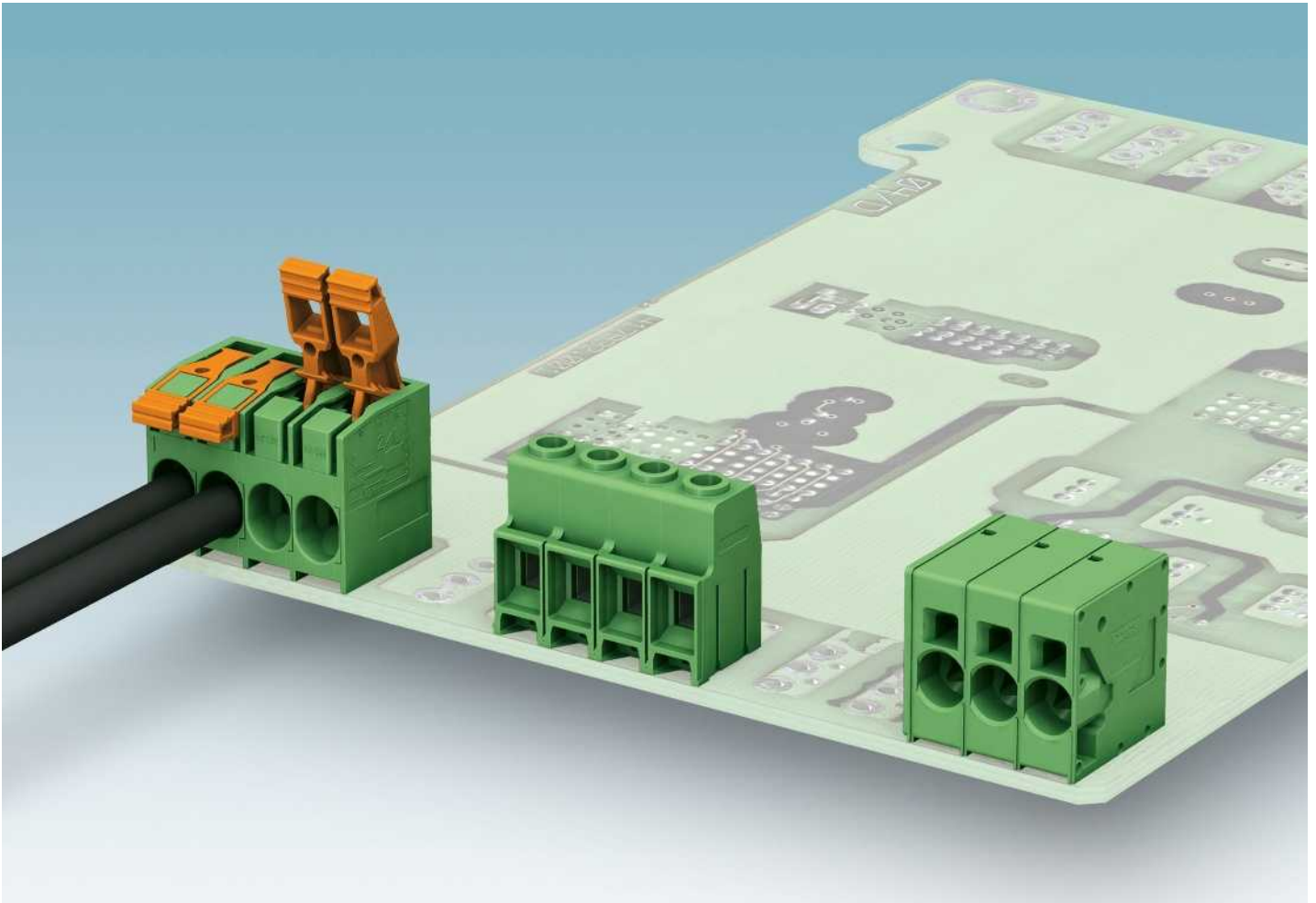

125 A via the PCB? It works!

Used in conjunction with high-current PCBs, the high-performance PCB terminal blocks support a current carrying capacity of up to 125 A.

Different PCB production technologies are providing new options for device design. The necessary functions and modules can now be grouped together on a single PCB. In this manner, expensive additional device wiring can be eliminated.

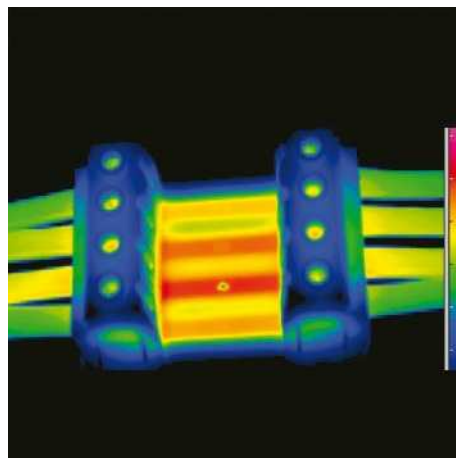
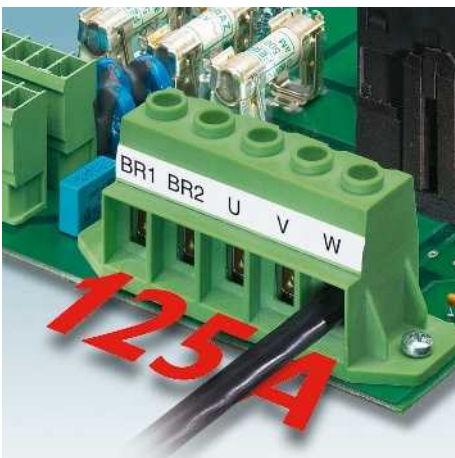

Thermographic image of a test application with 125 A

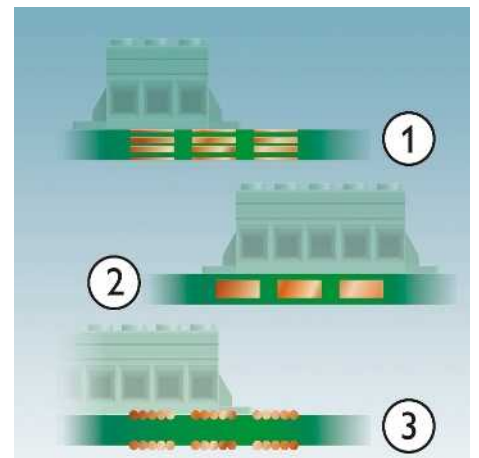

PCB production technologies

- ① = Multi-layer technology
- ② = Thick copper technology
- ③ = Wire-writing technology



Color coding

Color coding/printing, which is available as an option, enables the easy assignment of conductor/terminal points. This simplifies error-free installation of the devices to be connected. Color coding facilitates the easy and reliable implementation of work instructions such as “red conductor to red terminal point”.



UL approvals for 600 V high-current applications

The high-performance PCB terminal blocks offer 600 V UL approval for every application, even those with the smallest of dimensions. Please note that a distinction must be made here between product and device approvals. The COMBICON power flyer lists the applicable approvals for products and applications in detail.

For additional information on UL certifications, see page 42.

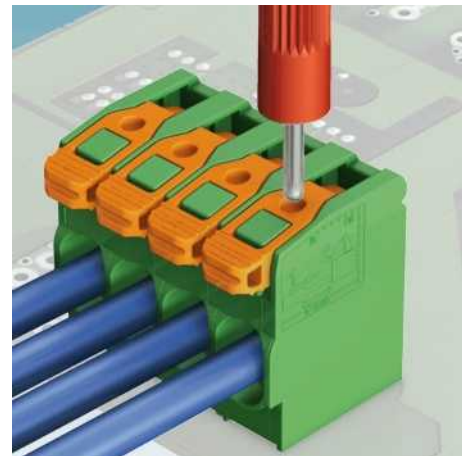

Fast and user-friendly testing

The high-performance PCB terminal block range offers a variety of products with integrated test connections/touch connections for service work and locating errors.

Measurements can, therefore, be taken easily without having to remove the wiring or other accessories.

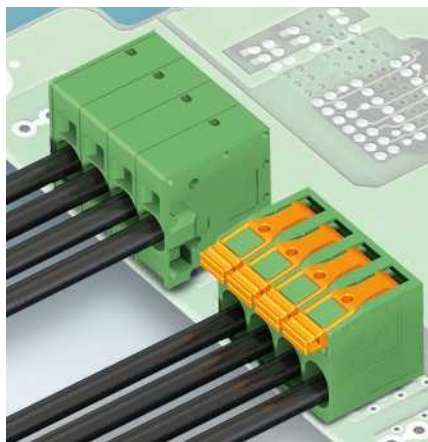

Connect large cross sections quickly and easily

With fast connection technology, conductors of up to 16 mm² are easily connected.

- With the PL series conductor connection, you can choose between the tool-free “one-hand rocker arm” principle and push-in connection.
- The SPT series with push-in connection facilitates the fast and tool-free connection of solid or stranded conductors with ferrules of up to 16 mm².

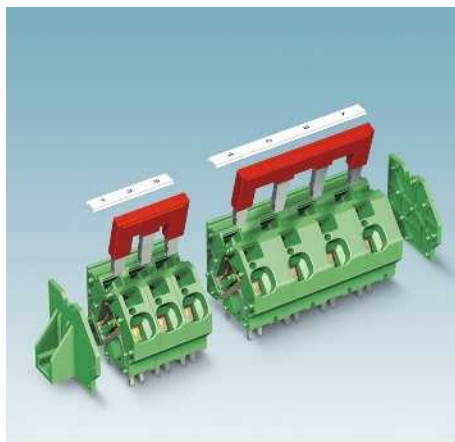

Bridges

The fully-insulated plug-in bridges in the ZFKDS series enable potential distribution or the ground conductor to be looped through. These enable the terminal blocks to be bridged electrically as required. The bridges, which are available with various numbers of positions, are inserted in the separate bridge shafts using minimal force.

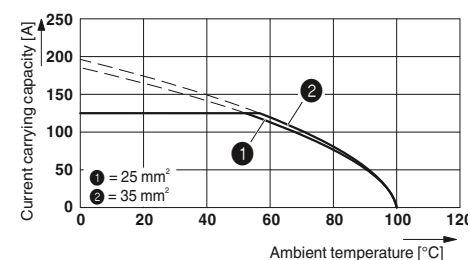

Current carrying capacity of PCB terminal blocks

Base curves are provided in the catalog so that the permitted current carrying capacity of the high-performance PCB terminal blocks can be determined. The maximum permissible current strength for a specific application can be read depending on the ambient temperature. The number of positions and the connection cross section of a conductor must be taken into account while doing so. Please also refer to the laboratory data sheets of the corresponding products. More information can be found on page 854.

PCB terminal blocks for power electronics with pitch from 6.35 to 15.0 mm

PCB terminal blocks with screw connection, MKDS 5 series up to 41 A/6 mm²

Horizontal connection direction, pitch 6.35/7.62/9.52 mm





- PCB terminal blocks with screw connection up to 6 mm² conductor cross section
- 2 and 3-pos. terminal block bases in order to set up any number of positions
- Different pitches to fulfill different voltage requirements (6.35 mm / 7.62 mm / 9.52 mm)
- Versions with anti-rotation pins (MKDSV, recommended for 2-pos. connections)

Notes:

In order to avoid tolerances between the terminal blocks and PCB, the terminal row should be interrupted when the number of positions exceeds 30.

1) Please observe the current carrying capacity curves and laboratory data sheets. Further current carrying capacity curves on request.

Accessories

For all types	Type	Page
	Screwdriver SZS 0,6 x 3,5 Order No. 1205053	
	Marker cards SK 6,2/3,8 or SK 7,5/3,8 or SK 5 WH:REEL	799

Current carrying capacity curve

Type: MKDS 5/2-6,35 and MKDS 5/3-6,35
Test following DIN EN 60512-5-2:2003-01
Reduction factor = 1
No. of positions: 5

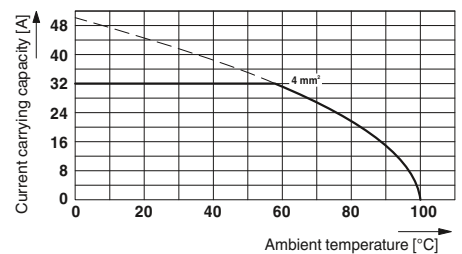

Technical data

Technical data in accordance to IEC / DIN VDE

Rated current / conductor cross section	[A] / [mm ²]
Rated insulation voltage for pollution degree 2	[V]
Pitch	[mm]
Connection capacity	
Solid / stranded	[mm ²] / [mm ²] / AWG
Stranded with ferrules without plastic sleeve	[mm ²]
Stranded with ferrules with plastic sleeve	[mm ²]
Multi-conductor connection capacity (two conductors with the same cross section)	
Solid / stranded	[mm ²]
Stranded with ferrules without plastic sleeve	[mm ²]
Stranded with TWIN ferrule with plastic sleeve	[mm ²]
Insulation coordination	
Surge voltage category / pollution degree	
Rated insulation voltage	[V]
Rated surge voltage	[kV]
Approval data (UL/CUL)	Use Group
Nominal voltage	[V]
Nominal current	[A]
Connection capacity AWG	AWG
Approval data (CSA)	Use Group
Nominal voltage	[V]
Nominal current	[A]
Connection capacity AWG	AWG
General data	
Stripping length	[mm]
Screw thread	
Tightening torque	[Nm]
Type of insulation material / insulation material group	
Inflammability class according to UL 94	
Drill hole diameter / pin dimensions	[mm]

MKDS 5/...6,35

Rated current / conductor cross section	32 ¹⁾ / 6
Rated insulation voltage for pollution degree 2	630
Pitch	6.35
Connection capacity	
Solid / stranded	0.2 - 6 / 0.2 - 4 / 24 - 10
Stranded with ferrules without plastic sleeve	0.25 - 4
Stranded with ferrules with plastic sleeve	0.25 - 4
Multi-conductor connection capacity (two conductors with the same cross section)	
Solid / stranded	0.2 - 1.5 / 0.2 - 1.5
Stranded with ferrules without plastic sleeve	0.25 - 0.75
Stranded with TWIN ferrule with plastic sleeve	0.5 - 2.5
Insulation coordination	
Surge voltage category / pollution degree	III / 3 III / 2 II / 2
Rated insulation voltage	500 630 1000
Rated surge voltage	6 6 6
Approval data (UL/CUL)	B C D
Nominal voltage	300 - 300
Nominal current	30 - 10
Connection capacity AWG	30 - 10 - 30 - 10
Approval data (CSA)	B C D
Nominal voltage	300 - 300
Nominal current	10 - 10
Connection capacity AWG	28 - 10 - 28 - 10
General data	
Stripping length	8
Screw thread	M3
Tightening torque	0.5 - 0.6
Type of insulation material / insulation material group	PA / I
Inflammability class according to UL 94	V0
Drill hole diameter / pin dimensions	1.3 / 0.9 x 0.9 mm

MKDS 5/ ...7,62

Rated current / conductor cross section	32 ¹⁾ / 6
Rated insulation voltage for pollution degree 2	630
Pitch	7.62
Connection capacity	
Solid / stranded	0.2 - 6 / 0.2 - 4 / 24 - 10
Stranded with ferrules without plastic sleeve	0.25 - 4
Stranded with ferrules with plastic sleeve	0.25 - 4
Multi-conductor connection capacity (two conductors with the same cross section)	
Solid / stranded	0.2 - 1.5 / 0.2 - 1.5
Stranded with ferrules without plastic sleeve	0.25 - 0.75
Stranded with TWIN ferrule with plastic sleeve	0.5 - 2.5
Insulation coordination	
Surge voltage category / pollution degree	III / 3 III / 2 II / 2
Rated insulation voltage	500 630 1000
Rated surge voltage	6 6 6
Approval data (UL/CUL)	B C D
Nominal voltage	300 - 300
Nominal current	30 - 10
Connection capacity AWG	30 - 10 - 30 - 10
Approval data (CSA)	B C D
Nominal voltage	300 - 300
Nominal current	- - -
Connection capacity AWG	- - -
General data	
Stripping length	8
Screw thread	M3
Tightening torque	0.5 - 0.6
Type of insulation material / insulation material group	PA / I
Inflammability class according to UL 94	V0
Drill hole diameter / pin dimensions	1.3 / 0.9 x 0.9 mm

MKDS 5/...9,52

Rated current / conductor cross section	32 ¹⁾ / 6
Rated insulation voltage for pollution degree 2	1000
Pitch	9.52
Connection capacity	
Solid / stranded	0.2 - 6 / 0.2 - 4 / 24 - 10
Stranded with ferrules without plastic sleeve	0.25 - 4
Stranded with ferrules with plastic sleeve	0.25 - 4
Multi-conductor connection capacity (two conductors with the same cross section)	
Solid / stranded	0.2 - 1.5 / 0.2 - 1.5
Stranded with ferrules without plastic sleeve	0.25 - 0.75
Stranded with TWIN ferrule with plastic sleeve	0.5 - 2.5
Insulation coordination	
Surge voltage category / pollution degree	III / 3 III / 2 II / 2
Rated insulation voltage	690 1000 1000
Rated surge voltage	6 6 6
Approval data (UL/CUL)	B C D
Nominal voltage	300 300 600
Nominal current	30 30 5
Connection capacity AWG	30 - 10 30 - 10 30 - 10
Approval data (CSA)	B C D
Nominal voltage	300 300 -
Nominal current	30 30 -
Connection capacity AWG	28 - 10 28 - 10 -
General data	
Stripping length	8
Screw thread	M3
Tightening torque	0.5 - 0.6
Type of insulation material / insulation material group	PA / I
Inflammability class according to UL 94	V0
Drill hole diameter / pin dimensions	1.3 / 0.9 x 0.9 mm

No. of pos.	Dim. a [mm]
2	6.35
3	12.70
2	6.35
3	12.70
2	7.62
3	15.24
2	7.62
3	15.24
2	9.52
3	19.04
2	9.52
3	19.04



6.35 mm pitch



7.62 mm pitch



9.52 mm pitch



Dimensional drawing

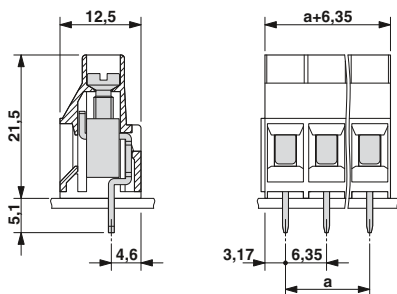

Drilling diagram

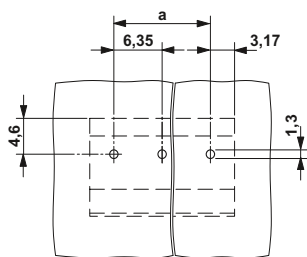

Ordering data

Type	Order No.	Pcs. / Pkt.
6.35 mm pitch, color: green		
MKDS 5/ 2-6,35	1714955	50
MKDS 5/ 3-6,35	1714968	50
6.35 mm pitch, color: green, with anti-rotation pins, for drilling plans and dimensional drawings see www.phoenixcontact.net/products .		
MKDSV 5/ 2-6,35	1710056	50
MKDSV 5/ 3-6,35	1710085	50



Dimensional drawing

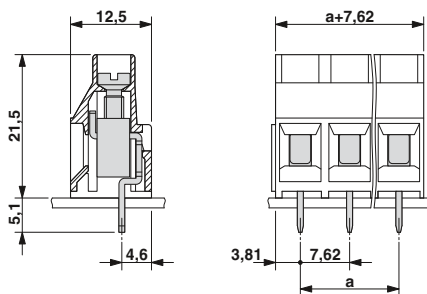

Drilling diagram

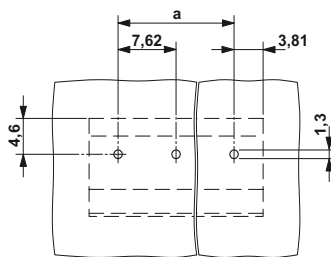

Ordering data

Type	Order No.	Pcs. / Pkt.
Pitch 7.62 mm, color: green		
MKDS 5/ 2-7,62	1868076	50
MKDS 5/ 3-7,62	1704936	50
7.62 mm pitch, color: green, with anti-rotation pins, for drilling plans and dimensional drawings see www.phoenixcontact.net/products .		
MKDSV 5/ 2-7,62	1907131	50
MKDSV 5/ 3-7,62	1907144	50



Dimensional drawing

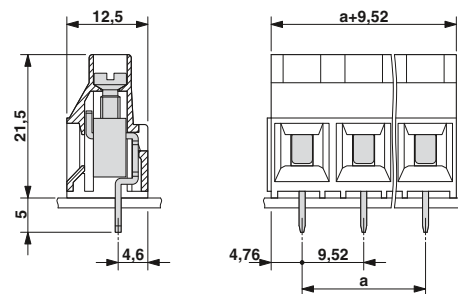

Drilling diagram

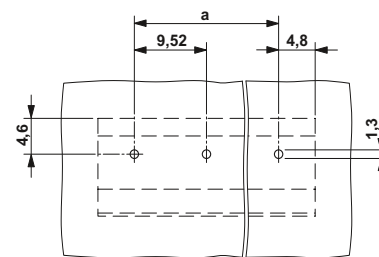

Ordering data

Type	Order No.	Pcs. / Pkt.
9.52 mm pitch, color: green		
MKDS 5/ 2-9,5	1714971	50
MKDS 5/ 3-9,5	1714984	50
9.52 mm pitch, color: green, with anti-rotation pins, for drilling plans and dimensional drawings see www.phoenixcontact.net/products .		
MKDSV 5/ 2-9,5	1710072	50
MKDSV 5/ 3-9,5	1710069	50

PCB terminal blocks for power electronics with pitch from 6.35 to 15.0 mm

PCB terminal blocks with screw connection, MKDS 5 series up to 41 A/6 mm²

600 V-UL, horizontal connection direction, pitch 6.35/9.52 mm

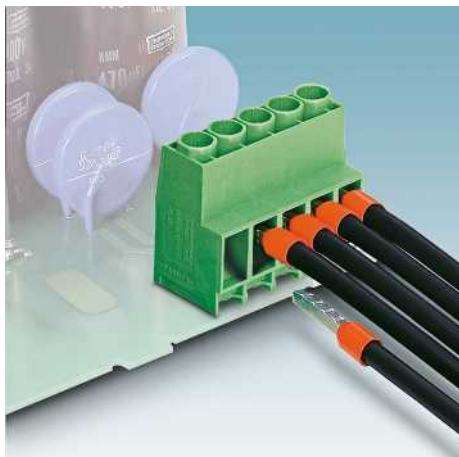

- High-voltage MKDS 5N HV PCB terminal blocks with increased air and creepage distances
- Unrestricted 600 V UL approval, thanks to compact Z pinning (MKDS 5N HV/...ZB-6,35 and MKDS 5 HV/...-9,52-Z)

MKDS 5 HV/...-9,52...



- 2 and 3-pos. terminal block bases in order to set up any number of positions
- Versions with anti-rotation pins (MKDSV, recommended for 2-pos. connections)

Notes:

In order to avoid tolerances between the terminal blocks and PCB, the terminal row should be interrupted when the number of positions exceeds 30.

1) Please observe the current carrying capacity curves and laboratory data sheets. Further current carrying capacity curves on request.

Accessories

For all types	Type	Page
	Screwdriver SZS 0,6 x 3,5 Order No. 1205053	
	Marker cards SK 6,2/3,8 or SK 5,0 WH:REEL	799

Current carrying capacity curve

Type: MKDS 5 HV/2-9,52 and MKDS 5 HV/3-9,52

Test following DIN EN 60512-5-2:2003-01

Reduction factor = 1

No. of positions: 5

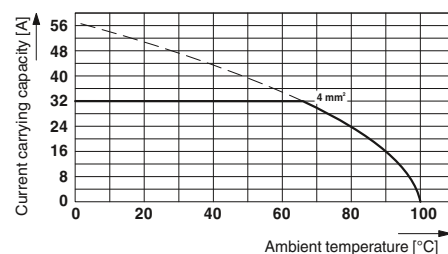

Technical data

Technical data in accordance to IEC / DIN VDE

Rated current / conductor cross section	[A] / [mm ²]	
Rated insulation voltage for pollution degree 2	[V]	
Pitch	[mm]	
Connection capacity		
Solid / stranded	[mm ²] / [mm ²] / AWG	
Stranded with ferrules without plastic sleeve	[mm ²]	
Stranded with ferrules with plastic sleeve	[mm ²]	
Multi-conductor connection capacity (two conductors with the same cross section)		
Solid / stranded	[mm ²]	
Stranded with ferrules without plastic sleeve	[mm ²]	
Stranded with TWIN ferrule with plastic sleeve	[mm ²]	
Insulation coordination		
Surge voltage category / pollution degree		
Rated insulation voltage	[V]	
Rated surge voltage	[kV]	
Approval data (UL/CUL)	Use Group	
Nominal voltage	[V]	
Nominal current	[A]	
Connection capacity AWG	AWG	
Approval data (CSA)	Use Group	
Nominal voltage	[V]	
Nominal current	[A]	
Connection capacity AWG	AWG	
General data		
Stripping length	[mm]	
Screw thread		
Tightening torque	[Nm]	
Type of insulation material / insulation material group		
Inflammability class according to UL 94		
Drill hole diameter / pin dimensions	[mm]	

MKDS 5N HV/ ...-ZB-6,35

Rated current / conductor cross section	41 ¹⁾ / 6
Rated insulation voltage for pollution degree 2	1000
Pitch	6.35
Connection capacity	
Solid / stranded	0.2 - 6 / 0.2 - 4 / 24 - 10
Stranded with ferrules without plastic sleeve	0.25 - 4
Stranded with ferrules with plastic sleeve	0.25 - 4
Multi-conductor connection capacity (two conductors with the same cross section)	
Solid / stranded	0.2 - 1.5 / 0.2 - 1.5
Stranded with ferrules without plastic sleeve	0.25 - 0.75
Stranded with TWIN ferrule with plastic sleeve	0.5 - 2.5
Insulation coordination	
Surge voltage category / pollution degree	III / 3 III / 2 II / 2
Rated insulation voltage	800 1000 1000
Rated surge voltage	8 8 8
Approval data (UL/CUL)	B C D
Nominal voltage	600 600 -
Nominal current	30 30 -
Connection capacity AWG	30 - 10 30 - 10 -
Approval data (CSA)	B C D
Nominal voltage	- - -
Nominal current	- - -
Connection capacity AWG	- - -
General data	
Stripping length	8
Screw thread	M3
Tightening torque	0.5 - 0.6
Type of insulation material / insulation material group	PA / I
Inflammability class according to UL 94	V0
Drill hole diameter / pin dimensions	1.3 / 0.9 x 0.9 mm

MKDS 5 HV/ ...-9,52

Rated current / conductor cross section	32 ¹⁾ / 6
Rated insulation voltage for pollution degree 2	1000
Pitch	9.52
Connection capacity	
Solid / stranded	0.2 - 6 / 0.2 - 4 / 24 - 10
Stranded with ferrules without plastic sleeve	0.25 - 4
Stranded with ferrules with plastic sleeve	0.25 - 4
Multi-conductor connection capacity (two conductors with the same cross section)	
Solid / stranded	0.2 - 1.5 / 0.2 - 1.5
Stranded with ferrules without plastic sleeve	0.25 - 0.75
Stranded with TWIN ferrule with plastic sleeve	0.5 - 2.5
Insulation coordination	
Surge voltage category / pollution degree	III / 3 III / 2 II / 2
Rated insulation voltage	800 1000 1000
Rated surge voltage	8 8 6
Approval data (UL/CUL)	B C D
Nominal voltage	300 300 600
Nominal current	30 30 5
Connection capacity AWG	30 - 10 30 - 10 30 - 10
Approval data (CSA)	B C D
Nominal voltage	- - -
Nominal current	- - -
Connection capacity AWG	- - -
General data	
Stripping length	8
Screw thread	M3
Tightening torque	0.5 - 0.6
Type of insulation material / insulation material group	PA / I
Inflammability class according to UL 94	V0
Drill hole diameter / pin dimensions	1.3 / 0.9 x 0.9 mm

MKDS 5 HV/ ...-9,52-Z

Rated current / conductor cross section	32 ¹⁾ / 6
Rated insulation voltage for pollution degree 2	1000
Pitch	9.52
Connection capacity	
Solid / stranded	0.2 - 6 / 0.2 - 4 / 24 - 10
Stranded with ferrules without plastic sleeve	0.25 - 4
Stranded with ferrules with plastic sleeve	0.25 - 4
Multi-conductor connection capacity (two conductors with the same cross section)	
Solid / stranded	0.2 - 1.5 / 0.2 - 1.5
Stranded with ferrules without plastic sleeve	0.25 - 0.75
Stranded with TWIN ferrule with plastic sleeve	0.5 - 2.5
Insulation coordination	
Surge voltage category / pollution degree	III / 3 III / 2 II / 2
Rated insulation voltage	690 1000 1000
Rated surge voltage	8 8 6
Approval data (UL/CUL)	B C D
Nominal voltage	600 600 -
Nominal current	30 30 -
Connection capacity AWG	30 - 10 30 - 10 -
Approval data (CSA)	B C D
Nominal voltage	- - -
Nominal current	- - -
Connection capacity AWG	- - -
General data	
Stripping length	8
Screw thread	M3
Tightening torque	0.5 - 0.6
Type of insulation material / insulation material group	PA / I
Inflammability class according to UL 94	V0
Drill hole diameter / pin dimensions	1.3 / 0.9 x 0.9 mm

No. of pos.	Dim. a [mm]
2	6.35
3	12.70
4	19.05
5	25.40
6	31.75
7	38.10
8	44.45
9	50.80
10	57.15
11	63.50
12	69.85
2	9.52
3	19.04
2	9.52



Z pinning, 600 V UL approval,
6.35 mm pitch



Linear pinning, 300 V UL approval,
9.52 mm pitch



Z pinning, 600 V UL approval,
9.52 mm pitch



Dimensional drawing

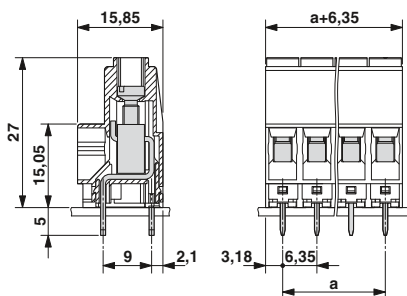

Drilling diagram

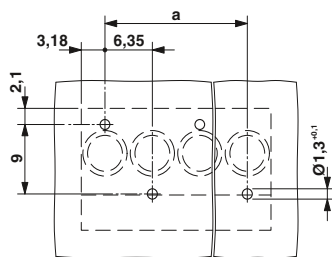

Ordering data

Type	Order No.	Pcs. / Pkt.
6.35 mm pitch, color: green		
MKDS 5N HV/ 2-ZB-6,35	1777545	50
MKDS 5N HV/ 3-ZB-6,35	1777558	50
MKDS 5N HV/ 4-ZB-6,35	1777561	50
MKDS 5N HV/ 5-ZB-6,35	1777574	50
MKDS 5N HV/ 6-ZB-6,35	1777587	50
MKDS 5N HV/ 7-ZB-6,35	1777590	50
MKDS 5N HV/ 8-ZB-6,35	1777600	50
MKDS 5N HV/ 9-ZB-6,35	1777613	50
MKDS 5N HV/10-ZB-6,35	1777626	50
MKDS 5N HV/11-ZB-6,35	1777639	50
MKDS 5N HV/12-ZB-6,35	1777642	50



Dimensional drawing

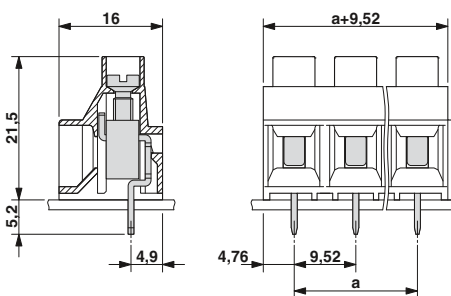

Drilling diagram

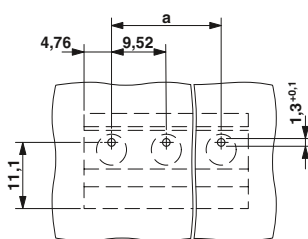

Ordering data

Type	Order No.	Pcs. / Pkt.
9.52 mm pitch, color: green		
MKDS 5 HV/ 2-9,52	1902547	50
MKDS 5 HV/ 3-9,52	1904150	50
9.52 mm pitch, color: green, with anti-rotation pins, for drilling plans and dimensional drawings see www.phoenixcontact.net/products .		
MKDSV 5 HV/ 2-9,52	1904147	50



Dimensional drawing

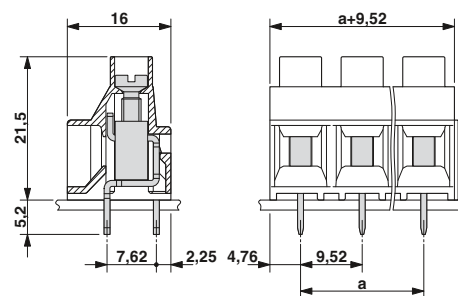

Drilling diagram

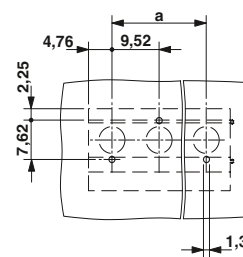

Ordering data

Type	Order No.	Pcs. / Pkt.
9.52 mm pitch, color: green		
MKDS 5 HV/ 2-9,52-Z	1907432	50
MKDS 5 HV/ 3-9,52-Z	1907429	50
9.52 mm pitch, color: green, with anti-rotation pins, for drilling plans and dimensional drawings see www.phoenixcontact.net/products .		
MKDSV 5 HV/ 2-9,52-Z	1907416	50

PCB terminal blocks for power electronics with pitch from 6.35 to 15.0 mm

PCB terminal blocks with screw connection, MKDS 5 series up to 41 A/6 mm²

Angled connection direction, pitch 6.35/9.52 mm





- Connection direction of the conductor angled to the PCB (35°)
- PCB terminal blocks with screw connection up to 6 mm² conductor cross section
- 2 and 3-pos. terminal block bases in order to set up any number of positions
- Different pitches to fulfill different voltage requirements (6.35 mm/9.52 mm)

Notes:

In order to avoid tolerances between the terminal blocks and PCB, the terminal row should be interrupted when the number of positions exceeds 30.

1) Please observe the current carrying capacity curves and laboratory data sheets. Further current carrying capacity curves on request.

Accessories

For all types	Type	Page
	Screwdriver SZS 0,6 x 3,5 Order No. 1205053	
	Marker cards SK 6,2/3,8 or SK 5,0 WH:REEL	799

Current carrying capacity curve

Type: SMKDS 5/2-6,35 and SMKDS 5/3-6,35

Test following DIN EN 60512-5-2:2003-01

Reduction factor = 1

No. of positions: 5

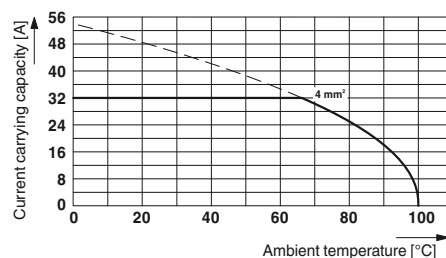

Technical data

Technical data in accordance to IEC / DIN VDE

Rated current / conductor cross section [A] / [mm²]

Rated insulation voltage for pollution degree 2 [V]

Pitch [mm]

Connection capacity

Solid / stranded [mm²] / [mm²] / AWG

Stranded with ferrules without plastic sleeve [mm²]

Stranded with ferrules with plastic sleeve [mm²]

Multi-conductor connection capacity (two conductors with the same cross section)

Solid / stranded [mm²]

Stranded with ferrules without plastic sleeve [mm²]

Stranded with TWIN ferrule with plastic sleeve [mm²]

Insulation coordination

Surge voltage category / pollution degree

Rated insulation voltage [V]

Rated surge voltage [kV]

Approval data (UL/CUL) Use Group

Nominal voltage [V]

Nominal current [A]

Connection capacity AWG AWG

Approval data (CSA) Use Group

Nominal voltage [V]

Nominal current [A]

Connection capacity AWG AWG

General data

Stripping length [mm]

Screw thread

Tightening torque [Nm]

Type of insulation material / insulation material group

Inflammability class according to UL 94

Drill hole diameter / pin dimensions [mm]

SMKDS 5/ ...-6,35

Rated current / conductor cross section	32 ¹⁾ / 6		
Rated insulation voltage for pollution degree 2	630		
Pitch	6.35		
Connection capacity			
Solid / stranded	0.2 - 6 / 0.2 - 4 / 24 - 10		
Stranded with ferrules without plastic sleeve	0.25 - 4		
Stranded with ferrules with plastic sleeve	0.25 - 4		
Multi-conductor connection capacity (two conductors with the same cross section)			
Solid / stranded	0.2 - 1.5 / 0.2 - 1.5		
Stranded with ferrules without plastic sleeve	0.25 - 0.75		
Stranded with TWIN ferrule with plastic sleeve	0.5 - 2.5		
Insulation coordination			
Surge voltage category / pollution degree	III / 3	III / 2	II / 2
Rated insulation voltage	500	630	1000
Rated surge voltage	6	6	6
Approval data (UL/CUL)	B	C	D
Nominal voltage	250	-	300
Nominal current	30	-	10
Connection capacity AWG	30 - 10	-	30 - 10
Approval data (CSA)	B	C	D
Nominal voltage	300	-	300
Nominal current	10	-	10
Connection capacity AWG	28 - 10	-	28 - 10
General data			
Stripping length	8		
Screw thread	M3		
Tightening torque	0.5 - 0.6		
Type of insulation material / insulation material group	PA / I		
Inflammability class according to UL 94	V2		
Drill hole diameter / pin dimensions	1.3 / 0.9 x 0.9 mm		

SMKDS 5/ ...-9,52

Rated current / conductor cross section	32 ¹⁾ / 6		
Rated insulation voltage for pollution degree 2	1000		
Pitch	9.52		
Connection capacity			
Solid / stranded	0.2 - 6 / 0.2 - 4 / 24 - 10		
Stranded with ferrules without plastic sleeve	0.25 - 4		
Stranded with ferrules with plastic sleeve	0.25 - 4		
Multi-conductor connection capacity (two conductors with the same cross section)			
Solid / stranded	0.2 - 1.5 / 0.2 - 1.5		
Stranded with ferrules without plastic sleeve	0.25 - 0.75		
Stranded with TWIN ferrule with plastic sleeve	0.5 - 2.5		
Insulation coordination			
Surge voltage category / pollution degree	III / 3	III / 2	II / 2
Rated insulation voltage	690	1000	1000
Rated surge voltage	6	6	6
Approval data (UL/CUL)	B	C	D
Nominal voltage	250	300	-
Nominal current	30	30	-
Connection capacity AWG	30 - 10	30 - 10	-
Approval data (CSA)	B	C	D
Nominal voltage	300	300	-
Nominal current	30	30	-
Connection capacity AWG	28 - 10	28 - 10	-
General data			
Stripping length	8		
Screw thread	M3		
Tightening torque	0.5 - 0.6		
Type of insulation material / insulation material group	PA / I		
Inflammability class according to UL 94	V2		
Drill hole diameter / pin dimensions	1.3 / 0.9 x 0.9 mm		

No. of pos.

Dim. a [mm]

2 6.35

3 12.70

2 9.52

3 19.04



6.35 mm pitch,
35° angled connection direction



9.52 mm pitch,
35° angled connection direction



Dimensional drawing

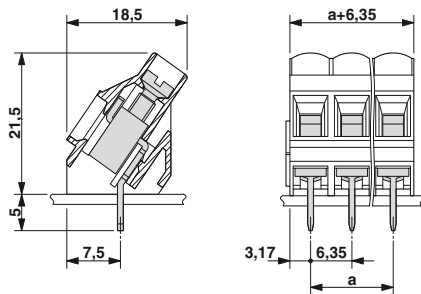

Drilling diagram

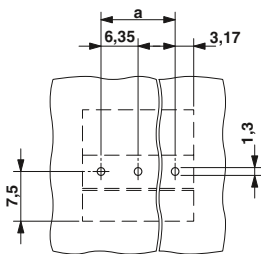

Dimensional drawing

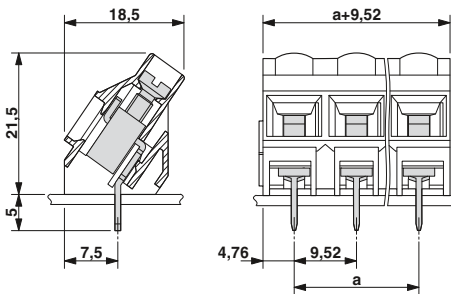

Drilling diagram

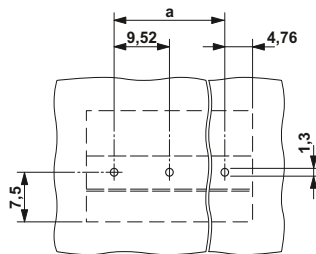

Ordering data

Type	Order No.	Pcs. / Pkt.
6.35 mm pitch, color: green		
SMKDS 5/ 2-6,35	1720033	50
SMKDS 5/ 3-6,35	1720046	50

Ordering data

Type	Order No.	Pcs. / Pkt.
9.52 mm pitch, color: green		
SMKDS 5/ 2-9,5	1720017	50
SMKDS 5/ 3-9,5	1720020	50

PCB terminal blocks for power electronics with pitch from 6.35 to 15.0 mm

PCB terminal blocks with screw connection, MKDS 5 series up to 41 A/6 mm²

Double-level design, pitch 6.35/9.52 mm



- Double-level PCB terminal blocks with a screw connection up to 6 mm² conductor cross section
- Different pitches to fulfill different voltage requirements (6.35 mm/9.52 mm)
- 2 and 3-pos. terminal block bases in order to set up any number of positions
- Lateral offset of terminal points for better accessibility of cable funnels

Notes:

In order to avoid tolerances between the terminal blocks and PCB, the terminal row should be interrupted when the number of positions exceeds 30.

1) Please observe the current carrying capacity curves and laboratory data sheets. Further current carrying capacity curves on request.

Accessories

For all types	Type	Page
	Screwdriver SZS 0,6 x 3,5 Order No. 1205053	
	Marker cards SK 6,2/3,8 or SK 5,0 WH:REEL	799

Current carrying capacity curve

Type: MKKDS 5/2-6,35 and MKKDS 5/3-6,35
Test following DIN EN 60512-5-2:2003-01
Reduction factor = 1
No. of positions: 5

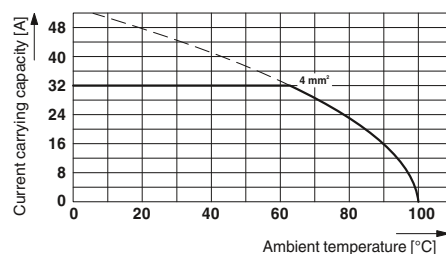

Technical data

Technical data in accordance to IEC / DIN VDE

Rated current / conductor cross section [A] / [mm²]
Rated insulation voltage for pollution degree 2 [V]

Pitch [mm]

Connection capacity

Solid / stranded [mm²] / [mm²] / AWG

Stranded with ferrules without plastic sleeve [mm²]

Stranded with ferrules with plastic sleeve [mm²]

Multi-conductor connection capacity (two conductors with the same cross section)

Solid / stranded [mm²]

Stranded with ferrules without plastic sleeve [mm²]

Stranded with TWIN ferrule with plastic sleeve [mm²]

Insulation coordination

Surge voltage category / pollution degree

Rated insulation voltage [V]

Rated surge voltage [kV]

Approval data (UL/CUL) Use Group

Nominal voltage [V]

Nominal current [A]

Connection capacity AWG AWG

Approval data (CSA) Use Group

Nominal voltage [V]

Nominal current [A]

Connection capacity AWG AWG

General data

Stripping length [mm]

Screw thread

Tightening torque [Nm]

Type of insulation material / insulation material group

Inflammability class according to UL 94

Drill hole diameter / pin dimensions [mm]

MKKDS 5/ ...-6,35

Rated current / conductor cross section [A] / [mm ²]			32 ¹⁾ / 6			32 ¹⁾ / 6		
Rated insulation voltage for pollution degree 2 [V]			630			1000		
Pitch [mm]			6.35			9.52		
Connection capacity								
Solid / stranded [mm ²] / [mm ²] / AWG			0.2 - 6 / 0.2 - 4 / 24 - 10			0.2 - 6 / 0.2 - 4 / 24 - 10		
Stranded with ferrules without plastic sleeve [mm ²]			0.25 - 2.5			0.25 - 2.5		
Stranded with ferrules with plastic sleeve [mm ²]			0.25 - 4			0.25 - 4		
Multi-conductor connection capacity (two conductors with the same cross section)								
Solid / stranded [mm ²]			0.2 - 1.5 / 0.2 - 1.5			0.2 - 1.5 / 0.2 - 1.5		
Stranded with ferrules without plastic sleeve [mm ²]			0.25 - 0.75			0.25 - 0.75		
Stranded with TWIN ferrule with plastic sleeve [mm ²]			0.5 - 2.5			0.5 - 2.5		
Insulation coordination								
Surge voltage category / pollution degree			III / 3 III / 2 II / 2			III / 3 III / 2 II / 2		
Rated insulation voltage [V]			500 630 1000			690 1000 1000		
Rated surge voltage [kV]			6 6 6			6 6 6		
Approval data (UL/CUL) Use Group			B C D			B C D		
Nominal voltage [V]			300 - - 300			300 300 600		
Nominal current [A]			30 - - 10			30 30 5		
Connection capacity AWG AWG			30 - 10 - 30 - 10			30 - 10 30 - 10 30 - 10		
Approval data (CSA) Use Group			B C D			B C D		
Nominal voltage [V]			300 - - 300			300 300 -		
Nominal current [A]			10 - - 10			30 30 -		
Connection capacity AWG AWG			28 - 10 - 28 - 10			28 - 10 28 - 10 -		
General data								
Stripping length [mm]			8			8		
Screw thread			M3			M3		
Tightening torque [Nm]			0.5 - 0.6			0.5 - 0.6		
Type of insulation material / insulation material group			PA / I			PA / I		
Inflammability class according to UL 94			V0			V2		
Drill hole diameter / pin dimensions [mm]			1.3 / 0.9 x 0.9 mm			1.3 / 0.9 x 0.9 mm		

No. of pos. Dim. a [mm]

2 6.35
3 12.70

2 9.52
3 19.04



6.35 mm pitch,
double-level PCB terminal block



9.52 mm pitch,
double-level PCB terminal block



Dimensional drawing

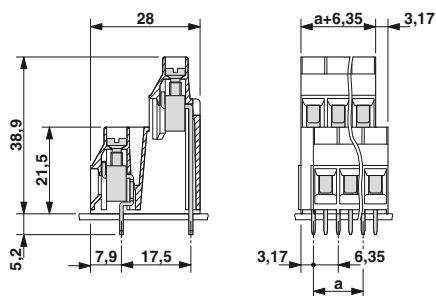

Drilling diagram

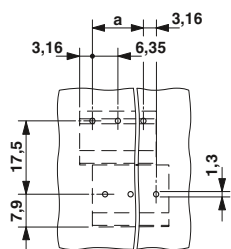

Ordering data

Type	Order No.	Pcs. / Pkt.
6.35 mm pitch, color: green		
MKKDS 5/ 2-6,35	1719031	50
MKKDS 5/ 3-6,35	1719044	50



Dimensional drawing

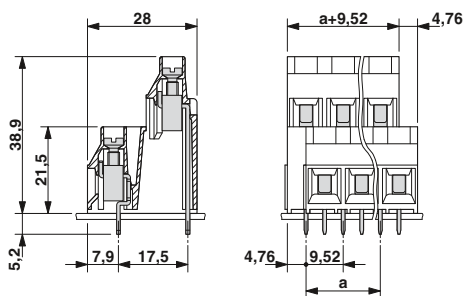

Drilling diagram

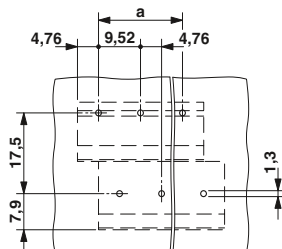

Ordering data

Type	Order No.	Pcs. / Pkt.
9.52 mm pitch, color: green		
MKKDS 5/ 2-9,5	1719015	50
MKKDS 5/ 3-9,5	1719028	50

PCB terminal blocks for power electronics with pitch from 6.35 to 15.0 mm

PCB terminal blocks with screw connection, MKDS 10 series up to 76 A/16 mm²

Horizontal connection direction, pitch 10.16/12.7 mm



- High-capacity PCB terminal blocks with a screw connection up to 16 mm² flexible and a current carrying capacity of 76 A
- Individual adjustment of voltage requirements using RZ pitch spacers (MKDS 10 HV)
- MKDSP 10 HV...-12,7 with unrestricted 600-V-UL approval
- Integrated test connection
- Terminal block bases that can be lined up next to each other in order to set up any number of positions

Notes:
In order to avoid tolerances between the terminal blocks and PCB, the terminal row should be interrupted when the number of positions exceeds 30.
When using ferrules for 16 mm ² conductors, crimp with CRIMPFOX 16 S (see accessories).
1) Please observe the current carrying capacity curves and laboratory data sheets. Further current carrying capacity curves on request.

Accessories		
For all types	Type	Page
	Test plug MPS	831
	Screwdriver SZS 0,6 x 3,5 Order No. 1205053	
	Marker strips SK 5,0 WH:REEL Order No. 0805221	801
	Crimping pliers for 0.25 to 6 mm ² CRIMPFOX 6 Order No. 1212034	
	Crimping pliers for 10 to 16 mm ² CRIMPFOX 16 S Order No. 1207983	
Only for MKDSP 10 HV...-12,7		
	Pitch spacer, width: 2.54 mm RZ-MKDSP 10 HV-2,54 Order No. 1929672	

Current carrying capacity curve
 Type: MKDSP 10N/...-10,16
 Tested in accordance with DIN EN 60512-5-2:2003-01
 Reduction factor = 1
 No. of positions: 5

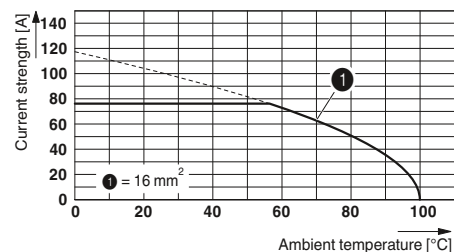

Technical data

Technical data in accordance to IEC / DIN VDE	
Rated current / conductor cross section	[A] / [mm ²]
Rated insulation voltage for pollution degree 2	[V]
Pitch	[mm]
Connection capacity	
Solid / stranded	[mm ²] / [mm ²] / AWG
Stranded with ferrules without plastic sleeve	[mm ²]
Stranded with ferrules with plastic sleeve	[mm ²]
Multi-conductor connection capacity (two conductors with the same cross section)	
Solid / stranded	[mm ²]
Stranded with ferrules without plastic sleeve	[mm ²]
Stranded with TWIN ferrule with plastic sleeve	[mm ²]
Insulation coordination	
Surge voltage category / pollution degree	
Rated insulation voltage	[V]
Rated surge voltage	[kV]
Approval data (UL/CUL)	Use Group
Nominal voltage	[V]
Nominal current	[A]
Connection capacity AWG	AWG
Approval data (CSA)	Use Group
Nominal voltage	[V]
Nominal current	[A]
Connection capacity AWG	AWG
General data	
Stripping length	[mm]
Screw thread	
Tightening torque	[Nm]
Type of insulation material / insulation material group	
Inflammability class according to UL 94	
Drill hole diameter / pin dimensions	[mm]

MKDSP 10N/ ...-10,16			MKDSP 10HV/ ...-10,16			MKDSP 10HV/ ...-12,7		
76 ¹⁾ / 16			76 ¹⁾ / 16			76 ¹⁾ / 16		
1000			1000			1000		
10.16			10.16			12.7		
0.5 - 16 / 0.5 - 16 / 20 - 6			0.5 - 16 / 0.5 - 16 / 20 - 6			0.5 - 16 / 0.5 - 16 / 20 - 6		
0.5 - 16			0.5 - 16			0.5 - 16		
0.5 - 16			0.5 - 16			0.5 - 16		
0.5 - 4 / 0.5 - 4			0.5 - 4 / 0.5 - 4			0.5 - 4 / 0.5 - 4		
0.5 - 2.5			0.5 - 2.5			0.5 - 2.5		
0.5 - 6			0.5 - 6			0.5 - 6		
III / 3	III / 2	II / 2	III / 3	III / 2	II / 2	III / 3	III / 2	II / 2
690	1000	1000	690	1000	1000	1000	1000	1000
8	8	6	8	8	6	8	8	6
B	C	D	B	C	D	B	C	D
300	300	600	300	300	600	600	600	-
60	60	5	60	60	5	60	60	-
20 - 6	20 - 6	20 - 6	20 - 6	20 - 6	20 - 6	20 - 6	20 - 6	-
B	C	D	B	C	D	B	C	D
-	-	-	-	-	-	-	-	-
-	-	-	-	-	-	-	-	-
-	-	-	-	-	-	-	-	-
10			10			10		
M4			M4			M4		
1.2 - 1.5			1.2 - 1.5			1.2 - 1.5		
PA / I			PA / I			PA / I		
V0			V0			V0		
1.5 / 1 x 0.9 mm			1.5 / 1 x 0.9 mm			1.5 / 1 x 0.9 mm		

No. of pos.	Dim. a [mm]
2	10.16
3	20.32
2	10.16
3	20.32
2	12.70
3	25.40

PCB terminal blocks for power electronics with pitch from 6.35 to 15.0 mm

PCB terminal blocks with screw connection, MKDS 10 series up to 76 A/16 mm²



10.16 mm pitch, 300 V UL approval



10.16 mm pitch, 300 V UL approval



12.7 mm pitch, 600 V UL approval



Dimensional drawing

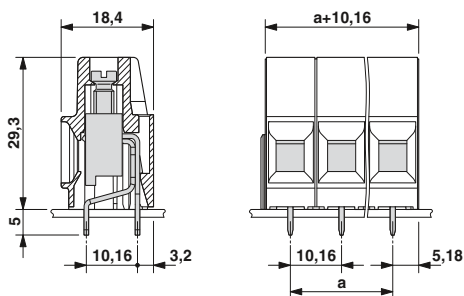

Drilling diagram

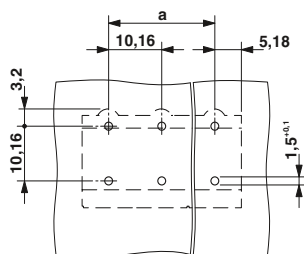

Dimensional drawing

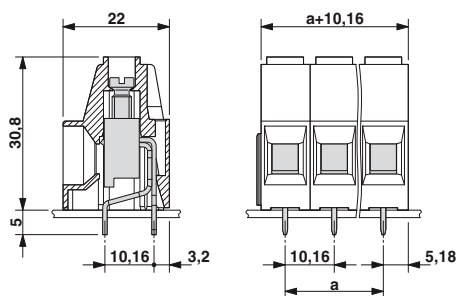

Drilling diagram

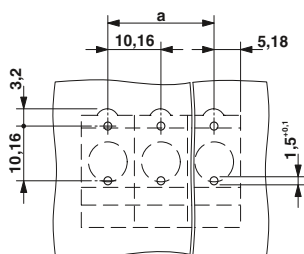

Dimensional drawing

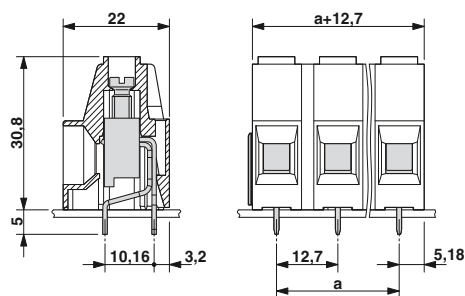

Drilling diagram

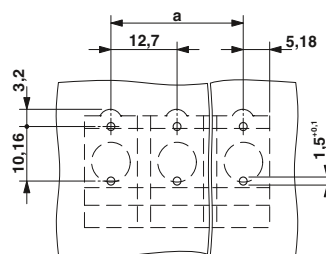

Ordering data

Type	Order No.	Pcs. / Pkt.
Pitch 10.16 mm, color: green		
MKDSP 10N/ 2-10,16	1773976	50
MKDSP 10N/ 3-10,16	1774137	50

Ordering data

Type	Order No.	Pcs. / Pkt.
Pitch 10.16 mm, color: green		
MKDSP 10HV/ 2-10,16	1929517	50
MKDSP 10HV/ 3-10,16	1929520	50

Ordering data

Type	Order No.	Pcs. / Pkt.
Pitch 12.7 mm, color: green		
MKDSP 10HV/ 2-12,7	1929533	50
MKDSP 10HV/ 3-12,7	1929546	50

PCB terminal blocks for power electronics with pitch from 6.35 to 15.0 mm

PCB terminal blocks with screw connection, MKDS 10 series up to 76 A/16 mm²

600 V-UL, horizontal connection direction, pitch 10.16 mm

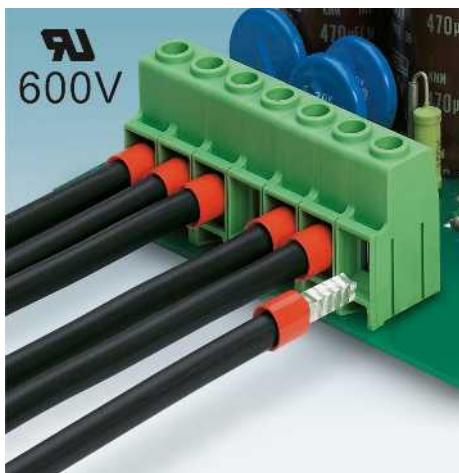

- Compact high-capacity PCB terminal blocks with a screw connection up to 16 mm², stranded, and a current carrying capacity of 76 A
- Unrestricted 600-V-UL approval, thanks to zig-zag pinning
- Pitch 10.16 mm
- MKDS 10 HV/...-B-10,16 with a solder pin at the back; MKDS 10 HV/...-F-10,16 with a solder pin in the front
- Terminal block bases that can be lined up next to each other in order to set up any number of positions

Notes:

In order to avoid tolerances between the terminal blocks and PCB, the terminal row should be interrupted when the number of positions exceeds 30.

When using ferrules for 16 mm² conductors, crimp with CRIMPFOX 16 S (see accessories).

When aligning single PCB terminal blocks with identical pinning, other rated insulation voltages can occur.

¹⁾ Please observe the current carrying capacity curves and laboratory data sheets. Further current carrying capacity curves on request.

Accessories

For all types	Type	Page
	Screwdriver SZS 0,6 x 3,5 Order No. 1205053	
	Marker strips SK 5,0 WH:REEL Order No. 0805221	801
	Crimping pliers for 0.25 to 6 mm ² CRIMPFOX 6 Order No. 1212034	
	Crimping pliers for 10 to 16 mm ² CRIMPFOX 16 S Order No. 1207983	

Current carrying capacity curve

Type: MKDS 10 HV/...-ZB-10,16

Tested in accordance with DIN EN 60512-5-2:2003-01

Reduction factor = 1

No. of positions = 5

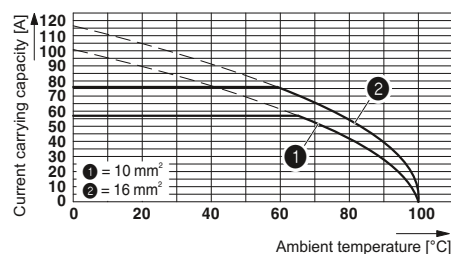

Technical data

Technical data in accordance to IEC / DIN VDE

Rated current / conductor cross section [A] / [mm²]

Rated insulation voltage for pollution degree 2 [V]

Pitch [mm]

Connection capacity

Solid / stranded [mm²] / [mm²] / AWG

Stranded with ferrules without plastic sleeve [mm²]

Stranded with ferrules with plastic sleeve [mm²]

Multi-conductor connection capacity (two conductors with the same cross section)

Solid / stranded [mm²]

Stranded with ferrules without plastic sleeve [mm²]

Stranded with TWIN ferrule with plastic sleeve [mm²]

Insulation coordination

Surge voltage category / pollution degree

Rated insulation voltage [V]

Rated surge voltage [kV]

Approval data (UL/CUL) Use Group

Nominal voltage [V]

Nominal current [A]

Connection capacity AWG AWG

Approval data (CSA) Use Group

Nominal voltage [V]

Nominal current [A]

Connection capacity AWG AWG

General data

Stripping length [mm]

Screw thread

Tightening torque [Nm]

Type of insulation material / insulation material group

Inflammability class according to UL 94

Drill hole diameter / pin dimensions [mm]

MKDS 10 HV/ ...-ZB-10,16

76¹⁾ / 16

1000

10.16

0.5 - 16 / 0.5 - 16 / 20 - 6

0.5 - 16

0.5 - 16

0.5 - 6 / 0.5 - 6

0.5 - 4

0.5 - 6

III / 3 III / 2 II / 2

800 1000 1000

8 8 8

B C D

600 600 -

60 60 -

20 - 6 20 - 6 -

B C D

- - -

- - -

- - -

10

M4

1.2 - 1.5

PA / I

V0

1.5 / 1 x 0.9 mm

MKDS 10 HV/ 1-B-10,16

76¹⁾ / 16

400

10.16

0.5 - 16 / 0.5 - 16 / 20 - 6

0.5 - 16

0.5 - 16

0.5 - 6 / 0.5 - 6

0.5 - 4

0.5 - 6

III / 3 III / 2 II / 2

400 400 800

4 4 4

B C D

600 600 -

60 60 -

20 - 6 20 - 6 -

B C D

- - -

- - -

- - -

10

M4

1.2 - 1.5

PA / I

V0

1.5 / 1 x 0.9 mm

MKDS 10 HV/ 1-F-10,16

76¹⁾ / 16

400

10.16

0.5 - 16 / 0.5 - 16 / 20 - 6

0.5 - 16

0.5 - 16

0.5 - 6 / 0.5 - 6

0.5 - 4

0.5 - 6

III / 3 III / 2 II / 2

400 400 800

4 4 4

B C D

600 600 -

60 60 -

20 - 6 20 - 6 -

B C D

- - -

- - -

- - -

10

M4

1.2 - 1.5

PA / I

V0

1.5 / 1 x 0.9 mm

No. of pos.

Dim. a [mm]

1

2 10.16

3 20.32

4 30.48

5 40.64

6 50.80

7 60.96

8 71.12

9 81.28

10 91.44

11 101.60

12 111.76

PCB terminal blocks for power electronics with pitch from 6.35 to 15.0 mm

PCB terminal blocks with screw connection, MKDS 10 series up to 76 A/16 mm²



Z pinning, 600 V UL approval



Single PCB terminal block with solder pin to the rear, 600 V UL approval



Single PCB terminal block with solder pin to the front, 600 V UL approval



Dimensional drawing

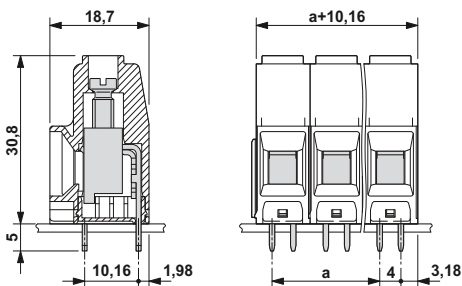

Drilling diagram

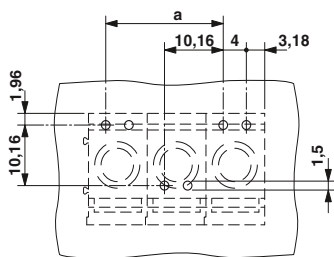

Dimensional drawing

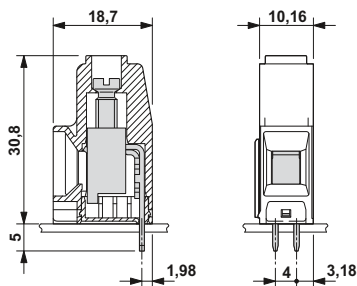

Drilling diagram

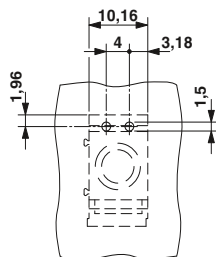

Dimensional drawing

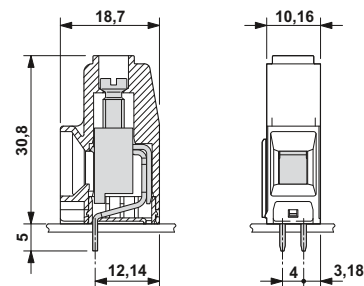

Drilling diagram

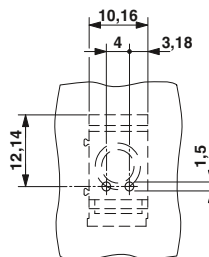

Ordering data

Type Order No. Pcs. / Pkt.
Pitch 10.16 mm, color: green

MKDS 10 HV/ 2-ZB-10,16	1709681	50
MKDS 10 HV/ 3-ZB-10,16	1709694	50
MKDS 10 HV/ 4-ZB-10,16	1709704	50
MKDS 10 HV/ 5-ZB-10,16	1709717	50
MKDS 10 HV/ 6-ZB-10,16	1709720	50
MKDS 10 HV/ 7-ZB-10,16	1709733	50
MKDS 10 HV/ 8-ZB-10,16	1709746	50
MKDS 10 HV/ 9-ZB-10,16	1709759	50
MKDS 10 HV/10-ZB-10,16	1709762	50
MKDS 10 HV/11-ZB-10,16	1709775	50
MKDS 10 HV/12-ZB-10,16	1709788	50

Ordering data

Type Order No. Pcs. / Pkt.
Pitch 10.16 mm, color: green

MKDS 10 HV/ 1-B-10,16	1993776	50

Ordering data

Type Order No. Pcs. / Pkt.
Pitch 10.16 mm, color: green

MKDS 10 HV/ 1-F-10,16	1993763	50

PCB terminal blocks for power electronics with pitch from 6.35 to 15.0 mm

PCB terminal blocks with screw connection, MKDSP 25 series up to 125 A/35 mm²

Horizontal connection direction, pitch 15 mm



- High-capacity PCB terminal blocks with a screw connection up to 35 mm² conductor cross section and a current carrying capacity of 125 A
- Unrestricted 600-V-UL approval
- Integrated test connection
- Version with mounting flange (-F) for safe mounting on the PCB
- Single-pos. version with a left-sided mounting flange (-FL)
- Integrated protective guide

Notes:

1) Please observe the current carrying capacity curves and laboratory data sheets. Further current carrying capacity curves on request.

2) 2.5 Nm = 25 mm²
4.5 Nm = 35 mm²

Accessories

For all types	Type	Page
	Test plug MPS	831
	Reducing plug RPS Order No. 0201647	831
	Screwdriver SZS 1,0 x 6,5 Order No. 1205079	
	Marker strips SK 10,0 WH:REEL Order No. 0812188	801
	Zack marker strip ZBF 15: UNBEDRUCKT	807

Current carrying capacity curve

Type: MKDSP 25/...-15,00

Tested in accordance with DIN EN 60512-5-2:2003-01

Reduction factor = 1

No. of positions: 5

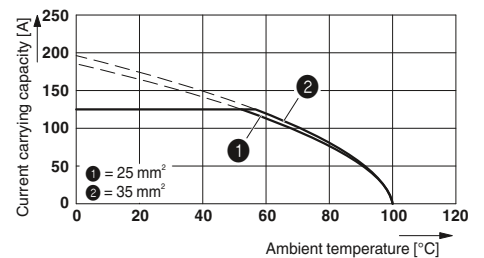

Technical data

Technical data in accordance to IEC / DIN VDE	
Rated current / conductor cross section	[A] / [mm ²]
Rated insulation voltage for pollution degree 2	[V]
Pitch	[mm]
Connection capacity	
Solid / stranded	[mm ²] / [mm ²] / AWG
Stranded with ferrules without plastic sleeve	[mm ²]
Stranded with ferrules with plastic sleeve	[mm ²]
Multi-conductor connection capacity (two conductors with the same cross section)	
Solid / stranded	[mm ²]
Stranded with ferrules without plastic sleeve	[mm ²]
Stranded with TWIN ferrule with plastic sleeve	[mm ²]
Insulation coordination	
Surge voltage category / pollution degree	
Rated insulation voltage	[V]
Rated surge voltage	[kV]
Approval data (UL/CUL)	Use Group
Nominal voltage	[V]
Nominal current	[A]
Connection capacity AWG	AWG
Approval data (CSA)	Use Group
Nominal voltage	[V]
Nominal current	[A]
Connection capacity AWG	AWG
General data	
Stripping length	[mm]
Screw thread	
Tightening torque	[Nm]
Type of insulation material / insulation material group	
Inflammability class according to UL 94	
Drill hole diameter / pin dimensions	[mm]

MKDSP 25/ ...-15,00

125 ¹⁾ / 35		
1000		
15		
0.5 - 35 / 0.5 - 25 / 20 - 2		
1 - 25		
1.5 - 25		
0.5 - 6 / 0.5 - 6		
0.5 - 4		
0.5 - 6		
III / 3	III / 2	II / 2
1000	1000	1000
8	8	8
B	C	D
600	600	-
115	115	-
20 - 2	20 - 2	-
B	C	D
-	-	-
-	-	-
-	-	-
PA / I		
V0		
1.6 / 1.2 x 1.2 mm		

MKDSP 25/ ...-15,00-F

125 ¹⁾ / 35		
1000		
15		
0.5 - 35 / 0.5 - 25 / 20 - 2		
1 - 25		
1.5 - 25		
0.5 - 6 / 0.5 - 6		
0.5 - 4		
0.5 - 6		
III / 3	III / 2	II / 2
1000	1000	1000
8	8	8
B	C	D
600	600	-
115	115	-
20 - 2	20 - 2	-
B	C	D
-	-	-
-	-	-
-	-	-
PA / I		
V0		
1.6 / 1.2 x 1.2 mm		

MKDSP 25/ 1-15,00-FL

125 ¹⁾ / 35		
1000		
15		
0.5 - 35 / 0.5 - 25 / 20 - 2		
1 - 25		
1.5 - 25		
0.5 - 6 / 0.5 - 6		
0.5 - 4		
0.5 - 6		
III / 3	III / 2	II / 2
1000	1000	1000
8	8	8
B	C	D
600	600	-
115	115	-
20 - 2	20 - 2	-
B	C	D
-	-	-
-	-	-
-	-	-
PA / I		
V0		
1.6 / 1.2 x 1.2 mm		

No. of pos.	Dim. a [mm]
1	
2	15.00
3	30.00
4	45.00
5	60.00
6	75.00
7	90.00
8	105.00
9	120.00

PCB terminal blocks for power electronics with pitch from 6.35 to 15.0 mm

PCB terminal blocks with screw connection, MKDSP 25 series up to 125 A/35 mm²



Without mounting flange,
600 V UL approval



With mounting flange,
600 V UL approval



Single PCB terminal block with
mounting flange, left,
600 V UL approval



Dimensional drawing

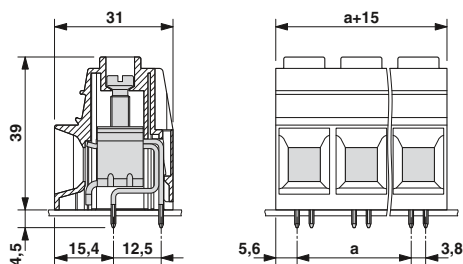

Drilling diagram

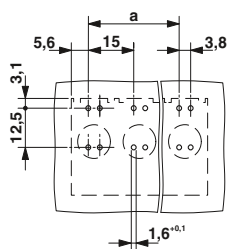

Dimensional drawing

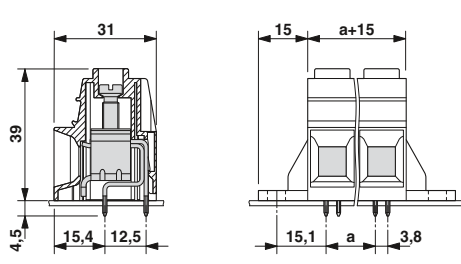

Drilling diagram

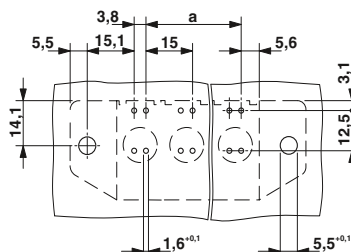

Dimensional drawing

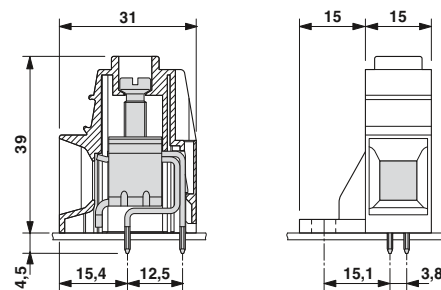

Drilling diagram

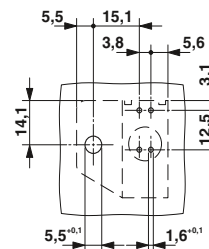

Ordering data

Type	Order No.	Pcs. / Pkt.
15 mm pitch, color: green		
MKDSP 25/ 2-15,00	1932588	25
MKDSP 25/ 3-15,00	1932591	25
MKDSP 25/ 4-15,00	1932601	25
MKDSP 25/ 5-15,00	1932614	25
MKDSP 25/ 6-15,00	1932627	25
MKDSP 25/ 7-15,00	1932630	25
MKDSP 25/ 8-15,00	1932643	25
MKDSP 25/ 9-15,00	1932656	25

Ordering data

Type	Order No.	Pcs. / Pkt.
15 mm pitch, color: green		
MKDSP 25/ 2-15,00-F	1932494	25
MKDSP 25/ 3-15,00-F	1932504	25
MKDSP 25/ 4-15,00-F	1932517	25
MKDSP 25/ 5-15,00-F	1932520	25
MKDSP 25/ 6-15,00-F	1932533	25
MKDSP 25/ 7-15,00-F	1932546	25
MKDSP 25/ 8-15,00-F	1932559	25
MKDSP 25/ 9-15,00-F	1932562	25

Ordering data

Type	Order No.	Pcs. / Pkt.
15 mm pitch, color: green		
MKDSP 25/ 1-15,00-FL	1932575	25

PCB terminal blocks for power electronics with pitch from 6.35 to 15.0 mm

Special designs with screw connection, KDS 10-, Front 4 series up to 76 A/16 mm²

Feed-through PCB terminal blocks, pitch 10 mm

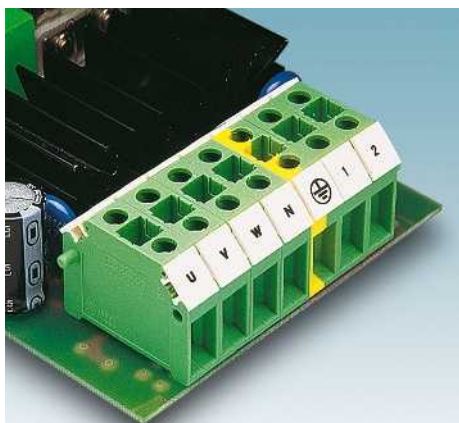

- High-capacity PCB terminal blocks with a current carrying capacity up to 76 A at the solder connection
- Can also be used as a feed-through terminal block up to 76 A
- Different solder pin geometries for greater voltage distances (KDS 10.../SO)
- Individual adjustment of voltage requirements using pitch spacers RZ
- Potential distribution possible by means of bridges

Notes:

In order to avoid tolerances between the terminal blocks and PCB, the terminal row should be interrupted when the number of positions exceeds 30.

FBI 10-10 maximum via 3 KDS 10 terminal blocks. Remove the break-out wall for bridging.

1) Higher voltages are achieved when the RZ-KDS 10 pitch spacer is inserted.

2) Please observe the current carrying capacity curves and laboratory data sheets. Further current carrying capacity curves on request.

Accessories

For all types	Type	Page
	Pitch spacer, width: 2.5 mm RZ-KDS 10 Order No. 1701065	
	Fixed bridge, 10-pos., divisible FBI 10-10 Order No. 0203276	
	Test plug PS...	831
	Test socket for PS test plugs PSB 4/7/6 Order No. 0303299	
	Zack marker strip ZB 10	805
	Screwdriver SZS 1,0 x 4,0 Order No. 1205066	

Current carrying capacity curve

Type: KDS 10
Test following DIN EN 60512-5-2:2003-01
Reduction factor = 1
No. of positions: 5

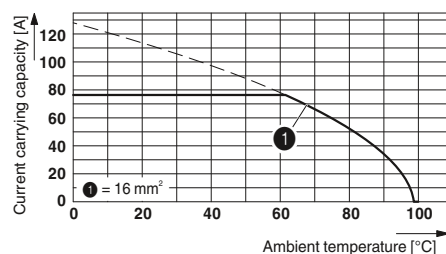

Technical data

Technical data in accordance to IEC / DIN VDE

Rated current / conductor cross section [A] / [mm²]
Rated insulation voltage for pollution degree 2 [V]

Pitch [mm]

Connection capacity

Solid / stranded [mm²] / [mm²] / AWG

Stranded with ferrules without plastic sleeve [mm²]

Stranded with ferrules with plastic sleeve [mm²]

Multi-conductor connection capacity (two conductors with the same cross section)

Solid / stranded [mm²]

Stranded with ferrules without plastic sleeve [mm²]

Stranded with TWIN ferrule with plastic sleeve [mm²]

Insulation coordination

Surge voltage category / pollution degree

Rated insulation voltage [V]

Rated surge voltage [kV]

Approval data (UL/CUL) Use Group

Nominal voltage [V]

Nominal current [A]

Connection capacity AWG AWG

Approval data (CSA) Use Group

Nominal voltage [V]

Nominal current [A]

Connection capacity AWG AWG

General data

Stripping length [mm]

Screw thread

Tightening torque [Nm]

Type of insulation material / insulation material group

Inflammability class according to UL 94

Drill hole diameter / pin dimensions [mm]

KDS10

KDS10/SO

KDS10-PE

No. of pos.

1

1

1

PCB terminal blocks for power electronics with pitch from 6.35 to 15.0 mm

Special designs with screw connection, KDS 10-, Front 4 series up to 76 A/16 mm²



Solder pins in a row



Offset solder pins



PE connection, solder pins in a row



Dimensional drawing

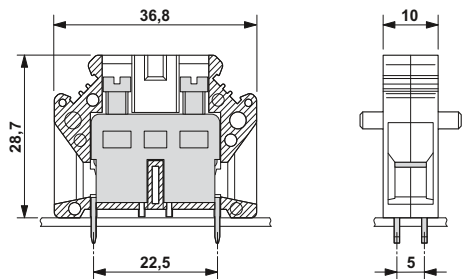

Drilling diagram

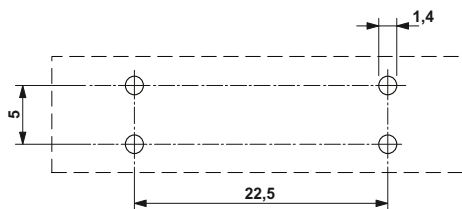

Dimensional drawing

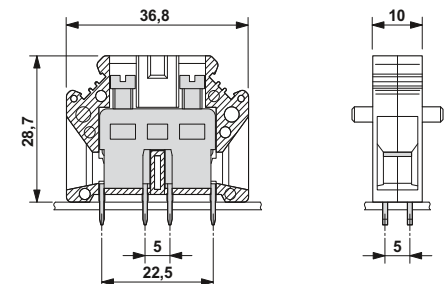

Drilling diagram

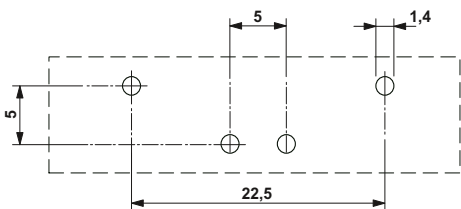

Dimensional drawing

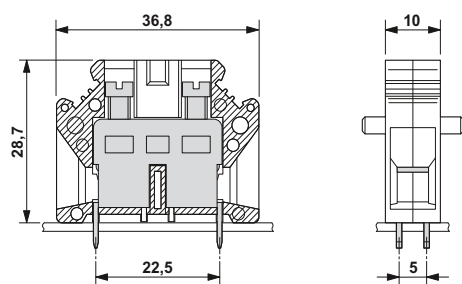

Drilling diagram

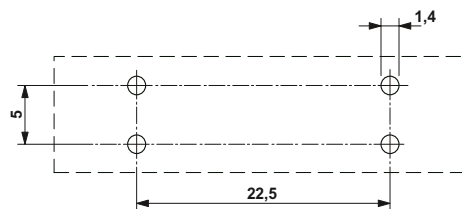

Ordering data

Type	Order No.	Pcs. / Pkt.
10 mm pitch, color: green KDS10	1704020	50

Ordering data

Type	Order No.	Pcs. / Pkt.
10 mm pitch, color: green KDS10/SO	1704059	50

Ordering data

Type	Order No.	Pcs. / Pkt.
10 mm pitch, color: green-yellow KDS10-PE	1704033	50

PCB terminal blocks for power electronics with pitch from 6.35 to 15.0 mm

Special designs with screw connection, KDS 10-, Front 4 series up to 76 A/16 mm²

Front PCB terminal blocks, pitch 6.35/7.62 mm

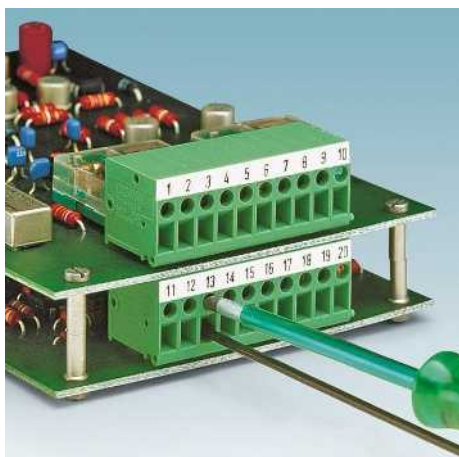

- Front screw connection terminal blocks up to 6 mm² conductor cross section
- Connection direction of the conductor: Horizontal (0° -H) or vertical (90° -V)
- A cover is necessary at the end of a terminal block row (D-FRONT 4-6,35)

Notes:

In order to avoid tolerances between the terminal blocks and PCB, the terminal row should be interrupted when the number of positions exceeds 30.

Additional versions and accessories for the KDS 10 series can be found on page 456.

1) Please observe the current carrying capacity curves and laboratory data sheets. Further current carrying capacity curves on request.

Accessories

For all types	Type	Page
Only for KDS 10...		
	Screwdriver SZS 1,0 x 4,0 Order No. 1205066	
	Pitch spacer, width: 2.5 mm RZ-KDS 10 Order No. 1701065	
	Zack marker strip ZB 10	805
Only for FRONT 4...-6,5		
	Cover, width 1.5 mm D-FRONT 4-6,35 Order No. 1703076	
	Screwdriver SZS 0,6 x 3,5 Order No. 1205053	
	Marker cards SK 6,2/3,8	799

Current carrying capacity curve

Type: FRONT 4-H-6,35
Test following DIN EN 60512-5-2:2003-01
Reduction factor = 1
No. of positions: 5

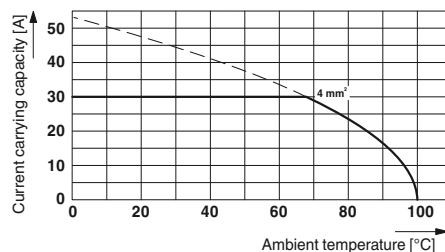

Technical data

Technical data in accordance to IEC / DIN VDE

Rated current / conductor cross section	[A] / [mm ²]
Rated insulation voltage for pollution degree 2	[V]
Pitch	[mm]
Connection capacity	
Solid / stranded	[mm ²] / [mm ²] / AWG
Stranded with ferrules without plastic sleeve	[mm ²]
Stranded with ferrules with plastic sleeve	[mm ²]
Multi-conductor connection capacity (two conductors with the same cross section)	
Solid / stranded	[mm ²]
Stranded with ferrules without plastic sleeve	[mm ²]
Stranded with TWIN ferrule with plastic sleeve	[mm ²]
Insulation coordination	
Surge voltage category / pollution degree	
Rated insulation voltage	[V]
Rated surge voltage	[kV]
Approval data (UL/CUL)	Use Group
Nominal voltage	[V]
Nominal current	[A]
Connection capacity AWG	AWG
Approval data (CSA)	Use Group
Nominal voltage	[V]
Nominal current	[A]
Connection capacity AWG	AWG
General data	
Stripping length	[mm]
Screw thread	
Tightening torque	[Nm]
Type of insulation material / insulation material group	
Inflammability class according to UL 94	
Drill hole diameter / pin dimensions	[mm]

KDS10-PE/SO

Rated current / conductor cross section	76 ¹⁾ / 16
Rated insulation voltage for pollution degree 2	630
Pitch	10
Connection capacity	
Solid / stranded	0.5 - 16 / 0.5 - 10 / 20 - 6
Stranded with ferrules without plastic sleeve	0.5 - 10
Stranded with ferrules with plastic sleeve	0.5 - 10
Multi-conductor connection capacity (two conductors with the same cross section)	
Solid / stranded	0.5 - 4 / 0.5 - 4
Stranded with ferrules without plastic sleeve	0.5 - 2.5
Stranded with TWIN ferrule with plastic sleeve	0.5 - 6
Insulation coordination	
Surge voltage category / pollution degree	III / 3 III / 2 II / 2
Rated insulation voltage	630 630 1000
Rated surge voltage	4 4 4
Approval data (UL/CUL)	B C D
Nominal voltage	- - -
Nominal current	- - -
Connection capacity AWG	- - -
Approval data (CSA)	B C D
Nominal voltage	- - -
Nominal current	- - -
Connection capacity AWG	- - -
General data	
Stripping length	12
Screw thread	M4
Tightening torque	1.2 - 1.5
Type of insulation material / insulation material group	PA / I
Inflammability class according to UL 94	V0
Drill hole diameter / pin dimensions	1.4 / 1 x 0.9 mm

FRONT 4-H-6,35

Rated current / conductor cross section	32 ¹⁾ / 6
Rated insulation voltage for pollution degree 2	320
Pitch	6.35
Connection capacity	
Solid / stranded	0.5 - 6 / 0.5 - 4 / 20 - 10
Stranded with ferrules without plastic sleeve	0.5 - 4
Stranded with ferrules with plastic sleeve	0.5 - 4
Multi-conductor connection capacity (two conductors with the same cross section)	
Solid / stranded	0.5 - 1.5 / 0.5 - 1.5
Stranded with ferrules without plastic sleeve	0.25 - 1
Stranded with TWIN ferrule with plastic sleeve	0.5 - 1
Insulation coordination	
Surge voltage category / pollution degree	III / 3 III / 2 II / 2
Rated insulation voltage	320 320 630
Rated surge voltage	4 4 4
Approval data (UL/CUL)	B C D
Nominal voltage	300 - 300
Nominal current	30 - 30
Connection capacity AWG	24 - 10 - 24 - 10
Approval data (CSA)	B C D
Nominal voltage	300 - 300
Nominal current	30 - 10
Connection capacity AWG	22 - 10 - 22 - 10
General data	
Stripping length	14
Screw thread	M3
Tightening torque	0.5 - 0.6
Type of insulation material / insulation material group	PA / I
Inflammability class according to UL 94	V2
Drill hole diameter / pin dimensions	1.3 / 1 x 0.8 mm

FRONT 4-V-6,35

Rated current / conductor cross section	32 ¹⁾ / 6
Rated insulation voltage for pollution degree 2	320
Pitch	6.35
Connection capacity	
Solid / stranded	0.5 - 6 / 0.5 - 4 / 20 - 10
Stranded with ferrules without plastic sleeve	0.5 - 4
Stranded with ferrules with plastic sleeve	0.5 - 4
Multi-conductor connection capacity (two conductors with the same cross section)	
Solid / stranded	0.5 - 1.5 / 0.5 - 1.5
Stranded with ferrules without plastic sleeve	0.25 - 1
Stranded with TWIN ferrule with plastic sleeve	0.5 - 1
Insulation coordination	
Surge voltage category / pollution degree	III / 3 III / 2 II / 2
Rated insulation voltage	320 320 630
Rated surge voltage	4 4 4
Approval data (UL/CUL)	B C D
Nominal voltage	300 - 300
Nominal current	30 - 30
Connection capacity AWG	24 - 10 - 24 - 10
Approval data (CSA)	B C D
Nominal voltage	300 - 300
Nominal current	30 - 10
Connection capacity AWG	22 - 10 - 22 - 10
General data	
Stripping length	14
Screw thread	M3
Tightening torque	0.5 - 0.6
Type of insulation material / insulation material group	PA / I
Inflammability class according to UL 94	V2
Drill hole diameter / pin dimensions	1.3 / 1 x 0.8 mm

No. of pos.

1

1

PCB terminal blocks for power electronics with pitch from 6.35 to 15.0 mm

Special designs with screw connection, KDS 10-, Front 4 series up to 76 A/16 mm²



Feed-through terminal block as PE connection, offset solder pins



Individual PCB terminal block, horizontal connection direction



Individual PCB terminal block, vertical connection direction



Dimensional drawing

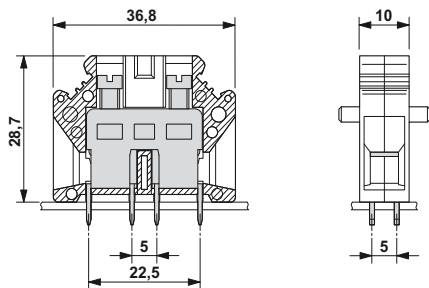

Drilling diagram

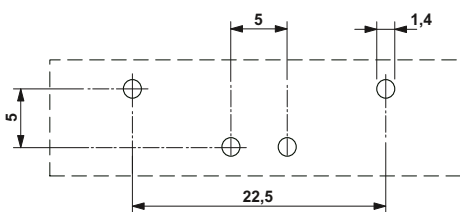

Ordering data

Type	Order No.	Pcs. / Pkt.
10 mm pitch, color: green-yellow KDS10-PE/SO	1704062	50



Dimensional drawing

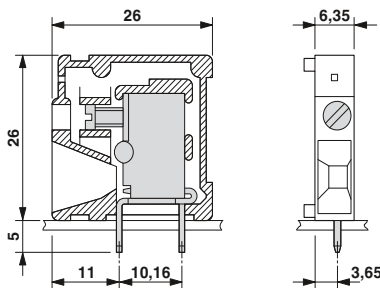

Drilling diagram

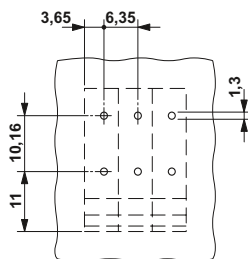

Ordering data

Type	Order No.	Pcs. / Pkt.
6.35 mm pitch, color: green FRONT 4-H-6,35	1703050	50



Dimensional drawing

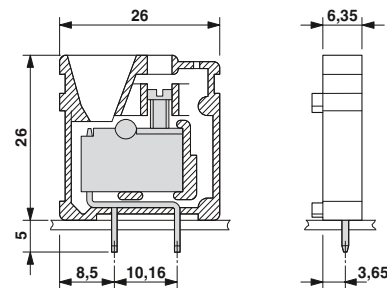

Drilling diagram

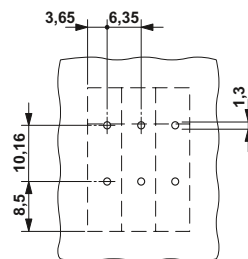

Ordering data

Type	Order No.	Pcs. / Pkt.
6.35 mm pitch, color: green FRONT 4-V-6,35	1703063	50

PCB terminal blocks for power electronics with pitch from 6.35 to 15.0 mm

Special designs with screw connection, KDS 10-, Front 4 series up to 76 A/16 mm²

Front PCB terminal blocks, pitch 6.35/7.62 mm

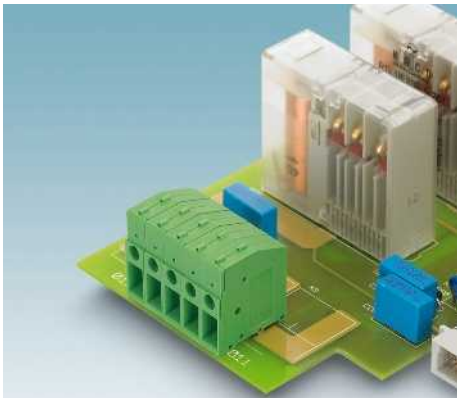



- Front screw connection terminal blocks up to 6 mm² conductor cross section
- Connection direction of the conductor: horizontal (0° -H) or vertical (90° -V)
- In the horizontal version, pitch spacers (RZ) are available for adjusting insulation distances

Notes:

In order to avoid tolerances between the terminal blocks and PCB, the terminal row should be interrupted when the number of positions exceeds 30.

1) Please observe the current carrying capacity curves and laboratory data sheets. Further current carrying capacity curves on request.

Accessories

For all types	Type	Page
	Screwdriver SZS 0,6 x 3,5 Order No. 1205053	
	Pitch spacer, width: 5.08 mm RZ-5,08-FRONT 4-H-7,62 Order No. 1904011	
	Marker cards SK 7,62/3,8	799

Current carrying capacity curve

Type: FRONT 4-H-7,62
Test following DIN EN 60512-5-2:2003-01
Reduction factor = 1
No. of positions: 5

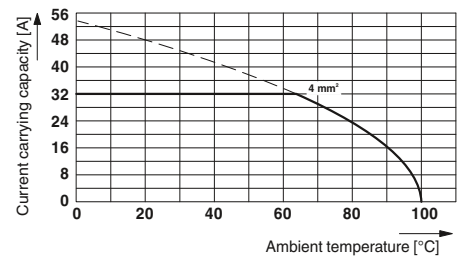

Technical data

Technical data in accordance to IEC / DIN VDE

Rated current / conductor cross section [A] / [mm²]
Rated insulation voltage for pollution degree 2 [V]

FRONT 4-H-7,62

FRONT 4-V-7,62

Pitch [mm]			
Connection capacity			
Solid / stranded [mm ²] / [mm ²] / AWG			
Stranded with ferrules without plastic sleeve [mm ²]			
Stranded with ferrules with plastic sleeve [mm ²]			
Multi-conductor connection capacity (two conductors with the same cross section)			
Solid / stranded [mm ²]			
Stranded with ferrules without plastic sleeve [mm ²]			
Stranded with TWIN ferrule with plastic sleeve [mm ²]			
Insulation coordination			
Surge voltage category / pollution degree			
Rated insulation voltage [V]			
Rated surge voltage [kV]			
Approval data (UL/CUL) Use Group			
Nominal voltage [V]			
Nominal current [A]			
Connection capacity AWG			
Approval data (CSA) Use Group			
Nominal voltage [V]			
Nominal current [A]			
Connection capacity AWG			
General data			
Stripping length [mm]			
Screw thread			
Tightening torque [Nm]			
Type of insulation material / insulation material group			
Inflammability class according to UL 94			
Drill hole diameter / pin dimensions [mm]			

Rated current / conductor cross section [A] / [mm ²]	32 ¹⁾ / 6		
Rated insulation voltage for pollution degree 2 [V]	630		
Pitch [mm]	7.62		
Connection capacity			
Solid / stranded [mm ²] / [mm ²] / AWG	0.5 - 6 / 0.5 - 4 / 20 - 10		
Stranded with ferrules without plastic sleeve [mm ²]	0.5 - 4		
Stranded with ferrules with plastic sleeve [mm ²]	0.5 - 4		
Multi-conductor connection capacity (two conductors with the same cross section)			
Solid / stranded [mm ²]	0.5 - 1.5 / 0.5 - 1.5		
Stranded with ferrules without plastic sleeve [mm ²]	0.25 - 1		
Stranded with TWIN ferrule with plastic sleeve [mm ²]	0.5 - 1		
Insulation coordination			
Surge voltage category / pollution degree	III / 3	III / 2	II / 2
Rated insulation voltage [V]	500	630	1000
Rated surge voltage [kV]	6	6	6
Approval data (UL/CUL) Use Group	B	C	D
Nominal voltage [V]	300	-	300
Nominal current [A]	30	-	30
Connection capacity AWG	24 - 10	-	24 - 10
Approval data (CSA) Use Group	B	C	D
Nominal voltage [V]	300	-	300
Nominal current [A]	30	-	10
Connection capacity AWG	22 - 10	-	22 - 10
General data			
Stripping length [mm]	14		
Screw thread	M3		
Tightening torque [Nm]	0.5 - 0.6		
Type of insulation material / insulation material group	PA / I		
Inflammability class according to UL 94	V0		
Drill hole diameter / pin dimensions [mm]	1.3 / 1 x 0.8 mm		

Rated current / conductor cross section [A] / [mm ²]	32 ¹⁾ / 6		
Rated insulation voltage for pollution degree 2 [V]	630		
Pitch [mm]	7.62		
Connection capacity			
Solid / stranded [mm ²] / [mm ²] / AWG	0.5 - 6 / 0.5 - 4 / 20 - 10		
Stranded with ferrules without plastic sleeve [mm ²]	0.5 - 4		
Stranded with ferrules with plastic sleeve [mm ²]	0.5 - 4		
Multi-conductor connection capacity (two conductors with the same cross section)			
Solid / stranded [mm ²]	0.5 - 1.5 / 0.5 - 1.5		
Stranded with ferrules without plastic sleeve [mm ²]	0.25 - 1		
Stranded with TWIN ferrule with plastic sleeve [mm ²]	0.5 - 1		
Insulation coordination			
Surge voltage category / pollution degree	III / 3	III / 2	II / 2
Rated insulation voltage [V]	500	630	1000
Rated surge voltage [kV]	6	6	6
Approval data (UL/CUL) Use Group	B	C	D
Nominal voltage [V]	300	-	300
Nominal current [A]	30	-	30
Connection capacity AWG	24 - 10	-	24 - 10
Approval data (CSA) Use Group	B	C	D
Nominal voltage [V]	300	-	300
Nominal current [A]	30	-	10
Connection capacity AWG	22 - 10	-	22 - 10
General data			
Stripping length [mm]	14		
Screw thread	M3		
Tightening torque [Nm]	0.5 - 0.6		
Type of insulation material / insulation material group	PA / I		
Inflammability class according to UL 94	V0		
Drill hole diameter / pin dimensions [mm]	1.3 / 1 x 0.8 mm		

No. of pos.

1



Individual PCB terminal block,
horizontal connection direction



Individual PCB terminal block,
vertical connection direction



Dimensional drawing

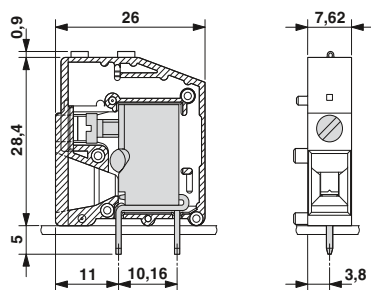

Drilling diagram

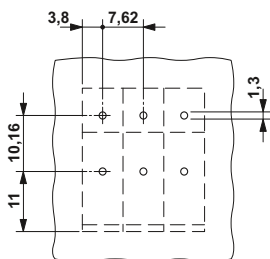

Ordering data

Type	Order No.	Pcs. / Pkt.
Pitch 7.62 mm, color: green FRONT 4-H-7,62	1703034	50



Dimensional drawing

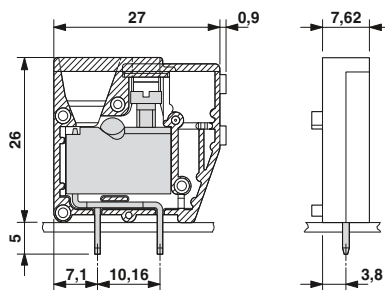

Drilling diagram

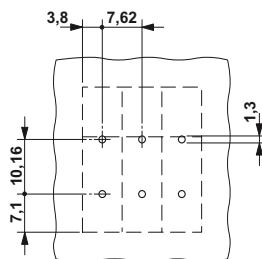

Ordering data

Type	Order No.	Pcs. / Pkt.
Pitch 7.62 mm, color: green FRONT 4-V-7,62	1703021	50

PCB terminal blocks for power electronics with pitch from 6.35 to 15.0 mm

PCB terminal blocks with push-in spring connection, SPT series up to 76 A/16 mm²

Horizontal connection direction, pitch 7.5 mm

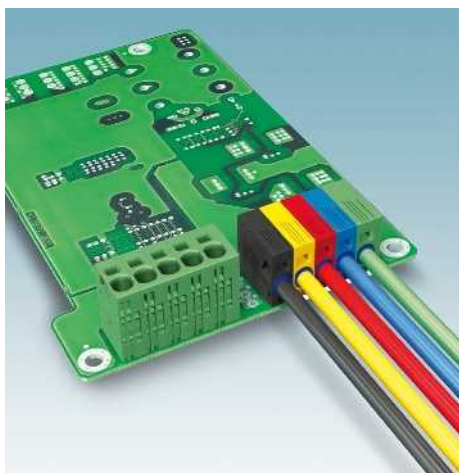

- Push-in spring-cage PCB terminal blocks SPT 5 for conductor cross sections up to 6 mm², stranded
- Fast connection technology, thanks to principle of direct plug-in without tools
- Unrestricted 600-V-UL approval, thanks to compact zig-zag pinning
- Connection direction of the conductor: horizontal (0° -H) to the PCB
- Single-position terminal blocks with double pinning

Notes:

When aligning versions with double pinning, other rated insulation voltages can occur.

¹⁾ Please observe the current carrying capacity curves and laboratory data sheets. Further current carrying capacity curves on request.

Accessories

For all types	Type	Page
	Screwdriver SZF 1-0,6 x 3,5 Order No. 1204517	
	Marker cards SK 7,5/3,8	799
	Ferrules with and without plastic sleeve	834
	Crimping pliers for 0.25 to 6 mm ² CRIMPFOX 6 Order No. 1212034	
	Pitch spacer RZ-SPT 5-4 H Order No. 1701534	

Current carrying capacity curve

Type: SPT 5/...-H-7,5-ZB
Test following DIN EN 60512-5-2:2003-01
Reduction factor = 1
No. of positions: 5

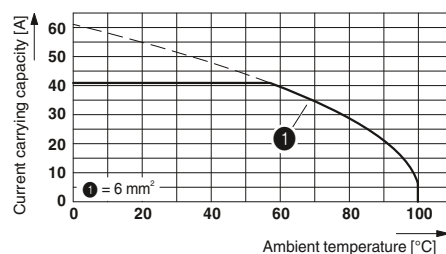

Technical data

Technical data in accordance to IEC / DIN VDE	
Rated current / conductor cross section	[A] / [mm ²]
Rated insulation voltage for pollution degree 2	[V]
Pitch	[mm]
Connection capacity	
Solid / stranded	[mm ²] / [mm ²] / AWG
Stranded with ferrules without plastic sleeve	[mm ²]
Stranded with ferrules with plastic sleeve	[mm ²]
Multi-conductor connection capacity (two conductors with the same cross section)	
Solid / stranded	[mm ²]
Stranded with ferrules without plastic sleeve	[mm ²]
Stranded with TWIN ferrule with plastic sleeve	[mm ²]
Insulation coordination	
Surge voltage category / pollution degree	
Rated insulation voltage	[V]
Rated surge voltage	[kV]
Approval data (UL/CUL)	Use Group
Nominal voltage	[V]
Nominal current	[A]
Connection capacity AWG	AWG
Approval data (CSA)	Use Group
Nominal voltage	[V]
Nominal current	[A]
Connection capacity AWG	AWG
General data	
Stripping length	[mm]
Type of insulation material / insulation material group	
Inflammability class according to UL 94	
Drill hole diameter / pin dimensions	[mm]

SPT 5/ 1-H-7,5

41 ¹⁾ / 10			41 ¹⁾ / 10		
1000			1000		
7.5			7.5		
0.2 - 10 / 0.2 - 6 / 24 - 8			0.2 - 10 / 0.2 - 6 / 24 - 8		
0.25 - 6			0.25 - 6		
0.25 - 4			0.25 - 4		
- / -			- / -		
-			-		
0.25 - 1.5			0.25 - 1.5		
III / 3	III / 2	II / 2	III / 3	III / 2	II / 2
630	1000	1000	800	1000	1000
6	6	6	8	8	6
B	C	D	B	C	D
300	150	600	600	600	-
35	35	5	35	35	-
24 - 8	24 - 8	24 - 8	24 - 8	24 - 8	-
B	C	D	B	C	D
-	-	-	-	-	-
-	-	-	-	-	-
-	-	-	-	-	-
15			15		
PA / I			PA / I		
V0			V0		
2.1 / 1.7 x 0.8			2.1 / 1.7 x 0.8		

SPT 5/ ...-H-7,5-ZB

No. of pos.	Dim. a [mm]
1	0.00
2	7.50
3	15.00
4	22.50
5	30.00
6	37.50
7	45.00
8	52.50
9	60.00
10	67.50
11	75.00
12	82.50

PCB terminal blocks for power electronics with pitch from 6.35 to 15.0 mm

PCB terminal blocks with push-in spring connection, SPT series up to 76 A/16 mm²

Vertical connection direction, pitch 7.5 mm

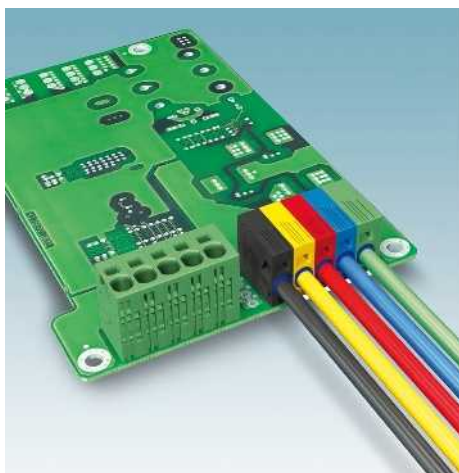

- Push-in spring-cage PCB terminal blocks SPT 5 for conductor cross sections up to 6 mm², stranded
- Fast connection technology, thanks to principle of direct plug-in without tools
- Unrestricted 600-V-UL approval, thanks to compact zig-zag pinning
- Connection direction of the conductor: Vertical (90° -V) to the PCB
- Single-position terminal blocks with double pinning

Notes:

When aligning versions with double pinning, other rated insulation voltages can occur.

1) Please observe the current carrying capacity curves and laboratory data sheets. Further current carrying capacity curves on request.

Accessories

For all types	Type	Page
	Screwdriver SZF 1-0,6 x 3,5 Order No. 1204517	
	Marker cards SK 7,5/3,8	799
	Ferrules with and without plastic sleeve	834
	Crimping pliers for 0.25 to 6 mm ² CRIMPFOX 6 Order No. 1212034	
	Pitch spacer RZ-SPT 5-4-V Order No. 1701535	

Current carrying capacity curve

Type: SPT 5/...-V-7,5-ZB
Test following DIN EN 60512-5-2:2003-01
Reduction factor = 1
No. of positions: 5

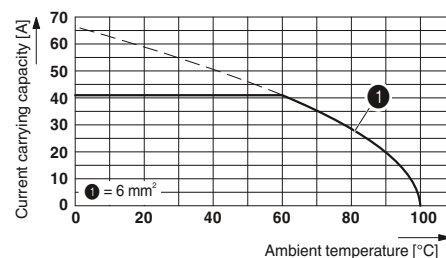

Technical data

Technical data in accordance to IEC / DIN VDE	
Rated current / conductor cross section	[A] / [mm ²]
Rated insulation voltage for pollution degree 2	[V]
Pitch	[mm]
Connection capacity	
Solid / stranded	[mm ²] / [mm ²] / AWG
Stranded with ferrules without plastic sleeve	[mm ²]
Stranded with ferrules with plastic sleeve	[mm ²]
Multi-conductor connection capacity (two conductors with the same cross section)	
Solid / stranded	[mm ²]
Stranded with ferrules without plastic sleeve	[mm ²]
Stranded with TWIN ferrule with plastic sleeve	[mm ²]
Insulation coordination	
Surge voltage category / pollution degree	
Rated insulation voltage	[V]
Rated surge voltage	[kV]
Approval data (UL/CUL)	Use Group
Nominal voltage	[V]
Nominal current	[A]
Connection capacity AWG	AWG
Approval data (CSA)	Use Group
Nominal voltage	[V]
Nominal current	[A]
Connection capacity AWG	AWG
General data	
Stripping length	[mm]
Type of insulation material / insulation material group	
Inflammability class according to UL 94	
Drill hole diameter / pin dimensions	[mm]

SPT 5/ 1-V-7,5

Rated current / conductor cross section			41 ¹⁾ / 10			
Rated insulation voltage for pollution degree 2			1000			
Pitch			7.5			
Connection capacity						
Solid / stranded			0.2 - 10 / 0.2 - 6 / 24 - 8			
Stranded with ferrules without plastic sleeve			0.25 - 6			
Stranded with ferrules with plastic sleeve			0.25 - 4			
Multi-conductor connection capacity (two conductors with the same cross section)						
Solid / stranded			- / -			
Stranded with ferrules without plastic sleeve			-			
Stranded with TWIN ferrule with plastic sleeve			0.25 - 1.5			
Insulation coordination						
Surge voltage category / pollution degree						
Rated insulation voltage	III / 3	III / 2	II / 2	800	1000	1000
Rated surge voltage	6	6	6	8	8	6
Approval data (UL/CUL)	B	C	D	B	C	D
Nominal voltage	300	150	600	600	600	-
Nominal current	35	35	5	35	35	-
Connection capacity AWG	24 - 8	24 - 8	24 - 8	24 - 8	24 - 8	-
Approval data (CSA)	B	C	D	B	C	D
Nominal voltage	-	-	-	-	-	-
Nominal current	-	-	-	-	-	-
Connection capacity AWG	-	-	-	-	-	-
General data						
Stripping length	15			15		
Type of insulation material / insulation material group						
Inflammability class according to UL 94						
Drill hole diameter / pin dimensions	2.1 / 1.7 x 0.8			2.1 / 1.7 x 0.8		

SPT 5/ ...-V-7,5-ZB

Rated current / conductor cross section			41 ¹⁾ / 10			
Rated insulation voltage for pollution degree 2			1000			
Pitch			7.5			
Connection capacity						
Solid / stranded			0.2 - 10 / 0.2 - 6 / 24 - 8			
Stranded with ferrules without plastic sleeve			0.25 - 6			
Stranded with ferrules with plastic sleeve			0.25 - 4			
Multi-conductor connection capacity (two conductors with the same cross section)						
Solid / stranded			- / -			
Stranded with ferrules without plastic sleeve			-			
Stranded with TWIN ferrule with plastic sleeve			0.25 - 1.5			
Insulation coordination						
Surge voltage category / pollution degree						
Rated insulation voltage	III / 3	III / 2	II / 2	800	1000	1000
Rated surge voltage	6	6	6	8	8	6
Approval data (UL/CUL)	B	C	D	B	C	D
Nominal voltage	300	150	600	600	600	-
Nominal current	35	35	5	35	35	-
Connection capacity AWG	24 - 8	24 - 8	24 - 8	24 - 8	24 - 8	-
Approval data (CSA)	B	C	D	B	C	D
Nominal voltage	-	-	-	-	-	-
Nominal current	-	-	-	-	-	-
Connection capacity AWG	-	-	-	-	-	-
General data						
Stripping length	15			15		
Type of insulation material / insulation material group						
Inflammability class according to UL 94						
Drill hole diameter / pin dimensions	2.1 / 1.7 x 0.8			2.1 / 1.7 x 0.8		

No. of pos.	Dim. a [mm]
1	0.00
2	7.50
3	15.00
4	22.50
5	30.00
6	37.50
7	45.00
8	52.50
9	60.00
10	67.50
11	75.00
12	82.50



Individual PCB terminal block, double pinning

Z pinning, 600 V UL approval



Dimensional drawing

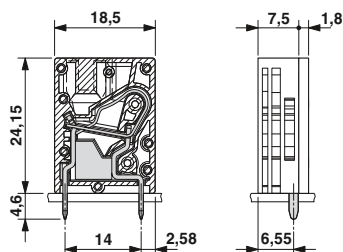

Drilling diagram

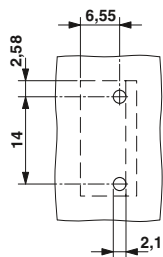

Dimensional drawing

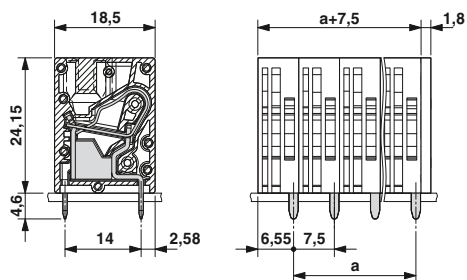

Drilling diagram

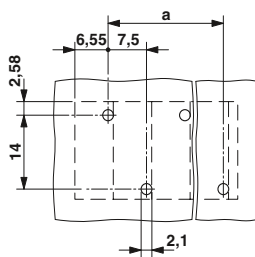

Ordering data

Type Order No. Pcs. / Pkt.
7.5 mm pitch, color: green

SPT 5/ 1-V-7,5 1719309 50

Ordering data

Type Order No. Pcs. / Pkt.
7.5 mm pitch, color: green

SPT 5/ 2-V-7,5-ZB	1719312	50
SPT 5/ 3-V-7,5-ZB	1719325	50
SPT 5/ 4-V-7,5-ZB	1719338	50
SPT 5/ 5-V-7,5-ZB	1719341	50
SPT 5/ 6-V-7,5-ZB	1719354	50
SPT 5/ 7-V-7,5-ZB	1719367	50
SPT 5/ 8-V-7,5-ZB	1719370	50
SPT 5/ 9-V-7,5-ZB	1719383	50
SPT 5/10-V-7,5-ZB	1719396	50
SPT 5/11-V-7,5-ZB	1719406	50
SPT 5/12-V-7,5-ZB	1719419	50

PCB terminal blocks for power electronics with pitch from 6.35 to 15.0 mm

PCB terminal blocks with push-in spring connection, SPT series up to 76 A/16 mm²

Horizontal connection direction, pitch 10 mm

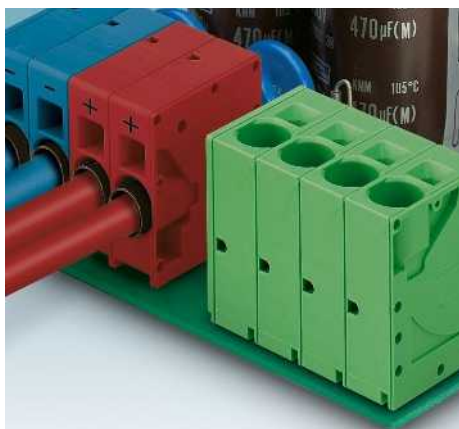

- SPT 16 PCB terminal block with push-in spring connection for conductor cross sections up to 16 mm² and a current carrying capacity of 76 A
- Fast connection technology, thanks to principle of direct plug-in without tools
- Unrestricted 600-V-UL approval, thanks to compact zigzag pinning
- Connection direction of the conductor: horizontal (0° -H) to the PCB
- Terminal blocks that can be lined up next to each other for color coding from position to position
- Single-position terminal blocks with double pinning

Notes:

When aligning versions with double pinning, other rated insulation voltages can occur.

¹⁾ Please observe the current carrying capacity curves and laboratory data sheets. Further current carrying capacity curves on request.

Accessories

For all types	Type	Page
	Marker strips SK 5,0 WH:REEL Order No. 0805221	801
	Screwdriver SZF 2-0,8 x4,0 Order No. 1204520	
	Ferrules with and without plastic sleeve	834
	Crimping pliers for 0.25 to 6 mm ² CRIMPFOX 6 Order No. 1212034	
	Crimping pliers for 10 to 16 mm ² CRIMPFOX 16 S Order No. 1207983	

Current carrying capacity curve

Type: SPT 16/...-H-10,0-ZB
Test based on DIN EN 60512-5-2:2003-01
Reduction factor = 1
Number of positions: 5

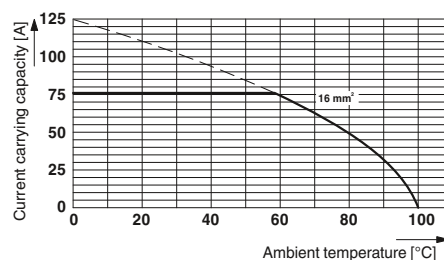

Technical data

Technical data in accordance to IEC / DIN VDE

Rated current / conductor cross section [A] / [mm²]
Rated insulation voltage for pollution degree 2 [V]

Pitch [mm]

Connection capacity

Solid & multi-strand / stranded [mm²] / [mm²] / AWG

Stranded with ferrules without plastic sleeve [mm²]

Stranded with ferrules with plastic sleeve [mm²]

Multi-conductor connection capacity (two conductors with the same cross section)

Solid & multi-strand / stranded [mm²]

Stranded with ferrules without plastic sleeve [mm²]

Stranded with TWIN ferrule with plastic sleeve [mm²]

Insulation coordination

Surge voltage category / pollution degree

Rated insulation voltage [V]

Rated surge voltage [kV]

Approval data (UL/CUL) Use Group

Nominal voltage [V]

Nominal current [A]

Connection capacity AWG AWG

Approval data (CSA) Use Group

Nominal voltage [V]

Nominal current [A]

Connection capacity AWG AWG

General data

Stripping length [mm]

Type of insulation material / insulation material group

Inflammability class according to UL 94

Drill hole diameter / pin dimensions [mm]

SPT 16/ 1-H-10,0

Rated current / conductor cross section [A] / [mm ²]			76 ¹⁾ / 16			76 ¹⁾ / 16		
Rated insulation voltage for pollution degree 2 [V]			1000			1000		
Pitch [mm]			10			10		
Connection capacity								
Solid & multi-strand / stranded [mm ²] / [mm ²] / AWG			0.75 - 16 / 0.75 - 16 / 20 - 4			0.75 - 16 / 0.75 - 16 / 20 - 4		
Stranded with ferrules without plastic sleeve [mm ²]			0.75 - 16			0.75 - 16		
Stranded with ferrules with plastic sleeve [mm ²]			0.75 - 10			0.75 - 10		
Multi-conductor connection capacity (two conductors with the same cross section)								
Solid & multi-strand / stranded [mm ²]			- / -			- / -		
Stranded with ferrules without plastic sleeve [mm ²]			-			-		
Stranded with TWIN ferrule with plastic sleeve [mm ²]			0.75 - 4			0.75 - 4		
Insulation coordination								
Surge voltage category / pollution degree			III / 3 III / 2 II / 2			III / 3 III / 2 II / 2		
Rated insulation voltage [V]			1000 1000 1000			1000 1000 1000		
Rated surge voltage [kV]			8 8 6			8 8 6		
Approval data (UL/CUL) Use Group			B C D			B C D		
Nominal voltage [V]			300 150 300			600 600 -		
Nominal current [A]			66 66 10			66 66 -		
Connection capacity AWG AWG			20 - 4 20 - 4 20 - 4			20 - 4 20 - 4 -		
Approval data (CSA) Use Group			B C D			B C D		
Nominal voltage [V]			- - -			- - -		
Nominal current [A]			- - -			- - -		
Connection capacity AWG AWG			- - -			- - -		
General data								
Stripping length [mm]			18			18		
Type of insulation material / insulation material group			PA / I			PA / I		
Inflammability class according to UL 94			V0			V0		
Drill hole diameter / pin dimensions [mm]			1.7 / 1.2 x 1 mm			1.7 / 1.2 x 1 mm		

No. of pos. Dim. a [mm]

1	0.00
2	10.00
3	20.00
4	30.00
5	40.00
6	50.00
7	60.00
8	70.00
9	80.00



Individual PCB terminal block, double pinning

Z pinning, 600 V UL approval



Dimensional drawing

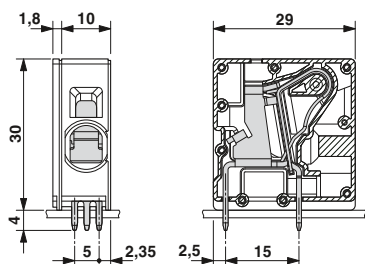

Drilling diagram

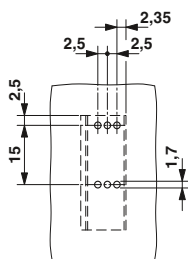

Ordering data

Type Order No. Pcs. / Pkt.
10 mm pitch, color: green

SPT 16/ 1-H-10,0 1735778 50



Dimensional drawing

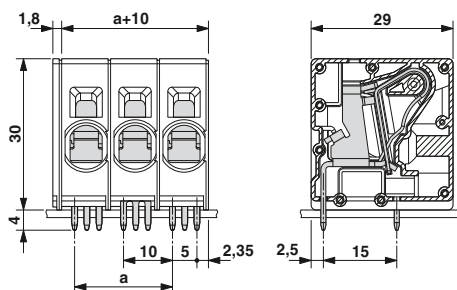

Drilling diagram

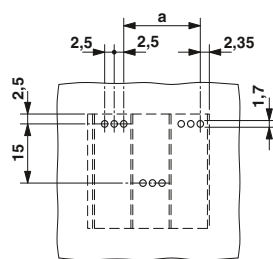

Ordering data

Type Order No. Pcs. / Pkt.
10 mm pitch, color: green

SPT 16/ 2-H-10,0-ZB	1735781	50
SPT 16/ 3-H-10,0-ZB	1735794	50
SPT 16/ 4-H-10,0-ZB	1735804	50
SPT 16/ 5-H-10,0-ZB	1735817	50
SPT 16/ 6-H-10,0-ZB	1735820	50
SPT 16/ 7-H-10,0-ZB	1735833	50
SPT 16/ 8-H-10,0-ZB	1735846	50
SPT 16/ 9-H-10,0-ZB	1735859	50

PCB terminal blocks for power electronics with pitch from 6.35 to 15.0 mm

PCB terminal blocks with push-in spring connection, SPT series up to 76 A/16 mm²

Vertical connection direction, pitch 10 mm

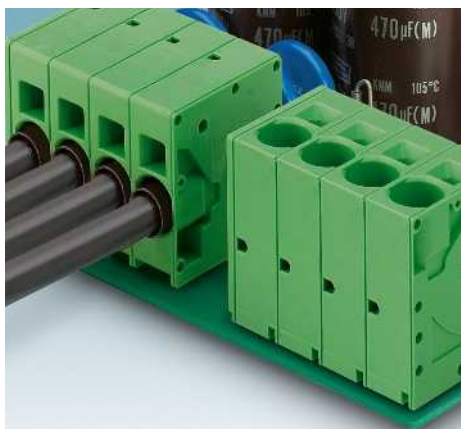

- SPT 16 PCB terminal block with push-in spring connection for conductor cross sections up to 16 mm² and a current carrying capacity of 76 A
- Fast connection technology, thanks to principle of direct plug-in without tools
- Unrestricted 600-V-UL approval, thanks to compact zig-zag pinning
- Connection direction of the conductor: horizontal (90° -V) to the PCB
- Single-position terminal blocks with double pinning
- Additional versions with anti-rotation protection for clear positioning during PCB assembly

Notes:

When aligning versions with double pinning, other rated insulation voltages can occur.

1) Please observe the current carrying capacity curves and laboratory data sheets. Further current carrying capacity curves on request.

Accessories

For all types	Type	Page
	Marker strips SK 5,0 WH:REEL Order No. 0805221	801
	Screwdriver SZF 2-0,8 x4,0 Order No. 1204520	
	Ferrules with and without plastic sleeve	834
	Crimping pliers for 0.25 to 6 mm ² CRIMPFOX 6 Order No. 1212034	
	Crimping pliers for 10 to 16 mm ² CRIMPFOX 16 S Order No. 1207983	

Current carrying capacity curve

Type: SPT 16/...-V-10,0-ZB
Test based on DIN EN 60512-5-2:2003-01
Reduction factor = 1
Number of positions: 5

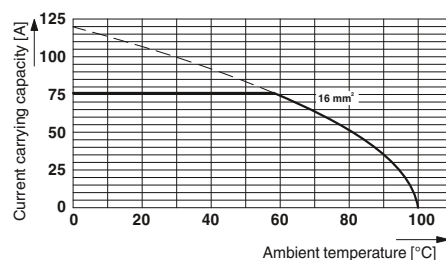

Technical data

Technical data in accordance to IEC / DIN VDE	
Rated current / conductor cross section	[A] / [mm ²]
Rated insulation voltage for pollution degree 2	[V]
Pitch	[mm]
Connection capacity	
Solid & multi-strand / stranded	[mm ²] / [mm ²] / AWG
Stranded with ferrules without plastic sleeve	[mm ²]
Stranded with ferrules with plastic sleeve	[mm ²]
Multi-conductor connection capacity (two conductors with the same cross section)	
Solid & multi-strand / stranded	[mm ²]
Stranded with ferrules without plastic sleeve	[mm ²]
Stranded with TWIN ferrule with plastic sleeve	[mm ²]
Insulation coordination	
Surge voltage category / pollution degree	
Rated insulation voltage	[V]
Rated surge voltage	[kV]
Approval data (UL/CUL)	Use Group
Nominal voltage	[V]
Nominal current	[A]
Connection capacity AWG	AWG
Approval data (CSA)	Use Group
Nominal voltage	[V]
Nominal current	[A]
Connection capacity AWG	AWG
General data	
Stripping length	[mm]
Type of insulation material / insulation material group	
Inflammability class according to UL 94	
Drill hole diameter / pin dimensions	[mm]

SPT 16/ 1-V-10,0

76 ¹⁾ / 16		
1000		
10		
0.75 - 16 / 0.75 - 16 / 20 - 4		
0.75 - 16		
0.75 - 10		
- / -		
-		
0.75 - 4		
III / 3	III / 2	II / 2
1000	1000	1000
8	8	6
B	C	D
300	150	300
66	66	10
20 - 4	20 - 4	20 - 4
B	C	D
-	-	-
-	-	-
-	-	-
18		
PA / I		
V0		
1.7 / 1.2 x 1 mm		

SPT 16/ ...-V-10,0-ZB

76 ¹⁾ / 16		
1000		
10		
0.75 - 16 / 0.75 - 16 / 20 - 4		
0.75 - 16		
0.75 - 10		
- / -		
-		
0.75 - 4		
III / 3	III / 2	II / 2
1000	1000	1000
8	8	6
B	C	D
600	600	-
66	66	-
20 - 4	20 - 4	-
B	C	D
-	-	-
-	-	-
-	-	-
18		
PA / I		
V0		
1.7 / 1.2 x 1 mm		

No. of pos.	Dim. a [mm]
1	0.00
2	10.00
3	20.00
4	30.00
5	40.00
6	50.00
7	60.00
8	70.00
9	80.00
2	10.00



Individual PCB terminal block, double pinning

Z pinning, 600 V UL approval



Dimensional drawing

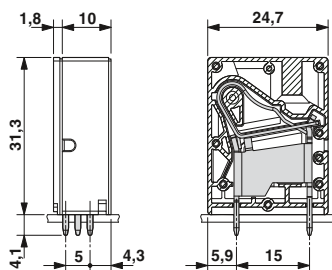

Drilling diagram

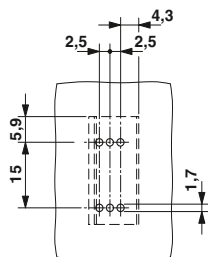

Dimensional drawing

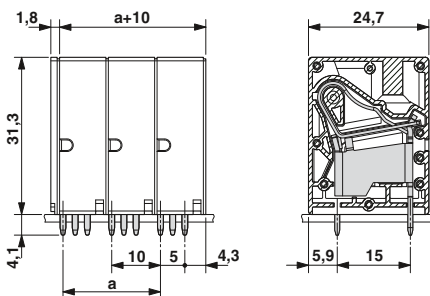

Drilling diagram

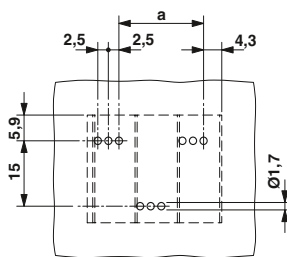

Ordering data

Type	Order No.	Pcs. / Pkt.
10 mm pitch, color: green		
SPT 16/ 1-V-10,0	1735862	50

Ordering data

Type	Order No.	Pcs. / Pkt.
10 mm pitch, color: green		
SPT 16/ 2-V-10,0-ZB	1735875	50
SPT 16/ 3-V-10,0-ZB	1735888	50
SPT 16/ 4-V-10,0-ZB	1735891	50
SPT 16/ 5-V-10,0-ZB	1735901	50
SPT 16/ 6-V-10,0-ZB	1735914	50
SPT 16/ 7-V-10,0-ZB	1735927	50
SPT 16/ 8-V-10,0-ZB	1735930	50
SPT 16/ 9-V-10,0-ZB	1735943	50
10 mm pitch, color: green, with anti-rotation pins, drilling diagram, and dimensional drawing, see www.phoenixcontact.net/products		
SPT 16/ 2-V-10,0-ZBV GN	1775356	50

PCB terminal blocks for power electronics with pitch from 6.35 to 15.0 mm

PCB terminal blocks with push-lock spring connection, PL series up to 76 A/16 mm²



Horizontal connection direction, zig-zag pinning, 600 V UL approval



Individual PCB terminal block, 30° angled connection direction, double pinning



30° angled connection direction, zig-zag pinning, 600 V UL approval

Dimensional drawing

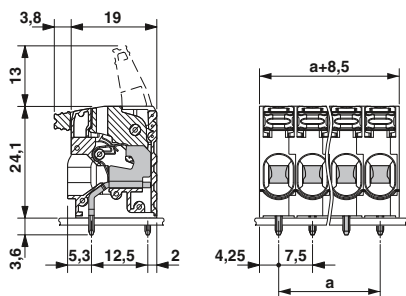

Drilling diagram

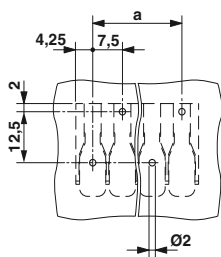

Dimensional drawing

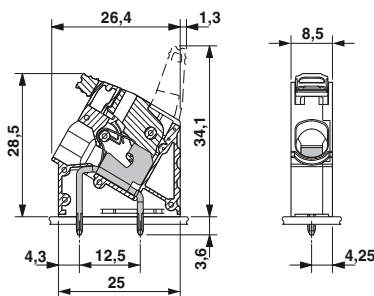

Drilling diagram

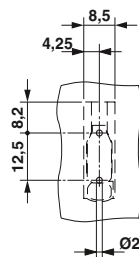

Dimensional drawing

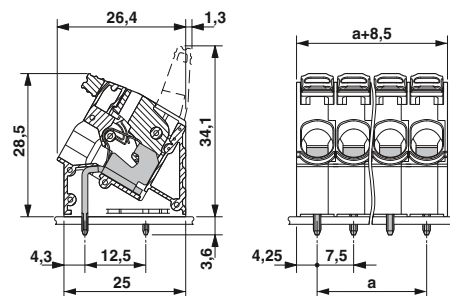

Drilling diagram

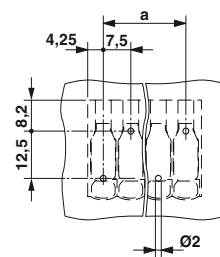

Ordering data

Type	Order No.	Pcs. / Pkt.
7.5 mm pitch, color: green		
PLH 5/ 2-7,5-ZF	1792106	25
PLH 5/ 3-7,5-ZF	1792119	25
PLH 5/ 4-7,5-ZF	1792122	25
PLH 5/ 5-7,5-ZF	1792135	25
PLH 5/ 6-7,5-ZF	1792148	25
PLH 5/ 7-7,5-ZF	1792151	25
PLH 5/ 8-7,5-ZF	1792164	25
PLH 5/ 9-7,5-ZF	1792177	25
PLH 5/10-7,5-ZF	1792180	25
PLH 5/11-7,5-ZF	1792193	25
PLH 5/12-7,5-ZF	1792203	25

Ordering data

Type	Order No.	Pcs. / Pkt.
7.5 mm pitch, color: green		
PLA 5/ 1-7,5	1792216	25

Ordering data

Type	Order No.	Pcs. / Pkt.
7.5 mm pitch, color: green		
PLA 5/ 2-7,5-ZF	1792229	25
PLA 5/ 3-7,5-ZF	1792232	25
PLA 5/ 4-7,5-ZF	1792245	25
PLA 5/ 5-7,5-ZF	1792258	25
PLA 5/ 6-7,5-ZF	1792261	25
PLA 5/ 7-7,5-ZF	1792274	25
PLA 5/ 8-7,5-ZF	1792287	25
PLA 5/ 9-7,5-ZF	1792290	25
PLA 5/10-7,5-ZF	1792300	25
PLA 5/11-7,5-ZF	1792313	25
PLA 5/12-7,5-ZF	1792326	25

PCB terminal blocks for power electronics with pitch from 6.35 to 15.0 mm

PCB terminal blocks with push-lock spring connection, PL series up to 76 A/16 mm²

Horizontal connection direction up to 10/15 mm pitch

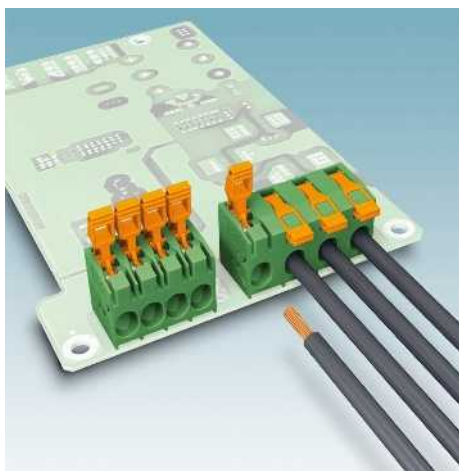





- PLH 16 terminal block with push-lock spring connection with lever operation for conductor cross sections up to 16 mm² and a current carrying capacity of up to 76 A
- Low actuation forces
- Fast connection technology, thanks to the toolless “One-hand tilting lever principle” or the direct plug-in method
- Unrestricted 600 V-UL approval already available with a 10 mm pitch with zig-zag pinning
- Touch connection for integration in the center of the lever
- Color coding from position to position, thanks to terminal blocks that can be mounted side by side
- Supplied open

Notes:

1) Please observe the current carrying capacity curves and laboratory data sheets. Further current carrying capacity curves on request.

Accessories

For all types	Type	Page
	Marker cards SK U/3,8 WH: UN- PRINTED Order No. 0803906	
	Ferrules with and without plastic sleeve	834
	Crimping pliers for 0.25 to 6 mm ² CRIMPFOX 6 Order No. 1212034	
	Crimping pliers for 10 to 16 mm ² CRIMPFOX 16 S Order No. 1207983	

Current carrying capacity curve

Type: PLH 16/...-10

Tested in accordance with DIN EN 60512-5-2:2003-01

No. of positions: 5

Conductor cross section: 16 mm²

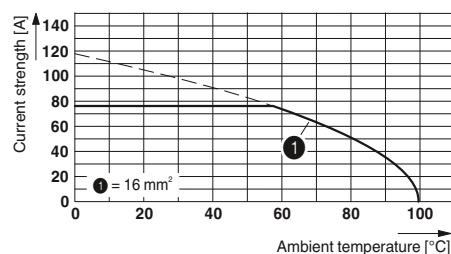

Technical data

Technical data in accordance to IEC / DIN VDE

Rated current / conductor cross section [A] / [mm²]

Rated insulation voltage for pollution degree 2 [V]

Pitch [mm]

Connection capacity

Solid & multi-strand / stranded [mm²] / [mm²] / AWG

Stranded with ferrules without plastic sleeve [mm²]

Stranded with ferrules with plastic sleeve [mm²]

Multi-conductor connection capacity (two conductors with the same cross section)

Solid & multi-strand / stranded [mm²]

Stranded with ferrules without plastic sleeve [mm²]

Stranded with TWIN ferrule with plastic sleeve [mm²]

Insulation coordination

Surge voltage category / pollution degree

Rated insulation voltage [V]

Rated surge voltage [kV]

Approval data (UL/CUL) Use Group

Nominal voltage [V]

Nominal current [A]

Connection capacity AWG

Approval data (CSA) Use Group

Nominal voltage [V]

Nominal current [A]

Connection capacity AWG

General data

Stripping length [mm]

Type of insulation material / insulation material group

Inflammability class according to UL 94

Drill hole diameter / pin dimensions [mm]

PLH 16/ ...-10

76¹⁾ / 16

400

10

0.75 - 16 / 0.75 - 16 / 18 - 4

0.75 - 16

0.75 - 10

- / -

-

0.75 - 4

III / 3 III / 2 II / 2

400 400 800

4 4 4

B C D

300 300 -

51 51 -

18 - 6 18 - 6 -

B C D

- - -

- - -

- - -

18

PA / I

V0

1.6 / 1.2 x 1.2 mm

PLH 16/ ...-10-ZF

76¹⁾ / 16

1000

10

0.75 - 16 / 0.75 - 16 / 18 - 4

0.75 - 16

0.75 - 10

- / -

-

0.75 - 4

III / 3 III / 2 II / 2

1000 1000 1000

8 8 8

B C D

600 600 -

51 51 -

18 - 6 18 - 6 -

B C D

- - -

- - -

- - -

18

PA / I

V0

1.6 / 1.2 x 1.2 mm

PLH 16/ ...-15

76¹⁾ / 16

1000

15

0.75 - 16 / 0.75 - 16 / 18 - 4

0.75 - 16

0.75 - 10

- / -

-

0.75 - 4

III / 3 III / 2 II / 2

1000 1000 1000

8 8 8

B C D

600 600 -

66 66 -

18 - 4 18 - 4 -

B C D

- - -

- - -

- - -

18

PA / I

V0

1.6 / 1.2 x 1.2 mm

No. of pos. Dim. a [mm]

1

2 10.00

3 20.00

4 30.00

5 40.00

6 50.00

7 60.00

8 70.00

2 15.00

3 30.00

4 45.00

5 60.00

6 75.00

7 90.00

8 105.00

PCB terminal blocks for power electronics with pitch from 6.35 to 15.0 mm

PCB terminal blocks with push-lock spring connection, PL series up to 76 A/16 mm²



Double pinning, 10 mm pitch



600 V UL approval, Z pinning, 10 mm pitch



600 V UL approval, double pinning, 15 mm pitch



Dimensional drawing

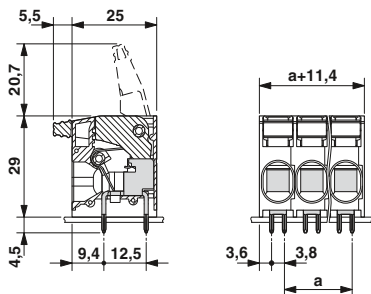

Drilling diagram

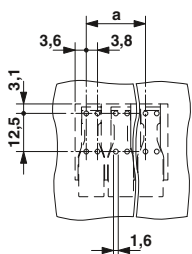

Dimensional drawing

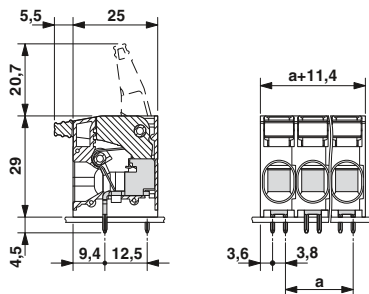

Drilling diagram

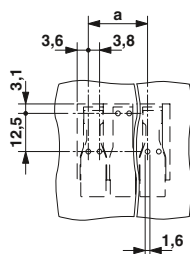

Dimensional drawing

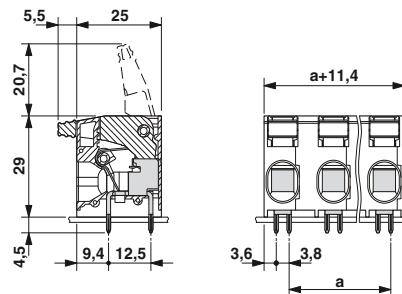

Drilling diagram

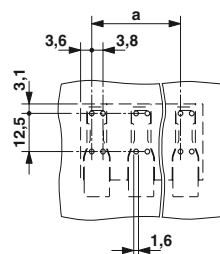

Ordering data

Type	Order No.	Pcs. / Pkt.
10 mm pitch, color: green		
PLH 16/ 1-10	1703995	25
PLH 16/ 2-10	1770393	25
PLH 16/ 3-10	1770403	25
PLH 16/ 4-10	1770416	25
PLH 16/ 5-10	1770429	25
PLH 16/ 6-10	1770432	25
PLH 16/ 7-10	1770445	25
PLH 16/ 8-10	1770458	25

Ordering data

Type	Order No.	Pcs. / Pkt.
10 mm pitch, color: green		
PLH 16/ 2-10-ZF	1770461	25
PLH 16/ 3-10-ZF	1770474	25
PLH 16/ 4-10-ZF	1770487	25
PLH 16/ 5-10-ZF	1770490	25
PLH 16/ 6-10-ZF	1770500	25
PLH 16/ 7-10-ZF	1770513	25
PLH 16/ 8-10-ZF	1770526	25

Ordering data

Type	Order No.	Pcs. / Pkt.
15 mm pitch, color: green		
PLH 16/ 2-15	1770539	25
PLH 16/ 3-15	1770542	25
PLH 16/ 4-15	1770555	25
PLH 16/ 5-15	1770568	25
PLH 16/ 6-15	1770571	25
PLH 16/ 7-15	1770584	25
PLH 16/ 8-15	1770597	25

PCB terminal blocks for power electronics with pitch from 6.35 to 15.0 mm

PCB terminal blocks with push-lock spring connection for the reflow process, PTSPL series up to 41 A/6 mm²

Horizontal connection direction without insulating housing

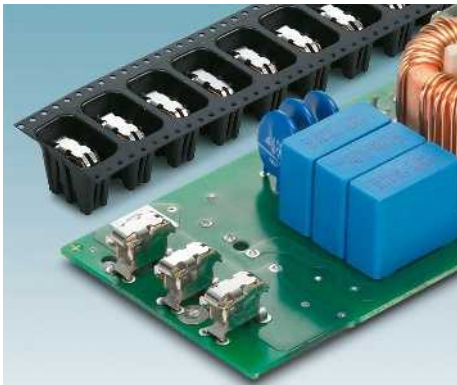

- PTSPL 6 push-lock spring-cage PCB terminal block without insulating body for conductor cross sections up to 6 mm² and a current carrying capacity of up to 41 A
- For use in SMT reflow processes
- Low actuation forces
- Delivery form: tape-on-reel packing according to IEC 60286-3 for automated mounting; 330 mm reel diameter
- PTSPL spring closed for assembly with vacuum pipette
- PTSPLO spring opened for assembly with mechanical gripper
- Standard pin lengths of 2.1 mm and 2.9 mm



Notes:

Pick and place pads for taped THR articles usually protrude beyond the components. The PCB layout must ensure that collisions are avoided when components are assembled. Dimensional drawings of tape reels and place pads can be found online at www.phoenixcontact.net/products.

1) UL/CUL on request.

2) Please observe the current carrying capacity curves and laboratory data sheets. Current carrying capacity curves can be found at www.phoenixcontact.net/products.

Accessories

For all types	Type	Page
	Screwdriver SZF 1-0,6 x 3,5 Order No. 1204517	
	Ferrules with and without plastic sleeve	834
	Crimping pliers for 0.25 to 6 mm ² CRIMPFOX 6 Order No. 1212034	

Technical data

Technical data in accordance to IEC / DIN VDE

Rated current / conductor cross section [A] / [mm²]
Rated insulation voltage for pollution degree 2 [V]

Pitch [mm]

Connection capacity

Solid & multi-strand / stranded [mm²] / [mm²] / AWG

Stranded with ferrules without plastic sleeve [mm²]

Stranded with ferrules with plastic sleeve [mm²]

Multi-conductor connection capacity (two conductors with the same cross section)

Solid & multi-strand / stranded [mm²]

Stranded with ferrules without plastic sleeve [mm²]

Stranded with TWIN ferrule with plastic sleeve [mm²]

Insulation coordination

Surge voltage category / pollution degree

Rated insulation voltage [V]

Rated surge voltage [kV]

Approval data (UL/CUL) Use Group

Nominal voltage [V]

Nominal current [A]

Connection capacity AWG AWG

Approval data (CSA) Use Group

Nominal voltage [V]

Nominal current [A]

Connection capacity AWG AWG

General data

Stripping length [mm]

Type of insulation material / insulation material group

Inflammability class according to UL 94

Drill hole diameter / pin dimensions [mm]

PTSPL-6/1-2X2 2,1

PTSPLO-6/1-2X2 2,1

41 ²⁾ / 6			41 ²⁾ / 6		
-			-		
-			-		
- / 2.5 - 6 / -			- / 2.5 - 6 / -		
2.5 - 6			2.5 - 6		
-			-		
- / -			- / -		
-			-		
-			-		
III / 3	III / 2	II / 2	III / 3	III / 2	II / 2
B	C	D	B	C	D
-	-	-	-	-	-
-	-	-	-	-	-
-	-	-	-	-	-
B	C	D	B	C	D
-	-	-	-	-	-
-	-	-	-	-	-
-	-	-	-	-	-
15			15		
- / -			- / -		
-			-		
1.3 / 0.6 x 1			1.3 / 0.6 x 1		

No. of pos.

PCB terminal blocks for power electronics with pitch from 6.35 to 15.0 mm

PCB terminal blocks with push-lock spring connection for the reflow process, PTSPL series up to 41 A/6 mm²



N

Closed on delivery, tape-on-reel packing



N

Open on delivery, individual PCB terminal block without insulating body, tape-on-reel packing

Dimensional drawing

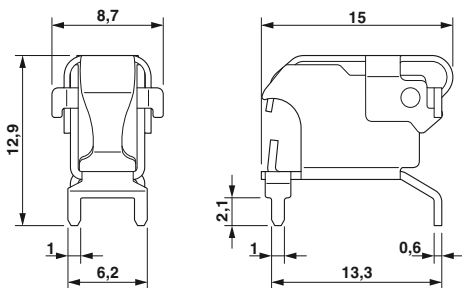

Dimensional drawing

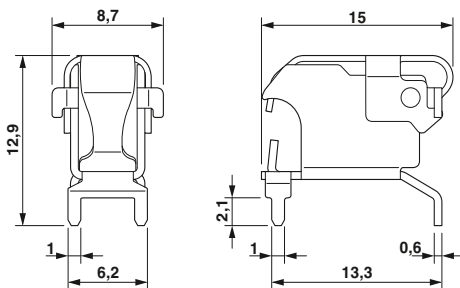

Drilling diagram

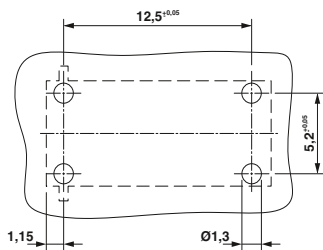

Drilling diagram

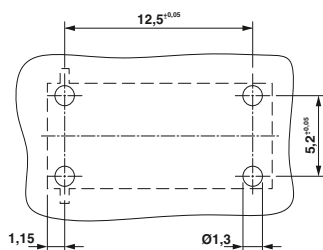

Ordering data

Type	Order No.	Pcs. / Pkt.
PCB terminal block closed, pin length 2.1 mm		
PTSPL-6/1-2X2 2,1 R32	1704836	240
PCB terminal block closed, pin length 2.9 mm		
PTSPL-6/1-2X2 2,9 R32	1704837	240

Ordering data

Type	Order No.	Pcs. / Pkt.
PCB terminal block open, pin length 2.1 mm		
PTSPLO-6/1-2X2 2,1 R32	1705081	220
Open PCB terminal block, pin length 2.9 mm		
PTSPLO-6/1-2X2 2,9 R32	1705085	220

PCB terminal blocks for power electronics with pitch from 6.35 to 15.0 mm

PCB terminal blocks with spring-cage connection, ZFKDS series up to 76 A/16 mm²

Angled connection direction, pitch 7.5 mm



- PCB terminal blocks with spring-cage connection up to 6 mm² conductor cross section
- Fully insulated bridges (FBSK) with different number of positions, e. g. for potential distribution
- Integrated test connection
- Pitch spacers (RZ) for voltage expansion
- Optional mounting flange (FL) for safe mounting in the device
- Colored marking of individual positions is possible
- A ZFKDSA end terminal block must be used at the end of a row of terminal blocks

Notes:

In order to avoid tolerances between the terminal blocks and PCB, the terminal row should be interrupted when the number of positions exceeds 30.

The current carrying capacity of the FBSK-ZFKDS 4 plug-in bridge is 20 A (see laboratory data sheet).

¹⁾ Please observe the current carrying capacity curves and laboratory data sheets. Further current carrying capacity curves on request.

Accessories		
For all types	Type	Page
	Pitch spacer, width: 2.5 mm RZ-ZFKDS 4 Order No. 1928521	
	Pair of flanges FL-ZFKDS 4 Order No. 1928495	
	Marker cards SK 7,5/5 or SK10/5	800
	Flat Zack marker strip ZBF 7,5 or ZBF 10	807
	Crimping pliers for 0.25 to 6 mm ² CRIMPFIX 6 Order No. 1212034	
Only for ZFKDS 4...		
	Plug-in bridge FBSK...	830

Current carrying capacity curve

Type: ZFKDS 4-7,5 and ZFKDSA 4-9
Test following DIN EN 60512-5-2:2003-01
Reduction factor = 1
No. of positions: 5

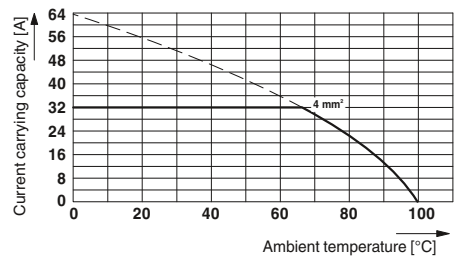

Technical data

Technical data in accordance to IEC / DIN VDE	
Rated current / conductor cross section	[A] / [mm ²]
Rated insulation voltage for pollution degree 2	[V]
Pitch	[mm]
Connection capacity	
Solid / stranded	[mm ²] / [mm ²] / AWG
Stranded with ferrules without plastic sleeve	[mm ²]
Stranded with ferrules with plastic sleeve	[mm ²]
Multi-conductor connection capacity (two conductors with the same cross section)	
Solid / stranded	[mm ²]
Stranded with ferrules without plastic sleeve	[mm ²]
Stranded with TWIN ferrule with plastic sleeve	[mm ²]
Insulation coordination	
Surge voltage category / pollution degree	
Rated insulation voltage	[V]
Rated surge voltage	[kV]
Approval data (UL/CUL)	Use Group
Nominal voltage	[V]
Nominal current	[A]
Connection capacity AWG	AWG
Approval data (CSA)	Use Group
Nominal voltage	[V]
Nominal current	[A]
Connection capacity AWG	AWG
General data	
Stripping length	[mm]
Type of insulation material / insulation material group	
Inflammability class according to UL 94	
Drill hole diameter / pin dimensions	[mm]

ZFKDS 4-7,5			ZFKDS 4-10		
Rated current / conductor cross section			32 ¹⁾ / 6		
Rated insulation voltage for pollution degree 2			630		
Pitch			7.5		
Connection capacity			10		
Solid / stranded			0.2 - 6 / 0.2 - 4 / 24 - 10		
Stranded with ferrules without plastic sleeve			0.25 - 4		
Stranded with ferrules with plastic sleeve			0.25 - 4		
Multi-conductor connection capacity (two conductors with the same cross section)					
Solid / stranded			- / -		
Stranded with ferrules without plastic sleeve			-		
Stranded with TWIN ferrule with plastic sleeve			-		
Insulation coordination					
Surge voltage category / pollution degree			III / 3 III / 2 II / 2		
Rated insulation voltage			500 630 1000		
Rated surge voltage			6 6 6		
Approval data (UL/CUL)			B C D		
Nominal voltage			300 150 300		
Nominal current			30 30 10		
Connection capacity AWG			24 - 10 24 - 10 24 - 10		
Approval data (CSA)			B C D		
Nominal voltage			-		
Nominal current			-		
Connection capacity AWG			-		
General data					
Stripping length			10		
Type of insulation material / insulation material group			PA / I		
Inflammability class according to UL 94			V0		
Drill hole diameter / pin dimensions			1.8 / 1.0 x 1.4 mm		

No. of pos.	1
	1
	1

PCB terminal blocks for power electronics with pitch from 6.35 to 15.0 mm

PCB terminal blocks with spring-cage connection, ZFKDS series up to 76 A/16 mm²



7.5 mm pitch, with test connection, bridgeable

10 mm pitch, with test connection, bridgeable



Dimensional drawing

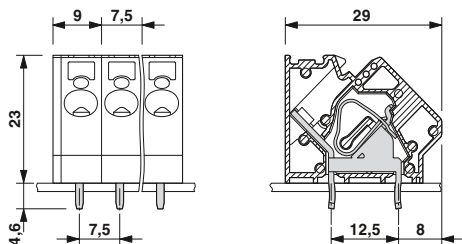

Drilling diagram

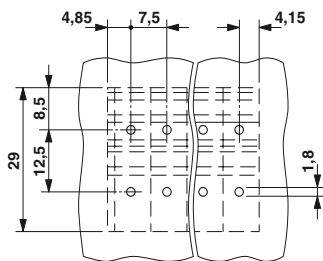

Ordering data

Type	Order No.	Pcs. / Pkt.
7.5 mm pitch, color: green		
ZFKDS 4-7,5	1907526	50
End terminal block, 9 mm wide, required at the end of a terminal row		
ZFKDSA 4-9	1907542	50



Dimensional drawing

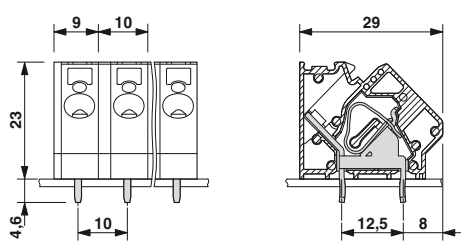

Drilling diagram

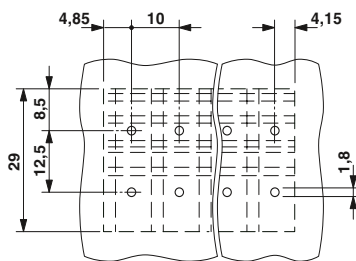

Ordering data

Type	Order No.	Pcs. / Pkt.
10 mm pitch, color: green		
ZFKDS 4-10	1907539	50
End terminal block, 9 mm wide, required at the end of a terminal row		
ZFKDSA 4-9	1907542	50

PCB terminal blocks for power electronics with pitch from 6.35 to 15.0 mm

PCB terminal blocks with spring-cage connection, ZFKDS series up to 76 A/16 mm²

Angled connection direction, pitch 10 mm

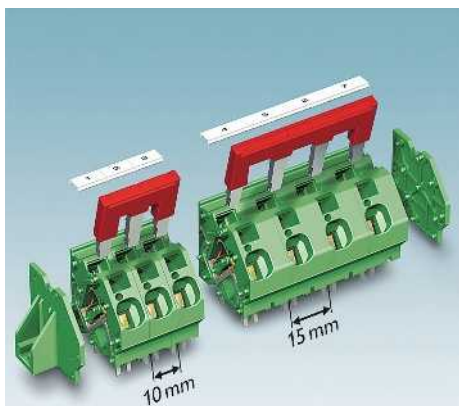

- PCB terminal blocks with spring-cage connection up to 16 mm² conductor cross section
- 15 mm pitch for the unrestricted 600-V-UL approval
- Fully insulated bridges (FBSK) with different number of positions, e. g. for potential distribution
- Integrated test connection
- Optional mounting flange (FL) for safe mounting in the device
- Colored marking of individual positions is possible
- A ZFKDSA end terminal block must be used at the end of a row of terminal blocks

Notes:

In order to avoid tolerances between the terminal blocks and PCB, the terminal row should be interrupted when the number of positions exceeds 30.

The current carrying capacity of the FBSK-ZFKDS 10 plug-in bridge is 57 A (see laboratory data sheet).

1) When the bridge is used, the voltage is reduced to 800 V.

2) Please observe the current carrying capacity curves and laboratory data sheets. Further current carrying capacity curves on request.

Accessories

For all types	Type	Page
	Pair of flanges FL-ZFKDS 10 Order No. 1987070	
	Screwdriver SZF 3-1,0 x 5,5 Order No. 1206612	
	Marker strips SK 5,0 WH:REEL Order No. 0805221	801
	Crimping pliers for 0.25 to 6 mm ² CRIMPFOX 6 Order No. 1212034	
	Crimping pliers for 10 to 16 mm ² CRIMPFOX 16 S Order No. 1207983	
Only for ZFKDS 10-...		
	Plug-in bridge FBSK.../ZFKDS 10	830

Current carrying capacity curve

Type: ZFKDS 10-10,00 and ZFKDSA 10-11,7
Test following DIN EN 60512-5-2:2003-01
Reduction factor = 1
No. of positions: 5

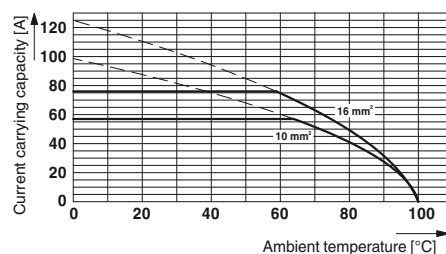

Technical data

Technical data in accordance to IEC / DIN VDE

Rated current / conductor cross section [A] / [mm²]

Rated insulation voltage for pollution degree 2 [V]

Pitch [mm]

Connection capacity

Solid / stranded [mm²] / [mm²] / AWG

Stranded with ferrules without plastic sleeve [mm²]

Stranded with ferrules with plastic sleeve [mm²]

Multi-conductor connection capacity (two conductors with the same cross section)

Solid / stranded [mm²]

Stranded with ferrules without plastic sleeve [mm²]

Stranded with TWIN ferrule with plastic sleeve [mm²]

Insulation coordination

Surge voltage category / pollution degree

Rated insulation voltage [V]

Rated surge voltage [kV]

Approval data (UL/CUL) Use Group

Nominal voltage [V]

Nominal current [A]

Connection capacity AWG AWG

Approval data (CSA) Use Group

Nominal voltage [V]

Nominal current [A]

Connection capacity AWG AWG

General data

Stripping length [mm]

Type of insulation material / insulation material group

Inflammability class according to UL 94

Drill hole diameter / pin dimensions [mm]

ZFKDS 10-10,00

ZFKDS 10-15,00

Rated current / conductor cross section [A] / [mm ²]	76 ²⁾ / 16			76 ²⁾ / 16		
Rated insulation voltage for pollution degree 2 [V]	400			1000 ¹⁾		
Pitch [mm]	10			15		
Connection capacity						
Solid / stranded [mm ²] / [mm ²] / AWG	0.2 - 16 / 0.2 - 16 / 24 - 6			0.2 - 16 / 0.2 - 16 / 24 - 6		
Stranded with ferrules without plastic sleeve [mm ²]	0.25 - 10			0.25 - 10		
Stranded with ferrules with plastic sleeve [mm ²]	0.25 - 10			0.25 - 10		
Multi-conductor connection capacity (two conductors with the same cross section)						
Solid / stranded [mm ²]	- / -			- / -		
Stranded with ferrules without plastic sleeve [mm ²]	-			-		
Stranded with TWIN ferrule with plastic sleeve [mm ²]	-			-		
Insulation coordination						
Surge voltage category / pollution degree	III / 3	III / 2	II / 2	III / 3	III / 2	II / 2
Rated insulation voltage [V]	320	400	800	1000 ¹⁾	1000 ¹⁾	1000 ¹⁾
Rated surge voltage [kV]	4	4	4	8	8	8
Approval data (UL/CUL) Use Group	B	C	D	B	C	D
Nominal voltage [V]	300	150	300	600	600	-
Nominal current [A]	65	65	10	65	65	-
Connection capacity AWG AWG	24 - 6	24 - 6	24 - 6	24 - 6	24 - 6	-
Approval data (CSA) Use Group	B	C	D	B	C	D
Nominal voltage [V]	-	-	-	-	-	-
Nominal current [A]	-	-	-	-	-	-
Connection capacity AWG AWG	-	-	-	-	-	-
General data						
Stripping length [mm]	12			12		
Type of insulation material / insulation material group	PA / I			PA / I		
Inflammability class according to UL 94	V0			V0		
Drill hole diameter / pin dimensions [mm]	2.2 / 1.2 x 1.4			2.2 / 1.2 x 1.4		

No. of pos.

1

1

1

1



10 mm pitch, with test connection, bridgeable



15 mm pitch, with test connection, bridgeable, 600 V UL approval



Dimensional drawing

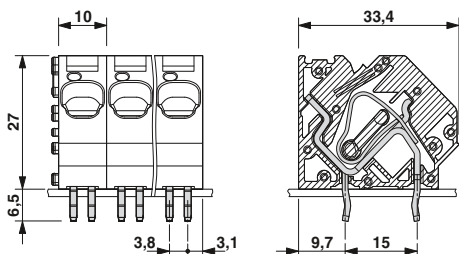

Drilling diagram

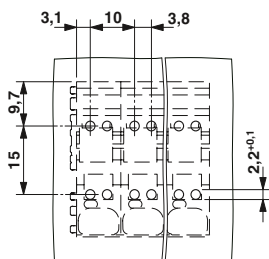

Ordering data

Type	Order No.	Pcs. / Pkt.
10 mm pitch, color: green ZFKDS 10-10,00	1986628	50
End terminal block, 11.7 mm wide, required at the end of a terminal row ZFKDSA 10-11,7	1987054	50



Dimensional drawing

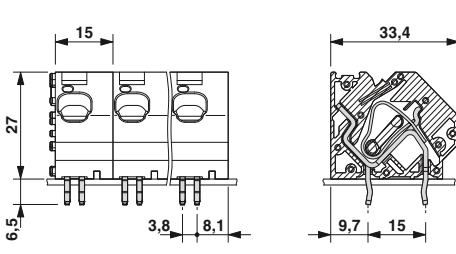

Drilling diagram

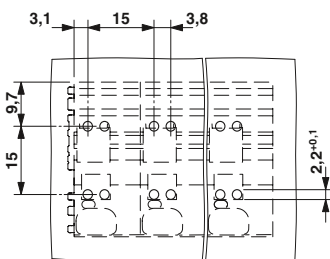

Ordering data

Type	Order No.	Pcs. / Pkt.
15 mm pitch, color: green ZFKDS 10-15,00	1986631	50
End terminal block, 16.7 mm wide, required at the end of a terminal row, ZFKDSA 10-16,7	1987067	50

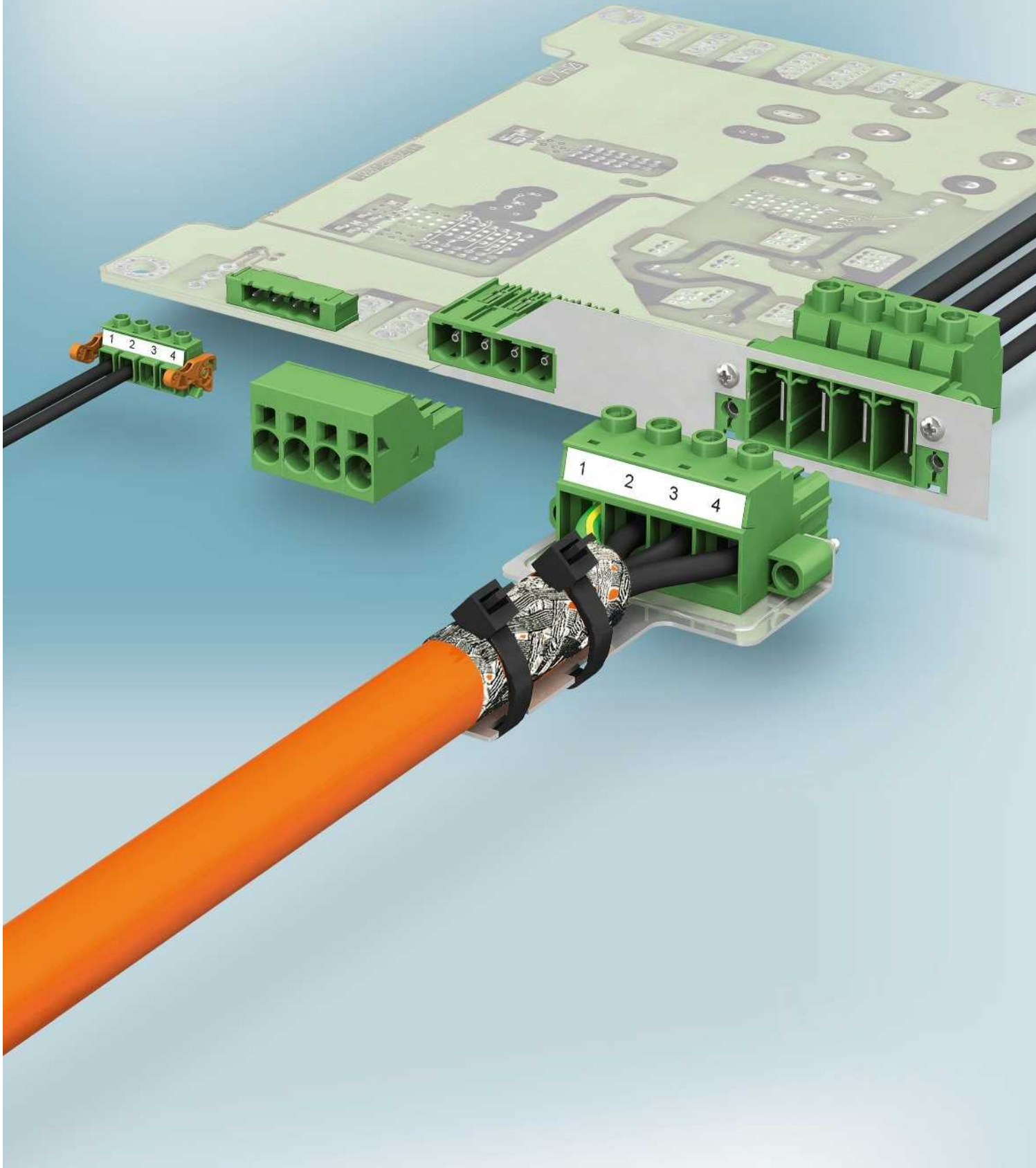

Plug-in connectors for power electronics

COMBICON power plug-in connectors provide professional connection solutions for power electronics. Plug-in PCB connections for numerous possible combinations are available from 16 A with the HC series up to 125 A in the PC 35 series. The conductors are connected with the proven screw connection technology (tension sleeve principle) or alternatively using the user-friendly direct plug-in technology.

In the high-performance classes 41 A (PC 5 series) and 76 A (PC 16 series) in particular, every one of the many and varied combinations supported by touch-protected (inverted) versions and housing feed-throughs is plug-in-capable and easy to maintain. In compact pitches and with 600 V UL approvals, the high-power plug-in connectors provide a connection for all applications with large cross sections anywhere on the global market.

General	482
COMBICON power cross-reference list	484
HC series plug-in connectors up to 16 A/2.5 mm², pitch 5.0 or 5.08/7.62 mm	490
Plugs with screw and spring connection	490
Headers with pin contact	490
Headers with socket contact	498
Vertical plugs for 600 V UL	498
Plugs with screw connection for 600 V UL	502
Headers with pin contact	504
Headers with socket contact	506
ME/ME MAX plug-in connectors/headers, pitch 7.25 mm	508
PC 4 series plug-in connectors up to 20 A/4 mm², pitch 7.62 mm	512
Plugs with screw and crimp connection	512
Headers with pin contact	512
Feed-through headers with pin contact	518
Headers with pin contact for DIN rail mounting	521
Cable housing for PC 4 plugs	521
PC 5 series plug-in connectors up to 41 A/10 mm², pitch 7.62 mm	521
Plugs with screw connection	521
Plugs with push-in spring connection	530
Headers with pin contact	536
Headers with socket contact	540
Feed-through headers with pin contact	544
PC 6 series plug-in connectors up to 41 A/6 mm², pitch 10.16 mm	550
Plugs with screw connection	550
Headers with pin contact	566
Plugs for direct mounting with socket contact	552
PC 16 series plug-in connectors up to 76 A/16 mm², pitch 10.16 mm	554
Plugs with screw and push-in spring connection	554
Headers with pin contact	566
Headers with socket contact	570
Feed-through headers with pin/socket contact	574
PC 35 series plug-in connectors up to 125 A/35 mm², pitch 15 mm	586
Plugs with screw connection	586
Headers with pin contact	590
Headers with socket contact	592
Sheet metal cutout dimensions	594

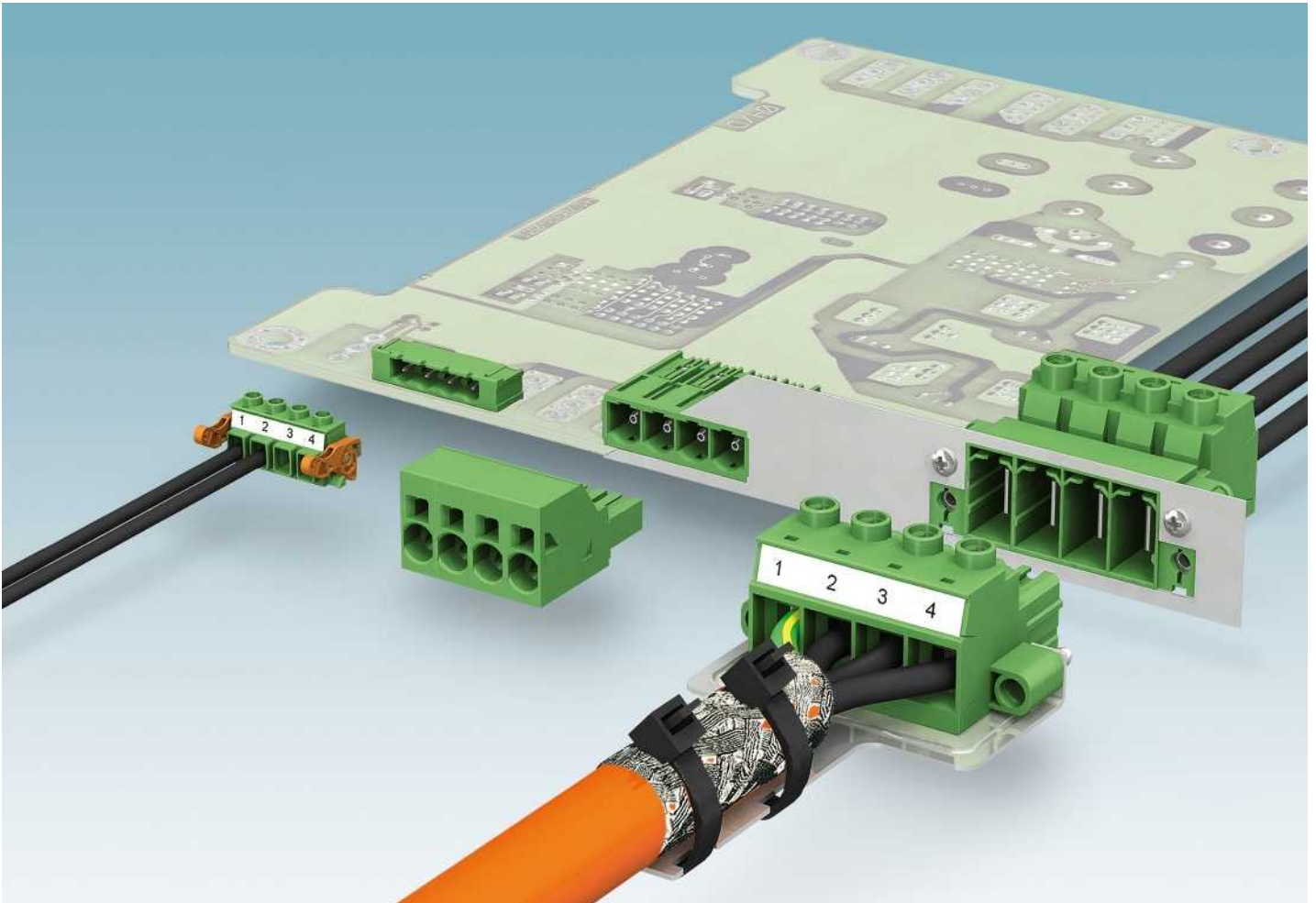

125 A via the PCB? It works!

Used in conjunction with high-current PCBs, the plug-in connectors for the power electronics support a current carrying capacity of up to 125 A.

Different PCB production technologies are providing new options for device design. The necessary functions and modules can now be grouped together on a single PCB. In this manner, expensive additional device wiring can be eliminated.

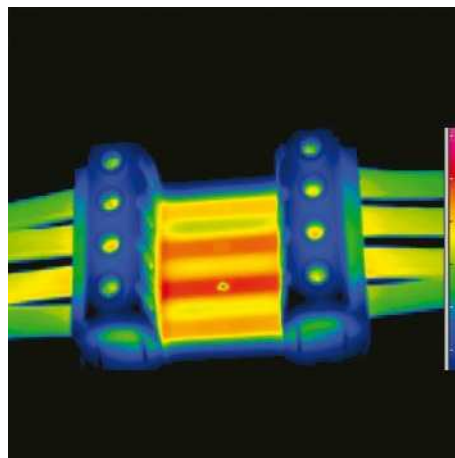

Thermographic image of a test application with 125 A

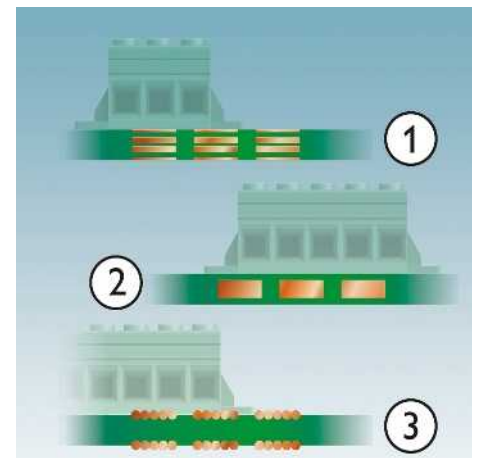

PCB production technologies

- ① = Multi-layer technology
- ② = Thick copper technology
- ③ = Wire-writing technology

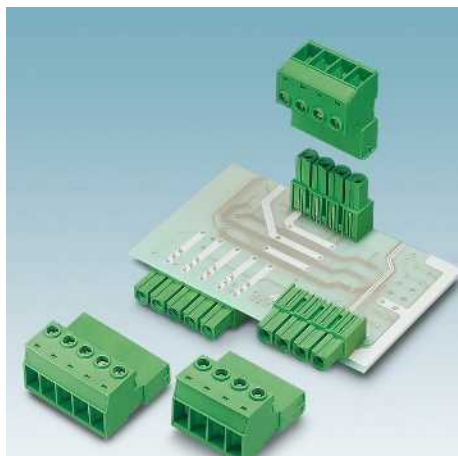

Touch-protected PCB inputs and outputs

The inverted plugs and headers provide the option of touch-protected PCB and device outputs. Furthermore, they also enable PCB/PCB and cable/cable connections to be implemented.

This enables a new level of freedom in device design.



Extra safety for optimum performance

All plug-in connectors for the power electronics have an integrated double steel spring. This covering spring provides additional safety in the event of power and temperature fluctuations. Contact corrosion is prevented as the double steel spring exerts additional pressure on the contact. This ensures the long-term stability of the contact resistance.

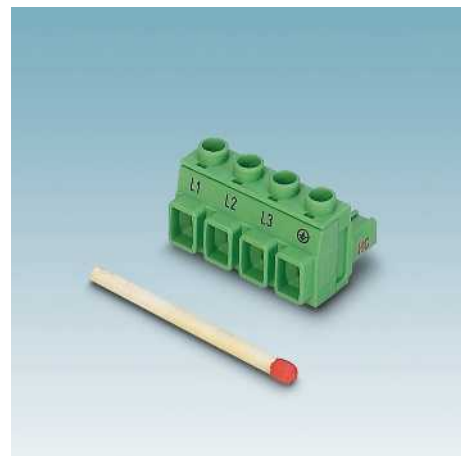

UL approvals for 600 V high-current applications

The plug-in connectors for the power electronics offer 600 V UL approval for every application, even those with the smallest of dimensions. Please note that a distinction must be made here between product and device approvals. The COMBICON power flyer lists the applicable approvals for products and applications in detail.



Plug versions with shield connection/strain relief

The shielded plug versions (-STF-SH) in the PC 5, PC 6, PC 16, and PC 35 product ranges provide a professional connection solution for the braided shield, which prevents electrical interference and meets EMC requirements.

- Spade connection for routing the shield
- PCB-SHIELD contacts the shield directly with the PCB
- Vibration-resistant connection, thanks to screws integrated in plug flange

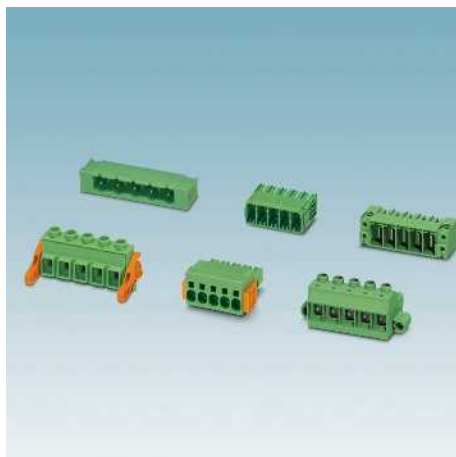

Reliable connection when exposed to vibration:

A fixed connection is essential for applications which experience high vibrations. A fixed connection can be implemented with:

- Conventional screw flange
- Automatic interlocking click & lock system
- New Lock & Release system, with ejector lever

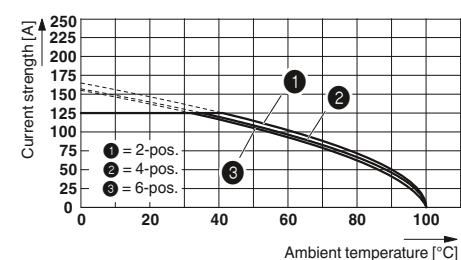











Current carrying capacity of the plug-in connection













Derating data is provided in the catalog so that the permitted current carrying capacity of the plug-in connections can be determined. The maximum permissible current strength for a specific application can be read depending on the ambient temperature. The number of positions and the connection cross section of the conductor must also be taken into consideration. Please also refer to the laboratory data sheets of the corresponding products. For further information, see page 854.

Plug-in connectors for power electronics with 5.0 to 15.0 mm pitch

COMBICON power cross-reference list











		COMBICON power plug-in connectors with pin contact					
COMBICON power plug-in connectors with socket contact	Type		MSTBA 2,5 HC/...G MSTBVA 2,5 HC/...G Page 496 497	MSTB 2,5 HC/...GF MSTBV 2,5 HC/...GF Page 497 497	FKIC 2,5 HC/...-ST FKIC 2,5 HC/...-STF Page 495	GMSTBA 2,5 HC/...-G GMSTBVA 2,5 HC/...-G Page 504	GIC 2,5 HCV/...-ST-7,62 Page 503
	Pitch		5.0 5.08	5.0 5.08	5.08	7.62	7.62
	MSTB 2,5 HC...ST Page 490	5.0	•				
	MSTB 2,5 HC...STF Page 491	5.08	•	•	•		
	MSTBT 2,5 HC...ST Page 491	5.0	•				
	MVSTBR 2,5 HC...ST Page 492	5.0	•		•		
	MVSTBR 2,5 HC...STF Page 493	5.08	•	•			
	MVSTBW 2,5 HC...ST Page 493	5.0	•		•		
	MVSTBW 2,5 HC...STF Page 493	5.08	•	•			
	FKC 2,5 HC/...-ST Page 494	5.0	•				
	FKC 2,5 HC/...-STF Page 495	5.08	•	•	•		
	IC 2,5 HC/...-G Page 498	5.08	•			•	
	ICV 2,5 HC/...-G Page 499	5.08	•			•	
	IC 2,5 HC/...-GF Page 499	5.08				•	
	ICV 2,5 HC/...-GF Page 499	5.08				•	
	GMSTB 2,5 HCV/...-ST Page 502	7.62				•	•
	GIC(V) 2,5 HC/...-G Page 506	7.62				•	•

		COMBICON power plug-in connectors with pin contact	
COMBICON power plug-in connectors with socket contact	Type		GMSTB(V)A 2,5 HC/...G-7,62-LR Page 505
	Pitch		7.62
	GMSTB 2,5 HCV/...-ST-LR Page 503	7.62	•

COMBICON power plug-in connectors with pin contact								
COMBICON power plug-in connectors with socket contact	Type		IPC 35 HC/...STF Page 588	IPC 35 HC/...STGF(-SH) Page 588	IPC 35 HC/...STF-SH Page 589	PC 35 HC/...GF Page 590	PCV 35 HC/...GF Page 591	PC 35 HC/...GF-SH Page 591
	Pitch		15.00	15.00	15.00	15.00	15.00	15.00
	PC 35 HC...STF Page 586	15.00		•		•	•	
	PC 35 HC ...STF-SH Page 587	15.00		•				•
	IPC 35 HC...GF Page 592	15.00	•			•	•	
	IPCV 35 HC...GF Page 593	15.00	•			•	•	
	DFK-IPC 35 HC/...GF Page 593	15.00	•		•			
	DFK-IPCV 35 HC...GF Page 593	15.00	•		•			























Plug-in connectors for power electronics with 5.0 to 15.0 mm pitch

COMBICON power cross-reference list

COMBICON power plug-in connectors with pin contact		COMBICON power plug-in connectors with socket contact							
		Type	Pitch	PC 4/...-G PCV 4/...G Page 516	DFK-PC 4/...-GF Page 518	DFK-PC/...-G...- FS-4,8 Page 519	PCVK 4-7,62-(PE) UPCV3K 4-G-7,62 Page 521	IPC 5/...-ST IPC 5/...-STF-(SH) Page 526	IPC 5/...-STGCL Page 527
	PC 4...ST Page 512	7.62	•		•	•			
	PC 4...STF Page 513	7.62	•	•		•			
	PCC 4 ...ST Page 514	7.62	•		•	•			
	PC 5/...ST1 Page 524	7.62	•		•	•	•		
	PC 5/...STF1 Page 525	7.62	•	•		•			
	PC 5/...STF-SH1 Page 525	7.62	•						
	PC 5/...STCL1 Page 525	7.62						•	
	SPC 5/...ST Page 530	7.62					•		
	SPC 5/...STF-(SH) Page 531	7.62							
	SPC 5/...STCL Page 531	7.62						•	
	TSPC 5/...ST Page 532	7.62					•		
	TSPC 5/...STF Page 533	7.62							
	TSPC 5/...STCL Page 533	7.62						•	
	IPC 5/...G(U) Page 540	7.62					•		
	IPC 5/...GF(U) Page 541	7.62					•		
	IPCV 5/...G Page 542	7.62					•		
	IPCV 5/...GF Page 543	7.62					•		

Plug-in connectors for power electronics with 5.0 to 15.0 mm pitch

COMBICON power cross-reference list

COMBICON power plug-in connectors with socket contact		COMBICON power plug-in connectors with pin contact							
		Type	Pitch	IPC 16/...ST Page 558	IPC 16/...STF-(SH) Page 559	IPC 16/...STGF-(SH) Page 560	ISPC 16/...-ST Page 564	ISPC 16/...-STF Page 565	ISPC 16/...-STGF Page 565
	PC 6...ST Page 550	10.16							
	PC 6...STF-(SH) Page 551	10.16							
	PCU 6 ...STD Page 552	10.16	•				•		
	PC 16/...ST Page 554	10.16	•				•		
	PC 16/...STF-(SH) Page 555	10.16				•			•
	TPC 16/...-ST Page 556	10.16	•				•		
	TPC 16/...STF Page 557	10.16				•			•
	SPC 16/..ST Page 562	10.16	•				•		
	SPC 16/...STF-(SH) Page 563	10.16				•			•
	IPC 16/..G(U) Page 570	10.16	•		•		•		
	IPC 16/..GF(U) Page 571	10.16			•			•	
	IPCV 16/..G Page 572	10.16	•		•		•		
	IPCV 16/..GF Page 573	10.16			•			•	
	DFK-IPC(V) 16/...G(U) Page 578	10.16	•				•		
	DFK-IPC(V) 16/...GF(U)-(SH) Page 581	10.16				•		•	
	DFK-IPC 16/...ST Page 584	10.16	•				•		
	DFK-IPC 16/...STF-(SH) Page 585	10.16			•			•	

¹⁾ Only with POWER COMBICON PCB-SHIELD

					
PC(V) 6-16/...G1 PC 6-16/...G1U Page 566 568	PC(V) 6-16/...G1F PC 6-16/...G1FU Page 567 569	DFK-PC(V) 6-16/...G(U) Page 574 577	DFK-PC(V) 6-16/...GF(U)-(SH) Page 575 577	DFK-PC 16/...ST Page 582	DFK-PC 16-STF-(SH) Page 583
10.16	10.16	10.16	10.16	10.16	10.16
•	•	•	•		
•					
•	•	•	•	•	•
•	•	•	•	•	•
•	•	•	•	•	•
•					
•					
•					

Plug-in connectors for power electronics with 5.0 to 15.0 mm pitch

HC series plug-in connectors up to 16 A/2.5 mm², pitch 5.0 or 5.08/7.62 mm

Plugs with screw and spring connection

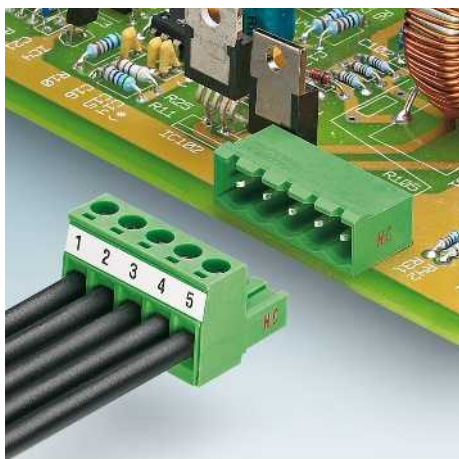

- The “High Current” (HC) versions with screw connection transmit a current of 16 A
- MSTB 2,5 HC plugs should be used only with HC headers
- The double steel spring ensures additional safety, especially in case of temperature and capacity fluctuations
- Coding profile CP-MSTB as protection against mismatching
- Available as a T-version (MSTBT 2,5 HC)

Notes:

In accordance with DIN EN 61984, COMBICON plug-in connectors have no switching power. During designated use, they must not be plugged in or disconnected when carrying voltage or under load.

COMBICON select

You will find the possible plug-in connector combinations in COMBICON select at: www.phoenixcontact.net/products or starting on page 484.

The designation “HC” is printed in red to provide clear identification of “High current” connectors.

Corresponding HC headers can be found starting from page 496.

1) Please observe the derating curves and laboratory data sheets. Derating curves of further combination options on request.



Without screw flange



Dimensional drawing

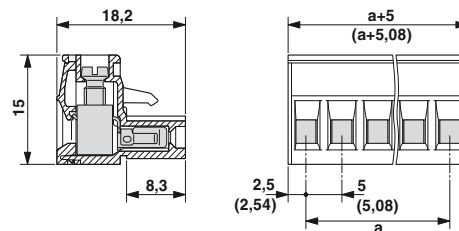

Note derating curves

Derating curves, determined as per DIN EN 61984 (VDE 0627):2002-09
Representation based on DIN EN 60512-5-2:2003-01
Connected conductor cross section = 2.5 mm²
Reduction factor = 0.8
Number of positions = see diagram

Accessories

For all types	Type	Page
	Coding profile CP-MSTB Order No. 1734634	38
	Screwdriver SZS 0,6 x 3,5 Order No. 1205053	
	Marker cards SK 5/3,8 or SK 5,08/3,8	798

Technical data

Technical data in accordance to IEC / DIN VDE	
Rated current / conductor cross section	[A] / [mm ²]
Rated insulation voltage for pollution degree 2	[V]
Pitch	[mm]
Connection capacity	
Solid / stranded	[mm ²] / [mm ²] / AWG
Stranded with ferrules without plastic sleeve	[mm ²]
Stranded with ferrules with plastic sleeve	[mm ²]
Multi-conductor connection capacity (two conductors with the same cross section)	
Solid / stranded	[mm ²]
Stranded with ferrules without plastic sleeve	[mm ²]
Stranded with TWIN ferrule with plastic sleeve	[mm ²]
Insulation coordination	
Surge voltage category / pollution degree	III / 3 III / 2 II / 2
Rated insulation voltage	[V]
Rated surge voltage	[kV]
Approval data (UL/CUL)	Use Group
Nominal voltage	[V]
Nominal current	[A]
Connection capacity AWG	AWG
Approval data (CSA)	Use Group
Nominal voltage	[V]
Nominal current	[A]
Connection capacity AWG	AWG
General data	
Stripping length	[mm]
Screw thread	
Tightening torque	[Nm]
Type of insulation material / insulation material group	
Inflammability class according to UL 94	

16 ¹⁾ / 2.5		
320		
5 / 5.08		
0.2 - 2.5 / 0.2 - 2.5 / 24 - 12		
0.25 - 2.5		
0.25 - 2.5		
0.2 - 1 / 0.2 - 1.5		
0.25 - 1		
0.5 - 1.5		
III / 3	III / 2	II / 2
250	320	630
4	4	4
B	C	D
300	-	300
16	-	15
30 - 12	-	30 - 12
B	C	D
-	-	-
-	-	-
-	-	-
7		
M3		
0.5 - 0.6		
PA / I		
V0		

No. of pos.	Dim. a [mm]
2	5.00
3	10.00
4	15.00
5	20.00
6	25.00
7	30.00
8	35.00
9	40.00
10	45.00
11	50.00
12	55.00

Ordering data

Type	Order No.	Pcs. / Pkt.
5.0 mm pitch, color: green		
MSTB 2,5 HC/ 2-ST	1911855	50
MSTB 2,5 HC/ 3-ST	1911868	50
MSTB 2,5 HC/ 4-ST	1911871	50
MSTB 2,5 HC/ 5-ST	1911884	50
MSTB 2,5 HC/ 6-ST	1911897	50
MSTB 2,5 HC/ 7-ST	1911907	50
MSTB 2,5 HC/ 8-ST	1911910	50
MSTB 2,5 HC/ 9-ST	1911923	50
MSTB 2,5 HC/10-ST	1911936	50
MSTB 2,5 HC/11-ST	1911949	50
MSTB 2,5 HC/12-ST	1911952	50
5.08 mm pitch, color: green		
MSTB 2,5 HC/ 2-ST-5,08	1911965	50
MSTB 2,5 HC/ 3-ST-5,08	1911978	50
MSTB 2,5 HC/ 4-ST-5,08	1911981	50
MSTB 2,5 HC/ 5-ST-5,08	1911994	50
MSTB 2,5 HC/ 6-ST-5,08	1912003	50
MSTB 2,5 HC/ 7-ST-5,08	1912016	50
MSTB 2,5 HC/ 8-ST-5,08	1912029	50
MSTB 2,5 HC/ 9-ST-5,08	1912032	50
MSTB 2,5 HC/10-ST-5,08	1912045	50
MSTB 2,5 HC/11-ST-5,08	1912058	50
MSTB 2,5 HC/12-ST-5,08	1912061	50



With screw flange



T contour, without screw flange



Dimensional drawing

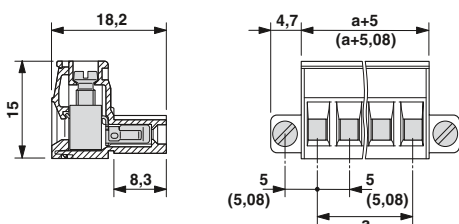

Dimensional drawing

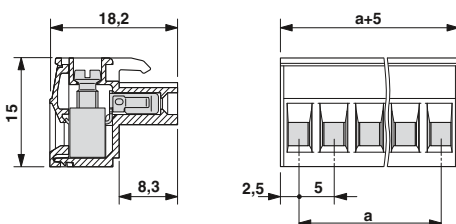

Representative derating curves of the above-mentioned plugs

Type: MSTB 2,5 HC/...-ST with MSTBA 2,5 HC/...G

Type: MSTBT 2,5 HC/...-ST with MSTBVA 2,5 HC/...G

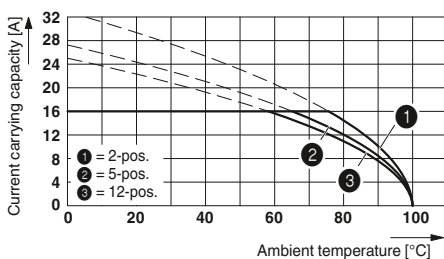
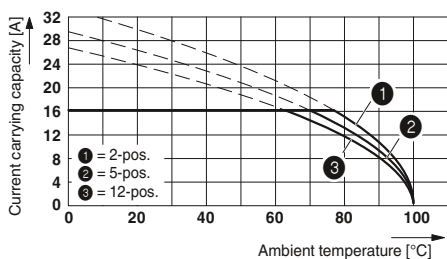

Ordering data

Type	Order No.	Pcs. / Pkt.
5.0 mm pitch, color: green		
MSTB 2,5 HC/ 2-STF	1912074	50
MSTB 2,5 HC/ 3-STF	1912087	50
MSTB 2,5 HC/ 4-STF	1912090	50
MSTB 2,5 HC/ 5-STF	1912100	50
MSTB 2,5 HC/ 6-STF	1912113	50
MSTB 2,5 HC/ 7-STF	1912126	50
MSTB 2,5 HC/ 8-STF	1912139	50
MSTB 2,5 HC/ 9-STF	1912142	50
MSTB 2,5 HC/10-STF	1912155	50
MSTB 2,5 HC/11-STF	1912168	50
MSTB 2,5 HC/12-STF	1912171	50
5.08 mm pitch, color: green		
MSTB 2,5 HC/ 2-STF-5,08	1912184	50
MSTB 2,5 HC/ 3-STF-5,08	1912197	50
MSTB 2,5 HC/ 4-STF-5,08	1912207	50
MSTB 2,5 HC/ 5-STF-5,08	1912210	50
MSTB 2,5 HC/ 6-STF-5,08	1912223	50
MSTB 2,5 HC/ 7-STF-5,08	1912236	50
MSTB 2,5 HC/ 8-STF-5,08	1912249	50
MSTB 2,5 HC/ 9-STF-5,08	1912252	50
MSTB 2,5 HC/10-STF-5,08	1912265	50
MSTB 2,5 HC/11-STF-5,08	1912278	50
MSTB 2,5 HC/12-STF-5,08	1912281	50

Ordering data

Type	Order No.	Pcs. / Pkt.
5.0 mm pitch, color: green		
MSTBT 2,5 HC/ 2-ST	1926358	50
MSTBT 2,5 HC/ 3-ST	1926248	50
MSTBT 2,5 HC/ 4-ST	1926251	50
MSTBT 2,5 HC/ 5-ST	1926264	50
MSTBT 2,5 HC/ 6-ST	1926277	50
MSTBT 2,5 HC/ 7-ST	1926280	50
MSTBT 2,5 HC/ 8-ST	1926293	50
MSTBT 2,5 HC/ 9-ST	1926303	50
MSTBT 2,5 HC/10-ST	1926316	50
MSTBT 2,5 HC/11-ST	1926329	50
MSTBT 2,5 HC/12-ST	1926332	50

Plug-in connectors for power electronics with 5.0 to 15.0 mm pitch

HC series plug-in connectors up to 16 A/2.5 mm², pitch 5.0 or 5.08/7.62 mm

Plugs with screw and spring connection

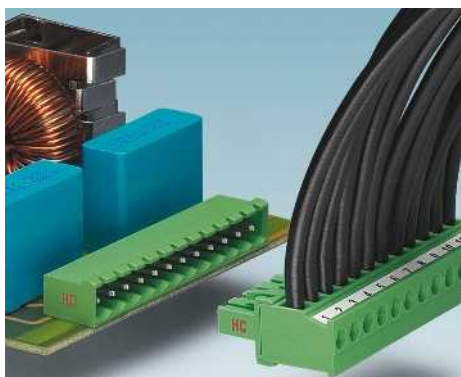

- 16 A plugs with vertical connection direction and screw connection
- MVSTBR 2,5 HC...ST, conductor entry on the coding side of the plug, therefore conductor exit to the top
- MVSTBW 2,5 HC...ST, conductor entry on the rippled side of the plug, therefore conductor exit to the bottom
- HC plugs should be used only with HC headers
- Versions with a screw flange (-STF) for a vibration-resistant connection

Notes:

In accordance with DIN EN 61984, COMBICON plug-in connectors have no switching power. During designated use, they must not be plugged in or disconnected when carrying voltage or under load.

COMBICON select

You will find the possible plug-in connector combinations in COMBICON select at: www.phoenixcontact.net/products or starting on page 484.

The designation "HC" is printed in red to provide clear identification of "High current" connectors.

Corresponding HC headers can be found starting from page 496.

1) Please observe the derating curves and laboratory data sheets. Derating curves of further combination options on request.



Connection point facing the smooth wall of the header (R)



Dimensional drawing

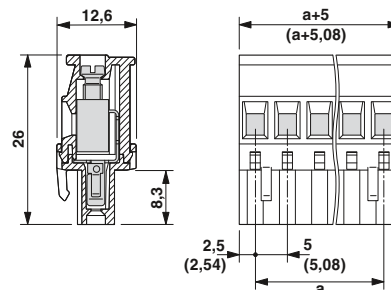

Note derating curves

Derating curves, determined as per DIN EN 61984 (VDE 0627):2002-09
Representation based on DIN EN 60512-5-2:2003-01
Connected conductor cross section = 2.5 mm²
Reduction factor = 0.8
Number of positions = see diagram

Accessories

For all types	Type	Page
	Coding profile CP-MSTB Order No. 1734634	38
	Screwdriver SZS 0,6 x 3,5 Order No. 1205053	
	Marker cards SK 5/3,8 or SK 5,08/3,8	798

Technical data

Technical data in accordance to IEC / DIN VDE	
Rated current / conductor cross section	[A] / [mm ²]
Rated insulation voltage for pollution degree 2	[V]
Pitch	[mm]
Connection capacity	
Solid / stranded	[mm ²] / [mm ²] / AWG
Stranded with ferrules without plastic sleeve	[mm ²]
Stranded with ferrules with plastic sleeve	[mm ²]
Multi-conductor connection capacity (two conductors with the same cross section)	
Solid / stranded	[mm ²]
Stranded with ferrules without plastic sleeve	[mm ²]
Stranded with TWIN ferrule with plastic sleeve	[mm ²]
Insulation coordination	
Surge voltage category / pollution degree	III / 3 III / 2 II / 2
Rated insulation voltage	[V]
Rated surge voltage	[kV]
Approval data (UL/CUL)	Use Group
Nominal voltage	[V]
Nominal current	[A]
Connection capacity AWG	AWG
Approval data (CSA)	Use Group
Nominal voltage	[V]
Nominal current	[A]
Connection capacity AWG	AWG
General data	
Stripping length	[mm]
Screw thread	M3
Tightening torque	[Nm]
Type of insulation material / insulation material group	PA / I
Inflammability class according to UL 94	V0

Rated current / conductor cross section	16 ¹⁾ / 2.5
Rated insulation voltage for pollution degree 2	320
Pitch	5 / 5.08
Connection capacity	
Solid / stranded	0.2 - 2.5 / 0.2 - 2.5 / 24 - 12
Stranded with ferrules without plastic sleeve	0.25 - 2.5
Stranded with ferrules with plastic sleeve	0.25 - 2.5
Multi-conductor connection capacity (two conductors with the same cross section)	
Solid / stranded	0.2 - 1 / 0.2 - 1.5
Stranded with ferrules without plastic sleeve	0.25 - 1
Stranded with TWIN ferrule with plastic sleeve	0.5 - 1.5
Insulation coordination	
Surge voltage category / pollution degree	III / 3 III / 2 II / 2
Rated insulation voltage	250 320 630
Rated surge voltage	4 4 4
Approval data (UL/CUL)	B C D
Nominal voltage	300 - 300
Nominal current	16 - 15
Connection capacity AWG	30 - 12 - 30 - 12
Approval data (CSA)	B C D
Nominal voltage	- - -
Nominal current	- - -
Connection capacity AWG	- - -
General data	
Stripping length	7
Screw thread	M3
Tightening torque	0.5 - 0.6
Type of insulation material / insulation material group	PA / I
Inflammability class according to UL 94	V0

No. of pos.	Dim. a [mm]
2	5.00
3	10.00
4	15.00
5	20.00
6	25.00
7	30.00
8	35.00
9	40.00
10	45.00
11	50.00
12	55.00

Ordering data

Type	Order No.	Pcs. / Pkt.
5.0 mm pitch, color: green		
MVSTBR 2,5 HC/ 2-ST	1912294	50
MVSTBR 2,5 HC/ 3-ST	1912304	50
MVSTBR 2,5 HC/ 4-ST	1912317	50
MVSTBR 2,5 HC/ 5-ST	1912320	50
MVSTBR 2,5 HC/ 6-ST	1912333	50
MVSTBR 2,5 HC/ 7-ST	1912346	50
MVSTBR 2,5 HC/ 8-ST	1912359	50
MVSTBR 2,5 HC/ 9-ST	1912362	50
MVSTBR 2,5 HC/10-ST	1912375	50
MVSTBR 2,5 HC/11-ST	1912388	50
MVSTBR 2,5 HC/12-ST	1912391	50
5.08 mm pitch, color: green		
MVSTBR 2,5 HC/ 2-ST-5,08	1912401	50
MVSTBR 2,5 HC/ 3-ST-5,08	1912414	50
MVSTBR 2,5 HC/ 4-ST-5,08	1912427	50
MVSTBR 2,5 HC/ 5-ST-5,08	1912430	50
MVSTBR 2,5 HC/ 6-ST-5,08	1912443	50
MVSTBR 2,5 HC/ 7-ST-5,08	1912456	50
MVSTBR 2,5 HC/ 8-ST-5,08	1912469	50
MVSTBR 2,5 HC/ 9-ST-5,08	1912472	50
MVSTBR 2,5 HC/10-ST-5,08	1912485	50
MVSTBR 2,5 HC/11-ST-5,08	1912498	50
MVSTBR 2,5 HC/12-ST-5,08	1912508	50

Plug-in connectors for power electronics with 5.0 to 15.0 mm pitch

HC series plug-in connectors up to 16 A/2.5 mm², pitch 5.0 or 5.08/7.62 mm



With screw flange, connection point facing the smooth panel of the header (R)



Connection point facing the rippled wall of the header (W)



With screw flange, connection point facing the rippled wall (W) of the header



Dimensional drawing

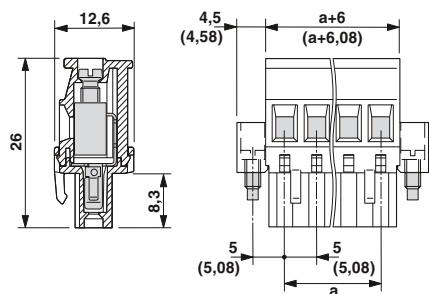

Dimensional drawing

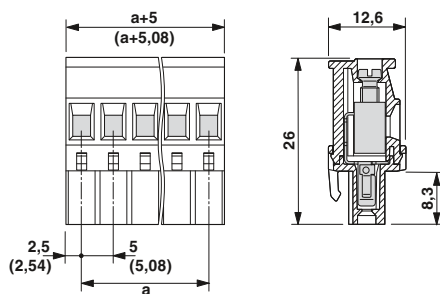

Dimensional drawing

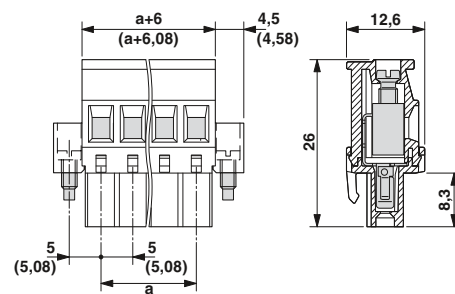

Representative derating curve

Type: MVSTBR 2,5 HC/...-ST with MSTBVA 2,5 HC/...-G

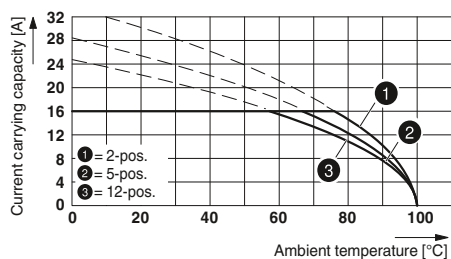

Ordering data

Type	Order No.	Pcs. / Pkt.
5.0 mm pitch, color: green		
MVSTBR 2,5 HC/ 2-STF	1912511	50
MVSTBR 2,5 HC/ 3-STF	1912524	50
MVSTBR 2,5 HC/ 4-STF	1912537	50
MVSTBR 2,5 HC/ 5-STF	1912540	50
MVSTBR 2,5 HC/ 6-STF	1912553	50
MVSTBR 2,5 HC/ 7-STF	1912566	50
MVSTBR 2,5 HC/ 8-STF	1912579	50
MVSTBR 2,5 HC/ 9-STF	1912582	50
MVSTBR 2,5 HC/10-STF	1912595	50
MVSTBR 2,5 HC/11-STF	1912605	50
MVSTBR 2,5 HC/12-STF	1912618	50
5.08 mm pitch, color: green		
MVSTBR 2,5 HC/ 2-STF-5,08	1912621	50
MVSTBR 2,5 HC/ 3-STF-5,08	1912634	50
MVSTBR 2,5 HC/ 4-STF-5,08	1912647	50
MVSTBR 2,5 HC/ 5-STF-5,08	1912650	50
MVSTBR 2,5 HC/ 6-STF-5,08	1912663	50
MVSTBR 2,5 HC/ 7-STF-5,08	1912676	50
MVSTBR 2,5 HC/ 8-STF-5,08	1912689	50
MVSTBR 2,5 HC/ 9-STF-5,08	1912692	50
MVSTBR 2,5 HC/10-STF-5,08	1912702	50
MVSTBR 2,5 HC/11-STF-5,08	1912715	50
MVSTBR 2,5 HC/12-STF-5,08	1912728	50

Ordering data

Type	Order No.	Pcs. / Pkt.
5.0 mm pitch, color: green		
MVSTBW 2,5 HC/ 2-ST	1912731	50
MVSTBW 2,5 HC/ 3-ST	1912744	50
MVSTBW 2,5 HC/ 4-ST	1912757	50
MVSTBW 2,5 HC/ 5-ST	1912760	50
MVSTBW 2,5 HC/ 6-ST	1912773	50
MVSTBW 2,5 HC/ 7-ST	1912786	50
MVSTBW 2,5 HC/ 8-ST	1912799	50
MVSTBW 2,5 HC/ 9-ST	1912809	50
MVSTBW 2,5 HC/10-ST	1912812	50
MVSTBW 2,5 HC/11-ST	1912825	50
MVSTBW 2,5 HC/12-ST	1912838	50
5.08 mm pitch, color: green		
MVSTBW 2,5 HC/ 2-ST-5,08	1912841	50
MVSTBW 2,5 HC/ 3-ST-5,08	1912854	50
MVSTBW 2,5 HC/ 4-ST-5,08	1912867	50
MVSTBW 2,5 HC/ 5-ST-5,08	1912870	50
MVSTBW 2,5 HC/ 6-ST-5,08	1912883	50
MVSTBW 2,5 HC/ 7-ST-5,08	1912896	50
MVSTBW 2,5 HC/ 8-ST-5,08	1912906	50
MVSTBW 2,5 HC/ 9-ST-5,08	1912919	50
MVSTBW 2,5 HC/10-ST-5,08	1912922	50
MVSTBW 2,5 HC/11-ST-5,08	1912935	50
MVSTBW 2,5 HC/12-ST-5,08	1912948	50

Ordering data

Type	Order No.	Pcs. / Pkt.
5.0 mm pitch, color: green		
MVSTBW 2,5 HC/ 2-STF	1912951	50
MVSTBW 2,5 HC/ 3-STF	1912964	50
MVSTBW 2,5 HC/ 4-STF	1912977	50
MVSTBW 2,5 HC/ 5-STF	1912980	50
MVSTBW 2,5 HC/ 6-STF	1912993	50
MVSTBW 2,5 HC/ 7-STF	1913002	50
MVSTBW 2,5 HC/ 8-STF	1913015	50
MVSTBW 2,5 HC/ 9-STF	1913028	50
MVSTBW 2,5 HC/10-STF	1913031	50
MVSTBW 2,5 HC/11-STF	1913044	50
MVSTBW 2,5 HC/12-STF	1913057	50
5.08 mm pitch, color: green		
MVSTBW 2,5 HC/ 2-STF-5,08	1913060	50
MVSTBW 2,5 HC/ 3-STF-5,08	1913073	50
MVSTBW 2,5 HC/ 4-STF-5,08	1913086	50
MVSTBW 2,5 HC/ 5-STF-5,08	1913099	50
MVSTBW 2,5 HC/ 6-STF-5,08	1913109	50
MVSTBW 2,5 HC/ 7-STF-5,08	1913112	50
MVSTBW 2,5 HC/ 8-STF-5,08	1913125	50
MVSTBW 2,5 HC/ 9-STF-5,08	1913138	50
MVSTBW 2,5 HC/10-STF-5,08	1913141	50
MVSTBW 2,5 HC/11-STF-5,08	1913154	50
MVSTBW 2,5 HC/12-STF-5,08	1913167	50

Plug-in connectors for power electronics with 5.0 to 15.0 mm pitch

HC series plug-in connectors up to 16 A/2.5 mm², pitch 5.0 or 5.08/7.62 mm

Plugs with screw and spring connection

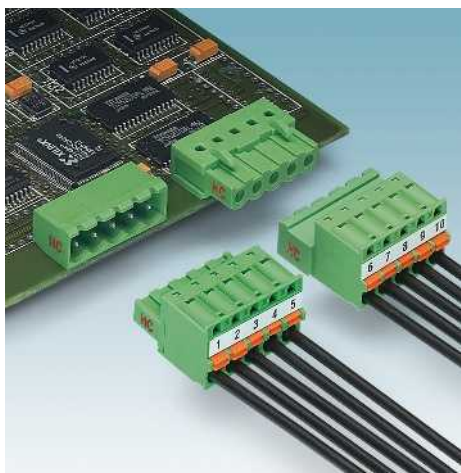

- Plug-in connectors with push-in spring connection as “High Current” (HC) version for 16 A
- Inverted versions with a pin contact (FKIC 2,5 HC); e.g. for cable-cable connections or motor outputs
- HC plugs should be used only with HC headers
- Two integrated test connections
- Coding profiles (CP) as protection against mismatching
- Versions with screw flange (STF)

Notes:

In accordance with DIN EN 61984, COMBICON plug-in connectors have no switching power. During designated use, they must not be plugged in or disconnected when carrying voltage or under load.

COMBICON select

You will find the possible plug-in connector combinations in COMBICON select at: www.phoenixcontact.net/products or starting on page 484.

The designation “HC” is printed in red to provide clear identification of “High current” connectors.

Corresponding HC headers can be found starting from page 496.

Corresponding inverted HC headers can be found starting from page 498.

¹⁾ Please observe the derating curves and laboratory data sheets. Derating curves of further combination options on request.



Without screw flange, with socket contact



Dimensional drawing

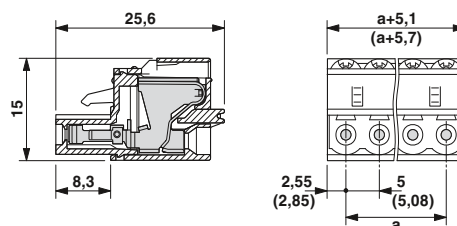

Note derating curves

Derating curves, determined as per DIN EN 61984 (VDE 0627):2002-09
Representation based on DIN EN 60512-5-2:2003-01
Connected conductor cross section = 2.5 mm²
Reduction factor = 0.8
Number of positions = see diagram

Accessories

For all types	Type	Page
	Strain relief STZ ...FKC-5,08	837
	Test plug MPS	831
	Screwdriver SZS 0,6 x 3,5 Order No. 1205053	
	Crimping pliers for 0.25 to 6 mm ² CRIMPFOX 6 Order No. 1212034	
Only for FKC 2,5 HC/...-ST(F)		
	Coding profile CP-MSTB Order No. 1734634	38
Only for FKIC 2,5 HC/...-ST(F)		
	Coding section CR-MSTB Order No. 1734401	38

Technical data

Technical data in accordance to IEC / DIN VDE			
Rated current / conductor cross section	[A] / [mm ²]	16 ¹⁾ / 2.5	
Rated insulation voltage for pollution degree 2	[V]	320	
Pitch	[mm]	5 / 5.08	
Connection capacity			
Solid / stranded	[mm ²] / [mm ²] / AWG	0.2 - 2.5 / 0.2 - 2.5 / 24 - 12	
Stranded with ferrules without plastic sleeve	[mm ²]	0.25 - 2.5	
Stranded with ferrules with plastic sleeve	[mm ²]	0.25 - 1.5	
Multi-conductor connection capacity (two conductors with the same cross section)			
Solid / stranded	[mm ²]	- / -	
Stranded with ferrules without plastic sleeve	[mm ²]	-	
Stranded with TWIN ferrule with plastic sleeve	[mm ²]	0.5 - 1.5	
Insulation coordination			
Surge voltage category / pollution degree		III / 3	III / 2
Rated insulation voltage	[V]	250	320
Rated surge voltage	[kV]	4	4
Approval data (UL/CUL)	Use Group	B	C D
Nominal voltage	[V]	300	- 300
Nominal current	[A]	16	- 15
Connection capacity AWG	AWG	26 - 12	- 26 - 12
Approval data (CSA)	Use Group	B	C D
Nominal voltage	[V]	-	- -
Nominal current	[A]	-	- -
Connection capacity AWG	AWG	-	- -
General data			
Stripping length	[mm]	10	
Type of insulation material / insulation material group		PA / I	
Inflammability class according to UL 94		V0	

Ordering data

No. of pos.	Dim. a [mm]	Type	Order No.	Pcs. / Pkt.
5.0 mm pitch, color: green				
2	5.00	FKC 2,5 HC/ 2-ST	1942154	50
3	10.00	FKC 2,5 HC/ 3-ST	1942167	50
4	15.00	FKC 2,5 HC/ 4-ST	1942170	50
5	20.00	FKC 2,5 HC/ 5-ST	1942183	50
6	25.00	FKC 2,5 HC/ 6-ST	1942196	50
7	30.00	FKC 2,5 HC/ 7-ST	1942206	50
8	35.00	FKC 2,5 HC/ 8-ST	1942219	50
9	40.00	FKC 2,5 HC/ 9-ST	1942222	50
10	45.00	FKC 2,5 HC/10-ST	1942235	50
11	50.00	FKC 2,5 HC/11-ST	1942248	50
12	55.00	FKC 2,5 HC/12-ST	1942251	50
5.08 mm pitch, color: green				
2	5.08	FKC 2,5 HC/ 2-ST-5,08	1942374	50
3	10.16	FKC 2,5 HC/ 3-ST-5,08	1942387	50
4	15.24	FKC 2,5 HC/ 4-ST-5,08	1942390	50
5	20.32	FKC 2,5 HC/ 5-ST-5,08	1942400	50
6	25.40	FKC 2,5 HC/ 6-ST-5,08	1942413	50
7	30.48	FKC 2,5 HC/ 7-ST-5,08	1942426	50
8	35.56	FKC 2,5 HC/ 8-ST-5,08	1942439	50
9	40.64	FKC 2,5 HC/ 9-ST-5,08	1942442	50
10	45.72	FKC 2,5 HC/10-ST-5,08	1942455	50
11	50.80	FKC 2,5 HC/11-ST-5,08	1942468	50
12	55.88	FKC 2,5 HC/12-ST-5,08	1942471	50

Plug-in connectors for power electronics with 5.0 to 15.0 mm pitch

HC series plug-in connectors up to 16 A/2.5 mm², pitch 5.0 or 5.08/7.62 mm



With screw flange and socket Contact



Inverted with pin contact



Inverted with pin contact, with screw flange



Dimensional drawing

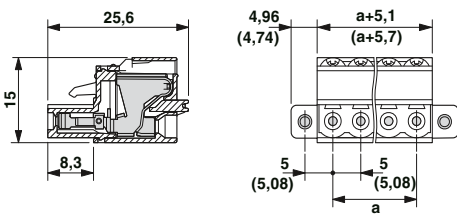

Dimensional drawing

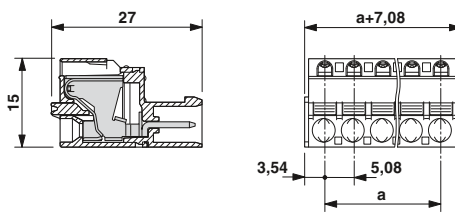

Dimensional drawing

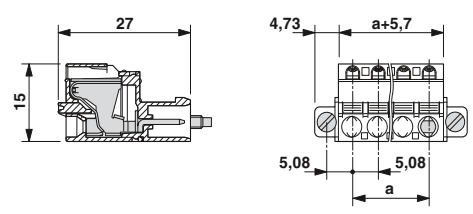

Representative derating curves of the above-mentioned plugs

Type: FKC 2,5 HC/...-ST with MSTBA 2,5 HC/...-G

Type: FKIC 2,5 HC/...-ST- 5,08 with IC 2,5 HC/...-G- 5,08

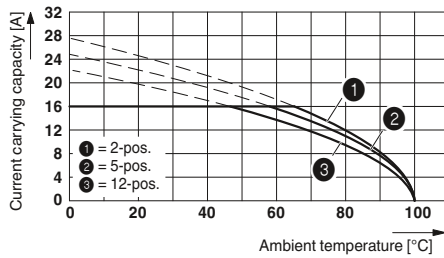
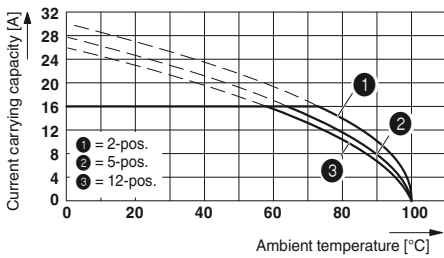

Ordering data

Type	Order No.	Pcs. / Pkt.
5.0 mm pitch, color: green		
FKC 2,5 HC/ 2-STF	1942264	50
FKC 2,5 HC/ 3-STF	1942277	50
FKC 2,5 HC/ 4-STF	1942280	50
FKC 2,5 HC/ 5-STF	1942293	50
FKC 2,5 HC/ 6-STF	1942303	50
FKC 2,5 HC/ 7-STF	1942316	50
FKC 2,5 HC/ 8-STF	1942329	50
FKC 2,5 HC/ 9-STF	1942332	50
FKC 2,5 HC/10-STF	1942345	50
FKC 2,5 HC/11-STF	1942358	50
FKC 2,5 HC/12-STF	1942361	50
5.08 mm pitch, color: green		
FKC 2,5 HC/ 2-STF-5,08	1942484	50
FKC 2,5 HC/ 3-STF-5,08	1942497	50
FKC 2,5 HC/ 4-STF-5,08	1942507	50
FKC 2,5 HC/ 5-STF-5,08	1942510	50
FKC 2,5 HC/ 6-STF-5,08	1942523	50
FKC 2,5 HC/ 7-STF-5,08	1942536	50
FKC 2,5 HC/ 8-STF-5,08	1942549	50
FKC 2,5 HC/ 9-STF-5,08	1942552	50
FKC 2,5 HC/10-STF-5,08	1942565	50
FKC 2,5 HC/11-STF-5,08	1942578	50
FKC 2,5 HC/12-STF-5,08	1942581	50

Ordering data

Type	Order No.	Pcs. / Pkt.
5.08 mm pitch, color: green		
FKIC 2,5 HC/ 2-ST-5,08	1942594	50
FKIC 2,5 HC/ 3-ST-5,08	1942604	50
FKIC 2,5 HC/ 4-ST-5,08	1942617	50
FKIC 2,5 HC/ 5-ST-5,08	1942620	50
FKIC 2,5 HC/ 6-ST-5,08	1942633	50
FKIC 2,5 HC/ 7-ST-5,08	1942646	50
FKIC 2,5 HC/ 8-ST-5,08	1942659	50
FKIC 2,5 HC/ 9-ST-5,08	1942662	50
FKIC 2,5 HC/10-ST-5,08	1942675	50
FKIC 2,5 HC/11-ST-5,08	1942688	50
FKIC 2,5 HC/12-ST-5,08	1942691	50

Ordering data

Type	Order No.	Pcs. / Pkt.
5.08 mm pitch, color: green		
FKIC 2,5 HC/ 2-STF-5,08	1942701	50
FKIC 2,5 HC/ 3-STF-5,08	1942714	50
FKIC 2,5 HC/ 4-STF-5,08	1942727	50
FKIC 2,5 HC/ 5-STF-5,08	1942730	50
FKIC 2,5 HC/ 6-STF-5,08	1942743	50
FKIC 2,5 HC/ 7-STF-5,08	1942756	50
FKIC 2,5 HC/ 8-STF-5,08	1942769	50
FKIC 2,5 HC/ 9-STF-5,08	1942772	50
FKIC 2,5 HC/10-STF-5,08	1942785	50
FKIC 2,5 HC/11-STF-5,08	1942798	50
FKIC 2,5 HC/12-STF-5,08	1942808	50

Plug-in connectors for power electronics with 5.0 to 15.0 mm pitch

HC series plug-in connectors up to 16 A/2.5 mm², pitch 5.0 or 5.08/7.62 mm

Headers with pin contact

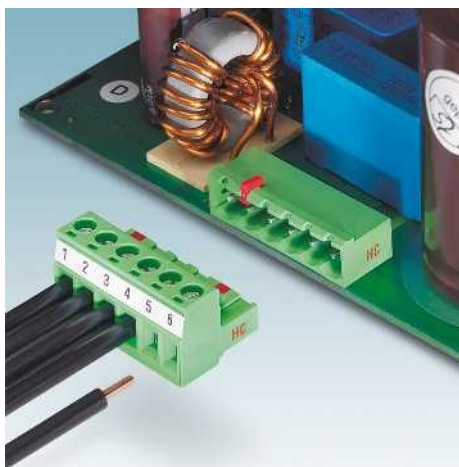

- 16-A (HC) header in horizontal and vertical (MSTBV) design
- Lateral HC print ("High Current")
- HC header should be used only with HC plugs
- Vibration-resistant connection with a threaded flange (-GF)
- Coding sections (CR) as protection against mismatching
- No possibility of lateral mismatching due to side panels

Notes:

In accordance with DIN EN 61984, COMBICON plug-in connectors have no switching power. During designated use, they must not be plugged in or disconnected when carrying voltage or under load.

COMBICON select

You will find the possible plug-in connector combinations in COMBICON select at: www.phoenixcontact.net/products or starting on page 484.

The designation "HC" is printed in red to provide clear identification of "High current" connectors.

Corresponding HC plug components can be found starting from page 490.

Mounting screws for base element with threaded flange (...GF...): sheet metal screw ISO 1481-ST 2,2x6,5 C or ISO 7049-ST 2,2x6,5 C. Screw connection only permitted prior to soldering.

1) Please observe the derating curves and laboratory data sheets. Derating curves of further combination options on request.



Horizontal



Dimensional drawing

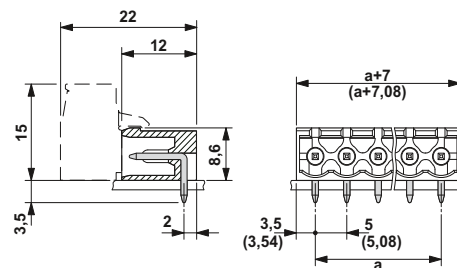

Drilling diagram

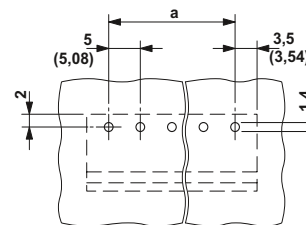

Accessories		
For all types	Type	Page
	Coding section CR-MSTB Order No. 1734401	38
	Coding tab MSTB-BL Order No. 1755477	837
	Marker cards SK 5/3,8 or SK 5,08/3,8	798

Technical data

Technical data in accordance to IEC / DIN VDE	
Rated current	[A]
Rated insulation voltage for pollution degree 2	[V]
Pitch	[mm]
Insulation coordination	
Surge voltage category / pollution degree	
Rated insulation voltage	[V]
Rated surge voltage	[kV]
Approval data (UL/CUL)	Use Group
Nominal voltage	[V]
Nominal current	[A]
Connection capacity AWG	AWG
Approval data (CSA)	Use Group
Nominal voltage	[V]
Nominal current	[A]
Connection capacity AWG	AWG
General data	
Type of insulation material / insulation material group	
Inflammability class according to UL 94	
Drill hole diameter / pin dimensions	[mm]

	16 ¹⁾
	320
	5 / 5.08
	III / 3 III / 2 II / 2
	250 320 400
	4 4 4
	B C D
	300 - 300
	16 - 15
	- - -
	B C D
	- - -
	- - -
	PA / I
	V0
	1.4 / 1 x 1 mm

No. of pos.	Dim. a [mm]
2	5.00
3	10.00
4	15.00
5	20.00
6	25.00
7	30.00
8	35.00
9	40.00
10	45.00
11	50.00
12	55.00

Ordering data

Type	Order No.	Pcs. / Pkt.
5.0 mm pitch, color: green		
MSTBA 2,5 HC/ 2-G	1923759	50
MSTBA 2,5 HC/ 3-G	1923762	50
MSTBA 2,5 HC/ 4-G	1923775	50
MSTBA 2,5 HC/ 5-G	1923788	50
MSTBA 2,5 HC/ 6-G	1923791	50
MSTBA 2,5 HC/ 7-G	1923801	50
MSTBA 2,5 HC/ 8-G	1923814	50
MSTBA 2,5 HC/ 9-G	1923827	50
MSTBA 2,5 HC/10-G	1923830	50
MSTBA 2,5 HC/11-G	1923843	50
MSTBA 2,5 HC/12-G	1923856	50
5.08 mm pitch, color: green		
MSTBA 2,5 HC/ 2-G-5,08	1923869	50
MSTBA 2,5 HC/ 3-G-5,08	1923872	50
MSTBA 2,5 HC/ 4-G-5,08	1923885	50
MSTBA 2,5 HC/ 5-G-5,08	1923898	50
MSTBA 2,5 HC/ 6-G-5,08	1923908	50
MSTBA 2,5 HC/ 7-G-5,08	1923911	50
MSTBA 2,5 HC/ 8-G-5,08	1923924	50
MSTBA 2,5 HC/ 9-G-5,08	1923937	50
MSTBA 2,5 HC/10-G-5,08	1923940	50
MSTBA 2,5 HC/11-G-5,08	1923953	50
MSTBA 2,5 HC/12-G-5,08	1923966	50

Plug-in connectors for power electronics with 5.0 to 15.0 mm pitch

HC series plug-in connectors up to 16 A/2.5 mm², pitch 5.0 or 5.08/7.62 mm



Horizontal, with threaded flange

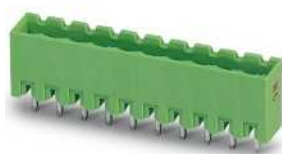

Vertical

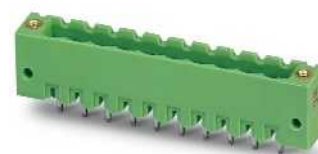

Vertical, with threaded flange



Dimensional drawing

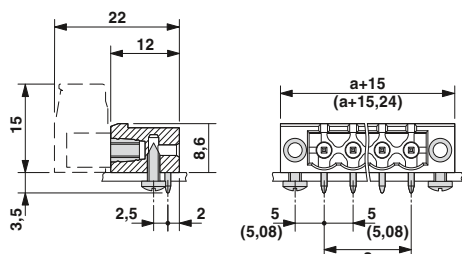

Drilling diagram

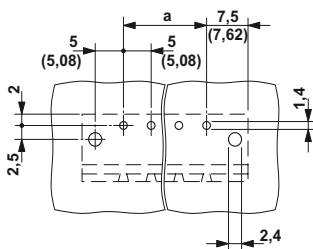

Ordering data

Type	Order No.	Pcs. / Pkt.
5.0 mm pitch, color: green		
MSTB 2,5 HC/ 2-GF	1923979	50
MSTB 2,5 HC/ 3-GF	1923982	50
MSTB 2,5 HC/ 4-GF	1923995	50
MSTB 2,5 HC/ 5-GF	1924004	50
MSTB 2,5 HC/ 6-GF	1924017	50
MSTB 2,5 HC/ 7-GF	1924020	50
MSTB 2,5 HC/ 8-GF	1924033	50
MSTB 2,5 HC/ 9-GF	1924046	50
MSTB 2,5 HC/10-GF	1924059	50
MSTB 2,5 HC/11-GF	1924062	50
MSTB 2,5 HC/12-GF	1924075	50
5.08 mm pitch, color: green		
MSTB 2,5 HC/ 2-GF-5,08	1924088	50
MSTB 2,5 HC/ 3-GF-5,08	1924091	50
MSTB 2,5 HC/ 4-GF-5,08	1924101	50
MSTB 2,5 HC/ 5-GF-5,08	1924114	50
MSTB 2,5 HC/ 6-GF-5,08	1924127	50
MSTB 2,5 HC/ 7-GF-5,08	1924130	50
MSTB 2,5 HC/ 8-GF-5,08	1924143	50
MSTB 2,5 HC/ 9-GF-5,08	1924156	50
MSTB 2,5 HC/10-GF-5,08	1924169	50
MSTB 2,5 HC/11-GF-5,08	1924172	50
MSTB 2,5 HC/12-GF-5,08	1924185	50



Dimensional drawing

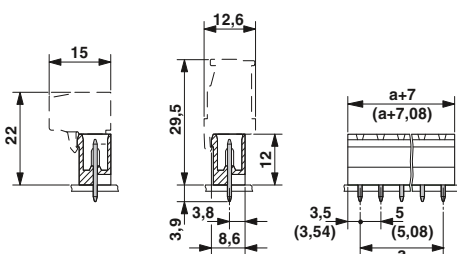

Drilling diagram

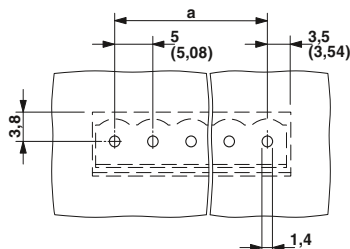

Ordering data

Type	Order No.	Pcs. / Pkt.
5.0 mm pitch, color: green		
MSTBVA 2,5 HC/ 2-G	1924198	50
MSTBVA 2,5 HC/ 3-G	1924208	50
MSTBVA 2,5 HC/ 4-G	1924211	50
MSTBVA 2,5 HC/ 5-G	1924224	50
MSTBVA 2,5 HC/ 6-G	1924237	50
MSTBVA 2,5 HC/ 7-G	1924240	50
MSTBVA 2,5 HC/ 8-G	1924253	50
MSTBVA 2,5 HC/ 9-G	1924266	50
MSTBVA 2,5 HC/10-G	1924279	50
MSTBVA 2,5 HC/11-G	1924282	50
MSTBVA 2,5 HC/12-G	1924295	50
5.08 mm pitch, color: green		
MSTBVA 2,5 HC/ 2-G-5,08	1924305	50
MSTBVA 2,5 HC/ 3-G-5,08	1924318	50
MSTBVA 2,5 HC/ 4-G-5,08	1924321	50
MSTBVA 2,5 HC/ 5-G-5,08	1924334	50
MSTBVA 2,5 HC/ 6-G-5,08	1924347	50
MSTBVA 2,5 HC/ 7-G-5,08	1924350	50
MSTBVA 2,5 HC/ 8-G-5,08	1924363	50
MSTBVA 2,5 HC/ 9-G-5,08	1924376	50
MSTBVA 2,5 HC/10-G-5,08	1924389	50
MSTBVA 2,5 HC/11-G-5,08	1924392	50
MSTBVA 2,5 HC/12-G-5,08	1924402	50



Dimensional drawing

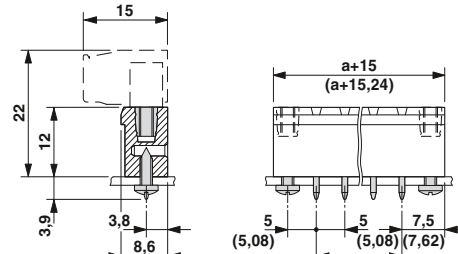

Drilling diagram

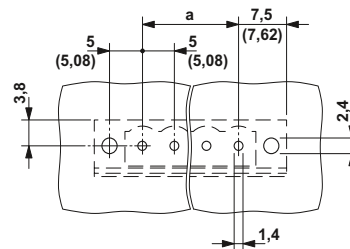

Ordering data

Type	Order No.	Pcs. / Pkt.
5.0 mm pitch, color: green		
MSTBV 2,5 HC/ 2-GF	1924415	50
MSTBV 2,5 HC/ 3-GF	1924428	50
MSTBV 2,5 HC/ 4-GF	1924431	50
MSTBV 2,5 HC/ 5-GF	1924444	50
MSTBV 2,5 HC/ 6-GF	1924457	50
MSTBV 2,5 HC/ 7-GF	1924460	50
MSTBV 2,5 HC/ 8-GF	1924473	50
MSTBV 2,5 HC/ 9-GF	1924486	50
MSTBV 2,5 HC/10-GF	1924499	50
MSTBV 2,5 HC/11-GF	1924509	50
MSTBV 2,5 HC/12-GF	1924512	50
5.08 mm pitch, color: green		
MSTBV 2,5 HC/ 2-GF-5,08	1924525	50
MSTBV 2,5 HC/ 3-GF-5,08	1924538	50
MSTBV 2,5 HC/ 4-GF-5,08	1924541	50
MSTBV 2,5 HC/ 5-GF-5,08	1924554	50
MSTBV 2,5 HC/ 6-GF-5,08	1924567	50
MSTBV 2,5 HC/ 7-GF-5,08	1924570	50
MSTBV 2,5 HC/ 8-GF-5,08	1924583	50
MSTBV 2,5 HC/ 9-GF-5,08	1924596	50
MSTBV 2,5 HC/10-GF-5,08	1924606	50
MSTBV 2,5 HC/11-GF-5,08	1924619	50
MSTBV 2,5 HC/12-GF-5,08	1924622	50

Plug-in connectors for power electronics with 5.0 to 15.0 mm pitch

HC series plug-in connectors up to 16 A/2.5 mm², pitch 5.0 or 5.08/7.62 mm

Headers with socket contact



- Inverted 16-A (HC) header with a socket contact for shock-proof applications or PCB-PCB connections
- Horizontal and vertical (ICV) designs
- Double steel spring as extra safety against contact corrosion
- Vibration-resistant connection with a threaded flange (-GF)
- HC header should be used only with HC connectors

Notes:
In accordance with DIN EN 61984, COMBICON plug-in connectors have no switching power. During designated use, they must not be plugged in or disconnected when carrying voltage or under load.
The designation "HC" is printed in red to provide clear identification of "High current" connectors.
Corresponding inverted HC plug components can be found starting from page 495.
Mounting screws for base element with threaded flange (...GF...): sheet metal screw ISO 1481-ST 2,2x6,5 C or ISO 7049-ST 2,2x6,5 C. Screw connection only permitted prior to soldering.
COMBICON select You will find the possible plug-in connector combinations in COMBICON select at: www.phoenixcontact.net/products or starting on page 484.
1) Please observe the derating curves and laboratory data sheets. Derating curves of further combination options on request.



Horizontal



Dimensional drawing

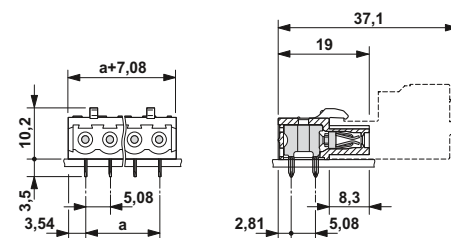

Drilling diagram

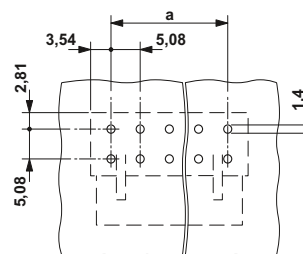

Technical data

Technical data in accordance to IEC / DIN VDE	
Rated current	[A]
Rated insulation voltage for pollution degree 2	[V]
Pitch	[mm]
Insulation coordination	
Surge voltage category / pollution degree	III / 3 III / 2 II / 2
Rated insulation voltage	[V]
Rated surge voltage	[kV]
Approval data (UL/CUL)	Use Group
Nominal voltage	[V]
Nominal current	[A]
Connection capacity AWG	AWG
Approval data (CSA)	Use Group
Nominal voltage	[V]
Nominal current	[A]
Connection capacity AWG	AWG
General data	
Type of insulation material / insulation material group	PA / I
Inflammability class according to UL 94	V0
Drill hole diameter / pin dimensions	[mm]

Accessories

For all types	Type	Page
	Coding profile CP-MSTB Order No. 1734634	38
	Test plug MPS	831
	Reducing plug RPS Order No. 0201647	831

Ordering data

No. of pos.	Dim. a [mm]	Type	Order No.	Pcs. / Pkt.
5.08 mm pitch, color: green				
2	5.08	IC 2,5 HC/ 2-G-5,08	1943302	50
3	10.16	IC 2,5 HC/ 3-G-5,08	1943315	50
4	15.24	IC 2,5 HC/ 4-G-5,08	1943328	50
5	20.32	IC 2,5 HC/ 5-G-5,08	1943331	50
6	25.40	IC 2,5 HC/ 6-G-5,08	1943344	50
7	30.48	IC 2,5 HC/ 7-G-5,08	1943360	50
8	35.56	IC 2,5 HC/ 8-G-5,08	1943373	50
9	40.64	IC 2,5 HC/ 9-G-5,08	1943386	50
10	45.72	IC 2,5 HC/10-G-5,08	1943399	50
11	50.80	IC 2,5 HC/11-G-5,08	1943409	50
12	55.88	IC 2,5 HC/12-G-5,08	1943412	50

Plug-in connectors for power electronics with 5.0 to 15.0 mm pitch

HC series plug-in connectors up to 16 A/2.5 mm², pitch 5.0 or 5.08/7.62 mm



Horizontal, with threaded flange



Vertical



Vertical, with threaded flange



Dimensional drawing

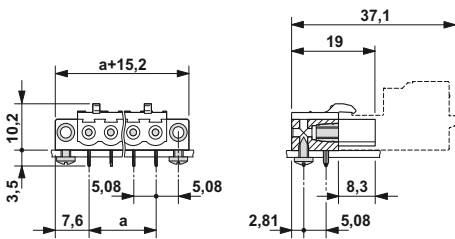

Drilling diagram

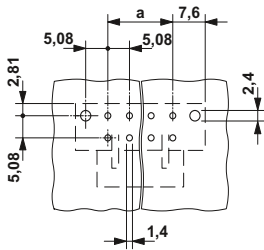

Ordering data

Type	Order No.	Pcs. / Pkt.
5.08 mm pitch, color: green		
IC 2,5 HC/ 2-GF-5,08	1943425	50
IC 2,5 HC/ 3-GF-5,08	1943438	50
IC 2,5 HC/ 4-GF-5,08	1943441	50
IC 2,5 HC/ 5-GF-5,08	1943454	50
IC 2,5 HC/ 6-GF-5,08	1943467	50
IC 2,5 HC/ 7-GF-5,08	1943470	50
IC 2,5 HC/ 8-GF-5,08	1943483	50
IC 2,5 HC/ 9-GF-5,08	1943496	50
IC 2,5 HC/10-GF-5,08	1943506	50
IC 2,5 HC/11-GF-5,08	1943519	50
IC 2,5 HC/12-GF-5,08	1943522	50



Dimensional drawing

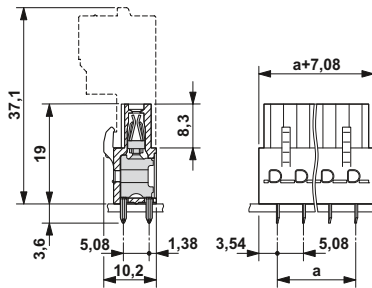

Drilling diagram

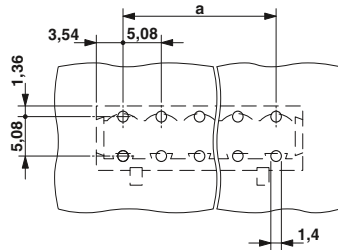

Ordering data

Type	Order No.	Pcs. / Pkt.
5.08 mm pitch, color: green		
ICV 2,5 HC/ 2-G-5,08	1943535	50
ICV 2,5 HC/ 3-G-5,08	1943548	50
ICV 2,5 HC/ 4-G-5,08	1943551	50
ICV 2,5 HC/ 5-G-5,08	1943564	50
ICV 2,5 HC/ 6-G-5,08	1943577	50
ICV 2,5 HC/ 7-G-5,08	1943580	50
ICV 2,5 HC/ 8-G-5,08	1943593	50
ICV 2,5 HC/ 9-G-5,08	1943603	50
ICV 2,5 HC/10-G-5,08	1943616	50
ICV 2,5 HC/11-G-5,08	1943629	50
ICV 2,5 HC/12-G-5,08	1943632	50



Dimensional drawing

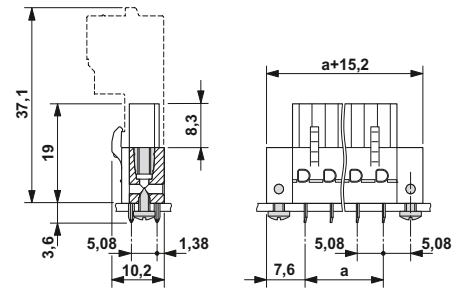

Drilling diagram

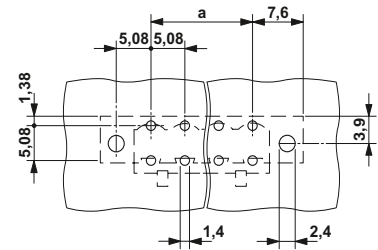

Ordering data

Type	Order No.	Pcs. / Pkt.
5.08 mm pitch, color: green		
ICV 2,5 HC/ 2-GF-5,08	1943645	50
ICV 2,5 HC/ 3-GF-5,08	1943658	50
ICV 2,5 HC/ 4-GF-5,08	1943661	50
ICV 2,5 HC/ 5-GF-5,08	1943674	50
ICV 2,5 HC/ 6-GF-5,08	1943687	50
ICV 2,5 HC/ 7-GF-5,08	1943690	50
ICV 2,5 HC/ 8-GF-5,08	1943700	50
ICV 2,5 HC/ 9-GF-5,08	1943713	50
ICV 2,5 HC/10-GF-5,08	1943726	50
ICV 2,5 HC/11-GF-5,08	1943739	50
ICV 2,5 HC/12-GF-5,08	1943742	50

Plug-in connectors for power electronics with 5.0 to 15.0 mm pitch

HC series plug-in connectors up to 16 A/2.5 mm², pitch 5.0 or 5.08/7.62 mm

Vertical plug-in connectors for 600 V UL

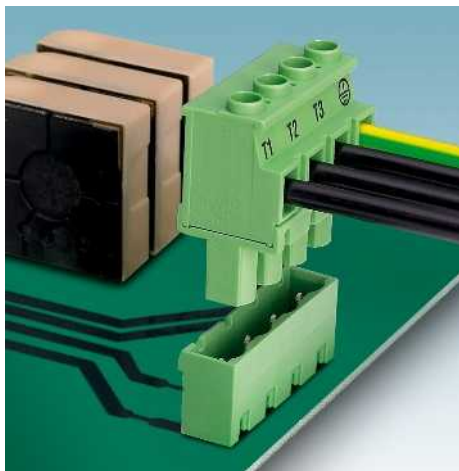

- High-capacity connectors for voltages of up to 1000 V as per IEC
- Plugs with unrestricted 600 V UL approval
- Plug-in direction vertical to the PCB
- GMVSTBR 2,5 HV...ST, conductor entry on the coding side of the plug, so conductor exit upward
- GMVSTBW 2,5 HV...ST, conductor entry on the rippled side of the plug, so conductor exit downward
- Compatible with the GMSTB 2,5/...-G-7,62 base strips, see page 342

Notes:

In accordance with DIN EN 61984, COMBICON plug-in connectors have no switching power. During designated use, they must not be plugged in or disconnected when carrying voltage or under load.

COMBICON select



You will find the possible plug-in connector combinations in COMBICON select at: www.phoenixcontact.net/products or starting on page 484.

¹⁾ Please observe the derating curves and laboratory data sheets. Derating curves of further combination options on request.



Connection point facing the smooth wall of the header (R), 600 V UL approval

Accessories

For all types	Type	Page
	Coding profile CP-MSTB Order No. 1734634	38
	Screwdriver SZS 0,6 x 3,5 Order No. 1205053	
	Marker cards SK 7,62/3,8	799

Dimensional drawing

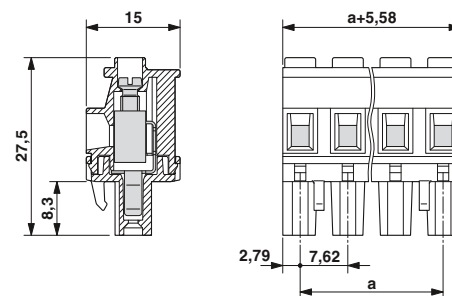

Note derating curves

Derating curves, determined as per
DIN EN 61984 (VDE 0627):2002-09
Representation based on DIN EN 60512-5-2:2003-01
Connected conductor cross section = 2.5 mm²
Reduction factor = 0.8
Number of positions = see diagram

Technical data

Technical data in accordance to IEC / DIN VDE	
Rated current / conductor cross section	[A] / [mm ²]
Rated insulation voltage for pollution degree 2	[V]
Pitch	[mm]
Connection capacity	
Solid / stranded	[mm ²] / [mm ²] / AWG
Stranded with ferrules without plastic sleeve	[mm ²]
Stranded with ferrules with plastic sleeve	[mm ²]
Multi-conductor connection capacity (two conductors with the same cross section)	
Solid / stranded	[mm ²]
Stranded with ferrules without plastic sleeve	[mm ²]
Stranded with TWIN ferrule with plastic sleeve	[mm ²]
Insulation coordination	
Surge voltage category / pollution degree	III / 3 III / 2 II / 2
Rated insulation voltage	[V]
Rated surge voltage	[kV]
Approval data (UL/CUL)	Use Group
Nominal voltage	[V]
Nominal current	[A]
Connection capacity AWG	AWG
Approval data (CSA)	Use Group
Nominal voltage	[V]
Nominal current	[A]
Connection capacity AWG	AWG
General data	
Stripping length	[mm]
Screw thread	
Tightening torque	[Nm]
Type of insulation material / insulation material group	
Inflammability class according to UL 94	

	12 ¹⁾ / 2.5
	630
	7.62
	0.2 - 2.5 / 0.2 - 2.5 / 24 - 12
	0.25 - 2.5
	0.25 - 2.5
	0.2 - 1 / 0.2 - 1.5
	0.25 - 1
	0.5 - 1
	III / 3 III / 2 II / 2
	500 630 1000
	6 6 6
	B C D
	600 600 -
	15 15 -
	30 - 12 30 - 12 -
	B C D
	- - -
	- - -
	- - -
	7
	M3
	0.5 - 0.6
	PA / I
	V0

Ordering data

Type	Order No.	Pcs. / Pkt.
Pitch 7.62 mm, color: green		
GMVSTBR 2,5 HV/ 2-ST-7,62	1774454	50
GMVSTBR 2,5 HV/ 3-ST-7,62	1993954	50
GMVSTBR 2,5 HV/ 4-ST-7,62	1774467	50



Connection point facing the rippled wall of the header (W), 600 V UL approval



Dimensional drawing

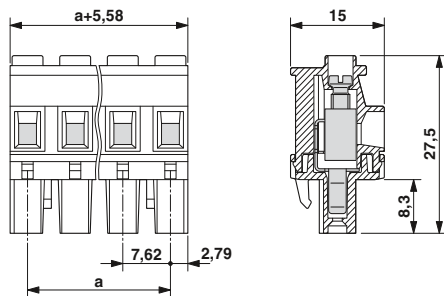

Representative derating curve

Type: GMVSTBR 2,5 HV/...-ST-7,62 with GMSTBA 2,5/...-G-7,62

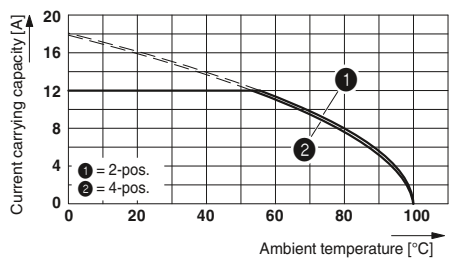

Ordering data

Type	Order No.	Pcs. / Pkt.
Pitch 7.62 mm, color: green		
GMVSTBW 2,5 HV/ 2-ST-7,62	1771910	50
GMVSTBW 2,5 HV/ 3-ST-7,62	1993967	50
GMVSTBW 2,5 HV/ 4-ST-7,62	1927221	50

Plug-in connectors for power electronics with 5.0 to 15.0 mm pitch

HC series plug-in connectors up to 16 A/2.5 mm², pitch 5.0 or 5.08/7.62 mm

Plugs with screw connection for 600 V UL

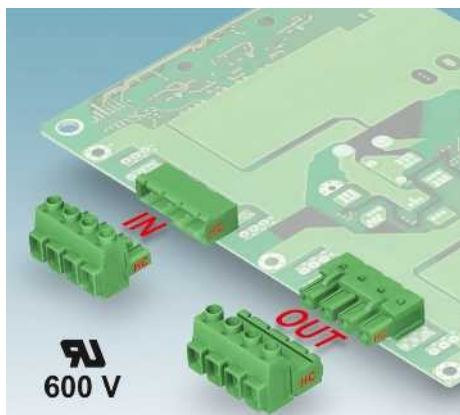

- High-capacity within minimum space: current carrying capacity of 16 A in combination with an unrestricted 600-V-UL approval
- Compact 7.62 mm pitch
- GMSTB 2,5 HCV plugs should be used only with GMSTBA 2,5 HC base strips
- The double steel spring ensures additional safety, especially in case of temperature and capacity fluctuations
- The versions with Lock & Release levers lock the plug to the header and also serve as a release tool
- Inverted GIC 2,5 HCV plugs with pin contacts

Notes:

In accordance with DIN EN 61984, COMBICON plug-in connectors have no switching power. During designated use, they must not be plugged in or disconnected when carrying voltage or under load.

The designation "HC" is printed in red to provide clear identification of "High current" connectors.

1) Please observe the derating curves and laboratory data sheets. Derating curves of further combination options on request.

2) Diverging UL data with GIC 2,5 HCV/...-ST-7,62: nominal current = 16 A.



With socket contact, 600 V UL approval

Accessories		
For all types	Type	Page
	Coding profile CP-MSTB Order No. 1734634	38
	Marker cards SK 7,62/3,8	799
	Screwdriver SZS 0,6 x 3,5 Order No. 1205053	



Dimensional drawing

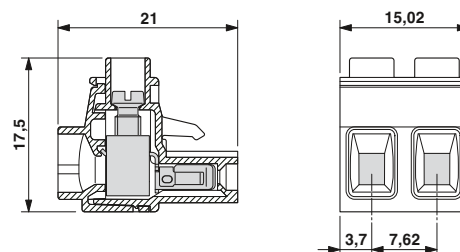

Note derating curves

Derating curves according to DIN EN 61984 (VDE 0627):2002-09
Representation based on DIN EN 60512-5-2:2003-01
Connected conductor cross section = 2.5 mm²
Reduction factor = 0.8
No. of positions: See diagram

Technical data

Technical data in accordance to IEC / DIN VDE	
Rated current / conductor cross section	[A] / [mm ²]
Rated insulation voltage for pollution degree 2	[V]
Pitch	[mm]
Connection capacity	
Solid / stranded	[mm ²] / [mm ²] / AWG
Stranded with ferrules without plastic sleeve	[mm ²]
Stranded with ferrules with plastic sleeve	[mm ²]
Multi-conductor connection capacity (two conductors with the same cross section)	
Solid / stranded	[mm ²]
Stranded with ferrules without plastic sleeve	[mm ²]
Stranded with TWIN ferrule with plastic sleeve	[mm ²]
Insulation coordination	
Surge voltage category / pollution degree	
Rated insulation voltage	[V]
Rated surge voltage	[kV]
Approval data (UL/CUL)	Use Group
Nominal voltage	[V]
Nominal current	[A]
Connection capacity AWG	AWG
Approval data (CSA)	Use Group
Nominal voltage	[V]
Nominal current	[A]
Connection capacity AWG	AWG
General data	
Stripping length	[mm]
Screw thread	
Tightening torque	[Nm]
Type of insulation material / insulation material group	
Inflammability class according to UL 94	

16 ¹⁾ / 2.5		
1000		
7.62		
0.2 - 2.5 / 0.2 - 2.5 / 24 - 12		
0.25 - 2.5		
0.25 - 2.5		
0.2 - 1 / 0.2 - 1.5		
0.25 - 1		
0.5 - 1		
III / 3	III / 2	II / 2
1000	1000	1000
8	8	8
B	C	D
600	600	-
18.5 ²⁾	18.5	-
30 - 12	30 - 12	-
B	C	D
-	-	-
-	-	-
-	-	-
8		
M3		
0.5 - 0.6		
PA / I		
V0		

No. of pos.	Dim. a [mm]
2	7.62
3	15.24
4	22.86
5	30.48
6	38.10
7	45.72
8	53.34
9	60.96
10	68.58
11	76.20
12	83.82

Ordering data

Type	Order No.	Pcs. / Pkt.
Pitch 7.62 mm, color: green		
GMSTB 2,5 HCV/ 2-ST-7,62	1714278	50
GMSTB 2,5 HCV/ 3-ST-7,62	1714281	50
GMSTB 2,5 HCV/ 4-ST-7,62	1714294	50
GMSTB 2,5 HCV/ 5-ST-7,62	1714304	50
GMSTB 2,5 HCV/ 6-ST-7,62	1714317	50
GMSTB 2,5 HCV/ 7-ST-7,62	1714320	50
GMSTB 2,5 HCV/ 8-ST-7,62	1714333	50
GMSTB 2,5 HCV/ 9-ST-7,62	1714346	50
GMSTB 2,5 HCV/10-ST-7,62	1714359	50
GMSTB 2,5 HCV/11-ST-7,62	1714362	50
GMSTB 2,5 HCV/12-ST-7,62	1714375	50

N



Inverted with pin contact, 600 V UL approval

Lock & Release locking, with socket contact, 600 V UL approval



Dimensional drawing

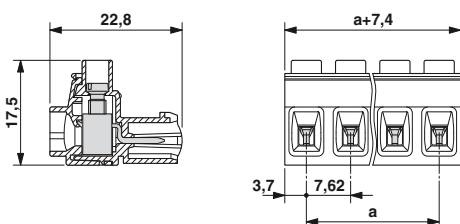

Dimensional drawing

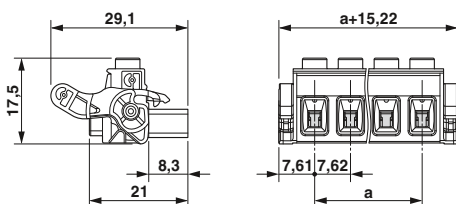

Representative derating curves of the above-mentioned plugs

Type: GMSTB 2,5 HCV/...-ST-7,62 with GMSTBA 2,5 HC/...-G-7,62

Type: GIC 2.5HCV/...-ST-7.62 with GIC 2.5HC/...-G-7.62

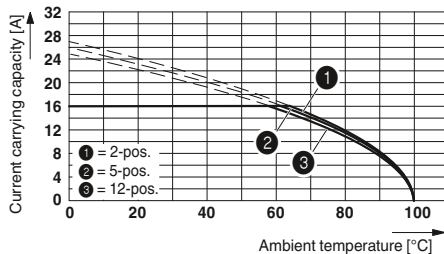
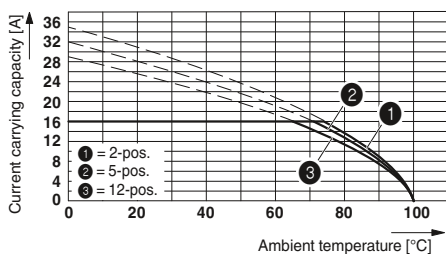

Ordering data

Type	Order No.	Pcs. / Pkt.
Pitch 7.62 mm, color: green		
GIC 2,5 HCV/ 2-ST-7,62	1745629	50
GIC 2,5 HCV/ 3-ST-7,62	1745632	50
GIC 2,5 HCV/ 4-ST-7,62	1745645	50
GIC 2,5 HCV/ 5-ST-7,62	1745658	50
GIC 2,5 HCV/ 6-ST-7,62	1745661	50
GIC 2,5 HCV/ 7-ST-7,62	1745674	50
GIC 2,5 HCV/ 8-ST-7,62	1745687	50
GIC 2,5 HCV/ 9-ST-7,62	1745690	50
GIC 2,5 HCV/10-ST-7,62	1745700	50
GIC 2,5 HCV/11-ST-7,62	1745713	50
GIC 2,5 HCV/12-ST-7,62	1745726	50

Ordering data

Type	Order No.	Pcs. / Pkt.
Pitch 7.62 mm, color: green		
GMSTB 2,5 HCV/ 2-ST-7,62-LR	1812759	50
GMSTB 2,5 HCV/ 3-ST-7,62-LR	1812762	50
GMSTB 2,5 HCV/ 4-ST-7,62-LR	1812775	50
GMSTB 2,5 HCV/ 5-ST-7,62-LR	1812788	50
GMSTB 2,5 HCV/ 6-ST-7,62-LR	1812791	50
GMSTB 2,5 HCV/ 7-ST-7,62-LR	1812801	50
GMSTB 2,5 HCV/ 8-ST-7,62-LR	1812814	50
GMSTB 2,5 HCV/10-ST-7,62-LR	1812830	50
GMSTB 2,5 HCV/10-ST-7,62-LR	1812830	50
GMSTB 2,5 HCV/11-ST-7,62-LR	1812843	50
GMSTB 2,5 HCV/12-ST-7,62-LR	1812856	50

Plug-in connectors for power electronics with 5.0 to 15.0 mm pitch

HC series plug-in connectors up to 16 A/2.5 mm², pitch 5.0 or 5.08/7.62 mm

Headers with pin contact

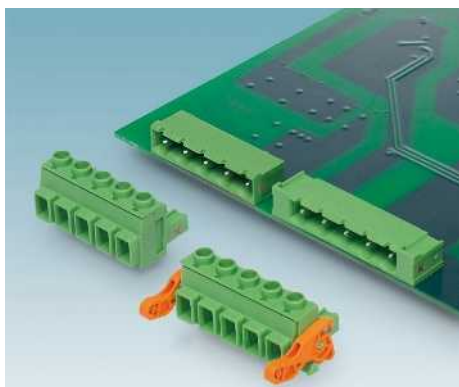

- GMSTB 2,5 HC headers for combination with GMSTB 2,5 HCV plugs
- Compact 7.62 mm pitch
- CR-MSTB coding sections as protection against mismatching
- Lock & Release versions lock the plug to the header and also serve as a release tool

Notes:

In accordance with DIN EN 61984, COMBICON plug-in connectors have no switching power. During designated use, they must not be plugged in or disconnected when carrying voltage or under load.

The designation "HC" is printed in red to provide clear identification of "High current" connectors.

COMBICON select

You will find the possible plug-in connector combinations in COMBICON select at: www.phoenixcontact.net/products or starting on page 484.

¹⁾ Please observe the derating curves and laboratory data sheets. Derating curves of further combination options on request.



Horizontal

Accessories

For all types	Type	Page
	Coding section CR-MSTB Order No. 1734401	38
	Marker cards SK 7,62/3,8	799
	Coding tab MSTB-BL Order No. 1755477	837



Dimensional drawing

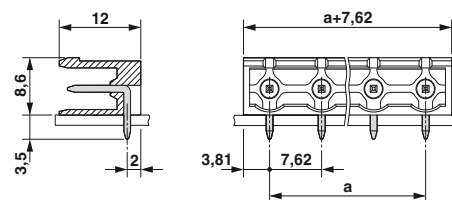

Drilling diagram

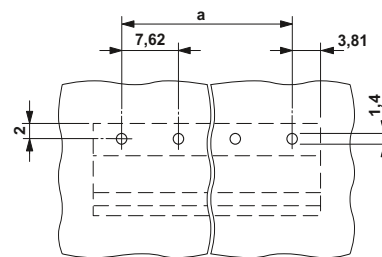

Technical data

Technical data in accordance to IEC / DIN VDE

Rated current	[A]	16 ¹⁾
Rated insulation voltage for pollution degree 2	[V]	630
Pitch	[mm]	7.62
Insulation coordination		
Surge voltage category / pollution degree		III / 3 III / 2 II / 2
Rated insulation voltage	[V]	500 630 1000
Rated surge voltage	[kV]	6 6 6
Approval data (UL/CUL)	Use Group	B C D
Nominal voltage	[V]	300 - 300
Nominal current	[A]	18.5 - 10
Connection capacity AWG	AWG	- - -
Approval data (CSA)	Use Group	B C D
Nominal voltage	[V]	- - -
Nominal current	[A]	- - -
Connection capacity AWG	AWG	- - -
General data		
Type of insulation material / insulation material group		PA / I
Inflammability class according to UL 94		V0
Drill hole diameter / pin dimensions	[mm]	1.4 / 1 x 1 mm

Ordering data

No. of pos.	Dim. a [mm]	Type	Order No.	Pcs. / Pkt.
Pitch 7.62 mm, color: green				
2	7.62	GMSTBA 2,5 HC/ 2-G-7,62	1728853	50
3	15.24	GMSTBA 2,5 HC/ 3-G-7,62	1728866	50
4	22.86	GMSTBA 2,5 HC/ 4-G-7,62	1728879	50
5	30.48	GMSTBA 2,5 HC/ 5-G-7,62	1728882	50
6	38.10	GMSTBA 2,5 HC/ 6-G-7,62	1728895	50
7	45.72	GMSTBA 2,5 HC/ 7-G-7,62	1728905	50
8	53.34	GMSTBA 2,5 HC/ 8-G-7,62	1728918	50
9	60.96	GMSTBA 2,5 HC/ 9-G-7,62	1728921	50
10	68.58	GMSTBA 2,5 HC/10-G-7,62	1728934	50
11	76.20	GMSTBA 2,5 HC/11-G-7,62	1728947	50
12	83.82	GMSTBA 2,5 HC/12-G-7,62	1728950	50

N

N

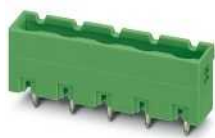

Vertical



Lock & Release locking, horizontal



Lock & Release locking, vertical



Dimensional drawing

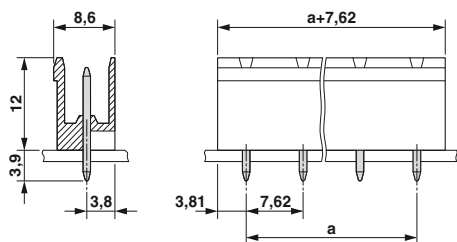

Drilling diagram

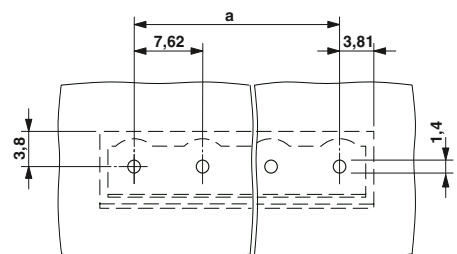

Ordering data

Type	Order No.	Pcs. / Pkt.
Pitch 7.62 mm, color: green		
GMSTBVA 2,5 HC/ 2-G-7,62	1792397	50
GMSTBVA 2,5 HC/ 3-G-7,62	1767979	50
GMSTBVA 2,5 HC/ 4-G-7,62	1758179	50
GMSTBVA 2,5 HC/ 5-G-7,62	1773455	50
GMSTBVA 2,5 HC/ 6-G-7,62	1767050	50
GMSTBVA 2,5 HC/ 7-G-7,62	1792407	50
GMSTBVA 2,5 HC/ 8-G-7,62	1792410	50
GMSTBVA 2,5 HC/ 9-G-7,62	1792423	50
GMSTBVA 2,5 HC/10-G-7,62	1792436	50
GMSTBVA 2,5 HC/11-G-7,62	1792449	50
GMSTBVA 2,5 HC/12-G-7,62	1792452	50



Dimensional drawing

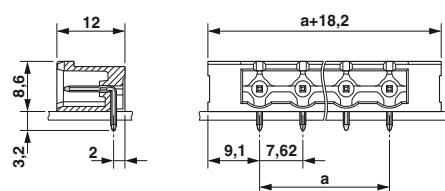

Drilling diagram

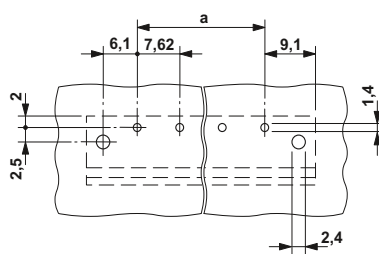

Ordering data

Type	Order No.	Pcs. / Pkt.
Pitch 7.62 mm, color: green		
GMSTBA 2,5 HC/ 2-G-7,62-LR	1812869	50
GMSTBA 2,5 HC/ 3-G-7,62-LR	1812872	50
GMSTBA 2,5 HC/ 4-G-7,62-LR	1812885	50
GMSTBA 2,5 HC/ 5-G-7,62-LR	1812898	50
GMSTBA 2,5 HC/ 6-G-7,62-LR	1812908	50
GMSTBA 2,5 HC/ 7-G-7,62-LR	1812911	50
GMSTBA 2,5 HC/ 8-G-7,62-LR	1812924	50
GMSTBA 2,5 HC/ 9-G-7,62-LR	1812937	50
GMSTBA 2,5 HC/10-G-7,62-LR	1812940	50
GMSTBA 2,5 HC/11-G-7,62-LR	1812953	50
GMSTBA 2,5 HC/12-G-7,62-LR	1812966	50



Dimensional drawing

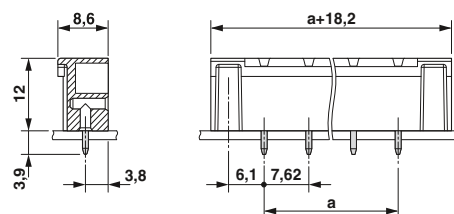

Drilling diagram

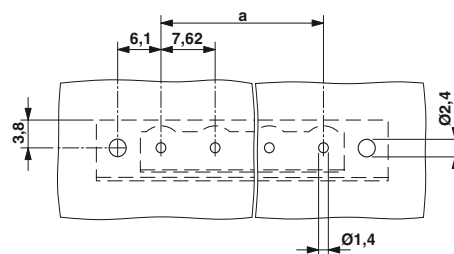

Ordering data

Type	Order No.	Pcs. / Pkt.
Pitch 7.62 mm, color: green		
GMSTBVA 2,5 HC/ 2-G-7,62-LR	1812979	50
GMSTBVA 2,5 HC/ 3-G-7,62-LR	1812982	50
GMSTBVA 2,5 HC/ 4-G-7,62-LR	1812995	50
GMSTBVA 2,5 HC/ 5-G-7,62-LR	1813004	50
GMSTBVA 2,5 HC/ 6-G-7,62-LR	1813017	50
GMSTBVA 2,5 HC/ 7-G-7,62-LR	1813020	50
GMSTBVA 2,5 HC/ 8-G-7,62-LR	1813033	50
GMSTBVA 2,5 HC/ 9-G-7,62-LR	1813046	50
GMSTBVA 2,5 HC/10-G-7,62-LR	1813059	50
GMSTBVA 2,5 HC/11-G-7,62-LR	1813062	50
GMSTBVA 2,5 HC/12-G-7,62-LR	1813075	50

Plug-in connectors for power electronics with 5.0 to 15.0 mm pitch

HC series plug-in connectors up to 16 A/2.5 mm², pitch 5.0 or 5.08/7.62 mm

Headers with socket contact



- Inverted GIC 2,5 HC headers with socket contacts for touch-proof device outputs (with GIC 2,5 HCV/... -ST) or a PCB-PCB connection (with GMSTBA 2,5 HC/... -G)
- Maximum contact safety, thanks to an integrated double steel spring
- Coding profile CP-MSTB as protection against mismatching
- Compact 7.62 mm pitch

Notes:

In accordance with DIN EN 61984, COMBICON plug-in connectors have no switching power. During designated use, they must not be plugged in or disconnected when carrying voltage or under load.

COMBICON select

You will find the possible plug-in connector combinations in COMBICON select at: www.phoenixcontact.net/products or starting on page 484.

The designation "HC" is printed in red to provide clear identification of "High current" connectors.

¹⁾ Please observe the derating curves and laboratory data sheets. Derating curves of further combination options on request.



Horizontal

Accessories

For all types	Type	Page
	Coding profile CP-MSTB Order No. 1734634	38
	Marker cards SK 7,62/3,8	799
	Reducing plug RPS Order No. 0201647	831
	Test plug MPS	831



Dimensional drawing

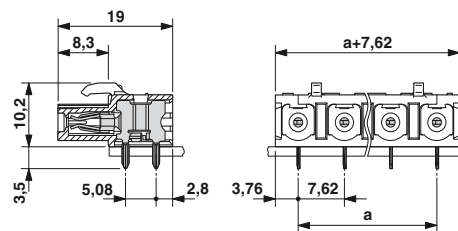

Drilling diagram

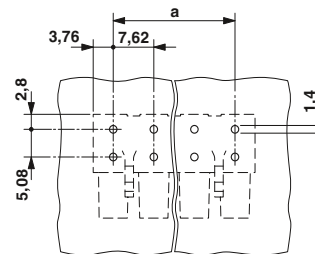

Technical data

Technical data in accordance to IEC / DIN VDE

Rated current	[A]	16 ¹⁾
Rated insulation voltage for pollution degree 2	[V]	630
Pitch	[mm]	7.62
Insulation coordination		
Surge voltage category / pollution degree		III / 3 III / 2 II / 2
Rated insulation voltage	[V]	630 630 1000
Rated surge voltage	[kV]	6 6 6
Approval data (UL/CUL)	Use Group	B C D
Nominal voltage	[V]	250 - 300
Nominal current	[A]	16 - 10
Connection capacity AWG	AWG	- - -
Approval data (CSA)	Use Group	B C D
Nominal voltage	[V]	- - -
Nominal current	[A]	- - -
Connection capacity AWG	AWG	- - -
General data		
Type of insulation material / insulation material group		PA / I
Inflammability class according to UL 94		V0
Drill hole diameter / pin dimensions	[mm]	1.4 / 1.2 x 0.5

Ordering data

No. of pos.	Dim. a [mm]	Type	Order No.	Pcs. / Pkt.
Pitch 7.62 mm, color: green				
2	7.62	GIC 2,5 HC/ 2-G-7,62	1745784	50
3	15.24	GIC 2,5 HC/ 3-G-7,62	1745797	50
4	22.86	GIC 2,5 HC/ 4-G-7,62	1745807	50
5	30.48	GIC 2,5 HC/ 5-G-7,62	1745810	50
6	38.10	GIC 2,5 HC/ 6-G-7,62	1745823	50
7	45.72	GIC 2,5 HC/ 7-G-7,62	1745836	50
8	53.34	GIC 2,5 HC/ 8-G-7,62	1745849	50
9	60.96	GIC 2,5 HC/ 9-G-7,62	1745852	50
10	68.58	GIC 2,5 HC/10-G-7,62	1745865	50
11	76.20	GIC 2,5 HC/11-G-7,62	1745878	50
12	83.82	GIC 2,5 HC/12-G-7,62	1745881	50



Vertical



Dimensional drawing

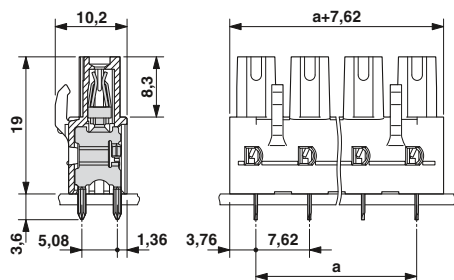

Drilling diagram

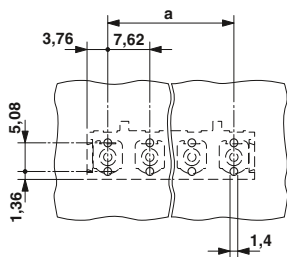

Ordering data

Type	Order No.	Pcs. / Pkt.
Pitch 7.62 mm, color: green		
GICV 2,5 HC/ 2-G-7,62	1756485	50
GICV 2,5 HC/ 3-G-7,62	1756498	50
GICV 2,5 HC/ 4-G-7,62	1756508	50
GICV 2,5 HC/ 5-G-7,62	1756511	50
GICV 2,5 HC/ 6-G-7,62	1756524	50
GICV 2,5 HC/ 7-G-7,62	1756537	50
GICV 2,5 HC/ 8-G-7,62	1756540	50
GICV 2,5 HC/ 9-G-7,62	1756553	50
GICV 2,5 HC/10-G-7,62	1756566	50
GICV 2,5 HC/11-G-7,62	1756579	50
GICV 2,5 HC/12-G-7,62	1756582	50

Plug-in connectors for power electronics with 5.0 to 15.0 mm pitch

HC series plug-in connectors up to 16 A/2.5 mm², pitch 5.0 or 5.08/7.62 mm

ME/ME MAX plug-in connectors/headers, 7.62 mm pitch



- Suitable for ME/ME MAX electronic housing
- 7.25 mm pitch for unlimited 600 V UL approval
- Orthogonal screw/plug-in connection
- 2 and 3 positions suitable for 17.5/35 mm and 22.5/45 mm housing width

Notes:

In accordance with DIN EN 61984, COMBICON plug-in connectors have no switching power. During designated use, they must not be plugged in or disconnected when carrying voltage or under load.

GMSTBT 2,5 HV/...-ST-7,25 GY7035



No. of pos.	Dimension b [mm]
2	14.95
3	19.95

¹⁾ Please observe the derating curves and laboratory data sheets. Derating curves of further combination options on request.



Suitable for GMSTBO 2,5 HV... headers, high-current-compatible

Accessories

For all types	Type	Page
	Coding profile CP-MSTB Order No. 1734634	38
	Marker cards SK 7,5/3,8	799
	Screwdriver SZS 0,6 x 3,5 Order No. 1205053	

Dimensional drawing

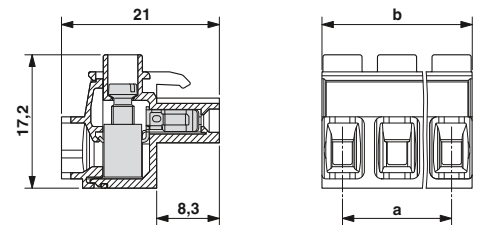

Representative derating curve

Technical data

Technical data in accordance to IEC / DIN VDE	
Rated current / conductor cross section	[A] / [mm ²]
Rated insulation voltage for pollution degree 2	[V]
Pitch	[mm]
Connection capacity	
Solid / stranded	[mm ²] / [mm ²] / AWG
Stranded with ferrules without plastic sleeve	[mm ²]
Stranded with ferrules with plastic sleeve	[mm ²]
Multi-conductor connection capacity (two conductors with the same cross section)	
Solid / stranded	[mm ²]
Stranded with ferrules without plastic sleeve	[mm ²]
Stranded with TWIN ferrule with plastic sleeve	[mm ²]
Insulation coordination	
Surge voltage category / pollution degree	III / 3 III / 2 II / 2
Rated insulation voltage	[V]
Rated surge voltage	[kV]
Approval data (UL/CUL)	Use Group
Nominal voltage	[V]
Nominal current	[A]
Connection capacity AWG	AWG
Approval data (CSA)	Use Group
Nominal voltage	[V]
Nominal current	[A]
Connection capacity AWG	AWG
General data	
Stripping length	[mm]
Screw thread	
Tightening torque	[Nm]
Type of insulation material / insulation material group	
Inflammability class according to UL 94	

Rated current / conductor cross section	16 ¹⁾ / 2.5
Rated insulation voltage for pollution degree 2	1000
Pitch	7.25
Connection capacity	
Solid / stranded	0.2 - 2.5 / 0.2 - 2.5 / 24 - 12
Stranded with ferrules without plastic sleeve	0.25 - 2.5
Stranded with ferrules with plastic sleeve	0.25 - 2.5
Multi-conductor connection capacity (two conductors with the same cross section)	
Solid / stranded	0.1 - 1 / 0.2 - 1.5
Stranded with ferrules without plastic sleeve	0.25 - 1
Stranded with TWIN ferrule with plastic sleeve	0.5 - 1
Insulation coordination	
Surge voltage category / pollution degree	III / 3 III / 2 II / 2
Rated insulation voltage	1000 1000 1000
Rated surge voltage	8 8 8
Approval data (UL/CUL)	B C D
Nominal voltage	600 600 -
Nominal current	16 16 -
Connection capacity AWG	24 - 12 24 - 12 -
Approval data (CSA)	B C D
Nominal voltage	- - -
Nominal current	- - -
Connection capacity AWG	- - -
General data	
Stripping length	8
Screw thread	M3
Tightening torque	0.5 - 0.6
Type of insulation material / insulation material group	PA / I
Inflammability class according to UL 94	V0

No. of pos.	Dim. a [mm]
2	7.25
3	14.50

Ordering data

Type	Order No.	Pcs. / Pkt.
Pitch: 7.25 mm, color: light gray		
GMSTBT 2,5 HV/2-ST-7,25 GY7035	2199757	50
GMSTBT 2,5 HV/3-ST-7,25 GY7035	2199553	50

Plug-in connectors for power electronics with 5.0 to 15.0 mm pitch

HC series plug-in connectors up to 16 A/2.5 mm², pitch 5.0 or 5.08/7.62 mm

Plug-in connectors for power electronics with 5.0 to 15.0 mm pitch

HC series plug-in connectors up to 16 A/2.5 mm², pitch 5.0 or 5.08/7.62 mm

ME/ME MAX plug-in connectors/headers, 7.62 mm pitch



- Suitable for ME/ME MAX electronic housing
- 7.25 mm pitch for unlimited 600 V UL approval
- Orthogonal screw/plug-in connection
- THR solderable
- 2 and 3 positions suitable for 17.5/35 mm and 22.5/45 mm housing width
- “Left” and “right” design
- Delivery form: box packaging bulk material or tape-on-reel packing for automated mounting



Notes:

GMSTBO 2,5 HV...-GL/GR		
No. of pos.	Dimension b [mm]	Dimension c [mm]
2	14.95	8.00
3	19.95	16.00

1) Please observe the derating curves and laboratory data sheets. Derating curves of further combination options on request.



Header with “left” pin strip leading off at a right angle, box packaging

Accessories		
For all types	Type	Page
	Coding section CR-MSTBO G1 Order No. 2199618	38
	Marker cards SK 7,5/3,8	799



Dimensional drawing

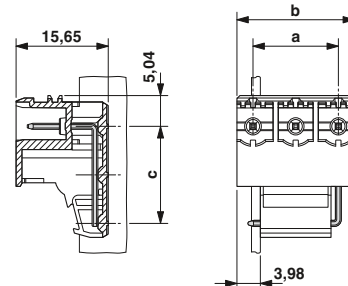

Drilling diagram

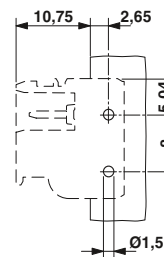

Technical data

Technical data in accordance to IEC / DIN VDE	
Rated current	[A] 16 ¹⁾
Rated insulation voltage for pollution degree 2	[V] 630
Pitch	[mm] -
Insulation coordination	
Surge voltage category / pollution degree	III / 3 III / 2 II / 2
Rated insulation voltage	[V] 400 630 630
Rated surge voltage	[kV] 6 6 6
Approval data (UL/CUL)	Use Group B C D
Nominal voltage	[V] 300 150 300
Nominal current	[A] 16 16 10
Connection capacity AWG	AWG - - -
Approval data (CSA)	Use Group B C D
Nominal voltage	[V] - - -
Nominal current	[A] - - -
Connection capacity AWG	AWG - - -
General data	
Type of insulation material / insulation material group	LCP / IIIa
Inflammability class according to UL 94	V0
Drill hole diameter / pin dimensions	[mm] 1.5 / 1.0 x 1.0 mm

Ordering data

Type	Order No.	Pcs. / Pkt.
Pitch: 7.25 mm, color: black		
GMSTBO 2,5 HV/ 2-GL-7,25 THR	2199867	50
GMSTBO 2,5 HV/ 3-GL-7,25 THR	2199663	50

Plug-in connectors for power electronics with 5.0 to 15.0 mm pitch

HC series plug-in connectors up to 16 A/2.5 mm², pitch 5.0 or 5.08/7.62 mm



Header with "right" pin strip leading off at a right angle, box packaging



Header with "left" pin strip leading off at a right angle, tape-on-reel packing



Header with "right" pin strip leading off at a right angle, tape-on-reel packing



Dimensional drawing

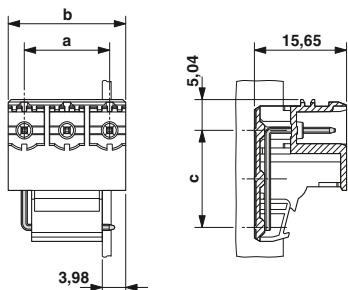

Drilling diagram

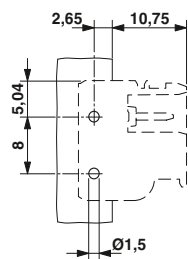

Dimensional drawing

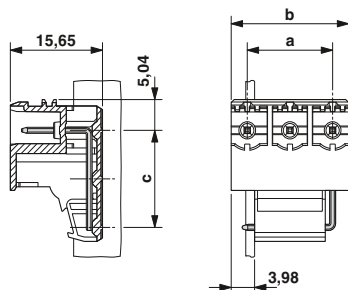

Drilling diagram

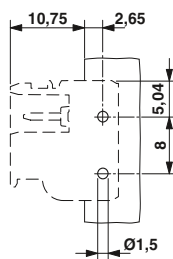

Dimensional drawing

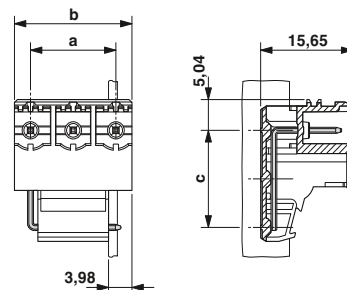

Drilling diagram

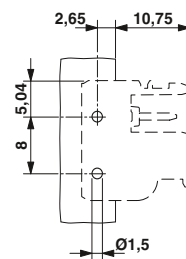

Ordering data

Type	Order No.	Pcs. / Pkt.
Pitch: 7.25 mm, color: black		
GMSTBO 2,5 HV/ 2-GR-7,25 THR	2199760	50
GMSTBO 2,5 HV/ 3-GR-7,25 THR	2199566	50

Ordering data

Type	Order No.	Pcs. / Pkt.
Pitch: 7.25 mm, color: black		
GMSTBO 2,5 HV/ 2-GL-7,25THRR32	2279703	110
GMSTBO 2,5 HV/3-GL-7,25 THRR44	2200263	70

Ordering data

Type	Order No.	Pcs. / Pkt.
Pitch: 7.25 mm, color: black		
GMSTBO 2,5 HV/ 2-GR-7,25THRR32	2279606	110
GMSTBO 2,5 HV/3-GR-7,25 THRR44	2200262	70

Plug-in connectors for power electronics with 5.0 to 15.0 mm pitch

PC 4 series plug-in connectors up to 20 A/4 mm², pitch 7.62 mm

Plugs with screw and crimp connection

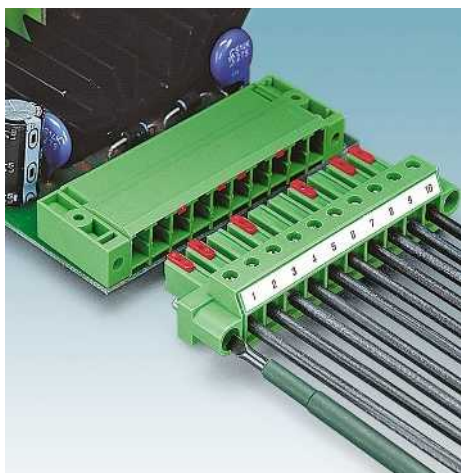

- High-capacity plugs with a current carrying capacity of 20 A
- Screw connection up to 4 mm², stranded
- Integrated double steel spring as extra safety against contact corrosion
- Available with 2 to 12-pos.
- Vibration-resistant connection with a screw flange (PC 4/...-STF-7,62)
- Plug components can be coded using the CP-PC RD coding profiles

Notes:

In accordance with DIN EN 61984, COMBICON plug-in connectors have no switching power. During designated use, they must not be plugged in or disconnected when carrying voltage or under load.

COMBICON select

You will find the possible plug-in connector combinations in COMBICON select at: www.phoenixcontact.net/products or starting on page 486.

¹⁾ Please observe the derating curves and laboratory data sheets. Derating curves of further combination options on request.



Without screw flange



Dimensional drawing

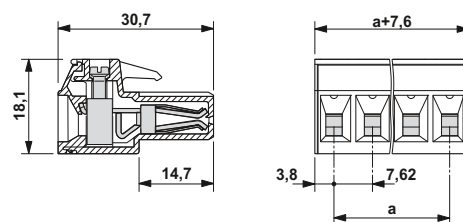

Note derating curves

Derating curves, determined as per DIN EN 61984 (VDE 0627):2002-09
Representation based on DIN EN 60512-5-2:2003-01
Connected conductor cross section = 4 mm²
Reduction factor = 0.8
Number of positions = see diagram

Accessories

For all types	Type	Page
	Coding profile CP-PC RD Order No. 1701967	38
	Marker cards SK 7,62/3,8	799
	Screwdriver SZS 0,6 x 3,5 Order No. 1205053	

Technical data

Technical data in accordance to IEC / DIN VDE

Rated current / conductor cross section [A] / [mm²]

Rated insulation voltage for pollution degree 2 [V]

Pitch [mm]

Connection capacity

Solid / stranded [mm²] / [mm²] / AWG

Stranded with ferrules without plastic sleeve [mm²]

Stranded with ferrules with plastic sleeve [mm²]

Multi-conductor connection capacity (two conductors with the same cross section)

Solid / stranded [mm²]

Stranded with ferrules without plastic sleeve [mm²]

Stranded with TWIN ferrule with plastic sleeve [mm²]

Insulation coordination

Surge voltage category / pollution degree

Rated insulation voltage [V]

Rated surge voltage [kV]

Approval data (UL/CUL) Use Group

Nominal voltage [V]

Nominal current [A]

Connection capacity AWG AWG

Approval data (CSA) Use Group

Nominal voltage [V]

Nominal current [A]

Connection capacity AWG AWG

General data

Stripping length [mm]

Screw thread

Tightening torque [Nm]

Type of insulation material / insulation material group

Inflammability class according to UL 94

20¹⁾ / 4

630

7.62

0.2 - 4 / 0.2 - 4 / 24 - 10

0.25 - 4

0.25 - 4

0.2 - 2.5 / 0.2 - 1.5

0.25 - 1.5

0.5 - 2.5

III / 3 III / 2 II / 2

400 630 1000

6 6 6

B C D

300 300 600

20 20 5

30 - 10 30 - 10 30 - 10

B C D

300 300 -

20 20 -

28 - 10 28 - 10 -

7

M3

0.5 - 0.6

PA / I

V0

Ordering data

No. of pos.

Dim. a [mm]

2 7.62

3 15.24

4 22.86

5 30.48

6 38.10

7 45.72

8 53.34

9 60.96

10 68.58

11 76.20

12 83.82

Type
Pitch 7.62 mm, color: green

Order No.

Pcs. / Pkt.

PC 4/ 2-ST-7,62

1804904

50

PC 4/ 3-ST-7,62

1804917

50

PC 4/ 4-ST-7,62

1804920

50

PC 4/ 5-ST-7,62

1804933

50

PC 4/ 6-ST-7,62

1804946

50

PC 4/ 7-ST-7,62

1804959

50

PC 4/ 8-ST-7,62

1804962

50

PC 4/ 9-ST-7,62

1804975

50

PC 4/10-ST-7,62

1804988

50

PC 4/11-ST-7,62

1804991

50

PC 4/12-ST-7,62

1805000

50



With screw flange



Dimensional drawing

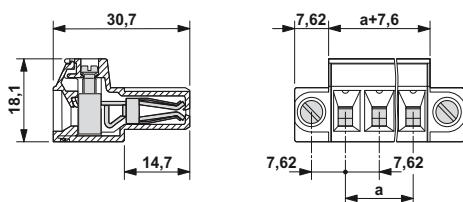

Note on PC 4 HV/...ST-7,62

As part of ongoing product improvements, the PC 4 HV plug-in connector range has been withdrawn.

A replacement is available in the form of the PC 5-ST1 plug-in connector. This connector offers the same space but even better performance data. This plug-in connector is available in the same version options and can be found from catalog page 524.

Representative derating curve

Type: PC 4/...-ST-7,62 with PC 4/...-G-7,62

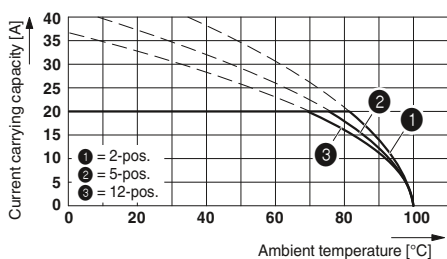

Ordering data

Type	Order No.	Pcs. / Pkt.
Pitch 7.62 mm, color: green		
PC 4/ 2-STF-7,62	1828249	50
PC 4/ 3-STF-7,62	1828252	50
PC 4/ 4-STF-7,62	1828265	50
PC 4/ 5-STF-7,62	1828278	50
PC 4/ 6-STF-7,62	1828281	50
PC 4/ 7-STF-7,62	1828294	50
PC 4/ 8-STF-7,62	1828304	50
PC 4/ 9-STF-7,62	1828317	50
PC 4/10-STF-7,62	1828320	50
PC 4/11-STF-7,62	1828333	50
PC 4/12-STF-7,62	1827583	50

Representative derating curve

Type: PC 5-ST1 with PC 4-G (4 mm²)

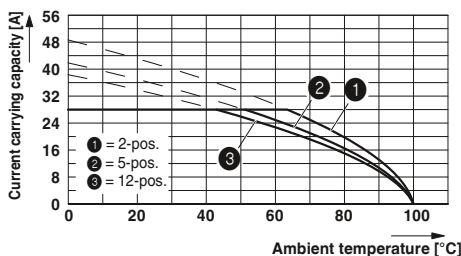

Plug-in connectors for power electronics with 5.0 to 15.0 mm pitch

PC 4 series plug-in connectors up to 20 A/4 mm², pitch 7.62 mm

Plugs with screw and crimp connection



- Low height of the PCC 4 series
- Plug-in direction parallel to the conductor axis
- Latching option for pull-out aid
- Compatible with PC 4 headers for PCB and PCVK 4- and UPCV3K headers for DIN rail mounting
- Crimp contacts available loose and on tape

STG-MTN 0,5-1,0

- for conductor cross sections from 0.5 to 1.0 mm² (AWG 20-18)

STG-MTN 1,5-2,5

- for conductor cross sections from 1.5 to 2.5 mm² (16-14 AWG)

Notes:

In accordance with DIN EN 61984, COMBICON plug-in connectors have no switching power. During designated use, they must not be plugged in or disconnected when carrying voltage or under load.

COMBICON select

You will find the possible plug-in connector combinations in COMBICON select at: www.phoenixcontact.net/products or starting on page 486.

¹⁾ Please observe the derating curves and laboratory data sheets. Derating curves of further combination options on request.



Plugs for crimp contacts

Accessories		
For all types	Type	Page
	Module socket contact, 0.5 to 2.5 mm ² STG-MTN...	827
	Crimping pliers for 0.5 to 2.5 mm ² CRIMPFOX MT 2,5 Order No. 1204038	
	Contact removal tool STG-EW Order No. 3190441	
	Pullout aid STZ...-PCC 4-7,62	828
	Coding profile CP-HCC 4 Order No. 1600027	38
	Marker cards SK 7,62/3,8	799



Dimensional drawing

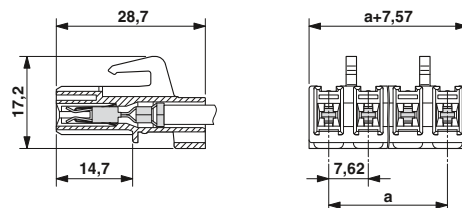

Representative derating curve

Type: PCC 4/...-ST-7,62 with PC 4/...-G-7,62

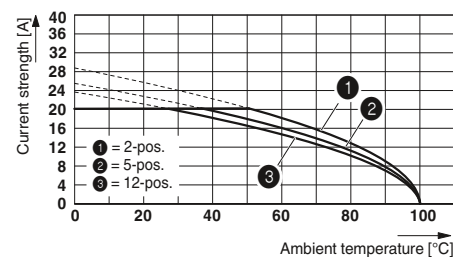

Technical data

Technical data in accordance to IEC / DIN VDE	
Rated current / conductor cross section	[A] / [mm ²]
Rated insulation voltage for pollution degree 2	[V]
Pitch	[mm]
Connection capacity	
Solid / stranded	[mm ²] / [mm ²] / AWG
Stranded with ferrules without plastic sleeve	[mm ²]
Stranded with ferrules with plastic sleeve	[mm ²]
Multi-conductor connection capacity (two conductors with the same cross section)	
Solid / stranded	[mm ²]
Stranded with ferrules without plastic sleeve	[mm ²]
Stranded with TWIN ferrule with plastic sleeve	[mm ²]
Insulation coordination	
Surge voltage category / pollution degree	III / 3 III / 2 II / 2
Rated insulation voltage	[V] 400 1000 1000
Rated surge voltage	[kV] 8 8 8
Approval data (UL/CUL)	Use Group B C D
Nominal voltage	[V] 600 600 -
Nominal current	[A] 10 10 -
Connection capacity AWG	AWG 20 - 14 20 - 14 -
Approval data (CSA)	Use Group B C D
Nominal voltage	[V] 300 300 -
Nominal current	[A] 10 10 -
Connection capacity AWG	AWG 20 - 14 20 - 14 -
General data	
Type of insulation material / insulation material group	PA / I
Inflammability class according to UL 94	V0

No. of pos.	Dim. a [mm]
2	7.62
3	15.24
4	22.86
5	30.48
6	38.10
7	45.72
8	53.34
9	60.96
10	68.58
11	76.20
12	83.82

Ordering data

Type	Order No.	Pcs. / Pkt.
Pitch 7.62 mm, color: green		
PCC 4/ 2-ST-7,62	1840191	50
PCC 4/ 3-ST-7,62	1840188	50
PCC 4/ 4-ST-7,62	1840175	50
PCC 4/ 5-ST-7,62	1840162	50
PCC 4/ 6-ST-7,62	1840159	50
PCC 4/ 7-ST-7,62	1840146	50
PCC 4/ 8-ST-7,62	1840133	50
PCC 4/ 9-ST-7,62	1840120	50
PCC 4/10-ST-7,62	1840117	50
PCC 4/11-ST-7,62	1840104	50
PCC 4/12-ST-7,62	1840094	50

Plug-in connectors for power electronics with 5.0 to 15.0 mm pitch

PC 4 series plug-in connectors up to 20 A/4 mm², pitch 7.62 mm

Headers with pin contact

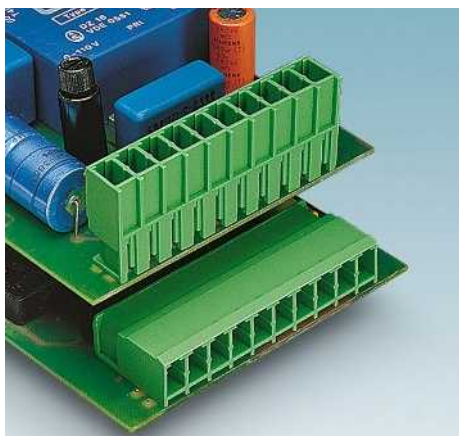

- PC 4 headers for use in combination with all PC 4 plugs
- Horizontal and vertical (PCV) versions available with 2 to 12-pos.
- Vibration-resistant connection with separate mounting flange BF-PC 4 (also for screw connection in the device)
- Shroud PCB-SHIELD for a professional EMC shield connection
- CP-PC RD coding profile as protection against mismatching

Notes:

In accordance with DIN EN 61984, COMBICON plug-in connectors have no switching power. During designated use, they must not be plugged in or disconnected when carrying voltage or under load.

COMBICON select

You will find the possible plug-in connector combinations in COMBICON select at: www.phoenixcontact.net/products or starting on page 486.

Mounting screw for PC(V) 4-G-7,62 with BF-PC 4: sheet metal screw ISO 1481-ST 2,9x9,5 C. Screw connection only permitted prior to soldering.





1) Please observe the derating curves and laboratory data sheets. Derating curves of further combination options on request.

2) Insulation material/insulation material class for the 10-, 11- and 12-pos. versions: PBT/IIIa



Horizontal

Accessories

For all types	Type	Page
	Mounting flange for lateral snapping on BF-PC 4 Order No. 1827570	
	Coding profile CP-PC RD Order No. 1701967	38
	Marker cards SK 7,62/3,8	799
Only for PC 4/...-G-7,62		
	Shroud POWER COMBICON PCB-SHIELD Order No. 1968387	



Dimensional drawing

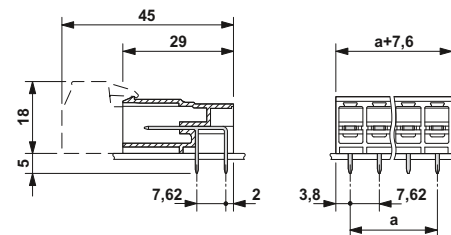

Drilling diagram

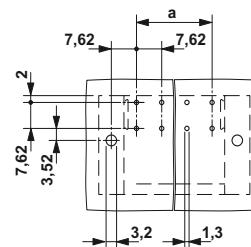

Technical data

Technical data in accordance to IEC / DIN VDE

Rated current	[A]	20 ¹⁾
Rated insulation voltage for pollution degree 2	[V]	630
Pitch	[mm]	7.62
Insulation coordination		
Surge voltage category / pollution degree		III / 3 III / 2 II / 2
Rated insulation voltage	[V]	400 630 630
Rated surge voltage	[kV]	6 6 6
Approval data (UL/CUL)	Use Group	B C D
Nominal voltage	[V]	300 300 -
Nominal current	[A]	20 20 -
Connection capacity AWG	AWG	- - -
Approval data (CSA)	Use Group	B C D
Nominal voltage	[V]	300 300 -
Nominal current	[A]	20 20 -
Connection capacity AWG	AWG	- - -
General data		
Type of insulation material / insulation material group		PA / I ²⁾
Inflammability class according to UL 94		V0
Drill hole diameter / pin dimensions	[mm]	1.3 / 1 x 0.8 mm

No. of pos.	Dim. a [mm]
2	7.62
3	15.24
4	22.86
5	30.48
6	38.10
7	45.72
8	53.34
9	60.96
10	68.58
11	76.20
12	83.82

Ordering data

Type	Order No.	Pcs. / Pkt.
Pitch 7.62 mm, color: green		
PC 4/ 2-G-7,62	1804797	50
PC 4/ 3-G-7,62	1804807	50
PC 4/ 4-G-7,62	1804810	50
PC 4/ 5-G-7,62	1804823	50
PC 4/ 6-G-7,62	1804836	50
PC 4/ 7-G-7,62	1804849	50
PC 4/ 8-G-7,62	1804852	50
PC 4/ 9-G-7,62	1804865	50
PC 4/10-G-7,62	1804878	50
PC 4/11-G-7,62	1804881	50
PC 4/12-G-7,62	1804894	50



Vertical



Dimensional drawing

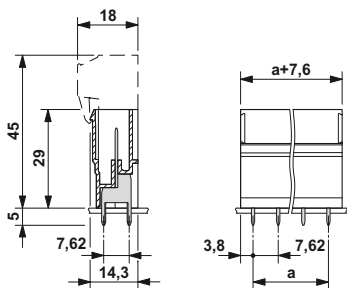

Drilling diagram

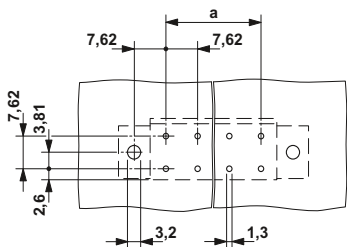

Ordering data

Type	Order No.	Pcs. / Pkt.
Pitch 7.62 mm, color: green		
PCV 4/ 2-G-7,62	1804687	50
PCV 4/ 3-G-7,62	1804690	50
PCV 4/ 4-G-7,62	1804700	50
PCV 4/ 5-G-7,62	1804713	50
PCV 4/ 6-G-7,62	1804726	50
PCV 4/ 7-G-7,62	1804739	50
PCV 4/ 8-G-7,62	1804742	50
PCV 4/ 9-G-7,62	1804755	50
PCV 4/10-G-7,62	1804768	50
PCV 4/11-G-7,62	1804771	50
PCV 4/12-G-7,62	1804784	50

Plug-in connectors for power electronics with 5.0 to 15.0 mm pitch

PC 4 series plug-in connectors up to 20 A/4 mm², pitch 7.62 mm

Feed-through header with a pin contact

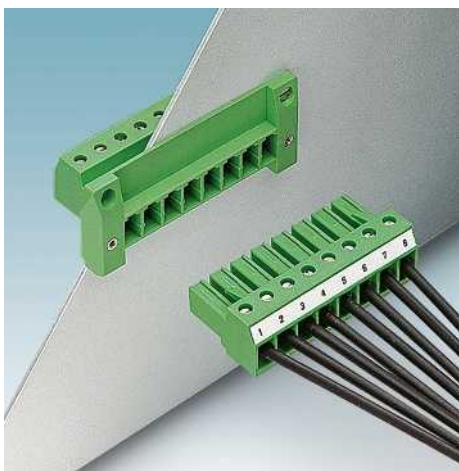

- Feed-through connectors for wall thicknesses from 1 to 5 mm
- Can be plugged onto PC 4 and PC 5 connectors
- A screw connection on the inside of the device
- Lateral mounting flange (screw set, refer to accessories)
- Can be mounted either from outside or pre-wired and mounted from inside

Notes:

In accordance with DIN EN 61984, COMBICON plug-in connectors have no switching power. During designated use, they must not be plugged in or disconnected when carrying voltage or under load.

The cutout dimensions for the feed-through versions can be found on page 595.

Derating curves according to DIN EN 61984 (VDE 0627):2002-09
Representation based on DIN EN 60512-5-2:2003-01
Connected conductor cross section = 4 mm²
Reduction factor = 0.8
No. of positions: See diagram

1) Please observe the derating curves and laboratory data sheets. Derating curves of further combination options on request.



With screw connection on the inside of the device



Accessories

For all types	Type	Page
	One screw set M3 x 10 mm DFK-MSTB-SS Order No. 0708263	
	Coding profile CP-PC RD Order No. 1701967	38
	Marker cards SK 7,62/3,8	799
	Screwdriver SZS 0,6 x 3,5 Order No. 1205053	

Dimensional drawing

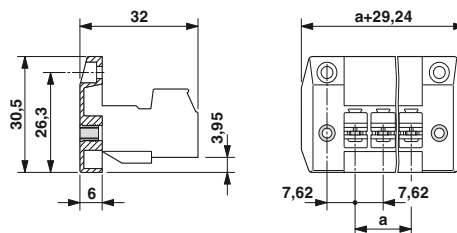

Representative derating curve

Type: PC 4/...-ST-7,62 with DFK-PC 4/...-GF-7,62

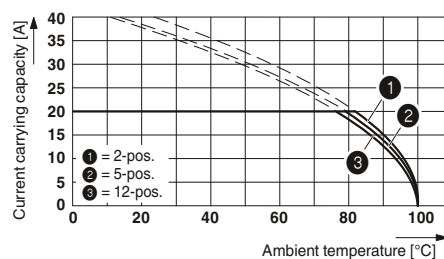

Technical data

Technical data in accordance to IEC / DIN VDE	
Rated current / conductor cross section	[A] / [mm ²]
Rated insulation voltage for pollution degree 2	[V]
Pitch	[mm]
Connection capacity	
Solid / stranded	[mm ²] / [mm ²] / AWG
Stranded with ferrules without plastic sleeve	[mm ²]
Stranded with ferrules with plastic sleeve	[mm ²]
Multi-conductor connection capacity (two conductors with the same cross section)	
Solid / stranded	[mm ²]
Stranded with ferrules without plastic sleeve	[mm ²]
Stranded with TWIN ferrule with plastic sleeve	[mm ²]
Insulation coordination	
Surge voltage category / pollution degree	III / 3 III / 2 II / 2
Rated insulation voltage	[V]
Rated surge voltage	[kV]
Approval data (UL/CUL)	Use Group
Nominal voltage	[V]
Nominal current	[A]
Connection capacity AWG	AWG
Approval data (CSA)	Use Group
Nominal voltage	[V]
Nominal current	[A]
Connection capacity AWG	AWG
General data	
Stripping length	[mm]
Screw thread	
Tightening torque	[Nm]
Type of insulation material / insulation material group	
Inflammability class according to UL 94	

	20 ¹⁾ / 4
	630
	7.62
	0.2 - 4 / 0.2 - 4 / 24 - 10
	0.25 - 4
	0.25 - 4
	0.2 - 2.5 / 0.2 - 2.5
	0.2 - 1.5
	0.5 - 2.5
	III / 3 III / 2 II / 2
	400 630 1000
	6 6 6
	B C D
	300 300 600
	35 35 5
	30 - 10 30 - 10 30 - 10
	B C D
	300 300 -
	20 20 -
	28 - 10 28 - 10 -
	7
	M3
	0.5 - 0.6
	PA / I
	V0

No. of pos.	Dim. a [mm]
2	7.62
3	15.24
4	22.86
5	30.48
6	38.10
7	45.72
8	53.34
9	60.96
10	68.58
11	76.20
12	83.82

Ordering data

Type	Order No.	Pcs. / Pkt.
Pitch 7.62 mm, color: green		
DFK-PC 4/ 2-GF-7,62	1840557	50
DFK-PC 4/ 3-GF-7,62	1840560	50
DFK-PC 4/ 4-GF-7,62	1840573	50
DFK-PC 4/ 5-GF-7,62	1840586	50
DFK-PC 4/ 6-GF-7,62	1840599	50
DFK-PC 4/ 7-GF-7,62	1840609	50
DFK-PC 4/ 8-GF-7,62	1840612	50
DFK-PC 4/ 9-GF-7,62	1840625	50
DFK-PC 4/10-GF-7,62	1840638	50
DFK-PC 4/11-GF-7,62	1840641	50
DFK-PC 4/12-GF-7,62	1840654	50

Feed-through header with a pin contact

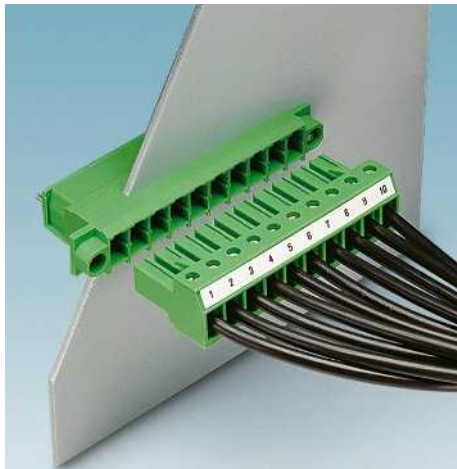

- Feed-through connectors for wall thicknesses from 1 to 5 mm
- Can be plugged onto PC 4 and PC 5 connectors
- Slip-on connection on the inside of the device (solder connection on request)
- Lateral mounting flange (screw set, refer to accessories)

Notes:
COMBICON select You will find the possible plug-in connector combinations in COMBICON select at: www.phoenixcontact.net/products or starting on page 486.
The cutout dimensions for the feed-through versions can be found on page 595.
Derating curves according to DIN EN 61984 (VDE 0627):2002-09 Representation based on DIN EN 60512-5-2:2003-01 Connected conductor cross section = 2.5 mm ² Reduction factor = 0.8 No. of positions: See diagram
1) Please observe the derating curves and laboratory data sheets. Derating curves of further combination options on request.

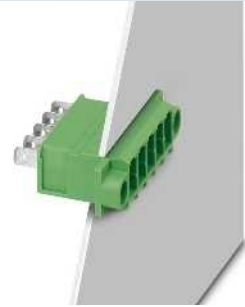

With slip-on connection on the inside of the device

Accessories		
For all types	Type	Page
	One screw set M3 x 10 mm DFK-MSTB-SS Order No. 0708263	
	Coding profile CP-PC RD Order No. 1701967	38
	Marker cards SK 7,62/3,8	799
	Screwdriver SZS 0,6 x 3,5 Order No. 1205053	



Dimensional drawing

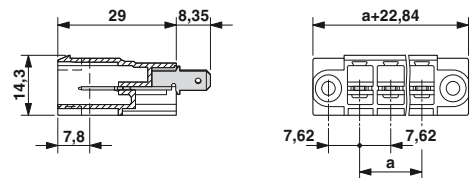

Representative derating curve

Type: PC 4/...-ST-7,62 with DFK-PC 4/...-G-7,62-FS4,8

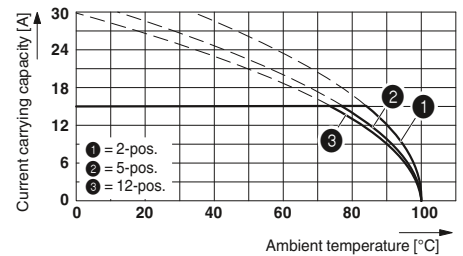

Technical data

Technical data in accordance to IEC / DIN VDE		
Rated current / conductor cross section	[A] / [mm ²]	15 ¹⁾ / 4
Rated insulation voltage for pollution degree 2	[V]	400
Pitch	[mm]	7.62
Insulation coordination		
Surge voltage category / pollution degree		III / 3 III / 2 II / 2
Rated insulation voltage	[V]	400 400 800
Rated surge voltage	[kV]	6 6 6
Approval data (UL/CUL)	Use Group	B C D
Nominal voltage	[V]	300 300 -
Nominal current	[A]	20 20 -
Connection capacity AWG	AWG	- - -
Approval data (CSA)	Use Group	B C D
Nominal voltage	[V]	300 300 -
Nominal current	[A]	20 20 -
Connection capacity AWG	AWG	- - -
General data		
Type of insulation material / insulation material group		PA / I
Inflammability class according to UL 94		V2
Slip-on connection (DIN 46249-1)	[A]/[mm]	- / 4.8 x 0.8 mm

No. of pos.	Dim. a [mm]
2	7.62
3	15.24
4	22.86
5	30.48
6	38.10
7	45.72
8	53.34
9	60.96
10	68.58
11	76.20
12	83.82

Ordering data

Type	Order No.	Pcs. / Pkt.
Pitch 7.62 mm, color: green		
DFK-PC 4/ 2-G-7,62-FS4,8	1861154	50
DFK-PC 4/ 3-G-7,62-FS4,8	1861167	50
DFK-PC 4/ 4-G-7,62-FS4,8	1861170	50
DFK-PC 4/ 5-G-7,62-FS4,8	1861183	50
DFK-PC 4/ 6-G-7,62-FS4,8	1861196	50
DFK-PC 4/ 7-G-7,62-FS4,8	1861206	50
DFK-PC 4/ 8-G-7,62-FS4,8	1861219	50
DFK-PC 4/ 9-G-7,62-FS4,8	1861222	50
DFK-PC 4/10-G-7,62-FS4,8	1861235	50
DFK-PC 4/11-G-7,62-FS4,8	1861248	50
DFK-PC 4/12-G-7,62-FS4,8	1861251	50

Plug-in connectors for power electronics with 5.0 to 15.0 mm pitch

PC 4 series plug-in connectors up to 20 A/4 mm², pitch 7.62 mm

Headers with pin contact for DIN rail mounting

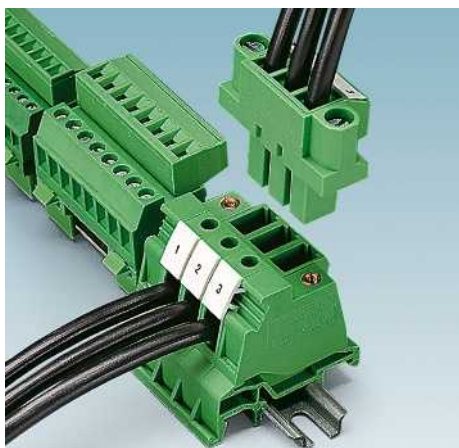

- PCVK 4 and UPCV3K 4 establish the pluggable connection between the electronics and the control cabinet
- For mounting on NS 35/... and NS 15... DIN rail according to EN 60715 – or for the UPCV3K 4-G-7,62 – for mounting on NS 35/... and NS 32 DIN rail
- Can be plugged onto PC 4 and PC 5 plug range
- Vibration-resistant connection with flange terminal blocks that can be aligned (-F)
- UPCV3K provides three connector outputs for each terminal point

Notes:



COMBICON select

You will find the possible plug-in connector combinations in COMBICON select at: www.phoenixcontact.net/products or starting on page 486.

For DIN rails, see Catalog 5.

1) Please observe the derating curves and laboratory data sheets. Derating curves of further combination options on request.

Accessories

For all types	Type	Page
	Coding profile CP-PC RD Order No. 1701967	38
	Screwdriver SZS 0,6 x 3,5 Order No. 1205053	
	Zack marker strip ZB 7,62	805

Representative derating curve

Type: PC 4/...-ST-7,62 with PCVK 4-7,62

DIN EN 61984 (VDE 0627):2002-09 Thermal test group C
Derating curve, representation based on DIN EN 60512-5-2:2003-01
connected conductor cross section = 4 mm²

Reduction factor = 0.8

No. of positions: See diagram

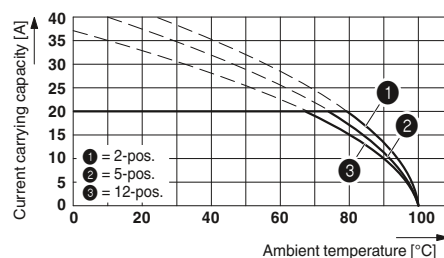

Technical data

Technical data in accordance to IEC / DIN VDE

Rated current / conductor cross section [A] / [mm²]

Rated insulation voltage for pollution degree 2 [V]

Pitch [mm]

Connection capacity

Solid / stranded [mm²] / [mm²] / AWG

Stranded with ferrules without plastic sleeve [mm²]

Stranded with ferrules with plastic sleeve [mm²]

Multi-conductor connection capacity (two conductors with the same cross section)

Solid / stranded [mm²]

Stranded with ferrules without plastic sleeve [mm²]

Stranded with TWIN ferrule with plastic sleeve [mm²]

Insulation coordination

Surge voltage category / pollution degree

Rated insulation voltage [V]

Rated surge voltage [kV]

Approval data (UL/CUL) Use Group

Nominal voltage [V]

Nominal current [A]

Connection capacity AWG AWG

Approval data (CSA) Use Group

Nominal voltage [V]

Nominal current [A]

Connection capacity AWG AWG

General data

Stripping length [mm]

Screw thread

Tightening torque [Nm]

Type of insulation material / insulation material group

Inflammability class according to UL 94

PCVK 4-7,62

20¹⁾ / 4

630

7.62

0.2 - 4 / 0.2 - 4 / 24 - 12

0.25 - 4

0.25 - 4

0.25 - 2.5 / 0.25 - 2.5

0.25 - 1.5

0.5 - 2.5

III / 3 III / 2 II / 2

500 630 1000

6 6 6

B C D

300 300 600

20 20 5

30 - 10 30 - 10 30 - 10

B C D

300 300 -

20 20 -

28 - 10 28 - 10 -

10

M3

0.5 - 0.6

PA / I

V0

PCVK 4-7,62-PE

20¹⁾ / 4

630

7.62

0.2 - 4 / 0.2 - 4 / 24 - 12

0.25 - 4

0.25 - 4

0.25 - 2.5 / 0.25 - 2.5

0.25 - 1.5

0.5 - 2.5

III / 3 III / 2 II / 2

500 630 1000

6 6 6

B C D

- - -

- - -

- - -

- - -

20 20 -

- - -

- - -

10

M3

0.5 - 0.6

PA / I

V0

UPCV3K 4-G-7,62

20¹⁾ / 4

1000

7.62

0.2 - 4 / 0.2 - 4 / 24 - 10

0.25 - 4

0.25 - 4

0.25 - 2.5 / 0.25 - 2.5

0.25 - 1.5

0.5 - 2.5

III / 3 III / 2 II / 2

800 1000 1000

8 8 8

B C D

300 300 600

20 20 5

30 - 10 30 - 10 30 - 10

B C D

- - -

- - -

- - -

10

M3

0.5 - 0.6

PA / I

V0

No. of pos.

1

1

1

1



Single terminal block

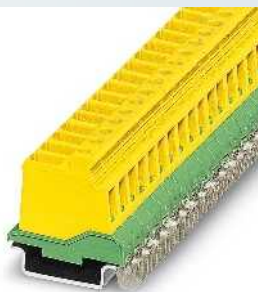

Single terminal block as protective conductor



Single terminal block with 3 plug entries



Dimensional drawing

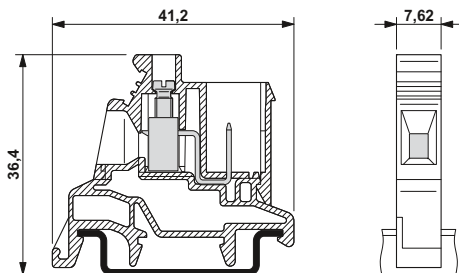

Dimensional drawing

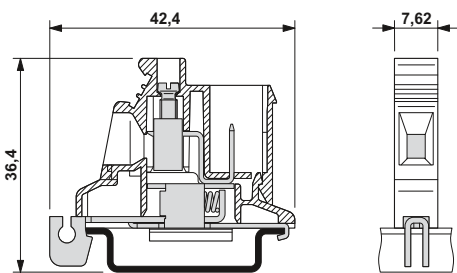

Dimensional drawing

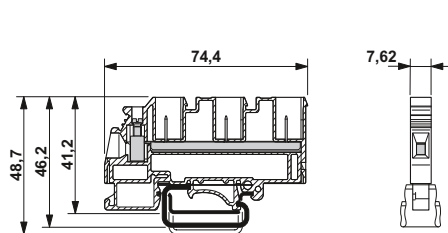

Ordering data		
Type	Order No.	Pcs. / Pkt.
Pitch 7.62 mm, color: green		
PCVK 4-7,62	1849998	50
Flange cover, fitted on the left and right of PCVK 4-7,62 for reliable screw connection of plugs with screw flanges, pitch: 7.62 mm, color: green		
PCVK 4-7,62-F	1850000	50

Ordering data		
Type	Order No.	Pcs. / Pkt.
Pitch 7.62 mm, color: green-yellow		
PCVK 4-7,62-PE	1876246	50

Ordering data		
Type	Order No.	Pcs. / Pkt.
Terminal block, with three vertical COMBICON (Power) connectors/exits, for mounting on NS 32 or NS 35		
UPCV3K 4-G-7,62	1838381	50
Flange cover, fitted on the left and right of UPCV3K 4-G-7,62 for reliable screw connection with the plugs with screw flanges		
UPCV3K-F	1881202	50

Plug-in connectors for power electronics with 5.0 to 15.0 mm pitch

PC 4 series plug-in connectors up to 20 A/4 mm², pitch 7.62 mm

Cable housing for PC 4 plug-in connectors

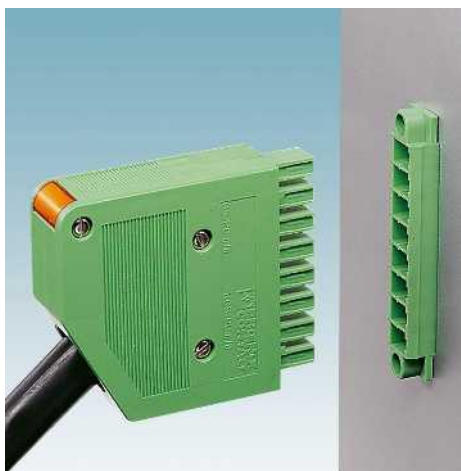

- Ergonomical cable housing for the standard PC 4 connectors with a screw connection
- 3 to 5-pos. and 6 to 12-pos. housing versions are available with and without a mounting flange (-F)
- KGG-PC 4 for cable diameters from 4 to 13.5 mm²
- KGS-PC 4 (angled cable outlet) for cable diameters from 6 to 16 mm²
- A cable clamp can be mounted back to front

Notes:

COMBICON select

You will find the possible plug-in connector combinations in COMBICON select at: www.phoenixcontact.net/products or starting on page 486.



3-5 positions, with straight cable connection

Accessories

For all types	Type	Page
	Transparent marker carrier KGS-MSTB 2,5/DST Order No. 1784914	
	Marker strips, unprinted, 10-section SBS 2,5/7,5 Order No. 1007604	

Dimensional drawing

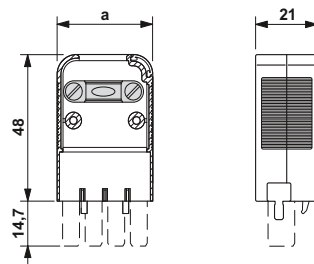

Technical data

Technical data in accordance to IEC / DIN VDE	
Rated current / conductor cross section	[A] / [mm ²]
Rated insulation voltage for pollution degree 2	[V]
Pitch	[mm]
Insulation coordination	
Surge voltage category / pollution degree	
Rated insulation voltage	[V]
Rated surge voltage	[kV]
General data	
Type of insulation material / insulation material group	
Inflammability class according to UL 94	

- / -		
-		
0		
III / 3	III / 2	II / 2
ABS / 0		
HB		

Ordering data

No. of pos.	Dim. a [mm]	Type	Order No.	Pcs. / Pkt.
Pitch 7.62 mm, color: green				
3	24.66	KGG-PC 4/ 3	1837227	10
4	32.28	KGG-PC 4/ 4	1837230	10
5	39.90	KGG-PC 4/ 5	1837243	10
6	47.52			
7	55.14			
8	62.76			
9	70.38			
10	78.00			
11	85.62			
12	93.24			
6	47.52			
7	55.14			
8	62.76			
9	70.98			
10	78.00			
11	85.62			
12	93.24			

Plug-in connectors for power electronics with 5.0 to 15.0 mm pitch

PC 5 series plug-in connectors up to 41 A/10 mm², pitch 7.62 mm

Plugs with screw connection, pin/socket contact

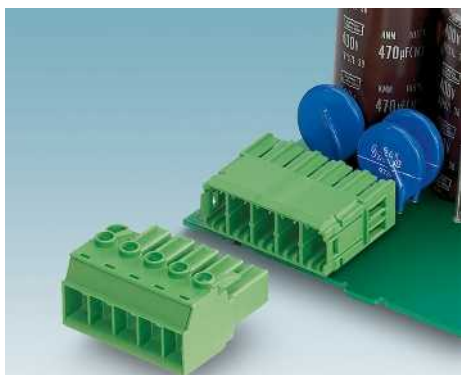

- High-capacity plugs with a current carrying capacity of 41 A and a connection capacity of 6 mm², flexible/10 mm² solid
- Unrestricted 600-V-UL approval
- Maximum contact safety, thanks to an integrated double steel spring
- An automatic toolless snap-lock mechanism with the click and lock system (-STCL); high degree of safety also in the case of vibrations
- Further features: Screw flange (-STF) and shield (-SH)
- CP-PC coding profile as protection against mismatching

Notes:

In accordance with DIN EN 61984, COMBICON plug-in connectors have no switching power. During designated use, they must not be plugged in or disconnected when carrying voltage or under load.

COMBICON select

You will find the possible plug-in connector combinations in COMBICON select at: www.phoenixcontact.net/products or starting on page 486.

1) Please observe the derating curves and laboratory data sheets. Derating curves of further combination options on request.

2) Tightening torque for ≤ 4 mm² = 0.5 to 0.6 Nm
Tightening torque for > 4 mm² = 0.7 to 0.8 Nm



Without screw flange, 600 V UL approval



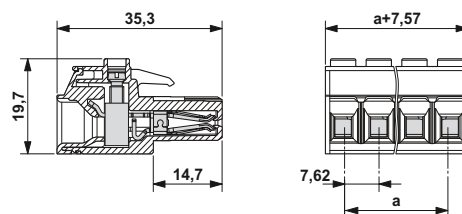

Dimensional drawing



Note derating curves

Derating curves, determined as per
DIN EN 61984 (VDE 0627):2002-09
Representation based on DIN EN 60512-5-2:2003-01
Reduction factor = 0.8
No. of positions: See diagram

Accessories

For all types	Type	Page
	Coding profile CP-PC RD Order No. 1701967	38
	Marker cards SK 7,62/3,8	799

Technical data

Technical data in accordance to IEC / DIN VDE	
Rated current / conductor cross section	[A] / [mm ²]
Rated insulation voltage for pollution degree 2	[V]
Pitch	[mm]
Connection capacity	
Solid / stranded	[mm ²] / [mm ²] / AWG
Stranded with ferrules without plastic sleeve	[mm ²]
Stranded with ferrules with plastic sleeve	[mm ²]
Multi-conductor connection capacity (two conductors with the same cross section)	
Solid / stranded	[mm ²]
Stranded with ferrules without plastic sleeve	[mm ²]
Stranded with TWIN ferrule with plastic sleeve	[mm ²]
Insulation coordination	
Surge voltage category / pollution degree	
Rated insulation voltage	[V]
Rated surge voltage	[kV]
Approval data (UL/CUL)	Use Group
Nominal voltage	[V]
Nominal current	[A]
Connection capacity AWG	AWG
Approval data (CSA)	Use Group
Nominal voltage	[V]
Nominal current	[A]
Connection capacity AWG	AWG
General data	
Stripping length	[mm]
Screw thread	
Tightening torque	[Nm]
Type of insulation material / insulation material group	
Inflammability class according to UL 94	

41 ¹⁾ / 10		
1000		
7.62		
0.2 - 10 / 0.2 - 6 / 24 - 10		
0.25 - 6		
0.25 - 4		
0.2 - 2.5 / 0.2 - 4		
0.25 - 1.5		
0.25 - 2.5		
III / 3	III / 2	II / 2
1000	1000	1000
8	8	6
B	C	D
600	600	-
41	41	-
24 - 8	24 - 8	-
B	C	D
-	-	-
-	-	-
-	-	-
10		
M3		
0.5 - 0.8 ²⁾		
PA / I		
V0		

Ordering data

No. of pos.	Dim. a [mm]	Type	Order No.	Pcs. / Pkt.
Pitch 7.62 mm, color: green				
2	7.62	PC 5/ 2-ST1-7,62	1777723	50
3	15.24	PC 5/ 3-ST1-7,62	1777736	50
4	22.86	PC 5/ 4-ST1-7,62	1777749	50
5	30.48	PC 5/ 5-ST1-7,62	1777752	50
6	38.10	PC 5/ 6-ST1-7,62	1777765	50
7	45.72	PC 5/ 7-ST1-7,62	1777778	50
8	53.34	PC 5/ 8-ST1-7,62	1777781	50
9	60.96	PC 5/ 9-ST1-7,62	1777794	50
10	68.58	PC 5/10-ST1-7,62	1777804	50
11	76.20	PC 5/11-ST1-7,62	1777817	50
12	83.82	PC 5/12-ST1-7,62	1777820	50

Plug-in connectors for power electronics with 5.0 to 15.0 mm pitch

PC 5 series plug-in connectors up to 41 A/10 mm², pitch 7.62 mm



With screw flange, 600 V UL approval

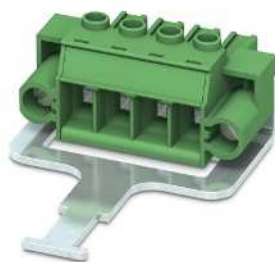

With screw flange and shield, 600 V UL approval

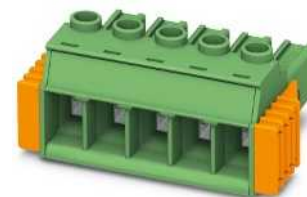

With Click and Lock system, compatible with PC 5 headers and STGCL plug components, 600 V UL approval



Dimensional drawing

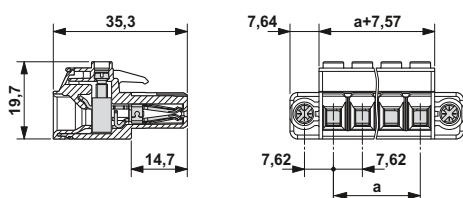

Dimensional drawing

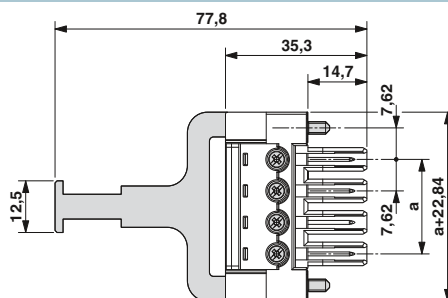

Dimensional drawing

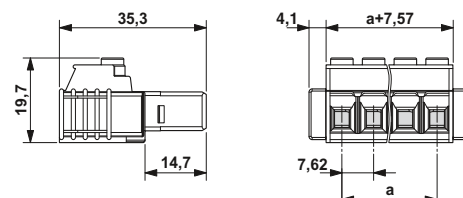

Representative derating curves of the above-mentioned plugs

Type: PC 5/...ST1-7,62 with PC 4/...-G-7,62
Conductor cross section: 4 mm²

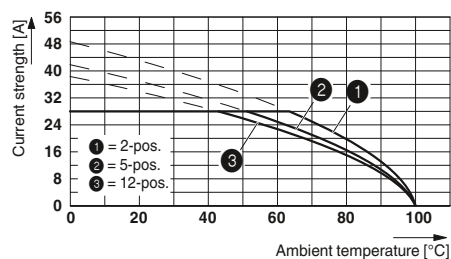

Type: PC 5/...ST1-7,62 with PC 5/...-G-7,62
Conductor cross section: 6 mm²

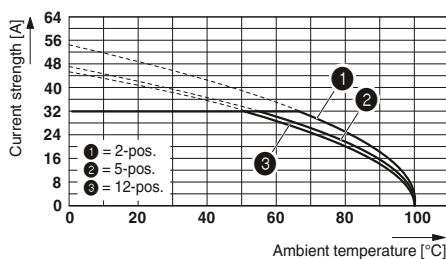

Type: PC 5/...ST1-7,62 with PC 5/...-G-7,62
Conductor cross section: 10 mm²

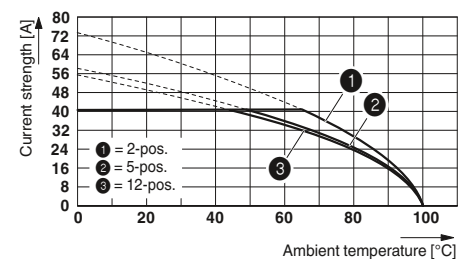

Ordering data

Type	Order No.	Pcs. / Pkt.
Pitch 7.62 mm, color: green		
PC 5/ 2-STF1-7,62	1777833	50
PC 5/ 3-STF1-7,62	1777846	50
PC 5/ 4-STF1-7,62	1777859	50
PC 5/ 5-STF1-7,62	1777862	50
PC 5/ 6-STF1-7,62	1777875	50
PC 5/ 7-STF1-7,62	1777888	50
PC 5/ 8-STF1-7,62	1777891	50
PC 5/ 9-STF1-7,62	1777901	50
PC 5/10-STF1-7,62	1777914	50
PC 5/11-STF1-7,62	1777927	50
PC 5/12-STF1-7,62	1777930	50

Ordering data

Type	Order No.	Pcs. / Pkt.
Pitch 7.62 mm, color: green		
PC 5/ 2-STF-SH1-7,62	1778175	50
PC 5/ 3-STF-SH1-7,62	1778188	50
PC 5/ 4-STF-SH1-7,62	1778191	50
PC 5/ 7-STF-SH1-7,62	1778201	50

Ordering data

Type	Order No.	Pcs. / Pkt.
Pitch 7.62 mm, color: green		
PC 5/ 2-STCL1-7,62	1778065	50
PC 5/ 3-STCL1-7,62	1778078	50
PC 5/ 4-STCL1-7,62	1778081	50
PC 5/ 5-STCL1-7,62	1778094	50
PC 5/ 6-STCL1-7,62	1778104	50
PC 5/ 7-STCL1-7,62	1778117	50
PC 5/ 8-STCL1-7,62	1778120	50
PC 5/ 9-STCL1-7,62	1778133	50
PC 5/10-STCL1-7,62	1778146	50
PC 5/11-STCL1-7,62	1778159	50
PC 5/12-STCL1-7,62	1778162	50

Plug-in connectors for power electronics with 5.0 to 15.0 mm pitch

PC 5 series plug-in connectors up to 41 A/10 mm², pitch 7.62 mm

Plugs with screw connection, pin/socket contact

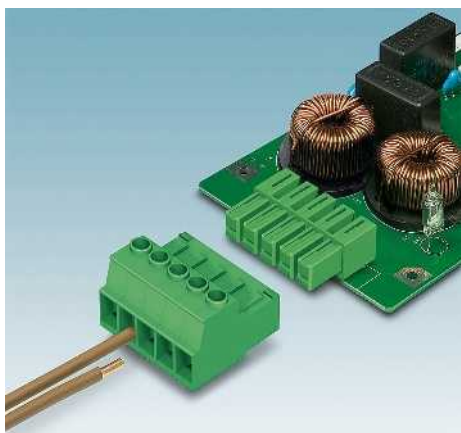

- Inverted IPC 5 plugs with pin contacts for touch-proof device outputs (with IPC 5 G) or free-hanging cable/cable connections
- Unrestricted 600-V-UL approval
- Can be plugged into PC 5 plugs or inverted IPC 5 headers
- An automatic snap-on mechanism without tools for cable-cable connections with the Click and Lock system (-STGCL); high degree of safety even in case of vibrations
- STGF plug with threaded flange

Notes:

In accordance with DIN EN 61984, COMBICON plug-in connectors have no switching power. During designated use, they must not be plugged in or disconnected when carrying voltage or under load.

COMBICON select

You will find the possible plug-in connector combinations in COMBICON select at: www.phoenixcontact.net/products or starting on page 486.

¹⁾ Please observe the derating curves and laboratory data sheets. Derating curves of further combination options on request.



Without screw flange, 600 V UL approval



Dimensional drawing

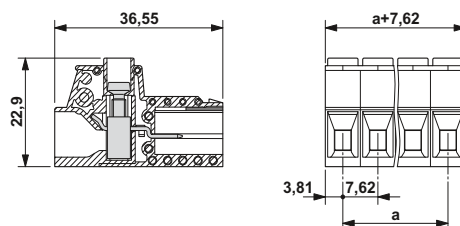

Note derating curves

Derating curves, determined as per
DIN EN 61984 (VDE 0627):2002-09
Representation based on DIN EN 60512-5-2:2003-01
Reduction factor = 0.8
No. of positions: See diagram

Accessories

For all types	Type	Page
	Coding profile CP-PC RD Order No. 1701967	38
	Screwdriver SZK PZ 1 Order No. 1206450	
	Marker cards SK 7,62/3,8	799

Technical data

Technical data in accordance to IEC / DIN VDE	
Rated current / conductor cross section	[A] / [mm ²]
Rated insulation voltage for pollution degree 2	[V]
Pitch	[mm]
Connection capacity	
Solid / stranded	[mm ²] / [mm ²] / AWG
Stranded with ferrules without plastic sleeve	[mm ²]
Stranded with ferrules with plastic sleeve	[mm ²]
Multi-conductor connection capacity (two conductors with the same cross section)	
Solid / stranded	[mm ²]
Stranded with ferrules without plastic sleeve	[mm ²]
Stranded with TWIN ferrule with plastic sleeve	[mm ²]
Insulation coordination	
Surge voltage category / pollution degree	
Rated insulation voltage	[V]
Rated surge voltage	[kV]
Approval data (UL/CUL)	Use Group
Nominal voltage	[V]
Nominal current	[A]
Connection capacity AWG	AWG
Approval data (CSA)	Use Group
Nominal voltage	[V]
Nominal current	[A]
Connection capacity AWG	AWG
General data	
Stripping length	[mm]
Screw thread	
Tightening torque	[Nm]
Type of insulation material / insulation material group	
Inflammability class according to UL 94	

41 ¹⁾ / 10		
1000		
7.62		
0.2 - 10 / 0.2 - 6 / 24 - 10		
0.25 - 6		
0.25 - 4		
0.2 - 2.5 / 0.2 - 4		
0.25 - 1.5		
0.25 - 2.5		
III / 3	III / 2	II / 2
1000	1000	1000
8	8	6
B	C	D
600	600	-
41	41	-
24 - 8	24 - 8	-
B	C	D
-	-	-
-	-	-
-	-	-
10		
M3		
0.7 - 0.8		
PA / I		
V0		

Ordering data

Type	Order No.	Pcs. / Pkt.
Pitch 7.62 mm, color: green		
IPC 5/ 2-ST-7,62	1709047	50
IPC 5/ 3-ST-7,62	1709050	50
IPC 5/ 4-ST-7,62	1709063	50
IPC 5/ 5-ST-7,62	1709076	50
IPC 5/ 6-ST-7,62	1709089	50
IPC 5/ 7-ST-7,62	1709092	50
IPC 5/ 8-ST-7,62	1709102	50
IPC 5/ 9-ST-7,62	1709115	50
IPC 5/10-ST-7,62	1709128	50
IPC 5/11-ST-7,62	1709131	50
IPC 5/12-ST-7,62	1709144	50



With screw flange, 600 V UL approval



With threaded flange, 600 V UL approval



With Click and Lock system, compatible with STCL plugs, 600 V UL approval



Dimensional drawing

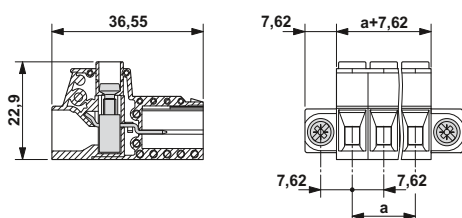

Dimensional drawing

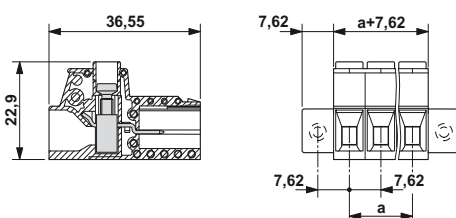

Dimensional drawing

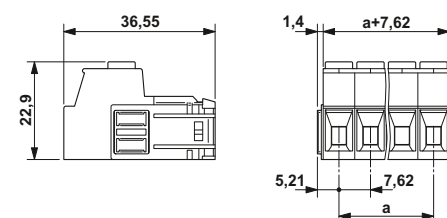

Representative derating curves of the above-mentioned plugs

Type: IPC 5/...-ST-7,62 with PC 5/...-ST1-7,62
Conductor cross section: 6 mm²

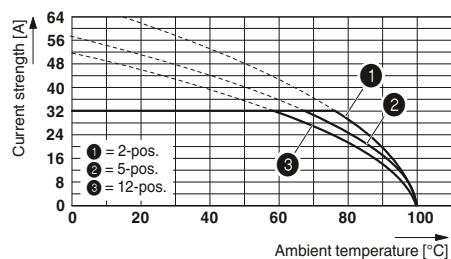

Type: IPC 5/...-ST-7,62 with IPC 5/...-G-7,62
Conductor cross section = 10 mm²

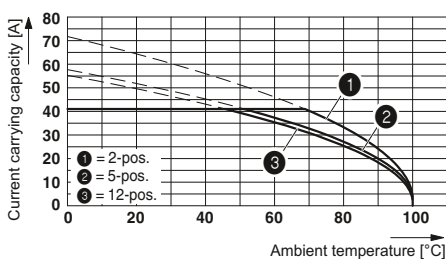

Type: IPC 5/...-ST-7,62 with IPC 5/...-G-7,62
Conductor cross section 6 mm²

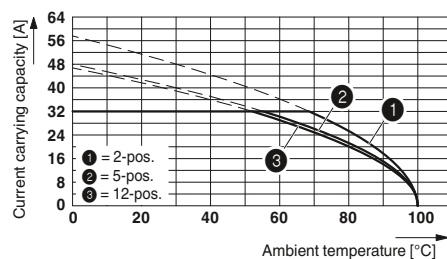

Ordering data

Type	Order No.	Pcs. / Pkt.
Pitch 7.62 mm, color: green		
IPC 5/ 2-STF-7,62	1709157	50
IPC 5/ 3-STF-7,62	1709160	50
IPC 5/ 4-STF-7,62	1709173	50
IPC 5/ 5-STF-7,62	1709186	50
IPC 5/ 6-STF-7,62	1709199	50
IPC 5/ 7-STF-7,62	1709209	50
IPC 5/ 8-STF-7,62	1709212	50
IPC 5/ 9-STF-7,62	1709225	50
IPC 5/10-STF-7,62	1709238	50
IPC 5/11-STF-7,62	1709241	50
IPC 5/12-STF-7,62	1709254	50

Ordering data

Type	Order No.	Pcs. / Pkt.
Pitch 7.62 mm, color: green		
IPC 5/ 2-STGF-7,62	1709267	50
IPC 5/ 3-STGF-7,62	1709270	50
IPC 5/ 4-STGF-7,62	1709283	50
IPC 5/ 5-STGF-7,62	1709296	50
IPC 5/ 6-STGF-7,62	1709306	50
IPC 5/ 7-STGF-7,62	1709319	50
IPC 5/ 8-STGF-7,62	1709322	50
IPC 5/ 9-STGF-7,62	1709335	50
IPC 5/10-STGF-7,62	1709348	50
IPC 5/11-STGF-7,62	1709351	50
IPC 5/12-STGF-7,62	1709364	50

Ordering data

Type	Order No.	Pcs. / Pkt.
Pitch 7.62 mm, color: green		
IPC 5/ 2-STGCL-7,62	1718261	50
IPC 5/ 3-STGCL-7,62	1718274	50
IPC 5/ 4-STGCL-7,62	1718287	50
IPC 5/ 5-STGCL-7,62	1718290	50
IPC 5/ 6-STGCL-7,62	1718300	50
IPC 5/ 7-STGCL-7,62	1718313	50
IPC 5/ 8-STGCL-7,62	1718326	50
IPC 5/ 9-STGCL-7,62	1718339	50
IPC 5/10-STGCL-7,62	1718342	50
IPC 5/11-STGCL-7,62	1718355	50
IPC 5/12-STGCL-7,62	1718368	50

Plug-in connectors for power electronics with 5.0 to 15.0 mm pitch

PC 5 series plug-in connectors up to 41 A/10 mm², pitch 7.62 mm

Plugs with screw connection, pin/socket contact

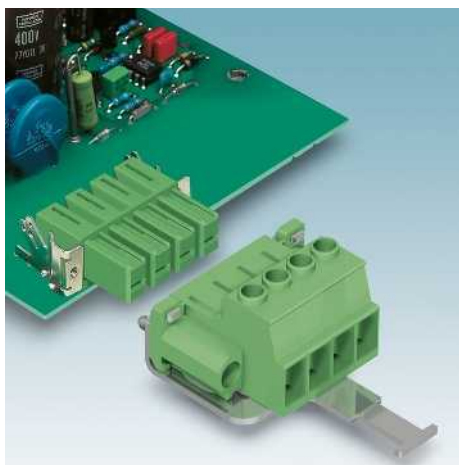

- The SH versions provide a professional EMC shield for adherence to the EMC requirements and an optional strain relief
- Unrestricted 600-V-UL approval
- Can be plugged into PC 5 plugs or inverted IPC 5 headers
- Increased vibration protection for cable/cable connections, thanks to screw-on STGF plugs

Notes:

In accordance with DIN EN 61984, COMBICON plug-in connectors have no switching power. During designated use, they must not be plugged in or disconnected when carrying voltage or under load.

COMBICON select



You will find the possible plug-in connector combinations in COMBICON select at: www.phoenixcontact.net/products or starting on page 486.

1) Please observe the derating curves and laboratory data sheets. Derating curves of further combination options on request.



With screw flange and shield,
600 V UL approval

Accessories

For all types	Type	Page
	Coding profile CP-PC RD Order No. 1701967	38
	Screwdriver SZK PZ 1 Order No. 1206450	
	Marker cards SK 7,62/3,8	799



Dimensional drawing

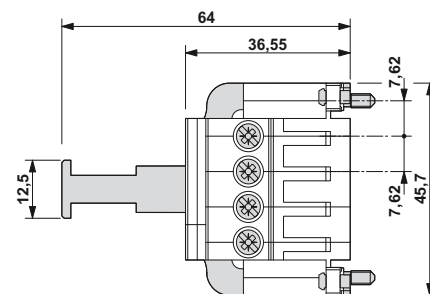

Note derating curves

Derating curves according to DIN EN 61984 (VDE 0627):2002-09
Representation based on DIN EN 60512-5-2:2003-01
Number of positions = see diagram

Technical data

Technical data in accordance to IEC / DIN VDE	
Rated current / conductor cross section	[A] / [mm ²]
Rated insulation voltage for pollution degree 2	[V]

Pitch	[mm]	7.62
Connection capacity		
Solid / stranded	[mm ²] / [mm ²] / AWG	0.2 - 10 / 0.2 - 6 / 24 - 10
Stranded with ferrules without plastic sleeve	[mm ²]	0.25 - 6
Stranded with ferrules with plastic sleeve	[mm ²]	0.25 - 4
Multi-conductor connection capacity (two conductors with the same cross section)		
Solid / stranded	[mm ²]	0.2 - 2.5 / 0.2 - 4
Stranded with ferrules without plastic sleeve	[mm ²]	0.25 - 1.5
Stranded with TWIN ferrule with plastic sleeve	[mm ²]	0.25 - 2.5

Insulation coordination	
Surge voltage category / pollution degree	III / 3 III / 2 II / 2
Rated insulation voltage	[V] 1000 1000 1000
Rated surge voltage	[kV] 8 8 6
Approval data (UL/CUL)	Use Group B C D
Nominal voltage	[V] 600 600 -
Nominal current	[A] 41 41 -
Connection capacity AWG	AWG 24 - 8 24 - 8 -
Approval data (CSA)	Use Group B C D
Nominal voltage	[V] - - -
Nominal current	[A] - - -
Connection capacity AWG	AWG - - -

General data	
Stripping length	[mm] 10
Screw thread	M3
Tightening torque	[Nm] 0.7 - 0.8
Type of insulation material / insulation material group	PA / I
Inflammability class according to UL 94	V0

No. of pos.	Dim. a [mm]
4	22.86

Ordering data

Type	Order No.	Pcs. / Pkt.
Pitch 7.62 mm, color: green		
IPC 5/ 4-STF-SH-7,62	1709380	50



With threaded flange and shield,
600 V UL approval



Dimensional drawing

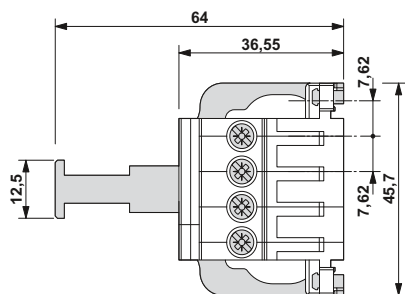

Representative derating curve

Type: IPC 5/...-ST-7,62 with PC 5/...-ST1-7,62
Conductor cross section: 6 mm²

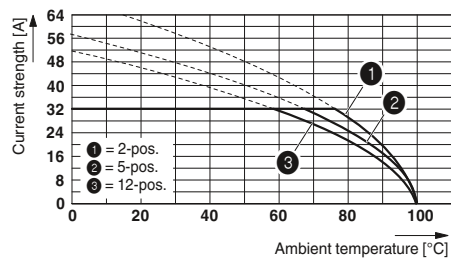

Ordering data

Type	Order No.	Pcs. / Pkt.
Pitch 7.62 mm, color: green		
IPC 5/ 4-STGF-SH-7,62	1709377	50

Plug-in connectors for power electronics with 5.0 to 15.0 mm pitch

PC 5 series plug-in connectors up to 41 A/10 mm², pitch 7.62 mm

Plugs with push-in spring connection, pin/socket contact

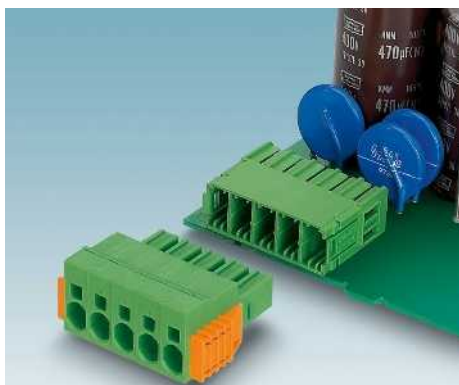

- Push-in spring connection with a current carrying capacity of 41 A
- Fast connection technology, thanks to principle of direct plug-in without tools
- Unrestricted 600-V-UL approval
- Maximum contact safety, thanks to an integrated double steel spring
- An automatic snap-on mechanism without tools with the Click and Lock system (-STCL); high degree of safety even in case of vibrations
- The SH versions provide a professional shield and an optional strain relief
- CP-PC RD coding profile

Notes:

In accordance with DIN EN 61984, COMBICON plug-in connectors have no switching power. During designated use, they must not be plugged in or disconnected when carrying voltage or under load.

COMBICON select

You will find the possible plug-in connector combinations in COMBICON select at: www.phoenixcontact.net/products or starting on page 486.

¹⁾ Please observe the derating curves and laboratory data sheets. Derating curves of further combination options on request.



Without screw flange, 600 V UL approval





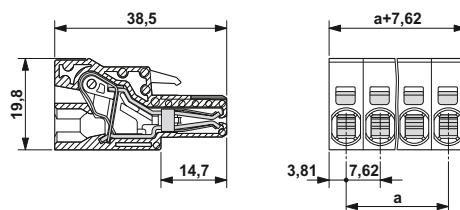

Dimensional drawing



Note derating curves

Derating curves, determined as per DIN EN 61984 (VDE 0627):2002-09
Representation based on DIN EN 60512-5-2:2003-01
Reduction factor = 0.8
No. of positions: See diagram

Accessories

For all types	Type	Page
	Coding profile CP-PC RD Order No. 1701967	38
	Screwdriver SZF 1-0,6 x 3,5 Order No. 1204517	
	Marker cards SK 7,62/3,8	799
	Ferrules with and without plastic sleeve	834
	Crimping pliers for 0.25 to 6 mm ² CRIMPFox 6 Order No. 1212034	

Technical data

Technical data in accordance to IEC / DIN VDE	
Rated current / conductor cross section	[A] / [mm ²]
Rated insulation voltage for pollution degree 2	[V]
Pitch	[mm]
Connection capacity	
Solid / stranded	[mm ²] / [mm ²] / AWG
Stranded with ferrules without plastic sleeve	[mm ²]
Stranded with ferrules with plastic sleeve	[mm ²]
Multi-conductor connection capacity (two conductors with the same cross section)	
Solid / stranded	[mm ²]
Stranded with ferrules without plastic sleeve	[mm ²]
Stranded with TWIN ferrule with plastic sleeve	[mm ²]
Insulation coordination	
Surge voltage category / pollution degree	
Rated insulation voltage	[V]
Rated surge voltage	[kV]
Approval data (UL/CUL)	Use Group
Nominal voltage	[V]
Nominal current	[A]
Connection capacity AWG	AWG
Approval data (CSA)	Use Group
Nominal voltage	[V]
Nominal current	[A]
Connection capacity AWG	AWG
General data	
Stripping length	[mm]
Type of insulation material / insulation material group	
Inflammability class according to UL 94	

41 ¹⁾ / 10		
1000		
7.62		
0.2 - 10 / 0.2 - 6 / 24 - 8		
0.25 - 6		
0.25 - 4		
- / -		
-		
0.25 - 1.5		
III / 3	III / 2	II / 2
1000	1000	1000
8	8	6
B	C	D
600	600	-
35	35	-
24 - 8	24 - 8	-
B	C	D
-	-	-
-	-	-
-	-	-
15		
PA / I		
V0		

Ordering data

No. of pos.	Dim. a [mm]	Type	Order No.	Pcs. / Pkt.
Pitch 7.62 mm, color: green				
2	7.62	SPC 5/ 2-ST-7,62	1996016	50
3	15.24	SPC 5/ 3-ST-7,62	1996029	50
4	22.86	SPC 5/ 4-ST-7,62	1996032	50
5	30.48	SPC 5/ 5-ST-7,62	1996045	50
6	38.10	SPC 5/ 6-ST-7,62	1996058	50
7	45.72	SPC 5/ 7-ST-7,62	1996061	50
8	53.34	SPC 5/ 8-ST-7,62	1996074	50
9	60.96	SPC 5/ 9-ST-7,62	1996087	50
10	68.58	SPC 5/10-ST-7,62	1996090	50
11	76.20	SPC 5/11-ST-7,62	1996100	50
12	83.82	SPC 5/12-ST-7,62	1996113	50

Plug-in connectors for power electronics with 5.0 to 15.0 mm pitch

PC 5 series plug-in connectors up to 41 A/10 mm², pitch 7.62 mm



With screw flange, 600 V UL approval



With screw flange and shield, 600 V UL approval



With Click and Lock system, compatible with PC 5 headers and STGCL plug components, 600 V UL approval



Dimensional drawing

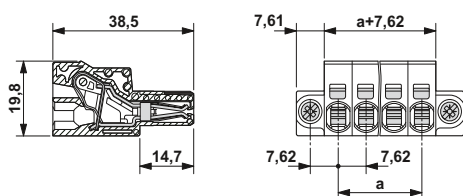

Dimensional drawing

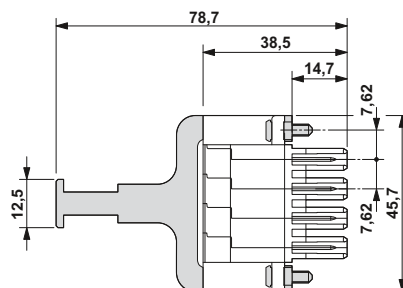

Dimensional drawing

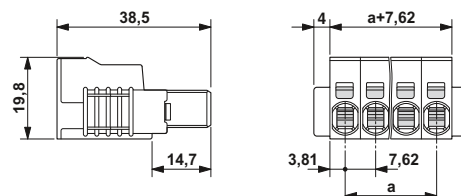

Representative derating curves of the above-mentioned plugs

Type: SPC 5/...-ST-7,62 with PC 5/...-G-7,62
Conductor cross section: 10 mm²

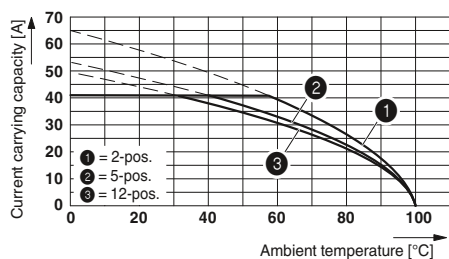

Type: SPC 5/...-ST-7,62 with PC 5/...-G-7,62
Conductor cross section: 6 mm²

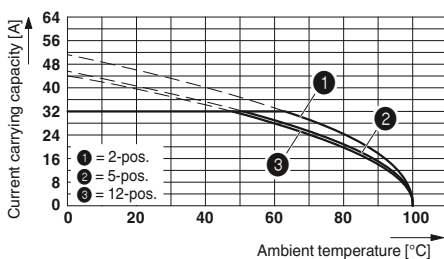

Ordering data

Type	Order No.	Pcs. / Pkt.
Pitch 7.62 mm, color: green		
SPC 5/ 2-STF-7,62	1996126	50
SPC 5/ 3-STF-7,62	1996139	50
SPC 5/ 4-STF-7,62	1996142	50
SPC 5/ 5-STF-7,62	1996155	50
SPC 5/ 6-STF-7,62	1996168	50
SPC 5/ 7-STF-7,62	1996171	50
SPC 5/ 8-STF-7,62	1996184	50
SPC 5/ 9-STF-7,62	1996197	50
SPC 5/10-STF-7,62	1996207	50
SPC 5/11-STF-7,62	1996210	50
SPC 5/12-STF-7,62	1996223	50

Ordering data

Type	Order No.	Pcs. / Pkt.
Pitch 7.62 mm, color: green		
SPC 5/ 4-STF-SH-7,62	1704071	50

Ordering data

Type	Order No.	Pcs. / Pkt.
Pitch 7.62 mm, color: green		
SPC 5/ 2-STCL-7,62	1718481	50
SPC 5/ 3-STCL-7,62	1718494	50
SPC 5/ 4-STCL-7,62	1718504	50
SPC 5/ 5-STCL-7,62	1718517	50
SPC 5/ 6-STCL-7,62	1718520	50
SPC 5/ 7-STCL-7,62	1718533	50
SPC 5/ 8-STCL-7,62	1718546	50
SPC 5/ 9-STCL-7,62	1718559	50
SPC 5/10-STCL-7,62	1718562	50
SPC 5/11-STCL-7,62	1718575	50
SPC 5/12-STCL-7,62	1718588	50

Plug-in connectors for power electronics with 5.0 to 15.0 mm pitch

PC 5 series plug-in connectors up to 41 A/10 mm², pitch 7.62 mm

Plugs with push-in spring connection, pin/socket contact



- Push-in spring connection with TWIN connection
- Simple potential distribution through two terminal points per contact
- Fast connection technology, thanks to principle of direct plug-in without tools
- Unrestricted 600-V-UL approval
- Maximum contact safety, thanks to an integrated double steel spring
- An automatic snap-on mechanism without tools with the Click and Lock system (-STCL); high degree of safety even in case of vibrations
- Further features: screw flange (-STF)
- CP-PC RD coding profile

Notes:

In accordance with DIN EN 61984, COMBICON plug-in connectors have no switching power. During designated use, they must not be plugged in or disconnected when carrying voltage or under load.

COMBICON select

You will find the possible plug-in connector combinations in COMBICON select at: www.phoenixcontact.net/products or starting on page 486.

¹⁾ Please observe the derating curves and laboratory data sheets. Derating curves of further combination options on request.



Without screw flange, 600 V UL approval



Dimensional drawing

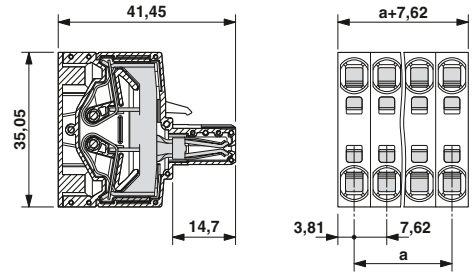

Note derating curves

Derating curves, determined as per DIN EN 61984 (VDE 0627):2002-09
Representation based on DIN EN 60512-5-2:2003-01
Connected conductor cross section = 10 mm²
Reduction factor = 0.8
Number of positions = see diagram

Accessories

For all types	Type	Page
	Screwdriver SZF 1-0,6 x 3,5 Order No. 1204517	
	Coding profile CP-PC RD Order No. 1701967	38
	Marker cards SK 7,62/3,8	799
	Ferrules with and without plastic sleeve	834
	Crimping pliers for 0.25 to 6 mm ² CRIMPFOX 6 Order No. 1212034	

Technical data

Technical data in accordance to IEC / DIN VDE	
Rated current / conductor cross section	[A] / [mm ²]
Rated insulation voltage for pollution degree 2	[V]
Pitch	[mm]
Connection capacity	
Solid / stranded	[mm ²] / [mm ²] / AWG
Stranded with ferrules without plastic sleeve	[mm ²]
Stranded with ferrules with plastic sleeve	[mm ²]
Multi-conductor connection capacity (two conductors with the same cross section)	
Solid / stranded	[mm ²]
Stranded with ferrules without plastic sleeve	[mm ²]
Stranded with TWIN ferrule with plastic sleeve	[mm ²]
Insulation coordination	
Surge voltage category / pollution degree	
Rated insulation voltage	[V]
Rated surge voltage	[kV]
Approval data (UL/CUL)	Use Group
Nominal voltage	[V]
Nominal current	[A]
Connection capacity AWG	AWG
Approval data (CSA)	Use Group
Nominal voltage	[V]
Nominal current	[A]
Connection capacity AWG	AWG
General data	
Stripping length	[mm]
Type of insulation material / insulation material group	
Inflammability class according to UL 94	

41 ¹⁾ / 10		
1000		
7.62		
0.2 - 10 / 0.2 - 6 / 24 - 8		
0.25 - 6		
0.25 - 4		
- / -		
-		
0.25 - 1.5		
III / 3	III / 2	II / 2
1000	1000	1000
8	8	6
B	C	D
600	600	-
31	31	-
24 - 8	24 - 8	-
B	C	D
-	-	-
-	-	-
-	-	-
15		
PA / I		
V0		

Ordering data

No. of pos.	Dim. a [mm]	Type	Order No.	Pcs. / Pkt.
Pitch 7.62 mm, color: green				
2	7.62	TSPC 5/ 2-ST-7,62	1728455	50
3	15.24	TSPC 5/ 3-ST-7,62	1728468	50
4	22.86	TSPC 5/ 4-ST-7,62	1728471	50
5	30.48	TSPC 5/ 5-ST-7,62	1728484	50
6	38.10	TSPC 5/ 6-ST-7,62	1728497	25
7	45.72	TSPC 5/ 7-ST-7,62	1728507	25
8	53.34	TSPC 5/ 8-ST-7,62	1728510	25
9	60.96	TSPC 5/ 9-ST-7,62	1728523	25
10	68.58	TSPC 5/10-ST-7,62	1728536	25
11	76.20	TSPC 5/11-ST-7,62	1728549	25
12	83.82	TSPC 5/12-ST-7,62	1728552	25



With screw flange, 600 V UL approval



With Click and Lock system, compatible with PC 5 headers and STGCL plug components, 600 V UL approval



Dimensional drawing

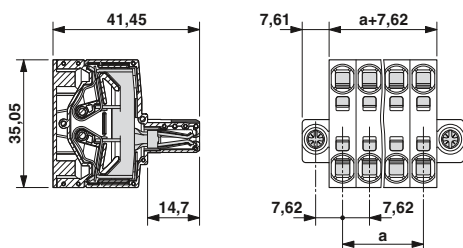

Dimensional drawing

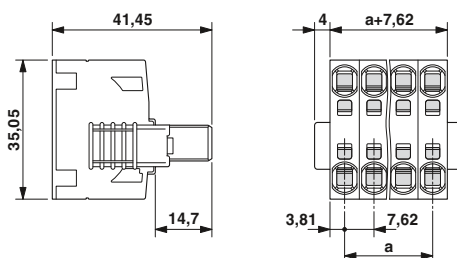

Representative derating curve

Type: TSPC 5/...-ST-7,62 with PC 5/...-G-7,62

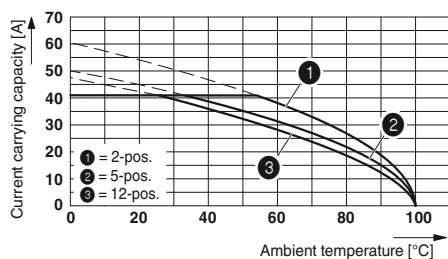

Ordering data

Type	Order No.	Pcs. / Pkt.
Pitch 7.62 mm, color: green		
TSPC 5/ 2-STF-7,62	1728206	50
TSPC 5/ 3-STF-7,62	1728219	50
TSPC 5/ 4-STF-7,62	1728222	50
TSPC 5/ 5-STF-7,62	1728235	50
TSPC 5/ 6-STF-7,62	1728248	25
TSPC 5/ 7-STF-7,62	1728251	25
TSPC 5/ 8-STF-7,62	1728264	25
TSPC 5/ 9-STF-7,62	1728277	25
TSPC 5/10-STF-7,62	1728280	25
TSPC 5/11-STF-7,62	1728293	25
TSPC 5/12-STF-7,62	1728303	25

Ordering data

Type	Order No.	Pcs. / Pkt.
Pitch 7.62 mm, color: green		
TSPC 5/ 2-STCL-7,62	1765418	10
TSPC 5/ 3-STCL-7,62	1765421	10
TSPC 5/ 4-STCL-7,62	1765434	10
TSPC 5/ 5-STCL-7,62	1765447	10
TSPC 5/ 6-STCL-7,62	1765450	10
TSPC 5/ 7-STCL-7,62	1765463	10
TSPC 5/ 8-STCL-7,62	1765476	10
TSPC 5/ 9-STCL-7,62	1765489	10
TSPC 5/10-STCL-7,62	1765492	10
TSPC 5/11-STCL-7,62	1765502	10
TSPC 5/12-STCL-7,62	1765515	10

Plug-in connectors for power electronics with 5.0 to 15.0 mm pitch

PC 5 series plug-in connectors up to 41 A/10 mm², pitch 7.62 mm

Plugs with push-in spring connection, pin/socket contact



- Inverted ISPC 5 push-in spring connection plugs with pin contact for touch-proof device outputs (with IPC 5 G) or free-hanging cable/cable connections (with SPC 5 ST)
- Unrestricted 600-V-UL approval
- Increased vibration protection, thanks to screw-on STF plug with screw flange
- STGF plug with threaded flange

Notes:

In accordance with DIN EN 61984, COMBICON plug-in connectors have no switching power. During designated use, they must not be plugged in or disconnected when carrying voltage or under load.

COMBICON select

You will find the possible plug-in connector combinations in COMBICON select at: www.phoenixcontact.net/products or starting on page 486.

¹⁾ Please observe the derating curves and laboratory data sheets. Derating curves of further combination options on request.



With Click and Lock system, compatible with STCL plugs, 600 V UL approval



Dimensional drawing

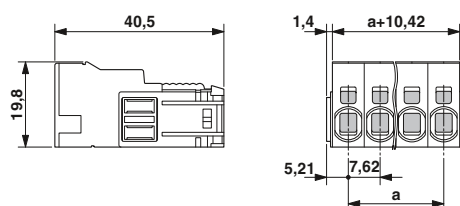

Note derating curves

Derating curves, determined as per DIN EN 61984 (VDE 0627):2002-09
Representation based on DIN EN 60512-5-2:2003-01
Connected conductor cross section = 6 mm²
Reduction factor = 0.8
Number of positions = see diagram

Accessories

For all types	Type	Page
	Coding profile CP-PC RD Order No. 1701967	38
	Screwdriver SZF 1-0,6 x 3,5 Order No. 1204517	
	Marker cards SK 7,62/3,8	799
	Ferrules with and without plastic sleeve	834
	Crimping pliers for 0.25 to 6 mm ² CRIMPFOX 6 Order No. 1212034	

Technical data

Technical data in accordance to IEC / DIN VDE	
Rated current / conductor cross section	[A] / [mm ²]
Rated insulation voltage for pollution degree 2	[V]
Pitch	[mm]
Connection capacity	
Solid / stranded	[mm ²] / [mm ²] / AWG
Stranded with ferrules without plastic sleeve	[mm ²]
Stranded with ferrules with plastic sleeve	[mm ²]
Multi-conductor connection capacity (two conductors with the same cross section)	
Solid / stranded	[mm ²]
Stranded with ferrules without plastic sleeve	[mm ²]
Stranded with TWIN ferrule with plastic sleeve	[mm ²]
Insulation coordination	
Surge voltage category / pollution degree	
Rated insulation voltage	[V]
Rated surge voltage	[kV]
Approval data (UL/CUL)	Use Group
Nominal voltage	[V]
Nominal current	[A]
Connection capacity AWG	AWG
Approval data (CSA)	Use Group
Nominal voltage	[V]
Nominal current	[A]
Connection capacity AWG	AWG
General data	
Stripping length	[mm]
Type of insulation material / insulation material group	
Inflammability class according to UL 94	

41 ¹⁾ / 10		
1000		
7.62		
0.2 - 10 / 0.2 - 6 / 24 - 8		
0.25 - 6		
0.25 - 4		
- / -		
-		
0.25 - 1.5		
III / 3	III / 2	II / 2
1000	1000	1000
8	8	6
B	C	D
600	600	-
35	35	-
24 - 8	24 - 8	-
B	C	D
-	-	-
-	-	-
-	-	-
15		
PA / I		
V0		

Ordering data

Type	Order No.	Pcs. / Pkt.
Pitch 7.62 mm, color: green		
No. of pos.	Dim. a [mm]	
2	7.62	
3	15.24	
4	22.86	
5	30.48	
6	38.10	
7	45.72	
8	53.34	
9	60.96	
10	68.58	
11	76.20	
12	83.82	
ISPC 5/ 2-STGCL-7,62	1748862	50
ISPC 5/ 3-STGCL-7,62	1748875	50
ISPC 5/ 4-STGCL-7,62	1748888	50
ISPC 5/ 5-STGCL-7,62	1748891	50
ISPC 5/ 6-STGCL-7,62	1748901	50
ISPC 5/ 7-STGCL-7,62	1748914	50
ISPC 5/ 8-STGCL-7,62	1748927	50
ISPC 5/ 9-STGCL-7,62	1748930	50
ISPC 5/10-STGCL-7,62	1748943	50
ISPC 5/11-STGCL-7,62	1748956	50
ISPC 5/12-STGCL-7,62	1748969	50



With screw flange, 600 V UL approval



With threaded flange, 600 V UL approval



Dimensional drawing

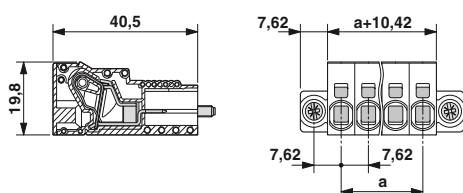

Dimensional drawing

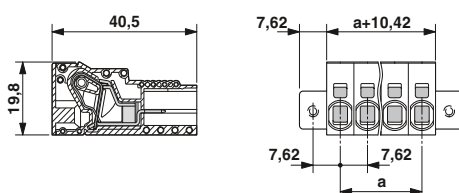

Representative derating curves of the above-mentioned plugs

Type: ISPC 5/...-STGCL-7,62 with IPC 5/...-G-7,62

Type: ISPC 5/...-STGCL-7,62 with IPCV 5/...-G-7,62

Type: ISPC 5/...-STGCL-7,62 with SPC 5/...-ST-7,62

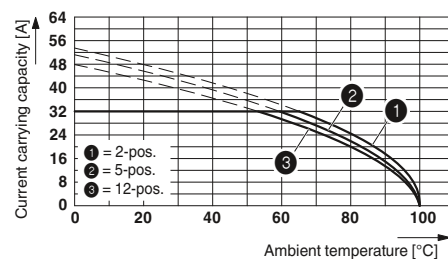
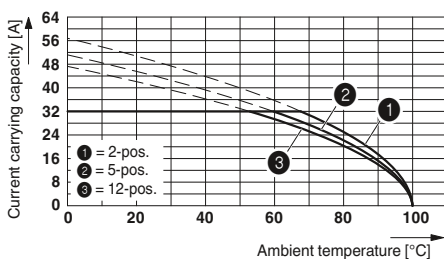
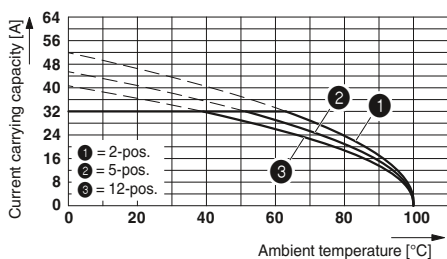

Ordering data

Type	Order No.	Pcs. / Pkt.
Pitch 7.62 mm, color: green		
ISPC 5/ 2-STF-7,62	1748972	50
ISPC 5/ 3-STF-7,62	1748985	50
ISPC 5/ 4-STF-7,62	1748998	50
ISPC 5/ 5-STF-7,62	1749007	50
ISPC 5/ 6-STF-7,62	1749010	50
ISPC 5/ 7-STF-7,62	1749023	50
ISPC 5/ 8-STF-7,62	1749036	50
ISPC 5/ 9-STF-7,62	1749049	50
ISPC 5/10-STF-7,62	1749052	50
ISPC 5/11-STF-7,62	1749065	50
ISPC 5/12-STF-7,62	1749078	50

Ordering data

Type	Order No.	Pcs. / Pkt.
Pitch 7.62 mm, color: green		
ISPC 5/ 2-STGF-7,62	1749201	50
ISPC 5/ 3-STGF-7,62	1749214	50
ISPC 5/ 4-STGF-7,62	1749227	50
ISPC 5/ 5-STGF-7,62	1749230	50
ISPC 5/ 6-STGF-7,62	1749243	50
ISPC 5/ 7-STGF-7,62	1749256	50
ISPC 5/ 8-STGF-7,62	1749269	50
ISPC 5/ 9-STGF-7,62	1749272	50
ISPC 5/10-STGF-7,62	1749285	50
ISPC 5/11-STGF-7,62	1749298	50
ISPC 5/12-STGF-7,62	1749308	50

Plug-in connectors for power electronics with 5.0 to 15.0 mm pitch

PC 5 series plug-in connectors up to 41 A/10 mm², pitch 7.62 mm

Headers with pin contact

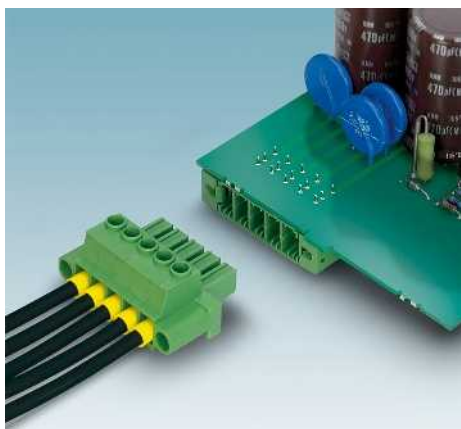

- PC 5 headers for use in combination with PC 5 plugs
- If the GU headers are used, the plug is rotated by 180° before fitting
- Vibration-resistant connection with a threaded flange (-GF; also for screw connection in the device)
- Compatible with the Click and Lock system
- Shroud PCB-SHIELD for a professional EMC shield connection
- CP-PC RD coding profile as protection against mismatching
- Suitable for 600 V UL when used in combination with PC 5 screw or spring-cage plugs

Notes:

In accordance with DIN EN 61984, COMBICON plug-in connectors have no switching power. During designated use, they must not be plugged in or disconnected when carrying voltage or under load.

COMBICON select

You will find the possible plug-in connector combinations in COMBICON select at: www.phoenixcontact.net/products or starting on page 486.



Mounting screw for PC 5/...-GF-7,62 and PC 5/...-GFU-7,62: sheet metal screw ISO 1481-ST 2,9 C. Screw connection only permitted prior to soldering.

1) Please observe the derating curves and laboratory data sheets. Derating curves of further combination options on request.



Compatible with STCL plugs

Accessories

For all types	Type	Page
	Coding profile CP-PC RD Order No. 1701967	38
	Marker cards SK 7,62/3,8	799
Only for PC 5/...-G-7,62 and PC 5/...-GU-7,62		
	Shroud POWER COMBICON PCB-SHIELD Order No. 1968387	



Dimensional drawing

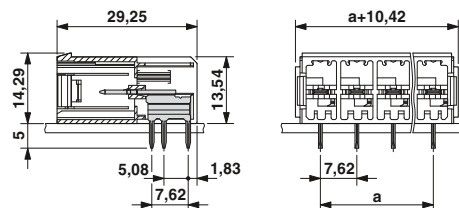

Drilling diagram

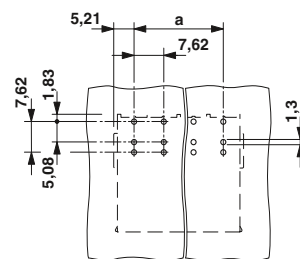

Technical data

Technical data in accordance to IEC / DIN VDE

Rated current	[A]	41 ¹⁾
Rated insulation voltage for pollution degree 2	[V]	630
Pitch	[mm]	7.62
Insulation coordination		
Surge voltage category / pollution degree		III / 3 III / 2 II / 2
Rated insulation voltage	[V]	630 630 1000
Rated surge voltage	[kV]	6 6 6
Approval data (UL/CUL)	Use Group	B C D
Nominal voltage	[V]	300 150 300
Nominal current	[A]	41 41 10
Connection capacity AWG	AWG	- - -
Approval data (CSA)	Use Group	B C D
Nominal voltage	[V]	- - -
Nominal current	[A]	- - -
Connection capacity AWG	AWG	- - -
General data		
Type of insulation material / insulation material group		PA / I
Inflammability class according to UL 94		V0
Drill hole diameter / pin dimensions	[mm]	1.3 / 0.8 x 1.0

No. of pos.	Dim. a [mm]
2	7.62
3	15.24
4	22.86
5	30.48
6	38.10
7	45.72
8	53.34
9	60.96
10	68.58
11	76.20
12	83.82

Ordering data

Type	Order No.	Pcs. / Pkt.
Pitch 7.62 mm, color: green		
PC 5/ 2-G-7,62	1720466	50
PC 5/ 3-G-7,62	1720479	50
PC 5/ 4-G-7,62	1720482	50
PC 5/ 5-G-7,62	1720495	50
PC 5/ 6-G-7,62	1720505	50
PC 5/ 7-G-7,62	1720518	50
PC 5/ 8-G-7,62	1720521	50
PC 5/ 9-G-7,62	1720534	50
PC 5/10-G-7,62	1720547	50
PC 5/11-G-7,62	1720550	50
PC 5/12-G-7,62	1720563	50

Plug-in connectors for power electronics with 5.0 to 15.0 mm pitch

PC 5 series plug-in connectors up to 41 A/10 mm², pitch 7.62 mm



With threaded flange



Rotated 180°, compatible with STCL plugs



Rotated 180°, with threaded flange



Dimensional drawing

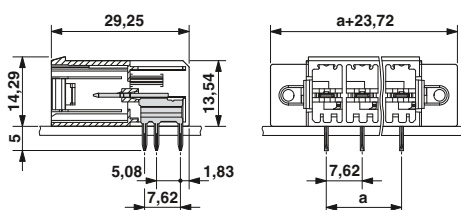

Drilling diagram

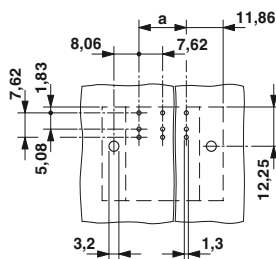

Ordering data

Type	Order No.	Pcs. / Pkt.
Pitch 7.62 mm, color: green		
PC 5/ 2-GF-7,62	1720796	50
PC 5/ 3-GF-7,62	1720806	50
PC 5/ 4-GF-7,62	1720819	50
PC 5/ 5-GF-7,62	1720822	50
PC 5/ 6-GF-7,62	1720835	50
PC 5/ 7-GF-7,62	1720848	50
PC 5/ 8-GF-7,62	1720851	50
PC 5/ 9-GF-7,62	1720864	50
PC 5/10-GF-7,62	1720877	50
PC 5/11-GF-7,62	1720880	50
PC 5/12-GF-7,62	1720893	50



Dimensional drawing

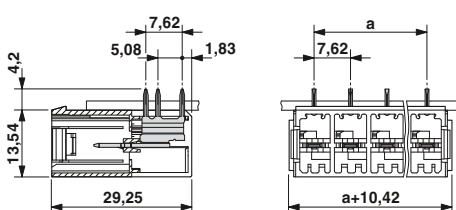

Drilling diagram

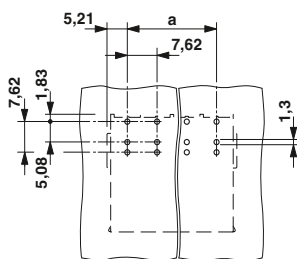

Ordering data

Type	Order No.	Pcs. / Pkt.
Pitch 7.62 mm, color: green		
PC 5/ 2-GU-7,62	1720686	50
PC 5/ 3-GU-7,62	1720699	50
PC 5/ 4-GU-7,62	1720709	50
PC 5/ 5-GU-7,62	1720712	50
PC 5/ 6-GU-7,62	1720725	50
PC 5/ 7-GU-7,62	1720738	50
PC 5/ 8-GU-7,62	1720741	50
PC 5/ 9-GU-7,62	1720754	50
PC 5/10-GU-7,62	1720767	50
PC 5/11-GU-7,62	1720770	50
PC 5/12-GU-7,62	1720783	50



Dimensional drawing

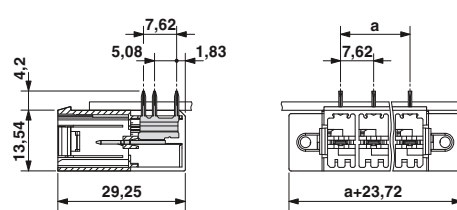

Drilling diagram

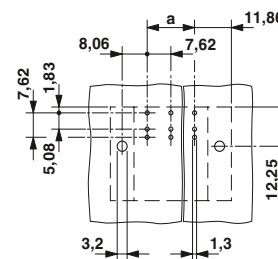

Ordering data

Type	Order No.	Pcs. / Pkt.
Pitch 7.62 mm, color: green		
PC 5/ 2-GFU-7,62	1721012	50
PC 5/ 3-GFU-7,62	1721025	50
PC 5/ 4-GFU-7,62	1721038	50
PC 5/ 5-GFU-7,62	1721041	50
PC 5/ 6-GFU-7,62	1721054	50
PC 5/ 7-GFU-7,62	1721067	50
PC 5/ 8-GFU-7,62	1721070	50
PC 5/ 9-GFU-7,62	1721083	50
PC 5/10-GFU-7,62	1721096	50
PC 5/11-GFU-7,62	1721106	50
PC 5/12-GFU-7,62	1721119	50

Plug-in connectors for power electronics with 5.0 to 15.0 mm pitch

PC 5 series plug-in connectors up to 41 A/10 mm², pitch 7.62 mm

Headers with pin contact

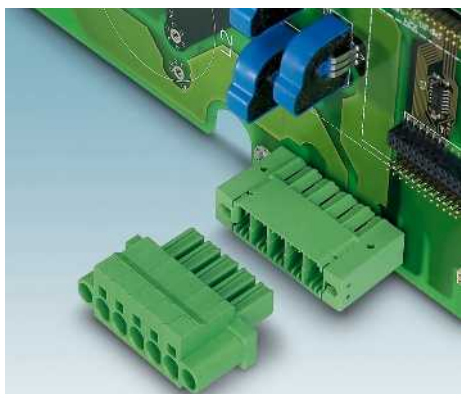

- Vertical PC 5 headers for use in combination with PC 5 plugs
- Available with 2 to 12-pos.
- Vibration-resistant connection with a threaded flange (-GF; also for screw connection in the device)
- Compatible with the Click and Lock system
- Asymmetrical layout of solder pins to avoid incorrect plugging-in
- Suitable for 600 V UL when used in combination with PC 5 screw or spring-cage plugs

Notes:

In accordance with DIN EN 61984, COMBICON plug-in connectors have no switching power. During designated use, they must not be plugged in or disconnected when carrying voltage or under load.

COMBICON select

You will find the possible plug-in connector combinations in COMBICON select at: www.phoenixcontact.net/products or starting on page 486.

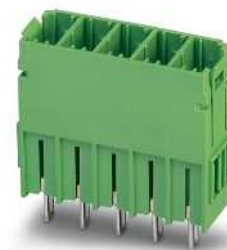

Mounting screw for PCV 5/...-GF-7,62: sheet metal screw ISO 1481-ST 2,9 C. Screw connection only permitted prior to soldering.

¹⁾ Please observe the derating curves and laboratory data sheets. Derating curves of further combination options on request.



Compatible with STCL plugs

Accessories

For all types	Type	Page
	Coding profile CP-PC RD Order No. 1701967	38
	Marker cards SK 7,62/3,8	799



Dimensional drawing

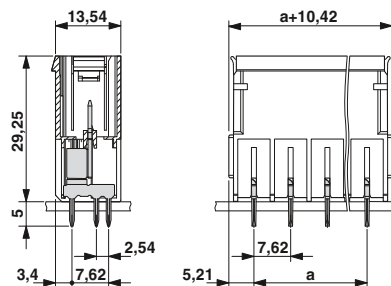

Drilling diagram

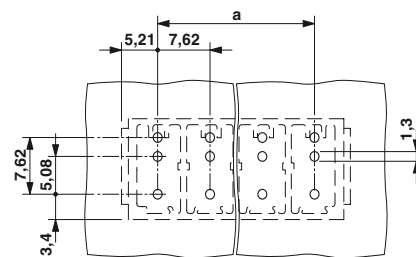

Technical data

Technical data in accordance to IEC / DIN VDE

Rated current	[A]	41 ¹⁾
Rated insulation voltage for pollution degree 2	[V]	630
Pitch	[mm]	7.62
Insulation coordination		
Surge voltage category / pollution degree		III / 3 III / 2 II / 2
Rated insulation voltage	[V]	630 630 1000
Rated surge voltage	[kV]	6 6 6
Approval data (UL/CUL)	Use Group	B C D
Nominal voltage	[V]	300 150 300
Nominal current	[A]	41 41 10
Connection capacity AWG	AWG	- - -
Approval data (CSA)	Use Group	B C D
Nominal voltage	[V]	- - -
Nominal current	[A]	- - -
Connection capacity AWG	AWG	- - -
General data		
Type of insulation material / insulation material group		PA / I
Inflammability class according to UL 94		V0
Drill hole diameter / pin dimensions	[mm]	1.3 / 0.8 x 1.0

Ordering data

No. of pos.	Dim. a [mm]	Type	Order No.	Pcs. / Pkt.
		Pitch 7.62 mm, color: green		
2	7.62	PCV 5/ 2-G-7,62	1720576	50
3	15.24	PCV 5/ 3-G-7,62	1720589	50
4	22.86	PCV 5/ 4-G-7,62	1720592	50
5	30.48	PCV 5/ 5-G-7,62	1720602	50
6	38.10	PCV 5/ 6-G-7,62	1720615	50
7	45.72	PCV 5/ 7-G-7,62	1720628	50
8	53.34	PCV 5/ 8-G-7,62	1720631	50
9	60.96	PCV 5/ 9-G-7,62	1720644	50
10	68.58	PCV 5/10-G-7,62	1720657	50
11	76.20	PCV 5/11-G-7,62	1720660	50
12	83.82	PCV 5/12-G-7,62	1720673	50

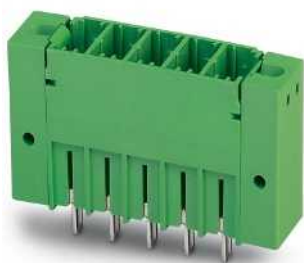

With threaded flange



Dimensional drawing

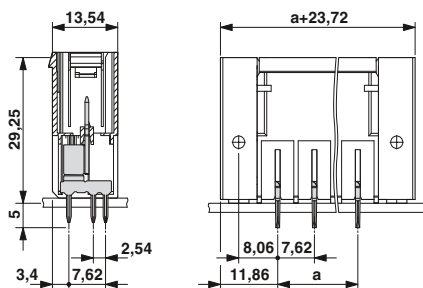

Drilling diagram

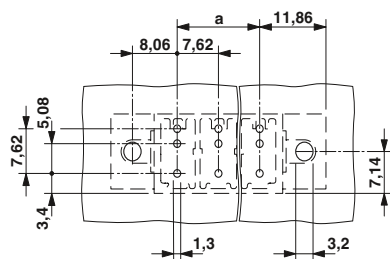

Ordering data

Type	Order No.	Pcs. / Pkt.
Pitch 7.62 mm, color: green		
PCV 5/ 2-GF-7,62	1720903	50
PCV 5/ 3-GF-7,62	1720916	50
PCV 5/ 4-GF-7,62	1720929	50
PCV 5/ 5-GF-7,62	1720932	50
PCV 5/ 6-GF-7,62	1720945	50
PCV 5/ 7-GF-7,62	1720958	50
PCV 5/ 8-GF-7,62	1720961	50
PCV 5/ 9-GF-7,62	1720974	50
PCV 5/10-GF-7,62	1720987	50
PCV 5/11-GF-7,62	1720990	50
PCV 5/12-GF-7,62	1721009	50

Plug-in connectors for power electronics with 5.0 to 15.0 mm pitch

PC 5 series plug-in connectors up to 41 A/10 mm², pitch 7.62 mm

Headers with socket contact

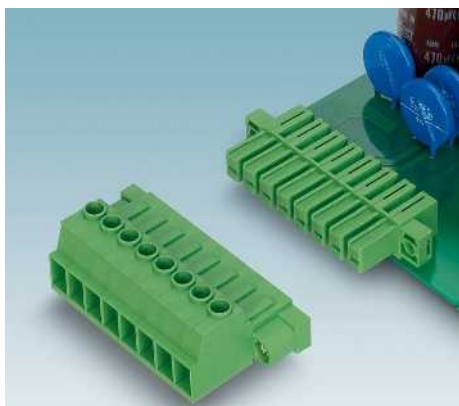

- An inverted IPC 5 header to implement a touch-proof PCB output or a PCB-PCB connection (in combination with PC 5 base strips)
- Maximum contact safety, thanks to an integrated double steel spring
- GU versions for a solder-in direction rotated by 180°
- Shroud PCB-SHIELD for a professional EMC shield connection
- Suitable for 600 V UL when used in combination with IPC 5 screw and spring-cage plugs

Notes:

In accordance with DIN EN 61984, COMBICON plug-in connectors have no switching power. During designated use, they must not be plugged in or disconnected when carrying voltage or under load.

COMBICON select



You will find the possible plug-in connector combinations in COMBICON select at: www.phoenixcontact.net/products or starting on page 486.

¹⁾ Please observe the derating curves and laboratory data sheets. Derating curves of further combination options on request.



Without threaded flange

Accessories

For all types	Type	Page
	Coding profile CP-PC RD Order No. 1701967	38
	Marker cards SK 7,62/3,8	799
Only for IPC 5/...-G-7,62 and IPC 5/...-GU-7,62		
	Shroud POWER COMBICON PCB-SHIELD Order No. 1968387	

UL

Dimensional drawing

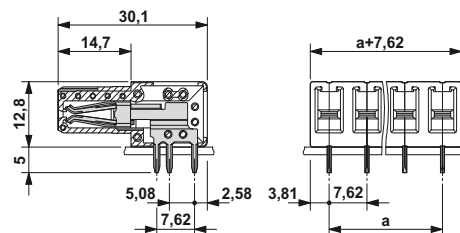

Drilling diagram

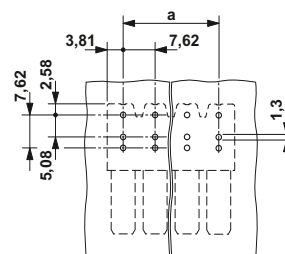

Technical data

Technical data in accordance to IEC / DIN VDE

Rated current	[A]	41 ¹⁾
Rated insulation voltage for pollution degree 2	[V]	630
Pitch	[mm]	7.62
Insulation coordination		
Surge voltage category / pollution degree		III / 3 III / 2 II / 2
Rated insulation voltage	[V]	630 630 1000
Rated surge voltage	[kV]	6 6 6
Approval data (UL/CUL)	Use Group	B C D
Nominal voltage	[V]	300 300 600
Nominal current	[A]	41 41 5
Connection capacity AWG	AWG	- - -
Approval data (CSA)	Use Group	B C D
Nominal voltage	[V]	- - -
Nominal current	[A]	- - -
Connection capacity AWG	AWG	- - -
General data		
Type of insulation material / insulation material group		PA / I
Inflammability class according to UL 94		V0
Drill hole diameter / pin dimensions	[mm]	1.3 / 1.2 x 0.8

No. of pos.	Dim. a [mm]
2	7.62
3	15.24
4	22.86
5	30.48
6	38.10
7	45.72
8	53.34
9	60.96
10	69.58
11	76.20
12	83.82

Ordering data

Type	Order No.	Pcs. / Pkt.
Pitch 7.62 mm, color: green		
IPC 5/ 2-G-7,62	1708381	50
IPC 5/ 3-G-7,62	1708394	50
IPC 5/ 4-G-7,62	1708404	50
IPC 5/ 5-G-7,62	1708417	50
IPC 5/ 6-G-7,62	1708420	50
IPC 5/ 7-G-7,62	1708433	50
IPC 5/ 8-G-7,62	1708446	50
IPC 5/ 9-G-7,62	1708459	50
IPC 5/10-G-7,62	1708462	50
IPC 5/11-G-7,62	1708475	50
IPC 5/12-G-7,62	1708488	50



With threaded flange



Rotated 180°, without threaded flange



Rotated 180°, with threaded flange



Dimensional drawing

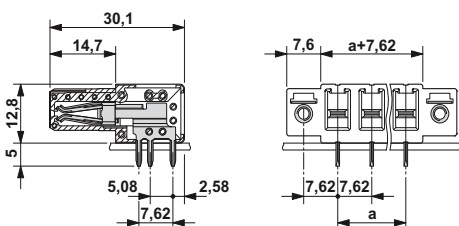

Drilling diagram

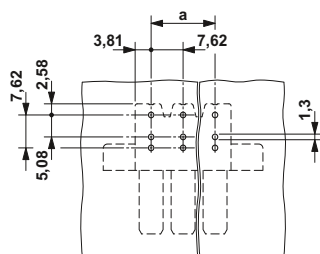

Ordering data

Type	Order No.	Pcs. / Pkt.
Pitch 7.62 mm, color: green		
IPC 5/ 2-GF-7,62	1708491	50
IPC 5/ 3-GF-7,62	1708501	50
IPC 5/ 4-GF-7,62	1708514	50
IPC 5/ 5-GF-7,62	1708527	50
IPC 5/ 6-GF-7,62	1708530	50
IPC 5/ 7-GF-7,62	1708543	50
IPC 5/ 8-GF-7,62	1708556	50
IPC 5/ 9-GF-7,62	1708569	50
IPC 5/10-GF-7,62	1708572	50
IPC 5/11-GF-7,62	1708585	50
IPC 5/12-GF-7,62	1708598	50



Dimensional drawing

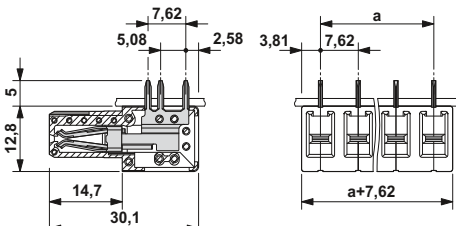

Drilling diagram

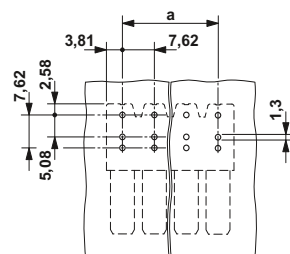

Ordering data

Type	Order No.	Pcs. / Pkt.
Pitch 7.62 mm, color: green		
IPC 5/ 2-GU-7,62	1708608	50
IPC 5/ 3-GU-7,62	1708611	50
IPC 5/ 4-GU-7,62	1708624	50
IPC 5/ 5-GU-7,62	1708637	50
IPC 5/ 6-GU-7,62	1708640	50
IPC 5/ 7-GU-7,62	1708653	50
IPC 5/ 8-GU-7,62	1708666	50
IPC 5/ 9-GU-7,62	1708679	50
IPC 5/10-GU-7,62	1708682	50
IPC 5/11-GU-7,62	1708695	50
IPC 5/12-GU-7,62	1708705	50



Dimensional drawing

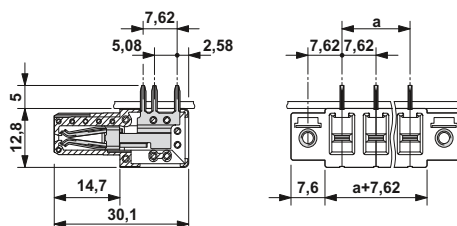

Drilling diagram

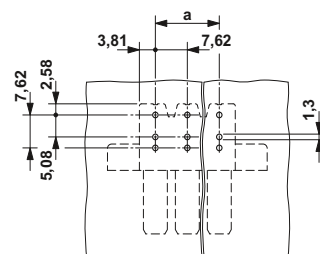

Ordering data

Type	Order No.	Pcs. / Pkt.
Pitch 7.62 mm, color: green		
IPC 5/ 2-GFU-7,62	1708718	50
IPC 5/ 3-GFU-7,62	1708721	50
IPC 5/ 4-GFU-7,62	1708734	50
IPC 5/ 5-GFU-7,62	1708747	50
IPC 5/ 6-GFU-7,62	1708750	50
IPC 5/ 7-GFU-7,62	1708763	50
IPC 5/ 8-GFU-7,62	1708776	50
IPC 5/ 9-GFU-7,62	1708789	50
IPC 5/10-GFU-7,62	1708792	50
IPC 5/11-GFU-7,62	1708802	50
IPC 5/12-GFU-7,62	1708815	50

Plug-in connectors for power electronics with 5.0 to 15.0 mm pitch

PC 5 series plug-in connectors up to 41 A/10 mm², pitch 7.62 mm

Headers with socket contact

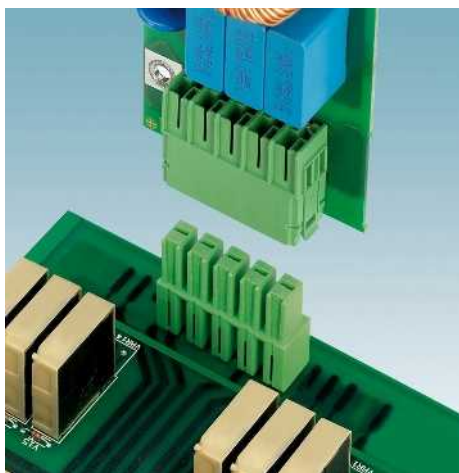

- An inverted IPC 5 header in a vertical design to implement a touch-proof PCB output or a PCB-PCB connection (in combination with PC 5 base strips)
- Maximum contact safety, thanks to an integrated double steel spring
- Asymmetrical layout of solder pins to avoid incorrect plugging-in
- Threaded flange -GF
- Suitable for 600 V UL when used in combination with IPC 5 screw and spring-cage plugs

Notes:

In accordance with DIN EN 61984, COMBICON plug-in connectors have no switching power. During designated use, they must not be plugged in or disconnected when carrying voltage or under load.

COMBICON select



You will find the possible plug-in connector combinations in COMBICON select at: www.phoenixcontact.net/products or starting on page 486.

¹⁾ Please observe the derating curves and laboratory data sheets. Derating curves of further combination options on request.



Without threaded flange

Accessories

For all types	Type	Page
	Coding profile CP-PC RD Order No. 1701967	38
	Marker cards SK 7,62/3,8	799



Dimensional drawing

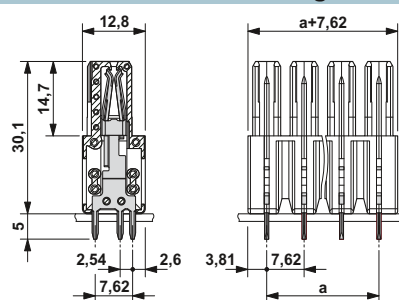

Drilling diagram

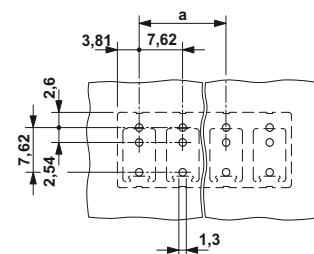

Technical data

Technical data in accordance to IEC / DIN VDE

Rated current	[A]	41 ¹⁾
Rated insulation voltage for pollution degree 2	[V]	630
Pitch	[mm]	7.62
Insulation coordination		
Surge voltage category / pollution degree		III / 3 III / 2 II / 2
Rated insulation voltage	[V]	630 630 1000
Rated surge voltage	[kV]	6 6 6
Approval data (UL/CUL)	Use Group	B C D
Nominal voltage	[V]	300 300 600
Nominal current	[A]	41 41 5
Connection capacity AWG	AWG	- - -
Approval data (CSA)	Use Group	B C D
Nominal voltage	[V]	- - -
Nominal current	[A]	- - -
Connection capacity AWG	AWG	- - -
General data		
Type of insulation material / insulation material group		PA / I
Inflammability class according to UL 94		V0
Drill hole diameter / pin dimensions	[mm]	1.3 / 1.2 x 0.8

Ordering data

No. of pos.	Dim. a [mm]	Type	Order No.	Pcs. / Pkt.
		Pitch 7.62 mm, color: green		
2	7.62	IPCV 5/ 2-G-7,62	1708828	50
3	15.24	IPCV 5/ 3-G-7,62	1708831	50
4	22.86	IPCV 5/ 4-G-7,62	1708844	50
5	30.48	IPCV 5/ 5-G-7,62	1708857	50
6	38.10	IPCV 5/ 6-G-7,62	1708860	50
7	45.72	IPCV 5/ 7-G-7,62	1708873	50
8	53.34	IPCV 5/ 8-G-7,62	1708886	50
9	60.96	IPCV 5/ 9-G-7,62	1708899	50
10	68.58	IPCV 5/10-G-7,62	1708909	50
11	76.20	IPCV 5/11-G-7,62	1708912	50
12	83.82	IPCV 5/12-G-7,62	1708925	50



With threaded flange



Dimensional drawing

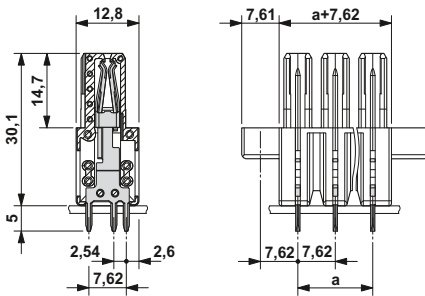

Drilling diagram

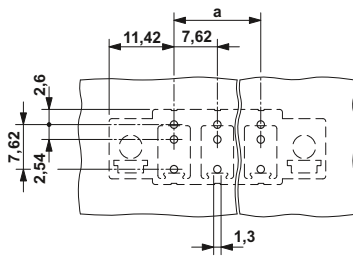

Ordering data

Type	Order No.	Pcs. / Pkt.
Pitch 7.62 mm, color: green		
IPCV 5/ 2-GF-7,62	1708938	50
IPCV 5/ 3-GF-7,62	1708941	50
IPCV 5/ 4-GF-7,62	1708954	50
IPCV 5/ 5-GF-7,62	1708967	50
IPCV 5/ 6-GF-7,62	1708970	50
IPCV 5/ 7-GF-7,62	1708983	50
IPCV 5/ 8-GF-7,62	1708996	50
IPCV 5/ 9-GF-7,62	1709005	50
IPCV 5/10-GF-7,62	1709018	50
IPCV 5/11-GF-7,62	1709021	50
IPCV 5/12-GF-7,62	1709034	50

Plug-in connectors for power electronics with 5.0 to 15.0 mm pitch

PC 5 series plug-in connectors up to 41 A/10 mm², pitch 7.62 mm

Feed-through header with a pin contact

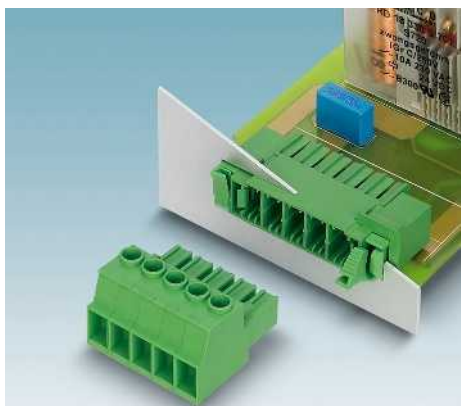

- Feed-through headers for use in combination with all PC 5 plugs
- To solder onto the PCB
- Mounting on the housing wall using the snap-lock mechanism to be operated without tools or the classical screw connection
- Wall thicknesses from 1 mm to 3 mm
- In GF versions, shielding functions can be executed on the housing wall
- If the GU headers are used, the plug is rotated by 180° before fitting
- Suitable for 600 V UL when used in combination with PC 5 screw and spring-cage plugs

Notes:

In accordance with DIN EN 61984, COMBICON plug-in connectors have no switching power. During designated use, they must not be plugged in or disconnected when carrying voltage or under load.

COMBICON select

You will find the possible plug-in connector combinations in COMBICON select at: www.phoenixcontact.net/products or starting on page 486.

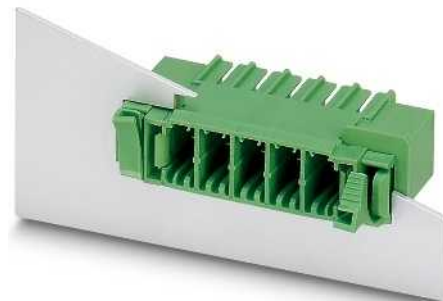

The cutout dimensions and mounting options for the feed-through versions can be found on page 595.

¹⁾ Please observe the derating curves and laboratory data sheets. Derating curves of further combination options on request.



Compatible with STCL plugs

Accessories

For all types	Type	Page
	Coding profile CP-PC RD Order No. 1701967	38
	Screws for mounting on the housing panel DFK-PC 16-SS Order No. 1705449	
	Marker cards SK 7,62/3,8	799



Dimensional drawing

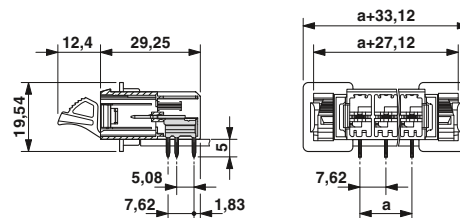

Drilling diagram

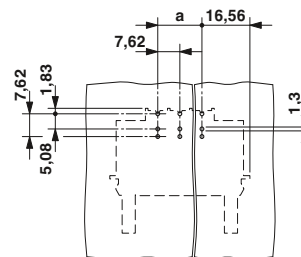

Technical data

Technical data in accordance to IEC / DIN VDE

Rated current	[A]	41 ¹⁾
Rated insulation voltage for pollution degree 2	[V]	630
Pitch	[mm]	7.62
Insulation coordination		
Surge voltage category / pollution degree		III / 3 III / 2 II / 2
Rated insulation voltage	[V]	500 630 800
Rated surge voltage	[kV]	6 6 6
Approval data (UL/CUL)	Use Group	B C D
Nominal voltage	[V]	300 150 300
Nominal current	[A]	41 41 10
Connection capacity AWG	AWG	- - -
Approval data (CSA)	Use Group	B C D
Nominal voltage	[V]	- - -
Nominal current	[A]	- - -
Connection capacity AWG	AWG	- - -
General data		
Type of insulation material / insulation material group		PA / I
Inflammability class according to UL 94		V0
Drill hole diameter / pin dimensions	[mm]	1.3 / 0.8 x 1.0

Ordering data

No. of pos.	Dim. a [mm]	Type	Order No.	Pcs. / Pkt.
Pitch 7.62 mm, color: green				
2	7.62	DFK-PC 5/ 2-G-7,62	1727582	10
3	15.24	DFK-PC 5/ 3-G-7,62	1727595	10
4	22.86	DFK-PC 5/ 4-G-7,62	1727605	10
5	30.48	DFK-PC 5/ 5-G-7,62	1727618	10
6	38.10	DFK-PC 5/ 6-G-7,62	1727621	10
7	45.72	DFK-PC 5/ 7-G-7,62	1727634	10
8	53.34	DFK-PC 5/ 8-G-7,62	1727647	10
9	60.96	DFK-PC 5/ 9-G-7,62	1727650	10
10	68.58	DFK-PC 5/10-G-7,62	1727663	10
11	76.20	DFK-PC 5/11-G-7,62	1727676	10
12	83.82	DFK-PC 5/12-G-7,62	1727689	10

Plug-in connectors for power electronics with 5.0 to 15.0 mm pitch

PC 5 series plug-in connectors up to 41 A/10 mm², pitch 7.62 mm

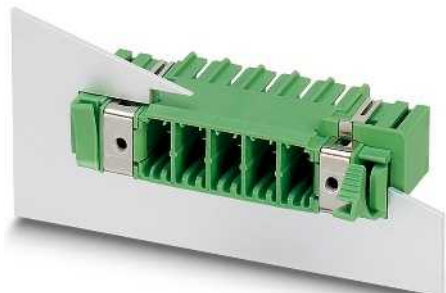

With threaded flange and shield connection on the front of the device

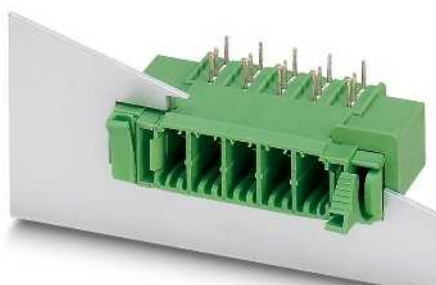

Rotated 180°, compatible with STCL plugs

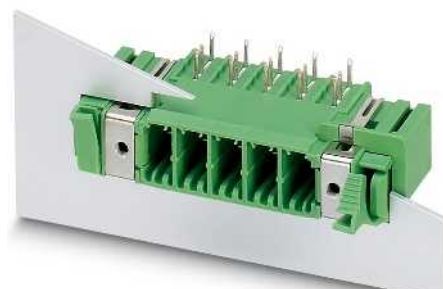

Rotated 180°, threaded flange, shield connection on the front of the device



Dimensional drawing

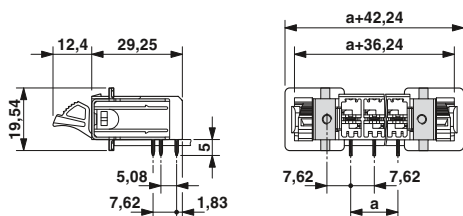

Drilling diagram

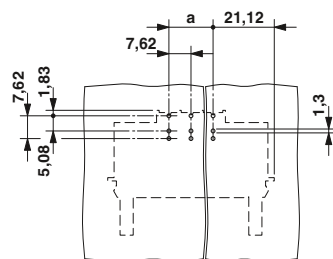

Ordering data

Type	Order No.	Pcs. / Pkt.
Pitch 7.62 mm, color: green		
DFK-PC 5/ 2-GF-7,62	1727692	10
DFK-PC 5/ 3-GF-7,62	1727702	10
DFK-PC 5/ 4-GF-7,62	1727715	10
DFK-PC 5/ 5-GF-7,62	1727728	10
DFK-PC 5/ 6-GF-7,62	1727731	10
DFK-PC 5/ 7-GF-7,62	1727744	10
DFK-PC 5/ 8-GF-7,62	1727757	10
DFK-PC 5/ 9-GF-7,62	1727760	10
DFK-PC 5/10-GF-7,62	1727773	10
DFK-PC 5/11-GF-7,62	1727786	10
DFK-PC 5/12-GF-7,62	1727799	10



Dimensional drawing

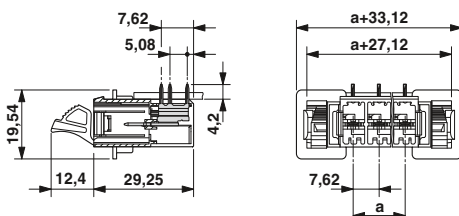

Drilling diagram

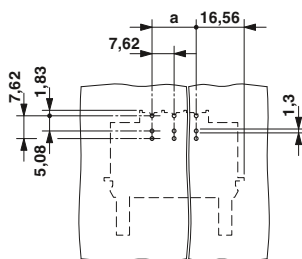

Ordering data

Type	Order No.	Pcs. / Pkt.
Pitch 7.62 mm, color: green		
DFK-PC 5/ 2-GU-7,62	1727809	10
DFK-PC 5/ 3-GU-7,62	1727812	10
DFK-PC 5/ 4-GU-7,62	1727825	10
DFK-PC 5/ 5-GU-7,62	1727838	10
DFK-PC 5/ 6-GU-7,62	1727841	10
DFK-PC 5/ 7-GU-7,62	1727854	10
DFK-PC 5/ 8-GU-7,62	1727867	10
DFK-PC 5/ 9-GU-7,62	1727870	10
DFK-PC 5/10-GU-7,62	1727883	10
DFK-PC 5/11-GU-7,62	1727896	10
DFK-PC 5/12-GU-7,62	1727906	10



Dimensional drawing

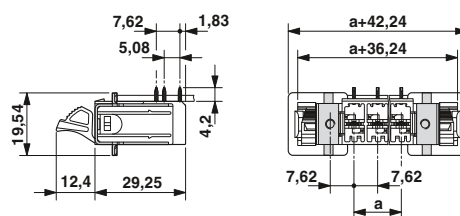

Drilling diagram

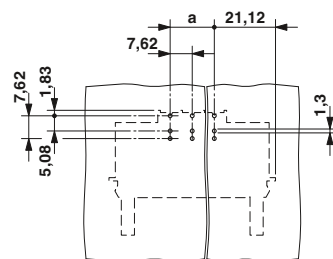

Ordering data

Type	Order No.	Pcs. / Pkt.
Pitch 7.62 mm, color: green		
DFK-PC 5/ 2-GFU-7,62	1727919	10
DFK-PC 5/ 3-GFU-7,62	1727922	10
DFK-PC 5/ 4-GFU-7,62	1727935	10
DFK-PC 5/ 5-GFU-7,62	1727948	10
DFK-PC 5/ 6-GFU-7,62	1727951	10
DFK-PC 5/ 7-GFU-7,62	1727964	10
DFK-PC 5/ 8-GFU-7,62	1727977	10
DFK-PC 5/ 9-GFU-7,62	1727980	10
DFK-PC 5/10-GFU-7,62	1727993	10
DFK-PC 5/11-GFU-7,62	1728002	10
DFK-PC 5/12-GFU-7,62	1716056	10

Plug-in connectors for power electronics with 5.0 to 15.0 mm pitch

PC 5 series plug-in connectors up to 41 A/10 mm², pitch 7.62 mm

Feed-through header with a pin contact

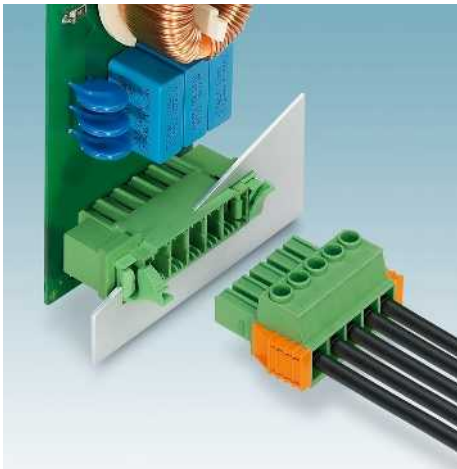

- Feed-through headers for use in combination with all PC 5 plugs
- To solder onto the PCB
- In SH versions, shielding functions can be executed on the inside of the device as well
- Mounting on the housing wall using the snap-lock mechanism to be operated without tools or the classical screw connection
- Wall thicknesses from 1 mm to 3 mm
- Suitable for 600 V UL when used in combination with PC 5 screw or spring-cage plugs

Notes:

In accordance with DIN EN 61984, COMBICON plug-in connectors have no switching power. During designated use, they must not be plugged in or disconnected when carrying voltage or under load.

COMBICON select

You will find the possible plug-in connector combinations in COMBICON select at: www.phoenixcontact.net/products or starting on page 486.

The cutout dimensions and mounting options for the feed-through versions can be found on page 595.

¹⁾ Please observe the derating curves and laboratory data sheets. Derating curves of further combination options on request.

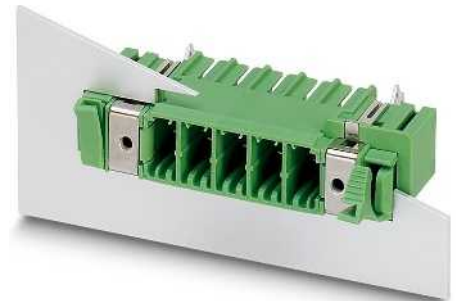

With threaded flange and shield feed-through on the inside of the device



Dimensional drawing

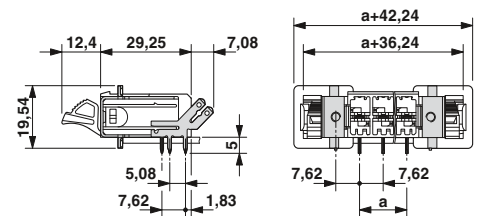

Drilling diagram

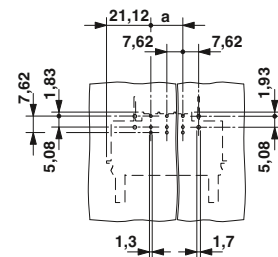

Accessories

For all types	Type	Page
	Coding profile CP-PC RD Order No. 1701967	38
	Screws for mounting on the housing panel DFK-PC 16-SS Order No. 1705449	
	Marker cards SK 7,62/3,8	799

Technical data

Technical data in accordance to IEC / DIN VDE

Rated current	[A]	41 ¹⁾
Rated insulation voltage for pollution degree 2	[V]	630
Pitch	[mm]	7.62
Insulation coordination		
Surge voltage category / pollution degree		III / 3 III / 2 II / 2
Rated insulation voltage	[V]	500 630 800
Rated surge voltage	[kV]	6 6 6
Approval data (UL/CUL)	Use Group	B C D
Nominal voltage	[V]	300 150 300
Nominal current	[A]	41 41 10
Connection capacity AWG	AWG	- - -
Approval data (CSA)	Use Group	B C D
Nominal voltage	[V]	- - -
Nominal current	[A]	- - -
Connection capacity AWG	AWG	- - -
General data		
Type of insulation material / insulation material group		PA / I
Inflammability class according to UL 94		V0
Drill hole diameter / pin dimensions	[mm]	1.3 / 0.8 x 1.0

Ordering data

No. of pos.	Dim. a [mm]	Type	Order No.	Pcs. / Pkt.
		Pitch 7.62 mm, color: green		
2	7.62	DFK-PC 5/ 2-GF-SH-7,62	1716069	10
3	15.24	DFK-PC 5/ 3-GF-SH-7,62	1716072	10
4	22.86	DFK-PC 5/ 4-GF-SH-7,62	1716085	10
5	30.48	DFK-PC 5/ 5-GF-SH-7,62	1716098	10
6	38.10	DFK-PC 5/ 6-GF-SH-7,62	1716108	10
7	45.72	DFK-PC 5/ 7-GF-SH-7,62	1716111	10
8	53.34	DFK-PC 5/ 8-GF-SH-7,62	1716124	10
9	60.96	DFK-PC 5/ 9-GF-SH-7,62	1716137	10
10	68.58	DFK-PC 5/10-GF-SH-7,62	1716140	10
11	76.20	DFK-PC 5/11-GF-SH-7,62	1716153	10
12	83.82	DFK-PC 5/12-GF-SH-7,62	1716166	10

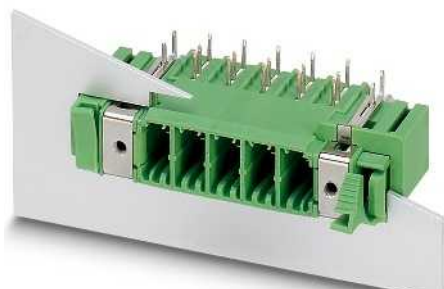

Rotated 180°, threaded flange, shield feed-through on the inside of the device

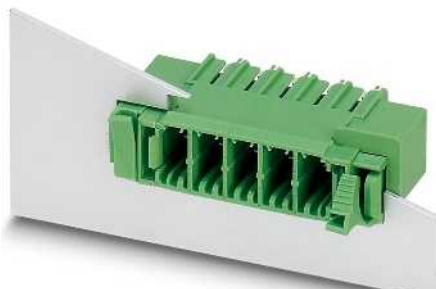

Vertical, compatible with STCL plugs



Vertical, threaded flange, shield connection on the front of the device



Dimensional drawing

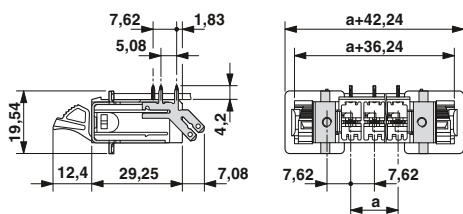

Drilling diagram

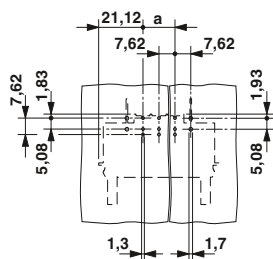

Ordering data

Type	Order No.	Pcs. / Pkt.
Pitch 7.62 mm, color: green		
DFK-PC 5/ 2-GFU-SH-7,62	1716179	10
DFK-PC 5/ 3-GFU-SH-7,62	1716182	10
DFK-PC 5/ 4-GFU-SH-7,62	1716195	10
DFK-PC 5/ 5-GFU-SH-7,62	1716205	10
DFK-PC 5/ 6-GFU-SH-7,62	1716218	10
DFK-PC 5/ 7-GFU-SH-7,62	1716221	10
DFK-PC 5/ 8-GFU-SH-7,62	1716234	10
DFK-PC 5/ 9-GFU-SH-7,62	1716247	10
DFK-PC 5/10-GFU-SH-7,62	1716250	10
DFK-PC 5/11-GFU-SH-7,62	1716263	10
DFK-PC 5/12-GFU-SH-7,62	1716276	10



Dimensional drawing

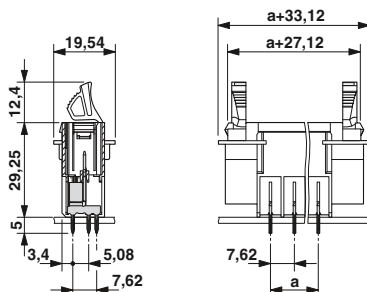

Drilling diagram

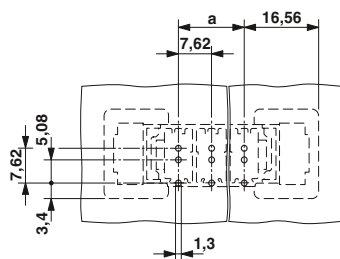

Ordering data

Type	Order No.	Pcs. / Pkt.
Pitch 7.62 mm, color: green		
DFK-PCV 5/ 2-G-7,62	1716289	10
DFK-PCV 5/ 3-G-7,62	1716292	10
DFK-PCV 5/ 4-G-7,62	1716302	10
DFK-PCV 5/ 5-G-7,62	1716315	10
DFK-PCV 5/ 6-G-7,62	1716328	10
DFK-PCV 5/ 7-G-7,62	1716331	10
DFK-PCV 5/ 8-G-7,62	1716344	10
DFK-PCV 5/ 9-G-7,62	1716357	10
DFK-PCV 5/10-G-7,62	1716360	10
DFK-PCV 5/11-G-7,62	1716373	10
DFK-PCV 5/12-G-7,62	1716386	10



Dimensional drawing

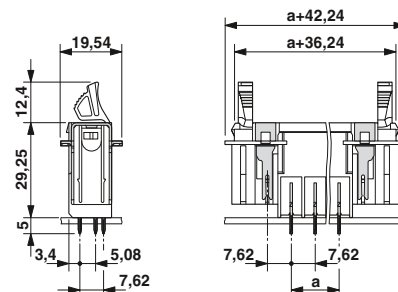

Drilling diagram

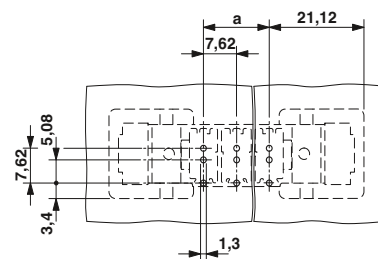

Ordering data

Type	Order No.	Pcs. / Pkt.
Pitch 7.62 mm, color: green		
DFK-PCV 5/ 2-GF-7,62	1716399	10
DFK-PCV 5/ 3-GF-7,62	1716409	10
DFK-PCV 5/ 4-GF-7,62	1716412	10
DFK-PCV 5/ 5-GF-7,62	1716425	10
DFK-PCV 5/ 6-GF-7,62	1716438	10
DFK-PCV 5/ 7-GF-7,62	1716441	10
DFK-PCV 5/ 8-GF-7,62	1716454	10
DFK-PCV 5/ 9-GF-7,62	1716467	10
DFK-PCV 5/10-GF-7,62	1716470	10
DFK-PCV 5/11-GF-7,62	1716483	10
DFK-PCV 5/12-GF-7,62	1716496	10

Plug-in connectors for power electronics with 5.0 to 15.0 mm pitch

PC 5 series plug-in connectors up to 41 A/10 mm², pitch 7.62 mm

Feed-through header with a pin contact

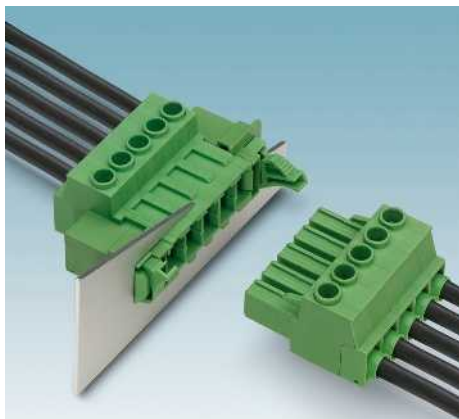

- Feed-through headers for use in combination with PC 5 plugs
- Screw connection for direct wiring on the inside of the device
- Mounting on the housing wall using the snap-lock mechanism to be operated without tools or the classical screw connection
- Wall thicknesses from 1 mm to 3 mm
- In SH versions, shielding functions can be executed on the inside of the device as well

Notes:

In accordance with DIN EN 61984, COMBICON plug-in connectors have no switching power. During designated use, they must not be plugged in or disconnected when carrying voltage or under load.

COMBICON select

You will find the possible plug-in connector combinations in COMBICON select at: www.phoenixcontact.net/products or starting on page 486.

The cutout dimensions and mounting options for the feed-through versions can be found on page 595.

1) Derating curves on request.

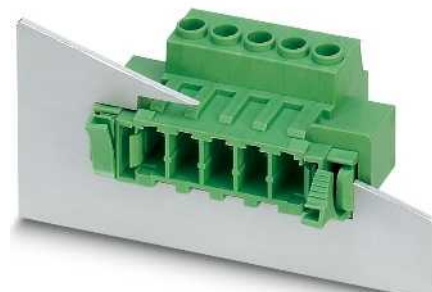

Compatible with STCL plugs,
600 V UL approval



Dimensional drawing

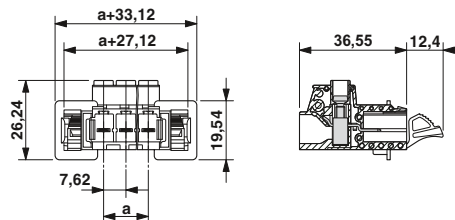

Accessories

For all types	Type	Page
	Coding profile CP-PC RD Order No. 1701967	38
	Screws for mounting on the housing panel DFK-PC 16-SS Order No. 1705449	
	Marker cards SK 7,62/3,8	799
	Screwdriver SZK PZ 1 Order No. 1206450	

Technical data

Technical data in accordance to IEC / DIN VDE	
Rated current / conductor cross section	[A] / [mm ²]
Rated insulation voltage for pollution degree 2	[V]
Pitch	[mm]
Connection capacity	
Solid / stranded	[mm ²] / [mm ²] / AWG
Stranded with ferrules without plastic sleeve	[mm ²]
Stranded with ferrules with plastic sleeve	[mm ²]
Multi-conductor connection capacity (two conductors with the same cross section)	
Solid / stranded	[mm ²]
Stranded with ferrules without plastic sleeve	[mm ²]
Stranded with TWIN ferrule with plastic sleeve	[mm ²]
Insulation coordination	
Surge voltage category / pollution degree	
Rated insulation voltage	[V]
Rated surge voltage	[kV]
Approval data (UL/CUL)	Use Group
Nominal voltage	[V]
Nominal current	[A]
Connection capacity AWG	AWG
Approval data (CSA)	Use Group
Nominal voltage	[V]
Nominal current	[A]
Connection capacity AWG	AWG
General data	
Stripping length	[mm]
Screw thread	
Tightening torque	[Nm]
Type of insulation material / insulation material group	
Inflammability class according to UL 94	

	41 ¹⁾ / 10
	1000
	7.62
	0.2 - 10 / 0.2 - 6 / 24 - 10
	0.25 - 6
	0.25 - 4
	0.2 - 2.5 / 0.2 - 4
	0.25 - 1.5
	0.25 - 2.5
	III / 3 III / 2 II / 2
	1000 1000 1000
	8 8 6
	B C D
	600 600 -
	41 41 -
	24 - 8 24 - 8 -
	B C D
	- - -
	- - -
	- - -
	10
	M3
	0.7 - 0.8
	PA / I
	V0

Ordering data

No. of pos.	Dim. a [mm]	Type	Order No.	Pcs. / Pkt.
Pitch 7.62 mm, color: green				
2	7.62	DFK-PC 5/ 2-ST-7,62	1716506	10
3	15.24	DFK-PC 5/ 3-ST-7,62	1716519	10
4	22.86	DFK-PC 5/ 4-ST-7,62	1716522	10
5	30.48	DFK-PC 5/ 5-ST-7,62	1716535	10
6	38.10	DFK-PC 5/ 6-ST-7,62	1716548	10
7	45.72	DFK-PC 5/ 7-ST-7,62	1716551	10
8	53.34	DFK-PC 5/ 8-ST-7,62	1716564	10
9	60.96	DFK-PC 5/ 9-ST-7,62	1716577	10
10	68.58	DFK-PC 5/10-ST-7,62	1716580	10
11	76.20	DFK-PC 5/11-ST-7,62	1716593	10
12	83.82	DFK-PC 5/12-ST-7,62	1716603	10



With threaded flange and shield connection on the front of the device, 600 V UL approval



With threaded flange and shield feed-through on the inside of the device, 600 V UL approval



Dimensional drawing

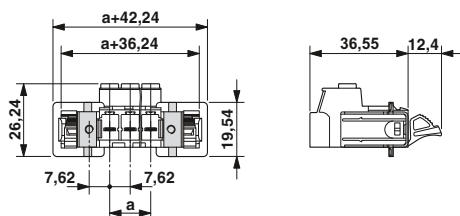

Dimensional drawing

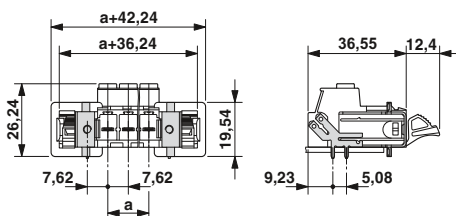

Ordering data

Type	Order No.	Pcs. / Pkt.
Pitch 7.62 mm, color: green		
DFK-PC 5/ 2-STF-7,62	1716616	10
DFK-PC 5/ 3-STF-7,62	1716629	10
DFK-PC 5/ 4-STF-7,62	1716632	10
DFK-PC 5/ 5-STF-7,62	1716645	10
DFK-PC 5/ 6-STF-7,62	1716658	10
DFK-PC 5/ 7-STF-7,62	1716661	10
DFK-PC 5/ 8-STF-7,62	1716674	10
DFK-PC 5/ 9-STF-7,62	1716687	10
DFK-PC 5/10-STF-7,62	1716690	10
DFK-PC 5/11-STF-7,62	1716700	10
DFK-PC 5/12-STF-7,62	1716713	10

Ordering data

Type	Order No.	Pcs. / Pkt.
Pitch 7.62 mm, color: green		
DFK-PC 5/ 2-STF-SH-7,62	1716726	10
DFK-PC 5/ 3-STF-SH-7,62	1716739	10
DFK-PC 5/ 4-STF-SH-7,62	1716742	10
DFK-PC 5/ 5-STF-SH-7,62	1716755	10
DFK-PC 5/ 6-STF-SH-7,62	1716768	10
DFK-PC 5/ 7-STF-SH-7,62	1716771	10
DFK-PC 5/ 8-STF-SH-7,62	1716784	10
DFK-PC 5/ 9-STF-SH-7,62	1716797	10
DFK-PC 5/10-STF-SH-7,62	1716807	10
DFK-PC 5/11-STF-SH-7,62	1716810	10
DFK-PC 5/12-STF-SH-7,62	1716823	10

Plug-in connectors for power electronics with 5.0 to 15.0 mm pitch

PC 6 series plug-in connectors up to 41 A/6 mm², pitch 10.16 mm

Plug with a screw connection

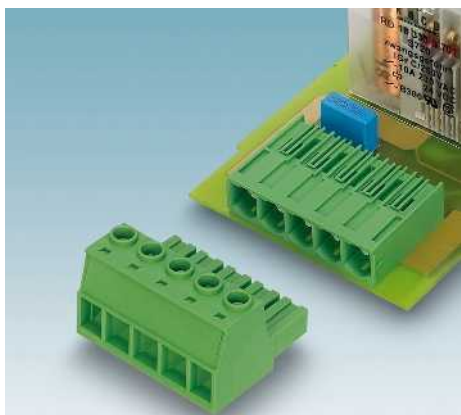

- High-capacity plugs with a current carrying capacity of 41 A and a connection capacity of 6 mm², stranded/10 mm², solid
- Unrestricted 600-V-UL approval
- Contact safety, thanks to integrated double steel spring and silver-plated surfaces
- Screw flange (-F) and shield (-SH)
- Can be plugged onto PC 6-16 headers
- CP-PC RD coding profile

Notes:

In accordance with DIN EN 61984, COMBICON plug-in connectors have no switching power. During designated use, they must not be plugged in or disconnected when carrying voltage or under load.

COMBICON select

You will find the possible plug-in connector combinations in COMBICON select at: www.phoenixcontact.net/products or starting on page 488.

¹⁾ Please observe the derating curves and laboratory data sheets. Derating curves of further combination options on request.



Without screw flange, 600 V UL approval



Dimensional drawing

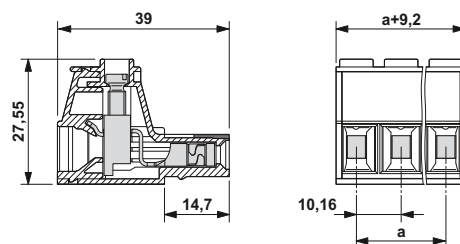

Note derating curves

Derating curves, determined as per
DIN EN 61984 (VDE 0627):2002-09
Representation based on DIN EN 60512-5-2:2003-01
Connected conductor cross section = 6 mm²
Reduction factor = 0.8
Number of positions = see diagram

Accessories

For all types	Type	Page
	Coding profile CP-PC RD Order No. 1701967	38
	Marker strips SK 5,0 WH:REEL Order No. 0805221	801
	Screwdriver SZS 1,0 x 4,0 Order No. 1205066	

Technical data

Technical data in accordance to IEC / DIN VDE	
Rated current / conductor cross section	[A] / [mm ²]
Rated insulation voltage for pollution degree 2	[V]
Pitch	[mm]
Connection capacity	
Solid / stranded	[mm ²] / [mm ²] / AWG
Stranded with ferrules without plastic sleeve	[mm ²]
Stranded with ferrules with plastic sleeve	[mm ²]
Multi-conductor connection capacity (two conductors with the same cross section)	
Solid / stranded	[mm ²]
Stranded with ferrules without plastic sleeve	[mm ²]
Stranded with TWIN ferrule with plastic sleeve	[mm ²]
Insulation coordination	
Surge voltage category / pollution degree	III / 3 III / 2 II / 2
Rated insulation voltage	[V]
Rated surge voltage	[kV]
Approval data (UL/CUL)	Use Group
Nominal voltage	[V]
Nominal current	[A]
Connection capacity AWG	AWG
Approval data (CSA)	Use Group
Nominal voltage	[V]
Nominal current	[A]
Connection capacity AWG	AWG
General data	
Stripping length	[mm]
Screw thread	
Tightening torque	[Nm]
Type of insulation material / insulation material group	
Inflammability class according to UL 94	

41 ¹⁾ / 10		
1000		
10.16		
0.75 - 10 / 0.75 - 6 / 18 - 8		
0.5 - 6		
0.5 - 6		
0.75 - 4 / 0.75 - 6		
0.5 - 2.5		
0.5 - 4		
III / 3	III / 2	II / 2
1000	1000	1000
8	8	6
B	C	D
600	600	-
50	50	-
20 - 8	20 - 8	-
B	C	D
-	-	-
-	-	-
-	-	-
12		
M4		
1.2 - 1.5		
PA / I		
V0		

No. of pos.	Dim. a [mm]
2	10.16
3	20.32
4	30.48
5	40.64
6	50.80
7	60.96
8	71.12

Ordering data

Type	Order No.	Pcs. / Pkt.
Pitch 10.16 mm, color: green		
PC 6/ 2-ST-10,16	1913507	50
PC 6/ 3-ST-10,16	1913510	50
PC 6/ 4-ST-10,16	1913523	50
PC 6/ 5-ST-10,16	1913536	50
PC 6/ 6-ST-10,16	1913549	50
PC 6/ 7-ST-10,16	1913552	50
PC 6/ 8-ST-10,16	1913565	50



With screw flange, 600 V UL approval



With screw flange and shield, 600 V UL approval



Dimensional drawing

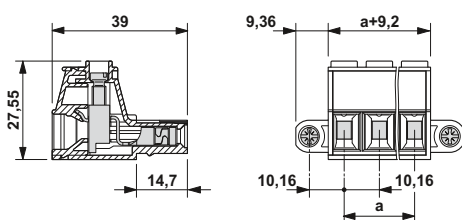

Dimensional drawing

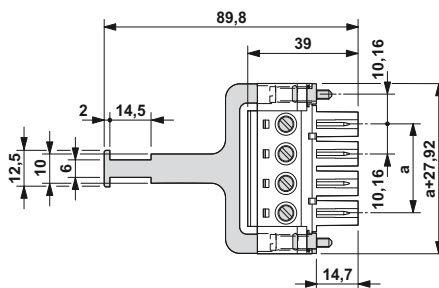

Representative derating curve

Type: PC 6/...-ST-10,16 with PC 6-16/...-G1-10,16

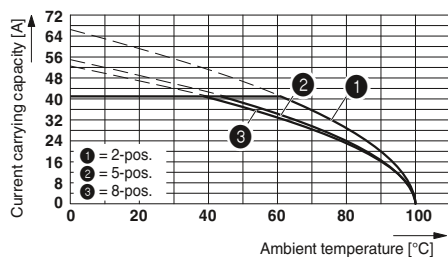

Ordering data

Type	Order No.	Pcs. / Pkt.
Pitch 10.16 mm, color: green		
PC 6/ 2-STF-10,16	1913578	50
PC 6/ 3-STF-10,16	1913581	50
PC 6/ 4-STF-10,16	1913594	50
PC 6/ 5-STF-10,16	1913604	50
PC 6/ 6-STF-10,16	1913617	50
PC 6/ 7-STF-10,16	1913620	50
PC 6/ 8-STF-10,16	1913633	50

Ordering data

Type	Order No.	Pcs. / Pkt.
Pitch 10.16 mm, color: green		
PC 6/ 3-STF-SH-10,16	1973042	50
PC 6/ 4-STF-SH-10,16	1966431	50

Plug-in connectors for power electronics with 5.0 to 15.0 mm pitch

PC 6 series plug-in connectors up to 41 A/6 mm², pitch 10.16 mm

Plugs for direct mounting with socket contact



- Plug-in block for direct mounting with a current carrying capacity of 41 A and a connection capacity of 6 mm², stranded / 10 mm², solid
- Unrestricted 600-V-UL approval
- Easy-maintenance PCB connection (PC 6-16 G1) or inverted IPC 16 plugs
- Laterally mounted flange for screw connection in the housing / on the mounting plate

Notes:

In accordance with DIN EN 61984, COMBICON plug-in connectors have no switching power. During designated use, they must not be plugged in or disconnected when carrying voltage or under load.

COMBICON select

You will find the possible plug-in connector combinations in COMBICON select at: www.phoenixcontact.net/products or starting on page 488.



¹⁾ Please observe the derating curves and laboratory data sheets. Derating curves of further combination options on request.



Vertical plug-in direction, can be screwed on, 600 V UL approval



Accessories

For all types	Type	Page
	Coding profile CP-PC RD Order No. 1701967	38
	Marker strips SK 5,0 WH:REEL Order No. 0805221	801
	Screwdriver SZS 1,0 x 4,0 Order No. 1205066	

Dimensional drawing

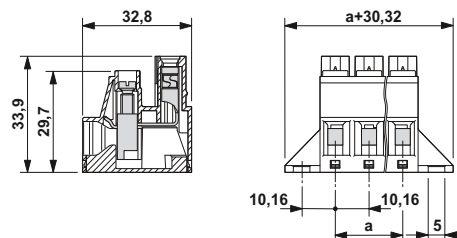

Drilling diagram

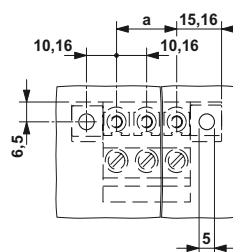

Technical data

Technical data in accordance to IEC / DIN VDE	
Rated current / conductor cross section	[A] / [mm ²]
Rated insulation voltage for pollution degree 2	[V]
Pitch	[mm]
Connection capacity	
Solid / stranded	[mm ²] / [mm ²] / AWG
Stranded with ferrules without plastic sleeve	[mm ²]
Stranded with ferrules with plastic sleeve	[mm ²]
Multi-conductor connection capacity (two conductors with the same cross section)	
Solid / stranded	[mm ²]
Stranded with ferrules without plastic sleeve	[mm ²]
Stranded with TWIN ferrule with plastic sleeve	[mm ²]
Insulation coordination	
Surge voltage category / pollution degree	III / 3 III / 2 II / 2
Rated insulation voltage	[V]
Rated surge voltage	[kV]
Approval data (UL/CUL)	Use Group
Nominal voltage	[V]
Nominal current	[A]
Connection capacity AWG	AWG
Approval data (CSA)	Use Group
Nominal voltage	[V]
Nominal current	[A]
Connection capacity AWG	AWG
General data	
Stripping length	[mm]
Screw thread	
Tightening torque	[Nm]
Type of insulation material / insulation material group	
Inflammability class according to UL 94	

Rated current / conductor cross section	41 ¹⁾ / 10
Rated insulation voltage for pollution degree 2	1000
Pitch	10.16
Connection capacity	
Solid / stranded	0.5 - 10 / 0.5 - 6 / 20 - 7
Stranded with ferrules without plastic sleeve	0.5 - 6
Stranded with ferrules with plastic sleeve	0.5 - 6
Multi-conductor connection capacity (two conductors with the same cross section)	
Solid / stranded	0.5 - 6 / 0.5 - 6
Stranded with ferrules without plastic sleeve	0.5 - 2.5
Stranded with TWIN ferrule with plastic sleeve	0.5 - 4
Insulation coordination	
Surge voltage category / pollution degree	III / 3 III / 2 II / 2
Rated insulation voltage	1000 1000 1000
Rated surge voltage	8 8 8
Approval data (UL/CUL)	B C D
Nominal voltage	600 600 -
Nominal current	50 50 -
Connection capacity AWG	20 - 8 20 - 8 -
Approval data (CSA)	B C D
Nominal voltage	- - -
Nominal current	- - -
Connection capacity AWG	- - -
General data	
Stripping length	12
Screw thread	M4
Tightening torque	1.2 - 1.5
Type of insulation material / insulation material group	PA / I
Inflammability class according to UL 94	V0

Ordering data

No. of pos.	Dim. a [mm]	Type	Order No.	Pcs. / Pkt.
Pitch 10.16 mm, color: green				
2	10.16	PCU 6 / 2-STD-10,16	1922637	50
3	20.32	PCU 6 / 3-STD-10,16	1922640	50
4	30.48	PCU 6 / 4-STD-10,16	1922653	50
5	40.64	PCU 6 / 5-STD-10,16	1922666	50
6	50.80	PCU 6 / 6-STD-10,16	1922679	50
7	60.96	PCU 6 / 7-STD-10,16	1922682	50
8	71.12	PCU 6 / 8-STD-10,16	1922695	50
9	81.28	PCU 6 / 9-STD-10,16	1922705	50

Plug-in connectors for power electronics with 5.0 to 15.0 mm pitch

PC 16 series plug-in connectors up to 76 A/16 mm², pitch 10.16 mm

Plugs with screw and spring connection

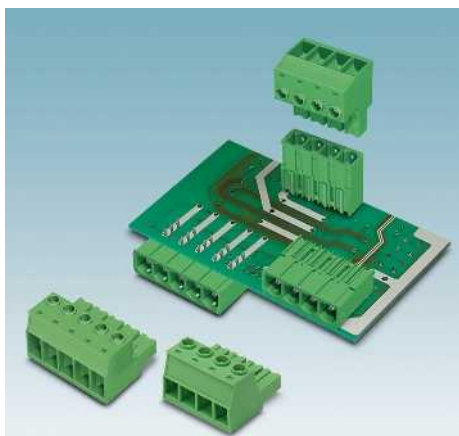

- High-capacity plugs with a current carrying capacity of 76 A and a connection capacity of 16 mm², stranded
- Unrestricted 600-V-UL approval
- Maximum contact safety, thanks to an integrated double steel spring
- Further features: screw flange (-STF) and shield (-SH)
- Can be plugged into PC 6-16 headers and IPC 16 plugs
- CP-PC RD coding profile

Notes:

In accordance with DIN EN 61984, COMBICON plug-in connectors have no switching power. During designated use, they must not be plugged in or disconnected when carrying voltage or under load.

COMBICON select

You will find the possible plug-in connector combinations in COMBICON select at: www.phoenixcontact.net/products or starting on page 488.

When using ferrules for 16 mm² conductors, crimp with CRIMPFOX 16 S (see accessories).

¹⁾ Please observe the derating curves and laboratory data sheets. Derating curves of further combination options on request.



Without screw flange, 600 V UL approval



Dimensional drawing

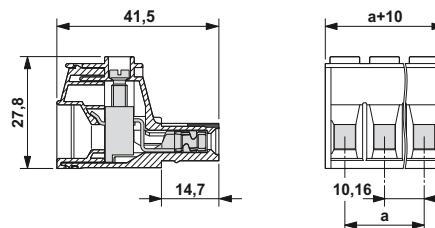

Note derating curves

Derating curves, determined as per DIN EN 61984 (VDE 0627):2002-09
Representation based on DIN EN 60512-5-2:2003-01
Connected conductor cross section = 16 mm²
Reduction factor = 0.8
Number of positions = see diagram

Accessories		
For all types	Type	Page
	Coding profile CP-PC RD Order No. 1701967	38
	Screwdriver SZS 1,0 x 4,0 Order No. 1205066	
	Marker strips SK 5,0 WH:REEL Order No. 0805221	801
	Crimping pliers for 0.25 to 6 mm ² CRIMPFOX 6 Order No. 1212034	
	Crimping pliers for 10 to 16 mm ² CRIMPFOX 16 S Order No. 1207983	

Technical data

Technical data in accordance to IEC / DIN VDE	
Rated current / conductor cross section	[A] / [mm ²]
Rated insulation voltage for pollution degree 2	[V]
Pitch	[mm]
Connection capacity	
Solid & multi-strand / stranded	[mm ²] / [mm ²] / AWG
Stranded with ferrules without plastic sleeve	[mm ²]
Stranded with ferrules with plastic sleeve	[mm ²]
Multi-conductor connection capacity (two conductors with the same cross section)	
Solid & multi-strand / stranded	[mm ²]
Stranded with ferrules without plastic sleeve	[mm ²]
Stranded with TWIN ferrule with plastic sleeve	[mm ²]
Insulation coordination	
Surge voltage category / pollution degree	
Rated insulation voltage	[V]
Rated surge voltage	[kV]
Approval data (UL/CUL)	Use Group
Nominal voltage	[V]
Nominal current	[A]
Connection capacity AWG	AWG
Approval data (CSA)	Use Group
Nominal voltage	[V]
Nominal current	[A]
Connection capacity AWG	AWG
General data	
Stripping length	[mm]
Screw thread	
Tightening torque	[Nm]
Type of insulation material / insulation material group	
Inflammability class according to UL 94	

76 ¹⁾ / 16		
1000		
10.16		
0.75 - 16 / 0.75 - 16 / 18 - 6		
0.5 - 16		
0.5 - 16		
0.75 - 6 / 0.75 - 6		
0.5 - 4		
0.5 - 6		
III / 3	III / 2	II / 2
1000	1000	1000
8	8	6
B	C	D
600	600	-
55	55	-
20 - 6	20 - 6	-
B	C	D
-	-	-
-	-	-
-	-	-
12		
M4		
1.7 - 1.8		
PA / I		
V0		

Ordering data

No. of pos.	Dim. a [mm]	Type	Order No.	Pcs. / Pkt.
Pitch 10.16 mm, color: green				
2	10.16	PC 16/ 2-ST-10,16	1967375	50
3	20.32	PC 16/ 3-ST-10,16	1967388	50
4	30.48	PC 16/ 4-ST-10,16	1967391	50
5	40.64	PC 16/ 5-ST-10,16	1967401	50
6	50.80	PC 16/ 6-ST-10,16	1967414	50
7	60.96	PC 16/ 7-ST-10,16	1967427	50
8	71.12	PC 16/ 8-ST-10,16	1967430	50
9	81.28	PC 16/ 9-ST-10,16	1967443	50



With screw flange, 600 V UL approval



With screw flange and shield, 600 V UL approval



Dimensional drawing

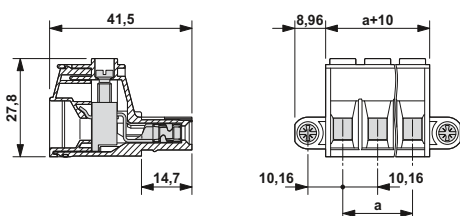

Dimensional drawing

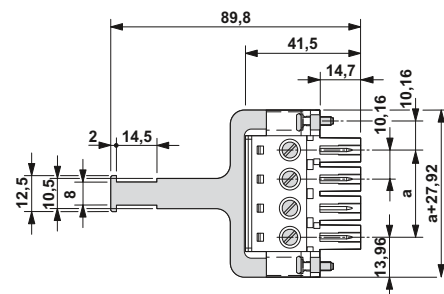

Representative derating curves of the above-mentioned plugs

Type: PC 16/..-ST-10,16 with PC 6-16/..-G1-10,16

Type: PC 16/..-ST-10,16 with IPC 16/..-ST-10,16

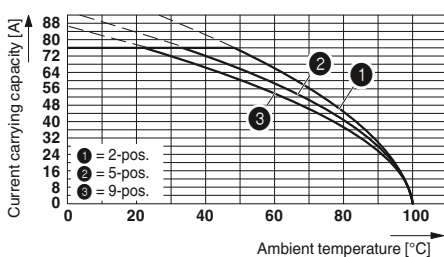
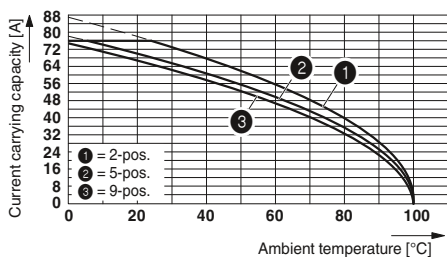

Ordering data

Type	Order No.	Pcs. / Pkt.
Pitch 10.16 mm, color: green		
PC 16/ 2-STF-10,16	1967456	50
PC 16/ 3-STF-10,16	1967469	50
PC 16/ 4-STF-10,16	1967472	50
PC 16/ 5-STF-10,16	1967485	50
PC 16/ 6-STF-10,16	1967498	50
PC 16/ 7-STF-10,16	1967508	50
PC 16/ 8-STF-10,16	1967511	50
PC 16/ 9-STF-10,16	1967524	50

Ordering data

Type	Order No.	Pcs. / Pkt.
Pitch 10.16 mm, color: green		
PC 16/ 3-STF-SH-10,16	1737530	50
PC 16/ 4-STF-SH-10,16	1970359	50

Plug-in connectors for power electronics with 5.0 to 15.0 mm pitch

PC 16 series plug-in connectors up to 76 A/16 mm², pitch 10.16 mm

Plugs with screw and spring connection

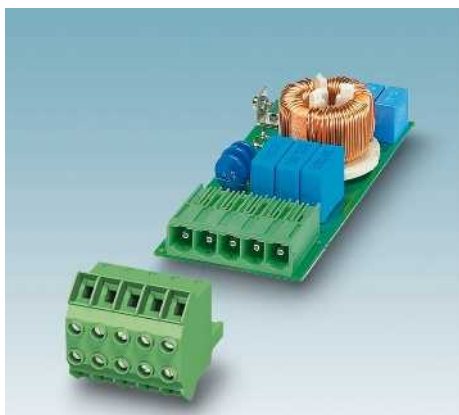

- Plug with double connection and a current carrying capacity of 76 A
- Simple potential distribution through two terminal points per contact
- Unrestricted 600-V-UL approval
- Maximum contact safety, thanks to an integrated double steel spring
- CP-PC RD coding profile

Notes:

In accordance with DIN EN 61984, COMBICON plug-in connectors have no switching power. During designated use, they must not be plugged in or disconnected when carrying voltage or under load.

COMBICON select

You will find the possible plug-in connector combinations in COMBICON select at: www.phoenixcontact.net/products or starting on page 488.

When using ferrules for 16 mm² conductors, crimp with CRIMPFOX 16 S (see accessories).

¹⁾ Please observe the derating curves and laboratory data sheets. Derating curves of further combination options on request.



Without screw flange, 600 V UL approval

Accessories

For all types	Type	Page
	Coding profile CP-PC RD Order No. 1701967	38
	Screwdriver SZS 1,0 x 4,0 Order No. 1205066	
	Marker strips SK 5,0 WH:REEL Order No. 0805221	801
	Crimping pliers for 0.25 to 6 mm ² CRIMPFOX 6 Order No. 1212034	
	Crimping pliers for 10 to 16 mm ² CRIMPFOX 16 S Order No. 1207983	



Dimensional drawing

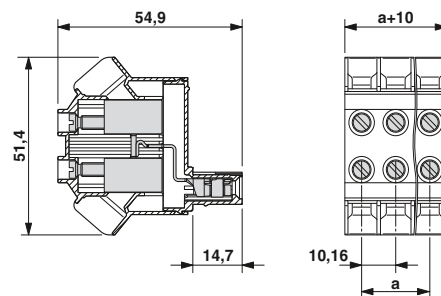

Note derating curves

Derating curves, determined as per DIN EN 61984 (VDE 0627):2002-09
Representation based on DIN EN 60512-5-2:2003-01
Connected conductor cross section = 16 mm²
Reduction factor = 0.8
Number of positions = see diagram

Technical data

Technical data in accordance to IEC / DIN VDE	
Rated current / conductor cross section	[A] / [mm ²]
Rated insulation voltage for pollution degree 2	[V]
Pitch	[mm]
Connection capacity	
Solid & multi-strand / stranded	[mm ²] / [mm ²] / AWG
Stranded with ferrules without plastic sleeve	[mm ²]
Stranded with ferrules with plastic sleeve	[mm ²]
Multi-conductor connection capacity (two conductors with the same cross section)	
Solid & multi-strand / stranded	[mm ²]
Stranded with ferrules without plastic sleeve	[mm ²]
Stranded with TWIN ferrule with plastic sleeve	[mm ²]
Insulation coordination	
Surge voltage category / pollution degree	III / 3 III / 2 II / 2
Rated insulation voltage	[V]
Rated surge voltage	[kV]
Approval data (UL/CUL)	Use Group
Nominal voltage	[V]
Nominal current	[A]
Connection capacity AWG	AWG
Approval data (CSA)	Use Group
Nominal voltage	[V]
Nominal current	[A]
Connection capacity AWG	AWG
General data	
Stripping length	[mm]
Screw thread	
Tightening torque	[Nm]
Type of insulation material / insulation material group	
Inflammability class according to UL 94	

	76 ¹⁾ / 16
	1000
	10.16
	0.75 - 16 / 0.75 - 16 / 18 - 6
	0.5 - 16
	0.5 - 16
	0.75 - 6 / 0.75 - 6
	0.5 - 4
	0.5 - 6
	III / 3 III / 2 II / 2
	1000 1000 1000
	8 8 6
	B C D
	600 600 -
	60 60 -
	20 - 4 20 - 4 -
	B C D
	- - -
	- - -
	- - -
	18
	M4
	1.7 - 1.8
	PA / I
	V0

Ordering data

No. of pos.	Dim. a [mm]	Type	Order No.	Pcs. / Pkt.
		Pitch 10.16 mm, color: green		
2	10.16	TPC 16/ 2-ST-10,16	1715170	20
3	20.32	TPC 16/ 3-ST-10,16	1715183	20
4	30.48	TPC 16/ 4-ST-10,16	1715196	20
5	40.64	TPC 16/ 5-ST-10,16	1715206	20
6	50.80	TPC 16/ 6-ST-10,16	1715219	20
7	60.96	TPC 16/ 7-ST-10,16	1715222	20
8	71.12	TPC 16/ 8-ST-10,16	1715235	20
9	81.28	TPC 16/ 9-ST-10,16	1715248	20



With screw flange, 600 V UL approval



Dimensional drawing

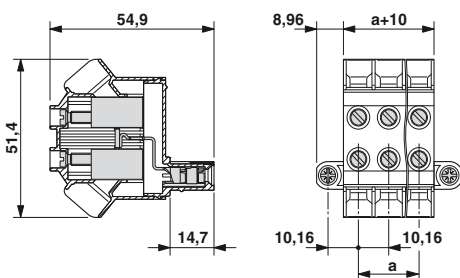

Representative derating curve

Type: TPC 16/....-ST-10,16 with PC 6-16/....-G1-10,16

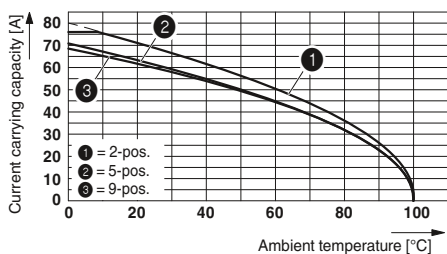

Ordering data

Type	Order No.	Pcs. / Pkt.
Pitch 10.16 mm, color: green		
TPC 16/ 2-STF-10,16	1715251	20
TPC 16/ 3-STF-10,16	1715264	20
TPC 16/ 4-STF-10,16	1715277	20
TPC 16/ 5-STF-10,16	1715280	20
TPC 16/ 6-STF-10,16	1715293	20
TPC 16/ 7-STF-10,16	1715303	20
TPC 16/ 8-STF-10,16	1715316	20
TPC 16/ 9-STF-10,16	1715329	50

Plug-in connectors for power electronics with 5.0 to 15.0 mm pitch

PC 16 series plug-in connectors up to 76 A/16 mm², pitch 10.16 mm

Plugs with screw and spring connection

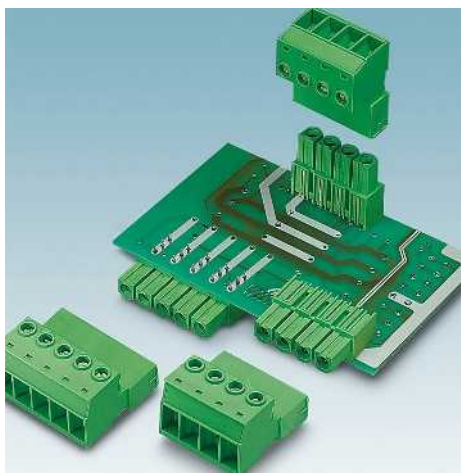

- Inverted IPC 16 plugs with pin contacts for touch-proof device outputs (with IPC 16 G) or free-hanging cable/cable connections
- Unrestricted 600-V-UL approval
- Can be plugged into PC 16 plugs or inverted IPC 16 headers
- The SH versions provide a professional EMC shield and an optional strain relief

Notes:

In accordance with DIN EN 61984, COMBICON plug-in connectors have no switching power. During designated use, they must not be plugged in or disconnected when carrying voltage or under load.

COMBICON select

You will find the possible plug-in connector combinations in COMBICON select at: www.phoenixcontact.net/products or starting on page 488.

When using ferrules for 16 mm² conductors, crimp with CRIMPFOX 16 S (see accessories).

¹⁾ Please observe the derating curves and laboratory data sheets. Derating curves of further combination options on request.



Without screw flange, 600 V UL approval

Accessories		
For all types	Type	Page
	Coding profile CP-PC RD Order No. 1701967	38
	Screwdriver SZS 1,0 x 4,0 Order No. 1205066	
	Marker strips SK 5,0 WH:REEL Order No. 0805221	801
	Crimping pliers for 0.25 to 6 mm ² CRIMPFOX 6 Order No. 1212034	
	Crimping pliers for 10 to 16 mm ² CRIMPFOX 16 S Order No. 1207983	



Dimensional drawing

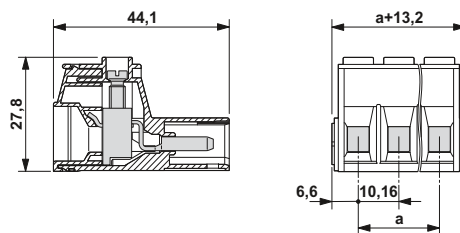

Note derating curves

Derating curves, determined as per
DIN EN 61984 (VDE 0627):2002-09
Representation based on DIN EN 60512-5-2:2003-01
Connected conductor cross section = 16 mm²
Reduction factor = 0.8
Number of positions = see diagram

Technical data

Technical data in accordance to IEC / DIN VDE	
Rated current / conductor cross section	[A] / [mm ²]
Rated insulation voltage for pollution degree 2	[V]
Pitch	[mm]
Connection capacity	
Solid & multi-strand / stranded	[mm ²] / [mm ²] / AWG
Stranded with ferrules without plastic sleeve	[mm ²]
Stranded with ferrules with plastic sleeve	[mm ²]
Multi-conductor connection capacity (two conductors with the same cross section)	
Solid & multi-strand / stranded	[mm ²]
Stranded with ferrules without plastic sleeve	[mm ²]
Stranded with TWIN ferrule with plastic sleeve	[mm ²]
Insulation coordination	
Surge voltage category / pollution degree	III / 3 III / 2 II / 2
Rated insulation voltage	[V]
Rated surge voltage	[kV]
Approval data (UL/CUL)	Use Group
Nominal voltage	[V]
Nominal current	[A]
Connection capacity AWG	AWG
Approval data (CSA)	Use Group
Nominal voltage	[V]
Nominal current	[A]
Connection capacity AWG	AWG
General data	
Stripping length	[mm]
Screw thread	
Tightening torque	[Nm]
Type of insulation material / insulation material group	
Inflammability class according to UL 94	

	76 ¹⁾ / 16
	1000
	10.16
	0.75 - 16 / 0.75 - 16 / 18 - 6
	0.5 - 16
	0.5 - 16
	0.75 - 6 / 0.75 - 6
	0.5 - 4
	0.5 - 6
	III / 3 III / 2 II / 2
	1000 1000 1000
	8 8 6
	B C D
	600 600 -
	55 55 -
	20 - 6 20 - 6 -
	B C D
	- - -
	- - -
	- - -
	12
	M4
	1.7 - 1.8
	PA / I
	V0

Ordering data

No. of pos.	Dim. a [mm]	Type	Order No.	Pcs. / Pkt.
		Pitch 10.16 mm, color: green		
2	10.16	IPC 16/ 2-ST-10,16	1969373	50
3	20.32	IPC 16/ 3-ST-10,16	1969386	50
4	30.48	IPC 16/ 4-ST-10,16	1969399	50
5	40.64	IPC 16/ 5-ST-10,16	1969409	50
6	50.80	IPC 16/ 6-ST-10,16	1969412	50
7	60.96	IPC 16/ 7-ST-10,16	1969425	50
8	71.12	IPC 16/ 8-ST-10,16	1969438	50
9	81.28	IPC 16/ 9-ST-10,16	1969441	50



With screw flange, 600 V UL approval



With screw flange and shield, 600 V UL approval



Dimensional drawing

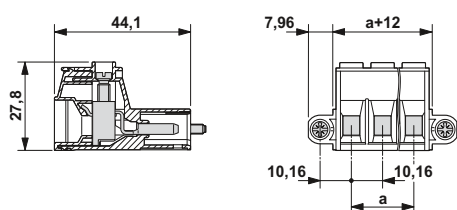

Dimensional drawing

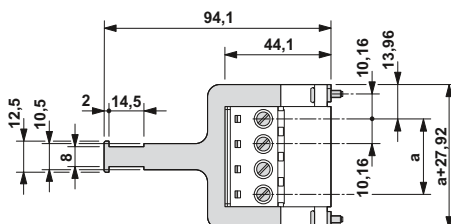

Representative derating curves of the above-mentioned plugs

Type: IPC 16/...-ST-10,16 with DFK-IPC 16/...-G-10,16

Type: IPC 16/...-ST-10,16 with IPC 16/...-G-10,16

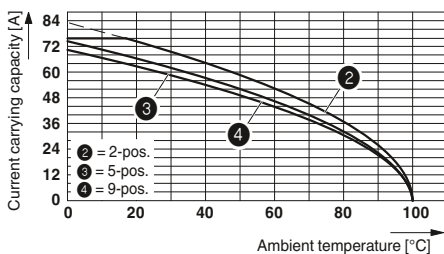
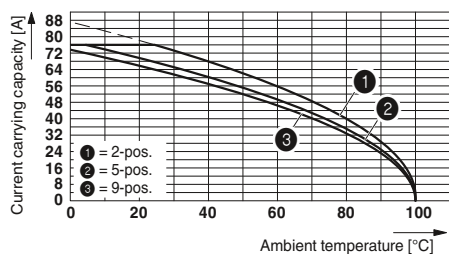

Ordering data

Type	Order No.	Pcs. / Pkt.
Pitch 10.16 mm, color: green		
IPC 16/ 2-STF-10,16	1969454	50
IPC 16/ 3-STF-10,16	1969467	50
IPC 16/ 4-STF-10,16	1969470	50
IPC 16/ 5-STF-10,16	1969483	50
IPC 16/ 6-STF-10,16	1969496	50
IPC 16/ 7-STF-10,16	1969506	50
IPC 16/ 8-STF-10,16	1969519	50
IPC 16/ 9-STF-10,16	1969522	50

Ordering data

Type	Order No.	Pcs. / Pkt.
Pitch 10.16 mm, color: green		
IPC 16/ 3-STF-SH-10,16	1737323	50
IPC 16/ 4-STF-SH-10,16	1970346	50
IPC 16/ 7-STF-SH-10,16	1737336	50

Plug-in connectors for power electronics with 5.0 to 15.0 mm pitch

PC 16 series plug-in connectors up to 76 A/16 mm², pitch 10.16 mm

Plugs with screw and spring connection



- Inverted IPC 16 plugs with pin contacts for free-hanging cable/cable connections
- Increased protection against vibration, thanks to screw-on STGF plugs with a threaded flange (can be plugged onto PC 16 plugs)
- Unrestricted 600-V-UL approval
- The SH versions provide a professional EMC shield and an optional strain relief

Notes:

In accordance with DIN EN 61984, COMBICON plug-in connectors have no switching power. During designated use, they must not be plugged in or disconnected when carrying voltage or under load.

COMBICON select

You will find the possible plug-in connector combinations in COMBICON select at: www.phoenixcontact.net/products or starting on page 488.

When using ferrules for 16 mm² conductors, crimp with CRIMPFOX 16 S (see accessories).

¹⁾ Please observe the derating curves and laboratory data sheets. Derating curves of further combination options on request.



With threaded flange, 600 V UL approval



Dimensional drawing

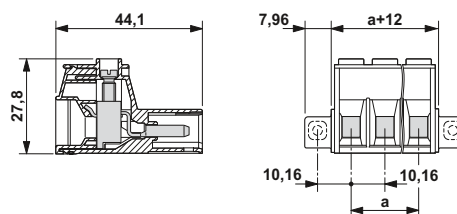

Note derating curves

Derating curves, determined as per DIN EN 61984 (VDE 0627):2002-09
Representation based on DIN EN 60512-5-2:2003-01
Connected conductor cross section = 16 mm²
Reduction factor = 0.8
Number of positions = see diagram

Accessories

For all types	Type	Page
	Coding profile CP-PC RD Order No. 1701967	38
	Screwdriver SZS 1,0 x 4,0 Order No. 1205066	
	Marker strips SK 5,0 WH:REEL Order No. 0805221	801
	Crimping pliers for 0.25 to 6 mm ² CRIMPFOX 6 Order No. 1212034	
	Crimping pliers for 10 to 16 mm ² CRIMPFOX 16 S Order No. 1207983	

Technical data

Technical data in accordance to IEC / DIN VDE	
Rated current / conductor cross section	[A] / [mm ²]
Rated insulation voltage for pollution degree 2	[V]
Pitch	[mm]
Connection capacity	
Solid & multi-strand / stranded	[mm ²] / [mm ²] / AWG
Stranded with ferrules without plastic sleeve	[mm ²]
Stranded with ferrules with plastic sleeve	[mm ²]
Multi-conductor connection capacity (two conductors with the same cross section)	
Solid & multi-strand / stranded	[mm ²]
Stranded with ferrules without plastic sleeve	[mm ²]
Stranded with TWIN ferrule with plastic sleeve	[mm ²]
Insulation coordination	
Surge voltage category / pollution degree	
Rated insulation voltage	[V]
Rated surge voltage	[kV]
Approval data (UL/CUL)	Use Group
Nominal voltage	[V]
Nominal current	[A]
Connection capacity AWG	AWG
Approval data (CSA)	Use Group
Nominal voltage	[V]
Nominal current	[A]
Connection capacity AWG	AWG
General data	
Stripping length	[mm]
Screw thread	
Tightening torque	[Nm]
Type of insulation material / insulation material group	
Inflammability class according to UL 94	

76 ¹⁾ / 16		
1000		
10.16		
0.75 - 16 / 0.75 - 16 / 18 - 6		
0.5 - 16		
0.5 - 16		
0.75 - 6 / 0.75 - 6		
0.5 - 4		
0.5 - 6		
III / 3	III / 2	II / 2
1000	1000	1000
8	8	6
B	C	D
600	600	-
55	55	-
20 - 6	20 - 6	-
B	C	D
-	-	-
-	-	-
-	-	-
12		
M4		
1.7 - 1.8		
PA / I		
V0		

Ordering data

No. of pos.	Dim. a [mm]	Type	Order No.	Pcs. / Pkt.
Pitch 10.16 mm, color: green				
2	10.16	IPC 16/ 2-STGF-10,16	1975817	50
3	20.32	IPC 16/ 3-STGF-10,16	1975820	50
4	30.48	IPC 16/ 4-STGF-10,16	1975833	50
5	40.64	IPC 16/ 5-STGF-10,16	1975846	50
6	50.80	IPC 16/ 6-STGF-10,16	1975859	50
7	60.96	IPC 16/ 7-STGF-10,16	1975862	50
8	71.12	IPC 16/ 8-STGF-10,16	1975875	50
9	81.28	IPC 16/ 9-STGF-10,16	1975888	50



With threaded flange and shield,
600 V UL approval



Dimensional drawing

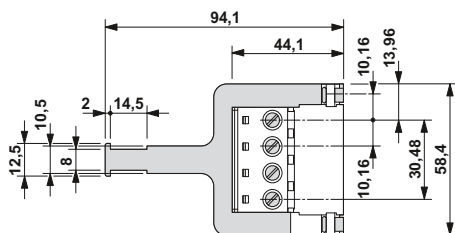

Representative derating curve

Type: PC 16/..-ST-10,16 with IPC 16/..-ST-10,16

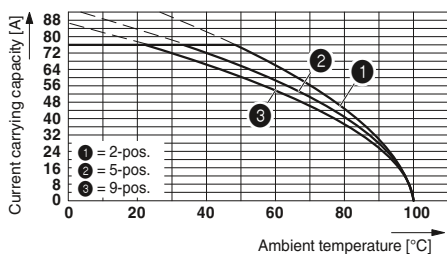

Ordering data

Type	Order No.	Pcs. / Pkt.
Pitch 10.16 mm, color: green		
IPC 16/ 4-STGF-SH-10,16	1975891	50

Plug-in connectors for power electronics with 5.0 to 15.0 mm pitch

PC 16 series plug-in connectors up to 76 A/16 mm², pitch 10.16 mm

Plugs with screw and spring connection

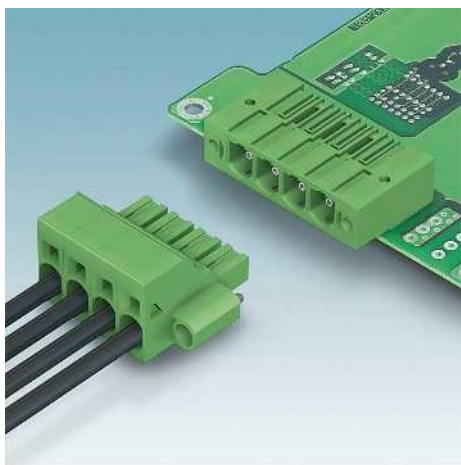

- Push-in spring connection plug with a current carrying capacity of 76 A
- Fast connection technology, thanks to principle of direct plug-in without tools
- Unrestricted 600-V-UL approval
- Maximum contact safety, thanks to an integrated double steel spring
- The SH versions provide a professional shield and an optional strain relief
- CP-PC RD coding profile

Notes:

In accordance with DIN EN 61984, COMBICON plug-in connectors have no switching power. During designated use, they must not be plugged in or disconnected when carrying voltage or under load.

COMBICON select

You will find the possible plug-in connector combinations in COMBICON select at: www.phoenixcontact.net/products or starting on page 488.

When using ferrules for 16 mm² conductors, crimp with CRIMPFOX 16 S (see accessories).

¹⁾ Please observe the derating curves and laboratory data sheets. Derating curves of further combination options on request.

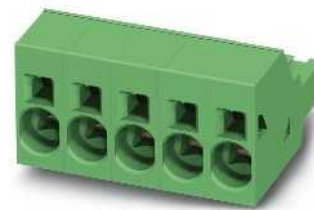

Without screw flange, 600 V UL approval



Dimensional drawing

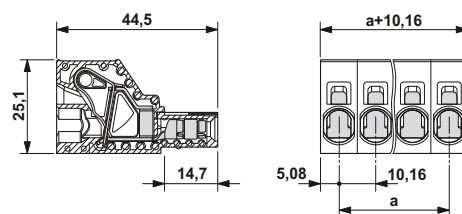

Note derating curves

Derating curves, determined as per DIN EN 61984 (VDE 0627):2002-09
Representation based on DIN EN 60512-5-2:2003-01
Connected conductor cross section = 16 mm²
Reduction factor = 0.8
Number of positions = see diagram

Accessories		
For all types	Type	Page
	Coding profile CP-PC RD Order No. 1701967	38
	Screwdriver SZF 2-0,8 x4,0 Order No. 1204520	
	Marker strips SK 5,0 WH:REEL Order No. 0805221	801
	Crimping pliers for 0.25 to 6 mm ² CRIMPFOX 6 Order No. 1212034	
	Crimping pliers for 10 to 16 mm ² CRIMPFOX 16 S Order No. 1207983	

Technical data

Technical data in accordance to IEC / DIN VDE	
Rated current / conductor cross section	[A] / [mm ²]
Rated insulation voltage for pollution degree 2	[V]
Pitch	[mm]
Connection capacity	
Solid & multi-strand / stranded	[mm ²] / [mm ²] / AWG
Stranded with ferrules without plastic sleeve	[mm ²]
Stranded with ferrules with plastic sleeve	[mm ²]
Multi-conductor connection capacity (two conductors with the same cross section)	
Solid & multi-strand / stranded	[mm ²]
Stranded with ferrules without plastic sleeve	[mm ²]
Stranded with TWIN ferrule with plastic sleeve	[mm ²]
Insulation coordination	
Surge voltage category / pollution degree	III / 3 III / 2 II / 2
Rated insulation voltage	[V]
Rated surge voltage	[kV]
Approval data (UL/CUL)	Use Group
Nominal voltage	[V]
Nominal current	[A]
Connection capacity AWG	AWG
Approval data (CSA)	Use Group
Nominal voltage	[V]
Nominal current	[A]
Connection capacity AWG	AWG
General data	
Stripping length	[mm]
Type of insulation material / insulation material group	
Inflammability class according to UL 94	

	76 ¹⁾ / 16
	1000
	10.16
	0.75 - 16 / 0.75 - 16 / 18 - 4
	0.75 - 16
	0.75 - 10
	- / -
	-
	0.75 - 4
	III / 3 III / 2 II / 2
	1000 1000 1000
	8 8 6
	B C D
	600 600 -
	66 66 -
	20 - 4 20 - 4 -
	B C D
	- - -
	- - -
	- - -
	18
	PA / I
	V0

Ordering data

No. of pos.	Dim. a [mm]	Type	Order No.	Pcs. / Pkt.
Pitch 10.16 mm, color: green				
2	10.16	SPC 16/ 2-ST-10,16	1711268	50
3	20.32	SPC 16/ 3-ST-10,16	1711271	50
4	30.48	SPC 16/ 4-ST-10,16	1711284	50
5	40.64	SPC 16/ 5-ST-10,16	1711297	50
6	50.80	SPC 16/ 6-ST-10,16	1711307	50
7	60.96	SPC 16/ 7-ST-10,16	1711310	50
8	71.12	SPC 16/ 8-ST-10,16	1711323	50
9	81.28	SPC 16/ 9-ST-10,16	1711336	50

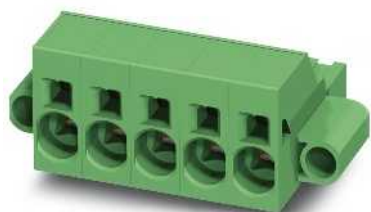

With screw flange, 600 V UL approval



With screw flange and shield, 600 V UL approval



Dimensional drawing

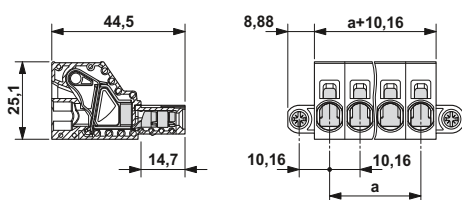

Dimensional drawing

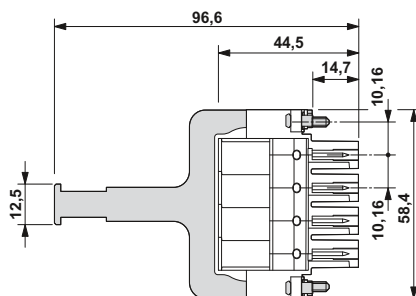

Representative derating curve

Type: SPC 16/...-ST-10,16 with PC 6-16/...-G1-10,16

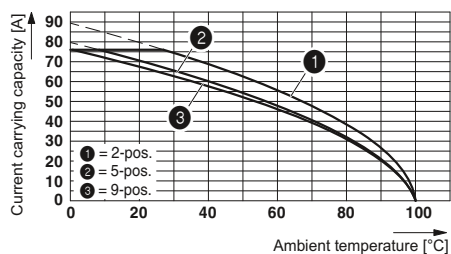

Ordering data

Type	Order No.	Pcs. / Pkt.
Pitch 10.16 mm, color: green		
SPC 16/ 2-STF-10,16	1711378	50
SPC 16/ 3-STF-10,16	1711381	50
SPC 16/ 4-STF-10,16	1711394	50
SPC 16/ 5-STF-10,16	1711404	50
SPC 16/ 6-STF-10,16	1711417	50
SPC 16/ 7-STF-10,16	1711420	50
SPC 16/ 8-STF-10,16	1711433	50
SPC 16/ 9-STF-10,16	1711446	50

Ordering data

Type	Order No.	Pcs. / Pkt.
Pitch 10.16 mm, color: green		
SPC 16/ 4-STF-SH-10,16	1711488	50

Plug-in connectors for power electronics with 5.0 to 15.0 mm pitch

PC 16 series plug-in connectors up to 76 A/16 mm², pitch 10.16 mm

Plugs with screw and spring connection

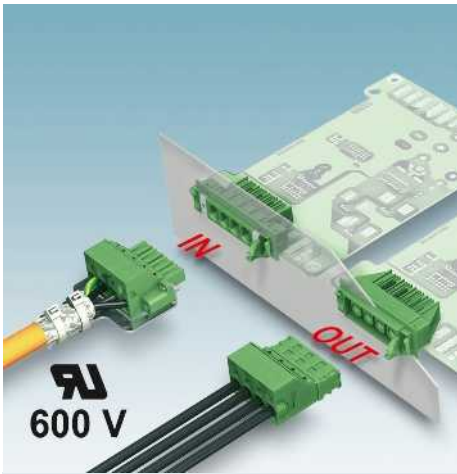

- Inverted ISPC 16 push-in spring connection plugs with pin contact for touch-proof device outputs (with IPC 16 G) or free-hanging cable/cable connections
- Unrestricted 600-V-UL approval
- Can be plugged into (S)PC 16 plugs or inverted IPC 16 headers
- Increased vibration protection, thanks to screw-on STF plug with screw flange
- STGF plugs with threaded flange for free hanging cable/cable connections

Notes:

In accordance with DIN EN 61984, COMBICON plug-in connectors have no switching power. During designated use, they must not be plugged in or disconnected when carrying voltage or under load.

COMBICON select

You will find the possible plug-in connector combinations in COMBICON select at: www.phoenixcontact.net/products or starting on page 488.

When using ferrules for 16 mm² conductors, crimp with CRIMPFOX 16 S (see accessories).

¹⁾ Please observe the derating curves and laboratory data sheets. Derating curves of further combination options on request.



Without screw flange, 600 V UL approval



Dimensional drawing

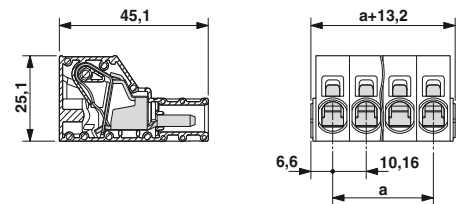

Note derating curves

Derating curves, determined as per DIN EN 61984 (VDE 0627):2002-09
Representation based on DIN EN 60512-5-2:2003-01
Connected conductor cross section = 16 mm²
Reduction factor = 0.8
Number of positions = see diagram

Accessories

For all types	Type	Page
	Coding profile CP-PC RD Order No. 1701967	38
	Screwdriver SZF 2-0,8 x4,0 Order No. 1204520	
	Marker strips SK 5,0 WH:REEL Order No. 0805221	801
	Crimping pliers for 0.25 to 6 mm ² CRIMPFOX 6 Order No. 1212034	
	Crimping pliers for 10 to 16 mm ² CRIMPFOX 16 S Order No. 1207983	

Technical data

Technical data in accordance to IEC / DIN VDE	
Rated current / conductor cross section	[A] / [mm ²]
Rated insulation voltage for pollution degree 2	[V]
Pitch	[mm]
Connection capacity	
Solid & multi-strand / stranded	[mm ²] / [mm ²] / AWG
Stranded with ferrules without plastic sleeve	[mm ²]
Stranded with ferrules with plastic sleeve	[mm ²]
Multi-conductor connection capacity (two conductors with the same cross section)	
Solid & multi-strand / stranded	[mm ²]
Stranded with ferrules without plastic sleeve	[mm ²]
Stranded with TWIN ferrule with plastic sleeve	[mm ²]
Insulation coordination	
Surge voltage category / pollution degree	III / 3 III / 2 II / 2
Rated insulation voltage	[V]
Rated surge voltage	[kV]
Approval data (UL/CUL)	Use Group
Nominal voltage	[V]
Nominal current	[A]
Connection capacity AWG	AWG
Approval data (CSA)	Use Group
Nominal voltage	[V]
Nominal current	[A]
Connection capacity AWG	AWG
General data	
Stripping length	[mm]
Type of insulation material / insulation material group	
Inflammability class according to UL 94	

	76 ¹⁾ / 16
	1000
	10.16
	0.75 - 16 / 0.75 - 16 / 18 - 4
	0.75 - 16
	0.75 - 10
	- / -
	-
	0.75 - 4
	III / 3 III / 2 II / 2
	1000 1000 1000
	8 8 6
	B C D
	600 600 -
	66 66 -
	20 - 4 20 - 4 -
	B C D
	- - -
	- - -
	- - -
	18
	PA / I
	V0

Ordering data

Type	Order No.	Pcs. / Pkt.
Pitch 10.16 mm, color: green		
ISPC 16/ 2-ST-10,16	1748545	50
ISPC 16/ 3-ST-10,16	1748558	50
ISPC 16/ 4-ST-10,16	1748561	50
ISPC 16/ 5-ST-10,16	1748574	50
ISPC 16/ 6-ST-10,16	1748587	50
ISPC 16/ 7-ST-10,16	1748590	50
ISPC 16/ 8-ST-10,16	1748600	50
ISPC 16/ 9-ST-10,16	1748613	50



With screw flange, 600 V UL approval



With threaded flange, 600 V UL approval



Dimensional drawing

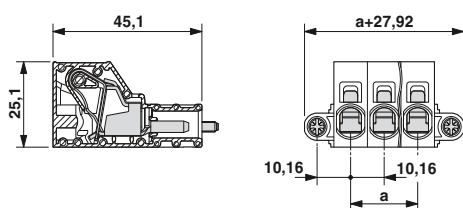

Dimensional drawing

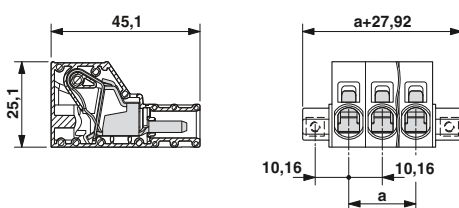

Representative derating curves of the above-mentioned plugs

Type: ISPC 16/...-ST-10,16 with IPC 16/...-G-10,16

Type: ISPC 16/...-ST-10,16 with SPC 16/...-ST-10,16

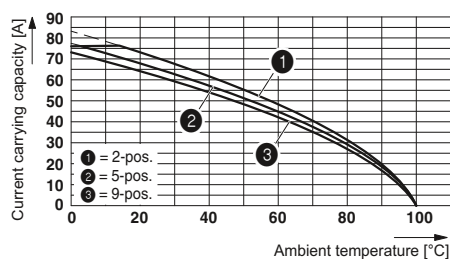
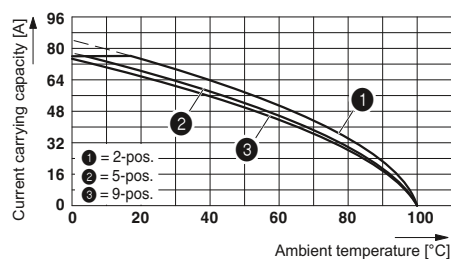

Ordering data

Type	Order No.	Pcs. / Pkt.
Pitch 10.16 mm, color: green		
ISPC 16/ 2-STF-10,16	1748626	50
ISPC 16/ 3-STF-10,16	1748639	50
ISPC 16/ 4-STF-10,16	1748642	50
ISPC 16/ 5-STF-10,16	1748655	50
ISPC 16/ 6-STF-10,16	1748668	50
ISPC 16/ 7-STF-10,16	1748671	50
ISPC 16/ 8-STF-10,16	1748684	50
ISPC 16/ 9-STF-10,16	1748697	50

Ordering data

Type	Order No.	Pcs. / Pkt.
Pitch 10.16 mm, color: green		
ISPC 16/ 2-STGF-10,16	1748707	50
ISPC 16/ 3-STGF-10,16	1748710	50
ISPC 16/ 4-STGF-10,16	1748723	50
ISPC 16/ 5-STGF-10,16	1748736	50
ISPC 16/ 6-STGF-10,16	1748749	50
ISPC 16/ 7-STGF-10,16	1748752	50
ISPC 16/ 8-STGF-10,16	1748765	50
ISPC 16/ 9-STGF-10,16	1748778	50

Plug-in connectors for power electronics with 5.0 to 15.0 mm pitch

PC 16 series plug-in connectors up to 76 A/16 mm², pitch 10.16 mm

Headers with pin contact



- PC 6-16 headers for use in combination with all PC 6 and PC 16 plugs
- PCB-PCB connections by using IPC 16 headers
- G1U versions for a solder-in direction rotated by 180°
- Shroud PCB-SHIELD for a professional EMC shield connection
- Threaded flange G1F (also for screw connection on the PCB or in the device)
- Suitable for 600 V UL when used in combination with PC 16 screw and spring-cage plugs

Notes:

In accordance with DIN EN 61984, COMBICON plug-in connectors have no switching power. During designated use, they must not be plugged in or disconnected when carrying voltage or under load.

COMBICON select
You will find the possible plug-in connector combinations in COMBICON select at: www.phoenixcontact.net/products or starting on page 488.

Mounting screw for PC-6-16/...-G1F-10,16 and PC 6-16/...-G1FU-10,16: sheet metal screw ISO 1481-ST 2,9 C. Screw connection only permitted prior to soldering.

1) Please observe the derating curves and laboratory data sheets. Derating curves of further combination options on request.



Without threaded flange



Accessories

For all types	Type	Page
	Coding profile CP-PC RD Order No. 1701967	38
	Coding pin CS-IPC 16/6 Order No. 1970016	38
	Marker strips SK 5,0 WH:REEL Order No. 0805221	801
Only for PC 6-16/...-G1(U)-10,16		
	Shroud POWER COMBICON PCB-SHIELD Order No. 1968387	

Dimensional drawing

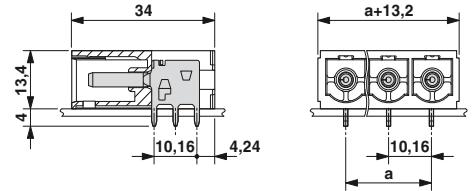

Drilling diagram

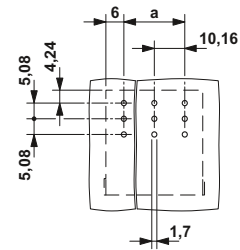

Technical data

Technical data in accordance to IEC / DIN VDE	
Rated current	[A]
Rated insulation voltage for pollution degree 2	[V]
Pitch	[mm]
Insulation coordination	
Surge voltage category / pollution degree	
Rated insulation voltage	[V]
Rated surge voltage	[kV]
Approval data (UL/CUL)	Use Group
Nominal voltage	[V]
Nominal current	[A]
Connection capacity AWG	AWG
Approval data (CSA)	Use Group
Nominal voltage	[V]
Nominal current	[A]
Connection capacity AWG	AWG
General data	
Type of insulation material / insulation material group	
Inflammability class according to UL 94	
Drill hole diameter / pin dimensions	[mm]

	76 ¹⁾
	1000
	10.16
	III / 3 III / 2 II / 2
	1000 1000 1000
	8 8 6
	B C D
	300 300 600
	66 66 5
	- - -
	B C D
	- - -
	- - -
	- - -
	PA / I
	V0
	1.7 / 1 x 1.2 mm

No. of pos.	Dim. a [mm]
2	10.16
3	20.32
4	30.48
5	40.64
6	50.80
7	60.96
8	71.12
9	81.28

Ordering data

Type	Order No.	Pcs. / Pkt.
Pitch 10.16 mm, color: green		
PC 6-16/ 2-G1-10,16	1998933	50
PC 6-16/ 3-G1-10,16	1998946	50
PC 6-16/ 4-G1-10,16	1998959	50
PC 6-16/ 5-G1-10,16	1998962	50
PC 6-16/ 6-G1-10,16	1998975	50
PC 6-16/ 7-G1-10,16	1998988	50
PC 6-16/ 8-G1-10,16	1998991	50
PC 6-16/ 9-G1-10,16	1996391	50

Plug-in connectors for power electronics with 5.0 to 15.0 mm pitch

PC 16 series plug-in connectors up to 76 A/16 mm², pitch 10.16 mm



With threaded flange



Rotated 180°, without threaded flange



Rotated 180°, with threaded flange



Dimensional drawing

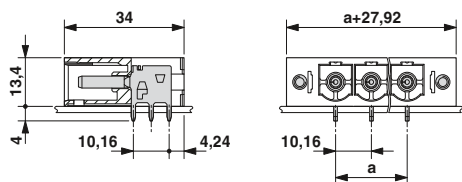

Drilling diagram

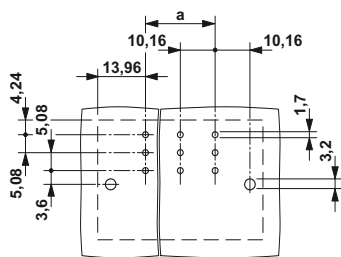

Ordering data

Type	Order No.	Pcs. / Pkt.
Pitch 10.16 mm, color: green		
PC 6-16/ 2-G1F-10,16	1999000	50
PC 6-16/ 3-G1F-10,16	1999013	50
PC 6-16/ 4-G1F-10,16	1999026	50
PC 6-16/ 5-G1F-10,16	1999039	50
PC 6-16/ 6-G1F-10,16	1999042	50
PC 6-16/ 7-G1F-10,16	1999055	50
PC 6-16/ 8-G1F-10,16	1999068	50
PC 6-16/ 9-G1F-10,16	1996401	50



Dimensional drawing

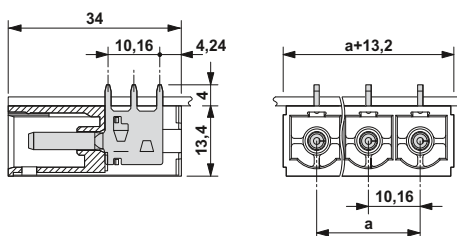

Drilling diagram

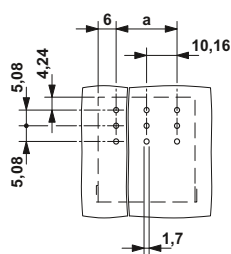

Ordering data

Type	Order No.	Pcs. / Pkt.
Pitch 10.16 mm, color: green		
PC 6-16/ 2-G1U-10,16	1996236	50
PC 6-16/ 3-G1U-10,16	1996249	50
PC 6-16/ 4-G1U-10,16	1996252	50
PC 6-16/ 5-G1U-10,16	1996265	50
PC 6-16/ 6-G1U-10,16	1996278	50
PC 6-16/ 7-G1U-10,16	1996281	50
PC 6-16/ 8-G1U-10,16	1996294	50
PC 6-16/ 9-G1U-10,16	1996304	50



Dimensional drawing

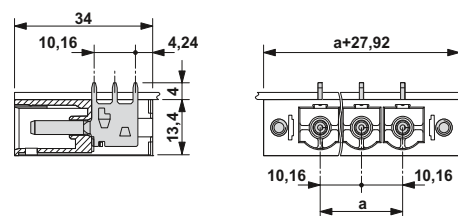

Drilling diagram

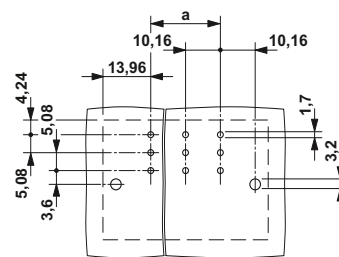

Ordering data

Type	Order No.	Pcs. / Pkt.
Pitch 10.16 mm, color: green		
PC 6-16/ 2-G1FU-10,16	1996317	50
PC 6-16/ 3-G1FU-10,16	1996320	50
PC 6-16/ 4-G1FU-10,16	1996333	50
PC 6-16/ 5-G1FU-10,16	1996346	50
PC 6-16/ 6-G1FU-10,16	1996359	50
PC 6-16/ 7-G1FU-10,16	1996362	50
PC 6-16/ 8-G1FU-10,16	1996375	50
PC 6-16/ 9-G1FU-10,16	1996388	50

Plug-in connectors for power electronics with 5.0 to 15.0 mm pitch

PC 16 series plug-in connectors up to 76 A/16 mm², pitch 10.16 mm

Headers with pin contact

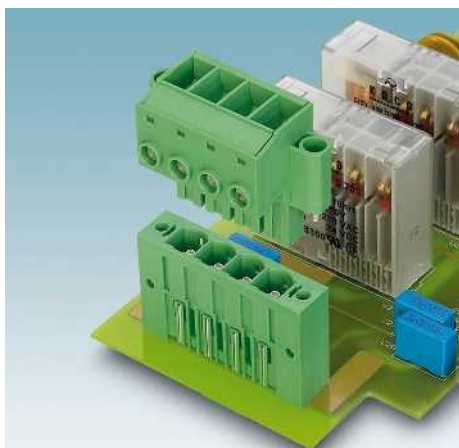

- Vertical PCV 6-16 headers for use in combination with all PC 6 and PC 16 plugs
- PCB-PCB connections by using IPC 16 headers
- Threaded flange G1F (also for screw connection on the PCB or in the device)
- CS-IPC 16/6 to serve as an anti-rotation element during assembly
- Suitable for 600 V UL when used in combination with PC 16 screw and spring-cage plugs

Notes:

In accordance with DIN EN 61984, COMBICON plug-in connectors have no switching power. During designated use, they must not be plugged in or disconnected when carrying voltage or under load.

COMBICON select

You will find the possible plug-in connector combinations in COMBICON select at: www.phoenixcontact.net/products or starting on page 488.

Mounting screw for PCV 6-16/...-G1F-10.16: sheet metal screw ISO 1481-ST 2,9 C. Screw connection only permitted prior to soldering.

1) Please observe the derating curves and laboratory data sheets. Derating curves of further combination options on request.



Without threaded flange



Dimensional drawing

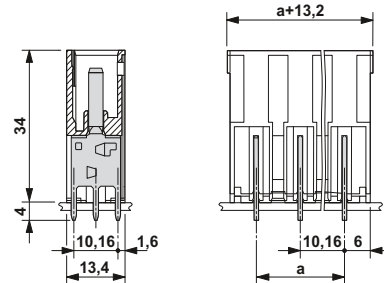

Drilling diagram

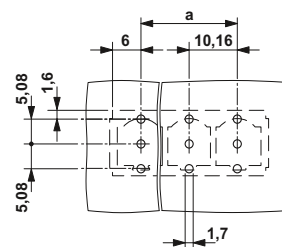

Accessories

For all types	Type	Page
	Coding profile CP-PC RD Order No. 1701967	38
	Coding pin CS-IPC 16/6 Order No. 1970016	38
	Marker strips SK 5,0 WH:REEL Order No. 0805221	801

Technical data

Technical data in accordance to IEC / DIN VDE

Rated current	[A]	76 ¹⁾
Rated insulation voltage for pollution degree 2	[V]	1000
Pitch	[mm]	10.16
Insulation coordination		
Surge voltage category / pollution degree		III / 3 III / 2 II / 2
Rated insulation voltage	[V]	1000 1000 1000
Rated surge voltage	[kV]	6 8 8
Approval data (UL/CUL)	Use Group	B C D
Nominal voltage	[V]	300 300 600
Nominal current	[A]	66 66 5
Connection capacity AWG	AWG	- - -
Approval data (CSA)	Use Group	B C D
Nominal voltage	[V]	- - -
Nominal current	[A]	- - -
Connection capacity AWG	AWG	- - -
General data		
Type of insulation material / insulation material group		PA / I
Inflammability class according to UL 94		V0
Drill hole diameter / pin dimensions	[mm]	1.7 / 1 x 1.2 mm

Ordering data

No. of pos.	Dim. a [mm]	Type	Order No.	Pcs. / Pkt.
		Pitch 10.16 mm, color: green		
2	10.16	PCV 6-16/ 2-G1-10,16	1998784	50
3	20.32	PCV 6-16/ 3-G1-10,16	1998797	50
4	30.48	PCV 6-16/ 4-G1-10,16	1998807	50
5	40.64	PCV 6-16/ 5-G1-10,16	1998810	50
6	50.80	PCV 6-16/ 6-G1-10,16	1998823	50
7	60.96	PCV 6-16/ 7-G1-10,16	1998836	50
8	71.12	PCV 6-16/ 8-G1-10,16	1998849	50
9	81.28	PCV 6-16/ 9-G1-10,16	1998852	50



With threaded flange



Dimensional drawing

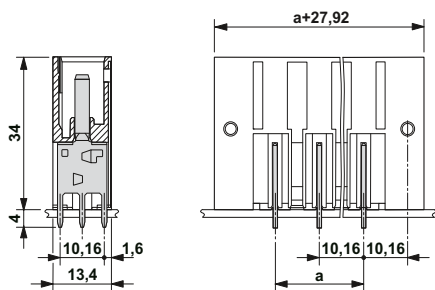

Drilling diagram

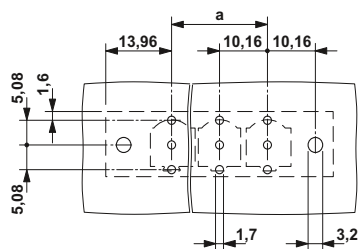

Ordering data

Type	Order No.	Pcs. / Pkt.
Pitch 10.16 mm, color: green		
PCV 6-16/ 2-G1F-10,16	1998865	50
PCV 6-16/ 3-G1F-10,16	1998878	50
PCV 6-16/ 4-G1F-10,16	1998881	50
PCV 6-16/ 5-G1F-10,16	1998894	50
PCV 6-16/ 6-G1F-10,16	1998904	50
PCV 6-16/ 7-G1F-10,16	1998917	50
PCV 6-16/ 8-G1F-10,16	1998920	50
PCV 6-16/ 9-G1F-10,16	1996414	50

Plug-in connectors for power electronics with 5.0 to 15.0 mm pitch

PC 16 series plug-in connectors up to 76 A/16 mm², pitch 10.16 mm

Headers with socket contact

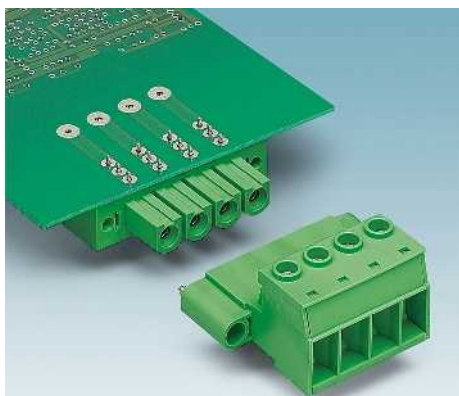

- An inverted IPC 16 header to implement a touch-proof PCB output or a PCB-PCB-connection (in combination with PC 6-16 base strips)
- GU versions for a solder-in direction rotated by 180°
- Threaded flange GF (also for screw connection on the PCB or in the device)
- Shroud PCB-SHIELD (EMC connection)
- Suitable for 600 V UL when used in combination with PC 16 screw and spring-cage plugs

Notes:

In accordance with DIN EN 61984, COMBICON plug-in connectors have no switching power. During designated use, they must not be plugged in or disconnected when carrying voltage or under load.

COMBICON select

You will find the possible plug-in connector combinations in COMBICON select at: www.phoenixcontact.net/products or starting on page 488.

Mounting screw for IPC 16/...-GF-10,16 and IPC 16/...-GFU-10,16: sheet metal screw ISO 1481-ST 2,9 C. Screw connection only permitted prior to soldering.

1) Please observe the derating curves and laboratory data sheets. Derating curves of further combination options on request.



Without threaded flange



Dimensional drawing

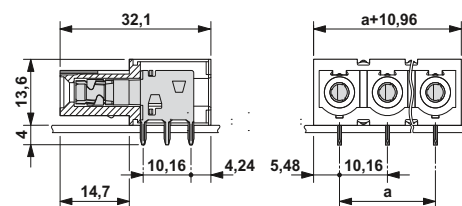

Drilling diagram

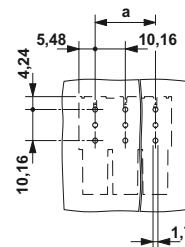

Accessories

For all types	Type	Page
	Coding profile CP-PC RD Order No. 1701967	38
	Coding pin CS-IPC 16/6 Order No. 1970016	38
	Marker strips SK 5,0 WH:REEL Order No. 0805221	801
Only for IPC 16/...-G(F)U-10,6		
	Shroud POWER COMBICON PCB-SHIELD Order No. 1968387	

Technical data

Technical data in accordance to IEC / DIN VDE

Rated current	[A]	76 ¹⁾
Rated insulation voltage for pollution degree 2	[V]	1000
Pitch	[mm]	10.16
Insulation coordination		
Surge voltage category / pollution degree		III / 3 III / 2 II / 2
Rated insulation voltage	[V]	1000 1000 1000
Rated surge voltage	[kV]	8 8 8
Approval data (UL/CUL)	Use Group	B C D
Nominal voltage	[V]	300 300 600
Nominal current	[A]	66 66 5
Connection capacity AWG	AWG	- - -
Approval data (CSA)	Use Group	B C D
Nominal voltage	[V]	- - -
Nominal current	[A]	- - -
Connection capacity AWG	AWG	- - -
General data		
Type of insulation material / insulation material group		PA / I
Inflammability class according to UL 94		V0
Drill hole diameter / pin dimensions	[mm]	1.7 / 0.8 x 1.2

No. of pos.	Dim. a [mm]
2	10.16
3	20.32
4	30.48
5	40.64
6	50.80
7	60.96
8	71.12
9	81.28

Ordering data

Type	Order No.	Pcs. / Pkt.
Pitch 10.16 mm, color: green		
IPC 16/ 2-G-10,16	1969535	50
IPC 16/ 3-G-10,16	1969548	50
IPC 16/ 4-G-10,16	1969551	50
IPC 16/ 5-G-10,16	1969564	50
IPC 16/ 6-G-10,16	1969577	50
IPC 16/ 7-G-10,16	1969580	50
IPC 16/ 8-G-10,16	1969593	50
IPC 16/ 9-G-10,16	1969603	50

Plug-in connectors for power electronics with 5.0 to 15.0 mm pitch

PC 16 series plug-in connectors up to 76 A/16 mm², pitch 10.16 mm



With threaded flange



Rotated 180°, without threaded flange



Rotated 180°, with threaded flange



Dimensional drawing

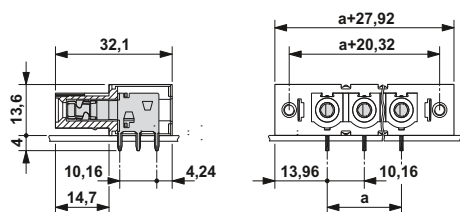

Drilling diagram

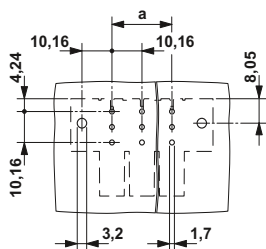

Dimensional drawing

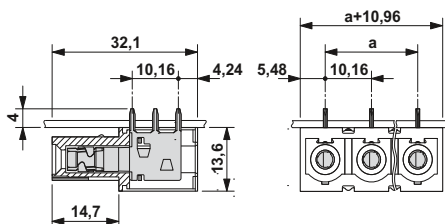

Drilling diagram

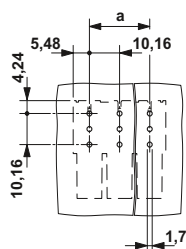

Dimensional drawing

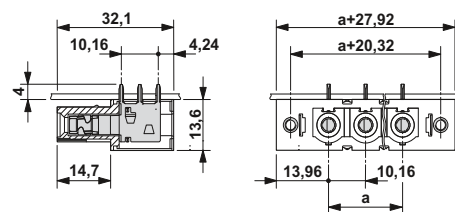

Drilling diagram

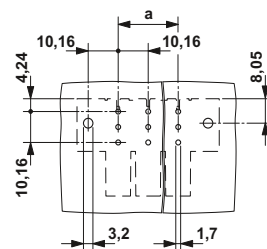

Ordering data

Type	Order No.	Pcs. / Pkt.
Pitch 10.16 mm, color: green		
IPC 16/ 2-GF-10,16	1969616	50
IPC 16/ 3-GF-10,16	1969629	50
IPC 16/ 4-GF-10,16	1969632	50
IPC 16/ 5-GF-10,16	1969645	50
IPC 16/ 6-GF-10,16	1969658	50
IPC 16/ 7-GF-10,16	1969661	50
IPC 16/ 8-GF-10,16	1969674	50
IPC 16/ 9-GF-10,16	1969687	50

Ordering data

Type	Order No.	Pcs. / Pkt.
Pitch 10.16 mm, color: green		
IPC 16/ 2-GU-10,16	1969852	50
IPC 16/ 3-GU-10,16	1969865	50
IPC 16/ 4-GU-10,16	1969878	50
IPC 16/ 5-GU-10,16	1969881	50
IPC 16/ 6-GU-10,16	1969894	50
IPC 16/ 7-GU-10,16	1969904	50
IPC 16/ 8-GU-10,16	1969917	50
IPC 16/ 9-GU-10,16	1969920	50

Ordering data

Type	Order No.	Pcs. / Pkt.
Pitch 10.16 mm, color: green		
IPC 16/ 2-GFU-10,16	1969933	50
IPC 16/ 3-GFU-10,16	1969946	50
IPC 16/ 4-GFU-10,16	1969959	50
IPC 16/ 5-GFU-10,16	1969962	50
IPC 16/ 6-GFU-10,16	1969975	50
IPC 16/ 7-GFU-10,16	1969988	50
IPC 16/ 8-GFU-10,16	1969991	50
IPC 16/ 9-GFU-10,16	1970003	50

Plug-in connectors for power electronics with 5.0 to 15.0 mm pitch

PC 16 series plug-in connectors up to 76 A/16 mm², pitch 10.16 mm

Headers with socket contact



- An inverted IPC 16 header in a vertical design to implement a touch-proof PCB output or a PCB-PCB connection (in combination with PC 6-16 base strips)
- Integrated double steel spring
- Threaded flange GF (also for screw connection on the PCB or in the device)
- CS-IPC 16/6 to serve as an anti-rotation element during assembly
- Suitable for 600 V UL when used in combination with PC 16 screw and spring-cage plugs

Notes:
In accordance with DIN EN 61984, COMBICON plug-in connectors have no switching power. During designated use, they must not be plugged in or disconnected when carrying voltage or under load.
COMBICON select You will find the possible plug-in connector combinations in COMBICON select at: www.phoenixcontact.net/products or starting on page 488.
Mounting screw for IPCV 16/...-GF-10,16: sheet metal screw ISO 1481-ST 2,9 C. Screw connection only permitted prior to soldering.
1) Please observe the derating curves and laboratory data sheets. Derating curves of further combination options on request.



Without threaded flange



Dimensional drawing

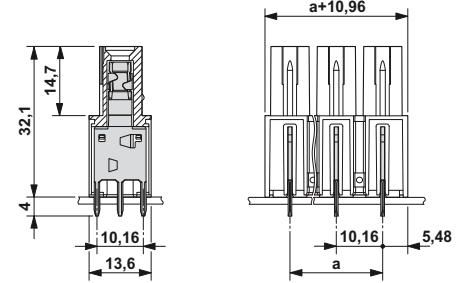

Drilling diagram

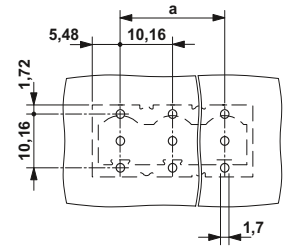

Accessories		
For all types	Type	Page
	Coding profile CP-PC RD Order No. 1701967	38
	Coding pin CS-IPC 16/6 Order No. 1970016	38
	Marker strips SK 5,0 WH:REEL Order No. 0805221	801

Technical data

Technical data in accordance to IEC / DIN VDE		
Rated current	[A]	76 ¹⁾
Rated insulation voltage for pollution degree 2	[V]	1000
Pitch	[mm]	10.16
Insulation coordination		
Surge voltage category / pollution degree		III / 3 III / 2 II / 2
Rated insulation voltage	[V]	1000 1000 1000
Rated surge voltage	[kV]	8 8 8
Approval data (UL/CUL)	Use Group	B C D
Nominal voltage	[V]	300 300 600
Nominal current	[A]	66 66 5
Connection capacity AWG	AWG	- - -
Approval data (CSA)	Use Group	B C D
Nominal voltage	[V]	- - -
Nominal current	[A]	- - -
Connection capacity AWG	AWG	- - -
General data		
Type of insulation material / insulation material group		PA / I
Inflammability class according to UL 94		V0
Drill hole diameter / pin dimensions	[mm]	1.7 / 0.8 x 1.2

Ordering data

No. of pos.	Dim. a [mm]	Type	Order No.	Pcs. / Pkt.
Pitch 10.16 mm, color: green				
2	10.16	IPCV 16/ 2-G-10,16	1969690	50
3	20.32	IPCV 16/ 3-G-10,16	1969700	50
4	30.48	IPCV 16/ 4-G-10,16	1969713	50
5	40.64	IPCV 16/ 5-G-10,16	1969726	50
6	50.80	IPCV 16/ 6-G-10,16	1969739	50
7	60.96	IPCV 16/ 7-G-10,16	1969742	50
8	71.12	IPCV 16/ 8-G-10,16	1969755	50
9	81.28	IPCV 16/ 9-G-10,16	1969768	50



With threaded flange



Dimensional drawing

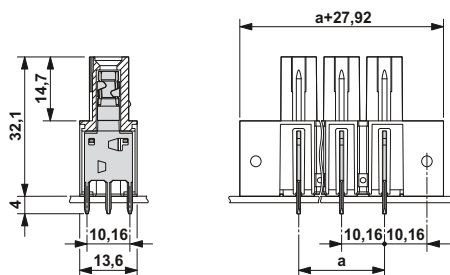

Drilling diagram

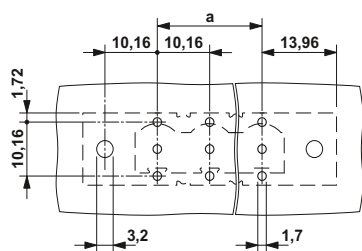

Ordering data

Type	Order No.	Pcs. / Pkt.
Pitch 10.16 mm, color: green		
IPCV 16/ 2-GF-10,16	1969771	50
IPCV 16/ 3-GF-10,16	1969784	50
IPCV 16/ 4-GF-10,16	1969797	50
IPCV 16/ 5-GF-10,16	1969807	50
IPCV 16/ 6-GF-10,16	1969810	50
IPCV 16/ 7-GF-10,16	1969823	50
IPCV 16/ 8-GF-10,16	1969836	50
IPCV 16/ 9-GF-10,16	1969849	50

Plug-in connectors for power electronics with 5.0 to 15.0 mm pitch

PC 16 series plug-in connectors up to 76 A/16 mm², pitch 10.16 mm

Feed-through headers with pin/socket contact

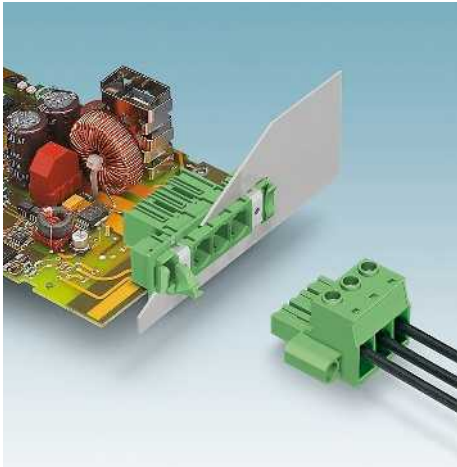

- Feed-through headers for use in combination with all PC 6 and PC 16 plugs
- To solder onto the PCB
- Mounting on the housing wall using the snap-lock mechanism to be operated without tools or the classical screw connection
- Wall thicknesses from 1 mm to 3 mm
- In GF versions, shielding functions can be executed on the housing wall
- Suitable for 600 V UL when used in combination with PC 16 screw and spring-cage plugs

Notes:

In accordance with DIN EN 61984, COMBICON plug-in connectors have no switching power. During designated use, they must not be plugged in or disconnected when carrying voltage or under load.

COMBICON select
You will find the possible plug-in connector combinations in COMBICON select at: www.phoenixcontact.net/products or starting on page 488.

The cutout dimensions and mounting options for the feed-through versions can be found on page 595.

Mounting screw for DFK-PC 6-16/...-G-10,16 and DFK-PC 6-16/...-GU-10,16: sheet metal screw ISO 1481-ST 2,9 C. Screw connection only permitted prior to soldering.

1) Please observe the derating curves and laboratory data sheets. Derating curves of further combination options on request.

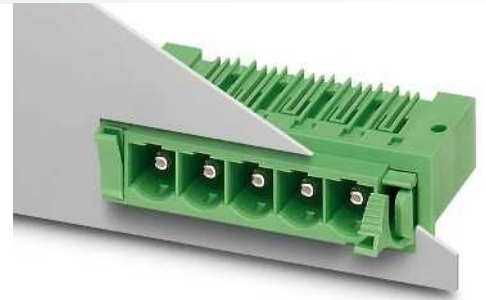

Without threaded flange



Dimensional drawing

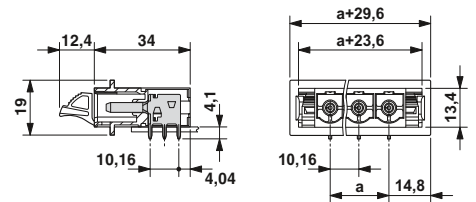

Drilling diagram

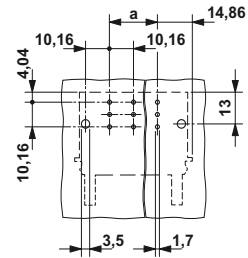

Accessories

For all types	Type	Page
	Coding profile CP-PC RD Order No. 1701967	38
	Coding pin CS-IPC 16/6 Order No. 1970016	38
	Screws for mounting on the housing panel DFK-PC 16-SS Order No. 1705449	
	Marker strips SK 5,0 WH:REEL Order No. 0805221	801

Technical data

Technical data in accordance to IEC / DIN VDE	
Rated current	[A] 76 ¹⁾
Rated insulation voltage for pollution degree 2	[V] 1000
Pitch	[mm] 10.16
Insulation coordination	
Surge voltage category / pollution degree	III / 3 III / 2 II / 2
Rated insulation voltage	[V] 1000 1000 1000
Rated surge voltage	[kV] 8 8 6
Approval data (UL/CUL)	Use Group B C D
Nominal voltage	[V] 300 300 600
Nominal current	[A] 66 66 5
Connection capacity AWG	AWG - - -
Approval data (CSA)	Use Group B C D
Nominal voltage	[V] - - -
Nominal current	[A] - - -
Connection capacity AWG	AWG - - -
General data	
Type of insulation material / insulation material group	PA / I
Inflammability class according to UL 94	V0
Drill hole diameter / pin dimensions	[mm] 1.7 / 1.0 x 1.2 mm

Ordering data

No. of pos.	Dim. a [mm]	Type	Order No.	Pcs. / Pkt.
10.16 mm pitch, color: green, for 1.0 to 3.0 mm thick housing walls				
2	10.16	DFK-PC 6-16/ 2-G-10,16	1701456	10
3	20.32	DFK-PC 6-16/ 3-G-10,16	1701469	10
4	30.48	DFK-PC 6-16/ 4-G-10,16	1701472	10
5	40.64	DFK-PC 6-16/ 5-G-10,16	1701485	10
6	50.80	DFK-PC 6-16/ 6-G-10,16	1701498	10
7	60.96	DFK-PC 6-16/ 7-G-10,16	1701508	10
8	71.12	DFK-PC 6-16/ 8-G-10,16	1701511	10
9	81.28	DFK-PC 6-16/ 9-G-10,16	1701524	10

Plug-in connectors for power electronics with 5.0 to 15.0 mm pitch

PC 16 series plug-in connectors up to 76 A/16 mm², pitch 10.16 mm



With threaded flange and shield connection on the front of the device

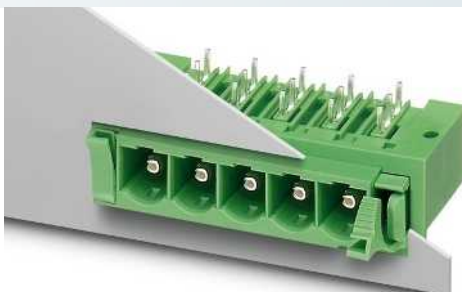

Rotated 180°, without threaded flange



Rotated 180°, with threaded flange and shield connection on the front of the device



Dimensional drawing

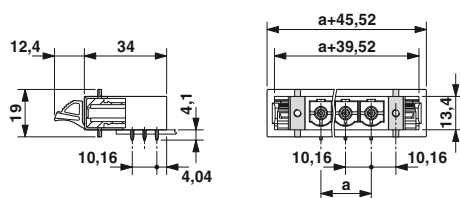

Drilling diagram

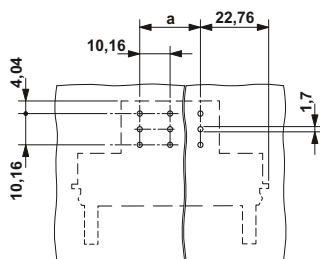

Ordering data

Type	Order No.	Pcs. / Pkt.
10.16 mm pitch, color: green, for 1.0 to 3.0 mm thick housing walls		
DFK-PC 6-16/ 2-GF-10,16	1701537	10
DFK-PC 6-16/ 3-GF-10,16	1701540	10
DFK-PC 6-16/ 4-GF-10,16	1701553	10
DFK-PC 6-16/ 5-GF-10,16	1701566	10
DFK-PC 6-16/ 6-GF-10,16	1701579	10
DFK-PC 6-16/ 7-GF-10,16	1701582	10
DFK-PC 6-16/ 8-GF-10,16	1701595	10
DFK-PC 6-16/ 9-GF-10,16	1701605	10



Dimensional drawing

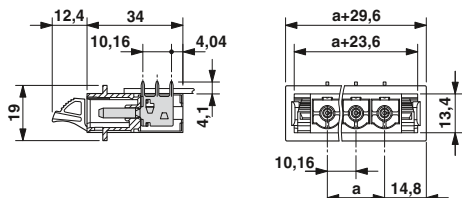

Drilling diagram

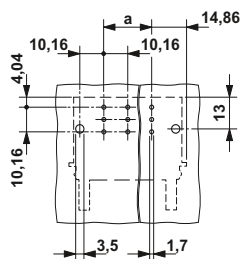

Ordering data

Type	Order No.	Pcs. / Pkt.
10.16 mm pitch, color: green, for 1.0 to 3.0 mm thick housing walls		
DFK-PC 6-16/ 2-GU-10,16	1701618	10
DFK-PC 6-16/ 3-GU-10,16	1701621	10
DFK-PC 6-16/ 4-GU-10,16	1701634	10
DFK-PC 6-16/ 5-GU-10,16	1701647	10
DFK-PC 6-16/ 6-GU-10,16	1701650	10
DFK-PC 6-16/ 7-GU-10,16	1701663	10
DFK-PC 6-16/ 8-GU-10,16	1701676	10
DFK-PC 6-16/ 9-GU-10,16	1701689	10



Dimensional drawing

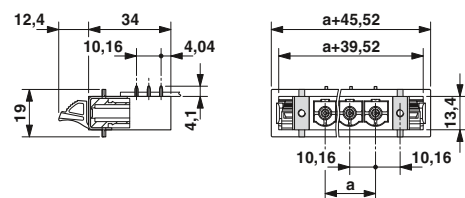

Drilling diagram

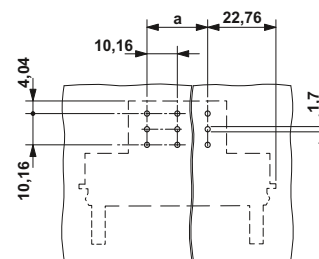

Ordering data

Type	Order No.	Pcs. / Pkt.
10.16 mm pitch, color: green, for 1.0 to 3.0 mm thick housing walls		
DFK-PC 6-16/ 2-GFU-10,16	1701692	10
DFK-PC 6-16/ 3-GFU-10,16	1701702	10
DFK-PC 6-16/ 4-GFU-10,16	1701715	10
DFK-PC 6-16/ 5-GFU-10,16	1701728	10
DFK-PC 6-16/ 6-GFU-10,16	1701731	10
DFK-PC 6-16/ 7-GFU-10,16	1701744	10
DFK-PC 6-16/ 8-GFU-10,16	1701757	10
DFK-PC 6-16/ 9-GFU-10,16	1701760	10

Plug-in connectors for power electronics with 5.0 to 15.0 mm pitch

PC 16 series plug-in connectors up to 76 A/16 mm², pitch 10.16 mm

Feed-through headers with pin/socket contact

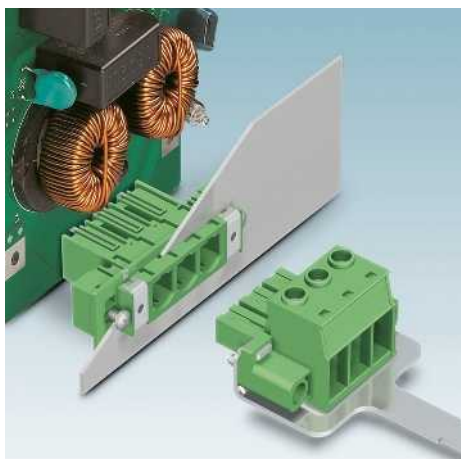

- Feed-through headers for use in combination with all PC 6 and PC 16 plugs
- To solder onto the PCB
- In SH versions, shielding functions can be executed on the inside of the device as well
- Mounting on the housing wall using the snap-lock mechanism to be operated without tools or the classical screw connection
- Wall thicknesses from 1 mm to 3 mm
- Suitable for 600 V UL when used in combination with PC 16 screw and spring-cage plugs

Notes:

In accordance with DIN EN 61984, COMBICON plug-in connectors have no switching power. During designated use, they must not be plugged in or disconnected when carrying voltage or under load.

COMBICON select

You will find the possible plug-in connector combinations in COMBICON select at: www.phoenixcontact.net/products or starting on page 488.

The cutout dimensions and mounting options for the feed-through versions can be found on page 595.

Mounting screw for DFK-PCV 6-16/...-G-10,16: sheet metal screw ISO 1481-ST 2,9 C. Screw connection only permitted prior to soldering.

1) Please observe the derating curves and laboratory data sheets. Derating curves of further combination options on request.



Horizontal, with threaded flange and shield feed-through on the inside of the device



Dimensional drawing

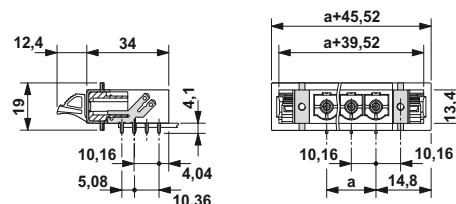

Drilling diagram

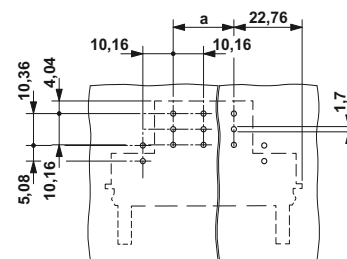

Accessories

For all types	Type	Page
	Coding profile CP-PC RD Order No. 1701967	38
	Coding pin CS-IPC 16/6 Order No. 1970016	38
	Screws for mounting on the housing panel DFK-PC 16-SS Order No. 1705449	
	Marker strips SK 5,0 WH:REEL Order No. 0805221	801

Technical data

Technical data in accordance to IEC / DIN VDE

Rated current	[A]	76 ¹⁾
Rated insulation voltage for pollution degree 2	[V]	1000
Pitch	[mm]	10.16
Insulation coordination		
Surge voltage category / pollution degree		III / 3 III / 2 II / 2
Rated insulation voltage	[V]	1000 1000 1000
Rated surge voltage	[kV]	8 8 6
Approval data (UL/CUL)	Use Group	B C D
Nominal voltage	[V]	300 300 600
Nominal current	[A]	66 66 5
Connection capacity AWG	AWG	- - -
Approval data (CSA)	Use Group	B C D
Nominal voltage	[V]	- - -
Nominal current	[A]	- - -
Connection capacity AWG	AWG	- - -
General data		
Type of insulation material / insulation material group		PA / I
Inflammability class according to UL 94		V0
Drill hole diameter / pin dimensions	[mm]	1.7 / 1.0 x 1.2 mm

Ordering data

No. of pos.	Dim. a [mm]	Type	Order No.	Pcs. / Pkt.
		10.16 mm pitch, color: green, for 1.0 to 3.0 mm thick housing walls		
2	10.16	DFK-PC 6-16/ 2-GF-SH-10,16	1701935	10
3	20.32	DFK-PC 6-16/ 3-GF-SH-10,16	1701948	10
4	30.48	DFK-PC 6-16/ 4-GF-SH-10,16	1701951	10
5	40.64	DFK-PC 6-16/ 5-GF-SH-10,16	1701964	10
6	50.80	DFK-PC 6-16/ 6-GF-SH-10,16	1701977	10
7	60.96	DFK-PC 6-16/ 7-GF-SH-10,16	1701980	10
8	71.12	DFK-PC 6-16/ 8-GF-SH-10,16	1701993	10
9	81.28	DFK-PC 6-16/ 9-GF-SH-10,16	1702002	10

Plug-in connectors for power electronics with 5.0 to 15.0 mm pitch

PC 16 series plug-in connectors up to 76 A/16 mm², pitch 10.16 mm



Horizontal, rotated 180°, with threaded flange and shield feed-through on the inside of the device



Vertical, without threaded flange



Vertical, with threaded flange and shield connection on the front of the device



Dimensional drawing

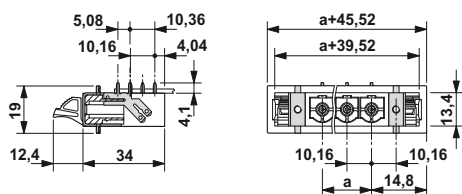

Drilling diagram

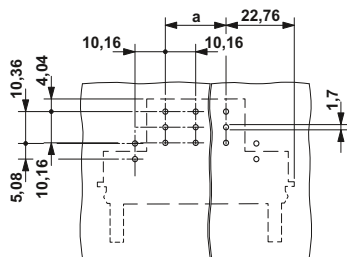

Ordering data

Type	Order No.	Pcs. / Pkt.
10.16 mm pitch, color: green, for 1.0 to 3.0 mm thick housing walls		
DFK-PC 6-16/ 2-GFU-SH-10,16	1702015	10
DFK-PC 6-16/ 3-GFU-SH-10,16	1702028	10
DFK-PC 6-16/ 4-GFU-SH-10,16	1702031	10
DFK-PC 6-16/ 5-GFU-SH-10,16	1702044	10
DFK-PC 6-16/ 6-GFU-SH-10,16	1702057	10
DFK-PC 6-16/ 7-GFU-SH-10,16	1702060	10
DFK-PC 6-16/ 8-GFU-SH-10,16	1702073	10
DFK-PC 6-16/ 9-GFU-SH-10,16	1702086	10



Dimensional drawing

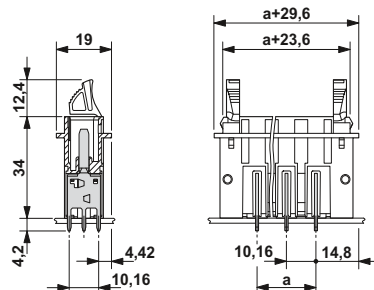

Drilling diagram

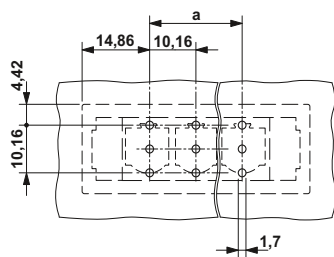

Ordering data

Type	Order No.	Pcs. / Pkt.
10.16 mm pitch, color: green, for 1.0 to 3.0 mm thick housing walls		
DFK-PCV 6-16/ 2-G-10,16	1702099	10
DFK-PCV 6-16/ 3-G-10,16	1702109	10
DFK-PCV 6-16/ 4-G-10,16	1702112	10
DFK-PCV 6-16/ 5-G-10,16	1702125	10
DFK-PCV 6-16/ 6-G-10,16	1702138	10
DFK-PCV 6-16/ 7-G-10,16	1702141	10
DFK-PCV 6-16/ 8-G-10,16	1702154	10
DFK-PCV 6-16/ 9-G-10,16	1702167	10



Dimensional drawing

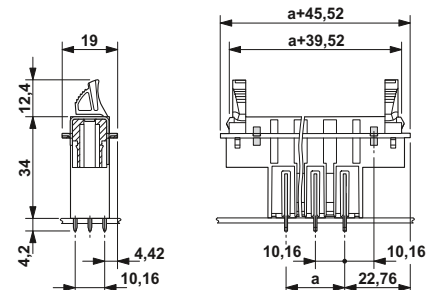

Drilling diagram

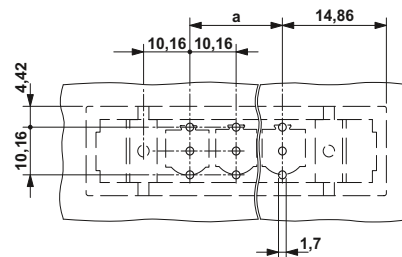

Ordering data

Type	Order No.	Pcs. / Pkt.
10.16 mm pitch, color: green, for 1.0 to 3.0 mm thick housing walls		
DFK-PCV 6-16/ 2-GF-10,16	1702251	10
DFK-PCV 6-16/ 3-GF-10,16	1702264	10
DFK-PCV 6-16/ 4-GF-10,16	1702277	10
DFK-PCV 6-16/ 5-GF-10,16	1702280	10
DFK-PCV 6-16/ 6-GF-10,16	1702293	10
DFK-PCV 6-16/ 7-GF-10,16	1702303	10
DFK-PCV 6-16/ 8-GF-10,16	1702316	10
DFK-PCV 6-16/ 9-GF-10,16	1702329	10

Plug-in connectors for power electronics with 5.0 to 15.0 mm pitch

PC 16 series plug-in connectors up to 76 A/16 mm², pitch 10.16 mm

Feed-through headers with pin/socket contact

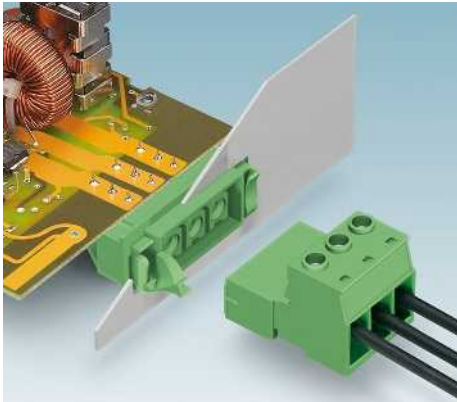

- An inverted feed-through header to implement a touch-proof PCB output (in combination with IPC 16 ST)
- To solder onto the PCB
- A snap-lock mechanism to be operated without tools or a classical screw connection
- Wall thicknesses from 1 mm to 3 mm
- In GF versions, shielding functions can be executed on the housing wall
- Suitable for 600 V UL when used in combination with IPC 16 screw and spring-cage plugs

Notes:

In accordance with DIN EN 61984, COMBICON plug-in connectors have no switching power. During designated use, they must not be plugged in or disconnected when carrying voltage or under load.

COMBICON select
You will find the possible plug-in connector combinations in COMBICON select at: www.phoenixcontact.net/products or starting on page 488.

The cutout dimensions and mounting options for the feed-through versions can be found on page 595.

¹⁾ Please observe the derating curves and laboratory data sheets. Derating curves of further combination options on request.

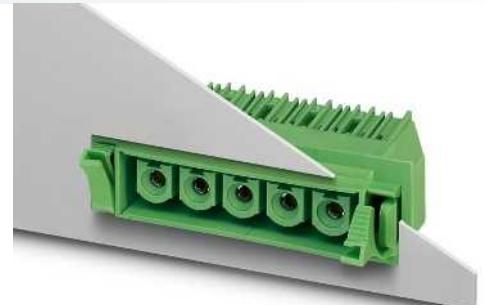

Without threaded flange



Dimensional drawing

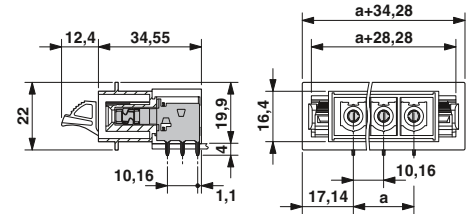

Drilling diagram

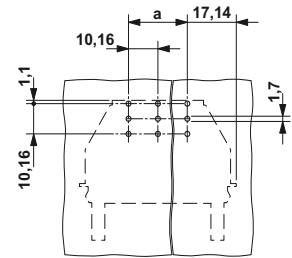

Accessories

For all types	Type	Page
	Coding profile CP-PC RD Order No. 1701967	38
	Coding pin CS-IPC 16/6 Order No. 1970016	38
	Screws for mounting on the housing panel DFK-PC 16-SS Order No. 1705449	
	Marker strips SK 5,0 WH:REEL Order No. 0805221	801

Technical data

Technical data in accordance to IEC / DIN VDE	
Rated current	[A]
Rated insulation voltage for pollution degree 2	[V]
Pitch	[mm]
Insulation coordination	
Surge voltage category / pollution degree	III / 3 III / 2 II / 2
Rated insulation voltage	[V]
Rated surge voltage	[kV]
Approval data (UL/CUL)	Use Group B C D
Nominal voltage	[V]
Nominal current	[A]
Connection capacity AWG	AWG
Approval data (CSA)	Use Group B C D
Nominal voltage	[V]
Nominal current	[A]
Connection capacity AWG	AWG
General data	
Type of insulation material / insulation material group	PA / I
Inflammability class according to UL 94	V0
Drill hole diameter / pin dimensions	[mm] 1.7 / 0.8 x 1.2

	76 ¹⁾
	1000
	10.16
	1000 1000 1000
	8 8 6
	300 300 600
	66 66 5
	- - -
	B C D
	- - -
	- - -
	- - -

Ordering data

No. of pos.	Dim. a [mm]	Type	Order No.	Pcs. / Pkt.
		10.16 mm pitch, color: green, for 1.0 to 3.0 mm thick housing walls		
2	10.16	DFK-IPC 16/ 2-G-10,16	1702413	10
3	20.32	DFK-IPC 16/ 3-G-10,16	1702426	10
4	30.48	DFK-IPC 16/ 4-G-10,16	1702439	10
5	40.64	DFK-IPC 16/ 5-G-10,16	1702442	10
6	50.80	DFK-IPC 16/ 6-G-10,16	1702455	10
7	60.96	DFK-IPC 16/ 7-G-10,16	1702468	10
8	71.12	DFK-IPC 16/ 8-G-10,16	1702471	10
9	81.28	DFK-IPC 16/ 9-G-10,16	1702484	10

Plug-in connectors for power electronics with 5.0 to 15.0 mm pitch

PC 16 series plug-in connectors up to 76 A/16 mm², pitch 10.16 mm



With threaded flange and shield connection on the front of the device

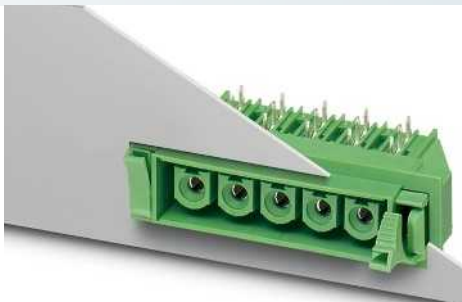

Rotated 180°, without threaded flange



Rotated 180°, with threaded flange and shield connection on the front of the device



Dimensional drawing

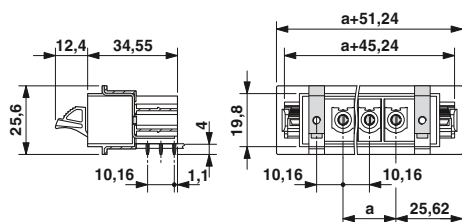

Drilling diagram

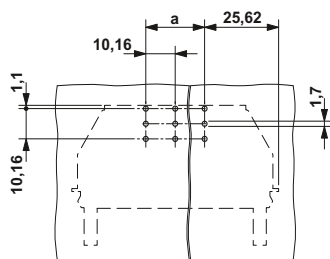

Ordering data

Type	Order No.	Pcs. / Pkt.
10.16 mm pitch, color: green, for 1.0 to 3.0 mm thick housing walls		
DFK-IPC 16/ 2-GF-10,16	1702730	10
DFK-IPC 16/ 3-GF-10,16	1702743	10
DFK-IPC 16/ 4-GF-10,16	1702756	10
DFK-IPC 16/ 5-GF-10,16	1702769	10
DFK-IPC 16/ 6-GF-10,16	1702772	10
DFK-IPC 16/ 7-GF-10,16	1702785	10
DFK-IPC 16/ 8-GF-10,16	1702798	10
DFK-IPC 16/ 9-GF-10,16	1702808	10



Dimensional drawing

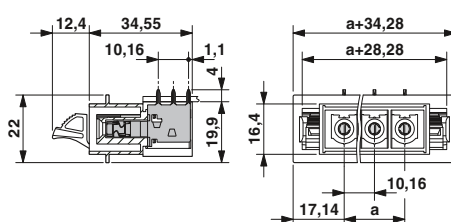

Drilling diagram

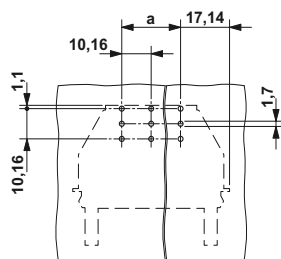

Ordering data

Type	Order No.	Pcs. / Pkt.
10.16 mm pitch, color: green, for 1.0 to 3.0 mm thick housing walls		
DFK-IPC 16/ 2-GU-10,16	1702497	10
DFK-IPC 16/ 3-GU-10,16	1702507	10
DFK-IPC 16/ 4-GU-10,16	1702510	10
DFK-IPC 16/ 5-GU-10,16	1702523	10
DFK-IPC 16/ 6-GU-10,16	1702536	10
DFK-IPC 16/ 7-GU-10,16	1702549	10
DFK-IPC 16/ 8-GU-10,16	1702552	10
DFK-IPC 16/ 9-GU-10,16	1702565	10



Dimensional drawing

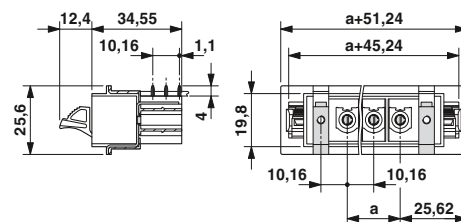

Drilling diagram

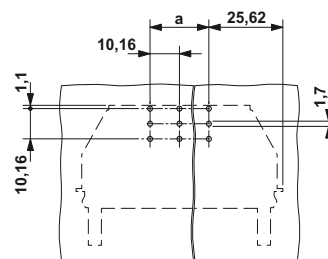

Ordering data

Type	Order No.	Pcs. / Pkt.
10.16 mm pitch, color: green, for 1.0 to 3.0 mm thick housing walls		
DFK-IPC 16/ 2-GFU-10,16	1702811	10
DFK-IPC 16/ 3-GFU-10,16	1702824	10
DFK-IPC 16/ 4-GFU-10,16	1702837	10
DFK-IPC 16/ 5-GFU-10,16	1702840	10
DFK-IPC 16/ 6-GFU-10,16	1702853	10
DFK-IPC 16/ 7-GFU-10,16	1702866	10
DFK-IPC 16/ 8-GFU-10,16	1702879	10
DFK-IPC 16/ 9-GFU-10,16	1702882	10

Plug-in connectors for power electronics with 5.0 to 15.0 mm pitch

PC 16 series plug-in connectors up to 76 A/16 mm², pitch 10.16 mm

Feed-through headers with pin/socket contact

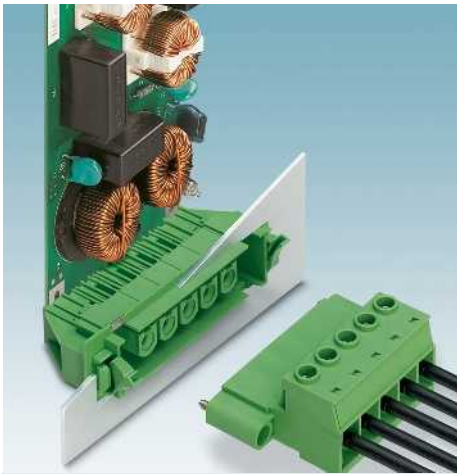

- An inverted feed-through header to implement a touch-proof PCB output (in combination with IPC 16 ST)
- To solder onto the PCB
- In SH versions, shielding functions can be executed on the inside of the device as well
- A snap-lock mechanism to be operated without tools or a classical screw connection
- Wall thicknesses from 1 mm to 3 mm
- Suitable for 600 V UL when used in combination with IPC 16 screw and spring-cage plugs

Notes:

In accordance with DIN EN 61984, COMBICON plug-in connectors have no switching power. During designated use, they must not be plugged in or disconnected when carrying voltage or under load.

COMBICON select

You will find the possible plug-in connector combinations in COMBICON select at: www.phoenixcontact.net/products or starting on page 488.

The cutout dimensions and mounting options for the feed-through versions can be found on page 595.

¹⁾ Please observe the derating curves and laboratory data sheets. Derating curves of further combination options on request.



Horizontal, with threaded flange and shield feed-through on the inside of the device



Dimensional drawing

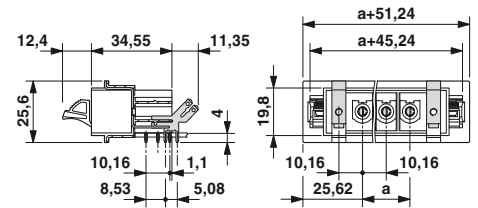

Drilling diagram

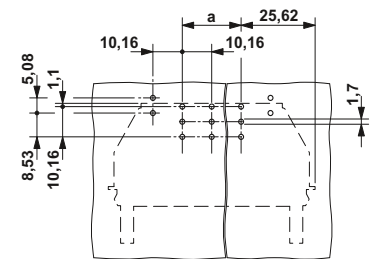

Accessories

For all types	Type	Page
	Coding profile CP-PC RD Order No. 1701967	38
	Coding pin CS-IPC 16/6 Order No. 1970016	38
	Screws for mounting on the housing panel DFK-PC 16-SS Order No. 1705449	
	Marker strips SK 5,0 WH:REEL Order No. 0805221	801

Technical data

Technical data in accordance to IEC / DIN VDE

Rated current	[A]	76 ¹⁾
Rated insulation voltage for pollution degree 2	[V]	1000
Pitch	[mm]	10.16
Insulation coordination		
Surge voltage category / pollution degree		III / 3 III / 2 II / 2
Rated insulation voltage	[V]	1000 1000 1000
Rated surge voltage	[kV]	8 8 6
Approval data (UL/CUL)	Use Group	B C D
Nominal voltage	[V]	300 300 600
Nominal current	[A]	66 66 5
Connection capacity AWG	AWG	- - -
Approval data (CSA)	Use Group	B C D
Nominal voltage	[V]	- - -
Nominal current	[A]	- - -
Connection capacity AWG	AWG	- - -
General data		
Type of insulation material / insulation material group		PA / I
Inflammability class according to UL 94		V0
Drill hole diameter / pin dimensions	[mm]	1.7 / 0.8 x 1.2

Ordering data

No. of pos.	Dim. a [mm]	Type	Order No.	Pcs. / Pkt.
10.16 mm pitch, color: green, for 1.0 to 3.0 mm thick housing walls				
2	10.16	DFK-IPC 16/ 2-GF-SH-10,16	1702976	10
3	20.32	DFK-IPC 16/ 3-GF-SH-10,16	1702989	10
4	30.48	DFK-IPC 16/ 4-GF-SH-10,16	1702992	10
5	40.64	DFK-IPC 16/ 5-GF-SH-10,16	1703001	10
6	50.80	DFK-IPC 16/ 6-GF-SH-10,16	1703014	10
7	60.96	DFK-IPC 16/ 7-GF-SH-10,16	1703027	10
8	71.12	DFK-IPC 16/ 8-GF-SH-10,16	1703030	10
9	81.28	DFK-IPC 16/ 9-GF-SH-10,16	1703043	10

Plug-in connectors for power electronics with 5.0 to 15.0 mm pitch

PC 16 series plug-in connectors up to 76 A/16 mm², pitch 10.16 mm

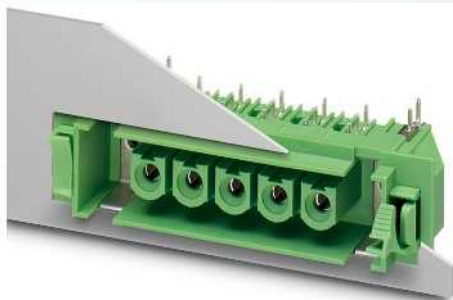

Horizontal, rotated 180°, with threaded flange, shield feed-through on the inside of the device

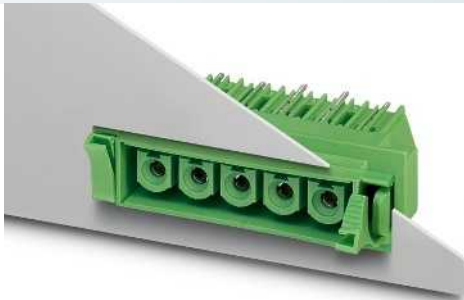

Vertical, without threaded flange

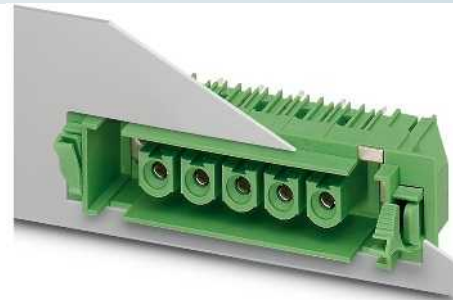

Vertical, with threaded flange and shield connection on the front of the device



Dimensional drawing

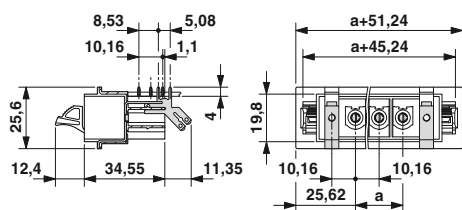

Drilling diagram

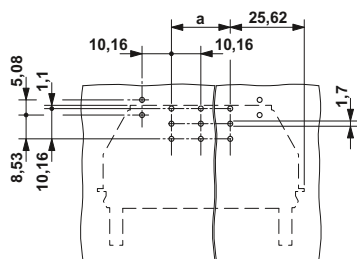

Ordering data

Type	Order No.	Pcs. / Pkt.
10.16 mm pitch, color: green, for 1.0 to 3.0 mm thick housing walls		
DFK-IPC 16/ 2-GFU-SH-10,16	1702895	10
DFK-IPC 16/ 3-GFU-SH-10,16	1702905	10
DFK-IPC 16/ 4-GFU-SH-10,16	1702918	10
DFK-IPC 16/ 5-GFU-SH-10,16	1702921	10
DFK-IPC 16/ 6-GFU-SH-10,16	1702934	10
DFK-IPC 16/ 7-GFU-SH-10,16	1702947	10
DFK-IPC 16/ 8-GFU-SH-10,16	1702950	10
DFK-IPC 16/ 9-GFU-SH-10,16	1702963	10



Dimensional drawing

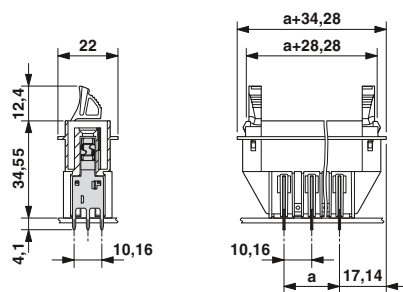

Drilling diagram

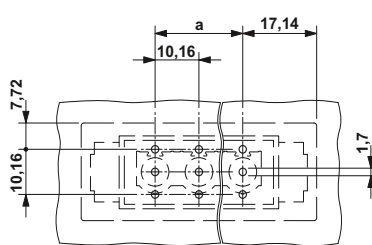

Ordering data

Type	Order No.	Pcs. / Pkt.
10.16 mm pitch, color: green, for 1.0 to 3.0 mm thick housing walls		
DFK-IPCV 16/ 2-G-10,16	1703056	10
DFK-IPCV 16/ 3-G-10,16	1703069	10
DFK-IPCV 16/ 4-G-10,16	1703072	10
DFK-IPCV 16/ 5-G-10,16	1703085	10
DFK-IPCV 16/ 6-G-10,16	1703098	10
DFK-IPCV 16/ 7-G-10,16	1703108	10
DFK-IPCV 16/ 8-G-10,16	1703111	10
DFK-IPCV 16/ 9-G-10,16	1703124	10



Dimensional drawing

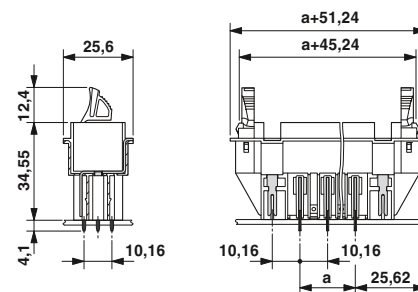

Drilling diagram

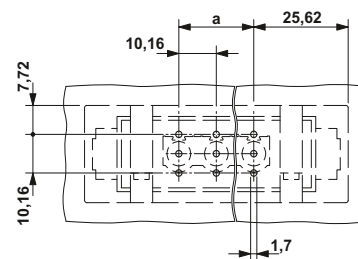

Ordering data

Type	Order No.	Pcs. / Pkt.
10.16 mm pitch, color: green, for 1.0 to 3.0 mm thick housing walls		
DFK-IPCV 16/ 2-GF-10,16	1703218	10
DFK-IPCV 16/ 3-GF-10,16	1703221	10
DFK-IPCV 16/ 4-GF-10,16	1703234	10
DFK-IPCV 16/ 5-GF-10,16	1703247	10
DFK-IPCV 16/ 6-GF-10,16	1703250	10
DFK-IPCV 16/ 7-GF-10,16	1703263	10
DFK-IPCV 16/ 8-GF-10,16	1703276	10
DFK-IPCV 16/ 9-GF-10,16	1703289	10

Plug-in connectors for power electronics with 5.0 to 15.0 mm pitch

PC 16 series plug-in connectors up to 76 A/16 mm², pitch 10.16 mm

Feed-through headers with pin/socket contact

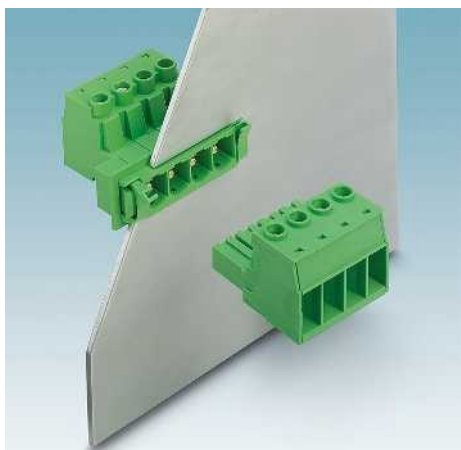

- Feed-through headers for use in combination with PC 16 plugs
- A screw connection on the inside of the device
- Mounting on the housing wall using the snap-lock mechanism to be operated without tools or the classical screw connection
- Wall thicknesses from 1 mm to 3 mm
- In SH versions, shielding functions can be executed on the inside of the device as well
- Suitable for 600 V UL when used in combination with PC 16 screw and spring-cage plugs

Notes:

In accordance with DIN EN 61984, COMBICON plug-in connectors have no switching power. During designated use, they must not be plugged in or disconnected when carrying voltage or under load.

COMBICON select

You will find the possible plug-in connector combinations in COMBICON select at: www.phoenixcontact.net/products or starting on page 488.

When using ferrules for 16 mm² conductors, crimp with CRIMPFOX 16 S (see accessories).

The cutout dimensions and mounting options for the feed-through versions can be found on page 595.

¹⁾ Please observe the derating curves and laboratory data sheets. Derating curves of further combination options on request.

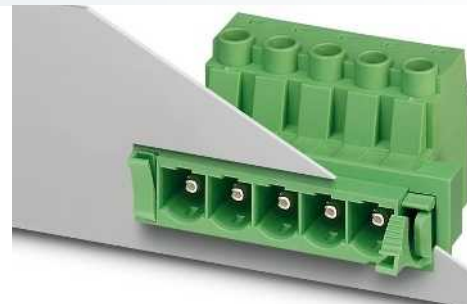

Without threaded flange, 600 V UL approval



Dimensional drawing

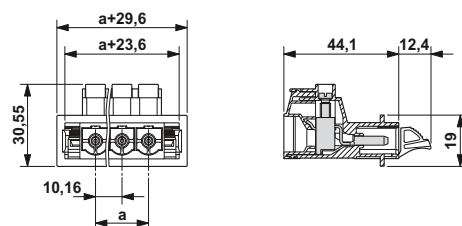

Note derating curves

Derating curves, determined as per DIN EN 61984 (VDE 0627):2002-09
Representation based on DIN EN 60512-5-2:2003-01
Connected conductor cross section = 16 mm²
Reduction factor = 0.8
Number of positions = see diagram

Accessories

For all types	Type	Page
	Coding profile CP-PC RD Order No. 1701967	38
	Screws for mounting on the housing panel DFK-PC 16-SS Order No. 1705449	
	Screwdriver SZS 1,0 x 4,0 Order No. 1205066	
	Marker strips SK 5,0 WH:REEL Order No. 0805221	801
	Crimping pliers for 0.25 to 6 mm ² CRIMPFOX 6 Order No. 1212034	
	Crimping pliers for 10 to 16 mm ² CRIMPFOX 16 S Order No. 1207983	

Technical data

Technical data in accordance to IEC / DIN VDE	
Rated current / conductor cross section	[A] / [mm ²]
Rated insulation voltage for pollution degree 2	[V]
Pitch	[mm]
Connection capacity	
Solid & multi-strand / stranded	[mm ²] / [mm ²] / AWG
Stranded with ferrules without plastic sleeve	[mm ²]
Stranded with ferrules with plastic sleeve	[mm ²]
Multi-conductor connection capacity (two conductors with the same cross section)	
Solid & multi-strand / stranded	[mm ²]
Stranded with ferrules without plastic sleeve	[mm ²]
Stranded with TWIN ferrule with plastic sleeve	[mm ²]
Insulation coordination	
Surge voltage category / pollution degree	III / 3 III / 2 II / 2
Rated insulation voltage	[V]
Rated surge voltage	[kV]
Approval data (UL/CUL)	Use Group
Nominal voltage	[V]
Nominal current	[A]
Connection capacity AWG	AWG
Approval data (CSA)	Use Group
Nominal voltage	[V]
Nominal current	[A]
Connection capacity AWG	AWG
General data	
Stripping length	[mm]
Screw thread	
Tightening torque	[Nm]
Type of insulation material / insulation material group	
Inflammability class according to UL 94	

	76 ¹⁾ / 16
	1000
	10.16
	0.75 - 16 / 0.75 - 16 / 18 - 6
	0.5 - 16
	0.5 - 16
	0.75 - 6 / 0.75 - 6
	0.5 - 4
	0.5 - 6
	III / 3 III / 2 II / 2
	1000 1000 1000
	8 8 6
	B C D
	600 600 -
	55 55 -
	20 - 6 20 - 6 -
	B C D
	- - -
	- - -
	- - -
	12
	M4
	1.7 - 1.8
	PA / I
	V0

Ordering data

No. of pos.	Dim. a [mm]	Type	Order No.	Pcs. / Pkt.
		10.16 mm pitch, color: green, for 1.0 to 3.0 mm thick housing walls		
2	10.16	DFK-PC 16/ 2-ST-10,16	1703373	10
3	20.32	DFK-PC 16/ 3-ST-10,16	1703386	10
4	30.48	DFK-PC 16/ 4-ST-10,16	1703399	10
5	40.64	DFK-PC 16/ 5-ST-10,16	1703409	10
6	50.80	DFK-PC 16/ 6-ST-10,16	1703412	10
7	60.96	DFK-PC 16/ 7-ST-10,16	1703425	10
8	71.12	DFK-PC 16/ 8-ST-10,16	1703438	10
9	81.28	DFK-PC 16/ 9-ST-10,16	1703441	10



With threaded flange and shield connection on the front of the device, 600 V UL approval



With threaded flange and shield feed-through on the inside of the device, 600 V UL approval



Dimensional drawing

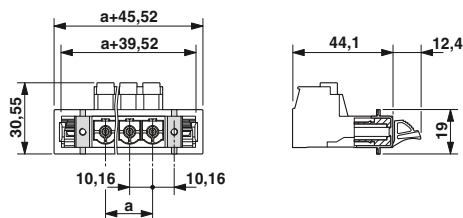

Dimensional drawing

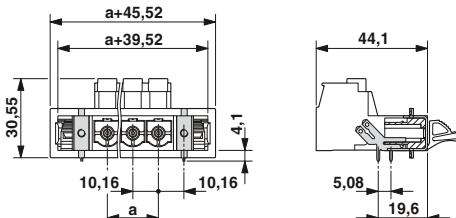

Representative derating curve

Type: PC 16/...-ST-10,16 with DFK-PC 16/...-ST-10,16

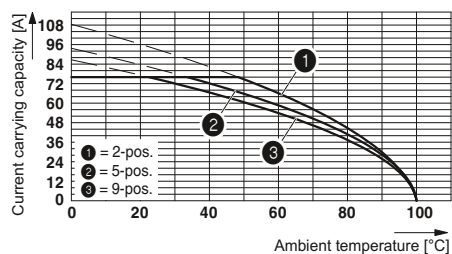

Ordering data

Type	Order No.	Pcs. / Pkt.
10.16 mm pitch, color: green, for 1.0 to 3.0 mm thick housing walls		
DFK-PC 16/ 2-STF-10,16	1703454	10
DFK-PC 16/ 3-STF-10,16	1703467	10
DFK-PC 16/ 4-STF-10,16	1703470	10
DFK-PC 16/ 5-STF-10,16	1703483	10
DFK-PC 16/ 6-STF-10,16	1703496	10
DFK-PC 16/ 7-STF-10,16	1703506	10
DFK-PC 16/ 8-STF-10,16	1703519	10
DFK-PC 16/ 9-STF-10,16	1703522	10

Ordering data

Type	Order No.	Pcs. / Pkt.
10.16 mm pitch, color: green, for 1.0 to 3.0 mm thick housing walls		
DFK-PC 16/ 2-STF-SH-10,16	1703616	10
DFK-PC 16/ 3-STF-SH-10,16	1703629	10
DFK-PC 16/ 4-STF-SH-10,16	1703632	10
DFK-PC 16/ 5-STF-SH-10,16	1703645	10
DFK-PC 16/ 6-STF-SH-10,16	1703658	10
DFK-PC 16/ 7-STF-SH-10,16	1703661	10
DFK-PC 16/ 8-STF-SH-10,16	1703674	10
DFK-PC 16/ 9-STF-SH-10,16	1703687	10

Plug-in connectors for power electronics with 5.0 to 15.0 mm pitch

PC 16 series plug-in connectors up to 76 A/16 mm², pitch 10.16 mm

Feed-through headers with pin/socket contact

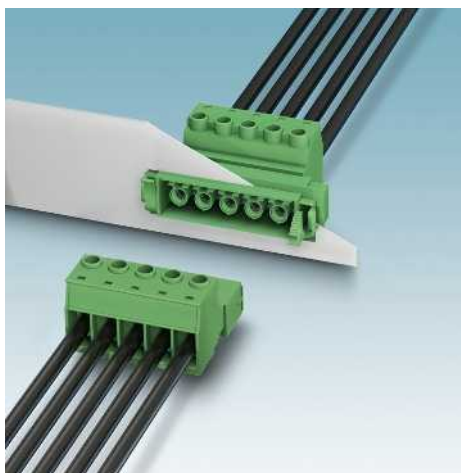

- An inverted feed-through header for a touch-proof device output (in combination with IPC 16 ST)
- A screw connection on the inside of the device
- A snap-lock mechanism to be operated without tools or a classical screw connection
- Wall thicknesses from 1 mm to 3 mm
- In SH versions, shielding functions can be executed on the inside of the device as well.
- Suitable for 600 V UL when used in combination with IPC 16 screw and spring-cage plugs

Notes:

In accordance with DIN EN 61984, COMBICON plug-in connectors have no switching power. During designated use, they must not be plugged in or disconnected when carrying voltage or under load.

COMBICON select

You will find the possible plug-in connector combinations in COMBICON select at: www.phoenixcontact.net/products or starting on page 488.

When using ferrules for 16 mm² conductors, crimp with CRIMPFOX 16 S (see accessories).

The cutout dimensions and mounting options for the feed-through versions can be found on page 595.

¹⁾ Please observe the derating curves and laboratory data sheets. Derating curves of further combination options on request.

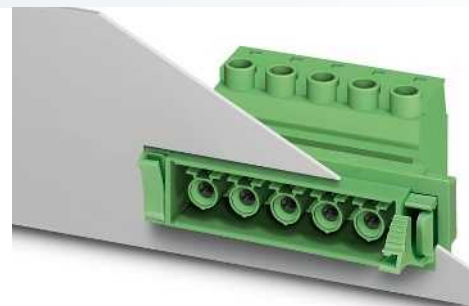

Without threaded flange, 600 V UL approval





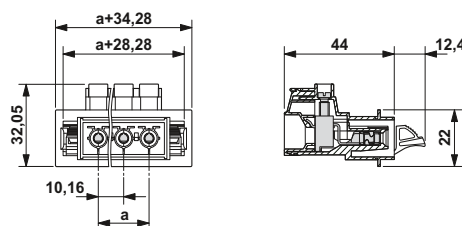



Dimensional drawing



Note derating curves

Derating curves, determined as per DIN EN 61984 (VDE 0627):2002-09
Representation based on DIN EN 60512-5-2:2003-01
Connected conductor cross section = 16 mm²
Reduction factor = 0.8
Number of positions = see diagram

Accessories

For all types	Type	Page
	Coding profile CP-PC RD Order No. 1701967	38
	Screws for mounting on the housing panel DFK-PC 16-SS Order No. 1705449	
	Screwdriver SZS 1,0 x 4,0 Order No. 1205066	
	Marker strips SK 5,0 WH:REEL Order No. 0805221	801
	Crimping pliers for 0.25 to 6 mm ² CRIMPFOX 6 Order No. 1212034	
	Crimping pliers for 10 to 16 mm ² CRIMPFOX 16 S Order No. 1207983	

Technical data

Technical data in accordance to IEC / DIN VDE	
Rated current / conductor cross section	[A] / [mm ²]
Rated insulation voltage for pollution degree 2	[V]
Pitch	[mm]
Connection capacity	
Solid & multi-strand / stranded	[mm ²] / [mm ²] / AWG
Stranded with ferrules without plastic sleeve	[mm ²]
Stranded with ferrules with plastic sleeve	[mm ²]
Multi-conductor connection capacity (two conductors with the same cross section)	
Solid & multi-strand / stranded	[mm ²]
Stranded with ferrules without plastic sleeve	[mm ²]
Stranded with TWIN ferrule with plastic sleeve	[mm ²]
Insulation coordination	
Surge voltage category / pollution degree	III / 3 III / 2 II / 2
Rated insulation voltage	[V]
Rated surge voltage	[kV]
Approval data (UL/CUL)	Use Group
Nominal voltage	[V]
Nominal current	[A]
Connection capacity AWG	AWG
Approval data (CSA)	Use Group
Nominal voltage	[V]
Nominal current	[A]
Connection capacity AWG	AWG
General data	
Stripping length	[mm]
Screw thread	
Tightening torque	[Nm]
Type of insulation material / insulation material group	
Inflammability class according to UL 94	

	76 ¹⁾ / 16
	1000
	10.16
	0.75 - 16 / 0.75 - 16 / 18 - 6
	0.5 - 16
	0.5 - 16
	0.75 - 6 / 0.75 - 6
	0.5 - 4
	0.5 - 6
	III / 3 III / 2 II / 2
	1000 1000 1000
	8 8 6
	B C D
	600 600 -
	55 55 -
	20 - 6 20 - 6 -
	B C D
	- - -
	- - -
	- - -
	12
	M4
	1.7 - 1.8
	PA / I
	V0

Ordering data

No. of pos.	Dim. a [mm]	Type	Order No.	Pcs. / Pkt.
		10.16 mm pitch, color: green, for 1.0 to 3.0 mm thick housing walls		
2	10.16	DFK-IPC 16/ 2-ST-10,16	1703690	10
3	20.32	DFK-IPC 16/ 3-ST-10,16	1703700	10
4	30.48	DFK-IPC 16/ 4-ST-10,16	1703713	10
5	40.64	DFK-IPC 16/ 5-ST-10,16	1703726	10
6	50.80	DFK-IPC 16/ 6-ST-10,16	1703739	10
7	60.96	DFK-IPC 16/ 7-ST-10,16	1703742	10
8	71.12	DFK-IPC 16/ 8-ST-10,16	1703755	10
9	81.28	DFK-IPC 16/ 9-ST-10,16	1703768	10

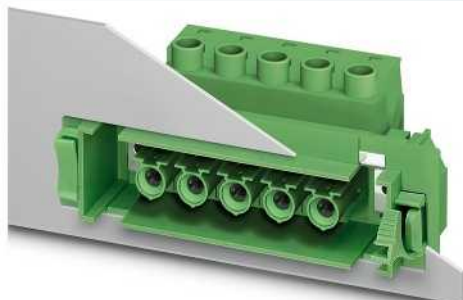

With threaded flange with shield connection on the front of the device, 600 V UL approval

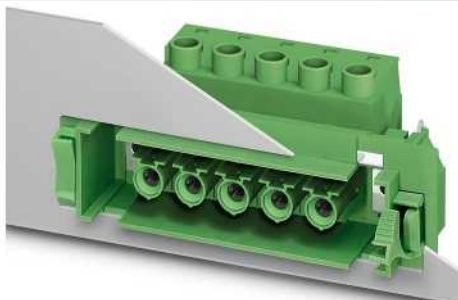

With threaded flange and shield feed-through on the inside of the device, 600 V UL approval



Dimensional drawing

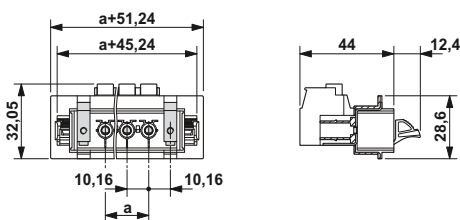

Dimensional drawing

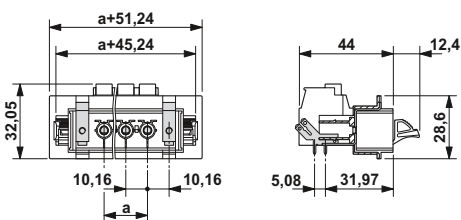

Representative derating curve

Type: IPC 16/...-ST-10,16 with DFK-IPC 16/...-ST-10,16

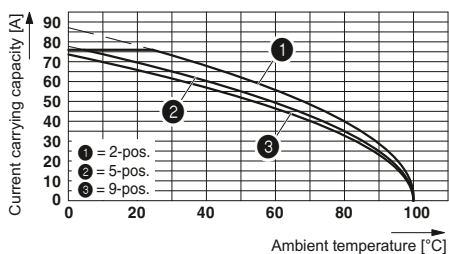

Ordering data

Type	Order No.	Pcs. / Pkt.
10.16 mm pitch, color: green, for 1.0 to 3.0 mm thick housing walls		
DFK-IPC 16/ 2-STF-10,16	1703771	10
DFK-IPC 16/ 3-STF-10,16	1703784	10
DFK-IPC 16/ 4-STF-10,16	1703797	10
DFK-IPC 16/ 5-STF-10,16	1703807	10
DFK-IPC 16/ 6-STF-10,16	1703810	10
DFK-IPC 16/ 7-STF-10,16	1703823	10
DFK-IPC 16/ 8-STF-10,16	1703836	10
DFK-IPC 16/ 9-STF-10,16	1703849	10

Ordering data

Type	Order No.	Pcs. / Pkt.
10.16 mm pitch, color: green, for 1.0 to 3.0 mm thick housing walls		
DFK-IPC 16/ 2-STF-SH-10,16	1703933	10
DFK-IPC 16/ 3-STF-SH-10,16	1703946	10
DFK-IPC 16/ 4-STF-SH-10,16	1703959	10
DFK-IPC 16/ 5-STF-SH-10,16	1703962	10
DFK-IPC 16/ 6-STF-SH-10,16	1703975	10
DFK-IPC 16/ 7-STF-SH-10,16	1703988	10
DFK-IPC 16/ 8-STF-SH-10,16	1703991	10
DFK-IPC 16/ 9-STF-SH-10,16	1704000	10

Plug-in connectors for power electronics with 5.0 to 15.0 mm pitch

PC 35 series plug-in connectors up to 125 A/35 mm², pitch 15 mm

Plugs with a screw connection

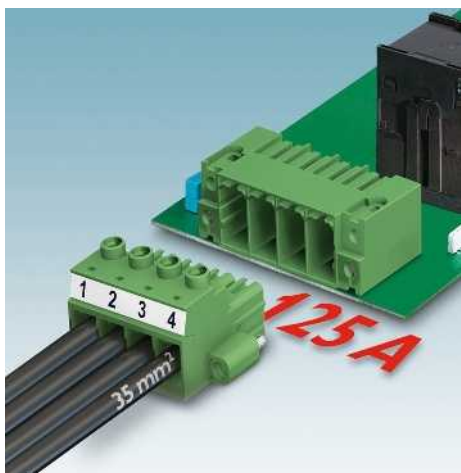

- High-capacity plugs with a current carrying capacity of up to 125 A and a connection capacity of 35 mm², solid
- Unrestricted 600-V-UL approval
- Maximum contact safety, thanks to an integrated double steel spring
- Standard with screw flange for secure connection even in applications with high levels of vibration
- Low insertion and withdrawal forces for convenient device connection
- Compatible with PC 35 HC/...-GF-15,0 base strip and IPC 35 HC/....-STGF-15,0 plug component

Notes:

In accordance with DIN EN 61984, COMBICON plug-in connectors have no switching power. During designated use, they must not be plugged in or disconnected when carrying voltage or under load.

COMBICON select

You will find the possible plug-in connector combinations in COMBICON select at: www.phoenixcontact.net/products or starting on page 485.

1) Please observe the derating curves and laboratory data sheets. Derating curves of further combination options on request.

2) Up to 16 mm² = 2.5 Nm
25 mm² = 3.5 Nm
35 mm² = 4.5 Nm



With screw flange, 600 V UL approval



Dimensional drawing

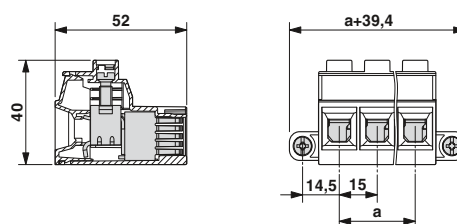

Note derating curves

Derating curves, determined in accordance with DIN EN 61984 (VDE 0627):2002-09
Representation based on DIN EN 60512-5-2:2003-01
Connected conductor cross section = 35 mm²
Reduction factor = 0.8
Number of positions = see diagram

Accessories

For all types	Type	Page
	Marker strips SK 10,0 WH:REEL Order No. 0812188	801
	Screwdriver SZS 1,0 x 6,5 Order No. 1205079	
	Coding profile CP-HC Order No. 1686478	38

Technical data

Technical data in accordance to IEC / DIN VDE	
Rated current / conductor cross section	[A] / [mm ²]
Rated insulation voltage for pollution degree 2	[V]
Pitch	[mm]
Connection capacity	
Solid & multi-strand / stranded	[mm ²] / [mm ²] / AWG
Stranded with ferrules without plastic sleeve	[mm ²]
Stranded with ferrules with plastic sleeve	[mm ²]
Multi-conductor connection capacity (two conductors with the same cross section)	
Solid & multi-strand / stranded	[mm ²]
Stranded with ferrules without plastic sleeve	[mm ²]
Stranded with TWIN ferrule with plastic sleeve	[mm ²]
Insulation coordination	
Surge voltage category / pollution degree	III / 3 III / 2 II / 2
Rated insulation voltage	[V]
Rated surge voltage	[kV]
Approval data (UL/CUL)	Use Group
Nominal voltage	[V]
Nominal current	[A]
Connection capacity AWG	AWG
Approval data (CSA)	Use Group
Nominal voltage	[V]
Nominal current	[A]
Connection capacity AWG	AWG
General data	
Stripping length	[mm]
Screw thread	
Tightening torque	[Nm]
Type of insulation material / insulation material group	
Inflammability class according to UL 94	

	125 ¹⁾ / 35
	1000
	15
	0.5 - 35 / 0.5 - 35 / 20 - 2
	1 - 35
	1.5 - 35
	0.5 - 6 / 0.5 - 6
	0.5 - 4
	0.5 - 6
	III / 3 III / 2 II / 2
	1000 1000 1000
	8 8 6
	B C D
	600 600 -
	115 115 -
	16 - 2 16 - 2 -
	B C D
	- - -
	- - -
	- - -
	20
	M5
	2.5 - 4.5 ²⁾
	PA / I
	V0

No. of pos.	Dim. a [mm]
2	15.00
3	30.00
4	45.00
5	60.00
6	75.00

Ordering data

Type	Order No.	Pcs. / Pkt.
PC 35 HC/ 2-STF-15,00	1762592	25
PC 35 HC/ 3-STF-15,00	1762602	25
PC 35 HC/ 4-STF-15,00	1762615	25
PC 35 HC/ 5-STF-15,00	1762628	10
PC 35 HC/ 6-STF-15,00	1762631	10



With screw flange and shield, 600 V UL approval



Dimensional drawing

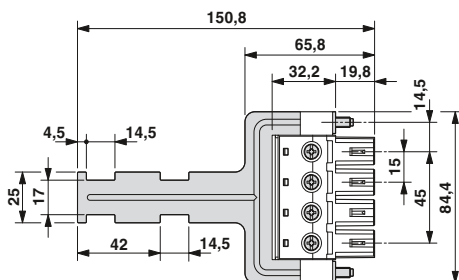

Representative derating curve

Type: PC 35 HC/...-STF-15,00 with PC 35 HC/...-GF-15,00

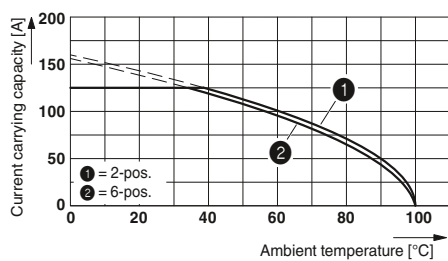

Ordering data

Type	Order No.	Pcs. / Pkt.
PC 35 HC/ 4-STF-SH-15,00	1762848	10

Plug-in connectors for power electronics with 5.0 to 15.0 mm pitch

PC 35 series plug-in connectors up to 125 A/35 mm², pitch 15 mm

Plugs with a screw connection

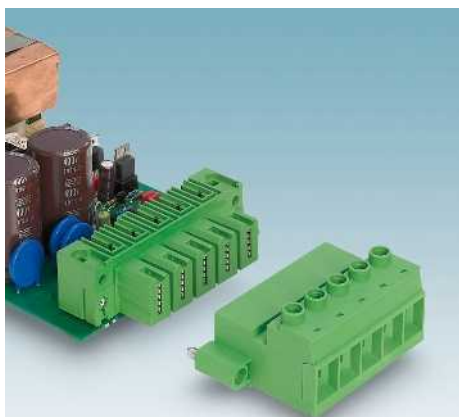

- Inverted high-performance plug components with pin contact for touch-proof device outputs or free hanging cable-cable connections
- Unrestricted 600-V-UL approval
- Maximum contact safety, thanks to an integrated double steel spring
- Standard with screw flange for secure connection even in applications with high levels of vibration
- Low insertion and withdrawal forces for convenient device connection
- Compatible with IPC 35 header HC/...-GF-15,0 and with plug component PC 35 HC/...-STF-15,0

Notes:

In accordance with DIN EN 61984, COMBICON plug-in connectors have no switching power. During designated use, they must not be plugged in or disconnected when carrying voltage or under load.

COMBICON select

You will find the possible plug-in connector combinations in COMBICON select at: www.phoenixcontact.net/products or starting on page 485.

1) Please observe the derating curves and laboratory data sheets. Derating curves of further combination options on request.

2) Up to 16 mm² = 2.5 Nm
25 mm² = 3.5 Nm
35 mm² = 4.5 Nm



With screw flange, 600 V UL approval

Accessories

For all types	Type	Page
	Marker strips SK 10,0 WH:REEL Order No. 0812188	801
	Screwdriver SZS 1,0 x 6,5 Order No. 1205079	
	Coding profile CP-HC Order No. 1686478	38
	Screws for mounting on the housing panel DFK-PC 35-SS Order No. 1700368	



Dimensional drawing

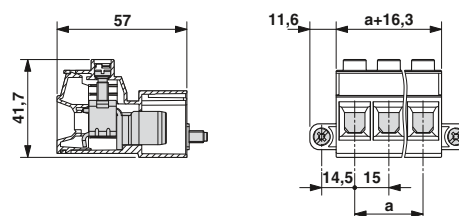

Note derating curves

Derating curves, determined in accordance with DIN EN 61984 (VDE 0627):2002-09
Representation based on DIN EN 60512-5-2:2003-01
Connected conductor cross section = 35 mm²
Reduction factor = 0.8
Number of positions = see diagram

Technical data

Technical data in accordance to IEC / DIN VDE	
Rated current / conductor cross section	[A] / [mm ²]
Rated insulation voltage for pollution degree 2	[V]
Pitch	[mm]
Connection capacity	
Solid & multi-strand / stranded	[mm ²] / [mm ²] / AWG
Stranded with ferrules without plastic sleeve	[mm ²]
Stranded with ferrules with plastic sleeve	[mm ²]
Multi-conductor connection capacity (two conductors with the same cross section)	
Solid & multi-strand / stranded	[mm ²]
Stranded with ferrules without plastic sleeve	[mm ²]
Stranded with TWIN ferrule with plastic sleeve	[mm ²]
Insulation coordination	
Surge voltage category / pollution degree	III / 3 III / 2 II / 2
Rated insulation voltage	[V]
Rated surge voltage	[kV]
Approval data (UL/CUL)	Use Group
Nominal voltage	[V]
Nominal current	[A]
Connection capacity AWG	AWG
Approval data (CSA)	Use Group
Nominal voltage	[V]
Nominal current	[A]
Connection capacity AWG	AWG
General data	
Stripping length	[mm]
Screw thread	
Tightening torque	[Nm]
Type of insulation material / insulation material group	
Inflammability class according to UL 94	

Rated current / conductor cross section	125 ¹⁾ / 35
Rated insulation voltage for pollution degree 2	1000
Pitch	15
Connection capacity	
Solid & multi-strand / stranded	0.5 - 35 / 0.5 - 35 / 20 - 2
Stranded with ferrules without plastic sleeve	1 - 35
Stranded with ferrules with plastic sleeve	1.5 - 35
Multi-conductor connection capacity (two conductors with the same cross section)	
Solid & multi-strand / stranded	0.5 - 6 / 0.5 - 6
Stranded with ferrules without plastic sleeve	0.5 - 4
Stranded with TWIN ferrule with plastic sleeve	0.5 - 6
Insulation coordination	
Surge voltage category / pollution degree	III / 3 III / 2 II / 2
Rated insulation voltage	1000 1000 1000
Rated surge voltage	8 8 8
Approval data (UL/CUL)	B C D
Nominal voltage	600 600 -
Nominal current	115 115 -
Connection capacity AWG	16 - 2 16 - 2 -
Approval data (CSA)	B C D
Nominal voltage	- - -
Nominal current	- - -
Connection capacity AWG	- - -
General data	
Stripping length	20
Screw thread	M5
Tightening torque	2.5 - 4.5 ²⁾
Type of insulation material / insulation material group	PA / I
Inflammability class according to UL 94	V0

No. of pos.	Dim. a [mm]
2	15.00
3	30.00
4	45.00
5	60.00
6	75.00

Ordering data

Type	Order No.	Pcs. / Pkt.
IPC 35 HC/ 2-STF-15,00	1784790	25
IPC 35 HC/ 3-STF-15,00	1784800	25
IPC 35 HC/ 4-STF-15,00	1784813	25
IPC 35 HC/ 5-STF-15,00	1784826	10
IPC 35 HC/ 6-STF-15,00	1784839	10

Plug-in connectors for power electronics with 5.0 to 15.0 mm pitch

PC 35 series plug-in connectors up to 125 A/35 mm², pitch 15 mm



With threaded flange, 600 V UL approval



With screw flange and shield, 600 V UL approval



With threaded flange and shield, 600 V UL approval



Dimensional drawing

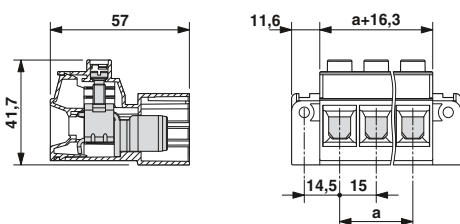

Dimensional drawing

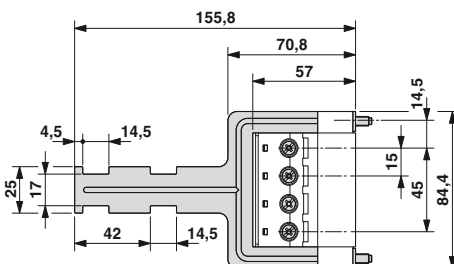

Dimensional drawing

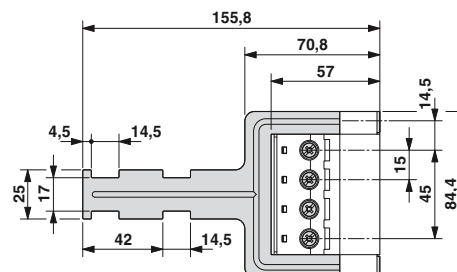

Representative derating curves of the above-mentioned plugs

Type: IPC 35 HC/...-STF-15,0 with IPC 35 HC/...-GF-15,0

Type: PC 35 HC/...-STF-15,0 with IPC 35 HC/...-STGF-15,0

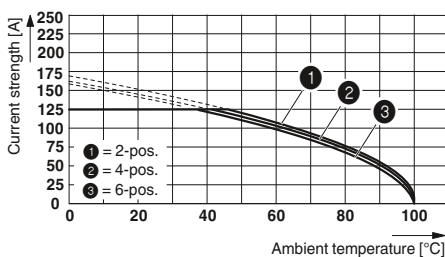
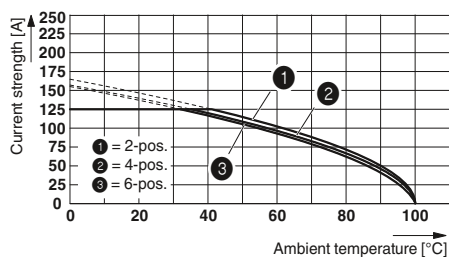

Ordering data

Type	Order No.	Pcs. / Pkt.
IPC 35 HC/ 2-STGF-15,00	1784855	25
IPC 35 HC/ 3-STGF-15,00	1784868	25
IPC 35 HC/ 4-STGF-15,00	1784871	25
IPC 35 HC/ 5-STGF-15,00	1784884	10
IPC 35 HC/ 6-STGF-15,00	1784897	10

Ordering data

Type	Order No.	Pcs. / Pkt.
IPC 35 HC/ 4-STF-SH-15,00	1784842	10

Ordering data

Type	Order No.	Pcs. / Pkt.
IPC 35 HC/ 4-STGF-SH-15,00	1784907	10

Plug-in connectors for power electronics with 5.0 to 15.0 mm pitch

PC 35 series plug-in connectors up to 125 A/35 mm², pitch 15 mm

Headers with pin contact



- PC 35 HC headers for use in combination with PC 35 plugs and IPC 35 headers
- Horizontal (0° to the PCB) and vertical (90° to the PCB) versions are available
- Integrated double flange for fastening with PC 35 connector and housing panel
- Integrated threaded flange for screwing to the PCB

Notes:

In accordance with DIN EN 61984, COMBICON plug-in connectors have no switching power. During designated use, they must not be plugged in or disconnected when carrying voltage or under load.

COMBICON select

You will find the possible plug-in connector combinations in COMBICON select at: www.phoenixcontact.net/products or starting on page 485.

The cutout dimensions for the feed-through versions can be found on page 595.

Header can be screwed to the PCB using DFK-PC 35-SS, Order No. 1700368. Screw connection only permitted prior to soldering.

¹⁾ Please observe the derating curves and laboratory data sheets. Derating curves of further combination options on request.



Horizontal, 600 V UL approval



Dimensional drawing

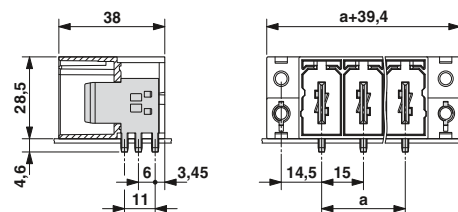

Drilling diagram

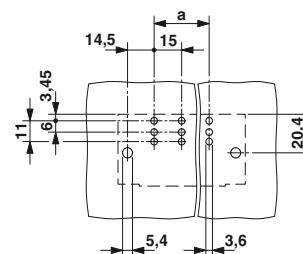

Accessories

For all types	Type	Page
	Marker strips SK 10,0 WH-REEL Order No. 0812188	801
	Coding profile CP-HC Order No. 1686478	38
	Screws for mounting on the housing panel DFK-PC 35-SS Order No. 1700368	

Technical data

Technical data in accordance to IEC / DIN VDE

Rated current	[A]	125 ¹⁾
Rated insulation voltage for pollution degree 2	[V]	1000
Pitch	[mm]	15
Insulation coordination		
Surge voltage category / pollution degree		III / 3 III / 2 II / 2
Rated insulation voltage	[V]	1000 1000 1000
Rated surge voltage	[kV]	8 8 8
Approval data (UL/CUL)	Use Group	B C D
Nominal voltage	[V]	600 600 -
Nominal current	[A]	115 115 -
Connection capacity AWG	AWG	- - -
Approval data (CSA)	Use Group	B C D
Nominal voltage	[V]	- - -
Nominal current	[A]	- - -
Connection capacity AWG	AWG	- - -
General data		
Type of insulation material / insulation material group		PBT / IIIa
Inflammability class according to UL 94		V0
Drill hole diameter / pin dimensions	[mm]	3.6 / 2.4 x 2.5 mm

Ordering data

No. of pos.	Dim. a [mm]	Type	Order No.	Pcs. / Pkt.
2	15.00	PC 35 HC/ 2-GF-15,00	1762741	25
3	30.00	PC 35 HC/ 3-GF-15,00	1762754	25
4	45.00	PC 35 HC/ 4-GF-15,00	1762767	25
5	60.00	PC 35 HC/ 5-GF-15,00	1762770	10
6	75.00	PC 35 HC/ 6-GF-15,00	1762783	10

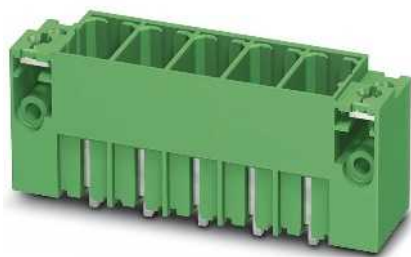

Vertical, 600 V UL approval



Horizontal, with shield connection, 600 V UL approval



Dimensional drawing

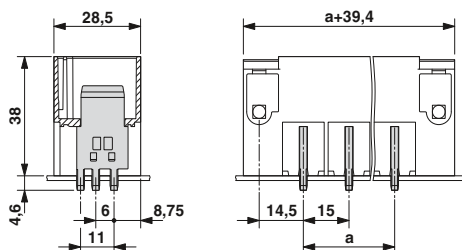

Drilling diagram

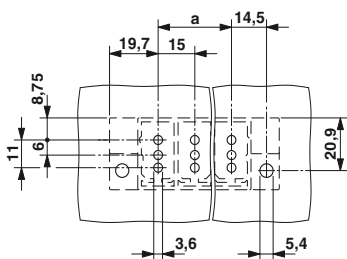

Ordering data

Type	Order No.	Pcs. / Pkt.
PCV 35 HC/ 2-GF-15,00	1762796	25
PCV 35 HC/ 3-GF-15,00	1762806	25
PCV 35 HC/ 4-GF-15,00	1762819	25
PCV 35 HC/ 5-GF-15,00	1762822	10
PCV 35 HC/ 6-GF-15,00	1762835	10



Dimensional drawing

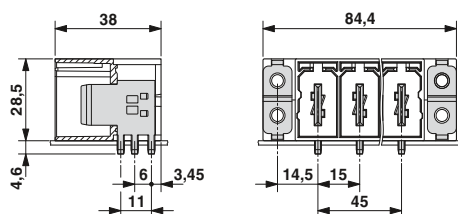

Drilling diagram

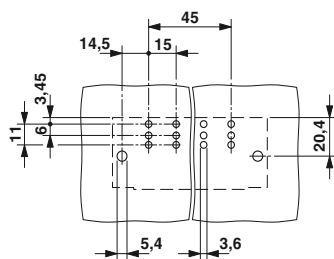

Ordering data

Type	Order No.	Pcs. / Pkt.
PC 35 HC/ 4-GF-SH-15,00	1762851	25

Plug-in connectors for power electronics with 5.0 to 15.0 mm pitch

PC 35 series plug-in connectors up to 125 A/35 mm², pitch 15 mm

Headers with socket contact

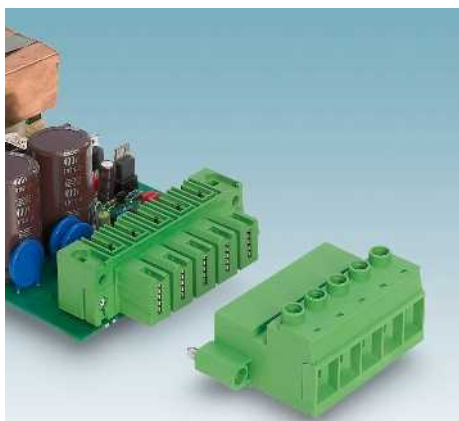

- Inverted IPC 35 HC headers for implementing a touch-proof PCB output (in combination with IPC 35 HC plugs) or a PCB/PCB connection (in combination with PC 35 headers)
- Horizontal (0° to the PCB) and vertical (90° to the PCB) versions are available
- DFK versions for fixing in the housing panel
- Integrated threaded flange for screwing to the PCB

Notes:

In accordance with DIN EN 61984, COMBICON plug-in connectors have no switching power. During designated use, they must not be plugged in or disconnected when carrying voltage or under load.

COMBICON select

You will find the possible plug-in connector combinations in COMBICON select at: www.phoenixcontact.net/products or starting on page 485.

The cutout dimensions for the feed-through versions can be found on page 595.

The header can be screwed to the PCB with DFK-IPC 35-SS Order No. 1703166. Screw connection only permitted prior to soldering.



Horizontal, 600 V UL approval

Accessories

For all types	Type	Page
	Marker strips SK 10,0 WH-REEL Order No. 0812188	801
	Coding profile CP-HC Order No. 1686478	38
	Screws for mounting on the housing panel DFK-IPC 35-SS Order No. 1703166	



Dimensional drawing

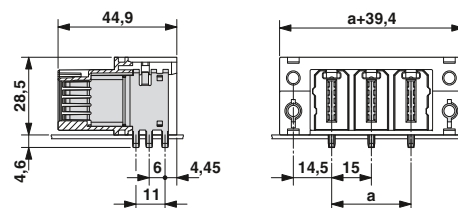

Drilling diagram

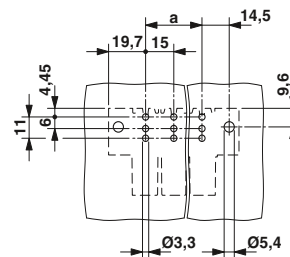

Technical data

Technical data in accordance to IEC / DIN VDE

Rated current	[A]	125
Rated insulation voltage for pollution degree 2	[V]	1000
Pitch	[mm]	15
Insulation coordination		
Surge voltage category / pollution degree		III / 3 III / 2 II / 2
Rated insulation voltage	[V]	1000 1000 1000
Rated surge voltage	[kV]	8 8 8
Approval data (UL/CUL)	Use Group	B C D
Nominal voltage	[V]	600 600 -
Nominal current	[A]	115 115 -
Connection capacity AWG	AWG	- - -
Approval data (CSA)	Use Group	B C D
Nominal voltage	[V]	- - -
Nominal current	[A]	- - -
Connection capacity AWG	AWG	- - -
General data		
Type of insulation material / insulation material group		PBT / IIIa
Inflammability class according to UL 94		V0
Drill hole diameter / pin dimensions	[mm]	3.6 / 2.4 x 2.5 mm

No. of pos.	Dim. a [mm]
2	15.00
3	30.00
4	45.00
5	60.00
6	75.00

Ordering data

Type	Order No.	Pcs. / Pkt.
IPC 35 HC/ 2-GF-15,00	1784910	25
IPC 35 HC/ 3-GF-15,00	1784923	25
IPC 35 HC/ 4-GF-15,00	1784936	25
IPC 35 HC/ 5-GF-15,00	1784949	10
IPC 35 HC/ 6-GF-15,00	1784952	10



Vertical, 600 V UL approval



Horizontal, for fixing in the housing panel with shield connection, 600 V UL approval

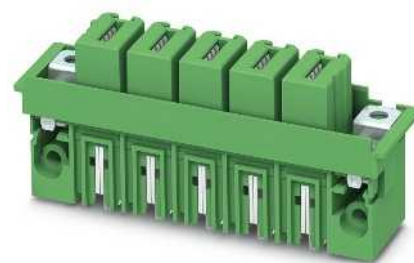

Vertical, for fixing in the housing panel with shield connection, 600 V UL approval



Dimensional drawing

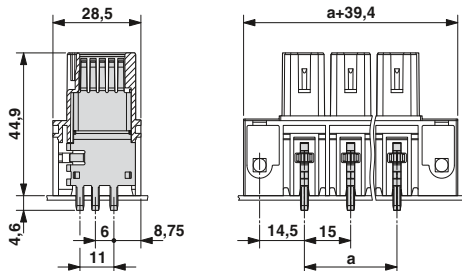

Drilling diagram

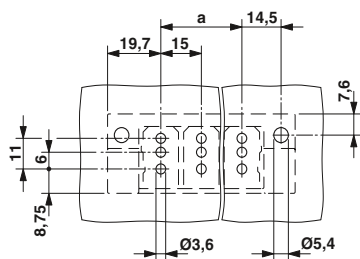

Ordering data

Type	Order No.	Pcs. / Pkt.
IPCV 35 HC/ 2-GF-15,00	1793558	25
IPCV 35 HC/ 3-GF-15,00	1793561	25
IPCV 35 HC/ 4-GF-15,00	1793574	25
IPCV 35 HC/ 5-GF-15,00	1793587	10
IPCV 35 HC/ 6-GF-15,00	1793590	10



Dimensional drawing

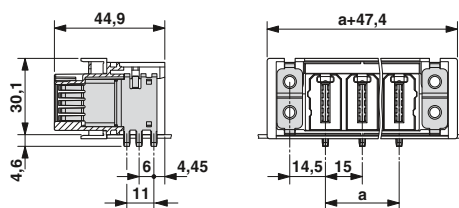

Drilling diagram

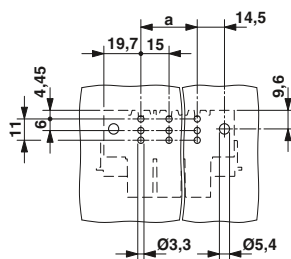

Ordering data

Type	Order No.	Pcs. / Pkt.
DFK-IPC 35 HC/ 2-GF-15,00	1784965	25
DFK-IPC 35 HC/ 3-GF-15,00	1784978	25
DFK-IPC 35 HC/ 4-GF-15,00	1784981	25
DFK-IPC 35 HC/ 5-GF-15,00	1784994	10
DFK-IPC 35 HC/ 6-GF-15,00	1785003	10



Dimensional drawing

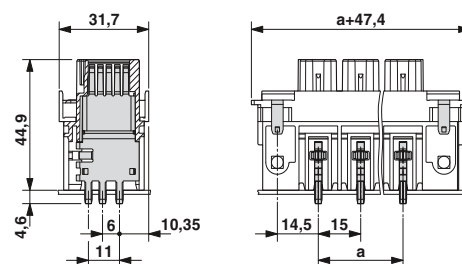

Drilling diagram

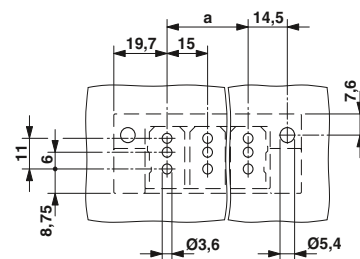

Ordering data

Type	Order No.	Pcs. / Pkt.
DFK-IPCV 35 HC/ 2-GF-15,00	1793600	25
DFK-IPCV 35 HC/ 3-GF-15,00	1793613	25
DFK-IPCV 35 HC/ 4-GF-15,00	1793626	25
DFK-IPCV 35 HC/ 5-GF-15,00	1793639	10
DFK-IPCV 35 HC/ 6-GF-15,00	1793642	10

Plug-in connectors for power electronics with 5.0 to 15.0 mm pitch

Feed-through plug-in connectors

Routing cables through panels

COMBICON power feed-through plug-in connectors enable you to route a conductor through device housing efficiently and without any gaps. PC 5 and PC 16 series feed-through plug-in connectors and headers are inserted in the housing opening and secured with the quick snap-lock mechanism ② without using any additional tools.

As an alternative to the snap-lock mechanism, each plug-in connector also has screw fixings ① for the housing panel. The corresponding screws can be ordered using Order No. 1705449.

In addition to solder-in versions, the version with a screw connection inside the device is a particularly easy-maintenance and fast alternative. Cable/cable connections can therefore be used in devices with a conductor cross section of up to 16 mm² and currents of up to 76 A.

The inverted design, which supports practical connection options, completes the range of feed-through plug-in connectors. In this way, a live device output, for example, can be designed very easily with shock protection.

DFK plug-in connectors in STF/STF-SH versions ③ also offer the option of routing shielding functions to or through the housing panel.

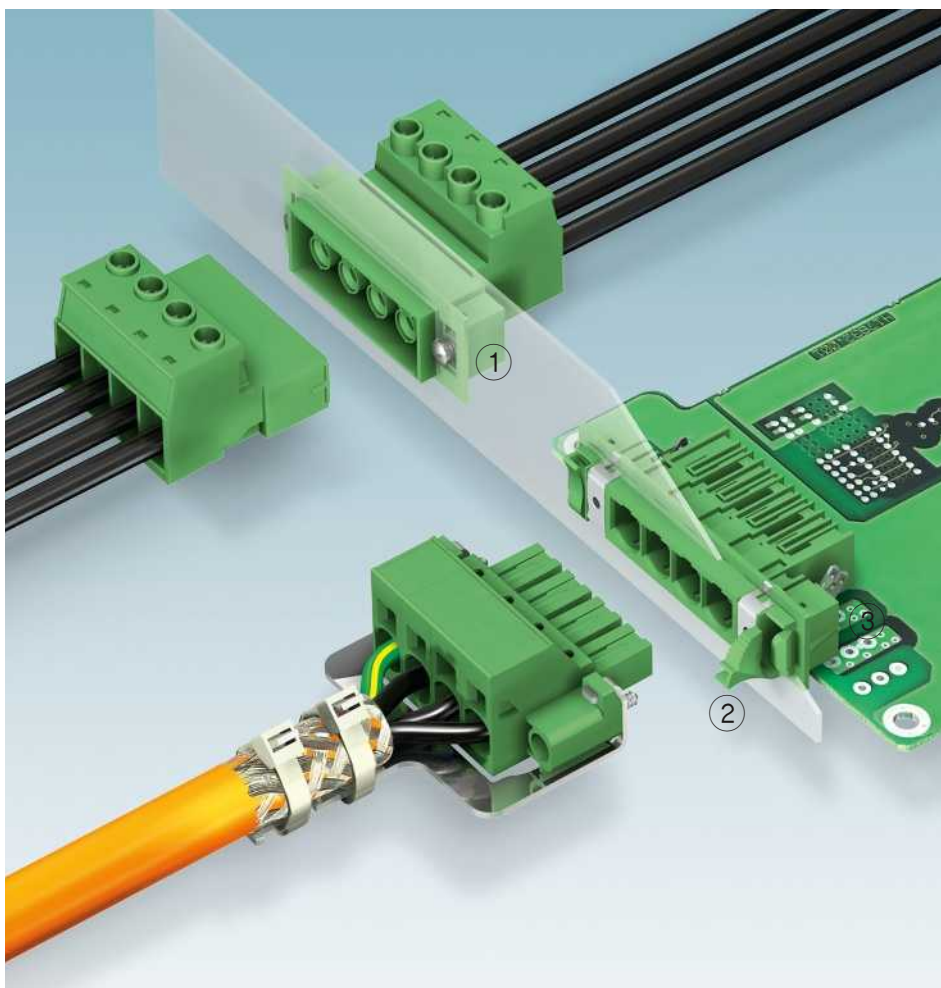

① Screw fixing



② Snap-lock mechanism



③ Shield routed through with the STF-SH version

Sheet metal cutouts for DFK-PC 4

DFK-PC 4/...G-7,62-FS4,8

DFK-PC 4/...-GF-7,62

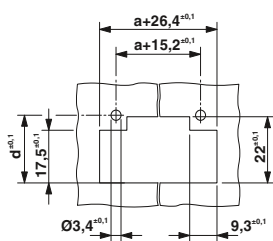
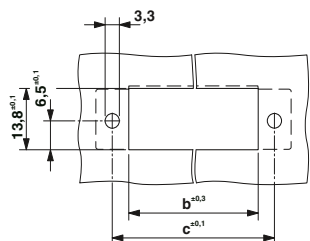

Sheet metal cutouts for PC 35

PC 35 HC/...-GF-15

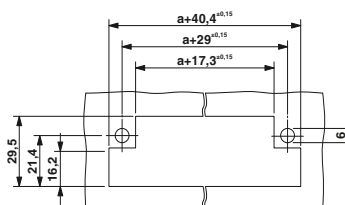

Sheet metal cutouts for DFK-PC(V) 5/...G

For G and GU versions

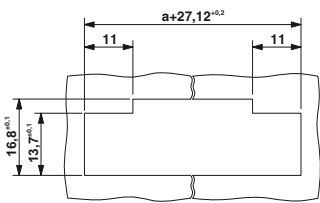

For snap-lock mechanism

For GF (-SH) and GFU (-SH) versions

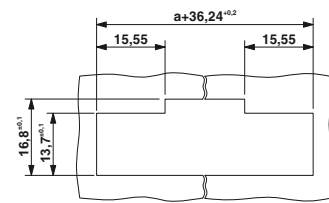

Sheet metal cutouts for DFK-PC(V) 16

For ST, G, and GU versions

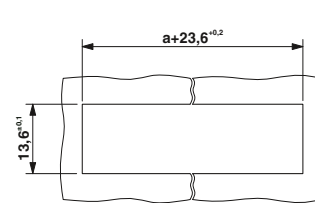

For snap-lock mechanism

For STF (-SH), GF (-SH), and GFU (-SH) versions

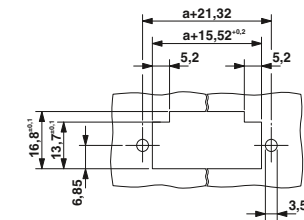
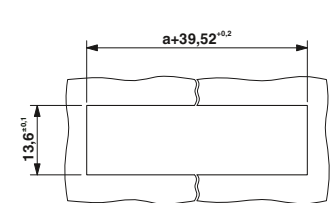

For screw fixing

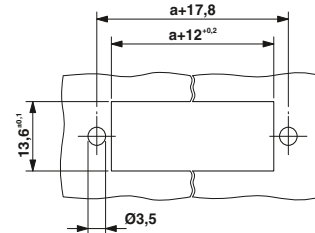
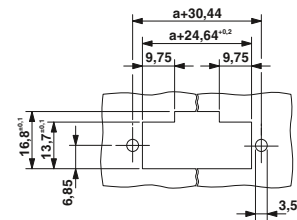

For screw fixing

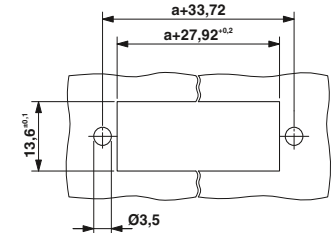

Sheet metal cutouts for DFK-PC 5/...ST

For ST versions

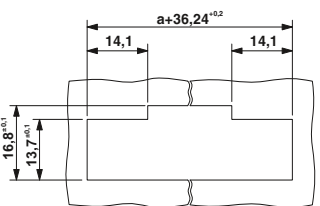

For snap-lock mechanism

For STF (-SH) versions

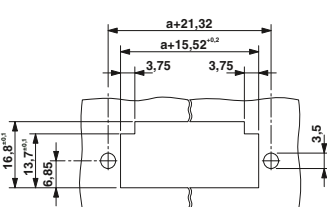
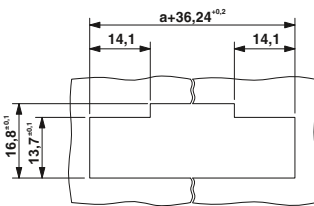

For screw fixing

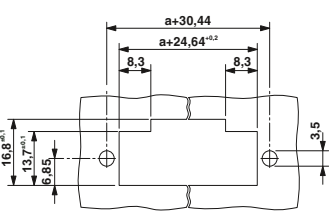

Sheet metal cutouts for DFK-IPC(V) 16

For ST, G, and GU versions

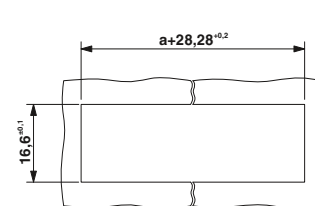

For snap-lock mechanism

For STF (-SH), GF (-SH), and GFU (-SH) versions

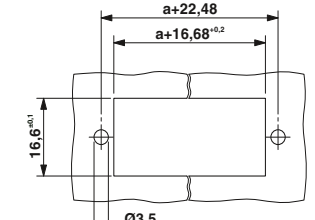
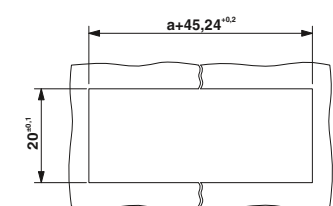

For screw fixing

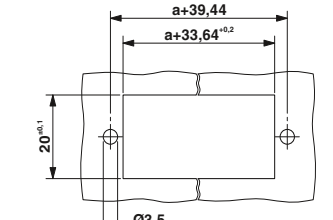

Sheet metal cutouts for IPC 35

DFK-IPC 35 HC/...-GF-15

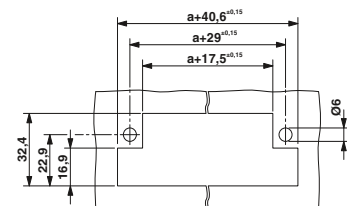

Dimensions table

Number of positions	DFK-PC 5	DFK-(I)PC 16	PC 35 HC/...-GF-15	DFK-IPC 35	DFK-PC 4/...FS4,8		DFK-PC 4/...GF		DFK-PC 4/...GF
	Dimension "a"	Dimension "a"	Dimension "a"	Dimension "a"	Dimension "b"	Dimension "c"	Dimension "b"	Dimension "c"	
2	7.62	10.16	15.00	15.00	15.19	22.86	22.9	34.1	
3	15.24	20.32	30.00	30.00	22.81	30.48	30.5	41.7	
4	22.86	30.48	45.00	45.00	30.43	38.10	38.1	49.3	
5	30.48	40.64	60.00	60.00	38.05	45.72	45.7	56.9	
6	38.10	50.80	75.00	75.00	45.67	53.34	53.3	64.6	
7	45.72	60.69			53.29	60.96	61.0	72.2	
8	53.34	71.12			60.91	68.58	68.6	79.8	1 21.4
9	60.96	81.28			68.53	76.20	76.2	87.4	2 21.9
10	68.58				76.15	83.82	83.8	95.0	3 22.5
11	76.20				83.77	91.44	91.4	102.7	4 23.1
12	83.82				91.39	99.06	99.1	110.3	5 23.7

Possible panel thickness of 1.0 - 3.0 mm for DFK-PC 5, DFK-(I)PC 16

Possible panel thickness of 1.0 - 5.0 mm for DFK-PC 4

Possible panel thickness of 1.0 - 3.0 mm for PC 35, DFK-IPC 35

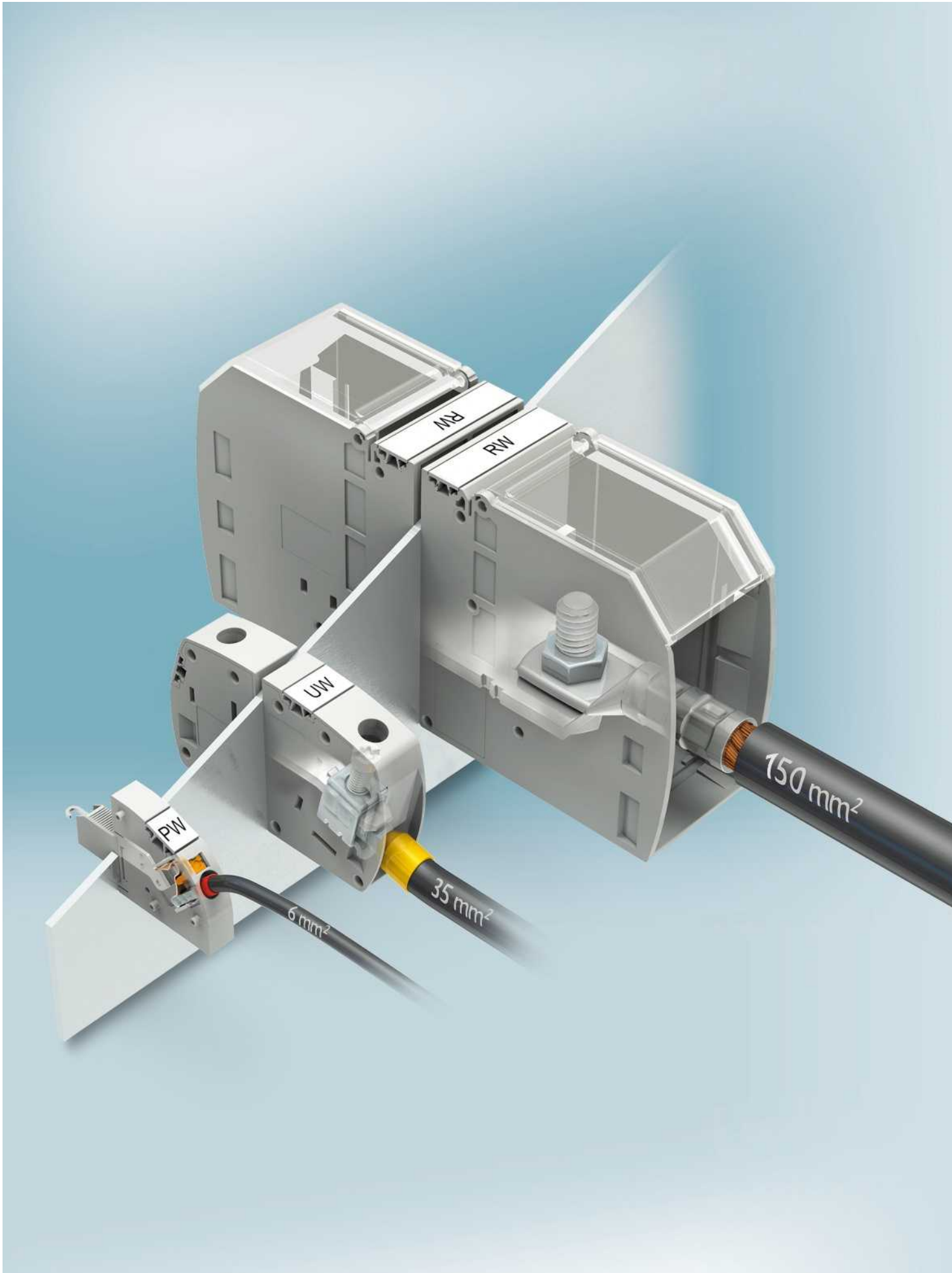

Feed-through terminal blocks for high-current applications

With the feed-through terminal blocks, you can freely select the connection technology. Choose between traditional screw connection, robust bolt connection, and convenient push-in connection - whichever best suits your application. The portfolio includes terminal blocks in the connection range from 0.2 to 150 mm² with a current carrying capacity of up to 309 A. Furthermore, the terminal blocks have unlimited UL approval up to 600 V UL, and up to 1000 V according to IEC.

The feed-through terminal blocks are available in standard or molded design, each with horizontal or vertical connection direction. The different connection directions mean that the product range is able to offer a space-saving connection for all installation locations.

The feed-through terminal blocks are available in single-position design with or without engagement pin on the outer panel. The engagement pin enables the terminal blocks to be snapped together side-by-side in the required number of positions. For neat termination or as single terminal blocks, the terminal blocks are used without the engagement pin.

The feed-through terminal blocks offer users the complete range of wiring "through the panel". The terminal blocks consist of an internal and external element. These pass through the housing panel and snap together easily without the need for tools. The precise engagement mechanism ensures a tight fit, however thick the panel. For high mechanical strain, maximum mechanical stability can be achieved with the option of using screws, rivets, and flange.

Product range overview	598
(Molded) feed-through terminal blocks with angled push-in spring connection, PW series	601
Internal with solder or spade connection up to 41 A/6 mm ²	601
Internal with cable lug connection up to 76 A/16 mm ²	603
Feed-through terminal blocks with horizontal push-lock spring connection, PLW series	605
Internal with angled push-in connection up to 41 A/6 mm ² , external 16 mm ²	605
(Molded) feed-through terminal blocks with horizontal, vertical screw connection, UW/HDFK series	607
Internal with screw, solder or spade connection up to 41 A/6 mm ²	607
Internal with screw, solder connection up to 76 A/16 mm ²	610
Internal with screw, cable lug connection up to 101 A/25 mm ²	612
Internal with screw, cable lug connection up to 125 A/35 mm ²	614
Internal with screw, cable lug connection up to 150 A/50 mm ²	619
Internal with screw, cable lug connection up to 232 A/95 mm ²	620
Vertical double connection external up to 152 A/35 mm ²	623
(Molded) feed-through terminal blocks with horizontal, vertical bolt connection, RW series	624
With captive cover nut up to 76 A/16 mm ²	624
With captive cover nut up to 125 A/35 mm ²	626
In open housing up to 76 A/16 mm ²	628
In open housing up to 125 A/35 mm ²	630
With transparent cover up to 76 A/16 mm ²	632
With transparent cover up to 125 A/35 mm ²	634
In open housing up to 309 A/150 mm ²	636
Special designs, feed-through terminal blocks with screw connection	639
DFK 4 with screw connection	639
DFK 5-9,5 with screw connection	641
VDFK with screw connection for molding	643

Feed-through terminal blocks for high-current applications

Product range overview

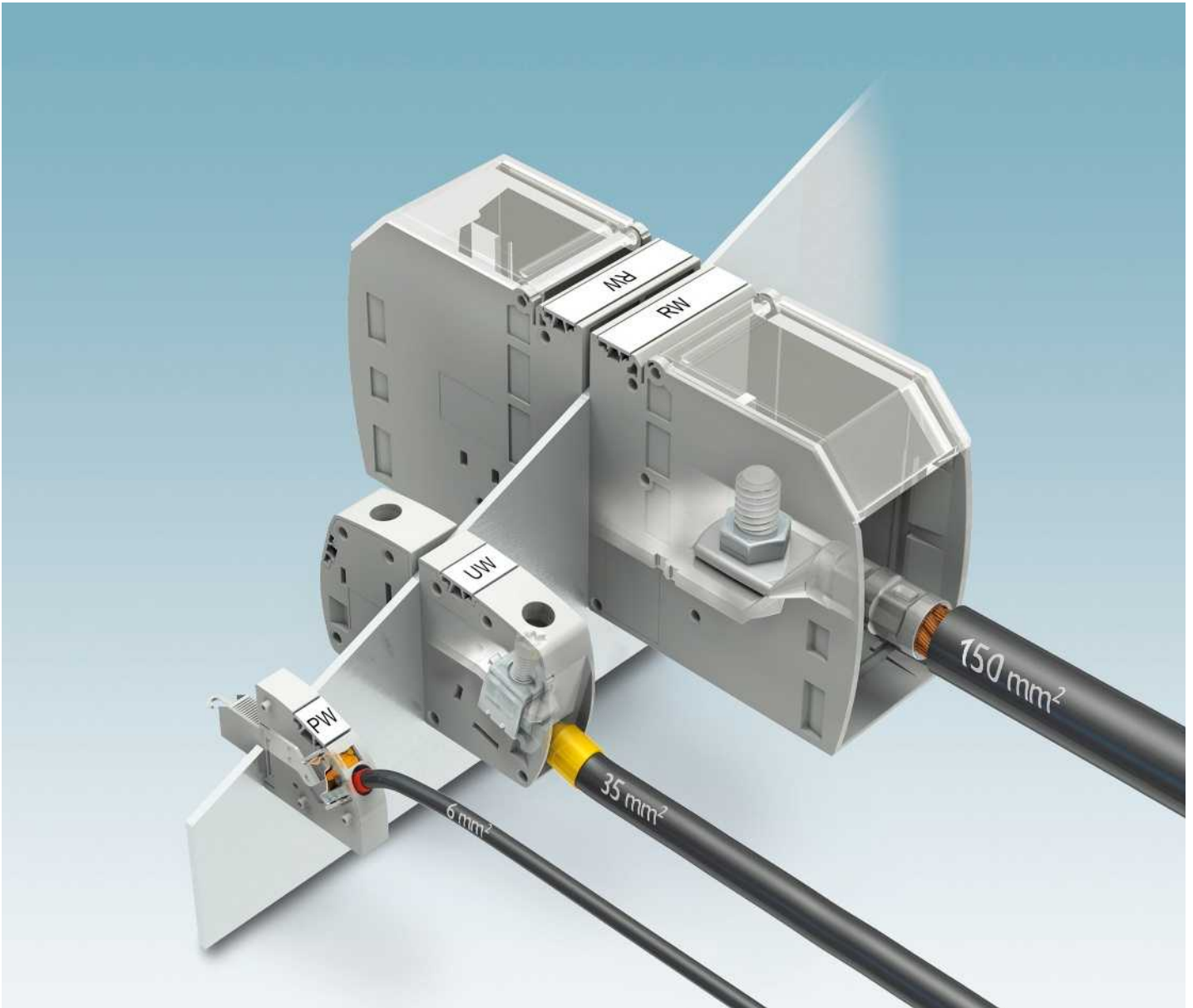

Panels pose no obstacle

Featuring a compact design, the high-current feed-through terminal blocks give you freedom of choice where connection technology is concerned.



Can be used in any application up to UL 600 V

The product range was specifically developed for devices and applications at the upper end of the power range. Their performance features allow them to be used anywhere in the world.

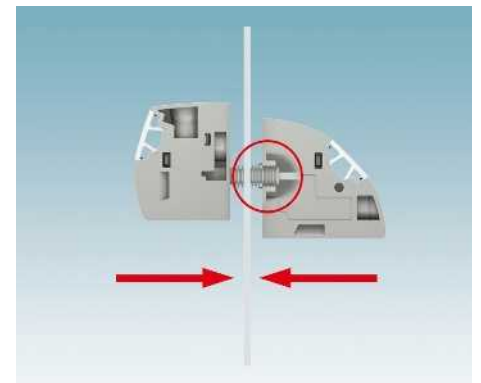

Easy mounting

The terminal blocks consist of an internal and external element. These pass through the housing panel and snap together easily without the need for tools. The precise engagement mechanism ensures a tight fit, however thick the panel.

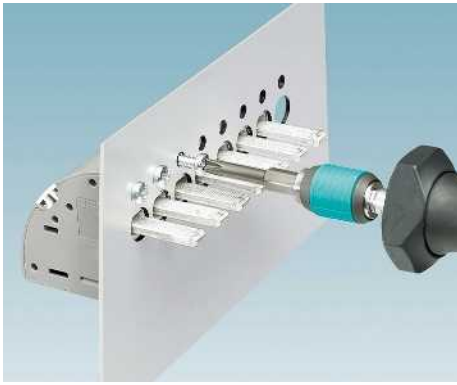

Alternative fixing options for higher levels of mechanical strain are provided by ... screws,



... rivet,



... flange.

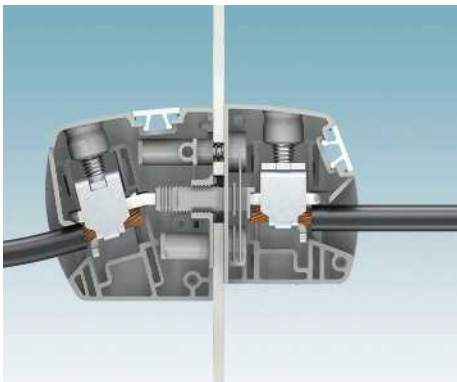

For effective and space-saving conductor routing, whatever the mounting position, high-current feed-through terminal blocks with horizontal and ...

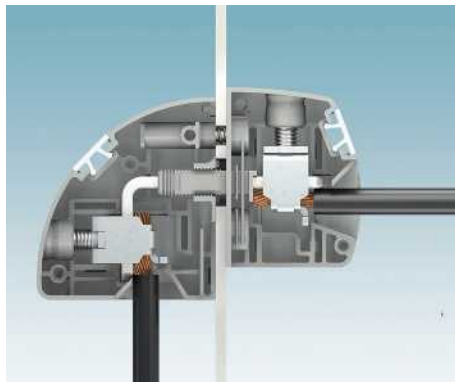

... vertical conductor routing are available.

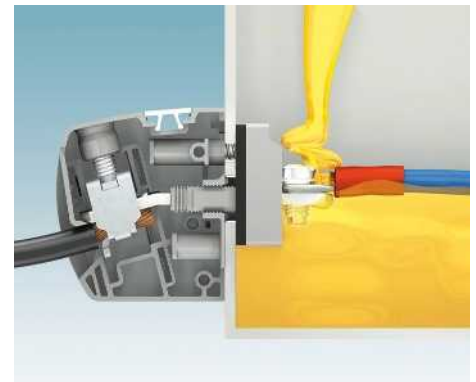

The molded versions have been designed specifically to meet the requirements associated with molded devices. They ensure maximum tightness of seal, even with low-viscosity sealing compounds.

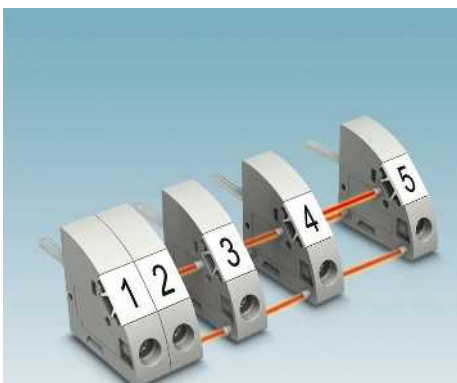

The various engagement pin versions can be used to create pre-assembled blocks and speed up mounting.



The universal marking groove, an integral part of the housing design, enables clear marking of the device connection.



The new PLW series panel feed-through terminal blocks for tool-free operation speed up conductor feed-through with lever technology outside the device and push-in connection technology inside the device; see page 605.

Feed-through terminal blocks for high-current applications

(Molded) feed-through terminal blocks with angled push-in spring connection, PW series

Internal with solder or spade connection up to 41 A/6 mm²



- User-friendly push-in connection
- Tool-free wiring of conductors with ferrules or solid conductors
- The integrated latch allows you to release connected conductors with any type of tool
- Molded versions ensure maximum tightness of seal
- Easy grouping with engagement pin versions
- Both terminal halves can be easily assembled by simply snapping them together
- Automatic panel thickness compensation
- Flange plates for alternative mounting from the outside of the device

Notes:

Internal = left side of portrait photos.
External = right side of portrait photos.

Corresponding screws for fixing the feed-through terminal blocks are supplied as standard.

Accessories

For all types	Type	
	Screwdriver SZF 1-0,6 x 3,5 Order No. 1204517	

For PW 4.../S	Type	
	Flange plate PW 4-F Order No. 3000403	

Technical data

Technical data in accordance to IEC / DIN VDE

Current/conductor cross section	[A] / [mm ²]
Rated voltage	[V]
Connection capacity	
Solid / stranded	[mm ²] / [mm ²] / AWG
Stranded with ferrules without plastic sleeve	[mm ²]
Stranded with ferrules with plastic sleeve	[mm ²]
Insulation coordination	
Surge voltage category / pollution degree	
Rated insulation voltage	[V]
Rated surge voltage	[kV]
Approval data (UL/CUL)	Use Group
Nominal voltage	[V]
Nominal current	[A]
Connection capacity AWG	AWG
Approval data (CSA)	Use Group
Nominal voltage	[V]
Nominal current	[A]
Connection capacity AWG	AWG
General data	
Stripping length	[mm]
Insulation material	
Inflammability class according to UL 94	
Panel thickness	[mm]

PW 4-POT-SCM

18 / 4 // 18 / 4			32 / 4 // 32 / 4		
800			800		
0.2 - 4 / 0.2 - 6 / 24 - 12			0.2 - 4 / 0.2 - 6 / 24 - 12		
0.25 - 6			0.25 - 6		
0.25 - 4			0.25 - 4		
III / 3	III / 2	II / 2	III / 3	III / 2	II / 2
800	1000	1000	800	1000	1000
8	8	8	8	8	8
B	C	D	B	C	D
300	300	600	300	300	600
30	30	5	30	30	5
24 - 10	24 - 10	24 - 10	24 - 10	24 - 10	24 - 10
B	C	D	B	C	D
-	-	-	-	-	-
-	-	-	-	-	-
-	-	-	-	-	-
10			10		
PA			PA		
V0			V0		
1 - 4			1 - 4		

Description

Feed-through terminal blocks for high-current applications

(Molded) feed-through terminal blocks with angled push-in spring connection, PW series



Internal part with spade connection



Internal part with solder connection



Dimensional drawing

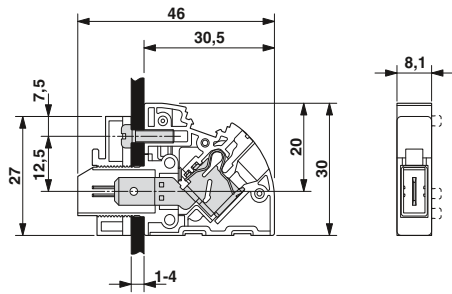

Drilling diagram

*Only when using the PW 4-F flange plate

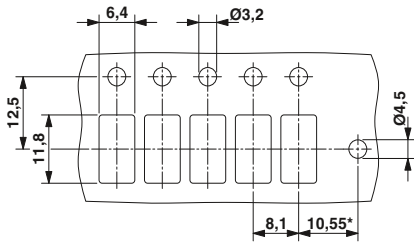

Dimensional drawing

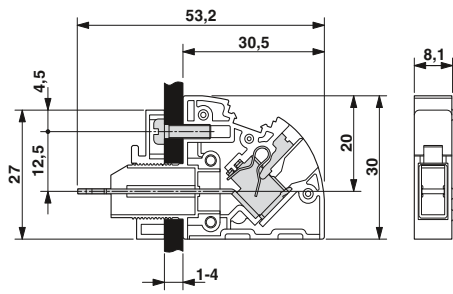

Drilling diagram

*Only when using the PW 4-F flange plate

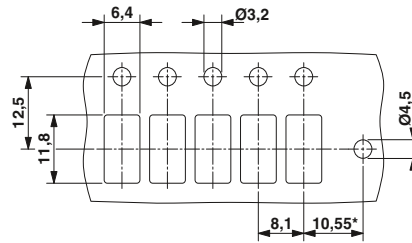

Ordering data

Type	Order No.	Pcs. / Pkt.
Feed-through terminal block		
PW 4-POT-SCM	3056938	50
Feed-through terminal block, with engagement pin		
PW 4-POT-SCM/S	3056941	50

ZB 8.../ZBF 8... marking material (see Catalog 5)

TMT (EX9,5)R marking material (see online catalog)

Ordering data

Type	Order No.	Pcs. / Pkt.
Feed-through terminal block		
PW 4-POT-SL	3059731	50
Feed-through terminal block, with engagement pin		
PW 4-POT-SL/S	3059744	50

ZB 8.../ZBF 8... marking material (see Catalog 5)

TMT (EX9,5)R marking material (see online catalog)

Feed-through terminal blocks for high-current applications

(Molded) feed-through terminal blocks with angled push-in spring connection, PW series

Internal with solder or spade connection up to 41 A/6 mm²



- User-friendly push-in connection
- Tool-free wiring of conductors with ferrules or solid conductors
- Molded versions ensure maximum tightness of seal
- Easy grouping with engagement pin versions
- Both terminal halves can be easily assembled by simply snapping them together
- Automatic panel thickness compensation
- Flange plates for alternative mounting from the outside of the device

Notes:

Internal = left side of portrait photos.
External = right side of portrait photos.

Corresponding screws for fixing the feed-through terminal blocks are supplied as standard.

Accessories

For all types	Type	
	Screwdriver SZF 1-0,6 x 3,5 Order No. 1204517	

For PW 4.../S	Type	
	Flange plate PW 4-F Order No. 3000403	

Technical data

Technical data in accordance to IEC / DIN VDE

Current/conductor cross section	[A] / [mm ²]
Rated voltage	[V]
Connection capacity	
Solid / stranded	[mm ²] / [mm ²] / AWG
Stranded with ferrules without plastic sleeve	[mm ²]
Stranded with ferrules with plastic sleeve	[mm ²]
Insulation coordination	
Surge voltage category / pollution degree	
Rated insulation voltage	[V]
Rated surge voltage	[kV]
Approval data (UL/CUL)	Use Group
Nominal voltage	[V]
Nominal current	[A]
Connection capacity AWG	AWG
Approval data (CSA)	Use Group
Nominal voltage	[V]
Nominal current	[A]
Connection capacity AWG	AWG
General data	
Stripping length	[mm]
Insulation material	
Inflammability class according to UL 94	
Panel thickness	[mm]

PWO 4-POT-SCM

Current/conductor cross section	18 / 4 // 18 / 4		
Rated voltage	800		
Connection capacity			
Solid / stranded	0.2 - 4 / 0.2 - 6 / 24 - 12		
Stranded with ferrules without plastic sleeve	0.25 - 6		
Stranded with ferrules with plastic sleeve	0.25 - 4		
Insulation coordination			
Surge voltage category / pollution degree	III / 3	III / 2	II / 2
Rated insulation voltage	800	1000	1000
Rated surge voltage	8	8	8
Approval data (UL/CUL)	B	C	D
Nominal voltage	300	300	600
Nominal current	30	30	5
Connection capacity AWG	24 - 10	24 - 10	24 - 10
Approval data (CSA)	B	C	D
Nominal voltage	-	-	-
Nominal current	-	-	-
Connection capacity AWG	-	-	-
General data			
Stripping length	10		
Insulation material	PA		
Inflammability class according to UL 94	V0		
Panel thickness	1 - 4		

PWO 4-POT-SL

Current/conductor cross section	32 / 4 // 32 / 4		
Rated voltage	800		
Connection capacity			
Solid / stranded	0.2 - 4 / 0.2 - 6 / 24 - 12		
Stranded with ferrules without plastic sleeve	0.25 - 6		
Stranded with ferrules with plastic sleeve	0.25 - 4		
Insulation coordination			
Surge voltage category / pollution degree	III / 3	III / 2	II / 2
Rated insulation voltage	800	1000	1000
Rated surge voltage	8	8	8
Approval data (UL/CUL)	B	C	D
Nominal voltage	300	300	600
Nominal current	30	30	5
Connection capacity AWG	24 - 10	24 - 10	24 - 10
Approval data (CSA)	B	C	D
Nominal voltage	-	-	-
Nominal current	-	-	-
Connection capacity AWG	-	-	-
General data			
Stripping length	10		
Insulation material	PA		
Inflammability class according to UL 94	V0		
Panel thickness	1 - 4		

Description



N

Internal part with spade connection



N

Internal part with solder connection



Dimensional drawing

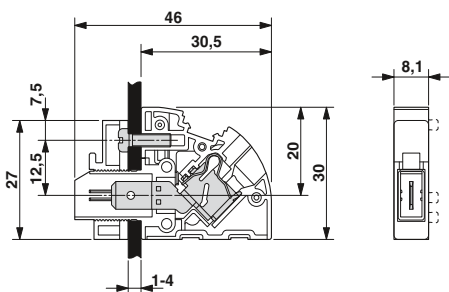

Drilling diagram

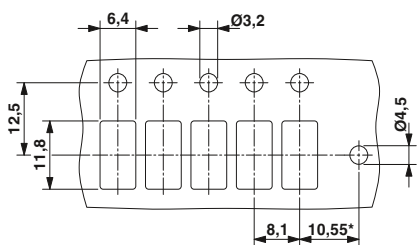

Dimensional drawing

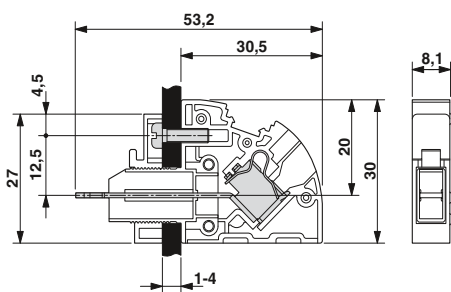

Drilling diagram

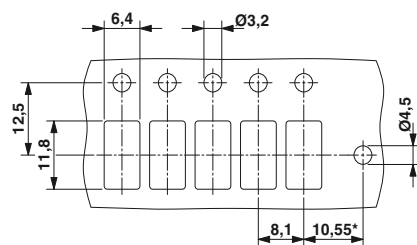

Ordering data

Type	Order No.	Pcs. / Pkt.
Feed-through terminal block		
PWO 4-POT-SCM	3056912	50
Feed-through terminal block, with engagement pin		
PWO 4-POT-SCM/S	3056925	50

ZB 8.../ZBF 8... marking material (see Catalog 5)

TMT (EX9,5)R marking material (see online catalog)

Ordering data

Type	Order No.	Pcs. / Pkt.
Feed-through terminal block		
PWO 4-POT-SL	3059715	50
Feed-through terminal block, with engagement pin		
PWO 4-POT-SL/S	3059728	50

ZB 8.../ZBF 8... marking material (see Catalog 5)

TMT (EX9,5)R marking material (see online catalog)

Feed-through terminal blocks for high-current applications

(Molded) feed-through terminal blocks with angled push-in spring connection, PW series

Internal with cable lug connection up to 76 A/16 mm²

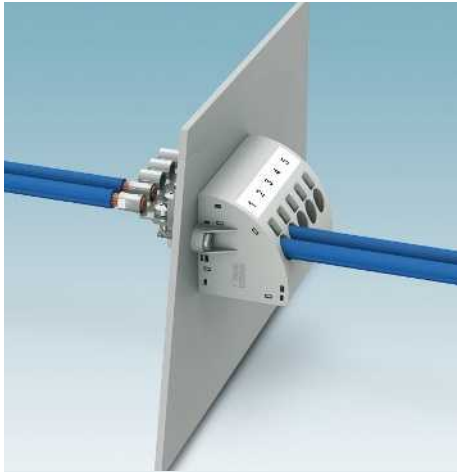

- Convenient push-in connection
- The two halves of the terminal can be easily assembled by simply snapping them together
- Tool-free wiring of conductors with ferrules or solid conductors
- Molded version for maximum tightness
- Easy grouping with engagement pin version
- Spacer plates increase air and creepage distances
- Flange plates as an alternative mounting option

Notes:

Corresponding screws for fixing the feed-through terminal blocks are supplied as standard.

Internal = left side of portrait photos.
External = right side of portrait photos.





¹⁾ When using DP-PWO 16-9 spacer plate (1705658).

N



16 mm² molded feed-through terminal block, external part with push-in connection, internal part with cable lug connection

Accessories

For all types	Type
	Spacer plate, 3 mm thick DP-PWO 16-3 Order No. 1705655
	Spacer plate, 6 mm thick DP-PWO 16-6 Order No. 1705657
	Spacer plate, 9 mm thick DP-PWO 16-9 Order No. 1705658
	Flange plate PWO 16-F Order No. 1705659

Dimensional drawing

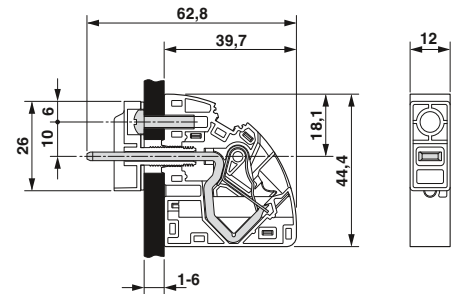

Drilling diagram

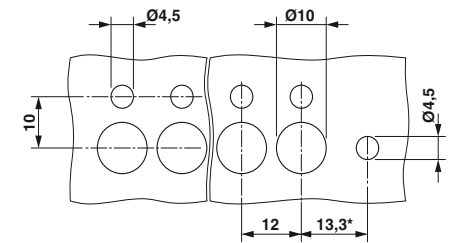

Technical data

Technical data in accordance to IEC / DIN VDE	
Current/conductor cross section	[A] / [mm ²]
Rated voltage	[V]
Connection capacity	
Solid / stranded	[mm ²] / [mm ²] / AWG
Stranded with ferrules without plastic sleeve	[mm ²]
Stranded with ferrules with plastic sleeve	[mm ²]
Multi-conductor connection capacity (two conductors with the same cross section)	
Solid / stranded	[mm ²]
Stranded with ferrules without plastic sleeve	[mm ²]
Stranded with TWIN ferrule with plastic sleeve	[mm ²]
Cross section with insertion bridge (solid/stranded)	[mm ²]
Insulation coordination	
Surge voltage category / pollution degree	
Rated insulation voltage	[V]
Rated surge voltage	[kV]
Approval data (UL/CUL)	Use Group
Nominal voltage	[V]
Nominal current	[A]
Connection capacity AWG	AWG
Approval data (CSA)	Use Group
Nominal voltage	[V]
Nominal current	[A]
Connection capacity AWG	AWG
General data	
Stripping length	[mm]
Insulation material	
Inflammability class according to UL 94	
Panel thickness	[mm]

	76 / 16 // 76 / 16
	1000 ¹⁾
	1.5 - 16 / 1.5 - 16 / 14 - 4
	1.5 - 16
	1.5 - 16
	- / -
	-
	1.5 - 4
	- / -
	III / 3 III / 2 II / 2
	1000 ¹⁾ 1000 ¹⁾ 1000 ¹⁾
	8 8 6
	B C D
	- - -
	- - -
	18
	PA
	V0
	1 - 6

Ordering data

Description	Type	Order No.	Pcs. / Pkt.
Feed-through terminal block	PWO 16-POT	1705653	50
Feed-through terminal block, with engagement pin	PWO 16-POT/S	1705654	50

ZB 12.../ZBF 12... marking material (see Catalog 5)

TMT (EX9,5)R marking material (see online catalog)

Internal with angled push-in connection up to 41 A/6 mm², outside 16 mm²

Notes:
Internal = left side of portrait photos.
External = right side of portrait photos.

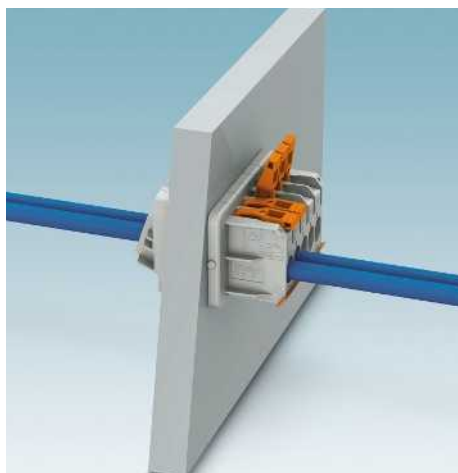



- Panel feed-through terminal blocks for tool-free operation with fast connection technology
- Outside the device with installation-friendly push-lock connection up to 16 mm² solid
- Fits inside the device with quick-fit push-in technology up to 6 mm²
- With sealing option for unauthorized operation
- Spacer for 3 mm panel thickness



N

16/6 mm² feed-through terminal block, external part with push-lock connection, internal part with push-in connection

Accessories

For all types	Type	
	Spacer for 3 mm device panels, 3-pos. DP-PLW 16-6/3 3MM Order No. 1705937	
	Spacer for 3 mm device panels, 4-pos. DP-PLW 16-6/4 3MM Order No. 1705938	
	Spacer for 3 mm device panels, 5-pos. DP-PLW 16-6/5 3MM Order No. 1705939	

Dimensional drawing

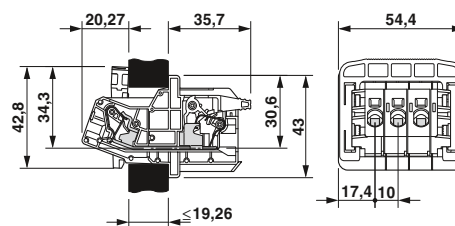

Technical data

Technical data in accordance to IEC / DIN VDE				
Current/conductor cross section	[A] / [mm ²]	41 / 16 // 41 / 16		
Rated voltage	[V]	1000		
Connection capacity				
Solid / stranded	[mm ²] / [mm ²] / AWG	2.5 - 16 / 2.5 - 25 / 14 - 4		
Stranded with ferrules without plastic sleeve	[mm ²]	2.5 - 16		
Stranded with ferrules with plastic sleeve	[mm ²]	2.5 - 16		
Multi-conductor connection capacity (two conductors with the same cross section)				
Solid / stranded	[mm ²]	- / -		
Stranded with ferrules without plastic sleeve	[mm ²]	-		
Stranded with TWIN ferrule with plastic sleeve	[mm ²]	-		
Cross section with insertion bridge (solid/stranded)	[mm ²]	- / -		
Insulation coordination				
Surge voltage category / pollution degree		III / 3	III / 2	II / 2
Rated insulation voltage	[V]	1000	1000	1000
Rated surge voltage	[kV]	8	8	8
Approval data (UL/CUL)	Use Group	B	C	D
Nominal voltage	[V]	-	-	-
Nominal current	[A]	-	-	-
Connection capacity AWG	AWG	-	-	-
Approval data (CSA)	Use Group	B	C	D
Nominal voltage	[V]	-	-	-
Nominal current	[A]	-	-	-
Connection capacity AWG	AWG	-	-	-
General data				
Stripping length	[mm]	18		
Insulation material		PA		
Inflammability class according to UL 94		V0		
Panel thickness	[mm]	19.26		

Ordering data

Description	Type	Order No.	Pcs. / Pkt.
Feed-through terminal block, 3-pos.	PLW 16-6/ 3-10	1821067	15
Feed-through terminal block, 4-pos.	PLW 16-6/ 4-10	1821070	15
Feed-through terminal block, 5-pos.	PLW 16-6/ 5-10	1821083	15

Feed-through terminal blocks for high-current applications

(Molded) feed-through terminal blocks with horizontal, vertical screw connection, UW/HDFK series

Internal with screw, solder or spade connection up to 41 A/6 mm²



- Universal screw connection with screw locking
- Both terminal halves can be easily assembled by simply snapping them together
- Automatic panel thickness compensation
- Easy grouping with engagement pin versions
- Touch-proof insulating housing in modern design
- Spacer plates increase air and creepage distances
- Flange plates for alternative mounting from the outside of the device

Notes:

Internal = left side of portrait photos.
External = right side of portrait photos.

Corresponding screws for fixing the feed-through terminal blocks are supplied as standard.

For corresponding rivets for fixing the feed-through terminal blocks, see Catalog 5.

¹⁾ The voltage specifications apply for mounting on a conductive housing panel and when using spacer plates.

Accessories

For all types	Type	
	Screwdriver SZS 0,6 x 3,5 Order No. 1205053	
	Insertion bridge, can be separated EBS 10-8 Order No. 3118135	
For UW 4 .../S		
	Spacer plate, 3 mm thick DP-UW 4 Order No. 3074499	
	Flange plate UW 4-F Order No. 3074512	
For UWV 4 .../S		
	Spacer plate, 3 mm thick DP-UWV 4 Order No. 3074509	
	Flange plate UWV 4-F Order No. 3074596	

Technical data

Technical data in accordance to IEC / DIN VDE

Current/conductor cross section	[A] / [mm ²]
Rated voltage	[V]
Connection capacity	
Solid / stranded	[mm ²] / [mm ²] / AWG
Stranded with ferrules without plastic sleeve	[mm ²]
Stranded with ferrules with plastic sleeve	[mm ²]
Multi-conductor connection capacity (two conductors with the same cross section)	
Solid / stranded	[mm ²]
Stranded with ferrules without plastic sleeve	[mm ²]
Stranded with TWIN ferrule with plastic sleeve	[mm ²]
Cross section with insertion bridge (solid/stranded)	[mm ²]
Insulation coordination	
Surge voltage category / pollution degree	
Rated insulation voltage	[V]
Rated surge voltage	[kV]
Approval data (UL/CUL)	Use Group
Nominal voltage	[V]
Nominal current	[A]
Connection capacity AWG	AWG
Approval data (CSA)	Use Group
Nominal voltage	[V]
Nominal current	[A]
Connection capacity AWG	AWG
General data	
Stripping length	[mm]
Terminal sleeve: Thread / Torque	- / [Nm]
Insulation material	
Inflammability class according to UL 94	
Panel thickness	[mm]

UW 4

41 / 6 // 32 / 4			41 / 6 // 32 / 4		
500 ¹⁾			500 ¹⁾		
0.2 - 6 / 0.2 - 4 / 24 - 10			0.2 - 6 / 0.2 - 4 / 24 - 10		
0.25 - 4			0.25 - 4		
0.25 - 4			0.25 - 4		
0.2 - 1.5 / 0.2 - 1.5			0.2 - 1.5 / 0.2 - 1.5		
0.25 - 1.5			0.25 - 1.5		
0.5 - 2.5			0.5 - 2.5		
1.5 - 4 / 1.5 - 2.5			1.5 - 4 / 1.5 - 2.5		
III / 3	III / 2	II / 2	III / 3	III / 2	II / 2
500 ¹⁾	630 ¹⁾	1000 ¹⁾	500 ¹⁾	630 ¹⁾	1000 ¹⁾
6 ¹⁾	6 ¹⁾	6 ¹⁾	6 ¹⁾	6 ¹⁾	6 ¹⁾
B	C	D	B	C	D
300 ¹⁾	300 ¹⁾	600 ¹⁾	300 ¹⁾	300 ¹⁾	600 ¹⁾
30	30	5	30	30	5
24 - 10	24 - 10	24 - 10	24 - 10	24 - 10	24 - 10
B	C	D	B	C	D
-	-	-	-	-	-
-	-	-	-	-	-
-	-	-	-	-	-
9			9		
M3 / 0.6 - 0.8			M3 / 0.6 - 0.8		
PA			PA		
V0			V0		
1 - 4			1 - 4		

Description



Horizontal conductor connection



Vertical conductor connection



Dimensional drawing

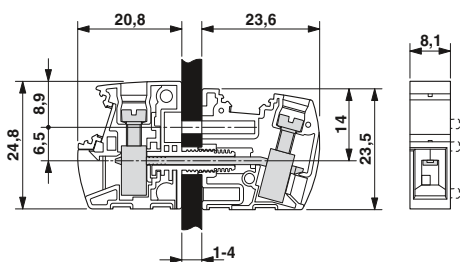

Drilling diagram

* Only when using the UW...-F flange plate
** Dimensions when using the DP-UW... spacer plate

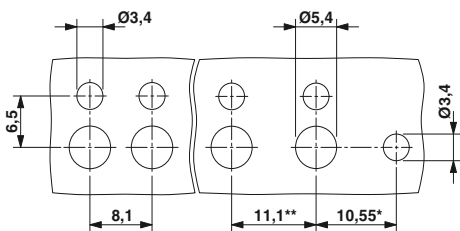

Ordering data

Type	Order No.	Pcs. / Pkt.
Feed-through terminal block		
UW 4	3073306	50
Feed-through terminal block, with engagement pin		
UW 4/S	3073319	50

ZB 8.../ZBF 8... marking material (see Catalog 5)

TMT (EX9,5)R marking material (see online catalog)



Dimensional drawing

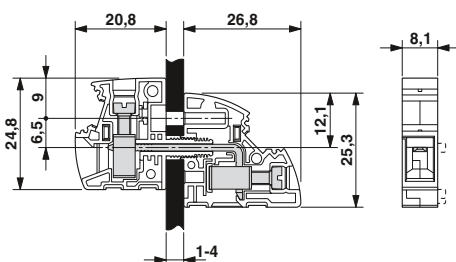

Drilling diagram

* Only when using the UW...-F flange plate
** Dimensions when using the DP-UW... spacer plate

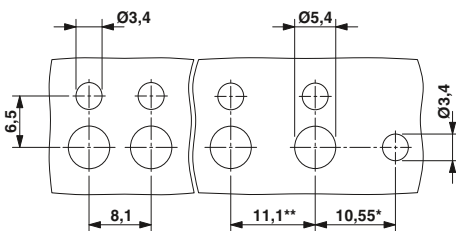

Ordering data

Type	Order No.	Pcs. / Pkt.
Feed-through terminal block		
UWV 4	3073380	50
Feed-through terminal block, with engagement pin		
UWV 4/S	3073393	50

ZB 8.../ZBF 8... marking material (see Catalog 5)

TMT (EX9,5)R marking material (see online catalog)

Feed-through terminal blocks for high-current applications

(Molded) feed-through terminal blocks with horizontal, vertical screw connection, UW/HDFK series

Internal with screw, solder or spade connection up to 41 A/6 mm²



- Universal screw connection with screw locking
- Both terminal halves can be easily assembled by simply snapping them together
- Automatic panel thickness compensation, thanks to the integrated snap principle in the insulating housing
- Easy grouping with engagement pin versions
- Molded type ensures maximum seal and is available with a slip-on or solder connection
- Touch-proof insulating housing in modern design
- Spacer plates increase air and creepage distances
- Flange plates for alternative mounting from the outside of the device

Notes:

Internal = left side of portrait photos.
External = right side of portrait photos.

Corresponding screws for fixing the feed-through terminal blocks are supplied as standard.

For corresponding rivets for fixing the feed-through terminal blocks, see Catalog 5.

¹⁾ The voltage specifications apply for mounting on a conductive housing panel and when using spacer plates.

Accessories

For all types	Type	
	Screwdriver SZS 0,6 x 3,5 Order No. 1205053	
	Insertion bridge, can be separated EBS 10-8 Order No. 3118135	
For UW 4 .../S		
	Spacer plate, 3 mm thick DP-UW 4 Order No. 3074499	
	Flange plate UW 4-F Order No. 3074512	

Technical data

Technical data in accordance to IEC / DIN VDE

Current/conductor cross section	[A] / [mm ²]
Rated voltage	[V]
Connection capacity	
Solid / stranded	[mm ²] / [mm ²] / AWG
Stranded with ferrules without plastic sleeve	[mm ²]
Stranded with ferrules with plastic sleeve	[mm ²]
Multi-conductor connection capacity (two conductors with the same cross section)	
Solid / stranded	[mm ²]
Stranded with ferrules without plastic sleeve	[mm ²]
Stranded with TWIN ferrule with plastic sleeve	[mm ²]
Cross section with insertion bridge (solid/stranded)	[mm ²]
Insulation coordination	
Surge voltage category / pollution degree	
Rated insulation voltage	[V]
Rated surge voltage	[kV]
Approval data (UL/CUL)	Use Group
Nominal voltage	[V]
Nominal current	[A]
Connection capacity AWG	AWG
Approval data (CSA)	Use Group
Nominal voltage	[V]
Nominal current	[A]
Connection capacity AWG	AWG
General data	
Stripping length	[mm]
Terminal sleeve: Thread / Torque	- / [Nm]
Insulation material	
Inflammability class according to UL 94	
Panel thickness	[mm]

UW 4-POT-SCM

41 / 6 // 32 / 4		
800 ¹⁾		
0.2 - 6 / 0.2 - 4 / 24 - 10		
0.25 - 4		
0.25 - 4		
0.2 - 1.5 / 0.2 - 1.5		
0.25 - 1.5		
0.5 - 2.5		
1.5 - 4 / 1.5 - 2.5		
III / 3	III / 2	II / 2
500	630	1000 ¹⁾
6	6	6
B	C	D
300 ¹⁾	300 ¹⁾	600 ¹⁾
30	30	5
24 - 10	24 - 10	24 - 10
B	C	D
-	-	-
-	-	-
-	-	-
10		
M3 / 0.6 - 0.8		
PA		
V0		
1 - 4		

UW 4-POT-SL

41 / 6 // 32 / 4		
800 ¹⁾		
0.2 - 6 / 0.2 - 4 / 24 - 10		
0.25 - 4		
0.25 - 4		
0.2 - 1.5 / 0.2 - 1.5		
0.25 - 1.5		
0.5 - 2.5		
1.5 - 4 / 1.5 - 2.5		
III / 3	III / 2	II / 2
500	630	1000 ¹⁾
6	6	6
B	C	D
300 ¹⁾	300 ¹⁾	600 ¹⁾
30	30	5
24 - 10	24 - 10	24 - 10
B	C	D
-	-	-
-	-	-
-	-	-
10		
M3 / 0.6 - 0.8		
PA		
V0		
1 - 4		

Description



Internal part with spade connection



Internal part with solder connection

UL

Dimensional drawing

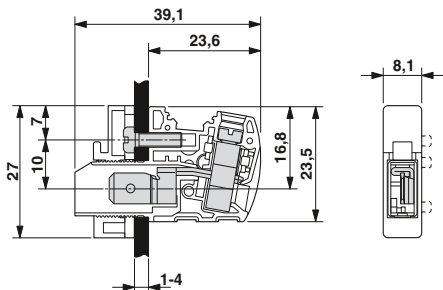

Drilling diagram

*Only when using the UW...-F flange plate
**Dimensions when using the DP-UW... spacer plate

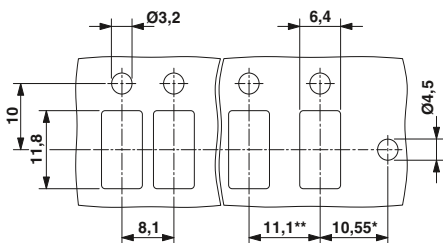

Ordering data

Type	Order No.	Pcs. / Pkt.
Feed-through terminal block		
UW 4-POT-SCM	3056996	50
Feed-through terminal block, with engagement pin		
UW 4-POT-SCM/S	3056909	50

ZB 8.../ZBF 8... marking material (see Catalog 5)

TMT (EX9,5)R marking material (see online catalog)

UL

Dimensional drawing

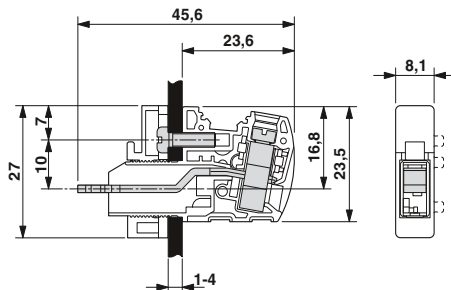

Drilling diagram

*Only when using the UW...-F flange plate
**Dimensions when using the DP-UW... spacer plate

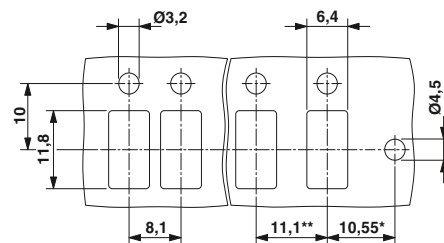

Ordering data

Type	Order No.	Pcs. / Pkt.
Feed-through terminal block		
UW 4-POT-SL	3059757	50
Feed-through terminal block, with engagement pin		
UW 4-POT-SL/S	3059760	50

ZB 8.../ZBF 8... marking material (see Catalog 5)

TMT (EX9,5)R marking material (see online catalog)

Feed-through terminal blocks for high-current applications

(Molded) feed-through terminal blocks with horizontal, vertical screw connection, UW/HDFK series

Internal with screw, solder connection up to 76 A/16 mm²



- Universal screw connection with screw locking
- Both terminal halves can be easily assembled by simply snapping them together
- Automatic panel thickness compensation
- Easy grouping with engagement pin versions
- Molded versions ensure maximum tightness of seal
- Touch-proof insulating housing in modern design
- Spacer plates increase air and creepage distances
- Flange plates for alternative mounting from the outside of the device

Notes:

Internal = left side of portrait photos.
External = right side of portrait photos.

Corresponding screws for fixing the feed-through terminal blocks are supplied as standard.

For corresponding rivets for fixing the feed-through terminal blocks, see Catalog 5.

¹⁾ The voltage specifications apply for mounting on a conductive housing panel and when using spacer plates.



Feed-through terminal blocks, horizontal conductor connection

Accessories

For all types	Type	
	Screwdriver SZS 1,0 x 4,0 Order No. 1205066	
	Insertion bridge, can be separated EBS 10-10 Order No. 0203137	
For UW 10 .../S		
	Spacer plate, 3 mm thick DP-UW 10 Order No. 3074389	
	Flange plate UW 10-F Order No. 3074525	
For UWV 10 .../S		
	Spacer plate, 3 mm thick DP-UWV 10 Order No. 3074415	
	Flange plate UWV 10-F Order No. 3074606	

Dimensional drawing

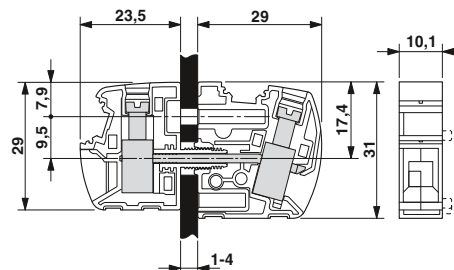

Drilling diagram

* Only when using the UW...-F flange plate
** Dimensions when using the DP-UW... spacer plate

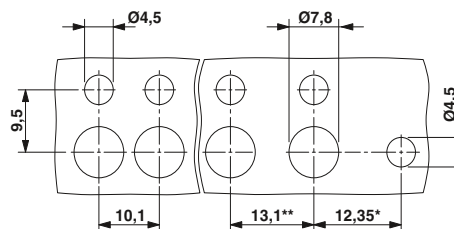

Technical data

Technical data in accordance to IEC / DIN VDE	
Current/conductor cross section	[A] / [mm ²]
Rated voltage	[V]
Connection capacity	
Solid / stranded	[mm ²] / [mm ²] / AWG
Stranded with ferrules without plastic sleeve	[mm ²]
Stranded with ferrules with plastic sleeve	[mm ²]
Multi-conductor connection capacity (two conductors with the same cross section)	
Solid / stranded	[mm ²]
Stranded with ferrules without plastic sleeve	[mm ²]
Stranded with TWIN ferrule with plastic sleeve	[mm ²]
Cross section with insertion bridge (solid/stranded)	[mm ²]
Insulation coordination	
Surge voltage category / pollution degree	
Rated insulation voltage	[V]
Rated surge voltage	[kV]
Approval data (UL/CUL)	Use Group
Nominal voltage	[V]
Nominal current	[A]
Connection capacity AWG	AWG
Approval data (CSA)	Use Group
Nominal voltage	[V]
Nominal current	[A]
Connection capacity AWG	AWG
General data	
Stripping length	[mm]
Terminal sleeve: Thread / Torque	- / [Nm]
Insulation material	
Inflammability class according to UL 94	
Panel thickness	[mm]

	76 / 16 // 57 / 10
	500 ¹⁾
	0.5 - 16 / 0.5 - 10 / 20 - 6
	0.5 - 10
	0.5 - 10
	0.5 - 4 / 0.5 - 4
	0.5 - 2.5
	0.5 - 6
	2.5 - 10 / 2.5 - 10
	III / 3 III / 2 II / 2
	500 ¹⁾ 630 ¹⁾ 1000 ¹⁾
	6 ¹⁾ 6 ¹⁾ 6 ¹⁾
	B C D
	300 ¹⁾ 300 ¹⁾ 600 ¹⁾
	65 65 5
	20 - 6 20 - 6 20 - 6
	B C D
	- - -
	- - -
	- - -
	11
	M4 / 1.5 - 1.8
	PA
	V0
	1 - 4

Description

Type	Order No.	Pcs. / Pkt.
Feed-through terminal block		
UW 10	3073322	50
Feed-through terminal block, with engagement pin		
UW 10/S	3073335	50

Ordering data

ZB 10.../ZBF 10... marking material (see Catalog 5)

TMT (EX9,5)R marking material (see online catalog)

Feed-through terminal blocks for high-current applications

(Molded) feed-through terminal blocks with horizontal, vertical screw connection, UW/HDFK series



Feed-through terminal blocks, vertical conductor connection



Molded feed-through terminal blocks, horizontal conductor connection, internal part with solder connection



Molded feed-through terminal blocks, vertical conductor connection, internal part with solder connection



Dimensional drawing

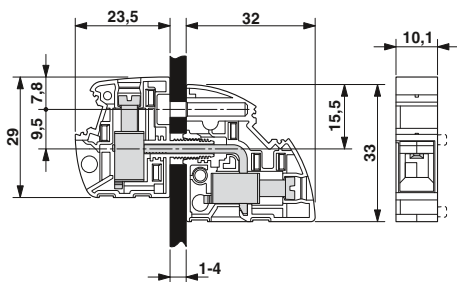

Drilling diagram

* Only when using the UW...-F flange plate
** Dimensions when using the DP-UW... spacer plate

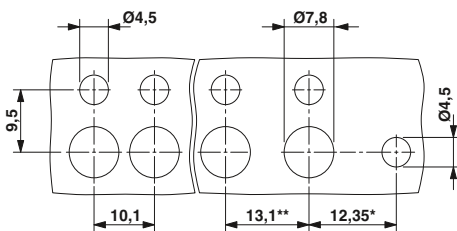

Ordering data

Type	Order No.	Pcs. / Pkt.
Feed-through terminal block		
UWV 10	3073403	50
Feed-through terminal block, with engagement pin		
UWV 10/S	3073416	50

ZB 10.../ZBF 10... marking material (see Catalog 5)

TMT (EX9,5)R marking material (see online catalog)



Dimensional drawing

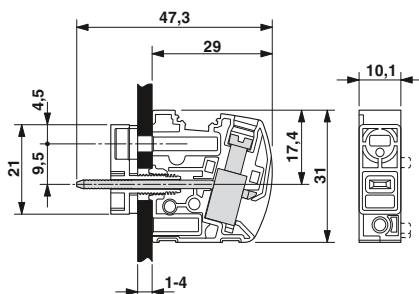

Drilling diagram

* Only when using the UW...-F flange plate
** Dimensions when using the DP-UW... spacer plate

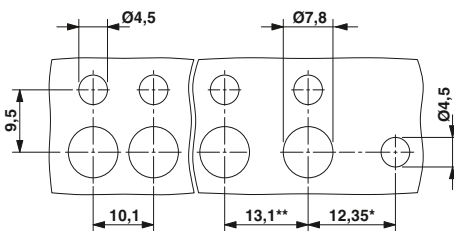

Ordering data

Type	Order No.	Pcs. / Pkt.
Feed-through terminal block		
UW 10-POT	3073461	50
Feed-through terminal block, with engagement pin		
UW 10-POT/S	3073474	50

ZB 10.../ZBF 10... marking material (see Catalog 5)

TMT (EX9,5)R marking material (see online catalog)



Dimensional drawing

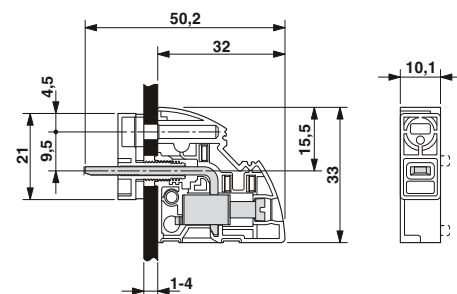

Drilling diagram

* Only when using the UW...-F flange plate
** Dimensions when using the DP-UW... spacer plate

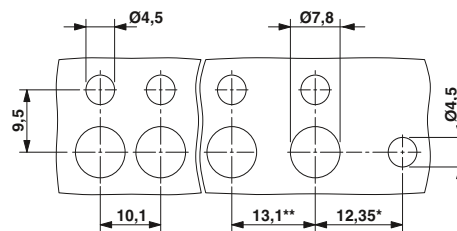

Ordering data

Type	Order No.	Pcs. / Pkt.
Feed-through terminal block		
UWV 10-POT	3073526	50
Feed-through terminal block, with engagement pin		
UWV 10-POT/S	3073539	50

ZB 10.../ZBF 10... marking material (see Catalog 5)

TMT (EX9,5)R marking material (see online catalog)

Feed-through terminal blocks for high-current applications

(Molded) feed-through terminal blocks with horizontal, vertical screw connection, UW/HDFK series

Internal with screw, cable lug connection up to 101 A/25 mm²

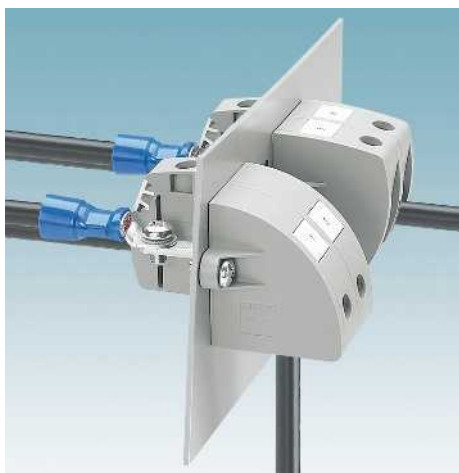

- Universal screw connection with screw locking
- Both terminal halves can be easily assembled by simply snapping them together
- Automatic panel thickness compensation
- Easy grouping with engagement pin versions
- Molded versions ensure maximum tightness of seal
- Touch-proof insulating housing in modern design
- Spacer plates increase air and creepage distances
- Flange plates for alternative mounting from the outside of the device

Notes:
Internal = left side of portrait photos. External = right side of portrait photos.
Corresponding screws for fixing the feed-through terminal blocks are supplied as standard.
For corresponding rivets for fixing the feed-through terminal blocks, see Catalog 5.
Notes on connecting aluminum conductors can be found at: www.phoenixcontact.net/products .
1) The voltage specifications apply for mounting on a conductive housing panel and when using spacer plates.



Feed-through terminal blocks, horizontal conductor connection

Accessories	
For all types	Type Screwdriver SZS 1,0 x 4,0 Order No. 1205066
For UW 16 .../S	Spacer plate, 3 mm thick DP-UW 16 Order No. 3074392
	Flange plate UW 16-F Order No. 3074538
For UWV 16 .../S	Spacer plate, 3 mm thick DP-UWV 16 Order No. 3074428
	Flange plate UWV 16-F Order No. 3074619

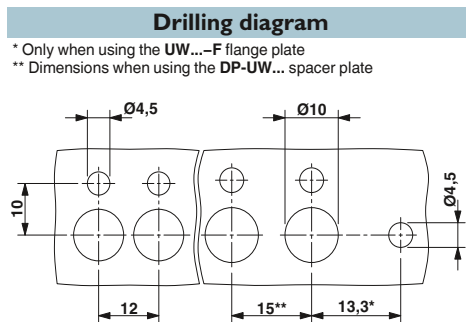
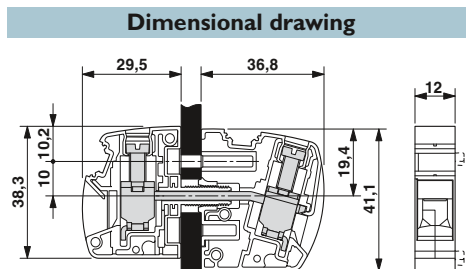

Technical data	
Technical data in accordance to IEC / DIN VDE	
Current/conductor cross section	[A] / [mm ²] 101 / 25 // 76 / 16
Rated voltage	[V] 800 ¹⁾
Connection capacity	
Solid / stranded	[mm ²] / [mm ²] / AWG 6 - 25 / 6 - 16 / 10 - 4
Stranded with ferrules without plastic sleeve	[mm ²] 6 - 16
Stranded with ferrules with plastic sleeve	[mm ²] 6 - 16
Multi-conductor connection capacity (two conductors with the same cross section)	
Solid / stranded	[mm ²] 2.5 - 10 / 2.5 - 6
Stranded with ferrules without plastic sleeve	[mm ²] 4 - 6
Stranded with TWIN ferrule with plastic sleeve	[mm ²] 4 - 6
Insulation coordination	
Surge voltage category / pollution degree	III / 3 III / 2 II / 2
Rated insulation voltage	[V] 800 ¹⁾ 1000 ¹⁾ 1000 ¹⁾
Rated surge voltage	[kV] 8 ¹⁾ 8 ¹⁾ 8 ¹⁾
Approval data (UL/CUL)	Use Group B C D
Nominal voltage	[V] 600 ¹⁾ 600 ¹⁾ -
Nominal current	[A] 85 85 -
Connection capacity AWG	AWG 10 - 4 10 - 4 -
Approval data (CSA)	Use Group B C D
Nominal voltage	[V] - - -
Nominal current	[A] - - -
Connection capacity AWG	AWG - - -
General data	
Stripping length	[mm] 16
Terminal sleeve: Thread / Torque	- / [Nm] M5 / 2.5 - 3
Insulation material	PA
Inflammability class according to UL 94	V0
Panel thickness	[mm] 1 - 6

Ordering data		
Type	Order No.	Pcs. / Pkt.
Feed-through terminal block		
UW 16	3073348	50
Feed-through terminal block, with engagement pin		
UW 16/S	3073351	50
ZB 12.../ZBF 12... marking material (see Catalog 5)		
TMT (EX9,5)R marking material (see online catalog)		

Feed-through terminal blocks for high-current applications

(Molded) feed-through terminal blocks with horizontal, vertical screw connection, UW/HDFK series



Feed-through terminal blocks, vertical conductor connection



Molded feed-through terminal blocks, horizontal conductor connection, internal part with M5 screw connection



Molded feed-through terminal blocks, vertical conductor connection, internal part with M5 screw connection



Dimensional drawing

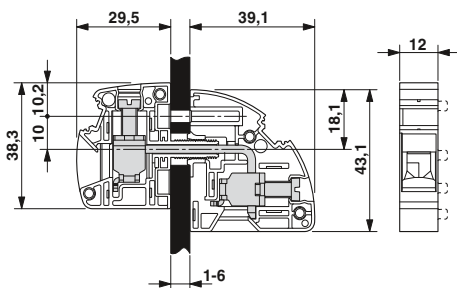

Drilling diagram

* Only when using the UW...-F flange plate
** Dimensions when using the DP-UW... spacer plate

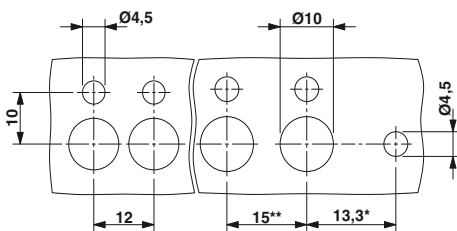

Ordering data

Type	Order No.	Pcs. / Pkt.
Feed-through terminal block		
UWV 16	3073419	50
Feed-through terminal block, with engagement pin		
UWV 16/S	3073432	50

ZB 12.../ZBF 12... marking material (see Catalog 5)

TMT (EX9,5)R marking material (see online catalog)



Dimensional drawing

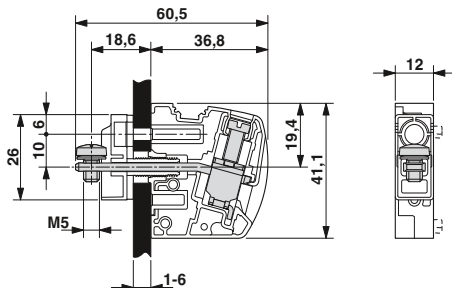

Drilling diagram

* Only when using the UW...-F flange plate
** Dimensions when using the DP-UW... spacer plate

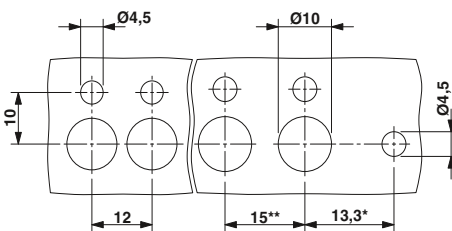

Ordering data

Type	Order No.	Pcs. / Pkt.
Feed-through terminal block		
UW 16-POT	3073487	50
Feed-through terminal block, with engagement pin		
UW 16-POT/S	3073490	50

ZB 12.../ZBF 12... marking material (see Catalog 5)

TMT (EX9,5)R marking material (see online catalog)



Dimensional drawing

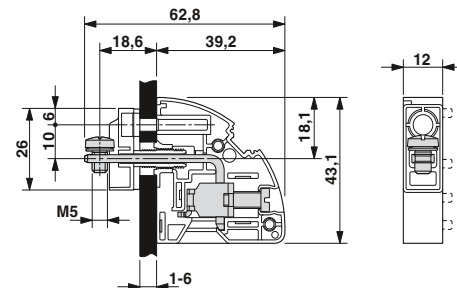

Drilling diagram

* Only when using the UW...-F flange plate
** Dimensions when using the DP-UW... spacer plate

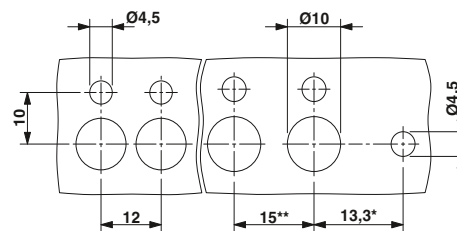

Ordering data

Type	Order No.	Pcs. / Pkt.
Feed-through terminal block		
UWV 16-POT	3073542	50
Feed-through terminal block, with engagement pin		
UWV 16-POT/S	3073555	50

ZB 12.../ZBF 12... marking material (see Catalog 5)

TMT (EX9,5)R marking material (see online catalog)

Feed-through terminal blocks for high-current applications

(Molded) feed-through terminal blocks with horizontal, vertical screw connection, UW/HDFK series

Internal with screw, cable lug connection up to 125 A/35 mm²



- Universal screw connection with screw locking
- Both terminal halves can be easily assembled by simply snapping them together
- Automatic panel thickness compensation
- Easy grouping with engagement pin versions
- Molded versions ensure maximum tightness of seal
- Touch-proof insulating housing in modern design
- Spacer plates increase air and creepage distances
- Flange plates for alternative mounting from the outside of the device

Notes:
Internal = left side of portrait photos. External = right side of portrait photos.
Corresponding screws for fixing the feed-through terminal blocks are supplied as standard.
For corresponding rivets for fixing the feed-through terminal blocks, see Catalog 5.
Notes on connecting aluminum conductors can be found at: www.phoenixcontact.net/products .
1) The voltage specifications apply for mounting on a conductive housing panel and when using spacer plates.



Feed-through terminal blocks, horizontal conductor connection

Accessories	
For all types	Type Screwdriver SZS 1,0 x 6,5 Order No. 1205079
For UW 25 .../S	Spacer plate, 4 mm thick DP-UW 25 Order No. 3074402
	Flange plate UW 25-F Order No. 3074541
For UWV 25 .../S	Spacer plate, 4 mm thick DP-UWV 25 Order No. 3074431
	Flange plate UWV 25-F Order No. 3074622

RU

Dimensional drawing

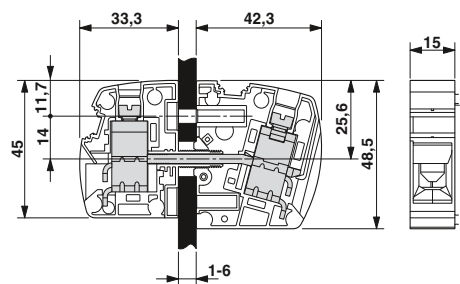

Drilling diagram

* Only when using the UW...-F flange plate
** Dimensions when using the DP-UW... spacer plate

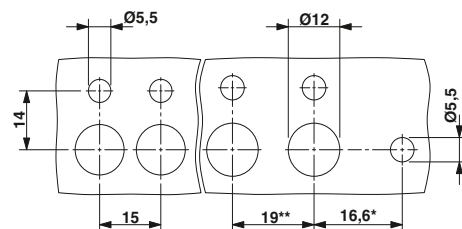

Technical data

Technical data in accordance to IEC / DIN VDE	
Current/conductor cross section	[A] / [mm ²]
Rated voltage	[V]
Connection capacity	
Solid / stranded	[mm ²] / [mm ²] / AWG
Stranded with ferrules without plastic sleeve	[mm ²]
Stranded with ferrules with plastic sleeve	[mm ²]
Multi-conductor connection capacity (two conductors with the same cross section)	
Solid / stranded	[mm ²]
Stranded with ferrules without plastic sleeve	[mm ²]
Stranded with TWIN ferrule with plastic sleeve	[mm ²]
Insulation coordination	
Surge voltage category / pollution degree	
Rated insulation voltage	[V]
Rated surge voltage	[kV]
Approval data (UL/CUL)	Use Group
Nominal voltage	[V]
Nominal current	[A]
Connection capacity AWG	AWG
Approval data (CSA)	Use Group
Nominal voltage	[V]
Nominal current	[A]
Connection capacity AWG	AWG
General data	
Stripping length	[mm]
Terminal sleeve: Thread / Torque	- / [Nm]
Insulation material	
Inflammability class according to UL 94	
Panel thickness	[mm]

	125 / 35 // 101 / 25
	800 ¹⁾
	6 - 35 / 10 - 25 / 10 - 2
	4 - 25
	4 - 25
	2.5 - 10 / 4 - 10
	2.5 - 10
	2.5 - 10
	III / 3 III / 2 II / 2
	800 ¹⁾ 1000 ¹⁾ 1000 ¹⁾
	8 ¹⁾ 8 ¹⁾ 8 ¹⁾
	B C D
	600 ¹⁾ 600 ¹⁾ -
	112.5 112.5 -
	10 - 2 10 - 2 -
	B C D
	- - -
	- - -
	- - -
	19
	M5 / 4 - 4.5
	PA
	V0
	1 - 6

Description

Ordering data

Type	Order No.	Pcs. / Pkt.
Feed-through terminal block		
UW 25	3073364	25
Feed-through terminal block, with engagement pin		
UW 25/S	3073377	25

ZB 15.../ZBF 15... marking material (see Catalog 5)

TMT (EX9,5)R marking material (see online catalog)

Feed-through terminal blocks for high-current applications

(Molded) feed-through terminal blocks with horizontal, vertical screw connection, UW/HDFK series



Feed-through terminal blocks, vertical conductor connection



Molded feed-through terminal blocks, horizontal conductor connection, internal part with M6 screw connection



Molded feed-through terminal blocks, vertical conductor connection, internal part with M6 screw connection



Dimensional drawing

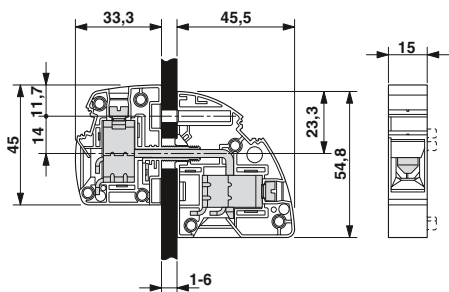

Drilling diagram

* Only when using the UW...-F flange plate
** Dimensions when using the DP-UW... spacer plate

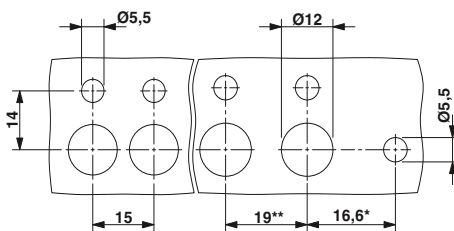

Ordering data

Type	Order No.	Pcs. / Pkt.
Feed-through terminal block		
UWV 25	3073445	25
Feed-through terminal block, with engagement pin		
UWV 25/S	3073458	25

ZB 15.../ZBF 15... marking material (see Catalog 5)

TMT (EX9,5)R marking material (see online catalog)



Dimensional drawing

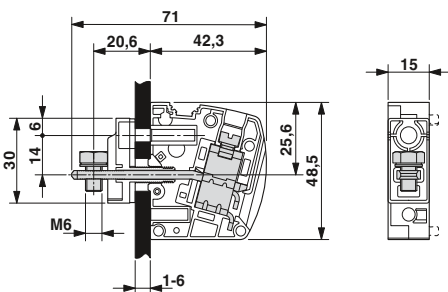

Drilling diagram

* Only when using the UW...-F flange plate
** Dimensions when using the DP-UW... spacer plate

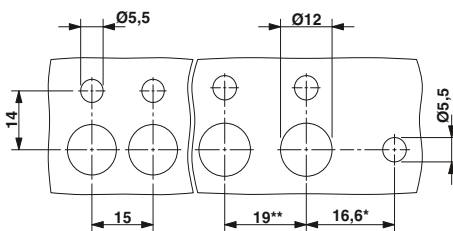

Ordering data

Type	Order No.	Pcs. / Pkt.
Feed-through terminal block		
UW 25-POT	3073500	25
Feed-through terminal block, with engagement pin		
UW 25-POT/S	3073513	25

ZB 15.../ZBF 15... marking material (see Catalog 5)

TMT (EX9,5)R marking material (see online catalog)



Dimensional drawing

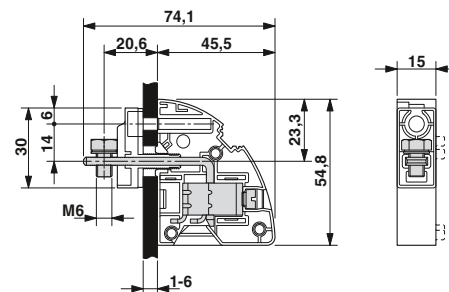

Drilling diagram

* Only when using the UW...-F flange plate
** Dimensions when using the DP-UW... spacer plate

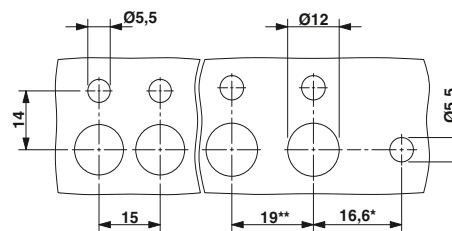

Ordering data

Type	Order No.	Pcs. / Pkt.
Feed-through terminal block		
UWV 25-POT	3073568	25
Feed-through terminal block, with engagement pin		
UWV 25-POT/S	3073571	25

ZB 15.../ZBF 15... marking material (see Catalog 5)

TMT (EX9,5)R marking material (see online catalog)

Feed-through terminal blocks for high-current applications

(Molded) feed-through terminal blocks with horizontal, vertical screw connection, UW/HDFK series

Internal with screw, cable lug connection up to 150 A/50 mm²





- Universal screw connection with screw locking
- Both terminal halves can be easily assembled by simply snapping them together
- Automatic panel thickness compensation
- Easy grouping with engagement pin versions
- Touch-proof insulating housing
- Spacer plates increase air and creepage distances

Notes:

Internal = left side of portrait photos.
External = right side of portrait photos.

Notes on connecting aluminum conductors can be found at:
www.phoenixcontact.net/products.

Accessories

For all types	Type	
	Insertion profile UKH 50 EP Order No. 3009228	
	Screwdriver SZS 1.2X8.0 Order No. 1205082	
Only for HDFK 50		
	Spacer plate DP-HDFK 50/7.2 Order No. 0709990	

Technical data

Technical data in accordance to IEC / DIN VDE

Current/conductor cross section	[A] / [mm ²]
Rated voltage	[V]
Connection capacity	
Solid / stranded	[mm ²] / [mm ²] / AWG
Stranded with ferrules without plastic sleeve	[mm ²]
Stranded with ferrules with plastic sleeve	[mm ²]
Multi-conductor connection capacity (two conductors with the same cross section)	
Solid / stranded	[mm ²]
Stranded with ferrules without plastic sleeve	[mm ²]
Stranded with TWIN ferrule with plastic sleeve	[mm ²]
Insulation coordination	
Surge voltage category / pollution degree	
Rated insulation voltage	[V]
Rated surge voltage	[kV]
Approval data (UL/CUL)	Use Group
Nominal voltage	[V]
Nominal current	[A]
Connection capacity AWG	AWG
Approval data (CSA)	Use Group
Nominal voltage	[V]
Nominal current	[A]
Connection capacity AWG	AWG
General data	
Stripping length	[mm]
Terminal sleeve: Thread / Torque	- / [Nm]
Insulation material	
Inflammability class according to UL 94	
Panel thickness	[mm]

HDFK 50

Current/conductor cross section	150 / 50 // 150 / 50		
Rated voltage	690		
Connection capacity			
Solid / stranded	16 - 50 / 16 - 50 / 6 - 1/0		
Stranded with ferrules without plastic sleeve	10 - 50		
Stranded with ferrules with plastic sleeve	10 - 50		
Multi-conductor connection capacity (two conductors with the same cross section)			
Solid / stranded	6 - 16 / 10 - 16		
Stranded with ferrules without plastic sleeve	6 - 16		
Stranded with TWIN ferrule with plastic sleeve	6 - 10		
Insulation coordination			
Surge voltage category / pollution degree	III / 3	III / 2	II / 2
Rated insulation voltage	690	1000	1000
Rated surge voltage	6	6	6
Approval data (UL/CUL)	B	C	D
Nominal voltage	600	600	-
Nominal current	150	150	-
Connection capacity AWG	6 - 1/0	6 - 1/0	-
Approval data (CSA)	B	C	D
Nominal voltage	600	600	-
Nominal current	125	125	-
Connection capacity AWG	6 - 1/0	6 - 1/0	-
General data			
Stripping length	24		
Terminal sleeve: Thread / Torque	M6 / 6 - 8		
Insulation material	PA		
Inflammability class according to UL 94	V0		
Panel thickness	1 - 6		

HDFKV 50

Current/conductor cross section	150 / 50 // 150 / 50		
Rated voltage	690		
Connection capacity			
Solid / stranded	16 - 50 / 16 - 50 / 6 - 1/0		
Stranded with ferrules without plastic sleeve	10 - 50		
Stranded with ferrules with plastic sleeve	10 - 50		
Multi-conductor connection capacity (two conductors with the same cross section)			
Solid / stranded	6 - 16 / 10 - 16		
Stranded with ferrules without plastic sleeve	6 - 16		
Stranded with TWIN ferrule with plastic sleeve	6 - 10		
Insulation coordination			
Surge voltage category / pollution degree	III / 3	III / 2	II / 2
Rated insulation voltage	690	1000	1000
Rated surge voltage	6	6	6
Approval data (UL/CUL)	B	C	D
Nominal voltage	600	600	-
Nominal current	150	150	-
Connection capacity AWG	6 - 1/0	6 - 1/0	-
Approval data (CSA)	B	C	D
Nominal voltage	600	600	-
Nominal current	125	125	-
Connection capacity AWG	6 - 1/0	6 - 1/0	-
General data			
Stripping length	24		
Terminal sleeve: Thread / Torque	M6 / 6 - 8		
Insulation material	PA		
Inflammability class according to UL 94	V0		
Panel thickness	1 - 6		

Description

Feed-through terminal blocks for high-current applications

(Molded) feed-through terminal blocks with horizontal, vertical screw connection, UW/HDFK series



Horizontal conductor connection



Vertical conductor connection



Dimensional drawing

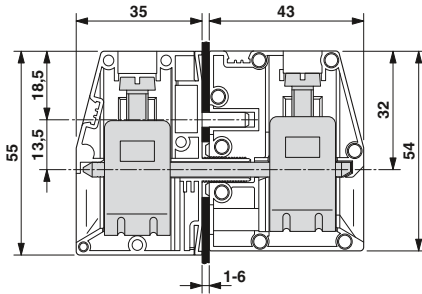

Drilling diagram

* Dimensions when using the DP-HDFK 50/7.2 spacer plate

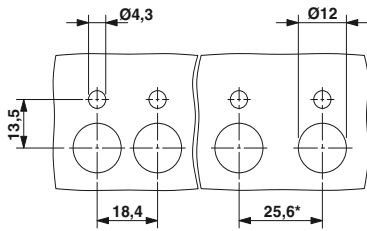

Ordering data

Type	Order No.	Pcs. / Pkt.
Feed-through terminal block		
HDFK 50	0708739	10
Feed-through terminal block, with engagement pin		
HDFK 50/Z	0705017	10

UC-TM 12 marking material for marking the center and lateral groove (see Catalog 5)
 ZB 15 marking material for marking the center and lateral groove (see Catalog 5)



Dimensional drawing

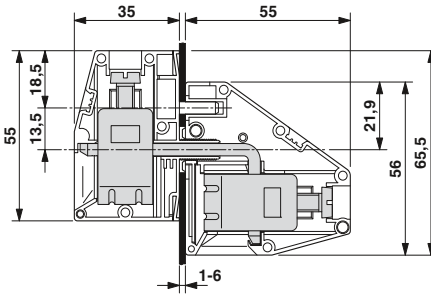

Drilling diagram

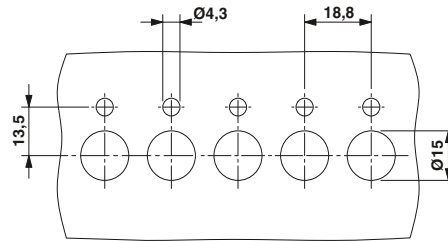

Ordering data

Type	Order No.	Pcs. / Pkt.
Feed-through terminal block		
HDFKV 50	0708522	10
Feed-through terminal block, with engagement pin		
HDFKV 50/Z	0714095	10

UC-TM 12 marking material for marking the center and lateral groove (see Catalog 5)
 ZB 15 marking material for marking the center and lateral groove (see Catalog 5)

Feed-through terminal blocks for high-current applications

(Molded) feed-through terminal blocks with horizontal, vertical screw connection, UW/HDFK series

Internal with screw, cable lug connection up to 232 A/95 mm²

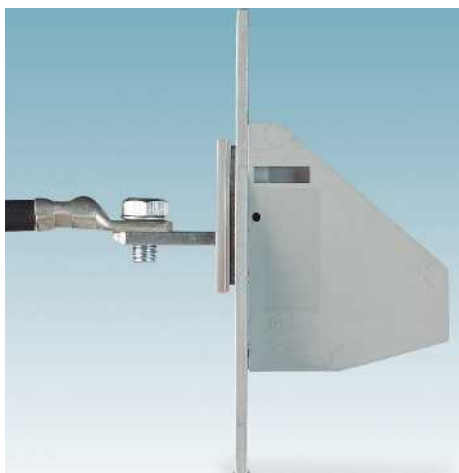

- Universal screw connection with screw locking
- Both terminal halves can be easily assembled by simply snapping them together
- Automatic panel thickness compensation
- Easy grouping with engagement pin versions
- Molded versions ensure maximum tightness of seal
- Touch-proof insulating housing





Notes:

Internal = left side of portrait photos.
External = right side of portrait photos.

Notes on connecting aluminum conductors can be found at:
www.phoenixcontact.net/products.

¹⁾ 630 V for metal panels from 2.5 mm to 5 mm.
500 V for metal panels from 5 mm to 6 mm.

Accessories

For all types	Type	
Only for HDFK 50-VP and HDFKV 50-VP		
	Insertion profile UKH 50 EP Order No. 3009228	
	Screwdriver SZS 1.2X8.0 Order No. 1205082	
Only for HDFKV 95-F-VP		
	Insertion profile UKH 95 EP Order No. 3009231	
	Allen wrench VDE-ISS 6 Order No. 1201934	

Technical data

Technical data in accordance to IEC / DIN VDE

Current/conductor cross section	[A] / [mm ²]
Rated voltage	[V]
Connection capacity	
Solid / stranded	[mm ²] / [mm ²] / AWG
Stranded with ferrules without plastic sleeve	[mm ²]
Stranded with ferrules with plastic sleeve	[mm ²]
Multi-conductor connection capacity (two conductors with the same cross section)	
Solid / stranded	[mm ²]
Stranded with ferrules without plastic sleeve	[mm ²]
Stranded with TWIN ferrule with plastic sleeve	[mm ²]
Insulation coordination	
Surge voltage category / pollution degree	
Rated insulation voltage	[V]
Rated surge voltage	[kV]
Approval data (UL/CUL)	Use Group
Nominal voltage	[V]
Nominal current	[A]
Connection capacity AWG	AWG
Approval data (CSA)	Use Group
Nominal voltage	[V]
Nominal current	[A]
Connection capacity AWG	AWG
General data	
Stripping length	[mm]
Terminal sleeve: Thread / Torque	- / [Nm]
Cable lug connection: Thread / tightening torque	
Insulation material	
Inflammability class according to UL 94	
Panel thickness	[mm]

HDFK 50-VP

Current/conductor cross section	150 / 50 // 150 / 50
Rated voltage	690
Connection capacity	
Solid / stranded	16 - 50 / 16 - 50 / 6 - 1/0
Stranded with ferrules without plastic sleeve	10 - 50
Stranded with ferrules with plastic sleeve	10 - 50
Multi-conductor connection capacity (two conductors with the same cross section)	
Solid / stranded	6 - 16 / 10 - 16
Stranded with ferrules without plastic sleeve	6 - 16
Stranded with TWIN ferrule with plastic sleeve	6 - 10
Insulation coordination	
Surge voltage category / pollution degree	III / 3 III / 2 II / 2
Rated insulation voltage	690 1000 1000
Rated surge voltage	6 6 6
Approval data (UL/CUL)	B C D
Nominal voltage	600 600 -
Nominal current	150 150 -
Connection capacity AWG	6 - 1/0 6 - 1/0 -
Approval data (CSA)	B C D
Nominal voltage	600 600 -
Nominal current	125 125 -
Connection capacity AWG	6 - 1/0 6 - 1/0 -
General data	
Stripping length	24
Terminal sleeve: Thread / Torque	M6 / 6 - 8
Cable lug connection: Thread / tightening torque	
Insulation material	PA
Inflammability class according to UL 94	V0
Panel thickness	1 - 6

HDFKV 50-VP

Current/conductor cross section	150 / 50 // 150 / 50
Rated voltage	690
Connection capacity	
Solid / stranded	16 - 50 / 16 - 50 / 6 - 1/0
Stranded with ferrules without plastic sleeve	10 - 50
Stranded with ferrules with plastic sleeve	10 - 50
Multi-conductor connection capacity (two conductors with the same cross section)	
Solid / stranded	6 - 16 / 10 - 16
Stranded with ferrules without plastic sleeve	6 - 16
Stranded with TWIN ferrule with plastic sleeve	6 - 10
Insulation coordination	
Surge voltage category / pollution degree	III / 3 III / 2 II / 2
Rated insulation voltage	690 1000 1000
Rated surge voltage	6 6 6
Approval data (UL/CUL)	B C D
Nominal voltage	600 600 -
Nominal current	150 150 -
Connection capacity AWG	6 - 1/0 6 - 1/0 -
Approval data (CSA)	B C D
Nominal voltage	600 600 -
Nominal current	125 125 -
Connection capacity AWG	6 - 1/0 6 - 1/0 -
General data	
Stripping length	24
Terminal sleeve: Thread / Torque	M6 / 6 - 8
Cable lug connection: Thread / tightening torque	
Insulation material	PA
Inflammability class according to UL 94	V0
Panel thickness	1 - 6

HDFK 95-F-VP

Current/conductor cross section	232 / 95 // 232 / 95
Rated voltage	630 ¹⁾
Connection capacity	
Solid / stranded	35 - 95 / 35 - 95 / 4 - 3/0
Stranded with ferrules without plastic sleeve	30 - 95
Stranded with ferrules with plastic sleeve	30 - 95
Multi-conductor connection capacity (two conductors with the same cross section)	
Solid / stranded	25 - 35 / 25 - 35
Stranded with ferrules without plastic sleeve	16 - 35
Stranded with TWIN ferrule with plastic sleeve	-
Insulation coordination	
Surge voltage category / pollution degree	III / 3 III / 2 II / 2
Rated insulation voltage	630 1000 1000
Rated surge voltage	6 6 6
Approval data (UL/CUL)	B C D
Nominal voltage	600 600 -
Nominal current	230 230 -
Connection capacity AWG	4 - 4/0 4 - 4/0 -
Approval data (CSA)	B C D
Nominal voltage	600 600 -
Nominal current	200 200 -
Connection capacity AWG	2 - 4/0 2 - 4/0 -
General data	
Stripping length	27
Terminal sleeve: Thread / Torque	M8 / 15 - 20
Cable lug connection: Thread / tightening torque	
Insulation material	PA
Inflammability class according to UL 94	V0
Panel thickness	1 - 6

Description

Feed-through terminal blocks for high-current applications

(Molded) feed-through terminal blocks with horizontal, vertical screw connection, UW/HDFK series



50 mm² feed-through terminal blocks, horizontal conductor connection



50 mm² feed-through terminal blocks, vertical conductor connection



95 mm² feed-through terminal blocks, horizontal conductor connection, external terminal half with screw flange



Dimensional drawing

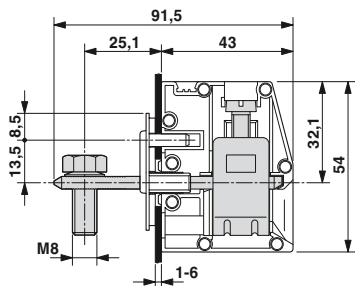

Drilling diagram

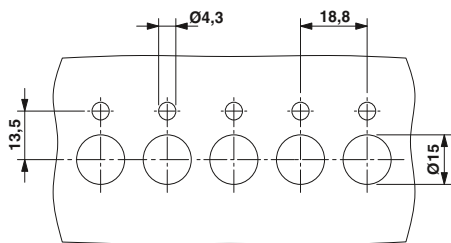

Ordering data

Type	Order No.	Pcs. / Pkt.
Feed-through terminal block		
HDFK 50-VP	0709123	10
Feed-through terminal block, with engagement pin		
HDFK 50-VP/Z	0711218	10

UC-TM 12 marking material for marking the center and lateral groove (see Catalog 5)
 ZB 15 marking material for marking the center and lateral groove (see Catalog 5)



Dimensional drawing

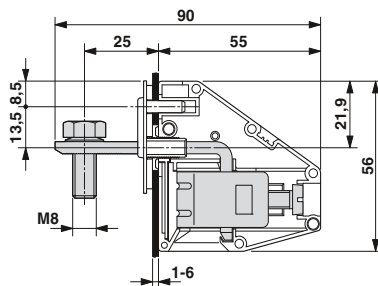

Drilling diagram

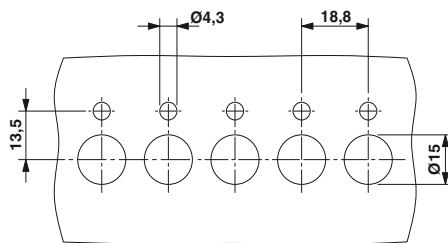

Ordering data

Type	Order No.	Pcs. / Pkt.
Feed-through terminal block		
HDFKV 50-VP	0708580	10
Feed-through terminal block, with engagement pin		
HDFKV 50-VP/Z	0717212	10

UC-TM 12 marking material for marking the center and lateral groove (see Catalog 5)
 ZB 15 marking material for marking the center and lateral groove (see Catalog 5)



Dimensional drawing

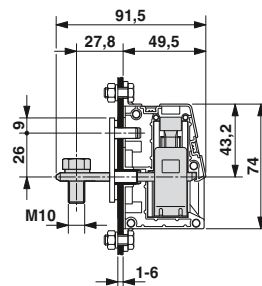

Drilling diagram

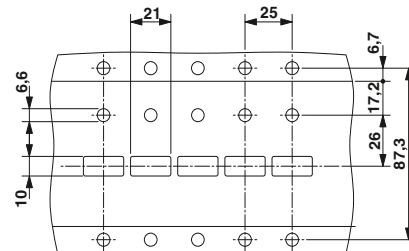

Ordering data

Type	Order No.	Pcs. / Pkt.
Feed-through terminal block		
HDFK 95-F-VP	0709916	10
Feed-through terminal block, with engagement pin		
HDFK 95-F-VP/Z	0717076	10

UC-TM 12 marking material for marking the center and lateral groove (see Catalog 5)
 ZB 12 marking material for marking the center and lateral groove (see Catalog 5)

Feed-through terminal blocks for high-current applications

(Molded) feed-through terminal blocks with horizontal, vertical screw connection, UW/HDFK series

Internal with screw, cable lug connection up to 232 A/95 mm²



- Universal screw connection with screw locking
- Both terminal halves can be easily assembled by simply snapping them together
- Automatic panel thickness compensation
- Easy grouping with engagement pin versions
- Spacer plates increase air and creepage distances
- Touch-proof insulating housing

Notes:

Internal = left side of portrait photos.
External = right side of portrait photos.

Notes on connecting aluminum conductors can be found at:
www.phoenixcontact.net/products.

1) 1000 V for metal panels from 1 mm to 2.5 mm.
800 V for metal panels larger than 2.5 mm up to 5 mm.
690 V for metal panels larger than 5 mm up to 6 mm.



Horizontal conductor connection





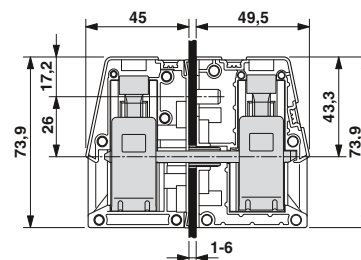

Dimensional drawing

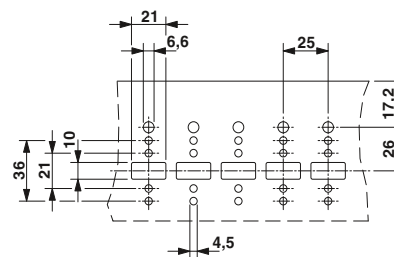

Drilling diagram

* Dimensions when using the DP-HDFK 95/15 spacer plate



Accessories	
For all types	Type
	Insertion profile UKH 95 EP Order No. 3009231
	Allen wrench VDE-ISS 6 Order No. 1201934
Only for HDFK 95	
	Spacer plate DP-HDFK 95/15 Order No. 0717102

Technical data

Technical data in accordance to IEC / DIN VDE

Current/conductor cross section	[A] / [mm ²]	232 / 95 // 232 / 95
Rated voltage	[V]	1000 ¹⁾
Connection capacity		
Solid / stranded	[mm ²] / [mm ²] / AWG	35 - 95 / 35 - 95 / 4 - 2/0
Stranded with ferrules without plastic sleeve	[mm ²]	25 - 95
Stranded with ferrules with plastic sleeve	[mm ²]	25 - 95
Multi-conductor connection capacity (two conductors with the same cross section)		
Solid / stranded	[mm ²]	25 - 35 / 25 - 35
Stranded with ferrules without plastic sleeve	[mm ²]	16 - 35
Stranded with TWIN ferrule with plastic sleeve	[mm ²]	-
Insulation coordination		
Surge voltage category / pollution degree		III / 3 III / 2 II / 2
Rated insulation voltage	[V]	1000 1000 1000
Rated surge voltage	[kV]	8 6 6
Approval data (UL/CUL)	Use Group	B C D
Nominal voltage	[V]	600 600 -
Nominal current	[A]	230 230 -
Connection capacity AWG	AWG	4 - 4/0 4 - 4/0 -
Approval data (CSA)	Use Group	B C D
Nominal voltage	[V]	600 600 -
Nominal current	[A]	200 200 -
Connection capacity AWG	AWG	2 - 4/0 2 - 4/0 -
General data		
Stripping length	[mm]	27
Terminal sleeve: Thread / Torque	- / [Nm]	M8 / 15 - 20
Insulation material		PA
Inflammability class according to UL 94		V0
Panel thickness	[mm]	1 - 6

Description

Ordering data

Type	Order No.	Pcs. / Pkt.
Feed-through terminal block		
HDFK 95	0709534	10
Feed-through terminal block, with engagement pin		
HDFK 95/Z	0717364	10

UC-TM 12 marking material for marking the center and lateral groove (see Catalog 5)
ZB 12 marking material for marking the center and lateral groove (see Catalog 5)

Feed-through terminal blocks for high-current applications

(Molded) feed-through terminal blocks with horizontal, vertical screw connection, UW/HDFK series



Horizontal conductor connection,
external terminal half with screw flange



Vertical conductor connection



Vertical conductor connection,
external terminal half with screw flange



Dimensional drawing

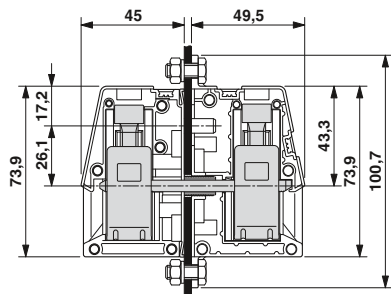

Drilling diagram

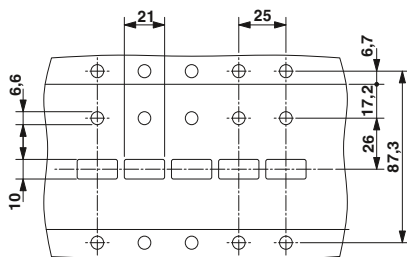

Ordering data

Type	Order No.	Pcs. / Pkt.
Feed-through terminal block		
HDFK 95-F	0709644	10
Feed-through terminal block, with engagement pin		
HDFK 95-F/Z	0714037	10

UC-TM 12 marking material for marking the center and lateral groove (see Catalog 5)
ZB 12 marking material for marking the center and lateral groove (see Catalog 5)



Dimensional drawing

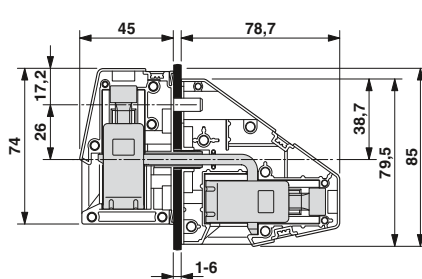

Drilling diagram

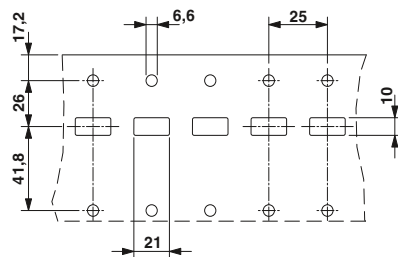

Ordering data

Type	Order No.	Pcs. / Pkt.
Feed-through terminal block		
HDFKV 95	0709547	10
Feed-through terminal block, with engagement pin		
HDFKV 95/Z	0714105	10

UC-TM 12 marking material for marking the center and lateral groove (see Catalog 5)
ZB 12 marking material for marking the center and lateral groove (see Catalog 5)



Dimensional drawing

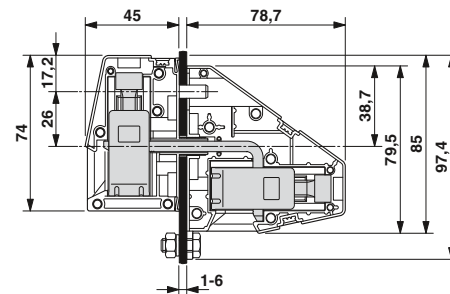

Drilling diagram

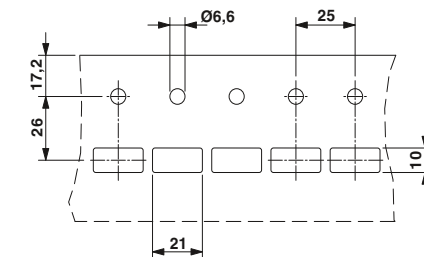

Ordering data

Type	Order No.	Pcs. / Pkt.
Feed-through terminal block		
HDFKV 95-F	0709673	10
Feed-through terminal block, with engagement pin		
HDFKV 95-F/Z	0714118	10

UC-TM 12 marking material for marking the center and lateral groove (see Catalog 5)
ZB 12 marking material for marking the center and lateral groove (see Catalog 5)

Feed-through terminal blocks for high-current applications

(Molded) feed-through terminal blocks with horizontal, vertical screw connection, UW/HDFK series

Vertical double connection outside up to 152 A/35 mm²



- Universal screw connection with screw locking
- Ideal for looping through power supply cables
- Both terminal halves can be easily assembled by simply snapping them together
- Automatic panel thickness compensation
- Easy grouping with engagement pin versions
- Touch-proof insulating housing

Notes:
Internal = left side of portrait photos. External = right side of portrait photos.
Note: With the HDFKV-TWIN, the terminal space must be completely open when joining both terminal block halves.
1) The max. load current must not be exceeded by the total current of all connected conductors.
2) 400 V for metal panels from 1 mm to 2.5 mm. 250 V for metal panels larger than 2.5 mm up to 4 mm. 500 V for plastic panels from 1 mm to 4 mm.

Accessories

For all types	Type	
	Screwdriver SZS 1,0 x 4,0 Order No. 1205066	
Only for HDFK 10-TWIN		
	Insertion bridge EB 2-10 Order No. 0203153	
	Insertion bridge EB 3-10 Order No. 0203328	
	Insertion bridge EB 10-10 Order No. 0203137	

Technical data

Technical data in accordance to IEC / DIN VDE	
Current/conductor cross section	[A] / [mm ²]
Rated voltage	[V]
Connection capacity	
Solid / stranded	[mm ²] / [mm ²] / AWG
Stranded with ferrules without plastic sleeve	[mm ²]
Stranded with ferrules with plastic sleeve	[mm ²]
Multi-conductor connection capacity (two conductors with the same cross section)	
Solid / stranded	[mm ²]
Stranded with ferrules without plastic sleeve	[mm ²]
Stranded with TWIN ferrule with plastic sleeve	[mm ²]
Cross section with insertion bridge (solid/stranded)	[mm ²]
Insulation coordination	
Surge voltage category / pollution degree	
Rated insulation voltage	[V]
Rated surge voltage	[kV]
Approval data (UL/CUL)	Use Group
Nominal voltage	[V]
Nominal current	[A]
Connection capacity AWG	AWG
Approval data (CSA)	Use Group
Nominal voltage	[V]
Nominal current	[A]
Connection capacity AWG	AWG
General data	
Stripping length	[mm]
Terminal sleeve: Thread / Torque	- / [Nm]
Insulation material	
Inflammability class according to UL 94	
Panel thickness	[mm]

HDFKV 10-TWIN

76 ¹⁾ / 16 // 57 ¹⁾ // 10			125 ¹⁾ / 35 // 101 ¹⁾ // 25		
400 ²⁾			500		
0.5 - 16 / 0.5 - 10 / 20 - 6			6 - 35 / 10 - 25 / 10 - 2		
0.5 - 10			4 - 25		
0.5 - 10			4 - 25		
0.5 - 4 / 0.5 - 4			2.5 - 10 / 4 - 10		
0.5 - 2.5			2.5 - 10		
0.5 - 6			2.5 - 10		
2.5 - 10 / 2.5 - 10			- / -		
III / 3	III / 2	II / 2	III / 3	III / 2	II / 2
400	1000	1000	500	1000	1000
6	6	6	6	6	6
B	C	D	B	C	D
-	600	300	600	600	-
-	65	10	115	115	-
-	24 - 6	24 - 6	8 - 2	8 - 2	-
B	C	D	B	C	D
-	-	-	600	600	-
-	-	-	100	100	-
-	-	-	8 - 4	8 - 4	-
11			19		
M4 / 1.5 - 1.8			M5 / 4 - 4.5		
PA			PA		
V0			V0		
1 - 4			1 - 6		

Description

(Molded) feed-through terminal blocks with horizontal, vertical screw connection, UW/HDFK series

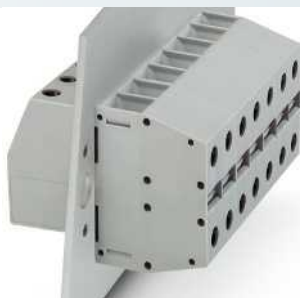

10/16 mm² TWIN feed-through terminal blocks

25/35 mm² TWIN feed-through terminal blocks



Dimensional drawing

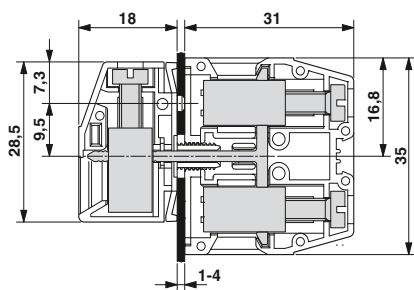

Drilling diagram

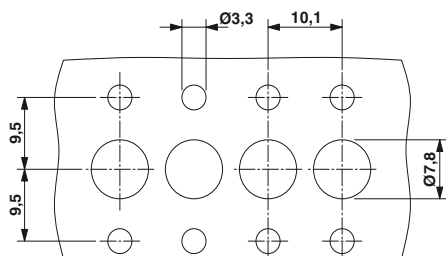

Ordering data

Type	Order No.	Pcs. / Pkt.
Feed-through terminal block		
HDFKV 10-TWIN	0709550	50

UC-TM 8 marking material for marking the center and lateral groove (see Catalog 5)
 ZB 8 marking material for marking the center and lateral groove (see Catalog 5)



Dimensional drawing

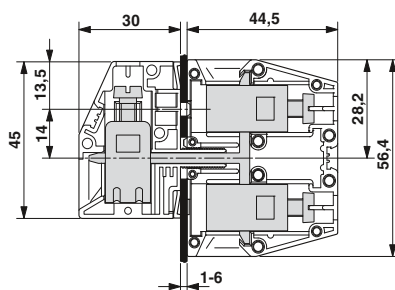

Drilling diagram

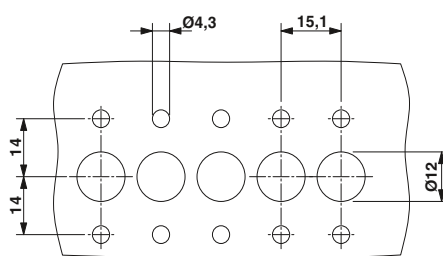

Ordering data

Type	Order No.	Pcs. / Pkt.
Feed-through terminal block		
HDFKV 25-TWIN	0709563	25

UC-TM 10 marking material for marking the center and lateral groove (see Catalog 5)
 ZB 10 marking material for marking the center and lateral groove (see Catalog 5)

Feed-through terminal blocks for high-current applications

(Molded) feed-through terminal blocks with horizontal, vertical bolt connection, RW series

With captive cover nut up to **76 A/16 mm²**

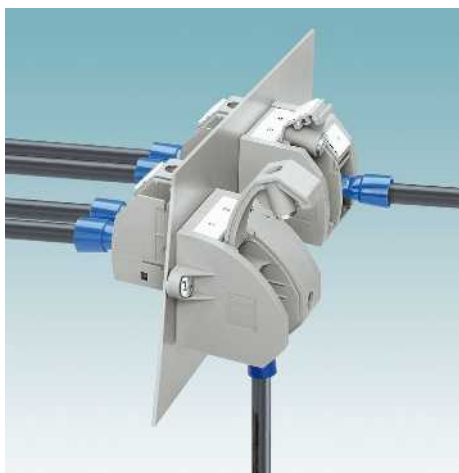

- Quick and easy conductor connection, thanks to hinged cover flaps with captive clamping nut
- Both terminal halves can be easily assembled by simply snapping them together
- Automatic panel thickness compensation
- Easy grouping with engagement pin versions
- Molded versions ensure maximum tightness of seal
- Touch-proof insulating housing in modern design
- Spring-loaded spacers protect the bolt connection against loosening

Notes:
Internal = left side of portrait photos. External = right side of portrait photos.
Corresponding screws for fixing the feed-through terminal blocks are supplied as standard.
For corresponding rivets for fixing the feed-through terminal blocks, see Catalog 5.



Feed-through terminal blocks, horizontal conductor connection

Accessories	
For all types	Type Screwdriver SZS 0,6 x 3,5 Order No. 1205053
For RW 5 .../S	Flange plate RW 5-F Order No. 3075155
For RWV 5 .../S	Flange plate RWV 5-F Order No. 3075317



Dimensional drawing

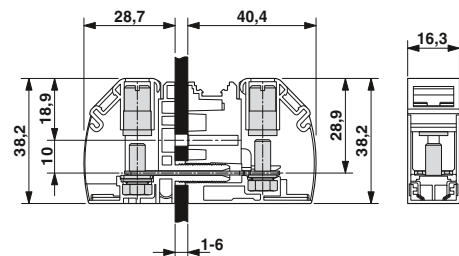

Drilling diagram

* Only when using the RW...-F flange plate

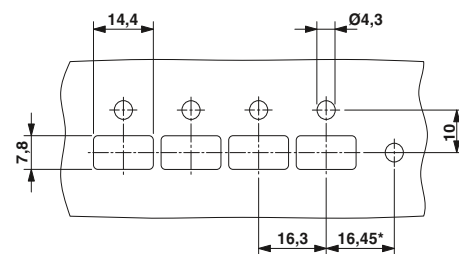

Technical data

Technical data in accordance to IEC / DIN VDE		
Current/conductor cross section	[A] / [mm ²]	76 / 16 // 76 / 16
Rated voltage	[V]	1000
Connection capacity, DIN 46234		
Cable lugs, DIN 46234	[mm ²]	0.5 - 16
Connection bolt / hole diameter / width	[mm]	5 / 5.3 / 11
Connection capacity DIN 46235		
Cable lugs DIN 46235	[mm ²]	6 - 10
Connection bolt / hole diameter / width	[mm]	5 / 5.3 / 9
Connection capacity, DIN 46237		
Cable lugs DIN 46237	[mm ²]	1 - 6
Connection bolt / hole diameter / width	[mm]	5 / 5.3 / 10
Color code		1.00 mm ² red 2.50 mm ² blue 6.00 mm ² yellow
Insulation coordination		
Surge voltage category / pollution degree		III / 3 III / 2 II / 2
Rated insulation voltage	[V]	1000 1000 1000
Rated surge voltage	[kV]	8 8 8
Approval data (UL/CUL)	Use Group	B C D
Nominal voltage	[V]	600 600 -
Nominal current	[A]	65 65 -
Connection capacity AWG		26 - 6 26 - 6 -
Approval data (CSA)	Use Group	B C D
Nominal voltage	[V]	- - -
Nominal current	[A]	- - -
Connection capacity AWG	AWG	- - -
General data		
Bolt thread/tightening torque	- / [Nm]	M5 / 2.5 - 3
Insulation material		PA
Inflammability class according to UL 94		V0
Panel thickness	[mm]	1 - 6

Ordering data

Type	Order No.	Pcs. / Pkt.
Feed-through terminal block		
RW 5	3073584	10
Feed-through terminal block, with engagement pin		
RW 5/S	3073597	10

ZB 16.../ZBF 16... marking material for marking the center groove (see Catalog 5)
 ZB 12.../ZBF 12... marking material for marking the lateral groove (see Catalog 5)
 TMT (EX9,5)R marking material (see online catalog)

Feed-through terminal blocks for high-current applications

(Molded) feed-through terminal blocks with horizontal, vertical bolt connection, RW series



Feed-through terminal blocks, vertical conductor connection



Molded feed-through terminal blocks, horizontal conductor connection, internal part with M5 bolt connection



Molded feed-through terminal blocks, vertical conductor connection, internal part with M5 bolt connection



Dimensional drawing

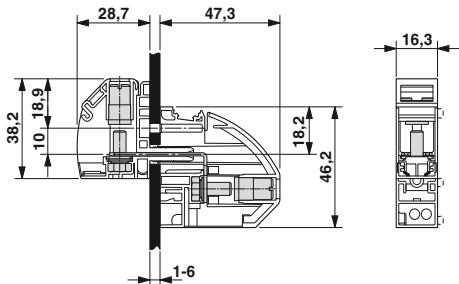

Drilling diagram

* Only when using the RW...-F flange plate

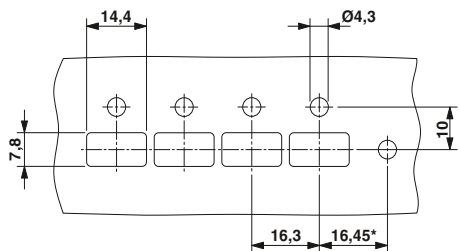

Ordering data

Type	Order No.	Pcs. / Pkt.
Feed-through terminal block		
RWV 5	3073746	10
Feed-through terminal block, with engagement pin		
RWV 5/S	3073759	10

ZB 16.../ZBF 16... marking material for marking the center groove (see Catalog 5)
 ZB 12.../ZBF 12... marking material for marking the lateral groove (see Catalog 5)
 TMT (EX9,5)R marking material (see online catalog)



Dimensional drawing

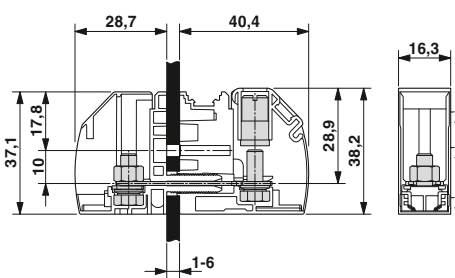

Drilling diagram

* Only when using the RW...-F flange plate

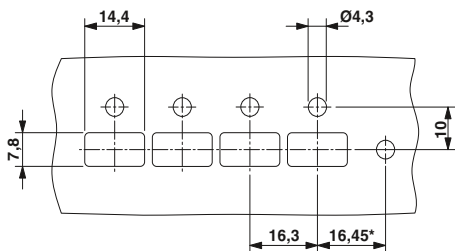

Ordering data

Type	Order No.	Pcs. / Pkt.
Feed-through terminal block, with sponge rubber seal		
RW 5-POT	3073665	10
Feed-through terminal block, with engagement pin and sponge rubber seal		
RW 5-POT/S	3073678	10

ZB 16.../ZBF 16... marking material for marking the center groove (see Catalog 5)
 ZB 12.../ZBF 12... marking material for marking the lateral groove (see Catalog 5)
 TMT (EX9,5)R marking material (see online catalog)



Dimensional drawing

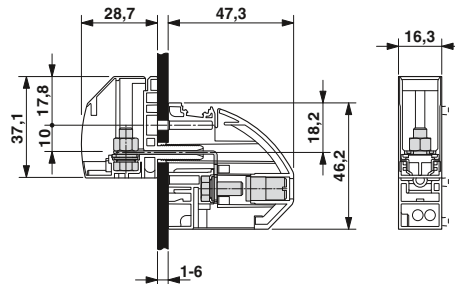

Drilling diagram

* Only when using the RW...-F flange plate

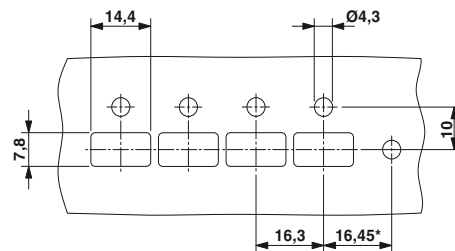

Ordering data

Type	Order No.	Pcs. / Pkt.
Feed-through terminal block, with sponge rubber seal		
RWV 5-POT	3073788	10
Feed-through terminal block, with engagement pin and sponge rubber seal		
RWV 5-POT/S	3073791	10

ZB 16.../ZBF 16... marking material for marking the center groove (see Catalog 5)
 TMT (EX9,5)R marking material (see online catalog)

Feed-through terminal blocks for high-current applications

(Molded) feed-through terminal blocks with horizontal, vertical bolt connection, RW series

With captive cover nut up to
125 A/35 mm²

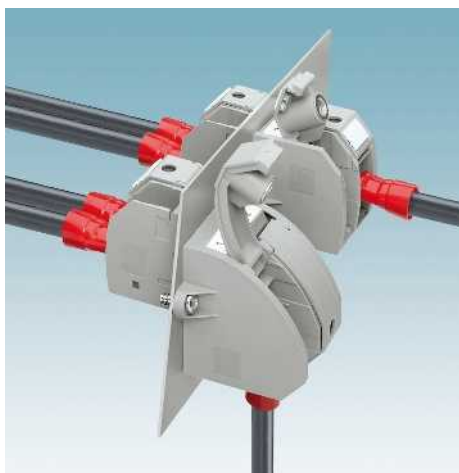



- Quick and easy conductor connection, thanks to hinged cover flaps with captive clamping nut
- Both terminal halves can be easily assembled by simply snapping them together
- Automatic panel thickness compensation
- Easy grouping with engagement pin versions
- Molded versions ensure maximum tightness of seal
- Touch-proof insulating housing in modern design
- Spring-loaded spacers protect the bolt connection against loosening

Notes:
Internal = left side of portrait photos. External = right side of portrait photos.
Corresponding screws for fixing the feed-through terminal blocks are supplied as standard.
For corresponding rivets for fixing the feed-through terminal blocks, see Catalog 5.



Feed-through terminal blocks, horizontal conductor connection

Accessories

For all types	Type
	Screwdriver SZS 1,0 x 4,0 Order No. 1205066
	Flange plate RW 8-F Order No. 3075171
	Flange plate RWV 8-F Order No. 3075333



Dimensional drawing

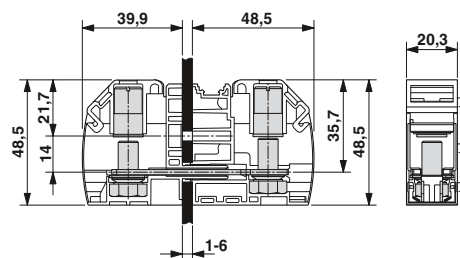

Drilling diagram

* Only when using the RW...-F flange plate

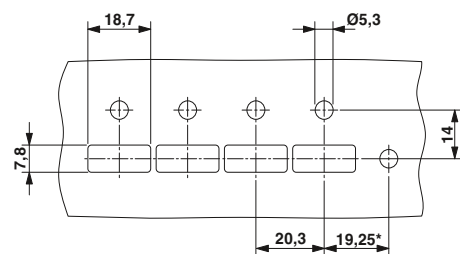

Technical data

Technical data in accordance to IEC / DIN VDE	
Current/conductor cross section	[A] / [mm ²]
Rated voltage	[V]
Connection capacity, DIN 46234	
Cable lugs, DIN 46234	[mm ²]
Connection bolt / hole diameter / width	[mm]
Connection capacity DIN 46235	
Cable lugs DIN 46235	[mm ²]
Connection bolt / hole diameter / width	[mm]
Connection capacity, DIN 46237	
Cable lugs DIN 46237	[mm ²]
Connection bolt / hole diameter / width	[mm]
Color code	red
	blue
	yellow

	125 / 35 // 125 / 35
	1000
	2.5 - 35
	8 / 8.4 / 16
	16 - 25
	8 / 8.4 / 14
	2.5 - 6
	8 / 8.4 / 14
	-
	2.50 mm ²
	6.00 mm ²

Insulation coordination	
Surge voltage category / pollution degree	
Rated insulation voltage	[V]
Rated surge voltage	[kV]
Approval data (UL/CUL)	Use Group
Nominal voltage	[V]
Nominal current	[A]
Connection capacity AWG	AWG
Approval data (CSA)	Use Group
Nominal voltage	[V]
Nominal current	[A]
Connection capacity AWG	AWG
General data	
Bolt thread/tightening torque	- / [Nm]
Insulation material	
Inflammability class according to UL 94	
Panel thickness	[mm]

	III / 3	III / 2	II / 2
Rated insulation voltage	1000	1000	1000
Rated surge voltage	8	8	8
Approval data (UL/CUL)	B	C	D
Nominal voltage	600	600	-
Nominal current	115	115	-
Connection capacity AWG	14 - 2	14 - 2	-
Approval data (CSA)	B	C	D
Nominal voltage	-	-	-
Nominal current	-	-	-
Connection capacity AWG	-	-	-
Bolt thread/tightening torque	M8 / 4.5 - 5		
Insulation material	PA		
Inflammability class according to UL 94	V0		
Panel thickness	1 - 6		

Ordering data

Type	Order No.	Pcs. / Pkt.
Feed-through terminal block		
RW 8	3073607	10
Feed-through terminal block, with engagement pin		
RW 8/S	3073610	10

ZB 20,3 marking material for marking the center groove (see online catalog)
ZB 16.../ZBF 16... marking material for marking the lateral groove (see Catalog 5)
TMT (EX9,5)R marking material (see online catalog)

Feed-through terminal blocks for high-current applications

(Molded) feed-through terminal blocks with horizontal, vertical bolt connection, RW series



Feed-through terminal blocks, vertical conductor connection



Molded feed-through terminal blocks, horizontal conductor connection, internal part with M8 bolt connection



Molded feed-through terminal blocks, vertical conductor connection, internal part with M8 bolt connection



Dimensional drawing

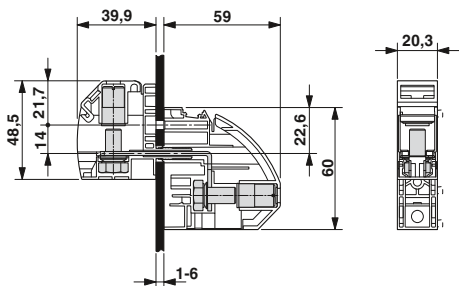

Drilling diagram

* Only when using the RW...-F flange plate

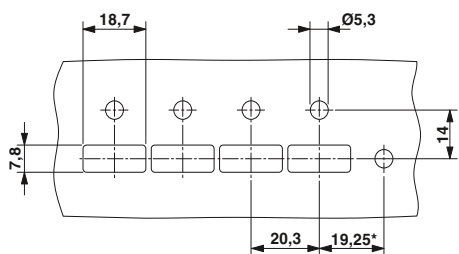

Ordering data

Type	Order No.	Pcs. / Pkt.
Feed-through terminal block		
RWV 8	3073762	10
Feed-through terminal block, with engagement pin		
RWV 8/S	3073775	10

ZB 20,3 marking material for marking the center groove (see online catalog)
 ZB 16.../ZBF 16... marking material for marking the lateral groove (see Catalog 5)
 TMT (EX9,5)R marking material (see online catalog)



Dimensional drawing

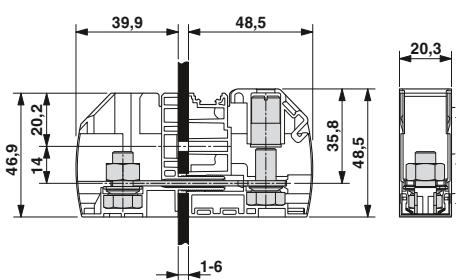

Drilling diagram

* Only when using the RW...-F flange plate

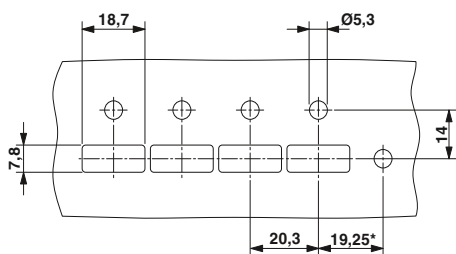

Ordering data

Type	Order No.	Pcs. / Pkt.
Feed-through terminal block, with sponge rubber seal		
RW 8-POT	3073681	10
Feed-through terminal block, with engagement pin and sponge rubber seal		
RW 8-POT/S	3073694	10

ZB 20,3 marking material for marking the center groove (see online catalog)
 ZB 16.../ZBF 16... marking material for marking the lateral groove (see Catalog 5)
 TMT (EX9,5)R marking material (see online catalog)



Dimensional drawing

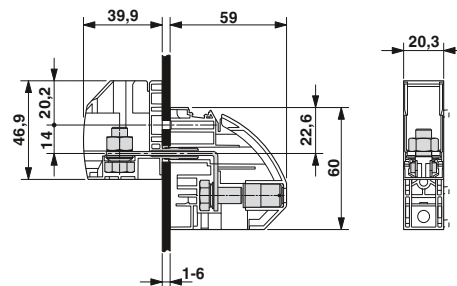

Drilling diagram

* Only when using the RW...-F flange plate

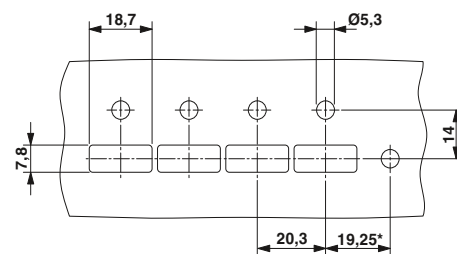

Ordering data

Type	Order No.	Pcs. / Pkt.
Feed-through terminal block, with sponge rubber seal		
RWV 8-POT	3073801	10
Feed-through terminal block, with engagement pin and sponge rubber seal		
RWV 8-POT/S	3073814	10

ZB 20,3 marking material for marking the center groove (see online catalog)
 TMT (EX9,5)R marking material (see online catalog)

Feed-through terminal blocks for high-current applications

(Molded) feed-through terminal blocks with horizontal, vertical bolt connection, RW series

In open housing up to 76 A/16 mm²

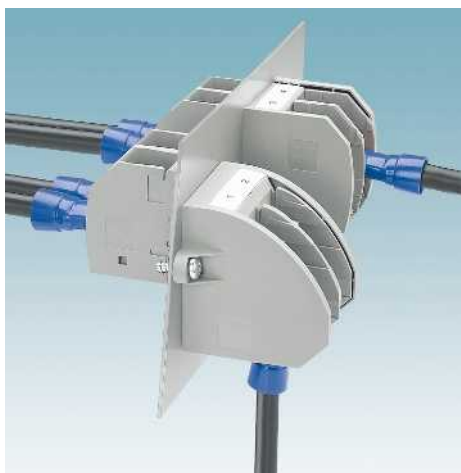

- Both terminal halves can be easily assembled by simply snapping them together
- Automatic panel thickness compensation
- Easy grouping with engagement pin versions
- Molded versions ensure maximum tightness of seal
- Spring-loaded spacers protect the bolt connection against loosening

Notes:
Internal = left side of portrait photos. External = right side of portrait photos.
Corresponding screws for fixing the feed-through terminal blocks are supplied as standard.
For corresponding rivets for fixing the feed-through terminal blocks, see Catalog 5.



Feed-through terminal blocks, horizontal conductor connection

Accessories	
For all types	Type Socket wrench SHN 8 Order No. 1209868
For RWO 5 .../S	Flange plate RW 5-F Order No. 3075155
For RWOV 5 .../S	Flange plate RWV 5-F Order No. 3075317



Dimensional drawing

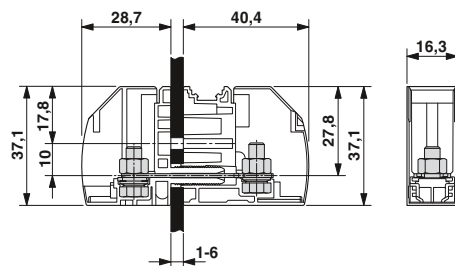

Drilling diagram

* Only when using the RW...-F flange plate

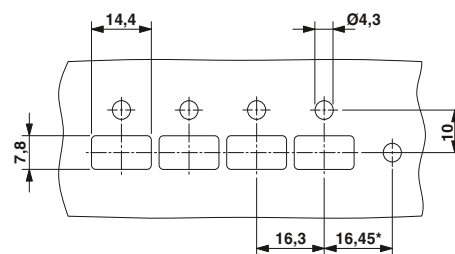

Technical data

Technical data in accordance to IEC / DIN VDE		
Current/conductor cross section	[A] / [mm ²]	76 / 16 // 76 / 16
Rated voltage	[V]	1000
Connection capacity, DIN 46234		
Cable lugs, DIN 46234	[mm ²]	0.5 - 16
Connection bolt / hole diameter / width	[mm]	5 / 5.3 / 11
Connection capacity DIN 46235		
Cable lugs DIN 46235	[mm ²]	6 - 10
Connection bolt / hole diameter / width	[mm]	5 / 5.3 / 9
Connection capacity, DIN 46237		
Cable lugs DIN 46237	[mm ²]	1 - 6
Connection bolt / hole diameter / width	[mm]	5 / 5.3 / 10
Color code		1.00 mm ² red blue yellow
Insulation coordination		
Surge voltage category / pollution degree		III / 3 III / 2 II / 2
Rated insulation voltage	[V]	1000 1000 1000
Rated surge voltage	[kV]	8 8 8
Approval data (UL/CUL)	Use Group	B C D
Nominal voltage	[V]	600 600 -
Nominal current	[A]	65 65 -
Connection capacity AWG		26 - 6 26 - 6 -
Approval data (CSA)	Use Group	B C D
Nominal voltage	[V]	- - -
Nominal current	[A]	- - -
Connection capacity AWG	AWG	- - -
General data		
Bolt thread/tightening torque	- / [Nm]	M5 / 2.5 - 3
Insulation material		PA
Inflammability class according to UL 94		V0
Panel thickness	[mm]	1 - 6

Ordering data

Type	Order No.	Pcs. / Pkt.
Feed-through terminal block		
RWO 5	3056116	10
Feed-through terminal block, with engagement pin		
RWO 5/S	3056129	10

ZB 16.../ZBF 16... marking material for marking the center groove (see Catalog 5)
TMT (EX9,5)R marking material (see online catalog)

Feed-through terminal blocks for high-current applications

(Molded) feed-through terminal blocks with horizontal, vertical bolt connection, RW series



Feed-through terminal blocks, vertical conductor connection



Molded feed-through terminal blocks, horizontal conductor connection, internal part with M5 bolt connection



Molded feed-through terminal blocks, vertical conductor connection, internal part with M5 bolt connection

Dimensional drawing

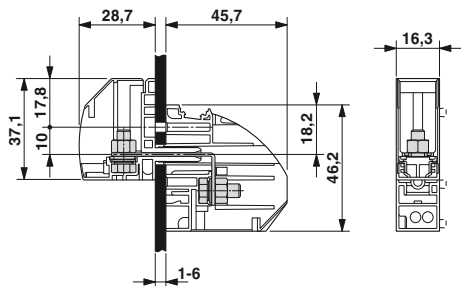

Drilling diagram

* Only when using the RW...-F flange plate

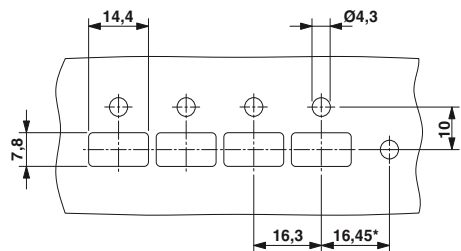

Ordering data

Type	Order No.	Pcs. / Pkt.
Feed-through terminal block		
RWOV 5	3056271	10
Feed-through terminal block, with engagement pin		
RWOV 5/S	3056284	10

ZB 16.../ZBF 16... marking material for marking the center groove (see Catalog 5)
TMT (EX9,5)R marking material (see online catalog)

Dimensional drawing

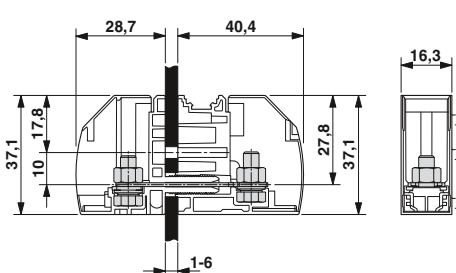

Drilling diagram

* Only when using the RW...-F flange plate

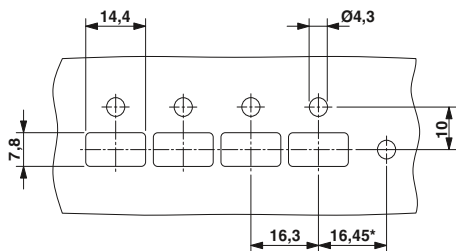

Ordering data

Type	Order No.	Pcs. / Pkt.
Feed-through terminal block, with sponge rubber seal		
RWO 5-POT	3056190	10
Feed-through terminal block, with engagement pin and sponge rubber seal		
RWO 5-POT/S	3056200	10

ZB 16.../ZBF 16... marking material for marking the center groove (see Catalog 5)
TMT (EX9,5)R marking material (see online catalog)

Dimensional drawing

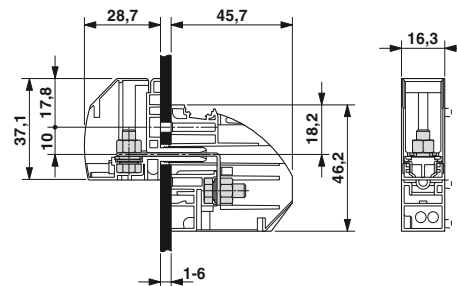

Drilling diagram

* Only when using the RW...-F flange plate

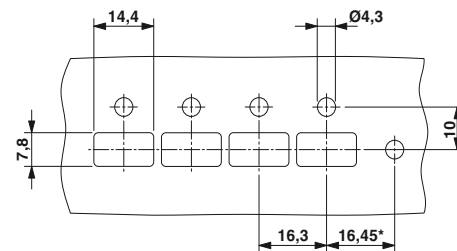

Ordering data

Type	Order No.	Pcs. / Pkt.
Feed-through terminal block, with sponge rubber seal		
RWOV 5-POT	3056310	10
Feed-through terminal block, with engagement pin and sponge rubber seal		
RWOV 5-POT/S	3056323	10

ZB 16.../ZBF 16... marking material for marking the center groove (see Catalog 5)
TMT (EX9,5)R marking material (see online catalog)

Feed-through terminal blocks for high-current applications

(Molded) feed-through terminal blocks with horizontal, vertical bolt connection, RW series

In open housing up to 125 A/35 mm²

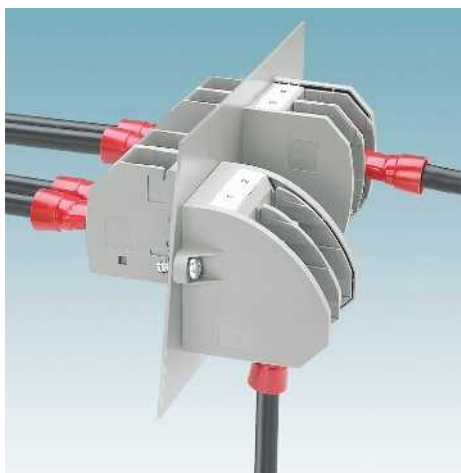

- Both terminal halves can be easily assembled by simply snapping them together
- Automatic panel thickness compensation
- Easy grouping with engagement pin versions
- Molded versions ensure maximum tightness of seal
- Spring-loaded spacers protect the bolt connection against loosening

Notes:

Internal = left side of portrait photos.
External = right side of portrait photos.

Corresponding screws for fixing the feed-through terminal blocks are supplied as standard.

For corresponding rivets for fixing the feed-through terminal blocks, see Catalog 5.



Feed-through terminal blocks, horizontal conductor connection

Accessories

For all types	Type
	Socket wrench SHN 13 Order No. 1209923
	Flange plate RW 8-F Order No. 3075171
	Flange plate RWV 8-F Order No. 3075333

Dimensional drawing

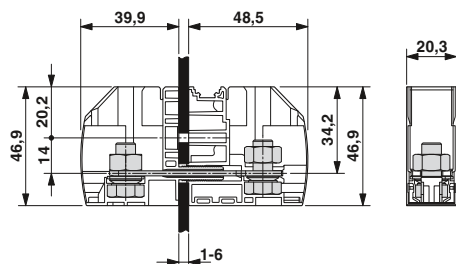

Drilling diagram

* Only when using the RW...-F flange plate

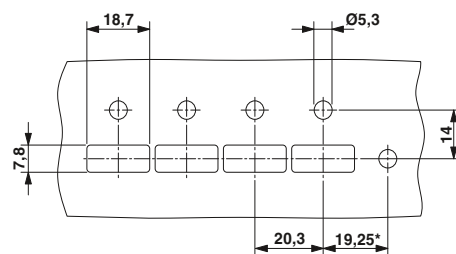

Technical data

Technical data in accordance to IEC / DIN VDE

Current/conductor cross section	[A] / [mm ²]	125 / 35 // 125 / 35
Rated voltage	[V]	1000
Connection capacity, DIN 46234		
Cable lugs, DIN 46234	[mm ²]	2.5 - 35
Connection bolt / hole diameter / width	[mm]	8 / 8.4 / 16
Connection capacity DIN 46235		
Cable lugs DIN 46235	[mm ²]	16 - 25
Connection bolt / hole diameter / width	[mm]	8 / 8.4 / 14
Connection capacity, DIN 46237		
Cable lugs DIN 46237	[mm ²]	2.5 - 6
Connection bolt / hole diameter / width	[mm]	8 / 8.4 / 14
Color code		-
	blue	2.50 mm ²
	yellow	6.00 mm ²

Insulation coordination

Surge voltage category / pollution degree

Rated insulation voltage	[V]	III / 3	III / 2	II / 2
Rated insulation voltage	[V]	1000	1000	1000
Rated surge voltage	[kV]	8	8	8
Approval data (UL/CUL)	Use Group	B	C	D
Nominal voltage	[V]	600	600	-
Nominal current	[A]	115	115	-
Connection capacity AWG		14 - 2	14 - 2	-
Approval data (CSA)	Use Group	B	C	D
Nominal voltage	[V]	-	-	-
Nominal current	[A]	-	-	-
Connection capacity AWG		-	-	-

General data

Bolt thread/tightening torque	- / [Nm]	M8 / 4.5 - 5
Insulation material		PA
Inflammability class according to UL 94		V0
Panel thickness	[mm]	1 - 6

Ordering data

Type	Order No.	Pcs. / Pkt.
Feed-through terminal block		
RWO 8	3056132	10
Feed-through terminal block, with engagement pin		
RWO 8/S	3056145	10

ZB 20,3 marking material for marking the center groove (see online catalog)

TMT (EX9,5)R marking material (see online catalog)

Feed-through terminal blocks for high-current applications

(Molded) feed-through terminal blocks with horizontal, vertical bolt connection, RW series



Feed-through terminal blocks, vertical conductor connection



Molded feed-through terminal blocks, horizontal conductor connection, internal part with M8 bolt connection



Molded feed-through terminal blocks, vertical conductor connection, internal part with M8 bolt connection

Dimensional drawing

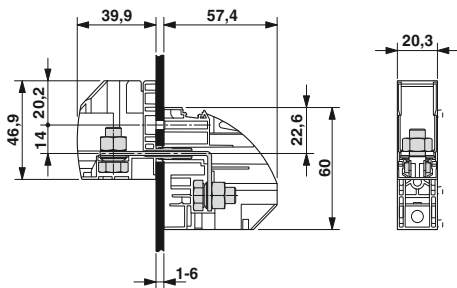

Drilling diagram

* Only when using the RW...-F flange plate

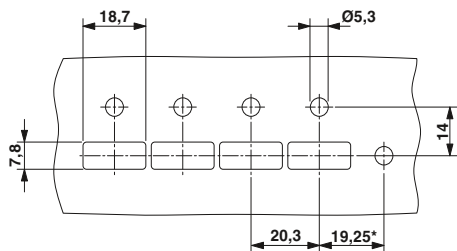

Ordering data

Type	Order No.	Pcs. / Pkt.
Feed-through terminal block		
RWOV 8	3056297	10
Feed-through terminal block, with engagement pin		
RWOV 8/S	3056307	10

ZB 20,3 marking material for marking the center groove (see online catalog)
TMT (EX9,5)R marking material (see online catalog)

Dimensional drawing

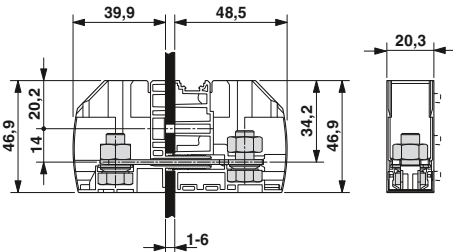

Drilling diagram

* Only when using the RW...-F flange plate

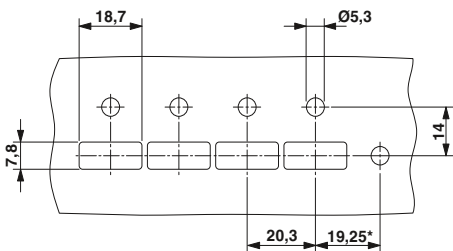

Ordering data

Type	Order No.	Pcs. / Pkt.
Feed-through terminal block, with sponge rubber seal		
RWO 8-POT	3056213	10
Feed-through terminal block, with engagement pin and sponge rubber seal		
RWO 8-POT/S	3056226	10

ZB 20,3 marking material for marking the center groove (see online catalog)
TMT (EX9,5)R marking material (see online catalog)

Dimensional drawing

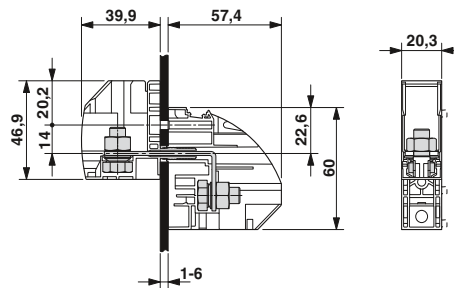

Drilling diagram

* Only when using the RW...-F flange plate

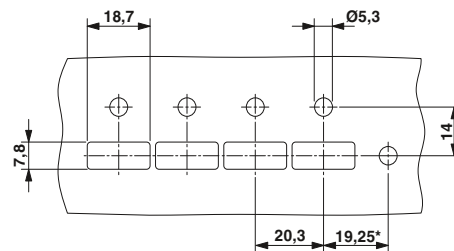

Ordering data

Type	Order No.	Pcs. / Pkt.
Feed-through terminal block, with sponge rubber seal		
RWOV 8-POT	3056336	10
Feed-through terminal block, with engagement pin and sponge rubber seal		
RWOV 8-POT/S	3056349	10

ZB 20,3 marking material for marking the center groove (see online catalog)
TMT (EX9,5)R marking material (see online catalog)

Feed-through terminal blocks for high-current applications

(Molded) feed-through terminal blocks with horizontal, vertical bolt connection, RW series

With transparent cover up to **76 A/16 mm²**

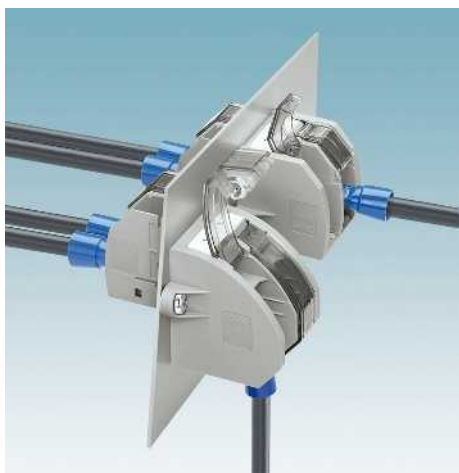

- Both terminal halves can be easily assembled by simply snapping them together
- Automatic panel thickness compensation
- Easy grouping with engagement pin versions
- Molded versions ensure maximum tightness of seal
- Touch-proof insulating housing with transparent cover
- Spring-loaded spacers protect the bolt connection against loosening

Notes:

Internal = left side of portrait photos.
External = right side of portrait photos.



Corresponding screws for fixing the feed-through terminal blocks are supplied as standard.

For corresponding rivets for fixing the feed-through terminal blocks, see Catalog 5.



Feed-through terminal blocks, horizontal conductor connection

Accessories

For all types	Type
	Socket wrench SHN 8 Order No. 1209868
	Flange plate RW 5-F Order No. 3075155
	Flange plate RWV 5-F Order No. 3075317

Dimensional drawing

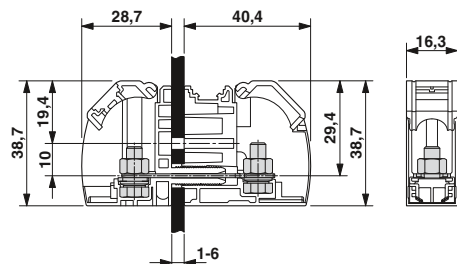

Drilling diagram

* Only when using the RW...-F flange plate

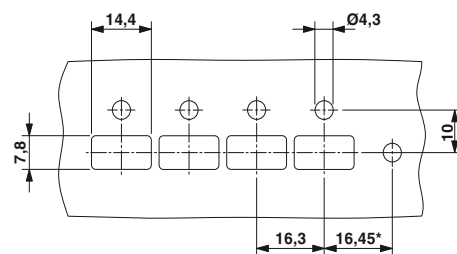

Technical data

Technical data in accordance to IEC / DIN VDE

Current/conductor cross section	[A] / [mm ²]	76 / 16 // 76 / 16
Rated voltage	[V]	1000
Connection capacity, DIN 46234		
Cable lugs, DIN 46234	[mm ²]	0.5 - 16
Connection bolt / hole diameter / width	[mm]	5 / 5.3 / 11
Connection capacity DIN 46235		
Cable lugs DIN 46235	[mm ²]	6 - 10
Connection bolt / hole diameter / width	[mm]	5 / 5.3 / 9
Connection capacity, DIN 46237		
Cable lugs DIN 46237	[mm ²]	1 - 6
Connection bolt / hole diameter / width	[mm]	5 / 5.3 / 10
Color code		red blue yellow

Insulation coordination

Surge voltage category / pollution degree		III / 3	III / 2	II / 2
Rated insulation voltage	[V]	1000	1000	1000
Rated surge voltage	[kV]	8	8	8
Approval data (UL/CUL)	Use Group	B	C	D
Nominal voltage	[V]	600	600	-
Nominal current	[A]	65	65	-
Connection capacity AWG		26 - 6	26 - 6	-
Approval data (CSA)	Use Group	B	C	D
Nominal voltage	[V]	-	-	-
Nominal current	[A]	-	-	-
Connection capacity AWG	AWG	-	-	-

General data

Bolt thread/tightening torque	- / [Nm]	M5 / 2.5 - 3
Insulation material		PA
Inflammability class according to UL 94		V0
Panel thickness	[mm]	1 - 6

Ordering data

Type	Order No.	Pcs. / Pkt.
------	-----------	-------------

Description	Feed-through terminal block	
	RWO 5-TC	3074910 10
	Feed-through terminal block, with engagement pin	
	RWO 5-TC/S	3074923 10

ZB 16 marking material for marking the center groove (see Catalog 5)
TMT (EX9,5)R marking material (see online catalog)

Feed-through terminal blocks for high-current applications

(Molded) feed-through terminal blocks with horizontal, vertical bolt connection, RW series



Feed-through terminal blocks, vertical conductor connection



Molded feed-through terminal blocks, horizontal conductor connection, internal part with M5 bolt connection



Molded feed-through terminal blocks, vertical conductor connection, internal part with M5 bolt connection



Dimensional drawing

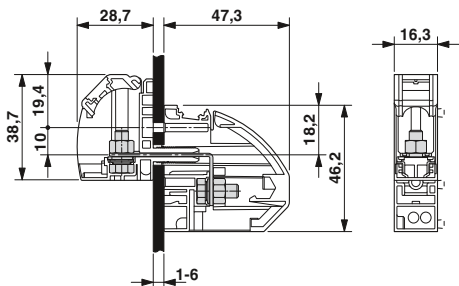

Drilling diagram

* Only when using the RW...-F flange plate

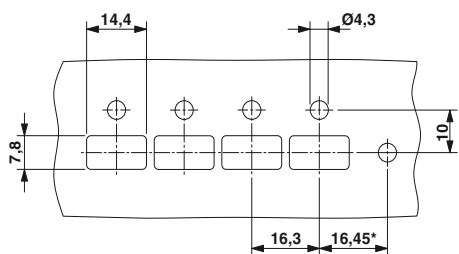

Ordering data

Type	Order No.	Pcs. / Pkt.
Feed-through terminal block		
RWOV 5-TC	3075074	10
Feed-through terminal block, with engagement pin		
RWOV 5-TC/S	3075087	10

ZB 16 marking material for marking the center groove (see Catalog 5)
TMT (EX9,5)R marking material (see online catalog)



Dimensional drawing

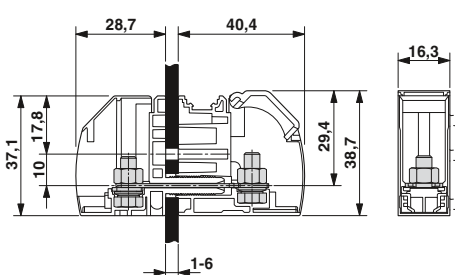

Drilling diagram

* Only when using the RW...-F flange plate

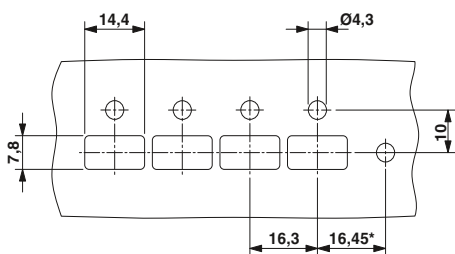

Ordering data

Type	Order No.	Pcs. / Pkt.
Feed-through terminal block, with sponge rubber seal		
RWO 5-POT-TC	3074994	10
Feed-through terminal block, with engagement pin and sponge rubber seal		
RWO 5-POT-TC/S	3075003	10

ZB 16 marking material for marking the center groove (see Catalog 5)
TMT (EX9,5)R marking material (see online catalog)



Dimensional drawing

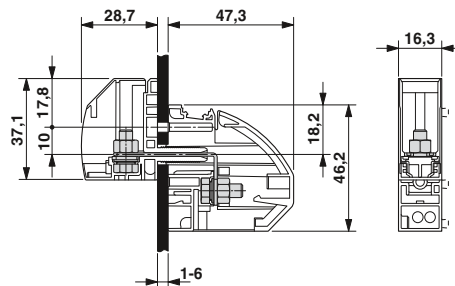

Drilling diagram

* Only when using the RW...-F flange plate

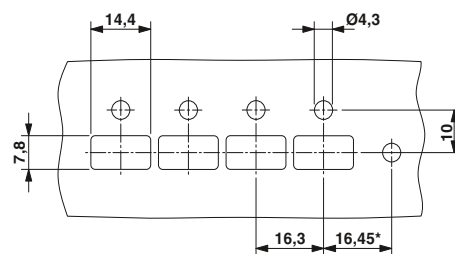

Ordering data

Type	Order No.	Pcs. / Pkt.
Feed-through terminal block, with sponge rubber seal		
RWOV 5-POT-TC	3075113	10
Feed-through terminal block, with engagement pin and sponge rubber seal		
RWOV 5-POT-TC/S	3075126	10

ZB 16 marking material for marking the center groove (see Catalog 5)
TMT (EX9,5)R marking material (see online catalog)

Feed-through terminal blocks for high-current applications

(Molded) feed-through terminal blocks with horizontal, vertical bolt connection, RW series

With transparent cover up to 125 A/35 mm²

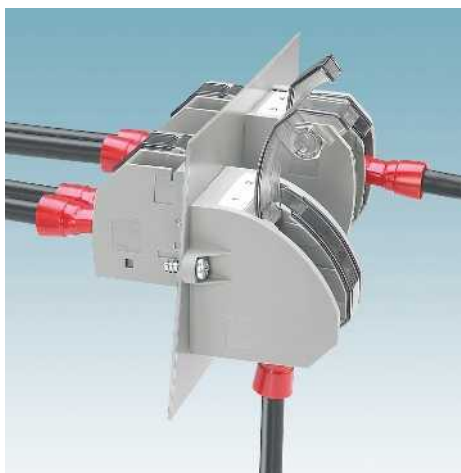

- Both terminal halves can be easily assembled by simply snapping them together
- Automatic panel thickness compensation
- Easy grouping with engagement pin versions
- Molded versions ensure maximum tightness of seal
- Touch-proof insulating housing with transparent cover
- Spring-loaded spacers protect the bolt connection against loosening

Notes:

Internal = left side of portrait photos.
External = right side of portrait photos.

Corresponding screws for fixing the feed-through terminal blocks are supplied as standard.

For corresponding rivets for fixing the feed-through terminal blocks, see Catalog 5.



Feed-through terminal blocks, horizontal conductor connection

Accessories

For all types	Type
	Socket wrench SHN 13 Order No. 1209923
	Flange plate RW 8-F Order No. 3075171
	Flange plate RWV 8-F Order No. 3075333

Dimensional drawing

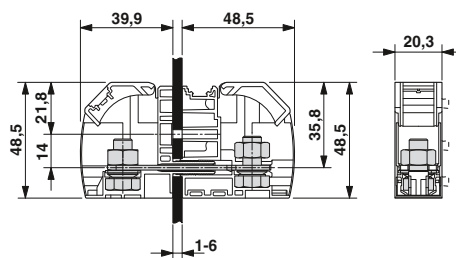

Drilling diagram

* Only when using the RW...-F flange plate

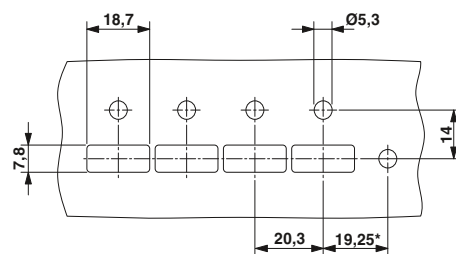

Technical data

Technical data in accordance to IEC / DIN VDE

Current/conductor cross section	[A] / [mm ²]	125 / 35 // 125 / 35
Rated voltage	[V]	1000
Connection capacity, DIN 46234		
Cable lugs, DIN 46234	[mm ²]	2.5 - 35
Connection bolt / hole diameter / width	[mm]	8 / 8.4 / 16
Connection capacity DIN 46235		
Cable lugs DIN 46235	[mm ²]	16 - 25
Connection bolt / hole diameter / width	[mm]	8 / 8.4 / 14
Connection capacity, DIN 46237		
Cable lugs DIN 46237	[mm ²]	2.5 - 6
Connection bolt / hole diameter / width	[mm]	8 / 8.4 / 14
Color code		-
	blue	2.50 mm ²
	yellow	6.00 mm ²

Insulation coordination

Surge voltage category / pollution degree

Rated insulation voltage	[V]	III / 3	III / 2	II / 2
Rated insulation voltage	[V]	1000	1000	1000
Rated surge voltage	[kV]	8	8	8
Approval data (UL/CUL)	Use Group	B	C	D
Nominal voltage	[V]	600	600	-
Nominal current	[A]	115	115	-
Connection capacity AWG		14 - 2	14 - 2	-
Approval data (CSA)	Use Group	B	C	D
Nominal voltage	[V]	-	-	-
Nominal current	[A]	-	-	-
Connection capacity AWG		-	-	-

General data

Bolt thread/tightening torque	- / [Nm]	M8 / 4.5 - 5
Insulation material		PA
Inflammability class according to UL 94		V0
Panel thickness	[mm]	1 - 6

Ordering data

Type	Order No.	Pcs. / Pkt.
------	-----------	-------------

Description	Feed-through terminal block	
RWO 8-TC	3074936	10
Description	Feed-through terminal block, with engagement pin	
RWO 8-TC/S	3074949	10

ZB 20,3 marking material for marking the center groove (see online catalog)
TMT (EX9,5)R marking material (see online catalog)

Feed-through terminal blocks for high-current applications

(Molded) feed-through terminal blocks with horizontal, vertical bolt connection, RW series



Feed-through terminal blocks, vertical conductor connection



Molded feed-through terminal blocks, horizontal conductor connection, internal part with M8 bolt connection



Molded feed-through terminal blocks, vertical conductor connection, internal part with M8 bolt connection



Dimensional drawing

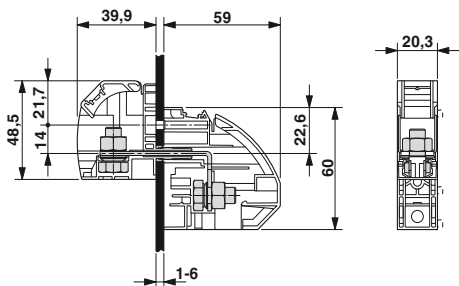

Drilling diagram

* Only when using the RW...-F flange plate

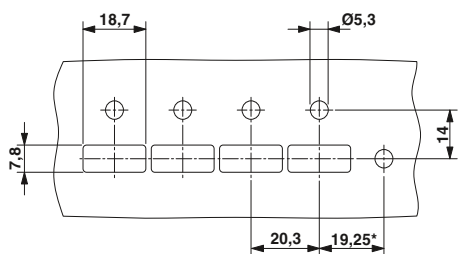

Ordering data

Type	Order No.	Pcs. / Pkt.
Feed-through terminal block		

RWOV 8-TC	3075090	10
Feed-through terminal block, with engagement pin		

RWOV 8-TC/S	3075100	10
-------------	---------	----

ZB 20,3 marking material for marking the center groove (see online catalog)
TMT (EX9,5)R marking material (see online catalog)



Dimensional drawing

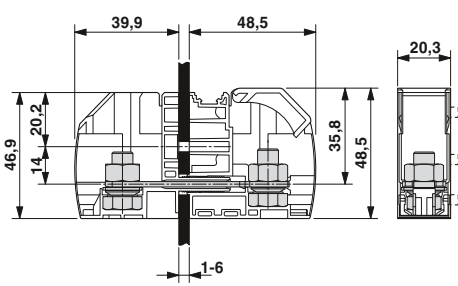

Drilling diagram

* Only when using the RW...-F flange plate

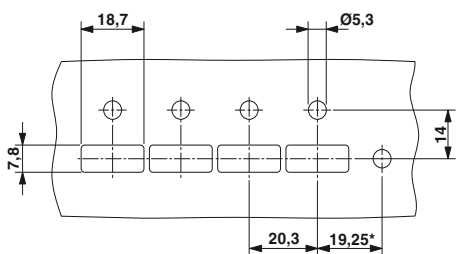

Ordering data

Type	Order No.	Pcs. / Pkt.
Feed-through terminal block, with sponge rubber seal		

RWO 8-POT-TC	3075016	10
Feed-through terminal block, with engagement pin and sponge rubber seal		
RWO 8-POT-TC/S	3075029	10

ZB 20,3 marking material for marking the center groove (see online catalog)
TMT (EX9,5)R marking material (see online catalog)



Dimensional drawing

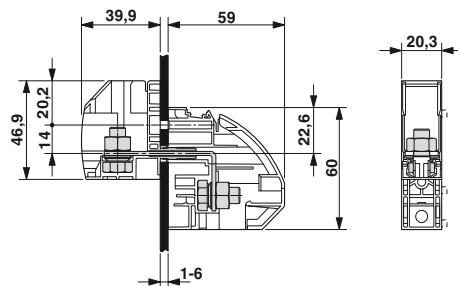

Drilling diagram

* Only when using the RW...-F flange plate

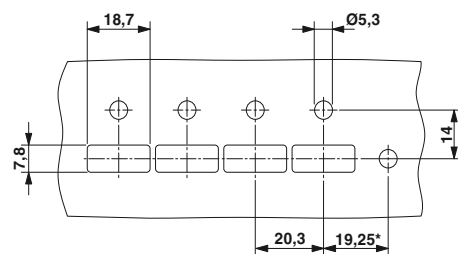

Ordering data

Type	Order No.	Pcs. / Pkt.
Feed-through terminal block, with sponge rubber seal		

RWOV 8-POT-TC	3075139	10
Feed-through terminal block, with engagement pin and sponge rubber seal		
RWOV 8-POT-TC/S	3075142	10

ZB 20,3 marking material for marking the center groove (see online catalog)
TMT (EX9,5)R marking material (see online catalog)

Feed-through terminal blocks for high-current applications

(Molded) feed-through terminal blocks with horizontal, vertical bolt connection, RW series

In open housing up to 309 A/150 mm²

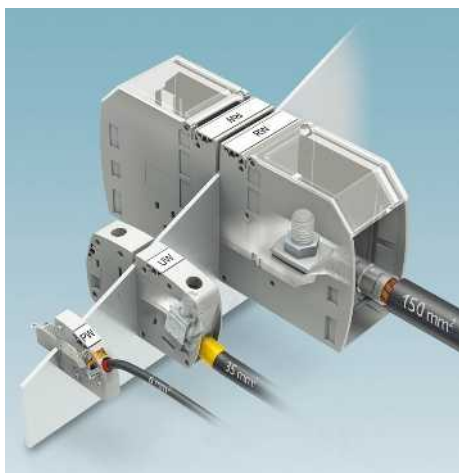

- Both terminal halves can be easily assembled by simply snapping them together
- Automatic panel thickness compensation
- Easy grouping with engagement pin versions
- Touch-proof insulating housing with transparent cover
- Spring-loaded spacers protect the bolt connection against loosening

Notes:
 Internal = left side of portrait photos.
 External = right side of portrait photos.
 Corresponding screws for fixing the feed-through terminal blocks are supplied as standard.
 For corresponding rivets for fixing the feed-through terminal blocks, see Catalog 5.

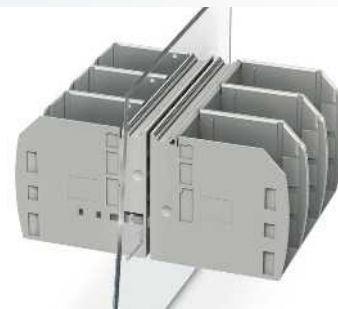

With open housing

Accessories

For all types	Type
	Flange plate RW 10-F Order No. 3075197

Dimensional drawing

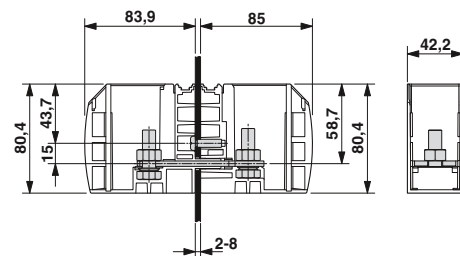

Drilling diagram

* Only when using the RW...-F flange plate

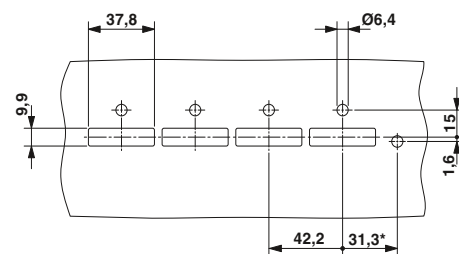

Technical data

Technical data in accordance to IEC / DIN VDE				
Current/conductor cross section	[A] / [mm ²]	309 / 150 // 309 / 150		
Rated voltage	[V]	1000		
Connection capacity, DIN 46234				
Cable lugs, DIN 46234	[mm ²]	6 - 150		
Connection bolt / hole diameter / width	[mm]	10 / 10.5 / 30		
Connection capacity DIN 46235				
Cable lugs DIN 46235	[mm ²]	10 - 95		
Connection bolt / hole diameter / width	[mm]	10 / 10.5 / 28		
Connection capacity, DIN 46237				
Cable lugs DIN 46237	[mm ²]	- 6		
Connection bolt / hole diameter / width	[mm]	10 / 10.5 / 18		
Insulation coordination				
Surge voltage category / pollution degree		III / 3	III / 2	II / 2
Rated insulation voltage	[V]	1000	1000	1000
Rated surge voltage	[kV]	8	8	8
Approval data (UL/CUL)	Use Group	B	C	D
Nominal voltage	[V]	-	-	-
Nominal current	[A]	-	-	-
Connection capacity AWG	AWG	-	-	-
Approval data (CSA)	Use Group	B	C	D
Nominal voltage	[V]	-	-	-
Nominal current	[A]	-	-	-
Connection capacity AWG	AWG	-	-	-
General data				
Bolt thread/tightening torque	- / [Nm]	M10 / 10 - 20		
Insulation material		PA		
Inflammability class according to UL 94		V0		
Panel thickness	[mm]	2 - 8		

Ordering data

Type	Order No.	Pcs. / Pkt.
Feed-through terminal block		
RWO 10	3056158	5
Feed-through terminal block, with engagement pin		
RWO 10/S	3056161	5

ZB 21,1 marking material for marking the center groove (see online catalog)
 TMT (EX9,5)R marking material (see online catalog)



With transparent cover



Dimensional drawing

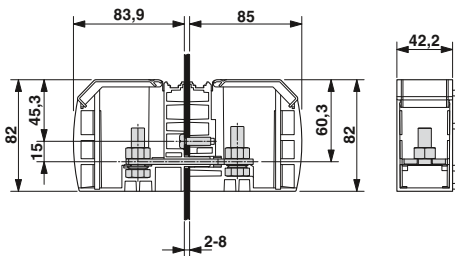

Drilling diagram

* Only when using the RW...-F flange plate

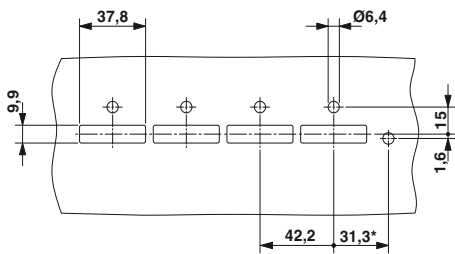

Ordering data

Type	Order No.	Pcs. / Pkt.
Feed-through terminal block		
RWO 10-TC	3074952	5
Feed-through terminal block, with engagement pin		
RWO 10-TC/S	3074965	5

ZB 21,1 marking material for marking the center groove (see online catalog)
 TMT (EX9,5)R marking material (see online catalog)

Feed-through terminal blocks for high-current applications

Special designs, feed-through terminal blocks with screw connection

DFK 4 with screw connection



- Universal screw connection with screw locking
- The feed-through terminal blocks snap into the panel cutout automatically
- Touch-proof insulating housing
- PE terminal block with ground function based on IEC 60947-7-2
- The fuse terminal blocks are available for 5 x 20 mm and 6.3 x 32 mm cartridge fuse inserts

Notes:

Internal = left side of portrait photos.
External = right side of portrait photos.

Current and voltage data for slip-on connections in acc. with EN 61210 are also dependent on nominal size, material, insulation of the slip-on sleeve and conductor cross section.

Accessories

For all types	Type	
	Screwdriver SZS 0,6 x 3,5 Order No. 1205053	
	Blind cover, width 6 mm B/DFK Order No. 0706045	
	Separating plate TS-DFK Order No. 0706210	
Only for DFK 4		
	Insertion bridge EB 2-6 Order No. 0201155	
	Insertion bridge EB 3-6 Order No. 0201142	
	Insertion bridge EB 10-6 Order No. 0201139	

Technical data

Technical data in accordance to IEC / DIN VDE

Current/conductor cross section	[A] / [mm ²]
Rated voltage	[V]
Connection capacity	[mm ²] / [mm ²] / AWG
Stranded with ferrules without plastic sleeve	[mm ²]
Stranded with ferrules with plastic sleeve	[mm ²]
Multi-conductor connection capacity (two conductors with the same cross section)	[mm ²]
Solid / stranded	[mm ²]
Stranded with ferrules without plastic sleeve	[mm ²]
Stranded with TWIN ferrule with plastic sleeve	[mm ²]
Cross section with insertion bridge (solid/stranded)	[mm ²]
Insulation coordination	
Surge voltage category / pollution degree	
Rated insulation voltage	[V]
Rated surge voltage	[kV]
Approval data (UL/CUL)	Use Group
Nominal voltage	[V]
Nominal current	[A]
Connection capacity AWG	AWG
Approval data (CSA)	Use Group
Nominal voltage	[V]
Nominal current	[A]
Connection capacity AWG	AWG
General data	
Stripping length	[mm]
Terminal sleeve: Thread / Torque	- / [Nm]
Insulation material	
Inflammability class according to UL 94	

DFK 4

Current/conductor cross section	17.5 / 6 // 17.5 / 1.5
Rated voltage	400
Connection capacity	0.2 - 6 / 0.2 - 4 / 24 - 10
Stranded with ferrules without plastic sleeve	0.25 - 4
Stranded with ferrules with plastic sleeve	0.25 - 2.5
Multi-conductor connection capacity (two conductors with the same cross section)	0.2 - 1.5 / 0.2 - 1.5
Solid / stranded	0.25 - 1.5
Stranded with ferrules without plastic sleeve	0.5 - 2.5
Stranded with TWIN ferrule with plastic sleeve	- 4 / - 4
Insulation coordination	III / 3 III / 2 II / 2
Rated insulation voltage	400 1000 1000
Rated surge voltage	6 6 6
Approval data (UL/CUL)	B C D
Nominal voltage	250 - 300
Nominal current	15 - 15
Connection capacity AWG	30 - 10 - 30 - 10
Approval data (CSA)	B C D
Nominal voltage	- - -
Nominal current	- - -
Connection capacity AWG	- - -
General data	
Stripping length	8
Terminal sleeve: Thread / Torque	M3 / 0.6 - 0.8
Insulation material	PA
Inflammability class according to UL 94	V2

DFK 4-PE

Current/conductor cross section	17.5 / 6 // 17.5 / 4
Rated voltage	400
Connection capacity	0.2 - 6 / 0.2 - 4 / 24 - 10
Stranded with ferrules without plastic sleeve	0.25 - 4
Stranded with ferrules with plastic sleeve	0.25 - 2.5
Multi-conductor connection capacity (two conductors with the same cross section)	0.2 - 1.5 / 0.2 - 1.5
Solid / stranded	0.25 - 1.5
Stranded with ferrules without plastic sleeve	0.5 - 2.5
Stranded with TWIN ferrule with plastic sleeve	- / -
Insulation coordination	III / 3 III / 2 II / 2
Rated insulation voltage	400 1000 1000
Rated surge voltage	6 6 6
Approval data (UL/CUL)	B C D
Nominal voltage	250 - 300
Nominal current	15 - 15
Connection capacity AWG	30 - 10 - 30 - 10
Approval data (CSA)	B C D
Nominal voltage	- - -
Nominal current	- - -
Connection capacity AWG	- - -
General data	
Stripping length	8
Terminal sleeve: Thread / Torque	M3 / 0.6 - 0.8
Insulation material	PA
Inflammability class according to UL 94	V2

DFK 4-SI(5X20) BK

Current/conductor cross section	6.3 / 6 // 6.3 / 1.5
Rated voltage	400
Connection capacity	0.2 - 6 / 0.2 - 4 / 24 - 10
Stranded with ferrules without plastic sleeve	0.25 - 4
Stranded with ferrules with plastic sleeve	0.25 - 2.5
Multi-conductor connection capacity (two conductors with the same cross section)	0.2 - 1.5 / 0.2 - 1.5
Solid / stranded	0.25 - 1.5
Stranded with ferrules without plastic sleeve	0.5 - 2.5
Stranded with TWIN ferrule with plastic sleeve	- / -
Insulation coordination	III / 3 III / 2 II / 2
Rated insulation voltage	400 1000 1000
Rated surge voltage	6 6 6
Approval data (UL/CUL)	B C D
Nominal voltage	250 - 300
Nominal current	8 - 8
Connection capacity AWG	30 - 10 - 30 - 10
Approval data (CSA)	B C D
Nominal voltage	250 - 300
Nominal current	8 - 8
Connection capacity AWG	28 - 10 - 28 - 10
General data	
Stripping length	8
Terminal sleeve: Thread / Torque	M3 / 0.6 - 0.8
Insulation material	PA
Inflammability class according to UL 94	V2

Description

Feed-through terminal blocks for high-current applications

Special designs, feed-through terminal blocks with screw connection



Feed-through terminal blocks, solder/2.8 mm spade connection inside



Ground feed-through terminal blocks



Fuse feed-through terminal blocks for cartridge fuse insert, solder/2.8 mm spade connection inside



Dimensional drawing

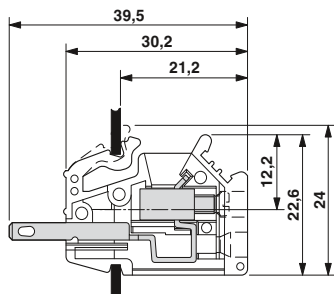

Drilling diagram

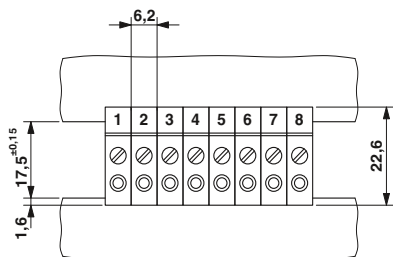

Ordering data

Type	Order No.	Pcs. / Pkt.
Feed-through terminal block, for 1.5 mm thick sheet metal		

DFK 4	0708357	50
Feed-through terminal block, for 2.5 mm thick sheet metal		

DFK/DP-4	0708616	50
----------	---------	----

ZB 6... marking material for marking the lateral groove (see Catalog 5)
 UC-TM 6 marking material for marking the lateral groove (see Catalog 5)



Dimensional drawing

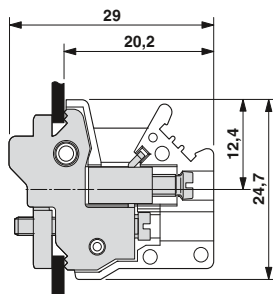

Drilling diagram

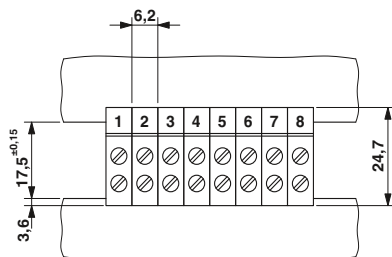

Ordering data

Type	Order No.	Pcs. / Pkt.
PE ground terminal block, for 1.5 mm thick sheet metal		

DFK 4-PE	0708315	50
----------	---------	----

ZB 6... marking material for marking the lateral groove (see Catalog 5)
 UC-TM 6 marking material for marking the lateral groove (see Catalog 5)



Dimensional drawing

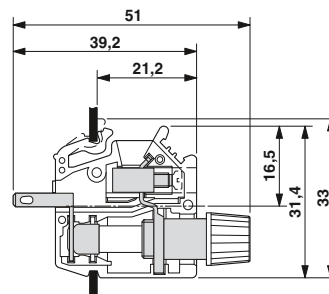

Drilling diagram

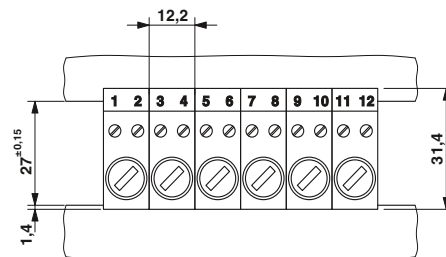

Ordering data

Type	Order No.	Pcs. / Pkt.
Feed-through fuse terminal block, for 5 x 20 cartridge fuse inserts		

DFK 4-SI(5X20) BK	0709301	50
Feed-through fuse terminal block, for 6.3 x 32 cartridge fuse inserts		
DFK 4-SI(6,3X32) BK	0708344	50

ZB 6... marking material for marking the lateral groove (see Catalog 5)
 UC-TM 6 marking material for marking the lateral groove (see Catalog 5)

Feed-through terminal blocks for high-current applications

Special designs, feed-through terminal blocks with screw connection

DFK 5-9,5 with screw connection

Notes:

Internal = left side of portrait photos.
External = right side of portrait photos.



- Universal screw connection with screw locking
- Easy fixing using plastic knurled nut
- Touch-proof insulating housing

Accessories

For all types	Type	
	Screwdriver SZS 0,6 x 3,5 Order No. 1205053	

Technical data

Technical data in accordance to IEC / DIN VDE				
Current/conductor cross section	[A] / [mm ²]	17.5 / 6 // 17.5 / 1.5		
Rated voltage	[V]	690		
Connection capacity				
Solid / stranded	[mm ²] / [mm ²] / AWG	0.2 - 6 / 0.2 - 4 / 24 - 10		
Stranded with ferrules without plastic sleeve	[mm ²]	0.25 - 4		
Stranded with ferrules with plastic sleeve	[mm ²]	0.25 - 4		
Multi-conductor connection capacity (two conductors with the same cross section)				
Solid / stranded	[mm ²]	0.2 - 1.5 / 0.2 - 2.5		
Stranded with ferrules without plastic sleeve	[mm ²]	0.25 - 1.5		
Stranded with TWIN ferrule with plastic sleeve	[mm ²]	0.5 - 2.5		
Cross section with insertion bridge (solid/stranded)	[mm ²]	- / -		
Insulation coordination				
Surge voltage category / pollution degree		III / 3	III / 2	II / 2
Rated insulation voltage	[V]	690	1000	1000
Rated surge voltage	[kV]	6	6	6
Approval data (UL/CUL)	Use Group	B	C	D
Nominal voltage	[V]	300	300	600
Nominal current	[A]	30	30	5
Connection capacity AWG	AWG	30 - 10	30 - 10	30 - 10
Approval data (CSA)	Use Group	B	C	D
Nominal voltage	[V]	300	300	600
Nominal current	[A]	30	30	5
Connection capacity AWG	AWG	22 - 10	22 - 10	22 - 10
General data				
Stripping length	[mm]	14		
Terminal sleeve: Thread / Torque	- / [Nm]	M3 / 0.6 - 0.8		
Insulation material		PA		
Inflammability class according to UL 94		V2		
Panel thickness	[mm]	0.5 - 3.5		

Description



Feed-through terminal blocks,
solder/2.8 mm spade connection inside



Dimensional drawing

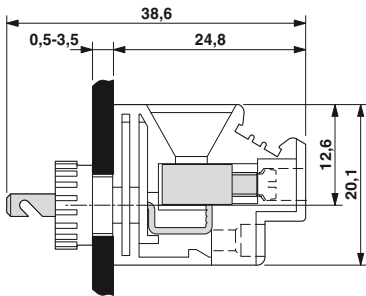

Drilling diagram

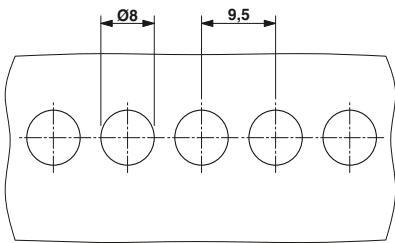

Ordering data

Type	Order No.	Pcs. / Pkt.
Feed-through terminal block, for sheet metal 0.5 - 3.5 mm thick		
DFK 5-9,5	0706605	50

ZB 6... marking material for marking the lateral groove (see Catalog 5)
UC-TM 6 marking material for marking the lateral groove (see Catalog 5)

Feed-through terminal blocks for high-current applications

Special designs, feed-through terminal blocks with screw connection

VDFK with screw connection for molding

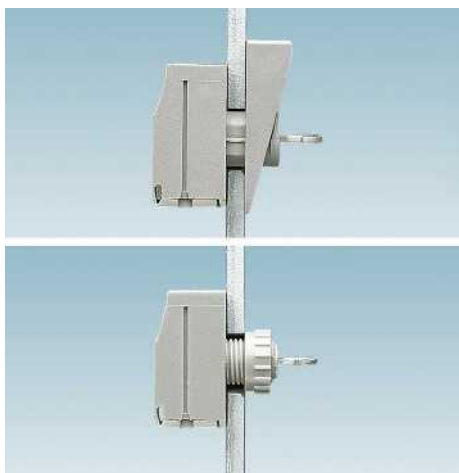



- Universal screw connection with screw locking
- Terminal blocks can be grouped
- Easy fixing using plastic knurled nut or quick mounting wedge
- Touch-proof insulating housing
- Spacer plates increase air and creepage distances

Notes:

Internal = left side of portrait photos.
External = right side of portrait photos.

Accessories

For all types	Type	
	Screwdriver SZS 0,6 x 3,5 Order No. 1205053	
	Spacer plate, 4 mm thick DP-VDFK 4/4 Order No. 0717144	

Technical data

Technical data in accordance to IEC / DIN VDE

Current/conductor cross section	[A] / [mm ²]
Rated voltage	[V]
Connection capacity	
Solid / stranded	[mm ²] / [mm ²] / AWG
Stranded with ferrules without plastic sleeve	[mm ²]
Stranded with ferrules with plastic sleeve	[mm ²]
Multi-conductor connection capacity (two conductors with the same cross section)	
Solid / stranded	[mm ²]
Stranded with ferrules without plastic sleeve	[mm ²]
Stranded with TWIN ferrule with plastic sleeve	[mm ²]
Cross section with insertion bridge (solid/stranded)	[mm ²]
Insulation coordination	
Surge voltage category / pollution degree	
Rated insulation voltage	[V]
Rated surge voltage	[kV]
Approval data (UL/CUL)	Use Group
Nominal voltage	[V]
Nominal current	[A]
Connection capacity AWG	AWG
Approval data (CSA)	Use Group
Nominal voltage	[V]
Nominal current	[A]
Connection capacity AWG	AWG
General data	
Stripping length	[mm]
Terminal sleeve: Thread / Torque	- / [Nm]
Insulation material	
Inflammability class according to UL 94	

VDFK 4

Current/conductor cross section	32 / 6 // 32 / 4		
Rated voltage	500		
Connection capacity			
Solid / stranded	0.2 - 6 / 0.2 - 4 / 24 - 10		
Stranded with ferrules without plastic sleeve	0.25 - 4		
Stranded with ferrules with plastic sleeve	0.25 - 4		
Multi-conductor connection capacity (two conductors with the same cross section)			
Solid / stranded	0.2 - 1.5 / 0.2 - 1.5		
Stranded with ferrules without plastic sleeve	0.25 - 1.5		
Stranded with TWIN ferrule with plastic sleeve	0.5 - 1.5		
Cross section with insertion bridge (solid/stranded)	- / -		
Insulation coordination			
Surge voltage category / pollution degree	III / 3	III / 2	II / 2
Rated insulation voltage	500	1000	1000
Rated surge voltage	6	6	6
Approval data (UL/CUL)	B	C	D
Nominal voltage	300	150	300
Nominal current	30	30	10
Connection capacity AWG	30 - 10	30 - 10	30 - 10
Approval data (CSA)	B	C	D
Nominal voltage	300	-	300
Nominal current	30	-	10
Connection capacity AWG	28 - 10	-	28 - 10
General data			
Stripping length	8		
Terminal sleeve: Thread / Torque	M3 / 0.6 - 0.8		
Insulation material	PA		
Inflammability class according to UL 94	V0		

VDFK 4/K

Current/conductor cross section	32 / 6 // 32 / 4		
Rated voltage	500		
Connection capacity			
Solid / stranded	0.2 - 6 / 0.2 - 4 / 24 - 10		
Stranded with ferrules without plastic sleeve	0.25 - 4		
Stranded with ferrules with plastic sleeve	0.25 - 4		
Multi-conductor connection capacity (two conductors with the same cross section)			
Solid / stranded	0.2 - 1.5 / 0.2 - 1.5		
Stranded with ferrules without plastic sleeve	0.25 - 1.5		
Stranded with TWIN ferrule with plastic sleeve	0.5 - 1.5		
Cross section with insertion bridge (solid/stranded)	- / -		
Insulation coordination			
Surge voltage category / pollution degree	III / 3	III / 2	II / 2
Rated insulation voltage	500	1000	1000
Rated surge voltage	6	6	6
Approval data (UL/CUL)	B	C	D
Nominal voltage	300	150	300
Nominal current	30	30	10
Connection capacity AWG	30 - 10	30 - 10	30 - 10
Approval data (CSA)	B	C	D
Nominal voltage	300	-	300
Nominal current	30	-	10
Connection capacity AWG	28 - 10	-	28 - 10
General data			
Stripping length	8		
Terminal sleeve: Thread / Torque	M3 / 0.6 - 0.8		
Insulation material	PA		
Inflammability class according to UL 94	V0		

Description



Molded feed-through terminal blocks, with solder connection and knurled nut inside

Molded feed-through terminal blocks, with solder connection and securing wedge inside



Dimensional drawing

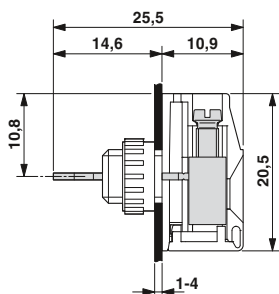

Drilling diagram

* Dimensions when using the DP-VDFK 4/4 spacer plate

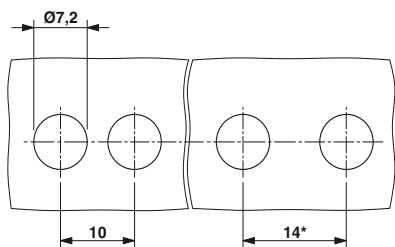

Ordering data

Type	Order No.	Pcs. / Pkt.
Molded feed-through terminal block, for housing panels 1 ... 4 mm thick		
VDFK 4	0708250	50
Molded feed-through terminal block, for 4...8 mm		
VDFK 4-DP	0708360	50

BN-ZB 10 marking material (see online catalog)



Dimensional drawing

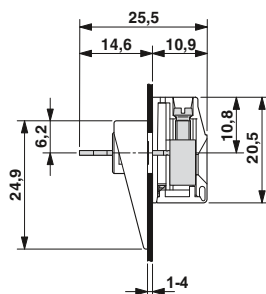

Drilling diagram

* Dimensions when using the DP-VDFK 4/4 spacer plate

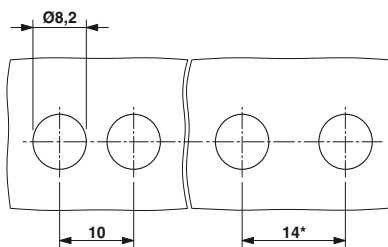

Ordering data

Type	Order No.	Pcs. / Pkt.
Molded feed-through terminal block, for housing panels 1 ... 4 mm thick		
VDFK 4/K	0709233	50
Molded feed-through terminal block, for housing panels 4...7 mm thick		
VDFK 4/K-DP	0709220	50

BN-ZB 10 marking material (see online catalog)

Feed-through terminal blocks for high-current applications

Special designs, feed-through terminal blocks with screw connection

VDFK with screw connection for molding

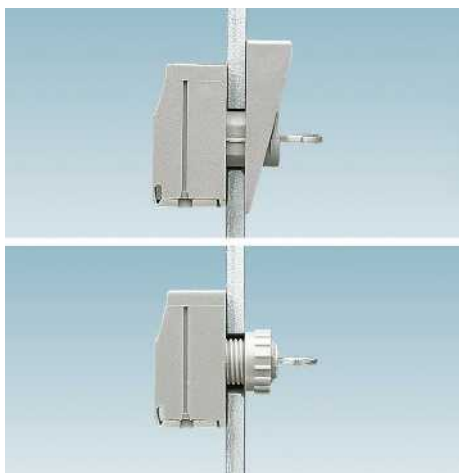

- Universal screw connection with screw locking
- Terminal blocks can be grouped
- Easy fixing using plastic knurled nut or quick mounting wedge
- Touch-proof insulating housing
- Strain relief can be snapped on as an option
- Spacer plates increase air and creepage distances

Notes:

Internal = left side of portrait photos.
External = right side of portrait photos.

Accessories

For all types	Type	
	Screwdriver SZS 1,0 x 4,0 Order No. 1205066	
	Spacer plate, 4 mm thick DP-VDFK 6/4 Order No. 0717157	
	Strain relief VDFK 6 ZEL Order No. 0711072	

Technical data

Technical data in accordance to IEC / DIN VDE

Current/conductor cross section	[A] / [mm ²]
Rated voltage	[V]
Connection capacity	
Solid / stranded	[mm ²] / [mm ²] / AWG
Stranded with ferrules without plastic sleeve	[mm ²]
Stranded with ferrules with plastic sleeve	[mm ²]
Multi-conductor connection capacity (two conductors with the same cross section)	
Solid / stranded	[mm ²]
Stranded with ferrules without plastic sleeve	[mm ²]
Stranded with TWIN ferrule with plastic sleeve	[mm ²]
Cross section with insertion bridge (solid/stranded)	[mm ²]
Insulation coordination	
Surge voltage category / pollution degree	
Rated insulation voltage	[V]
Rated surge voltage	[kV]
Approval data (UL/CUL)	Use Group
Nominal voltage	[V]
Nominal current	[A]
Connection capacity AWG	AWG
Approval data (CSA)	Use Group
Nominal voltage	[V]
Nominal current	[A]
Connection capacity AWG	AWG
General data	
Stripping length	[mm]
Terminal sleeve: Thread / Torque	- / [Nm]
Insulation material	
Inflammability class according to UL 94	

VDFK 6

Current/conductor cross section	57 / 10 // 41 / 6		
Rated voltage	500		
Connection capacity			
Solid / stranded	0.2 - 10 / 0.2 - 6 / 24 - 8		
Stranded with ferrules without plastic sleeve	0.25 - 6		
Stranded with ferrules with plastic sleeve	0.25 - 6		
Multi-conductor connection capacity (two conductors with the same cross section)			
Solid / stranded	0.2 - 4 / 0.2 - 4		
Stranded with ferrules without plastic sleeve	0.25 - 2.5		
Stranded with TWIN ferrule with plastic sleeve	0.5 - 4		
Cross section with insertion bridge (solid/stranded)	- / -		
Insulation coordination			
Surge voltage category / pollution degree	III / 3	III / 2	II / 2
Rated insulation voltage	500	1000	1000
Rated surge voltage	6	6	6
Approval data (UL/CUL)	B	C	D
Nominal voltage	300	150	300
Nominal current	50	50	10
Connection capacity AWG	26 - 8	26 - 8	26 - 8
Approval data (CSA)	B	C	D
Nominal voltage	300	150	300
Nominal current	50	50	10
Connection capacity AWG	26 - 8	26 - 8	26 - 8
General data			
Stripping length	9		
Terminal sleeve: Thread / Torque	M4 / 1.5 - 1.8		
Insulation material	PA		
Inflammability class according to UL 94	V0		

VDFK 6/K

Current/conductor cross section	57 / 10 // 41 / 6		
Rated voltage	500		
Connection capacity			
Solid / stranded	0.2 - 10 / 0.2 - 6 / 24 - 8		
Stranded with ferrules without plastic sleeve	0.25 - 6		
Stranded with ferrules with plastic sleeve	0.25 - 6		
Multi-conductor connection capacity (two conductors with the same cross section)			
Solid / stranded	0.2 - 4 / 0.2 - 4		
Stranded with ferrules without plastic sleeve	0.25 - 2.5		
Stranded with TWIN ferrule with plastic sleeve	0.5 - 4		
Cross section with insertion bridge (solid/stranded)	- / -		
Insulation coordination			
Surge voltage category / pollution degree	III / 3	III / 2	II / 2
Rated insulation voltage	500	1000	1000
Rated surge voltage	6	6	6
Approval data (UL/CUL)	B	C	D
Nominal voltage	300	150	300
Nominal current	50	50	10
Connection capacity AWG	26 - 8	26 - 8	26 - 8
Approval data (CSA)	B	C	D
Nominal voltage	300	150	300
Nominal current	50	50	10
Connection capacity AWG	26 - 8	26 - 8	26 - 8
General data			
Stripping length	9		
Terminal sleeve: Thread / Torque	M4 / 1.5 - 1.8		
Insulation material	PA		
Inflammability class according to UL 94	V0		

Description



Molded feed-through terminal blocks, with solder connection and knurled nut inside



Molded feed-through terminal blocks, with solder connection and securing wedge inside



Dimensional drawing

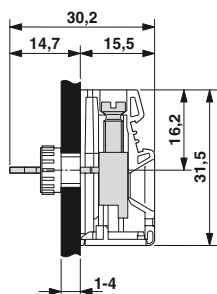

Drilling diagram

* Dimensions when using the DP-VDFK 6/4 spacer plate

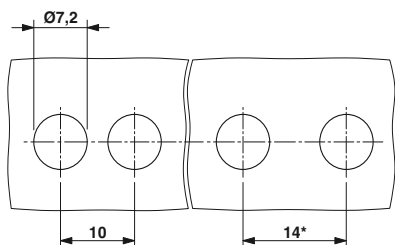

Ordering data

Type	Order No.	Pcs. / Pkt.
Molded feed-through terminal block, for housing panels 1 ... 4 mm thick		
VDFK 6	0711027	50
Molded feed-through terminal block, for 4...8 mm		
VDFK 6-DP	0711014	50

UC-TM 10 marking material for marking the lateral groove (see Catalog 5)
 ZB 10 marking material for marking the lateral groove (see Catalog 5)
 BN-ZB 10 marking material (see online catalog)



Dimensional drawing

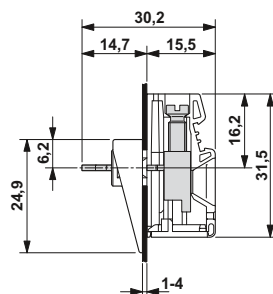

Drilling diagram

* Dimensions when using the DP-VDFK 6/4 spacer plate

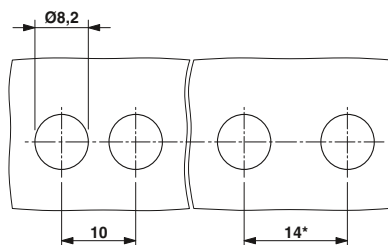

Ordering data

Type	Order No.	Pcs. / Pkt.
Molded feed-through terminal block, for housing panels 1 ... 4 mm thick		
VDFK 6/K	0711056	50
Molded feed-through terminal block, for housing panels 4...7 mm thick		
VDFK 6/K-DP	0711043	50

UC-TM 10 marking material for marking the lateral groove (see Catalog 5)
 ZB 10 marking material for marking the lateral groove (see Catalog 5)
 BN-ZB 10 marking material (see online catalog)

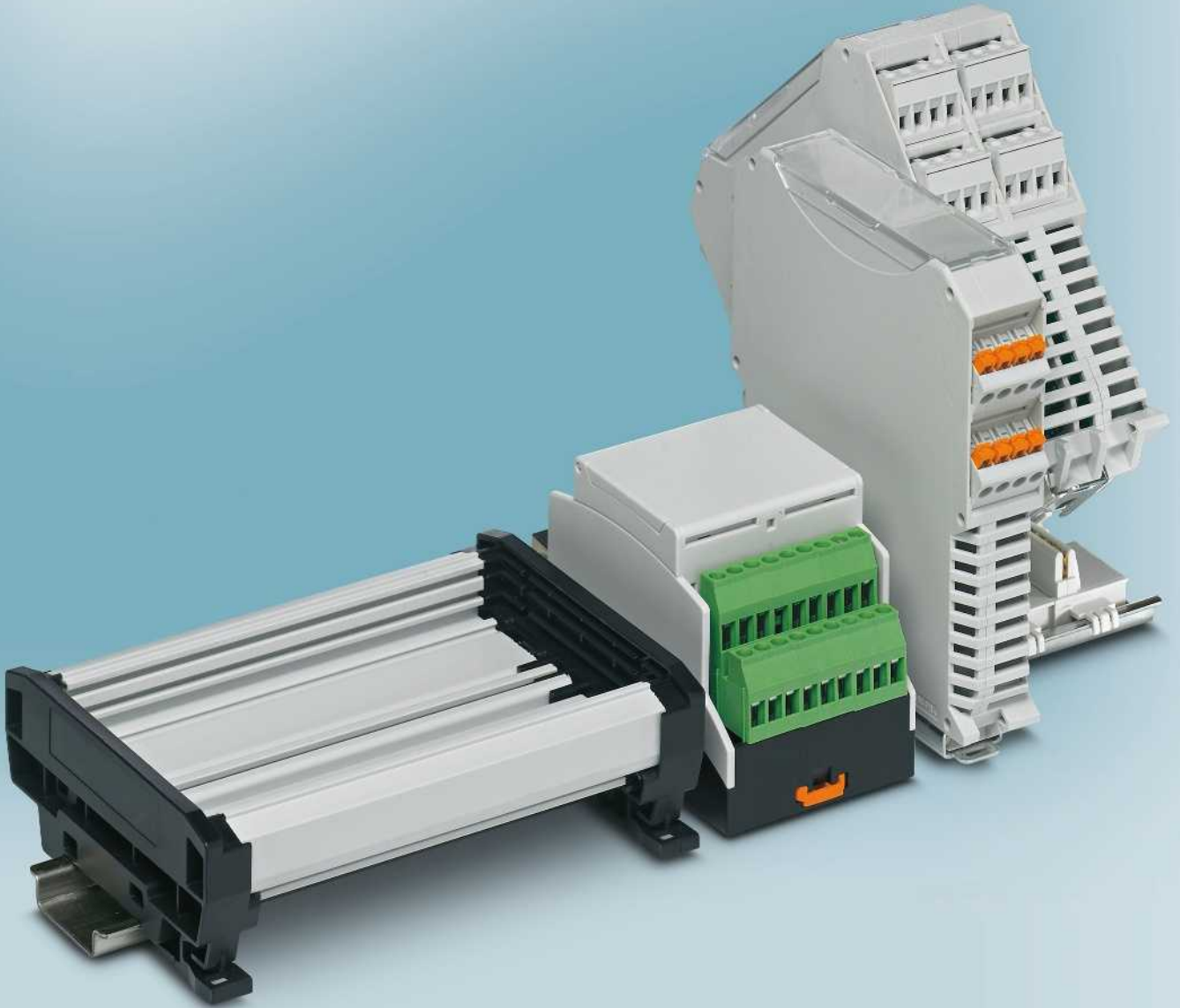

Electronics housing

Phoenix Contact component housings transform the assembled PCB into a shock-proof and dust-proof electronics module. The housings are mounted quickly and safely on standard 35 mm DIN rails. Apart from a few exceptions, the connection terminal blocks can be fitted and machine-soldered during PCB assembly.

The panel mounting bases consist of modular components, which form a DIN-rail mountable chassis for accommodating the PCB. The surface of the PCB is freely accessible, making it particularly suitable for bulky operating elements or large plug-in connectors. If a device cannot be mounted directly on a standard DIN rail, Phoenix Contact mounting plates are available for adaptation.

Whether screw, spring-cage or fast connection, individual housing with customized connection technology is no problem for Phoenix Contact. We will develop and produce your special housing solution in accordance with your particular design specifications. From modifying a standard product through to developing a new solution, we provide expert support throughout.

Customer-specific solutions	648
Modular component housings for industrial electronics	650
ME modular component housings	652
ME BUS modular component housings	662
ME TBUS modular component housings	666
TBUS DIN rail connectors	676
ME MAX modular component housings	678
Building installation housings according to DIN EN 43880	694
BC installation component housings	698
Basic housings for universal use	704
EMG system component housings	708
EG receptacle-type component housings	718
UEG universal component housings	722
UEGM universal component housings	724
UEGH universal component housings	726
UEGM-MSTB universal component housings	728
Multifunctional housings for complex electronics	730
ME-PLC function component housings	732
CM compact component housings	736
EFG single component housings	738
UEG-EU universal component housings	739
Profile racks and adapters	740
UM-ALU 4 aluminum profile housings	742
UM-PRO and UM-BASIC press-drawn section panel mounting bases	748
UM press-drawn section panel mounting bases	754
UMK plug-in module panel mounting bases	760
UM plug-in module panel mounting bases	758
UTA, EM-MP/SISM DIN rail adapters	764
HC-ALU handheld housings for use in the field	766

Customer-specific solutions

Electronics housings in other colors



Electronics housings can also be produced in colors other than the standard color, either completely or as a combination of different colored housing parts. Our ability to reproduce your own company color maximizes brand recognition value.

Mechanically processed electronics housings



We can mill the necessary openings for connection systems, displays, screens or operating elements. Customer-specific cut-outs can be made on each side of the housing with our state-of-the-art milling machines. This means that you do not have to carry out additional manufacturing work or deal with the associated logistical issues. Your stock inventory is thereby reduced to components that are ready for assembly.

Marking and printing on electronics housings

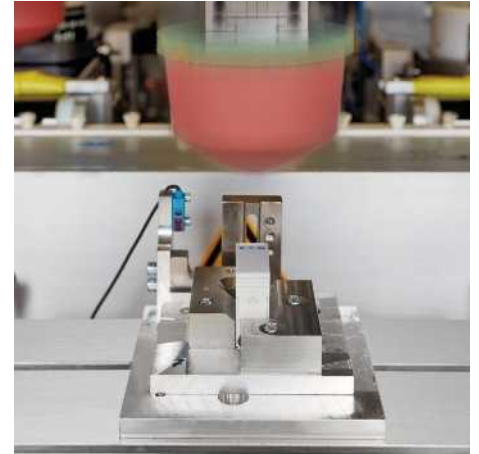

Phoenix Contact offers the option of printing housings or housing parts according to your specifications. The following procedures are available:

- Pad printing: ideal for one- or two-color printing
- Screen printing: for printing in multiple colors on larger surfaces
- Laser printing: particularly suitable for content that changes on a regular basis, e.g., serial numbers or barcodes

Customer-specific adaptations in series tools



For large volumes, injection molding is often a more cost-effective approach than mechanical finishing. Phoenix Contact is able to offer you the option of producing customized housing components directly from an original mold.

Development of a customer-specific housing component



To deliver a solution adapted to meet your specific requirements, it is sometimes necessary to replace individual standard housing parts with customer-specific design features. We design housing parts according to your specifications and combine them with proven standard components.

Development of new customer-specific housings

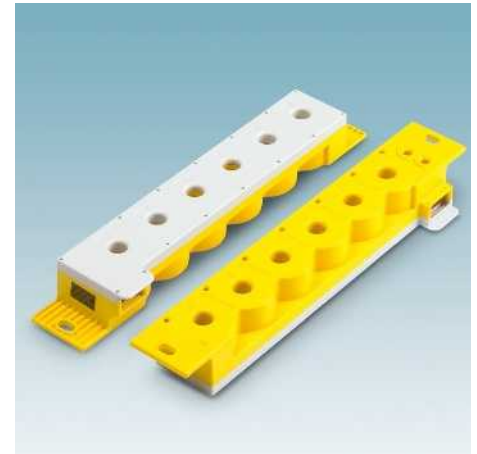

Do you need a new, special housing designed according to your requirements? With the expertise of our experienced housing specialists, we will support and assist you through all the necessary steps.

What you can expect from us:

- Draft of concept
- Design
- Prototype construction
- Tool engineering
- Pre-series production
- Series production

The example shown here is the housing for a custom-made insulation fault evaluator by Bender GmbH & Co. KG Grünberg.

Modular housing



ME and ME MAX modular electronics housings offer a functional and design-oriented “packaging” solution for modern electronic components. Variable connection technology, bus connectors, and modularity ensure the right device design for every application.



Flat designs

Flat and super-flat designs are the ideal solution for use in distributed terminal boxes.

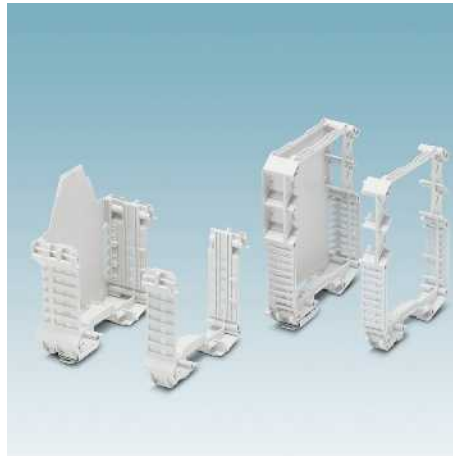

Modular construction

Housing widths with 17.5 mm or 22.5 mm pitch can be increased as required by aligning intermediate elements.



Connection systems

Hard soldered or plug-in connection technology with variable pitch dimensions and numbers of positions maximizes flexibility where PCB connections are concerned.



ME housing range

- Your advantages at a glance:
- Pre-assembled receptacle housing
 - Various cover versions
 - Same PCB geometry for different PCB connection technologies
 - Optional: DIN rail connector or integrated cross connector

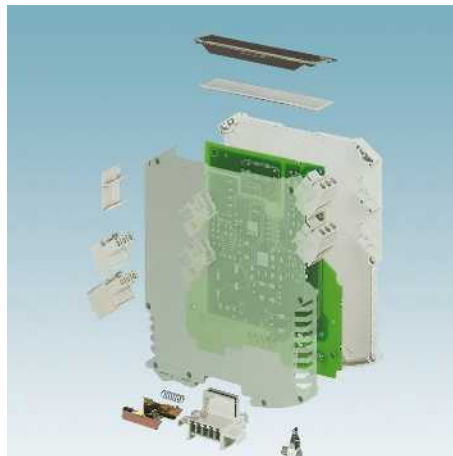

ME MAX housing range

- Your advantages at a glance:
- Large PCB assembly area
 - Large front panel with transparent cover and fitted cover
 - Half-shell design
 - Optional: DIN rail connector

ME electronics housings

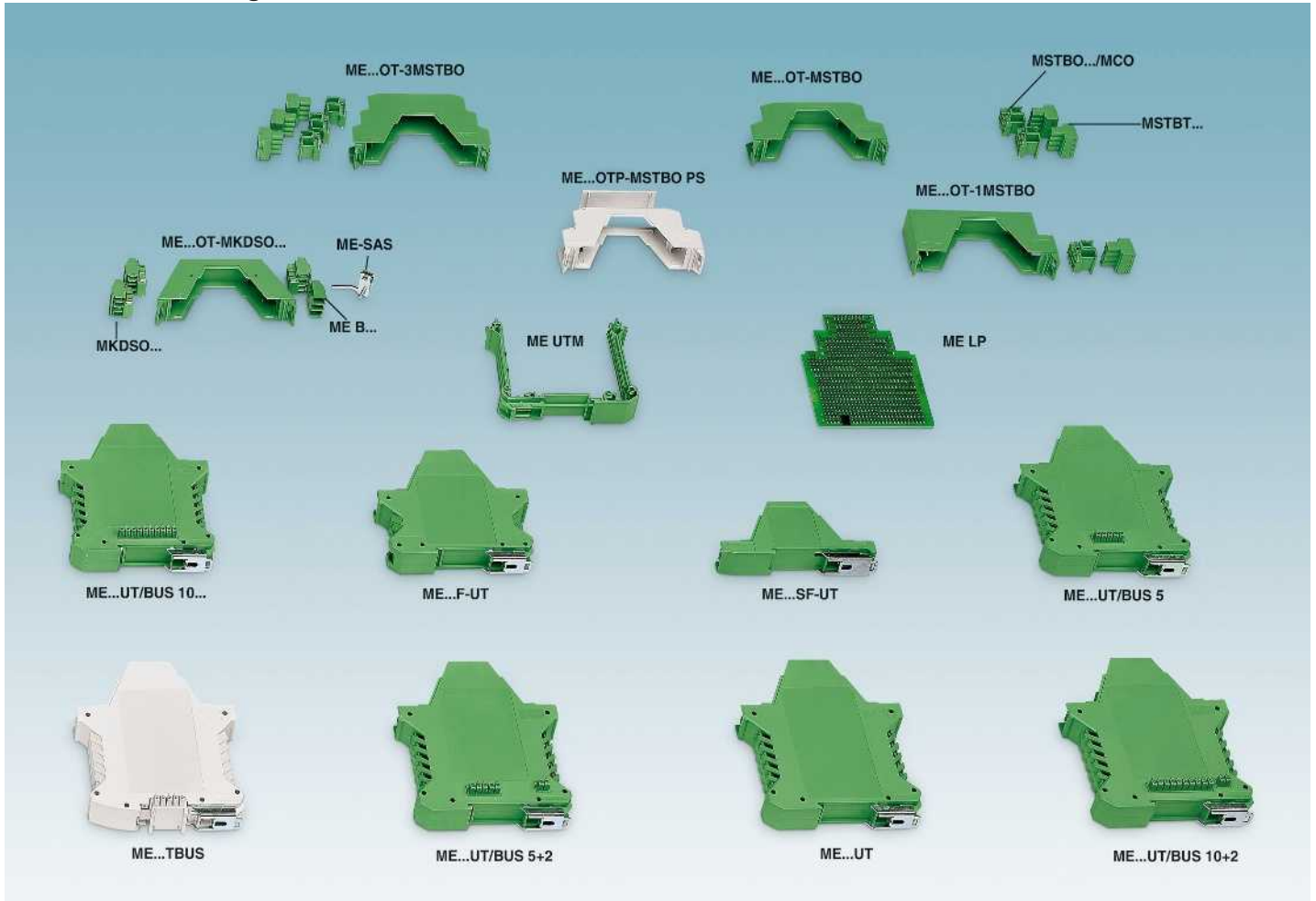

- ① MSTBO/MKDSO, etc., PCB connection technology see page 656
- ② ME...OT upper housing parts starting on page 670
- ③ ME LP sample PCB see page 658
- ④ ME...UT housing bases starting on page 658

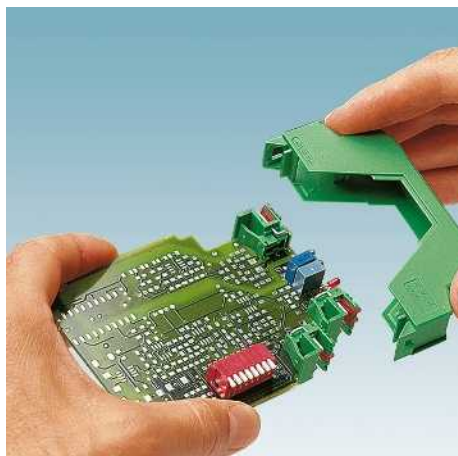

Mounting principle

Electronic components and PCB connection technology can be assembled and soldered in a single step. The upper part of the housing is mounted simply by latching with the soldered connection technology.

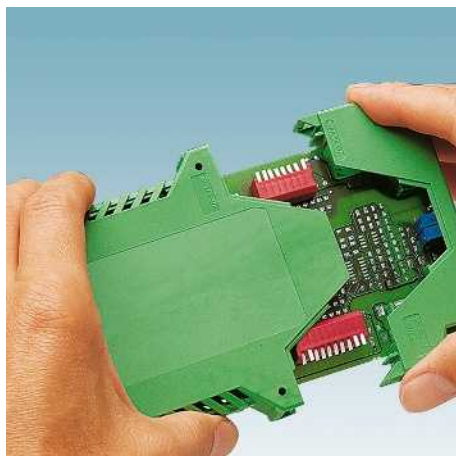

Having been pre-assembled in this way, the upper part is then pushed into the base of the housing, where it locks automatically.

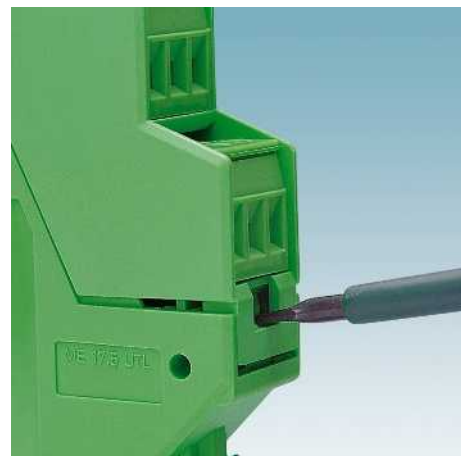

Release

The housing can be easily opened by simply pressing on the lock hook, e.g., using a screwdriver.

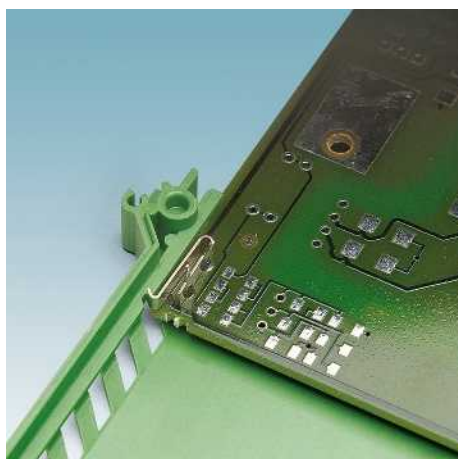

Partial removal

After approximately 4 cm, the ME LPZS PCB stop prevents the PCB from being removed completely and simultaneously locks it in place.



Integrated bus connectors







The bus connector integrated in the bottom of the ME housing is in one piece. The conductive path contact points on the PCB make direct contact with the gold-plated contact forks of the cross connector when the electronics module is inserted. A functional earth ground contact also integrated into the bottom of the housing connects the inserted PCB directly to the grounded DIN rail.



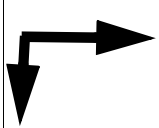





DIN rail connectors





The ME...TBUS connector snaps onto all standard NS 35/7,5 or NS 35/15 DIN rails. When an individual device is removed from the topology, the contact chain is not interrupted.

Matrix for selecting the housing base

ME housing base	Type	Page	Width [mm]	Without bus connector	With bus connector		
				ME... UT (G) Page 658	Integrated		
					5-pos. ME... UT BUS/5 Page 662	5+2-pos. ME... UT BUS/5+2 Page 662	
Start by selecting the housing base 							
	Tall design (standard)						
		ME 12,5 UT...	658	12.5	•		
		ME 17,5 UT...	658	17.5	•	•	•
		ME 22,5 UT...	659	22.5	•	•	•
		ME 35 UT...	660	35	•	•	•
		ME 45 UT....	660	45	•	•	•
ME 67,5 UT....		661	67.5	•		•	
ME 90 UT....	661	90	•		•		
Flat design							
	ME 22,5 F-UT....	659	22.5	•	•	•	
Ultra-flat design							
	ME 22,5 SF	659	22.5	•			



Matrix for selecting the housing upper part

ME housing base	Type	Page	ME upper housing parts			
			For PCB terminal block connection Screw ME... OTU-MKDSO Page 670	Spring-cage ME... OT-FKDSO Page 670	For COMBICON connection Single-level ME...OT-1MSTBO Page 670	
						
Select the housing upper part according to the housing width 						
	Tall design (standard)					
		ME 12,5 UT...	658	•	•	
		ME 17,5 UT...	658	•	•	
		ME 22,5 UT...	659	•	•	•
		ME 35 UT...	660	o	o	
		ME 45 UT....	660	•	•	•
ME 67,5 UT....		661	o	o	•	
ME 90 UT....	661	o	o	•		
Flat design						
	ME 22,5 F-UT....	659	•	•	•	
Ultra-flat design						
	ME 22,5 SF	659	•	•	•	

	With bus connector		For DIN rails 5-pos. ME...-TBUS Page 666	Intermediate element for increasing the housing width	
	Integrated 10-pos. ME... UT BUS/10 Page 662	10+2-pos. ME... UT BUS/10+2 Page 662		17.5 mm pitch ME 35 UTM / ME35 UTMG Page 675	22.5 mm pitch ME 45 UTM / ME 45 UTMG Page 675
					
	•	•	•	•	
	•	•	•	•	•
	•	•	•		•
	•	•	•		•
	•	•	•		•
	•	•	•		•
	•	•	•		•
	•	•	•		•
	•	•	•		•



Then select the housing upper part









	ME upper housing parts	
	Double-level ME.. OT-MSTBO Page 670	For COMBICON connection Three-level ME... OT-3MSTBO Page 670
		
	•	
	•	
	•	•
	•	○
	○	○
	○	○
	•	•
	•	•

Then select the connection technology











• = Housing upper part available in corresponding design width.
○ = Combination of several upper parts with smaller design width in the same housing pitch.

Matrix for selecting the connection technology

ME housing upper part	Type	Page	Width [mm]	PCB terminal block			
				3.5 mm pitch MKDSO 1,5/...3,5 Page 89	Screw 5 mm pitch MKDSO 2,5/... Page 113	7.5 mm pitch MKDSO 2,5 HV...7,5 Page 125	5 mm pitch FKDSO 2,5/... Page 153
Select the connection technology according to the selected housing upper part 							
	ME 12,5 OTU-MKDSO	670	12.5	• 3-pos.	• 2-pos.		
	ME 17,5 OTU-MKDSO	670	17.5	• 4-pos.	• 3-pos.		
	ME 22,5 OTU-MKDSO	671	22.5	• 5-pos.	• 4-pos.		
	ME 45 OTU-MKDSO	671	45	• 5-pos.	• 4-pos.		
	ME 12,5 OT-FKDSO	670	12.5				• 2-pos.
	ME 17,5 OT-FKDSO	670	17.5				• 3-pos.
	ME 22,5 OT-FKDSO	671	22.5				• 4-pos.
	ME 45 OT-FKDSO	671	45				• 4-pos.
	ME 22,5 OT-1MSTBO	670	22.5				
	ME 45 OT-1MSTBO	670	45				
	ME 67,5 OT-1MSTBO	671	67.5				
	ME 90 OT-1MSTBO	671	90				
	ME 12,5 OT-MSTBO	670	12.5				
	ME 17,5 OT-MSTBO	670	17.5				
	ME 22,5 OT-MSTBO	671	22.5				
	ME 35 OT-MSTBO	671	35				
	ME 45 OT-MSTBO	671	45				
	ME 22,5 OT-3MSTBO	671	22.5				
						Only for ME MAX housing range	

Matrix for selecting the filler plug

ME housing upper part	Type	Page	Width [mm]	Filler plug			
				For PCB terminal block upper part ME B-...MKDSO Page 674	ME B-...FKDSO Page 674	For COMBICON upper part ME B-...MSTBO Page 674	ME B-...3MSTBO Page 674
Select the filler plug according to the selected housing upper part 							
	ME 12,5 OTU-MKDSO	670	12.5	•			
	ME 17,5 OTU-MKDSO	670	17.5	•			
	ME 22,5 OTU-MKDSO	671	22.5	•			
	ME 45 OTU-MKDSO	671	45	•			
	ME 12,5 OT-FKDSO	670	12.5		•		
	ME 17,5 OT-FKDSO	670	17.5		•		
	ME 22,5 OT-FKDSO	671	22.5		•		
	ME 45 OT-FKDSO	671	45		•		
	ME 22,5 OT-1MSTBO	671	22.5			•	
	ME 45 OT-1MSTBO	671	45			•	
	ME 67,5 OT-1MSTBO	671	67.5			•	
	ME 90 OT-1MSTBO	671	90			•	
	ME 12,5 OT-MSTBO	670	12.5			•	
	ME 17,5 OT-MSTBO	670	17.5			•	
	ME 22,5 OT-MSTBO	671	22.5			•	
	ME 35 OT-MSTBO	671	35			•	
	ME 45 OT-MSTBO	671	45			•	
	ME 22,5 OT-3MSTBO	671	22.5				•
							2 required per terminal point.

COMBICON connection					Number of terminal points
3.5 mm pitch MCO 1,5/...3,5 Page 232	5 mm pitch MSTBO 2,5/... Page 322	Header Pitch: 5, touch proof MSTBO 2,5/...P Page 325	Pitch: 5, THR MSTBO 2,5/...THR UTMG Page 309	7.25 mm pitch GMSTBO 2,5 HV/...THR UTMG Page 510	
					
					2 per housing side
					2 per housing side
					2 per housing side
					4 per housing side
					2 per housing side
					2 per housing side
					2 per housing side
					4 per housing side
• 5-pos.	• 4-pos.	• 4-pos.	• 4-pos.	• 3-pos.	1 → Housing upper part can only be fitted with terminal block on one side
• 5-pos.	• 4-pos.	• 4-pos.	• 4-pos.	• 3-pos.	2 → Housing upper part can only be fitted with terminal block on one side
• 5-pos.	• 4-pos.	• 4-pos.	• 4-pos.	• 3-pos.	3 → Housing upper part can only be fitted with terminal block on one side
• 5-pos.	• 4-pos.	• 4-pos.	• 4-pos.	• 3-pos.	4 → Housing upper part can only be fitted with terminal block on one side
• 3-pos.	• 2-pos.	• 2-pos.	• 2-pos.		2 per housing side
• 4-pos.	• 3-pos.	• 3-pos.	• 3-pos.	• 2-pos.	2 per housing side
• 5-pos.	• 4-pos.	• 4-pos.	• 4-pos.	• 3-pos.	2 per housing side
• 4-pos.	• 3-pos.	• 3-pos.	• 3-pos.	• 2-pos.	4 per housing side
• 5-pos.	• 4-pos.	• 4-pos.	• 4-pos.	• 3-pos.	4 per housing side
• 5-pos.	• 4-pos.	• 4-pos.	• 4-pos.	• 3-pos.	3 per housing side

Specified number of positions = number of positions per terminal point

Modular component housing for industrial electronics

Bases for ME modular component housing

More housing dimensions, the layout of the PCBs, their dimensions and assembly areas can be found in the download center at: www.phoenixcontact.net/products

Notes:
Marking systems and mounting materials: see Catalog 5.
At least one COMBICON base strip or one PCB terminal block must be mounted on each side of the PCB.
For PCB connection technology, see page 656.
For accessories, refer to page: 674.
1) For information on power dissipation, see page 770.



Tall design, width: 12.5 mm



Tall design, width: 17.5 mm

Power dissipation P_V at 20°C in horizontal mounting position¹⁾

Mounted in rows without spacing
Mounted in rows with min. 20 mm spacing
Type of housing
Electronic housings



Technical data			
ME 12,5 UT GN	ME 12,5 UTG GN		
4.4 W	4.3 W	-	-
8.4 W	7.1 W	-	-
Polyamide / V0			



Technical data			
ME 17,5 UT GN	ME 17,5 UTG GN		
5.2 W	4.9 W	-	-
10.8 W	8.9 W	-	-
Polyamide / V0			

Description

Lower part of housing, fully assembled, with metal foot catch

with vents
without vents

Lower part of housing, fully assembled, with metal foot catch, with integrated functional earth contact

with vents

without vents

Lower part of housing, fully assembled, with metal foot catch

Superflat design

Lower part of housing, fully assembled, with metal foot catch

with vents, low-profile design
without vents, low-profile design

Lower part of housing, fully assembled, with metal foot catch, with integrated functional earth contact, flat design

with vents

without vents

Ordering data		
Type	Order No.	Pcs. / Pkt.
ME 12,5 UT GN	2906759	10
ME 12,5 UTG GN	2906762	10
ME 12,5 UT/FE GN	2906791	10
ME 12,5 UTG/FE GN	2906801	10

Ordering data		
Type	Order No.	Pcs. / Pkt.
ME 17,5 UT GN	2906775	10
ME 17,5 UTG GN	2906788	10
ME 17,5 UT/FE GN	2906924	10
ME 17,5 UTG/FE GN	2906937	10

PCB, for custom mounting components, for ME housing without bus connector

Accessories		
ME LP	2906908	5

Accessories		
ME LP	2906908	5

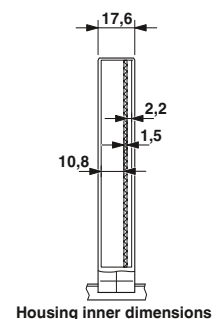
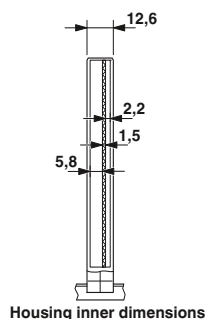
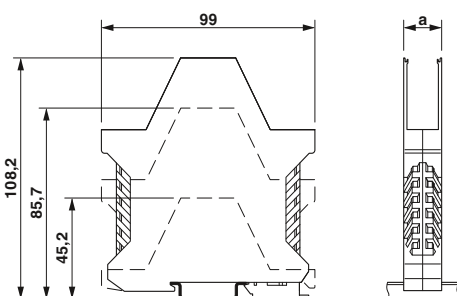



Ultra-flat design, width: 22.5 mm



Flat design, width 22.5 mm



Tall design, width: 22.5 mm



Technical data			
ME 22,5 SF-UT GN	-	-	-
-	-	-	-
Polyamide / V0			

Ordering data		
Type	Order No.	Pcs. / Pkt.
ME 22,5 SF-UT GN	2708009	10

Accessories		



Technical data			
ME 22,5 F-UT GN	ME 22,5 F-UTG GN	-	-
5.9 W	5.5 W	-	-
11.5 W	9.6 W	-	-
Polyamide / V0			

Ordering data		
Type	Order No.	Pcs. / Pkt.
ME 22,5 F-UT GN	2854131	10
ME 22,5 F-UTG GN	2854144	10
ME 22,5 F-UT/FE GN	2854160	10
ME 22,5 F-UTG/FE GN	2854157	10

Accessories		



Technical data			
ME 22,5 UT GN	ME 22,5 UTG GN	-	-
6.1 W	5.7 W	-	-
12.1 W	10.1 W	-	-
Polyamide / V0			

Ordering data		
Type	Order No.	Pcs. / Pkt.
ME 22,5 UT GN	2907130	10
ME 22,5 UTG GN	2907127	10
ME 22,5 UT/FE GN	2907114	10
ME 22,5 UTG/FE GN	2907101	10

Accessories		
ME LP		5

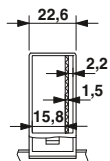

Housing inner dimensions

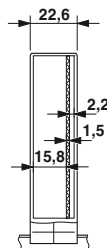

Housing inner dimensions

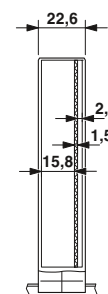

Housing inner dimensions

Modular component housing for industrial electronics

Bases for ME modular component housing

More housing dimensions, the layout of the PCBs, their dimensions and assembly areas can be found in the download center at: www.phoenixcontact.net/products

Notes:
Marking systems and mounting materials: see Catalog 5.
At least one COMBICON base strip or one PCB terminal block must be mounted on each side of the PCB.
For PCB connection technology, see page 656.
For accessories, see page 674.
1) For information on power dissipation, see page 770.



Tall design, width: 35 mm



Tall design, width: 45 mm

Power dissipation P_V at 20°C in horizontal mounting position¹⁾

Mounted in rows without spacing
 Mounted in rows with min. 20 mm spacing
 Type of housing
 Electronic housings



Technical data			
ME 35 UT GN	ME 35 UTG GN		
7.9 W	7.5 W	-	-
16.3 W	13.8 W	-	-
Polyamide / V0			



Technical data			
ME 45 UT GN	ME 45 UTG GN		
8.2 W	7.6 W	-	-
16.5 W	14.1 W	-	-
Polyamide / V0			

Description

Lower part of housing, fully assembled, with metal foot catch

with vents
 without vents

Lower part of housing, fully assembled, with metal foot catch, with integrated functional earth contact

with vents
 without vents

Ordering data		
Type	Order No.	Pcs. / Pkt.
ME 35 UT GN	2907198	10
ME 35 UTG GN	2907208	10
ME 35 UT/FE GN	2907211	10
ME 35 UTG/FE GN	2907224	10

Ordering data		
Type	Order No.	Pcs. / Pkt.
ME 45 UT GN	2909361	10
ME 45 UTG GN	2909374	10
ME 45 UT/FE GN	2909358	10
ME 45 UTG/FE GN	2909387	10

PCB, for custom mounting components, for ME housing without bus connector

Accessories		
ME LP	2906908	5

Accessories		
ME LP	2906908	5

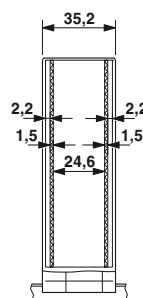
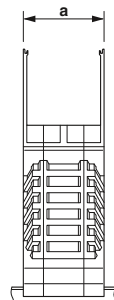
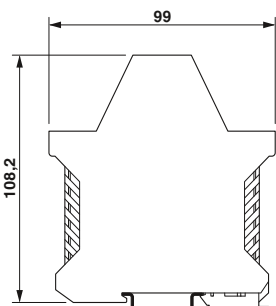

Housing inner dimensions

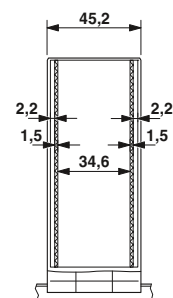

Housing inner dimensions



Tall design, width: 67.5 mm



Tall design, width: 90 mm

Technical data			
ME 67,5 UT/FE KMGY			
9.1 W	-	-	-
17.5 W	-	-	-
Polyamide / V0			

Ordering data		
Type	Order No.	Pcs. / Pkt.
ME 67,5 UT/FE KMGY	2200535	10

Accessories		
Type	Order No.	Pcs. / Pkt.
ME LP	2906908	5

Technical data			
ME 90 UT/FE KMGY			
10.4 W	-	-	-
18.9 W	-	-	-
Polyamide / V0			

Ordering data		
Type	Order No.	Pcs. / Pkt.
ME 90 UT/FE KMGY	2200536	10

Accessories		
Type	Order No.	Pcs. / Pkt.
ME LP	2906908	5

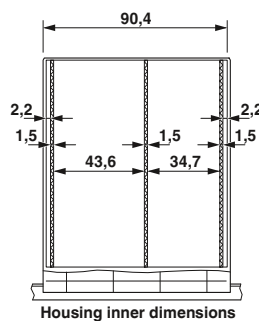
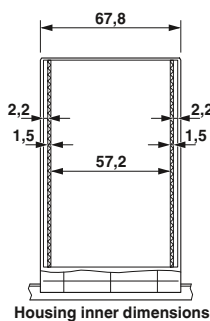

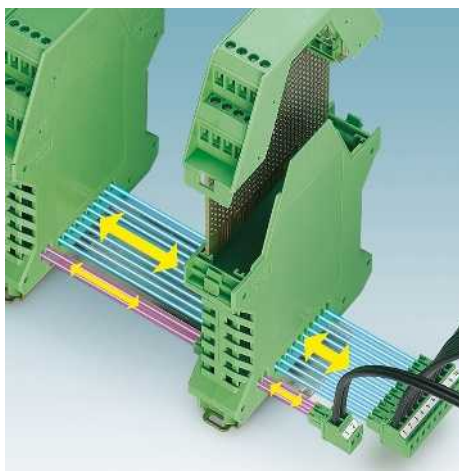

The ME bus housings are the system version of the ME modular electronic housing with integrated, cascable cross connection.

Main features:

- Six housing widths from 17.5 mm to 90 mm
- 5 or 10 integrated parallel contacts
- 2 optional serial contacts (daisy chain)
- Gold contacts for data transmission and power supply (125 V, 8 A)
- Supply via standard MINI COMBICON connector
- Can be snapped onto commercially available NS 35/7,5 and NS 35/15 DIN rails

More housing dimensions, the layout of the PCBs, their dimensions and assembly areas can be found in the download center at:
www.phoenixcontact.net/products

Notes:
Marking systems and mounting materials: see Catalog 5.
At least one COMBICON base strip or one PCB terminal block must be mounted on each side of the PCB.
For PCB connection technology, see page 656.
For accessories, refer to page: 674.
1) For information on power dissipation, see page 770.

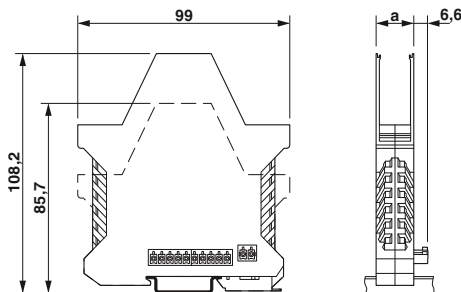

Tall design, width: 17.5 mm



Power dissipation P_v at 20°C in horizontal mounting position¹⁾

- Mounted in rows without spacing
- Mounted in rows with min. 20 mm spacing

Type of housing
Electronic housings

Technical data

ME 17,5 UT/FE BUS/5 GN			
5.2 W	-	-	-
10.8 W	-	-	-

Polyamide / V0

Ordering data

Description
Lower part of a housing , with vents, fully pre-assembled, with integrated bus connector (parallel)
Without functional earth ground contact and bus connector, 5-pos.
Without functional earth ground contact and bus connector, 10-pos.
With functional earth ground contact and bus connector, 5-pos.
With functional earth ground contact and bus connector, 10-pos.
Housing base , with vents and functional earth ground contacts
With additional serial contacting (2-pos.), and bus connector, 5-pos. and 2-pos.
With additional serial contacting (2-pos.), and bus connector, 10-pos. and 2-pos.
Housing base , flat design, fully pre-assembled
With vents and bus connector, 5-pos.
Without vents, with bus connector, 5-pos.
With vents and bus connector, 10-pos.
Without vents, with bus connector, 10-pos.
Lower part of housing , flat design, fully pre-assembled with integrated 5 or 10 pos. bus connector (parallel) and additional serial contacting (2-pos.)
With vents and bus connector, 5-pos., 2-pos.
Without vents and with bus connector, 5-pos., 2-pos.
With vents and bus connector, 10-pos., 2-pos.
Without vents and with bus connector, 10-pos., 2-pos.

Type	Order No.	Pcs. / Pkt.
ME 17,5 UT/FE BUS/ 5 GN	2908728	10
ME 17,5 UT/FE BUS/10 GN	2908731	10
ME 17,5 UT/FE BUS/ 5+2 GN	2854186	10
ME 17,5 UT/FE BUS/10+2 GN	2854199	10

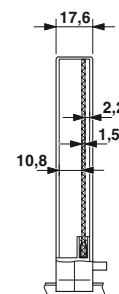
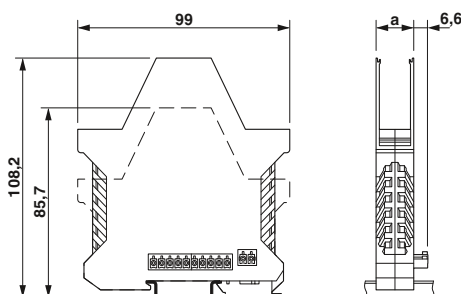

Housing inner dimensions



Flat design, width 22.5 mm



Tall design, width: 22.5 mm



Tall design, width: 35 mm



Technical data			
ME 22,5 F-UT BUS/ 5 GN			
5.9 W	-	-	-
11.5 W	-	-	-
Polyamide / V0			

Technical data			
ME 22,5 UT/FE BUS/5 GN			
6.1 W	-	-	-
12.1 W	-	-	-
Polyamide / V0			

Technical data			
ME 35 UT BUS/ 5 GN			
7.9 W	-	-	-
16.3 W	-	-	-
Polyamide / V0			

Ordering data

Ordering data

Ordering data

Type	Order No.	Pcs. / Pkt.
ME 22,5 F-UT BUS/ 5 GN	2735975	10
ME 22,5 F-UTG BUS/ 5 GN	2735988	10
ME 22,5 F-UT BUS/10 GN	2735991	10
ME 22,5 F-UTG BUS/10 GN	2736000	10
ME 22,5 F-UT BUS/ 5+2 GN	2706014	10
ME 22,5 F-UTG BUS/ 5+2 GN	2706027	10
ME 22,5 F-UT BUS/10+2 GN	2706030	10
ME 22,5 F-UTG BUS/10+2 GN	2706043	10

Type	Order No.	Pcs. / Pkt.
ME 22,5 UT/FE BUS/ 5 GN	2908744	10
ME 22,5 UT/FE BUS/10 GN	2908755	10
ME 22,5 UT/FE BUS/ 5+2 GN	2854209	10
ME 22,5 UT/FE BUS/10+2 GN	2854212	10

Type	Order No.	Pcs. / Pkt.
ME 35 UT BUS/ 5 GN	2853637	10
ME 35 UT BUS/10 GN	2853640	10
ME 35 UT/FE BUS/5 GN	2706771	10
ME 35 UT/FE BUS/ 5+2 GN	2735551	10
ME 35 UT/FE BUS/10+2 GN	2735564	10

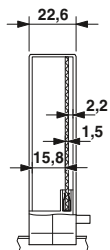

Housing inner dimensions

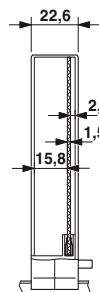

Housing inner dimensions

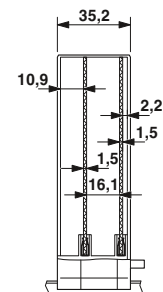

Housing inner dimensions

Notes:
Marking systems and mounting materials: see Catalog 5.
At least one COMBICON base strip or one PCB terminal block must be mounted on each side of the PCB.
For PCB connection technology, see page 656.
For accessories, refer to page: 674.
1) For information on power dissipation, see page 770.

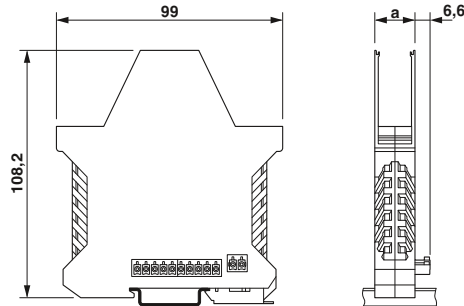

Tall design, width: 45 mm



Power dissipation P_v at 20°C in horizontal mounting position¹⁾

Mounted in rows without spacing
Mounted in rows with min. 20 mm spacing

Type of housing
Electronic housings

Technical data			
ME 45 UT BUS/5 GN			
8.2 W	-	-	-
16.5 W	-	-	-
Polyamide / V0			

Description
Housing base, with vents, fully pre-assembled
Without functional earth ground contact and bus connector, 5-pos.
Without functional earth ground contact and bus connector, 10-pos.
With functional earth ground contact and bus connector, 5-pos.
With functional earth ground contact and bus connector, 10-pos.
Housing base, fully pre-assembled, with metal foot catch, with integrated functional earth ground contacts and vents
With additional serial contacting (2-pos.), and bus connector, 5-pos. and 2-pos.
With additional serial contacting (2-pos.), and bus connector, 10-pos. and 2-pos.

Ordering data		
Type	Order No.	Pcs. / Pkt.
ME 45 UT BUS/5 GN	2853679	10
ME 45 UT BUS/10 GN	2853682	10
ME 45 UT/FE BUS/ 5 GN	2709765	10
ME 45 UT/FE BUS/ 5+2 GN	2735577	10
ME 45 UT/FE BUS/10+2 GN	2735580	10

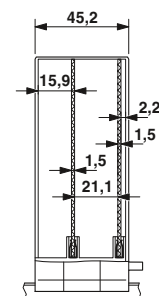
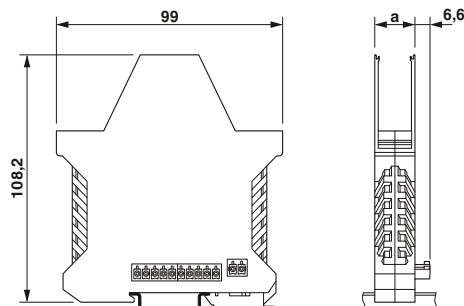

Housing inner dimensions



Tall design, width: 67.5 mm



Tall design, width: 90 mm

Technical data			
ME 67,5 UT/FE BUS/10 KMGY			
9.1 W	-	-	-
17.5 W	-	-	-
Polyamide / V0			

Ordering data		
Type	Order No.	Pcs. / Pkt.
ME 67,5 UT/FE BUS/10 KMGY	2200539	10
ME 67,5 UT/FE BUS/5+2 KMGY	2200537	10
ME 67,5 UT/FE BUS/10+2 KMGY	2200541	10

Technical data			
ME 90 UT/FE BUS/10 KMGY			
10.4 W	-	-	-
18.9 W	-	-	-
Polyamide / V0			

Ordering data		
Type	Order No.	Pcs. / Pkt.
ME 90 UT/FE BUS/10 KMGY	2200540	10
ME 90 UT/FE BUS/5+2 KMGY	2200538	10
ME 90 UT/FE BUS/10+2 KMGY	2200543	10

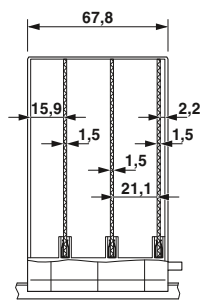

Housing inner dimensions

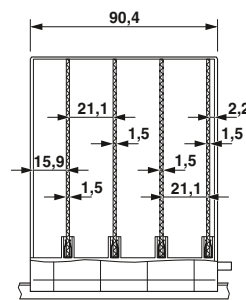

Housing inner dimensions

Modular component housing for industrial electronics

ME TBUS modular component housing



The ME TBUS housings can be interconnected using the DIN-rail mountable ME...TBUS connectors.

Main features:

- Six housing widths from 17.5 mm to 90 mm
- ME...TBUS connector with 5 parallel contacts can be snapped onto DIN rails to save space
- Gold contacts for data transmission and power supply (125 V, 8 A)
- When a device is unplugged from the system as a whole, the signal chain is not interrupted
- Supply via standard MINI COMBICON plug
- Can be snapped onto commercially available NS 35/7,5 and NS 35/15 DIN rails

More housing dimensions, the layout of the PCBs, their dimensions and assembly areas can be found in the download center at:

www.phoenixcontact.net/products

Notes:
Marking systems and mounting materials: see Catalog 5.
At least one COMBICON base strip or one PCB terminal block must be mounted on each side of the PCB.
For PCB connection technology, see page 656.
For accessories, refer to page: 674.
1) For information on power dissipation, see page 770.
2) DIN rail connectors see page 676.

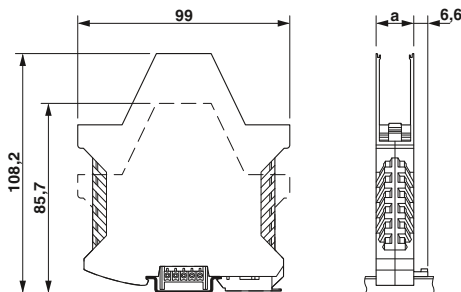

Tall design, width: 17.5 mm



Power dissipation P_V at 20°C in horizontal mounting position¹⁾

Mounted in rows without spacing
Mounted in rows with min. 20 mm spacing

Type of housing

Electronic housings

Connection data

ME 17,5.../TBUS...

Technical data

ME 17,5 UT TBUS KMGY	ME 17,5 UTG TBUS KMGY		
5,2 W	4,9 W	-	-
10,8 W	8,9 W	-	-
Polyamide / V0			
solid	stranded	I	U
	[mm ²]	AWG	[A] [V]
-	-	-	8 125

Ordering data

Type	Order No.	Pcs. / Pkt.
ME 17,5 UT TBUS KMGY	2914783	10
ME 17,5 UTG TBUS KMGY	2914796	10

Accessories

ME 17,5 TBUS 1,5/ 5-ST-3,81 KMGY	2713645	50
E/ME TBUS NS35 GY	2713780	50

DIN rail bus connector, 5-pos.²⁾

Power clip for TBUS connector, for strain relief in connection with MC(VR) 1,5/5-... or IMC 1,5/5-ST-3,81 AU plugs

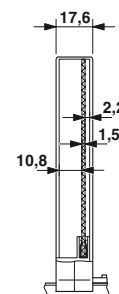
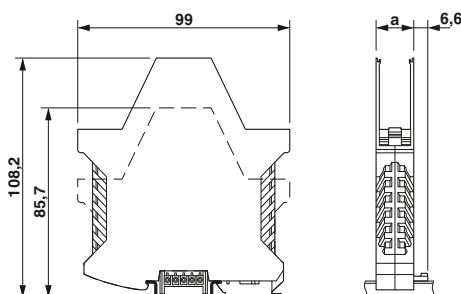

Housing inner dimensions



Flat design, width 22.5 mm



Tall design, width: 22.5 mm



Tall design, width: 35 mm



Technical data					
ME 22,5 F-UT TBUS KMGY	ME 22,5 F- UTG TBUS KMGY				
5.9 W	5.5 W	-	-		
11.5 W	9.6 W	-	-		
Polyamide / V0					
solid	stranded		I	U	
	[mm ²]	AWG	[A]	[V]	
-	-	-	8	125	



Technical data					
ME 22,5 UT TBUS KMGY	ME 22,5 UTG TBUS KMGY				
6.1 W	5.7 W	-	-		
12.1 W	10.1 W	-	-		
Polyamide / V0					
solid	stranded		I	U	
	[mm ²]	AWG	[A]	[V]	
-	-	-	8	125	



Technical data					
ME 35 UT TBUS KMGY	ME 35 UTG TBUS KMGY				
7.9 W	7.5 W	-	-		
16.3 W	13.8 W	-	-		
Polyamide / V0					
solid	stranded		I	U	
	[mm ²]	AWG	[A]	[V]	
-	-	-	8	125	

Ordering data		
Type	Order No.	Pcs. / Pkt.
ME 22,5 F-UT TBUS KMGY	2914835	10
ME 22,5 F-UTG TBUS KMGY	2914851	10

Ordering data		
Type	Order No.	Pcs. / Pkt.
ME 22,5 UT TBUS KMGY	2869524	10
ME 22,5 UTG TBUS KMGY	2914806	10

Ordering data		
Type	Order No.	Pcs. / Pkt.
ME 35 UT TBUS KMGY	2914819	10
ME 35 UTG TBUS KMGY	2914822	10

Accessories		
ME 22,5 TBUS 1,5/ 5-ST-3,81 KMGY	2713722	50
E/ME TBUS NS35 GY	2713780	50

Accessories		
ME 22,5 TBUS 1,5/ 5-ST-3,81 KMGY	2713722	50
E/ME TBUS NS35 GY	2713780	50

Accessories		
ME 17,5 TBUS 1,5/ 5-ST-3,81 KMGY	2713645	50
E/ME TBUS NS35 GY	2713780	50

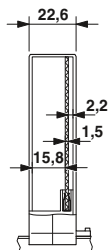

Housing inner dimensions

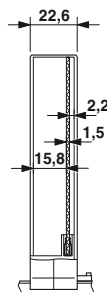

Housing inner dimensions

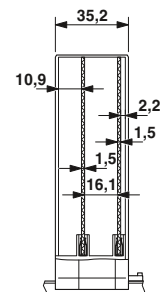

Housing inner dimensions

Modular component housing for industrial electronics

ME TBUS modular component housing

Notes:
Marking systems and mounting materials: see Catalog 5.
At least one COMBICON base strip or one PCB terminal block must be mounted on each side of the PCB.
For PCB connection technology, see page 656.
For accessories, refer to page: 674.
1) For information on power dissipation, see page 770.
2) DIN rail connectors see page 676.

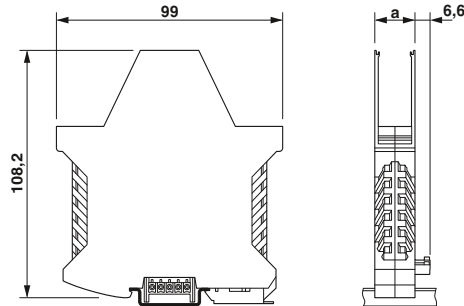

Tall design, width: 45 mm



Power dissipation P_V at 20°C in horizontal mounting position¹⁾

Mounted in rows without spacing
Mounted in rows with min. 20 mm spacing

Type of housing
Electronic housings

Connection data

ME 17,5.../TBUS...

Technical data				
ME 45 UT	ME 45 UTG			
TBUS KMGY	TBUS KMGY			
8.2 W	7.6 W	-	-	
16.5 W	14.1 W	-	-	
Polyamide / V0				
solid	stranded		I	U
	[mm ²]	AWG	[A]	[V]
-	-	-	8	125

Ordering data

Type	Order No.	Pcs. / Pkt.
ME 45 UT TBUS KMGY	2869511	10
ME 45 UTG TBUS KMGY	2914848	10

Accessories

ME 22,5 TBUS 1,5/ 5-ST-3,81 KMGY	2713722	50
E/ME TBUS NS35 GY	2713780	50

Description

Housing base, fully pre-assembled, with metal foot catch, without TBUS plug
with vents
without vents

DIN rail bus connector, 5-pos.²⁾

Power clip for TBUS plug, for strain relief in connection with MC(VR) 1,5/5-... or IMC 1,5/5-ST-3,81 AU plugs

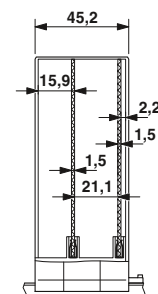
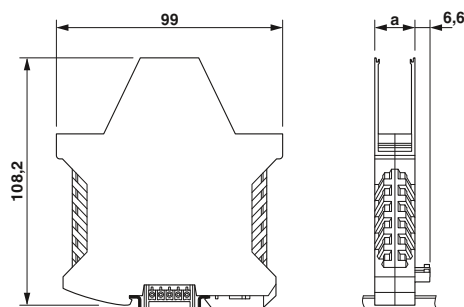

Housing inner dimensions



Tall design, width: 67.5 mm



Tall design, width: 90 mm

Technical data					
ME 67,5 UT TBUS KMGY					
9.1 W	-	-	-	-	-
17.5 W	-	-	-	-	-
Polyamide / V0					
solid	stranded		I	U	
	[mm ²]	AWG	[A]	[V]	
-	-	-	8	125	
Ordering data					
Type	Order No.	Pcs. / Pkt.			
ME 67,5 UT TBUS KMGY	2200544	10			
Accessories					
ME 22,5 TBUS 1,5/ 5-ST-3,81 KMGY	2713722	50			
E/ME TBUS NS35 GY	2713780	50			

Technical data					
ME 90 UT TBUS KMGY					
10.4 W	-	-	-	-	-
18.9 W	-	-	-	-	-
Polyamide / V0					
solid	stranded		I	U	
	[mm ²]	AWG	[A]	[V]	
-	-	-	8	125	
Ordering data					
Type	Order No.	Pcs. / Pkt.			
ME 90 UT TBUS KMGY	2200545	10			
Accessories					
ME 22,5 TBUS 1,5/ 5-ST-3,81 KMGY	2713722	50			
E/ME TBUS NS35 GY	2713780	50			

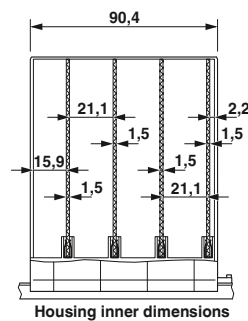
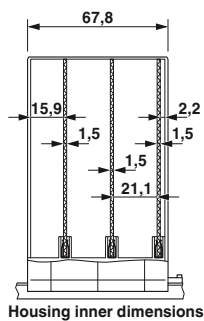



Width: 22.5 mm



Width: 35 mm



Width: 45 mm



Technical data

Polyamide / V0

Ordering data

Type	Order No.	Pcs. / Pkt.
ME 22,5 OTU-MKDSO GN	2278966	10
ME 22,5 OT-1MSTBO GN	2709558	10
ME 22,5 OT-MSTBO GN	2907169	10
ME 22,5 OT-3MSTBO GN	2735962	10
ME 22,5 OT-FKDSO KMGY	2200323	10
ME 22,5 OTU-MKDSO KMGY	2278953	10
ME 22,5 OT-1MSTBO KMGY	2914877	10
ME 22,5 OT-MSTBO KMGY	2907761	50
ME 22,5 OT-3MSTBO KMGY	2914880	10
ME 22,5 OTP-MSTBO PS KMGY	2279282	10
ME 22,5 PLATE-MSTBO KMGY	2279279	10
ME 22,5 OT-1MSTBO SET	2707741	1
ME 22,5 OT-MSTBO SET	2907444	1
ME 22,5 OT-3MSTBO SET	2707767	1
ME 22,5 OT-MKDSO SET	2907473	1

Technical data

Polyamide / V0

Ordering data

Type	Order No.	Pcs. / Pkt.
ME 17,5 OTU-MKDSO GN	2278872	10
ME 35 OT-MSTBO GN	2709639	10
ME 17,5 OT-FKDSO KMGY	2200322	10
ME 17,5 OTU-MKDSO KMGY	2278940	10
ME 35 OT-MSTBO KMGY	2914864	10
ME 17,5 OTP-MSTBO PS KMGY	2279253	10
ME 17,5 PLATE-MSTBO KMGY	2279266	10
ME 35 OT-MSTBO SET	2707738	1
ME 17,5 OT-MKDSO SET	2907460	1

Technical data

Polyamide / V0

Ordering data

Type	Order No.	Pcs. / Pkt.
ME 45 OTU-MKDSO GN	2279826	10
ME 45 OT-1MSTBO GN	2709192	10
ME 45 OT-MSTBO GN	2909743	10
ME 45 OT-FKDSO KMGY	2200327	10
ME 45 OTU-MKDSO KMGY	2279923	10
ME 45 OT-1MSTBO KMGY	2709299	10
ME 45 OT-MSTBO KMGY	2854429	10
ME 22,5 OTP-MSTBO PS KMGY	2279282	10
ME 22,5 PLATE-MSTBO KMGY	2279279	10
ME 45 OT-1MSTBO SET	2707754	1
ME 45 OT-MSTBO SET	2909905	1
ME 45 OT-MKDSO SET	2909345	1

Modular component housing for industrial electronics

Upper parts for ME modular component housing

More housing dimensions, the layout of the PCBs, their dimensions and assembly areas can be found in the download center at: www.phoenixcontact.net/products

Notes:
Marking systems and mounting materials: see Catalog 5.
At least one COMBICON base strip or one PCB terminal block must be mounted on each side of the PCB.
For PCB connection technology, see page 656.
For accessories, refer to page: 674.



Width: 67.5 mm



Width = 90 mm

	Technical data			Technical data		
Type of housing	Polyamide / V0			Polyamide / V0		
Electronic housings						
	Ordering data			Ordering data		
Description	Type	Order No.	Pcs. / Pkt.	Type	Order No.	Pcs. / Pkt.
Housing upper part , for COMBICON connection with 3.5 mm or 5 mm pitch, single-level, color: light gray	ME 67,5 OT-1MSTBO KMGY	2200522	10	ME 90 OT-1MSTBO KMGY	2200523	10

Upper parts ME...

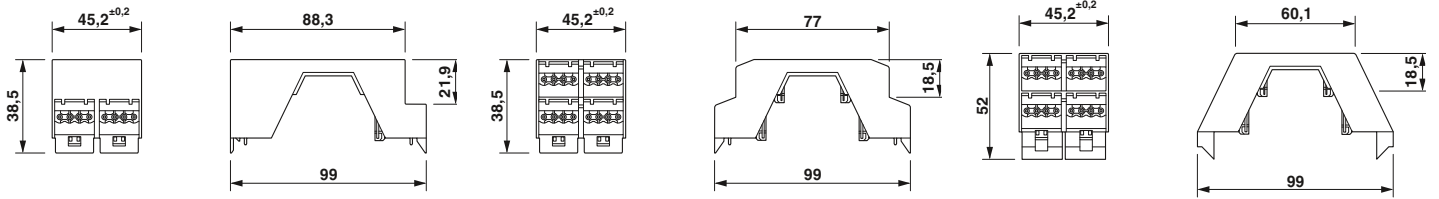

Side view ME...OT-1MSTBO

Side view ME...OT-MSTBO

Side view ME...OT-MKDSO

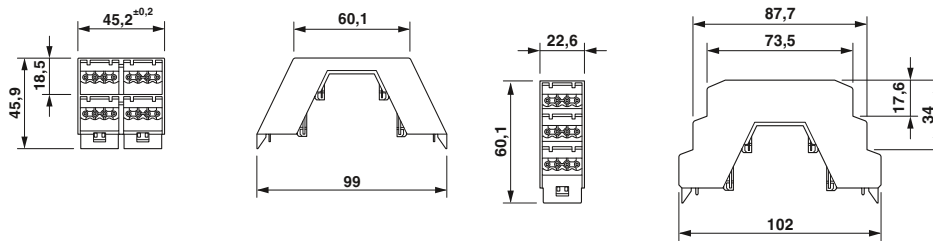

Side view ME...OT-FKDSO

Side view ME...OT-3MSTBO

Accessories for the ME housing



An extensive range of accessories is available for the ME housing range so that functions can be extended in precise accordance with requirements.

These include:

- ME B... filler plugs for closing unused terminal points. One filler plug is required for each terminal point
- ME...UTM intermediate elements and ME MF metal foot to increase the housing width
- ME PS... plug snap connector ejector with marking option in conjunction with ME...OTP-MSTBO PS upper housing parts
- ESL marking strips for ME PS ejector
- EML... labels to match housing contour for device-specific labels
- ME SAS shield connection clamp for potential connection of shielded cables

Notes:
Marking systems and mounting materials: see Catalog 5.
At least one COMBICON base strip or one PCB terminal block must be mounted on each side of the PCB.
For PCB connection technology, see page 656.



Accessories for ME 12,5



Ordering data

Description	Type	Order No.	Pcs. / Pkt.
Filler plug , for unoccupied terminal points, color: green			
For upper part of COMBICON, single and double-level For upper part of a PCB terminal block, double-level	ME B-12,5 MSTBO GN ME B-12,5 MKDSO GN	2906856 2906872	10 10
For upper part of COMBICON, three-level, two pieces required per terminal point			
Filler plug , for unused terminal points, color: light gray			
For upper part of COMBICON, single and double-level For upper part of a PCB terminal block, double-level	ME B-12,5 MSTBO KMGY	2854801	10
For upper part of spring-cage PCB terminal block, double-level	ME B-12,5 FKDSO KMGY	2200565	50
For upper part of COMBICON, three-level, 2 required for each 22.5 mm terminal point			
Intermediate element , for modular extension of the housing volume, 17.5 /22.5 mm pitch, color: green			
with vents without vents			
Plug snap ejector for COMBICON plug-in connectors for use with ME...OTP-MSTBO PS upper housing parts			
for MC connector for FMC connector for FKCT connector For MSTBT connector For TVFKCL connector For TVFKC connector			
Insert strips for Plug Snap, 1 sheet = 580 or 440 insert strips			
Thermal transfer label , material provided on rolls (1 roll = 200 labels), suitable for the side element of:			
ME ... UT ...	EML (44X76)R-ME	0828130	1
ME ... F-UT ...	EML (44X53)R-ME	0828156	1
ME ... SF-UT ...	EML (29X29)R-ME	0828172	1
ME ... UT ... BUS ...	EML (44X64)R-ME	0828266	1
ME ... F-UT ... BUS ...	EML (44X42)R-ME	0828279	1
ME ... UT ... TBUS ...	EML (44X72)R-ME	0828143	1
ME ... F-UT ... TBUS ...	EML (44X49)R-ME	0828169	1
Metal foot catch for intermediate element			
Shield connection clamp for PCB terminal block			
	ME-SAS	2853899	10
Coding section for MSTBO headers, is inserted into the recess on the header			
	CR MSTBO-G1	2199618	100
Coding profile , for COMBICON headers, is inserted into the slot on the plug, red insulating material			
	CP-MSTB	1734634	100



Accessories for ME 17,5



Accessories for ME 22,5



Ordering data			Ordering data		
Type	Order No.	Pcs. / Pkt.	Type	Order No.	Pcs. / Pkt.
ME B-17,5 MSTBO GN	2906869	10	ME B-22,5 MSTBO GN	2907156	10
ME B-17,5 MKDSO GN	2906885	10	ME B-22,5 MKDSO GN	2907143	10
			ME B-12,5 3MSTBO GN	2709176	50
ME B-17,5 MSTBO KMGY	2853776	10	ME B-22,5 MSTBO KMGY	2907965	50
ME B-17,5 MKDSO KMGY	2854115	10	ME B-22,5 MKDSO KMGY	2908498	10
ME B-17,5 FKDSO KMGY	2200566	50	ME B-22,5 FKDSO KMGY	2200567	50
			ME B-12,5 3MSTBO KMGY	2279787	50
ME 35 UTM	2908265	10	ME 45 UTM GN	2853404	10
ME 35 UTMG	2908275	10	ME 45 UTMG GN	2853417	10
ME PS-17,5 MC TRANS	2279842	50	ME PS-22,5 MC TRANS	2279745	50
ME PS-17,5 FMC TRANS	2279949	50	ME PS-22,5 FMC TRANS	2279648	50
			ME PS-22,5 FKCT TRANS	2279046	50
			ME PS-22,5 MSTBT TRANS	2279062	50
			ME PS-22,5 TVFKCL TRANS	2279088	50
			ME PS-22,5 TVFKC TRANS	2279075	50
ESL 15X5	0822592	10	ESL 20X5	0822589	10
EML (44X76)R-ME	0828130	1	EML (44X76)R-ME	0828130	1
EML (44X53)R-ME	0828156	1	EML (44X53)R-ME	0828156	1
EML (29X29)R-ME	0828172	1	EML (29X29)R-ME	0828172	1
EML (44X64)R-ME	0828266	1	EML (44X64)R-ME	0828266	1
EML (44X42)R-ME	0828279	1	EML (44X42)R-ME	0828279	1
EML (44X72)R-ME	0828143	1	EML (44X72)R-ME	0828143	1
EML (44X49)R-ME	0828169	1	EML (44X49)R-ME	0828169	1
ME MF 17,5	2908281	50	ME MF 17,5	2908281	50
ME-SAS	2853899	10	ME-SAS	2853899	10
CR MSTBO-G1	2199618	100	CR MSTBO-G1	2199618	100
CP-MSTB	1734634	100	CP-MSTB	1734634	100

TBUS DIN rail connector



For ME and ME MAX housing ranges

- Equally suitable for both housing ranges
- For housing widths of 6.2 mm, 17.5 mm, and 22.5 mm and multiples thereof
- Snap-on mounting on standard DIN rail NS 35/7,5 or NS 35/15

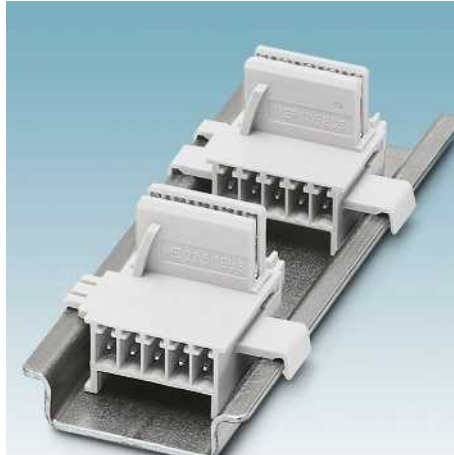

Automatic contacting

- For parallel data transmission and power supply (125 V, 8 A)
- 5-pos.
- Gold-plated contacts
- “Self-constructing” contact chain in the housing pitch

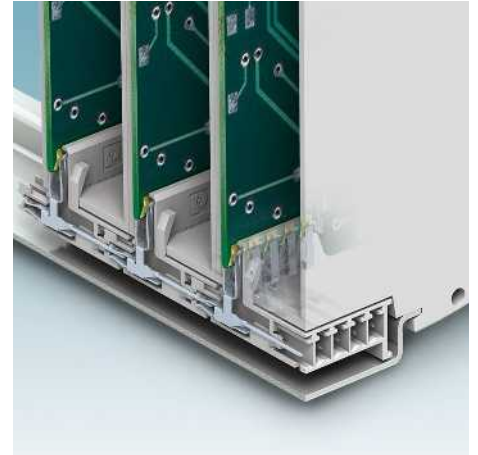

Direct plug-in technology

- When the devices are snapped on, the contact points on the PCB slide directly into the gold-plated contact forks of the bus connector



Signal supply

- MINI COMBICON plug-in connectors are used for the signal supply
- Supply clip for strain relief



Individual modules can be unplugged

- When a device is unplugged from the topology, the signal string is not interrupted

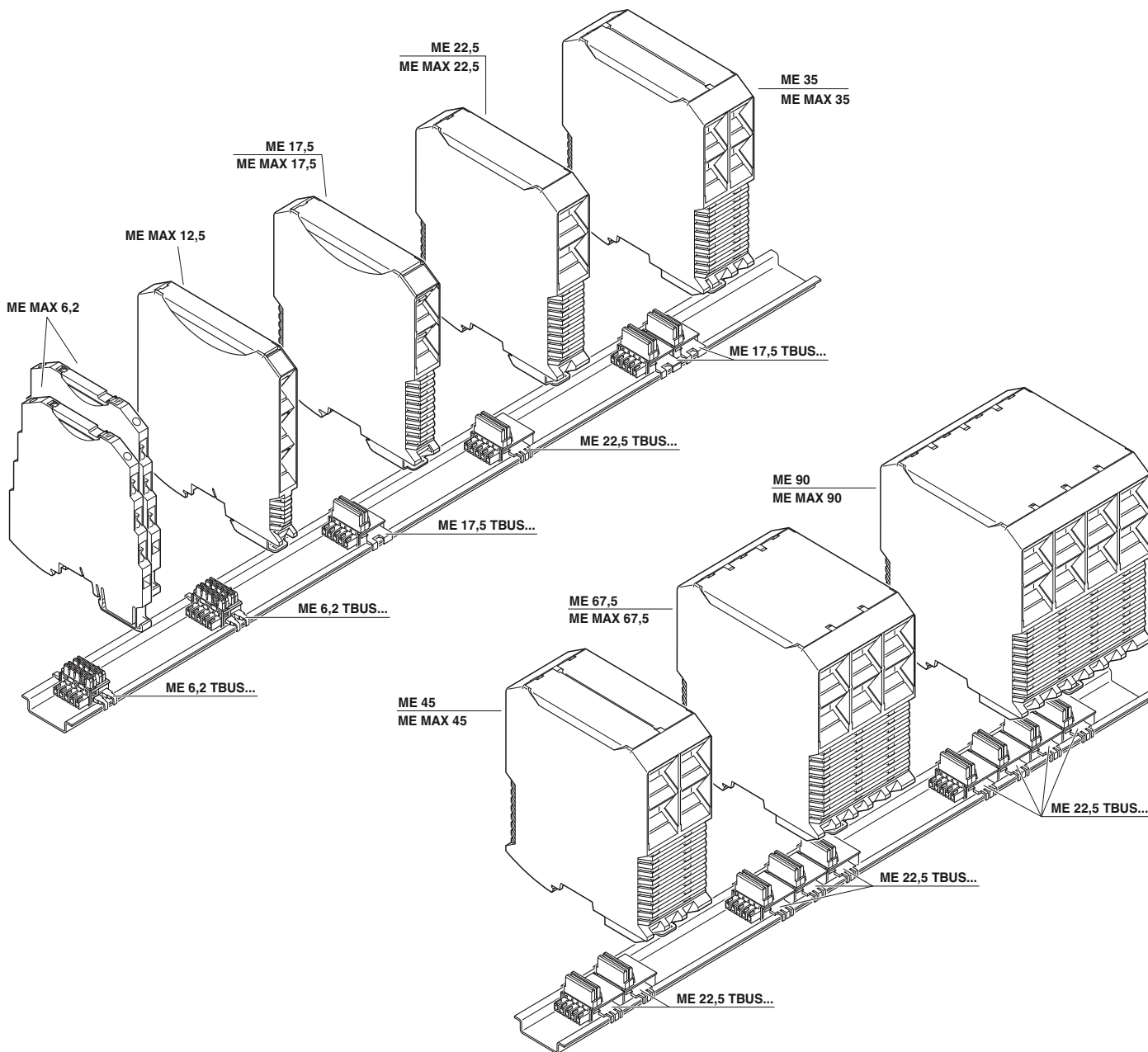

	ME MAX 6,2 Page 682	ME MAX 12,5 Page 684	ME 17,5 Page 666 ME MAX 17,5 Page 685	ME 22,5 Page 667 ME MAX 22,5 Page 686	ME 35 Page 667 ME MAX 35 Page 687	ME 45 Page 668 ME MAX 45 Page 688	ME 67,5 Page 669 ME MAX 67,5 Page 689	ME 90 Page 669 ME MAX 90 Page 690
ME 6,2 TBUS-2,5/5-ST-3,81 KMGY (2969401)	2 housings can be mounted on one TBUS	1 TBUS required per housing						
ME 17,5 TBUS-1,5/5-ST-3,81 KMGY (2713645)			1 TBUS required per housing		2 TBUS required per housing			
ME 22,5 TBUS-1,5/5-ST-3,81 KMGY (2713722)				1 TBUS required per housing		2 TBUS required per housing	3 TBUS required per housing	4 TBUS required per housing

ME MAX electronics housing



ME MAX U-U1 version electronics housings provide a connection level on one side of the housing combined with a universal cover. The other side of the housing is completely closed with a universal cover. This version is available in design widths from 17.5 up to 90 mm, either with or without vents. The height of the housing is 114.5 mm.



ME MAX 2-2 version electronics housings provide 2 connection levels on each side of the housing. This version is available in design widths from 17.5 up to 90 mm, either with or without vents. The height of the housing is 114.5 mm.



ME MAX 2-2 version electronics housings are also available in a super-flat design. This version is available in design widths of 17.5 mm, 22.5 mm, and 45 mm. The height of the housing is 70.4 mm.



ME MAX 3-3 version electronics housings provide 3 connection levels on each side of the housing. This version is available in design widths from 12.5 up to 90 mm, either with or without vents. The height of the housing is 114.5 mm.



ME MAX 3-3 version electronics housings are also available in a flat design. This version is available in design widths of 22.5 mm and 45 mm. The height of the housing is 92 mm.



ME MAX 6,2 version electronics housings provide 4 connection levels on each side of the housing. The connection technology, which is available in screw or spring-cage format, is firmly integrated in the housing. The height of the housing is 102.5 mm.



Mounting principle

Electronic components and PCB connection technology can be assembled and soldered in a single step. Once the assembled PCB has been inserted into the narrow housing half-shell, the second housing half-shell is simply snapped on.



Next, the fitted cover is inserted and the transparent cover is mounted. Finally, the metal foot catch is added.

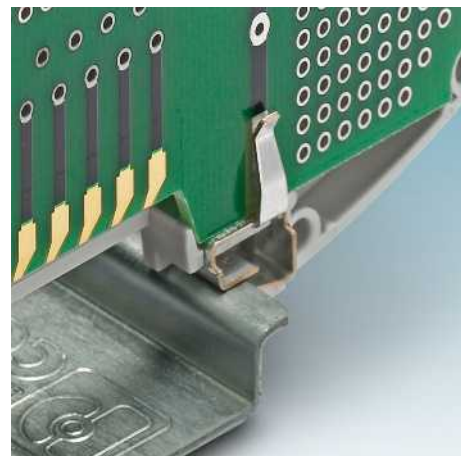

Functional earth ground contact

A functional earth ground contact is available to improve electromagnetic compatibility. It connects the inserted PCB directly to the grounded DIN rail.



Function-oriented design

The housing has a large front surface for high-position connectors or operating and setting elements. The fitted cover can be easily modified, labeled, and even removed using a tool if necessary. The hinged transparent cover adds the final touch. The printing is thereby shielded against harmful environmental influences; the setting elements are protected effectively.

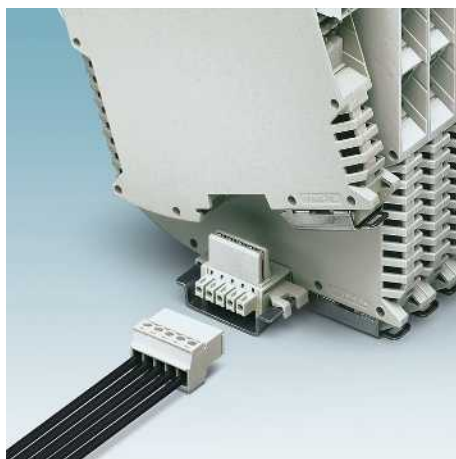

DIN rail connectors

The ME...TBUS connector snaps onto all standard NS 35/7.5 or NS 35/15 DIN rails taking up the minimum of space and providing a convenient means of wiring signal and supply voltages.

The bus connection is “self-constructing”, adopting the same pitch as the devices. Snap on the connector, swivel the modules, and you're done! Complex pre-configuration or reworking of the bus connection on site are a thing of the past.

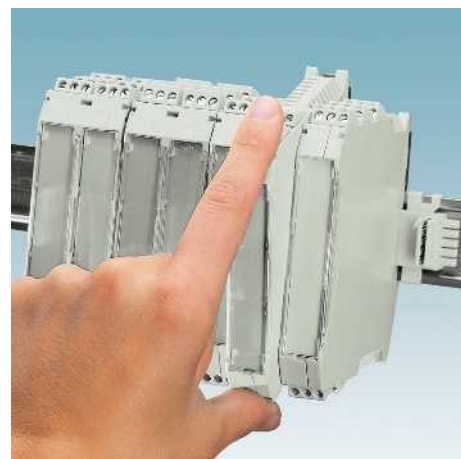



Removing individual modules from the topology



The design allows individual devices to be swung out of the module group. The contact chain is not interrupted.





Gold-plated contacts ensure the required level of transmission reliability. The familiar MINI COMBICON plug-in connectors from Phoenix Contact are suitable for the signal supply.

Electronics housing for industrial electronics and semi-industrial applications

Modular component housing for industrial electronics

ME MAX housing	Type	Page	Width [mm]	PCB terminal block			
				3.5 mm pitch MKDSO 1,5/...3,5 Page 89	Screw 5 mm pitch MKDSO 2,5/... Page 113	7.5 mm pitch MKDSO 2,5 HV...7,5 Page 125	Push-in 5 mm pitch FKDSO 2,5/... Page 153
	ME MAX 12,5...	684	12.5	• 3-pos.	• 2-pos.		• 2-pos.
	ME MAX 17,5...	685	17.5	• 4-pos.	• 3-pos.	• 2-pos.	• 3-pos.
	ME MAX 22,5...	686	22.5	• 5-pos.	• 4-pos.	• 3-pos.	• 4-pos.
	ME MAX 35...	687	35	• 4-pos.	• 3-pos.	• 2-pos.	• 3-pos.
	ME MAX 45...	688	45	• 5-pos.	• 4-pos.	• 3-pos.	• 4-pos.
	ME MAX 67,5...	689	67.5	• 5-pos.	• 4-pos.	• 3-pos.	• 4-pos.
	ME MAX 90...	690	90	• 5-pos.	• 4-pos.	• 3-pos.	• 4-pos.
	ME MAX 22,5 F...	686	22.5	• 5-pos.	• 4-pos.	• 3-pos.	• 4-pos.
	ME MAX 45 F...	688	45	• 5-pos.	• 4-pos.	• 3-pos.	• 4-pos.
	ME MAX 17,5 SF...	685	17.5	• 4-pos.	• 3-pos.	• 2-pos.	• 3-pos.
	ME MAX 22,5 SF...	686	22.5	• 5-pos.	• 4-pos.	• 3-pos.	• 4-pos.
	ME MAX 45 SF...	688	45	• 5-pos.	• 4-pos.	• 3-pos.	• 4-pos.

ME MAX housing	Type	Page	Width [mm]	Filler plug		
				ME MAX B-12,5 Page 684	ME MAX B-17,5 Page 685	ME MAX B-22,5 Page 686
	ME MAX 12,5...	684	12.5	•		
	ME MAX 17,5...	685	17.5		•	
	ME MAX 22,5...	686	22.5			•
	ME MAX 35...	687	35		•	
	ME MAX 45...	688	45			•
	ME MAX 67,5...	689	67.5			•
	ME MAX 90...	690	90			•
	ME MAX 22,5 F...	686	22.5			•
	ME MAX 45 F...	688	45			•
	ME MAX 17,5 SF...	685	17.5		•	
	ME MAX 22,5 SF...	686	22.5			•
	ME MAX 45 SF...	688	45			•

COMBICON connection					Number of terminal points
3.5 mm pitch MCO 1.5/...3.5 Page 232	5 mm pitch MSTBO 2.5/... Page 322	Header Pitch: 5, touch proof MSTBO 2.5/...P Page 325	Pitch: 5, THR MSTBO 2.5/...THR UTMG Page 309	7.25 mm pitch GMSTBO 2.5 HV/...THR UTMG Page 510	
					
• 3-pos.	• 2-pos.	• 2-pos.	• 2-pos.		3 per housing side
• 4-pos.	• 3-pos.	• 3-pos.	• 3-pos.	• 2-pos.	Min. 0 to max. 3 per housing side
• 5-pos.	• 4-pos.	• 4-pos.	• 4-pos.	• 3-pos.	Min. 0 to max. 3 per housing side
• 4-pos.	• 3-pos.	• 3-pos.	• 3-pos.	• 2-pos.	Min. 0 to max. 6 per housing side
• 5-pos.	• 4-pos.	• 4-pos.	• 4-pos.	• 3-pos.	Min. 0 to max. 6 per housing side
• 5-pos.	• 4-pos.	• 4-pos.	• 4-pos.	• 3-pos.	Min. 0 to max. 9 per housing side
• 5-pos.	• 4-pos.	• 4-pos.	• 4-pos.	• 3-pos.	Min. 0 to max. 12 per housing side
• 5-pos.	• 4-pos.	• 4-pos.	• 4-pos.	• 3-pos.	3 per housing side
• 5-pos.	• 4-pos.	• 4-pos.	• 4-pos.	• 3-pos.	6 per housing side
• 4-pos.	• 3-pos.	• 3-pos.	• 3-pos.	• 2-pos.	2 per housing side
• 5-pos.	• 4-pos.	• 4-pos.	• 4-pos.	• 3-pos.	2 per housing side
• 5-pos.	• 4-pos.	• 4-pos.	• 4-pos.	• 3-pos.	4 per housing side

Specified number of positions = number of positions per terminal point

Modular component housing for industrial electronics

ME MAX modular component housing

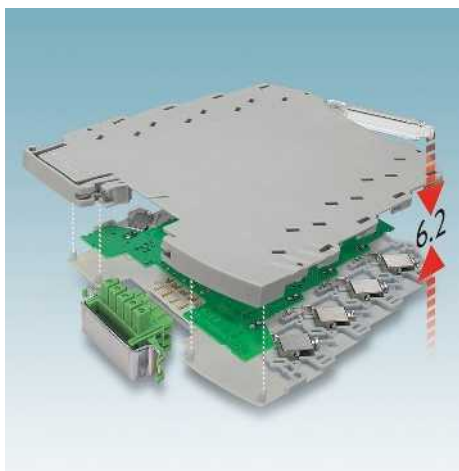

The electronic housings ME MAX 6,2 make it possible to realize individual and space-saving electronics components with a width of 6.2 mm.

The connection technology is firmly integrated in the housing, making it ready to take the components. Eight connections with a cross section of up to 2.5 mm² are available over four levels. These are available either as SCrew connection (SC) or in spring-cage technology (SP).

Simple through-contacting

The DIN rail bus connectors are simply pushed into the DIN rail and snapped together. All signals contact automatically when the housing is snapped on. When the device is removed from the whole, the contact chain is not interrupted.

Further advantages:

- The same PCB geometry for spring-cage and screw versions
- Housing can be laser printed with conventional laser systems
- Simple device tests, thanks to integrated test openings
- Transparent front cover can be swiveled, reversed, and labeled
- IP20 shock protection

More housing dimensions, the layout of the PCBs, their dimensions and assembly areas can be found in the download center at:
www.phoenixcontact.net/products

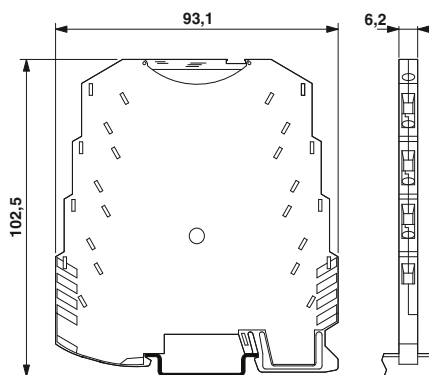

8-pos. with screw connection, width: 6.2 mm



Type of housing	Electronic housings
Stripping length	12 mm
Connection data	solid stranded

Technical data				
PBT / V0				
12 mm				
	solid	stranded	I	U
		[mm ²]	[A]	[V]
	0.2 - 2.5	0.2 - 2.5	26 - 12	8 250

Description	Electronic housings
For DIN rail bus connector	

Ordering data		
Type	Order No.	Pcs. / Pkt.
ME MAX 6,2 SC 4-4 KMGY	2713094	10

DIN rail bus connector, 2 x 5-pos. ¹⁾
Zack flat marker strip, 10-section, unprinted: for individual marking with TML (101X4,2)R TR, X-PEN or CMS-P1 – PLOTTER, sufficient for marking 100 terminal blocks per pack
Marker pen, refillable, for manual marking, 0.35 mm line thickness, can be refilled with CMS-INK-TR-C 5, delivered without ink
Screwdriver

Accessories		
ZBF 6:UNBEDRUCKT	0808710	10
X-PEN 0,35	0811228	1
SZF 1-0,6X3,5	1204517	10

Notes:
The rated connection data refers to untreated conductors without ferrules.
Torque [Nm] 0,5-0,6.
¹⁾ DIN rail connectors see page 676.



8-pos. with spring-cage connection, width: 6.2 mm



8-pos. with screw connection, for DIN rail bus connectors, width: 6.2 mm



8-pos. with spring-cage connection, for DIN rail bus connectors, width: 6.2 mm



Technical data					
PBT / V0					
8 mm					
solid	stranded		I	U	
	[mm ²]	AWG	[A]	[V]	
0.2 - 2.5	0.2 - 2.5	24 - 12	8	250	

Technical data					
PBT / V0					
12 mm					
solid	stranded		I	U	
	[mm ²]	AWG	[A]	[V]	
0.2 - 2.5	0.2 - 2.5	26 - 12	8	250	

Technical data					
PBT / V0					
8 mm					
solid	stranded		I	U	
	[mm ²]	AWG	[A]	[V]	
0.2 - 2.5	0.2 - 2.5	24 - 12	8	250	

Ordering data		
Type	Order No.	Pcs. / Pkt.
ME MAX 6,2 SP 4-4 KMGY	2713104	10

Ordering data		
Type	Order No.	Pcs. / Pkt.
ME MAX 6,2 SC-TBUS 4-4 KMGY	2869634	10

Ordering data		
Type	Order No.	Pcs. / Pkt.
ME MAX 6,2 SP-TBUS 4-4 KMGY	2869647	10

Accessories		
ZBF 6:UNBEDRUCKT	0808710	10
X-PEN 0,35	0811228	1
SZF 1-0,6X3,5	1204517	10

Accessories		
ME 6,2 TBUS-2 1,5/5-ST-3,81KMGY	2969401	10
ZBF 6:UNBEDRUCKT	0808710	10
X-PEN 0,35	0811228	1
SZF 1-0,6X3,5	1204517	10

Accessories		
ME 6,2 TBUS-2 1,5/5-ST-3,81KMGY	2969401	10
ZBF 6:UNBEDRUCKT	0808710	10
X-PEN 0,35	0811228	1
SZF 1-0,6X3,5	1204517	10

Modular component housing for industrial electronics

ME MAX modular component housing

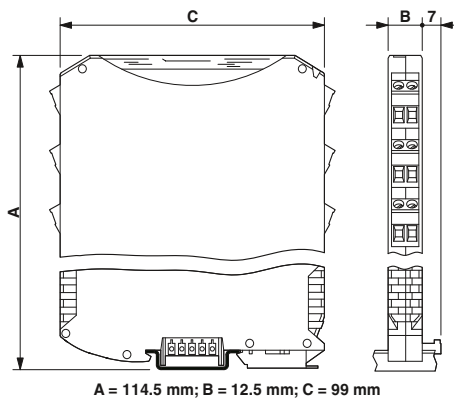

Width: 12.5 mm

The features at a glance:

- Large PCB surface despite compact housing dimensions
- DIN rail bus connector as an option
- Simple exchange of modules without having to break the contact chain
- Permanent or pluggable connection technologies can be mixed on up to three connection levels, with different pitches
- Pluggable connection with screw spring-cage or fast connection technologies
- Large front surface for connectors or operating and setting elements with a high number of positions
- The fitted cover is easy to adapt and print
- The transparent front cover can be swung out
- Functional earth ground contact optional
- labels for additional marking optional

More housing dimensions, the layout of the PCBs, their dimensions and assembly areas can be found in the download center at:

www.phoenixcontact.net/products

Power dissipation P_v at 20°C in horizontal mounting position¹⁾

Mounted in rows without spacing
Mounted in rows with min. 20 mm spacing

Type of housing

Electronic housings

Connection data

MSTBT 2,5/...
MSTBT 2,5 HC/...
MKDSO 2,5/...
ME 6,2 TBUS-2...

Description

Electronic housing, comprising left and right housing shells, front plate, transparent cover, metal foot catch and spring

6x2 positions, without vents, with TBUS option
6x2 positions, with vents, with TBUS option

Pin strip for soldering into the PCB, for contacting in DIN rail bus connectors

Box packaging

Tape-on-reel packing

DIN rail bus connector, 2 x 5-pos.⁵⁾ gray

Filler plugs, for unoccupied terminal points

Technical data

ME MAX 12,5
3-3 TBUS
KMGY

4.4 W - - -
8.4 W - - -

Polyamide / V0

	solid	stranded	AWG	I [A]	U [V]
	0.2 - 2.5	0.2 - 2.5	24 - 12	12 ³⁾	250
	0.2 - 2.5	0.2 - 2.5	24 - 12	16 ⁴⁾	250
	0.14 - 2.5	0.14 - 2.5	26 - 14	24 ²⁾	250
	-	-	-	8	125

Ordering data

Type	Order No.	Pcs. / Pkt.
ME MAX 12,5 G 3-3 TBUS KMGY	2279017	10
ME MAX 12,5 3-3 TBUS KMGY	2279020	10

Accessories

ME TBUS PST 1,5/ 5-3,81	2279033	50
ME TBUS PST 1,5/ 5-3,81 THRR32	2914369	440
ME 6,2 TBUS-2 1,5/5-ST-3,81KMGY	2969401	10
ME MAX B-12,5 KMGY	2914660	10

Notes:

For PCB connection technology, see page 680.

¹⁾ For information on power dissipation, see page 770.

²⁾ Please observe the current carrying capacity curves. Further current carrying capacity curves on request.

³⁾ Please observe the derating curves. Derating curves of further combination options on request.

⁴⁾ Please observe the derating curves and laboratory data sheets. Derating curves of further combination options on request.

⁵⁾ DIN rail connectors see page 676.

ME MAX modular component housing

- Notes:**
- Only actuate the TBUS connector when in no load condition. If for operating reasons small loads must be switched, empirical values are available upon request.
 - The connection cross section refers to untreated conductors without ferrules.
 - For PCB connection technology, see page 680.
 - 1) For information on power dissipation, see page 770.
 - 2) As an alternative, the PCB connection system is also available as single-section designs. Versions with spring-cage or fast connection technologies are thus possible.
 - 3) Please observe the current carrying capacity curves. Further current carrying capacity curves on request.
 - 4) Please observe the derating curves. Derating curves of further combination options on request.
 - 5) Please observe the derating curves and laboratory data sheets. Derating curves of further combination options on request.
 - 6) DIN rail connectors see page 676.

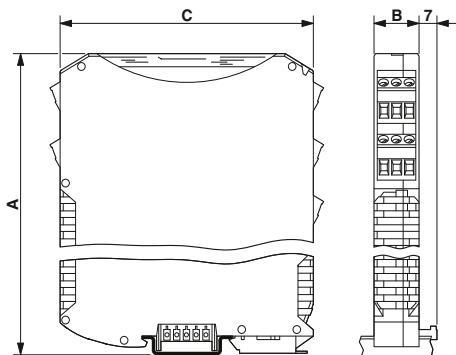

A = 70.4, 114.5 mm; B = 17.5 mm; C = 85 or 99 mm



Width: 17.5 mm



Power dissipation P _V at 20°C in horizontal mounting position ¹⁾	
Mounted in rows without spacing	5.2 W
Mounted in rows with min. 20 mm spacing	10.8 W
Type of housing	
Electronic housings	
Connection data	
MSTBT 2,5/...	
MSTBT 2,5 HC/...	
MKDSO 2,5/...	
ME...TBUS 1,5/...	

Technical data					
ME MAX 17,5 U-U1 KMGY	ME MAX 17,5 G U-U1 KMGY				
5.2 W	4.9 W	-	-		
10.8 W	8.9 W	-	-		
Polyamide / V0					
	solid	stranded	AWG	I [A]	U [V]
		[mm ²]			
	0.2 - 2.5	0.2 - 2.5	24 - 12	12 ⁴⁾	250
	0.2 - 2.5	0.2 - 2.5	24 - 12	16 ⁵⁾	250
	0.14 - 2.5	0.14 - 2.5	26 - 14	24 ³⁾	250
	-	-	-	8	125

Description	Width [mm]
Electronic housing , comprising left and right housing shells, front plate, transparent cover, metal foot catch and spring	
(1 x 3 positions), with vents	
(1 x 3 positions), without vents	
(4 x 3 positions), with vents	
(4 x 3 positions), without vents	
(6 x 3 positions), with vents	
(6 x 3 positions), without vents	
Electronic housing , superflat design, height x depth (70.4 x 85 mm)	
(4 x 3 positions), without vents	

Ordering data		
Type	Order No.	Pcs. / Pkt.
ME MAX 17,5 U-U1 KMGY	2713641	10
ME MAX 17,5 G U-U1 KMGY	2713515	10
ME MAX 17,5 2-2 KMGY	2713599	10
ME MAX 17,5 G 2-2 KMGY	2713609	10
ME MAX 17,5 3-3 KMGY	2713612	10
ME MAX 17,5 G 3-3 KMGY	2713531	10
ME MAX 17,5 SF G 2-2 KMGY	2901369	10

PCB connection technology set for 6 x 3 positions (18-pos.) with a 5 mm pitch ²⁾	
PCB terminal blocks	
COMBICON headers and screw plugs	
PCB , for custom fitting with COMBICON connection technology, for high design (114.5 mm)	
DIN rail bus connector , 5-pos. ⁶⁾	
Filler plugs , for unoccupied terminal points	
Filler plugs for TBUS recess	
Functional earth ground contact , for connection of the PCB to the grounded DIN rail, for ME BUS, ME TBUS and ME MAX housings	
Label sheet for laser printer , for electronic housing ME MAX	
1 sheet = 242 labels	12

Accessories		
Type	Order No.	Pcs. / Pkt.
MKDSO 2,5/ 3-6 SET KMGY	2713735	1
MSTBO 2,5/ 3-6 ST SET KMGY	2713748	1
ME MAX LP SAMPLE MSTBO 2-2	2713777	5
ME 17,5 TBUS 1,5/ 5-ST-3,81 KMGY	2713645	50
ME MAX B-17,5 KMGY	2706959	50
ME MAX TBUS BS KMGY	2199650	50
ME BUS FE CONTACT	2278076	50
BMKLT 14X12 WH	0813789	2

Modular component housing for industrial electronics

ME MAX modular component housing

Notes:
Only actuate the TBUS connector when in no load condition. If for operating reasons small loads must be switched, empirical values are available upon request.
The connection cross section refers to untreated conductors without ferrules.
For PCB connection technology, see page 680.
1) For information on power dissipation, see page 770.
2) As an alternative, the PCB connection system is also available as single-section designs. Versions with spring-cage or fast connection technologies are thus possible.
3) Please observe the current carrying capacity curves. Further current carrying capacity curves on request.
4) Please observe the derating curves. Derating curves of further combination options on request.
5) Please observe the derating curves and laboratory data sheets. Derating curves of further combination options on request.
6) DIN rail connectors see page 676.

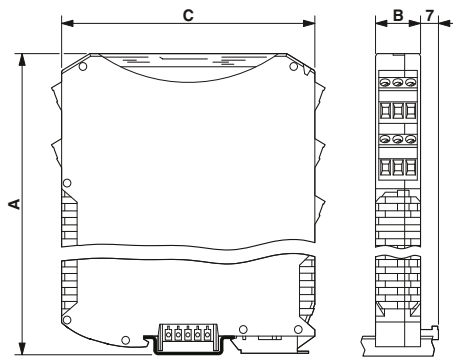

A = 70.4, 92, 114.5 mm; B = 22.5 mm; C = 85, 99 mm



Width: 22.5 mm



Power dissipation P_V at 20°C in horizontal mounting position¹⁾

Mounted in rows without spacing
Mounted in rows with min. 20 mm spacing

Type of housing
Electronic housings
Connection data

MSTBT 2,5/...
MSTBT 2,5 HC/...
MKDSO 2,5/...
ME...TBUS 1,5/...

Technical data				
ME MAX 22,5 U-U1 KMGY	ME MAX 22,5 G U-U1 KMGY	ME MAX 22,5 F G 3-3 KMGY		
6.1 W	5.7 W	5.5 W	-	-
12.1 W	10.1 W	9.6 W	-	-
Polyamide / V0				
solid	stranded		I	U
[mm ²]		AWG	[A]	[V]
0.2 - 2.5	0.2 - 2.5	24 - 12	12 ⁴⁾	250
0.2 - 2.5	0.2 - 2.5	24 - 12	16 ⁵⁾	250
0.14 - 2.5	0.14 - 2.5	26 - 14	24 ³⁾	250
-	-	-	8	125

Description	Width [mm]
Electronic housing , comprising left and right housing shells, front plate, transparent cover, metal foot catch and spring	
(1 x 4 positions), with vents	
(1 x 4 positions), without vents	
(4 x 4 positions), with vents	
(4 x 4 positions), without vents	
(6 x 4 positions), with vents	
(6 x 4 positions), without vents	
Electronic housing , comprising left and right housing shells, front plate, transparent cover, metal foot catch and spring	
Low profile design, Height x depth (92 x 85 mm), (6 x 4 positions), without vents	
Extremely low-profile design, Height x depth (70.4 x 85 mm), (4 x 4 positions), without vents	

Ordering data		
Type	Order No.	Pcs. / Pkt.
ME MAX 22,5 U-U1 KMGY	2713476	10
ME MAX 22,5 G U-U1 KMGY	2713489	10
ME MAX 22,5 2-2 KMGY	2713625	10
ME MAX 22,5 G 2-2 KMGY	2713638	10
ME MAX 22,5 3-3 KMGY	2713939	10
ME MAX 22,5 G 3-3 KMGY	2713942	10
ME MAX 22,5 F G 3-3 KMGY	2869388	10
ME MAX 22,5 SF G 2-2 KMGY	2869362	10

PCB connection technology set for 6 x 4 positions (24-pos.) with a 5 mm pitch ²⁾	
PCB terminal blocks COMBICON headers and screw plugs	
PCB , for custom fitting with COMBICON connection technology, for high design (114.5 mm)	
DIN rail bus connector , 5-pos. ⁶⁾	
Filler plugs , for unoccupied terminal points	
Filler plugs for TBUS recess	
Functional earth ground contact , for connection of the PCB to the grounded DIN rail, for ME BUS, ME TBUS and ME MAX housings	
Label sheet for laser printer , for electronic housing ME MAX	
1 sheet = 176 labels	12

Accessories		
Type	Order No.	Pcs. / Pkt.
MKDSO 2,5/4-6 SET KMGY	2713751	1
MSTBO 2,5/4-6 ST SET KMGY	2713764	1
ME MAX LP SAMPLE MSTBO 2-2	2713777	5
ME 22,5 TBUS 1,5/ 5-ST-3,81 KMGY	2713722	50
ME MAX B-22,5 KMGY	2707929	10
ME MAX TBUS BS KMGY	2199650	50
ME BUS FE CONTACT	2278076	50
BMKLT 19X12 WH	0813792	4

ME MAX modular component housing

Notes:
Only actuate the TBUS connector when in no load condition. If for operating reasons small loads must be switched, empirical values are available upon request.
The connection cross section refers to untreated conductors without ferrules.
For PCB connection technology, see page 680.
1) For information on power dissipation, see page 770.
2) As an alternative, the PCB connection system is also available as single-section designs. Versions with spring-cage or fast connection technologies are thus possible.
3) Please observe the current carrying capacity curves. Further current carrying capacity curves on request.
4) Please observe the derating curves. Derating curves of further combination options on request.
5) Please observe the derating curves and laboratory data sheets. Derating curves of further combination options on request.
6) DIN rail connectors see page 676.

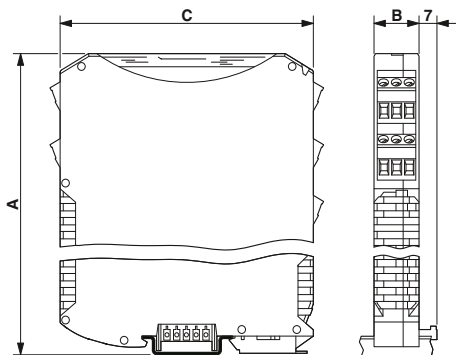

A = 114.5 mm; B = 35 mm; C = 99 mm,



Width: 35 mm



Power dissipation P_V at 20°C in horizontal mounting position¹⁾
Mounted in rows without spacing
Mounted in rows with min. 20 mm spacing
Type of housing
Electronic housings
Connection data
MSTBT 2,5/...
MSTBT 2,5 HC/...
MKDSO 2,5/...
ME...TBUS 1,5/...

Technical data					
ME MAX 35 U- U1 KMGY	ME MAX 35 G U-U1 KMGY				
7.9 W	7.5 W	-	-		
16.3 W	13.8 W	-	-		
Polyamide / V0					
	solid	stranded	AWG	I [A]	U [V]
	[mm ²]				
	0.2 - 2.5	0.2 - 2.5	24 - 12	12 ⁴⁾	250
	0.2 - 2.5	0.2 - 2.5	24 - 12	16 ⁵⁾	250
	0.14 - 2.5	0.14 - 2.5	26 - 14	24 ³⁾	250
	-	-	-	8	125

Description	Width [mm]
Electronic housing , comprising left and right housing shells, 2 front plates, 2 transparent covers, intermediate element, metal foot catch and spring	
(2 x 3 positions), with vents	
(2 x 3 positions), without vents	
(8 x 3 positions), with vents	
(8 x 3 positions), without vents	
(12 x 3 positions), with vents	
(12 x 3 positions), without vents	
Electronic housing , as above, but with a wide transparent cover and a wide front plate	
(8 x 3 positions), with vents	
(12 x 3 positions), with vents	

Ordering data		
Type	Order No.	Pcs. / Pkt.
ME MAX 35 U-U1 KMGY	2713667	10
ME MAX 35 G U-U1 KMGY	2713528	10
ME MAX 35 2-2 KMGY	2713670	10
ME MAX 35 G 2-2 KMGY	2713683	10
ME MAX 35 3-3 KMGY	2713696	10
ME MAX 35 G 3-3 KMGY	2713544	10
ME MAX 35 LC 2-2 KMGY	2200597	10
ME MAX 35 LC 3-3 KMGY	2200596	10

PCB connection technology set for 6 x 3 positions (18-pos.) with a 5 mm pitch ²⁾
PCB terminal blocks
COMBICON headers and screw plugs
PCB , for custom fitting with COMBICON connection technology, for high design (114.5 mm)
DIN rail bus connector , 5-pos. ⁶⁾
Filler plugs , for unoccupied terminal points
Filler plugs for TBUS recess
Functional earth ground contact , for connection of the PCB to the grounded DIN rail, for ME BUS, ME TBUS and ME MAX housings
Label sheet for laser printer , for electronic housing ME MAX
1 sheet = 110 labels

Accessories		
Type	Order No.	Pcs. / Pkt.
MKDSO 2,5/ 3-6 SET KMGY	2713735	1
MSTBO 2,5/ 3-6 ST SET KMGY	2713748	1
ME MAX LP SAMPLE MSTBO 2-2	2713777	5
ME 17,5 TBUS 1,5/ 5-ST-3,81 KMGY	2713645	50
ME MAX B-17,5 KMGY	2706959	50
ME MAX TBUS BS KMGY	2199650	50
ME BUS FE CONTACT	2278076	50
BMKLT 31,5X12 WH	0813802	4

Modular component housing for industrial electronics

ME MAX modular component housing

Notes:
Only actuate the TBUS connector when in no load condition. If for operating reasons small loads must be switched, empirical values are available upon request.
The connection cross section refers to untreated conductors without ferrules.
For PCB connection technology, see page 680.
1) For information on power dissipation, see page 770.
2) As an alternative, the PCB connection system is also available as single-section designs. Versions with spring-cage or fast connection technologies are thus possible.
3) Please observe the current carrying capacity curves. Further current carrying capacity curves on request.
4) Please observe the derating curves. Derating curves of further combination options on request.
5) Please observe the derating curves and laboratory data sheets. Derating curves of further combination options on request.
6) DIN rail connectors see page 676.

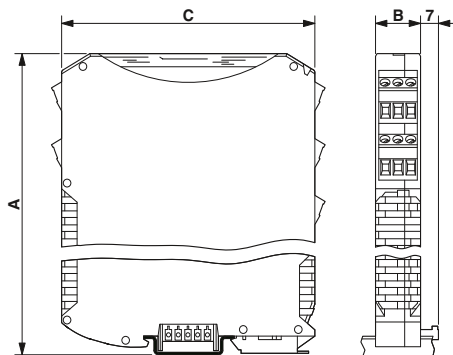

A = 70.4, 92, 114.5 mm; B = 45 mm; C = 85, 99 mm



Width: 45 mm



Power dissipation P _v at 20°C in horizontal mounting position ¹⁾
Mounted in rows without spacing
Mounted in rows with min. 20 mm spacing
Type of housing
Electronic housings
Connection data
MSTBT 2,5/...
MSTBT 2,5 HC/...
MKD50 2,5/...
ME...TBUS 1,5/...

Technical data				
ME MAX 45 U- U1 KMGY	ME MAX 45 G U-U1 KMGY			
8.2 W	7.6 W	-	-	
16.5 W	14.1 W	-	-	
Polyamide / V0				
solid	stranded	AWG	I [A]	U [V]
[mm ²]				
0.2 - 2.5	0.2 - 2.5	24 - 12	12 ⁴⁾	250
0.2 - 2.5	0.2 - 2.5	24 - 12	16 ⁵⁾	250
0.14 - 2.5	0.14 - 2.5	26 - 14	24 ³⁾	250
-	-	-	8	125

Description	Width [mm]
Electronic housing , comprising left and right housing shells, 2 front plates, 2 transparent covers, intermediate element, metal foot catch and spring	
(2 x 4 positions), with vents	
(2 x 4 positions), without vents	
(8 x 4 positions), with vents	
(8 x 4 positions), without vents	
(12 x 4 positions), with vents	
(12 x 4 positions), without vents	
Electronic housing , comprising left and right housing shells, 2 front plates, 2 transparent covers, intermediate element, metal foot catch and spring	
Low profile design, height x depth (92 x 85 mm), (12 x 4 positions), without vents	
Superflat design, height x depth (70.4 x 85 mm), (8 x 4 positions), without vents	
Electronic housing , as above, but with a wide transparent cover and a wide front plate	
(8 x 4 positions), with vents	
(12 x 4 positions), with vents	

Ordering data		
Type	Order No.	Pcs. / Pkt.
ME MAX 45 U-U1 KMGY	2713492	10
ME MAX 45 G U-U1 KMGY	2713502	10
ME MAX 45 2-2 KMGY	2713706	10
ME MAX 45 G 2-2 KMGY	2713719	10
ME MAX 45 3-3 KMGY	2713913	10
ME MAX 45 G 3-3 KMGY	2713926	10
ME MAX 45 F G 3-3 KMGY	2869391	10
ME MAX 45 SF G 2-2 KMGY	2869375	10
ME MAX 45 LC 2-2 KMGY	2200071	10
ME MAX 45 LC 3-3 KMGY	2890179	10

PCB connection technology set for 6 x 4 positions (24-pos.) with a 5 mm pitch ²⁾	
PCB terminal blocks	
COMBICON headers and screw plugs	
PCB, for custom fitting with COMBICON connection technology, for high design (114.5 mm)	
DIN rail bus connector, 5-pos. ⁶⁾	
Filler plugs, for unoccupied terminal points	
Filler plugs for TBUS recess	
Functional earth ground contact, for connection of the PCB to the grounded DIN rail, for ME BUS, ME TBUS and ME MAX housings	
Label sheet for laser printer, for electronic housing ME MAX	
1 sheet = 88 labels	12

Accessories		
Type	Order No.	Pcs. / Pkt.
MKD50 2,5/4-6 SET KMGY	2713751	1
MSTBO 2,5/4-6 ST SET KMGY	2713764	1
ME MAX LP SAMPLE MSTBO 2-2	2713777	5
ME 22,5 TBUS 1,5/ 5-ST-3,81 KMGY	2713722	50
ME MAX B-22,5 KMGY	2707929	10
ME MAX TBUS BS KMGY	2199650	50
ME BUS FE CONTACT	2278076	50
BMKLT 41,5X12 WH	0813815	5

ME MAX modular component housing

Notes:
For PCB connection technology, see page 680.
1) For information on power dissipation, see page 770.
2) As an alternative, the PCB connection system is also available as single-section designs. Versions with spring-cage or fast connection technologies are thus possible.
3) Please observe the current carrying capacity curves. Further current carrying capacity curves on request.
4) Please observe the derating curves. Derating curves of further combination options on request.
5) Please observe the derating curves and laboratory data sheets. Derating curves of further combination options on request.
6) DIN rail connectors see page 676.

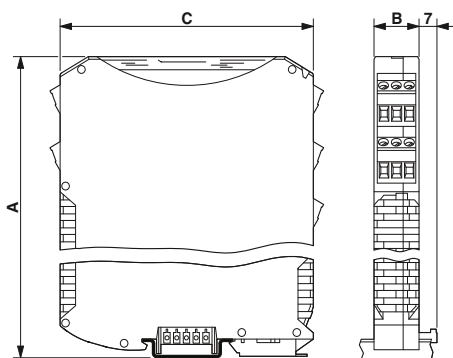

A = 114.5 mm; B = 67.5 mm; C = 99 mm



Width: 67.5 mm

Power dissipation P_V at 20°C in horizontal mounting position¹⁾

Mounted in rows without spacing
Mounted in rows with min. 20 mm spacing

Type of housing
Electronic housings

Connection data

MSTBT 2,5/...
MSTBT 2,5 HC/...
MKDSO 2,5/...
ME...TBUS 1,5/...

Technical data

ME MAX 67,5 U-U1 KMGY	ME MAX 67,5 G U-U1 KMGY				
9.1 W	8.5 W	-	-		
17.5 W	15 W	-	-		
Polyamide / V0					
				I	U
				[A]	[V]
0.2 - 2.5	0.2 - 2.5	24 - 12	12 ⁴⁾	250	
0.2 - 2.5	0.2 - 2.5	24 - 12	16 ⁵⁾	250	
0.14 - 2.5	0.14 - 2.5	26 - 14	24 ³⁾	250	
-	-	-	8	125	

Ordering data

Description	Width [mm]	Type	Order No.	Pcs. / Pkt.
Electronic housing , comprising left and right housing shells, one-piece insertable front plate, one-piece transparent cover, intermediate elements, metal foot catch with spring				
(3 x 4) positions with a 5 mm pitch, with vents		ME MAX 67,5 U-U1 KMGY	2200547	10
(3 x 4) positions with a 5 mm pitch, without vents		ME MAX 67,5 G U-U1 KMGY	2200528	10
(12 x 4) positions with a 5 mm pitch, with vents		ME MAX 67,5 2-2 KMGY	2200524	10
(12 x 4) positions with a 5 mm pitch, without vents		ME MAX 67,5 G 2-2 KMGY	2200525	10
(18 x 4) positions with a 5 mm pitch, with vents		ME MAX 67,5 3-3 KMGY	2200526	10
(18 x 4) positions with a 5 mm pitch, without vents		ME MAX 67,5 G 3-3 KMGY	2200527	10

Accessories

PCB connection technology set for 6 x 4 positions (24-pos.) with a 5 mm pitch ²⁾				
PCB terminal blocks		MKDSO 2,5/4-6 SET KMGY	2713751	1
COMBICON headers and screw plugs		MSTBO 2,5/4-6 ST SET KMGY	2713764	1
PCB , for custom fitting with COMBICON connection technology, for high design (114.5 mm)		ME MAX LP SAMPLE MSTBO 2-2	2713777	5
DIN rail bus connector , 5-pos. ⁶⁾		ME 22,5 TBUS 1,5/ 5-ST-3,81 KMGY	2713722	50
Filler plugs , for unoccupied terminal points		ME MAX B-22,5 KMGY	2707929	10
Filler plugs for TBUS recess		ME MAX TBUS BS KMGY	2199650	50
Functional earth ground contact , for connection of the PCB to the grounded DIN rail, for ME BUS, ME TBUS and ME MAX housings		ME BUS FE CONTACT	2278076	50
Label sheet for laser printer , for electronic housing ME MAX		BMKLT 41,5X12 WH	0813815	5

Modular component housing for industrial electronics

ME MAX modular component housing

Notes:
For PCB connection technology, see page 680.
1) For information on power dissipation, see page 770.
2) As an alternative, the PCB connection system is also available as single-section designs. Versions with spring-cage or fast connection technologies are thus possible.
3) Please observe the current carrying capacity curves. Further current carrying capacity curves on request.
4) Please observe the derating curves. Derating curves of further combination options on request.
5) Please observe the derating curves and laboratory data sheets. Derating curves of further combination options on request.
6) DIN rail connectors see page 676.

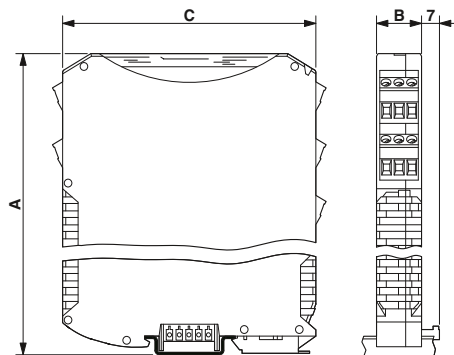

A = 114.5 mm; B = 90 mm; C = 99 mm



Width = 90 mm

Power dissipation P_V at 20°C in horizontal mounting position¹⁾

Mounted in rows without spacing
Mounted in rows with min. 20 mm spacing

Type of housing
Electronic housings
Connection data

MSTBT 2,5/...
MSTBT 2,5 HC/...
MKDSO 2,5/...
ME...TBUS 1,5/...

Technical data

ME MAX 90 U- U1 KMGY	ME MAX 90 G U-U1 KMGY		
10.4 W	9.7 W	-	-
18.9 W	16.4 W	-	-

Polyamide / V0				
solid	stranded	AWG	I [A]	U [V]
0.2 - 2.5	0.2 - 2.5	24 - 12	12 ⁴⁾	250
0.2 - 2.5	0.2 - 2.5	24 - 12	16 ⁵⁾	250
0.14 - 2.5	0.14 - 2.5	26 - 14	24 ³⁾	250
-	-	-	8	125

Description	Width [mm]
Electronic housing , comprising left and right housing shells, one-piece insertable front plate, one-piece transparent cover, intermediate elements, metal foot catch with spring	
(4 x 4) positions with 5 mm pitch, with vents	
(4 x 4) positions with 5 mm pitch, without vents	
(16 x 4) positions with 5 mm pitch, with vents	
(16 x 4) positions with 5 mm pitch, without vents	
(24 x 4) positions with 5 mm pitch, with vents	
(24 x 4) positions with 5 mm pitch, without vents	

Ordering data

Type	Order No.	Pcs. / Pkt.
ME MAX 90 U-U1 KMGY	2200546	10
ME MAX 90 G U-U1 KMGY	2200533	10
ME MAX 90 2-2 KMGY	2200529	10
ME MAX 90 G 2-2 KMGY	2200530	10
ME MAX 90 3-3 KMGY	2200531	10
ME MAX 90 G 3-3 KMGY	2200532	10

PCB connection technology set for 6 x 4 positions (24-pos.) with a 5 mm pitch²⁾

PCB terminal blocks
COMBICON headers and screw plugs

PCB, for custom fitting with COMBICON connection technology, for high design (114.5 mm)

DIN rail bus connector, 5-pos.⁶⁾

Filler plugs, for unoccupied terminal points

Filler plugs for TBUS recess

Functional earth ground contact, for connection of the PCB to the grounded DIN rail, for ME BUS, ME TBUS and ME MAX housings

Label sheet for laser printer, for electronic housing ME MAX

1 sheet = 88 labels 12

Accessories

MKDSO 2,5/4-6 SET KMGY	2713751	1
MSTBO 2,5/4-6 ST SET KMGY	2713764	1
ME MAX LP SAMPLE MSTBO 2-2	2713777	5
ME 22,5 TBUS 1,5/ 5-ST-3,81 KMGY	2713722	50
ME MAX B-22,5 KMGY	2707929	10
ME MAX TBUS BS KMGY	2199650	50
ME BUS FE CONTACT	2278076	50
BMKLT 41,5X12 WH	0813815	5

ME MAX ordering data for delivery quantities < 10 pcs.

Order No.	Type	Pcs. / Pkt.	Description
2201314	ME MAX 17,5 U-U1 KMGY VPE 1	1	Electronics housing, consisting of: left and right housing shells, front plate, transparent cover, metal foot catch and spring, open housing, 3-pos. (1 x 3-pos.), width: 17.5 mm, color: light gray
2201315	ME MAX 17,5 2-2 KMGY VPE 1	1	Electronics housing, consisting of: left and right housing shells, front plate, transparent cover, metal foot catch and spring, open housing, 12-pos. (4 x 3-pos.), width: 17.5 mm, color: light gray
2201316	ME MAX 17,5 3-3 KMGY VPE 1	1	Electronics housing, consisting of: left and right housing shells, front plate, transparent cover, metal foot catch and spring, open housing, 18-pos. (6 x 3-pos.), width: 17.5 mm, color: light gray
2201317	ME MAX 17,5 SF G 2-2 KMGY VPE 1	1	Electronics housing, consisting of: left and right housing shells, front plate, transparent cover, metal foot catch and spring, without vents, 18-pos. (6 x 3-pos.), design: ultra-flat, height x depth (70.4 x 85 mm), width: 17.5 mm, color: light gray
2201318	ME MAX 22,5 U-U1 KMGY VPE 1	1	Electronics housing, consisting of: left and right housing shells, front plate, transparent cover, metal foot catch and spring, open housing, 4-pos. (1 x 4-pos.), width: 22.5 mm, color: light gray
2201319	ME MAX 22,5 2-2 KMGY VPE 1	1	Electronics housing, consisting of: left and right housing shells, front plate, transparent cover, metal foot catch and spring, open housing, 16-pos. (4 x 4-pos.), width: 22.5 mm, color: light gray
2201320	ME MAX 22,5 3-3 KMGY VPE 1	1	Electronics housing, consisting of: left and right housing shells, front plate, transparent cover, metal foot catch and spring, open housing, 24-pos. (6 x 4-pos.), width: 22.5 mm, color: light gray
2201321	ME MAX 22,5 F G 3-3 KMGY VPE 1	1	Electronics housing, consisting of: left and right housing shells, front plate, transparent cover, metal foot catch and spring, closed housing, 24-pos. (6 x 4-pos.), design: flat, width: 22.5 mm, color: light gray
2201322	ME MAX 22,5 SF G 2-2 KMGY VPE 1	1	Electronics housing, consisting of: left and right housing shells, front plate, transparent cover, metal foot catch and spring, closed housing, 16-pos. (4 x 4-pos.), design: ultra-flat, width: 22.5 mm, color: light gray
2201323	ME MAX 35 U-U1 KMGY VPE 1	1	Electronics housing, consisting of: left and right housing shells, 2 x front plate, 2 x transparent cover, intermediate element, metal foot catch and spring, open housing, 6-pos. (2 x 3-pos.), width: 35 mm, color: light gray
2201324	ME MAX 35 LC 2-2 KMGY VPE 1	1	Electronics housing, consisting of: left and right housing shells, one-piece front plate, one-piece transparent cover, intermediate element, metal foot catch and spring, open housing, 24-pos. (8 x 3-pos.), width: 35 mm, color: light gray
2201325	ME MAX 35 LC 3-3 KMGY VPE 1	1	Electronics housing, consisting of: left and right housing shells, one-piece front plate, one-piece transparent cover, intermediate element, metal foot catch and spring, open housing, 36-pos. (12 x 3-pos.), width: 35 mm, color: light gray
2201326	ME MAX 45 U-U1 KMGY VPE 1	1	Electronics housing, consisting of: left and right housing shells, 2 x front plate, 2 x transparent cover, intermediate element, metal foot catch and spring, open housing, 8-pos. (2 x 4-pos.), width: 45 mm, color: light gray
2201328	ME MAX 45 LC 2-2 KMGY VPE 1	1	Electronics housing, consisting of: left and right housing shells, one-piece front plate, one-piece transparent cover, intermediate element, metal foot catch and spring, open housing, 36-pos. (12 x 3-pos.), width: 45 mm, color: light gray
2201329	ME MAX 45 LC 3-3 KMGY VPE 1	1	Electronics housing, consisting of: left and right housing shells, one-piece front plate, one-piece transparent cover, intermediate element, metal foot catch and spring, open housing, 48-pos. (12 x 4-pos.), width: 45 mm, color: light gray
2201330	ME MAX 45 F G 3-3 KMGY VPE 1	1	Electronics housing, consisting of: left and right housing shells, 2 x front plate, 2 x transparent cover, intermediate element, metal foot catch and spring, closed housing, 48-pos. (12 x 4-pos.), design: flat, width: 45 mm, color: light gray
2201331	ME MAX 45 SF G 2-2 KMGY VPE 1	1	Electronics housing, consisting of: left and right housing shells, 2 x front plate, 2 x transparent cover, intermediate element, metal foot catch and spring, closed housing, 32-pos. (8 x 4-pos.), design: ultra-flat, width: 45 mm, color: light gray
2201333	ME MAX 67,5 U-U1 KMGY VPE 1	1	Electronics housing, consisting of: left and right housing shells, one-piece front plate, one-piece transparent cover, intermediate elements, metal foot catch and spring, open housing, 12-pos. (3 x 4-pos.), width: 67.5 mm, color: light gray
2201335	ME MAX 67,5 2-2 KMGY VPE 1	1	Electronics housing, consisting of: left and right housing shells, one-piece front plate, one-piece transparent cover, intermediate elements, metal foot catch and spring, open housing, 48-pos. (12 x 4-pos.), width: 67.5 mm, color: light gray
2201336	ME MAX 67,5 3-3 KMGY VPE 1	1	Electronics housing, consisting of: left and right housing shells, one-piece front plate, one-piece transparent cover, intermediate elements, metal foot catch and spring, open housing, 72-pos. (18 x 4-pos.), width: 67.5 mm, color: light gray
2201337	ME MAX 90 U-U1 KMGY VPE 1	1	Electronics housing, consisting of: left and right housing shells, one-piece front plate, one-piece transparent cover, intermediate elements, metal foot catch and spring, open housing, 16-pos. (4 x 4-pos.), width: 90 mm, color: light gray
2201338	ME MAX 90 2-2 KMGY VPE 1	1	Electronics housing, consisting of: left and right housing shells, one-piece front plate, one-piece transparent cover, intermediate elements, metal foot catch and spring, open housing, 64-pos. (16 x 4-pos.), width: 90 mm, color: light gray
2201339	ME MAX 90 3-3 KMGY VPE 1	1	Electronics housing, consisting of: left and right housing shells, one-piece front plate, one-piece transparent cover, intermediate elements, metal foot catch and spring, open housing, 96-pos. (24 x 4-pos.), width: 90 mm, color: light gray

Modular component housing for industrial electronics

Overview of connector plugs for integrated bus connectors and DIN rail connectors

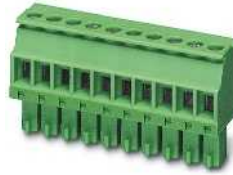

Standard color green



Standard color light gray



Connection data	Technical data					Technical data									
	solid	stranded		I	U	solid	stranded		I	U					
		[mm ²]		AWG	[A]	[V]		[mm ²]		AWG	[A]	[V]			
MCVR 1,5/...	0.14 - 1.5	0.14 - 1.5	28 - 16	8	160	0.14 - 1.5	0.14 - 1.5	28 - 16	8	160	0.14 - 1.5	0.14 - 1.5	28 - 16	8	160
MC 1,5/...	0.14 - 1.5	0.14 - 1.5	28 - 16	8	160	0.14 - 1.5	0.14 - 1.5	28 - 16	8	160	0.14 - 1.5	0.14 - 1.5	28 - 16	8	160
IMC 1,5/ ...	0.14 - 1.5	0.14 - 1.5	28 - 16	8	160	0.14 - 1.5	0.14 - 1.5	28 - 16	8	160	0.14 - 1.5	0.14 - 1.5	28 - 16	8	160

Description	Grid [mm]	No. of pos.	Width [mm]	Ordering data			Ordering data		
				Type	Order No.	Pcs. / Pkt.	Type	Order No.	Pcs. / Pkt.
Plugs for bus connectors, plug-in direction parallel to the conductor axis, gold-plated contacts									
	3.81	2		MCVR 1,5/ 2-ST-3,81 AU	1940680	50	MCVR 1,5/ 5-ST-3,81 GY7035 AU	1719684	50
	3.81	5		MCVR 1,5/ 5-ST-3,81 AU	1893203	50	MCVR 1,5/10-ST-3,81 KMGY AU	1936186	50
	3.81	10		MCVR 1,5/10-ST-3,81 AU	1893216	50			
Plugs for bus connectors, plug-in direction parallel to the PCB axis, gold-plated contacts									
	3.81	2		MC 1,5/ 2-ST-3,81 AU	1851999	50	MC 1,5/ 5-ST-3,81 GY7035 AU	1719697	50
	3.81	5		MC 1,5/ 5-ST-3,81 AU	1860883	50			
	3.81	10		MC 1,5/10-ST-3,81 AU	1879599	50			
Inverted plugs for bus connectors, plug-in direction parallel to the conductor axis, gold-plated contacts									
	3.81	2		IMC 1,5/ 2-ST-3,81 AU	1943263	50	IMC 1,5/ 5-ST-3,81 GY7035 AU	1719707	50
	3.81	5		IMC 1,5/ 5-ST-3,81 AU	1943276	50			
	3.81	10		IMC 1,5/10-ST-3,81 AU	1943289	50			
Terminal cover, 1 strip covers up to 12 terminal points									
For terminal opening (pin)				ME B-KA	2854173	50	ME B-KA KMGY	2706302	50
For plug side (socket)				ME B-SA/NS 35	2935959	10	ME B-SA/NS 35 KMGY	2706700	10
Spacers, for protection of the input or output contacts for DIN rail NS 35									
				ME DH27 NS 35	2908760	50	ME DH 27 NS 35 KMGY	2706289	10
				ME DH36 NS 35	2909895	50	ME DH 36 NS 35 KMGY	2706292	10
Power clip for TBUS plug, for strain relief in connection with MC(VR) 1,5/5-... or IMC 1,5/5-ST-3,81 AU plugs									
							E/ME TBUS NS35 GY	2713780	50

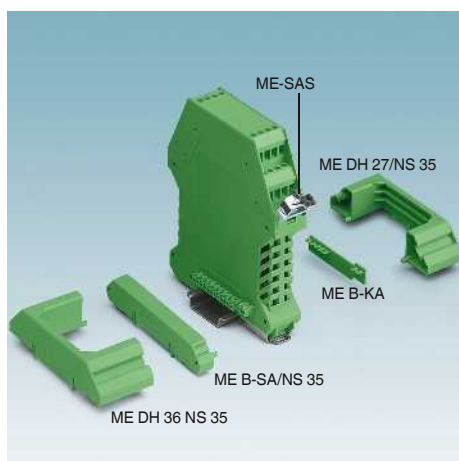
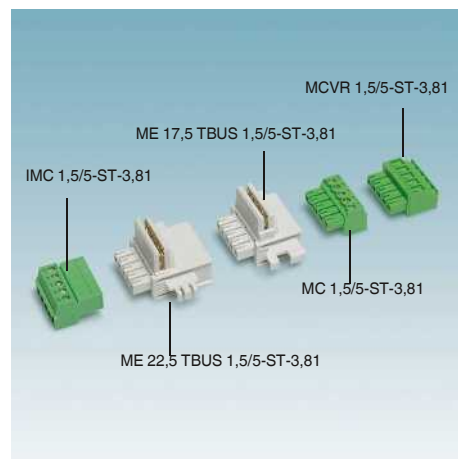
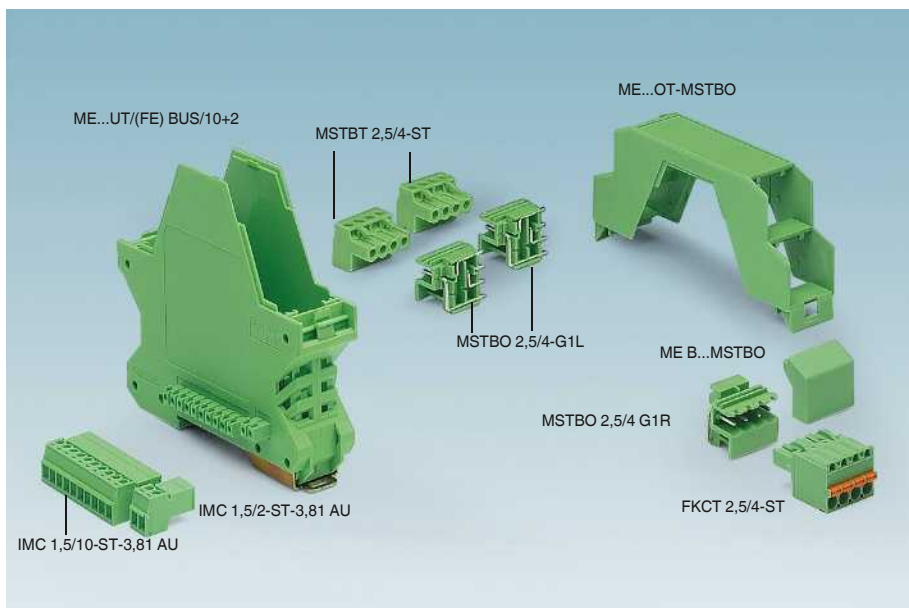

Housing building

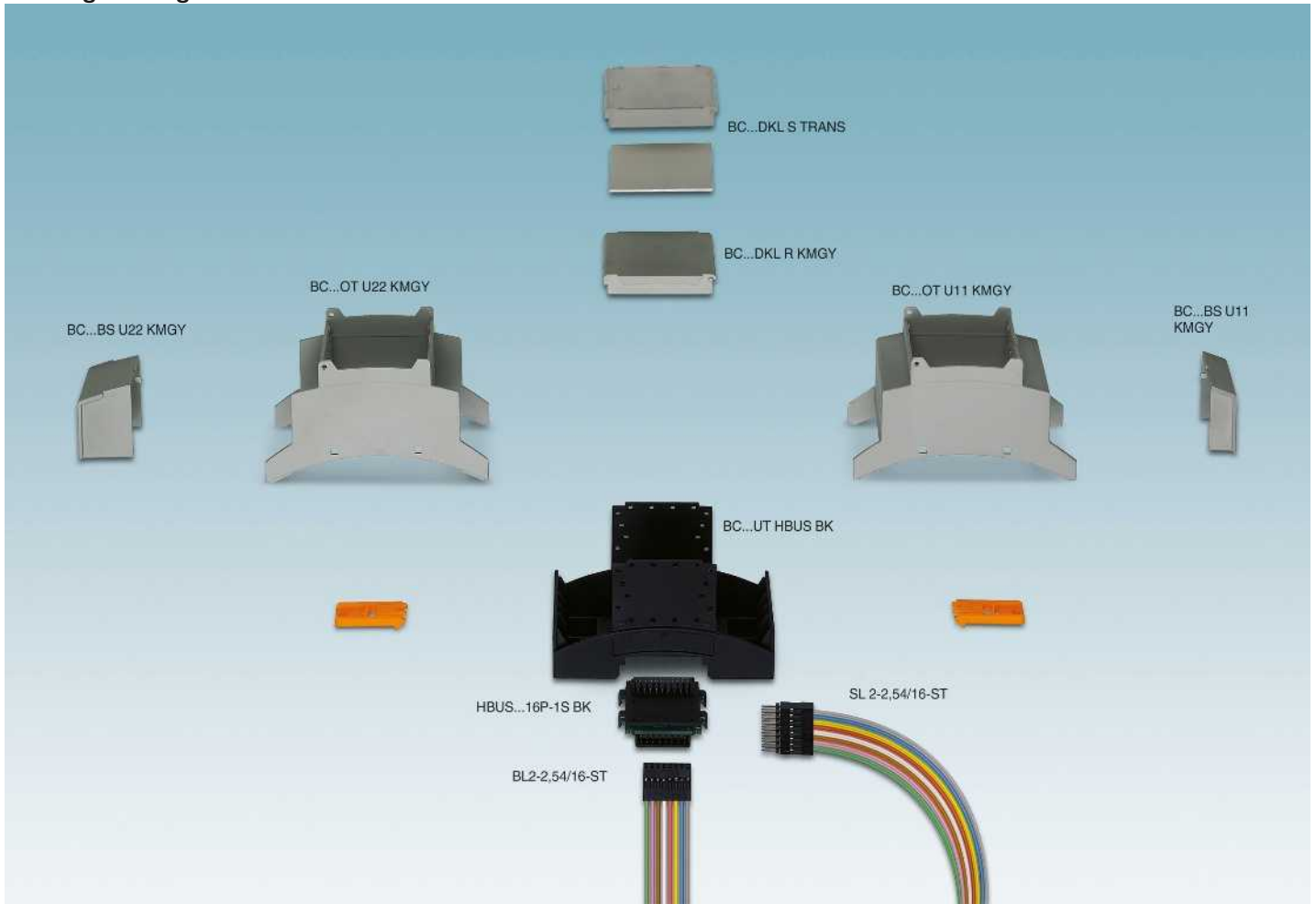

The BC electronic housings have been designed for future-oriented applications in building technology. In addition to the modern design, this housing range offers numerous other features.



The housing complies with DIN 43880, thus guaranteeing problem-free operation in all common distributor boards.

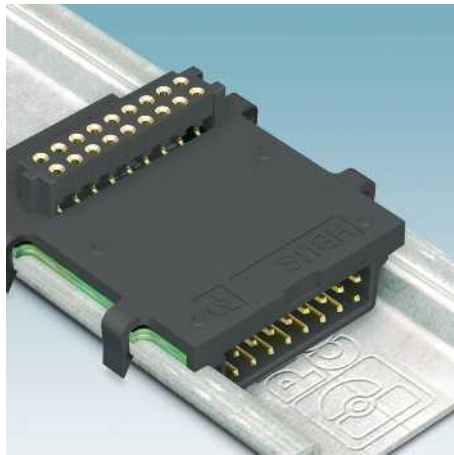

Automatic contacting between devices

The 16-pos. DIN rail connector supports both parallel and serial data transmission plus power supply.

Gold-plated contacts ensure a high level of transmission reliability. They are mounted by simply snapping them onto the DIN rail.

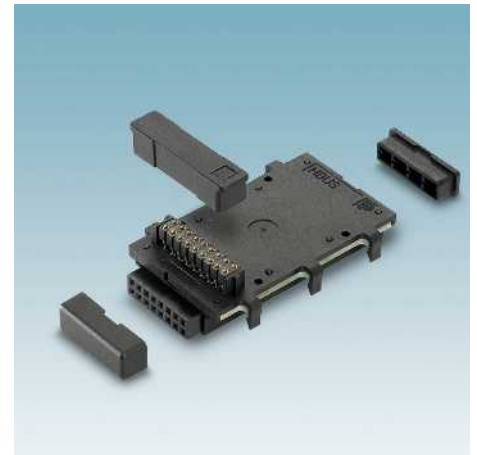

Protection for DIN rail connectors

Cover caps are available to protect unused HBUS DIN rail connectors. They are mounted by simply snapping them on and can be removed by hand or using a screwdriver.

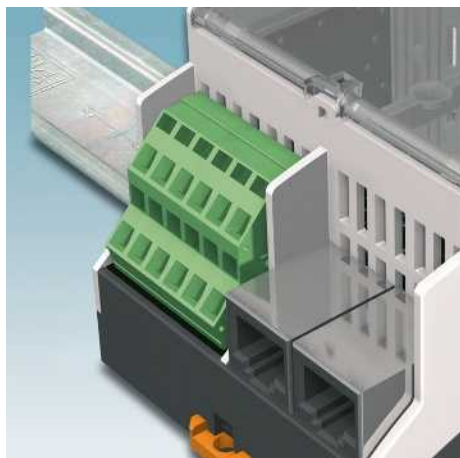

Free selection of corresponding PCB connection technology

BC...U11 housing types with a small clamping space are ideal for the connection technology used in COMBICON compact building technology. If using conventional connection technology or data plug-in connectors, BC...U22 housing versions with a large clamping space are available.

Various cover versions for optimum device design

A transparent cover including fitted cover and a light gray cover, which is the color of the housing, is available for all housing widths. The transparent cover can be swiveled open and is therefore suitable for devices in which indication or operating elements are used.

The fitted cover, which is inserted below the cover, can be labeled easily. The cover can be sealed, thus ensuring the device safety required. The opaque cover is the same color as the housing. It is latched onto the upper part of the housing and cannot be removed.

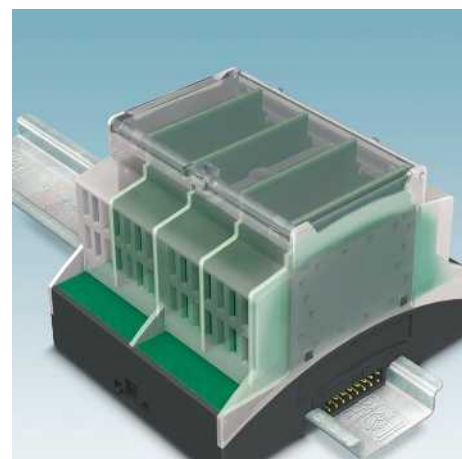
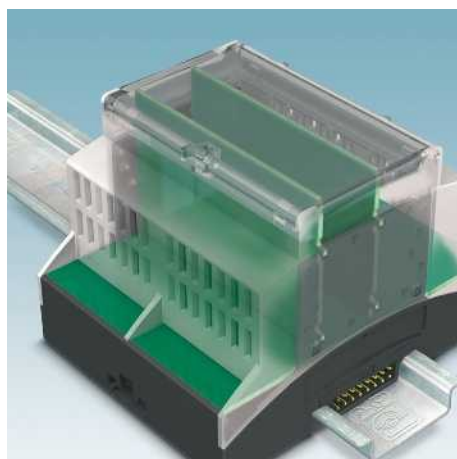
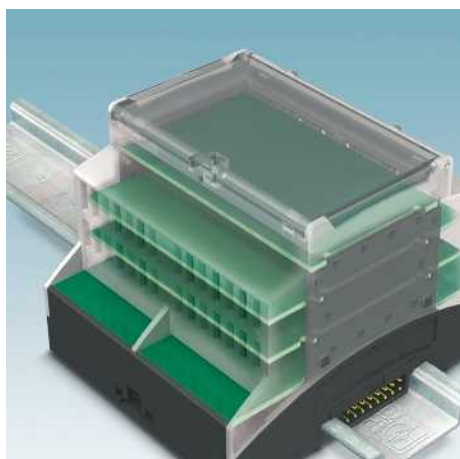

Flexible device concepts

Internal PCB guides in all three space directions enable the electronic components to be installed in a functional and convenient manner. The PCBs can be snapped on parallel to the DIN rail on different levels as well as orthogonally in different positions.

Matrix for selecting the connection technology

Module	BC 17,8 OTU	BC 35,6 OT U11	BC 35,6 OT U22	BC 53,6 OT U11	BC 53,6 OT U22	BC 71,6 OT U11
Terminal installation depth		11.1 mm	22.35 mm	11.1 mm	22.35 mm	11.1 mm
MKDSO 1,5/4-L-3,5	•	-	-	-	-	-
MKDSO 1,5/4-R-3,5	•	-	-	-	-	-
MKDSO 2,5/3-L	•	-	-	-	-	-
MKDSO 2,5/3-R	•	-	-	-	-	-
MKDS 1,5/... HT	-	•	•	•	•	•
MKDS 3/... HT	-	•	•	•	•	•
MKDS 1,5/...	-	•	•	•	•	•
MKDSP 1,5/...	-	•	•	•	•	•
MKDSN 2,5/...	-	•	•	•	•	•
MKDS 3/...	-	•	•	•	•	•
MKDSP 3/...	-	•	•	•	•	•
MKKDSH 3/...	-	•	•	•	•	•
GMKDS 1,5/...	-	•	•	•	•	•
GMKDS 3/...	-	•	•	•	•	•
GMKDSP 3/...	-	•	•	•	•	•
SPTA 1/...-3,5	-	•	•	•	•	•
SPTA 1/...-5,0	-	•	•	•	•	•
MKKDS 1,5/...	-	-	•	-	•	-
MKKDS 3/...	-	-	•	-	•	-
MKKDSG 3/...	-	-	•	-	•	-
ZFKKDS 1,5C-5,0	-	-	•	-	•	-
FK-MPT 0,5/...-3,5-H	-	•	•	•	•	•
FK-MPT 0,5/...-ST-3,5	-	•	•	•	•	•
PTSA 0,5/...-2,5-Z	-	•	•	•	•	•
PTSA 0,5/...-2,5-F	-	•	•	•	•	•
PTSA 1,5/...-3,5-Z	-	•	•	•	•	•
PTSA 1,5/...-3,5-F	-	•	•	•	•	•
PTS 1,5/...-5,0-H	-	•	•	•	•	•
PT 1,5/...-5,0-H	-	•	•	•	•	•
PT 1,5/...-PH-5,0	-	•	•	•	•	•
PT 2,5/...-5,0-H	-	•	•	•	•	•
PT 2,5/4-7,5-H	-	•	•	•	•	•
PTDA 1,5/...-PH-3,5	-	-	•	-	•	-
PTDA 1,5/...-PH-5,0	-	-	•	-	•	-
PT 2,5/...-P VH-5,0	-	-	•	-	•	-
PST 1,3/...-LH-5,0	-	-	•	-	•	-
PST 1,3/...-LV-5,0	-	-	•	-	•	-
PST 1,0/...-3,5	-	•	•	•	•	•
PST 1,3/...-5,0	-	•	•	•	•	•
VS-08-BU-RJ45...	-	-	•	-	•	-

For the 22 mm terminal installation depth, terminal blocks for U11 installation depth can also be used and are therefore listed as well.

**Terminal installation depth
U11 = 11.1 mm**

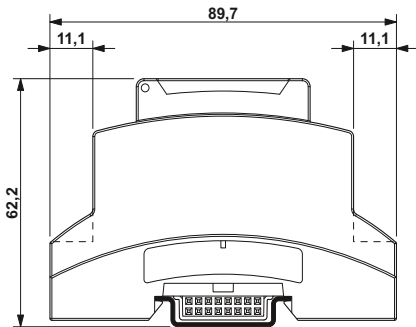

**Terminal installation depth
U22 = 22.35 mm**

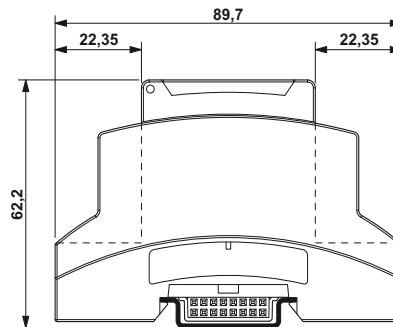

BC installation component housing

More housing dimensions, the layout of the PCBs, their dimensions and assembly areas can be found in the download center at:
www.phoenixcontact.net/products

Notes:
1) For information on power dissipation, see page 770.
2) DIN rail connectors, see page 702.



17.8 mm wide = 1 terminal pitch



35.6 mm wide = 2 terminal pitches



Technical data					
Power dissipation P _V at 20°C in horizontal mounting position ¹⁾					
BC 17,8 UT HBUS BK					
2.95 W					
Mounted in rows without spacing					
Type of housing					
Electronic housings					
Connection data					
HBUS					
polycarbonate / V0					
solid	stranded		I	U	
[mm ²]		AWG	[A]	[V]	
-	-	-	3	60	

Ordering data		
Type	Order No.	Pcs. / Pkt.
BC 17,8 UT HBUS BK	2896241	10
BC 17,8 OTU MKDSO KMGY	2279732	10
BC 17,8 DKL R KMGY	2896144	10
BC 17,8 DKL S TRANS	2896102	10

Accessories		
PCB terminal block, left, 3.5 mm pitch, color: light gray		
Left	MKDSO 1,5/ 4-L-3,5 KMGY	2278432 50
Right	MKDSO 1,5/ 4-R-3,5 KMGY	2278429 50
PCB terminal block, for soldering into the PCB, pitch 5		
Left	MKDSO 2,5/ 3-L KMGY	2854102 250
Right	MKDSO 2,5/ 3-R KMGY	2854092 250
Cap set, 3-section	HBUS-B SET BK	2278173 10
DIN rail connector, 16-pos. ²⁾		
One 18-pos. slot to the PCB	HBUS 35,6-16P-1S BK	2896283 10
Two 18-pos. slots to the PCB	HBUS 53,6-16P-3S BK	2896322 10
Three 18-pos. slots to the PCB		
Power connector for DIN rail bus connector with 16 free cable ends with a cross section of 0.25 mm ² , 500 mm long		
Socket strip	BL2-2,54/16-ST	2896335 50
Pin strip	SL2-2,54/16-ST	2896348 50
Filler plugs, for unoccupied terminal points	ME B-17,5 MKDSO KMGY	2854115 10
Cover caps for empty terminal space, 17.6 mm width, for terminal installation depth 22 mm		
Cover caps for empty terminal space, 35.6 mm width, for terminal installation depth 11 mm		
Cover caps for empty terminal space, 35.6 mm width, for terminal installation depth 22 mm		
Cover caps for empty terminal space, 53.6 mm width, for terminal installation depth 11 mm		
Cover caps for empty terminal space, 53.6 mm width, for terminal installation depth 22 mm		



Technical data					
Power dissipation P _V at 20°C in horizontal mounting position ¹⁾					
BC 35,6 UT HBUS BK					
4.78 W					
Mounted in rows without spacing					
Type of housing					
Electronic housings					
Connection data					
HBUS					
polycarbonate / V0					
solid	stranded		I	U	
[mm ²]		AWG	[A]	[V]	
-	-	-	3	60	

Ordering data		
Type	Order No.	Pcs. / Pkt.
BC 35,6 UT HBUS BK	2896254	10
BC 35,6 OT U11 KMGY	2896034	10
BC 35,6 OT U22 KMGY	2896047	10
BC 35,6 DKL R KMGY	2896157	10
BC 35,6 DKL S TRANS	2896115	10

Accessories		
PCB terminal block, left, 3.5 mm pitch, color: light gray		
Left	MKDSO 1,5/ 4-L-3,5 KMGY	2278432 50
Right	MKDSO 1,5/ 4-R-3,5 KMGY	2278429 50
PCB terminal block, for soldering into the PCB, pitch 5		
Left	MKDSO 2,5/ 3-L KMGY	2854102 250
Right	MKDSO 2,5/ 3-R KMGY	2854092 250
Cap set, 3-section	HBUS-B SET BK	2278173 10
DIN rail connector, 16-pos. ²⁾		
One 18-pos. slot to the PCB	HBUS 35,6-16P-1S BK	2896283 10
Two 18-pos. slots to the PCB	HBUS 53,6-16P-3S BK	2896322 10
Three 18-pos. slots to the PCB		
Power connector for DIN rail bus connector with 16 free cable ends with a cross section of 0.25 mm ² , 500 mm long		
Socket strip	BL2-2,54/16-ST	2896335 50
Pin strip	SL2-2,54/16-ST	2896348 50
Filler plugs, for unoccupied terminal points	ME B-17,5 MKDSO KMGY	2854115 10
Cover caps for empty terminal space, 17.6 mm width, for terminal installation depth 22 mm		
Cover caps for empty terminal space, 35.6 mm width, for terminal installation depth 11 mm		
Cover caps for empty terminal space, 35.6 mm width, for terminal installation depth 22 mm		
Cover caps for empty terminal space, 53.6 mm width, for terminal installation depth 11 mm		
Cover caps for empty terminal space, 53.6 mm width, for terminal installation depth 22 mm		



53.6 mm wide = 3 terminal pitches



71.6 mm wide = 4 terminal pitches



107.6 mm wide = 6 terminal pitches



Technical data					
BC 53,6 UT HBUS BK 7.21 W					
polycarbonate / V0					
solid	stranded		I	U	
	[mm ²]	AWG	[A]	[V]	
-	-	-	3	60	

Technical data					
BC 71,6 UT HBUS BK 11.95 W					
polycarbonate / V0					
solid	stranded		I	U	
	[mm ²]	AWG	[A]	[V]	
-	-	-	3	60	

Technical data					
BC 107,6 UT HBUS BK 13.08 W					
polycarbonate / V0					
solid	stranded		I	U	
	[mm ²]	AWG	[A]	[V]	
-	-	-	3	60	

Ordering data		
Type	Order No.	Pcs. / Pkt.
BC 53,6 UT HBUS BK	2896403	10
BC 53,6 OT U11 KMGY	2896416	10
BC 53,6 OT U22 KMGY	2896429	10
BC 53,6 DKL R KMGY	2896432	10
BC 53,6 DKL S TRANS	2896445	10

Ordering data		
Type	Order No.	Pcs. / Pkt.
BC 71,6 UT HBUS BK	2896267	10
BC 71,6 OT U11 KMGY	2896050	10
BC 71,6 OT U22 KMGY	2896063	10
BC 71,6 DKL R KMGY	2896160	10
BC 71,6 DKL S TRANS	2896128	10

Ordering data		
Type	Order No.	Pcs. / Pkt.
BC 107,6 UT HBUS BK	2896270	10
BC 107,6 OT U11 KMGY	2896076	10
BC 107,6 OT U22 KMGY	2896089	10
BC 107,6 DKL R KMGY	2896173	10
BC 107,6 DKL S TRANS	2896131	10

Accessories		
Type	Order No.	Pcs. / Pkt.
HBUS-B SET BK	2278173	10
HBUS 53,6-16P-1S BK	2896458	10
BL2-2,54/16-ST	2896335	50
SL2-2,54/16-ST	2896348	50
BC 17,6 BS U11 KMGY	2896186	50
BC 17,6 BS U22 KMGY	2896199	50
BC 35,6 BS U11 KMGY	2896209	50
BC 35,6 BS U22 KMGY	2896212	50
BC 53,6 BS U11 KMGY	2896225	50
BC 53,6 BS U22 KMGY	2896238	50

Accessories		
Type	Order No.	Pcs. / Pkt.
HBUS-B SET BK	2278173	10
HBUS 71,6-16P-1S BK	2896296	10
BL2-2,54/16-ST	2896335	50
SL2-2,54/16-ST	2896348	50
BC 17,6 BS U11 KMGY	2896186	50
BC 17,6 BS U22 KMGY	2896199	50
BC 35,6 BS U11 KMGY	2896209	50
BC 35,6 BS U22 KMGY	2896212	50

Accessories		
Type	Order No.	Pcs. / Pkt.
HBUS-B SET BK	2278173	10
HBUS 107,6-16P-1S BK	2896306	10
BL2-2,54/16-ST	2896335	50
SL2-2,54/16-ST	2896348	50
BC 17,6 BS U11 KMGY	2896186	50
BC 17,6 BS U22 KMGY	2896199	50
BC 35,6 BS U11 KMGY	2896209	50
BC 35,6 BS U22 KMGY	2896212	50
BC 53,6 BS U11 KMGY	2896225	50
BC 53,6 BS U22 KMGY	2896238	50

BC installation component housings

More housing dimensions, the layout of the PCBs, their dimensions and assembly areas can be found in the download center at:
www.phoenixcontact.net/products

Notes:
1) For information on power dissipation, see page 770.
2) DIN rail connectors see page 702.



161.6 mm wide = 9 terminal pitches

Power dissipation P_v at 20°C in horizontal mounting position ¹⁾
Mounted in rows without spacing
Type of housing
Electronic housings
Connection data
HBUS

Description
Housing base
Upper part of housing With vents, terminal installation depth 11 mm
Housing upper part, with vents, terminal installation depth 22 mm
Housing cover , firmly locked with the housing upper part, in housing color light gray
Housing cover , can be swiveled and sealed, transparent, incl. fitted cover

Cap set , 3-section
DIN rail connector for housing width 161.6 mm (9TE) , 16-pos., one 18-pos. slot for PCB ²⁾
Power connector for DIN rail bus connector with 16 free cable ends with a cross section of 0.25 mm ² , 500 mm long
Socket strip
Pin strip
Cover caps for empty terminal space, 17.6 mm width, for terminal installation depth 11 mm
Cover caps for empty terminal space, 17.6 mm width, for terminal installation depth 22 mm
Cover caps for empty terminal space, 35.6 mm width, for terminal installation depth 11 mm
Cover caps for empty terminal space, 35.6 mm width, for terminal installation depth 22 mm
Cover caps for empty terminal space, 53.6 mm width, for terminal installation depth 11 mm
Cover caps for empty terminal space, 53.6 mm width, for terminal installation depth 22 mm



Technical data				
BC 161,6 UT				
HBUS BK				
16.95 W	-	-	-	-
polycarbonate / V0				
solid	stranded	AWG	I [A]	U [V]
-	-	-	3	60

Ordering data		
Type	Order No.	Pcs. / Pkt.
BC 161,6 UT HBUS BK	2278500	10
BC 161,6 OT U11 KMGY	2278513	10
BC 161,6 OT U22 KMGY	2278526	10
BC 161,6 DKL R KMGY	2278539	10
BC 161,6 DKL S TRANS	2278542	10

Accessories		
	Order No.	Pcs. / Pkt.
HBUS-B SET BK	2278173	10
HBUS 161,6-16P-1S BK	2278555	10
BL2-2,54/16-ST	2896335	50
SL2-2,54/16-ST	2896348	50
BC 17,6 BS U11 KMGY	2896186	50
BC 17,6 BS U22 KMGY	2896199	50
BC 35,6 BS U11 KMGY	2896209	50
BC 35,6 BS U22 KMGY	2896212	50
BC 53,6 BS U11 KMGY	2896225	50
BC 53,6 BS U22 KMGY	2896238	50

BC modular

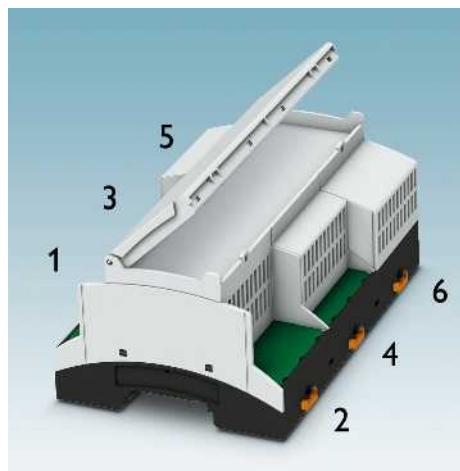

The BC 161,6 modular extends the BC housing range with a modular upper part which is a perfect match for the proven BC 161,6 housing bases.

An innovative tool concept makes it possible to design both the PCB assembly area as well as the installation space for the PCB connection technology in line with the application.

Customers can choose from 3 different side panel arrangements per segment:

- Side panel in the outermost position, i.e., flush with the outer edge of the housing base: maximum PCB assembly area inside the housing for a variety of different components
- Side panel in the innermost position: maximum installation space for connection technology = 22 mm, e.g., for double-level terminal blocks or RJ45
- Middle side panel position: installation space for connection technology = 11 mm, i.e., space both for the connection technology and inside the housing

Please tell us how you would like the product to be configured.

Notes:
1) For information on power dissipation, see page 770.
2) DIN rail connectors see page 702.

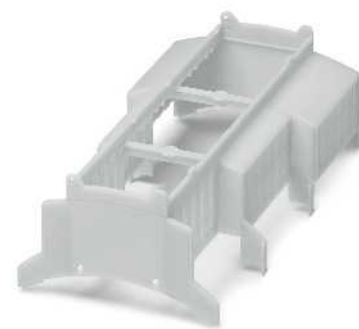

Modular upper part for customer-specific configuration
161.6 mm wide = 9 pitches

Power dissipation P_V at 20°C in horizontal mounting position ¹⁾	BC 161,6 OT 000020 KMGY 16.95 W
Mounted in rows without spacing	
Type of housing	Electronic housings
Connection data	polycarbonate / V0
	solid stranded
	[mm ²] AWG I [A] U [V]
	- - - 3 60

HBUS

Technical data				
BC 161,6 OT 000020 KMGY 16.95 W				
polycarbonate / V0				
	solid	stranded	I	U
	[mm ²]	AWG	[A]	[V]
	-	-	3	60

Ordering data	
Description	Housing base
Housing upper part with vents, 1 x terminal installation depth of 22 mm at pos. 5, pos. 1 - 4, and pos. 6 clamping space closed	Housing upper part with vents, 1 x terminal installation depth 22 mm at pos. 3, pos. 1+2, and pos. 4-6 clamping space closed
Housing upper part with vents, 1 x terminal installation depth 22 mm at pos. 5+6, pos. 1-4 clamping space closed	Housing upper part with vents, 2 x terminal installation depth 22 mm at pos. 5+6, pos. 1-4 clamping space closed
Housing cover , firmly locked with the housing upper part, in housing color light gray	Housing cover , can be swiveled and sealed, transparent, incl. fitted cover

Type	Order No.	Pcs. / Pkt.
BC 161,6 UT HBUS BK	2278500	10
BC 161,6 OT 000020 KMGY	2201450	10
BC 161,6 OT 002000 KMGY	2201451	10
BC 161,6 OT 000022 KMGY	2201454	10
BC 161,6 DKL R KMGY	2278539	10
BC 161,6 DKL S TRANS	2278542	10

Accessories	
Cap set, 3-section	HBUS-B SET BK
DIN rail connector for housing width 161.6 mm (9TE), 16-pos., one 18-pos. slot for PCB ²⁾	2278173
Power connector for DIN rail bus connector with 16 free cable ends with a cross section of 0.25 mm ² , 500 mm long	HBUS 161,6-16P-1S BK
Socket strip	2278555
Pin strip	BL2-2,54/16-ST
Cover caps for empty terminal space, 17.6 mm width, for terminal installation depth 22 mm	2896335
Cover caps for empty terminal space, 35.6 mm width, for terminal installation depth 22 mm	2896348
Cover caps for empty terminal space, 53.6 mm width, for terminal installation depth 22 mm	2896199
	BC 17,6 BS U22 KMGY
	2896212
	BC 35,6 BS U22 KMGY
	2896238
	BC 53,6 BS U22 KMGY

Accessories	
HBUS-B SET BK	2278173
HBUS 161,6-16P-1S BK	2278555
BL2-2,54/16-ST	2896335
SL2-2,54/16-ST	2896348
BC 17,6 BS U22 KMGY	2896199
BC 35,6 BS U22 KMGY	2896212
BC 53,6 BS U22 KMGY	2896238

HBUS DIN rail connectors

Notes:
1) DIN rail connectors see page 702.



Automatic contacting between devices

- For parallel and serial data transmission and power supply
- 16-pos. in DIN rail, 18-pos. in device
- Gold-plated contacts
- Housing width 17.8 mm suitable for connectors with 2 or 3 slots
- One connector per housing is required for housing widths in excess of 35.6 mm
- Cover caps for protection
- Pin or socket strip (SL or BL) for supply incl. 50 cm cable ends

Description
DIN rail connector for housing width 17.8 mm (1TE)
Two 18-pos. slots to the PCB Three 18-pos. slots to the PCB DIN rail connector, 16-pos.¹⁾ One 18-pos. slot to the PCB
DIN rail connector, 16-pos., for housing width 53.6 mm (3TE)
DIN rail connector for housing width 71.6 mm (4TE), 16-pos., one 18-pos. slot for PCB
DIN rail connector for housing width 107.6 mm (6TE), 16-pos., one 18-pos. slot for PCB
DIN rail connector for housing width 161.6 mm (9TE), 16-pos., one 18-pos. slot for PCB¹⁾

Ordering data

Type	Order No.	Pcs. / Pkt.
HBUS 35,6-16P-2S BK	2896319	10
HBUS 53,6-16P-3S BK	2896322	10
HBUS 35,6-16P-1S BK	2896283	10
HBUS 53,6-16P-1S BK	2896458	10
HBUS 71,6-16P-1S BK	2896296	10
HBUS 107,6-16P-1S BK	2896306	10
HBUS 161,6-16P-1S BK	2278555	10

Power plug for DIN rail bus connector with 16 free cable ends with a cross section of 0.25 mm², 500 mm long
Socket strip
Pin strip
Cap set, 3-section

Accessories

BL2-2,54/16-ST	2896335	50
SL2-2,54/16-ST	2896348	50
HBUS-B SET BK	2278173	10

Housing bases

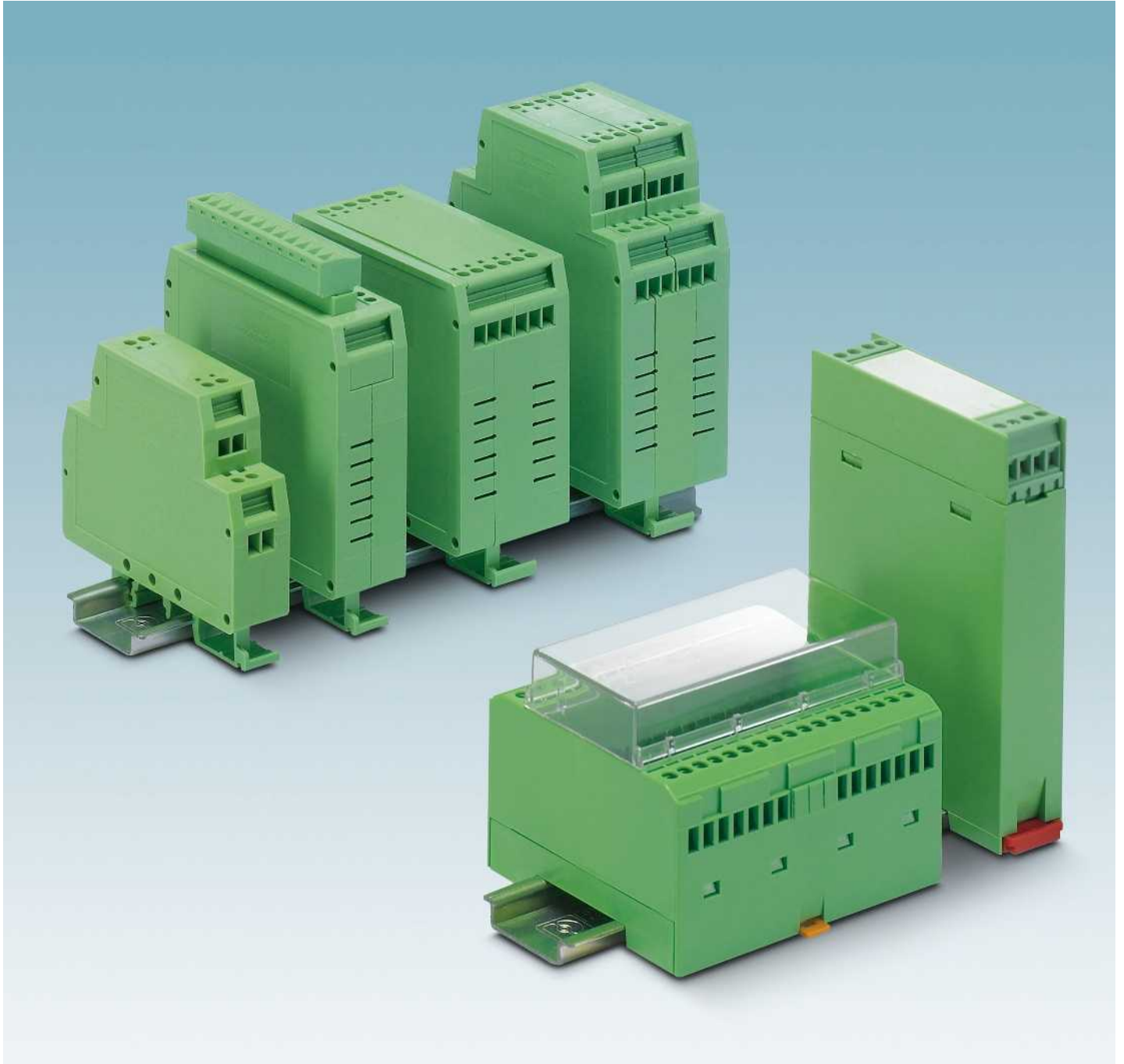

The EMG, EG, and UEG housing ranges are the ideal solution for cost-effective housing production. Cost-effectiveness and functionality are combined with simple PCB geometries, carefully thought-out overall width scaling, and some versions with integrated connection technology.

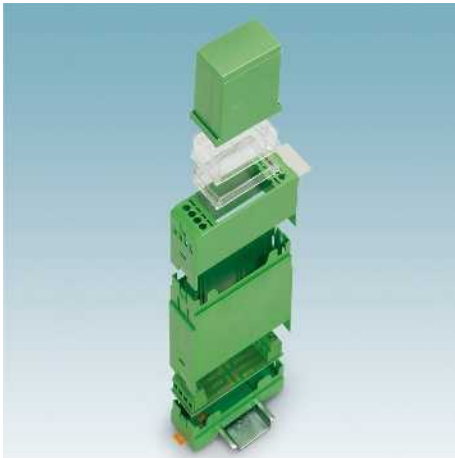

EMG housing range

Your advantages at a glance:

- Fine type scaling for broad diversity of overall widths
- Various cover versions
- Flat design
- For solid 2.5 mm² - MKDS 3 screw connections with 5 mm pitch

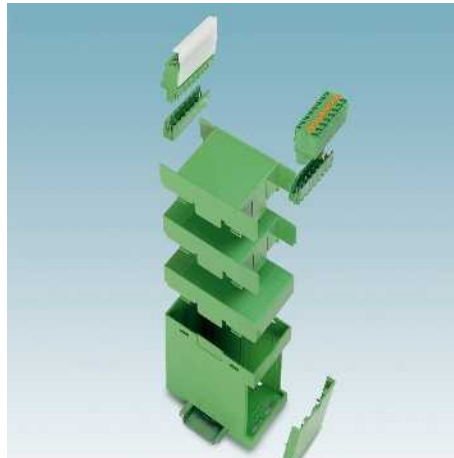

EG housing range

Your advantages at a glance:

- Robust housing type
- Receptacle housing
- A variety of cover designs
- Two material versions, ABS and PC
- Optional with test opening

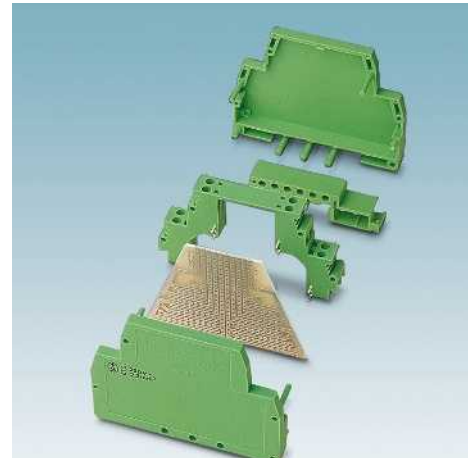

UEG housing range

Your advantages at a glance:

- Flat half-shell design
- Base element with integrated connection technology, double-level design
- Optional PCBs for small series



UEGM housing range

Your advantages at a glance:

- Half-shell design
- Base element with integrated connection technology, single-level design
- Large PCB surface
- Optional PCBs for small series

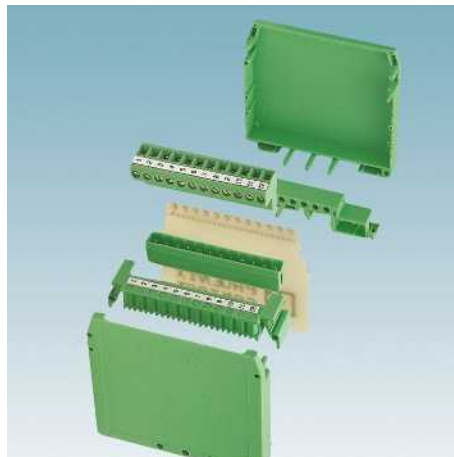

UEGM-MSTB housings

Your advantages at a glance:

- Half-shell design
- Base element with integrated 12-pos. pin strip
- Can be additionally equipped with 3 mm LED light indicator
- Large PCB surface

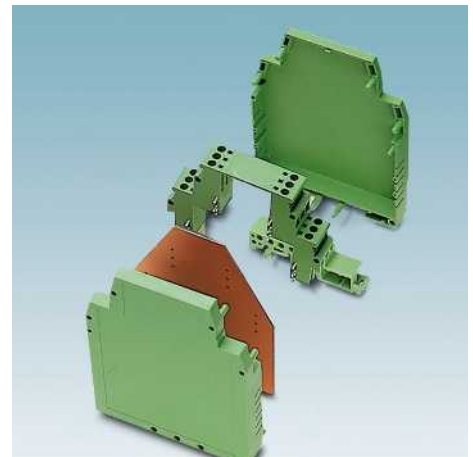

UEGH housing range

Your advantages at a glance:

- Tall half-shell design
- Base element with integrated connection technology, double-level design
- Optional PCBs for small series
- Versions offering space for PCBs fitted with SMDs on both sides

Basic housings for universal use

EMG system component housing

EMG is a complete range of component housing for the cost-effective design of industrial electronics to suit control cabinet requirements. Both small interface circuits and complete control units can be installed in this housing.

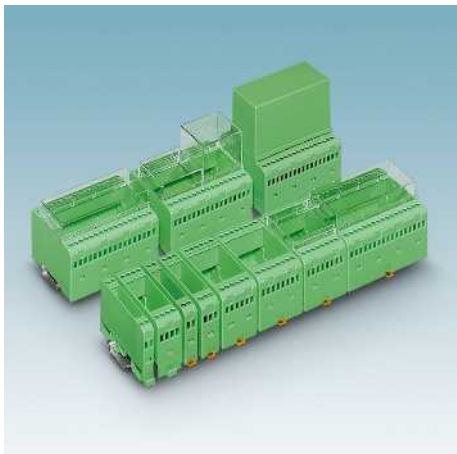

Features of EMG housing:

- Uniform and appropriate housing technology
- Space-saving accommodation of electronic components in finely graded module versions available with 10 to 150 mm pitch
- Practical and easy-to-wire conductor connections
- Inflammability class V0 insulation material (according to UL 94)
- High degree of flexibility due to the wide choice of versions
- User-friendly and safe mounting on DIN rails according to EN 60715
- Shock and contamination-proof accommodation of electronic components
- Choice of four cover sizes in transparent or color versions
- Universal PCBs for all pitches

Construction principle

The top right image shows the principle of EMG construction: the assembled PCB is inserted into the upper part of the housing and then reliably latched into the housing base.

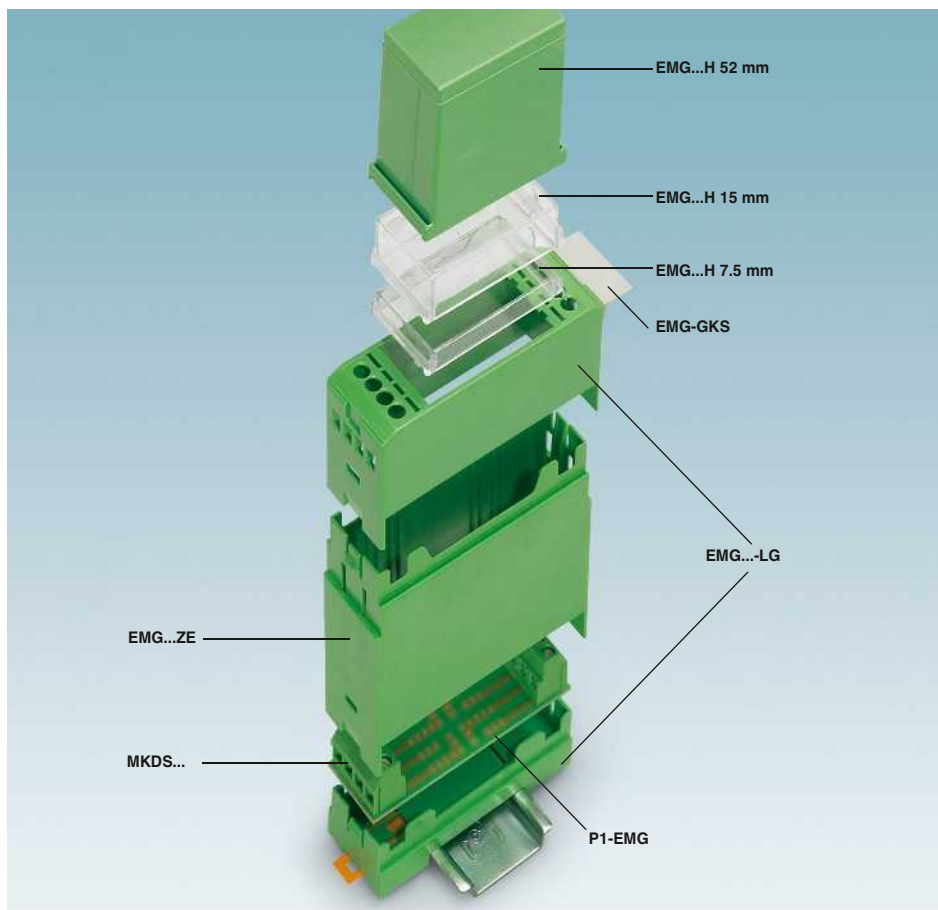

Accommodating electronic components

The fine grading of types enables optimum adaptation of the housing to the required PCB area and the required number of connection positions. The PCB is rectangular.

The special feature of this range is that all electronic components and PCB terminal blocks can be mounted to suit production requirements and machine-soldered in a single step.

To create narrow modules that also have comprehensive electronic components, one or more additional PCBs can be mounted perpendicular to the main PCB.

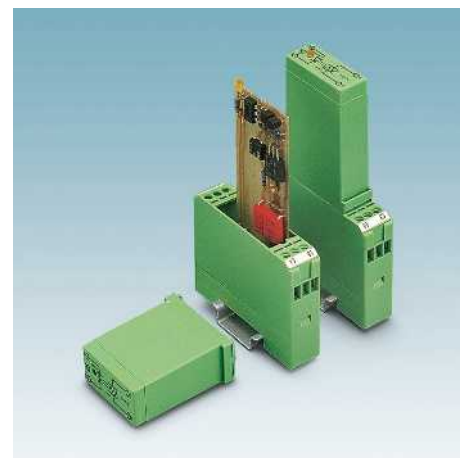

Details of PCB layout, dimensions, connection points, and assembly areas can be found in the Download Center at www.phoenixcontact.net/products.



Four cover heights

The transparent or opaque green covers are supplied to protect the internal electronic components against shock and contamination. The cover is simply snapped on and can be removed again at any time.

The front has openings for the installation of indication or actuation elements and the surface can be printed with a circuit diagram. The covers can be supplied with cut-outs or printing on the front.

Special coding adaptation ensures that the covers can only be mounted to match the circuit.

You can choose between four cover heights allowing optimum adaptation of the module height to the space requirements of the electronic components. The 7.5 mm, 15 mm, and 35 mm high covers are transparent, whereas the 52 mm high cover is opaque green. The high covers have guide slots to accommodate the perpendicular secondary PCB(s).

EMG housing with a design width of 17 mm, 25 mm, and 75 mm is also available as an enclosed version (EMG...-LG/G) on request.



Conductor connections

Standard EMG...LG versions are designed for sturdy 2.5 mm² screw connections on both sides in the form of MKDS 3 PCB terminal blocks with 5 mm pitch. The terminal points that are not used can be sealed with EMG-KA terminal blocks/screw covers.

The following versions of EMG housing are also available:

- EMG...LG 7,5 for PCB terminal blocks with 7.5 mm pitch.
- EMG...LG/O, with open clamping space for free assembly, can be fitted with 2.8 x 0.8 mm spade connections or with PCB terminal block or COMBICON connections with vertical plug-in direction (MSTBV 2,5/...-G).
- EMG...LG/MSTB for lateral COMBICON connection (plug-in direction parallel to the PCB).



Intermediate elements

EMG...ZE intermediate elements are available for pitches of 25, 45, and 90 mm. These elements increase the assembly space perpendicular to the DIN rail significantly. The various PCB guides ensure optimum accommodation of your electronic components.

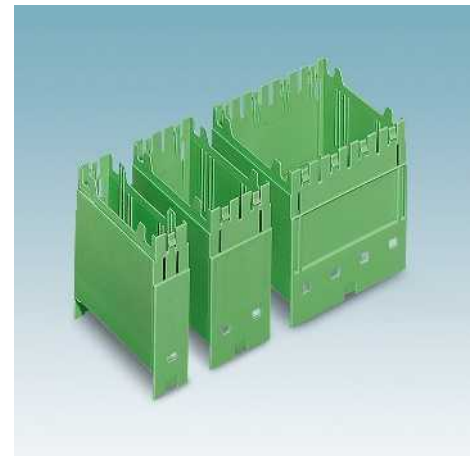

Basic housings for universal use

EMG system component housing

Delivery forms

This component housing range can be divided into three delivery groups:

- Housings with order no. EMG...LG consist of an upper and a lower part.
- Articles ending in SET are supplied as upper and lower housing parts in the standard version, including the relevant PCB terminal blocks.
- Ready-mounted custom circuit modules with PCB and solder tags, which are fitted on MKDS 3/... connection terminal blocks, are available as EMG...B.... These custom circuit modules are the answer if you want to make a professional job of integrating components such as damping diodes, varistors or capacitors in the control cabinet.

Mounting:

All housings are aligned in rows on the symmetrical DIN rail in accordance with EN 60715 by simply snap locking them into place. They are removed by pulling back the base latch. Modules of up to a design width of 22.5 mm are also supplied with a universal foot, thus making them suitable for all DIN rails commonly available in the market.

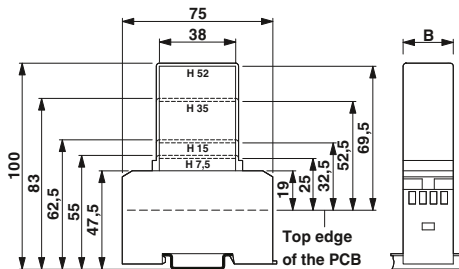

B= Width



4-pos., width: 10 mm

Power dissipation P_V at 20°C in horizontal mounting position¹⁾

Mounted in rows without spacing
Mounted in rows with min. 20 mm spacing

Type of housing
Electronic housings
Green cover
Transparent cover
Stripping length
Connection data

Technical data			
H 7,5	H 15	H 35	H 52
0.9 W	1 W	-	1.5 W
1.2 W	1.4 W	-	2.2 W
Polycarbonate fiber reinforced / V0 Polycarbonate fiber reinforced PC-F / V0 Polycarbonate, PC / V2 8 mm			
solid	stranded		I U
	[mm ²]	AWG	[A] [V]
0.2 - 4	0.2 - 2.5	24 - 12	- -

Notes:			
Torque of terminal block screws see page 854.			
Marking systems and mounting materials: see Catalog 5.			
¹⁾ For information on power dissipation, see page 770.			

Description	Grid [mm]	No. of pos.	Width [mm]
Electronic housing , for PCB insertion, without screw connection terminal blocks and cover, with universal foot,	5	4	10
	5	4	12.5
	5	6	15
	5	6	17.5
	7.5	4	17.5
With open terminal space			17.5

Electronic housing set , consisting of electronic housings and printed circuit termination blocks			
5	4	10	
5	4	12.5	
5	6	15	
5	6	17.5	

Custom circuit module , consisting of housing, Connecting terminal blocks MKDS 3 and printed circuit board with solder tags, for soldering in electronic components			
5			

Covering hood , for the contact and dust-protected encapsulation of the components			
Height 7.5 mm, transparent			
Height 15 mm, transparent			
Height 35 mm, transparent			
Height 52 mm, green			
PCB , for assembling electronic components			

Printed circuit termination block , pitch 5 or 5.08, for soldering onto the printed circuit board			
	2		
	3		

Printed circuit termination block , pitch 7.5, for soldering into the printed circuit board			
	2		

Terminal block/screw cover , set consisting of 50 strips each for terminal blocks and screw openings, 1 strip covers 12 terminal points			

Equipment marker			
		10	
		12	

Ordering data			
Type	Order No.	Pcs. / Pkt.	
EMG 10-LG	2947747	10	
EMG 10-LG/SET	2942959	10	
EMG 10-B2	2947750	10	

Accessories			
EMG 10-H 7,5MM KLAR	2947763	10	
EMG 10-H 15MM KLAR	2947776	10	
EMG 10-H 52MM GN	2947789	10	
P 1-EMG 10	2947792	10	
MKDS 3/ 2-EMG 10	1712342	50	
EMG-KA	2941510	50	
EMG-SGKS 10	2947585	50	



4-pos., width: 12.5 mm

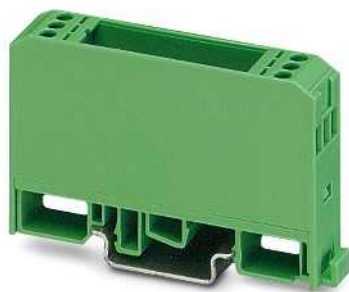

6-pos., width: 15 mm



4-pos., 7.5 mm pitch, 6-pos., 5 mm pitch, width: 17.5 mm

Technical data				
H 7,5	H 15	H 35	H 52	
1.2 W	1.3 W	-	2 W	
1.3 W	1.5 W	-	2.6 W	
Polycarbonate fiber reinforced / V0 Polycarbonate fiber reinforced PC-F / V0 Polycarbonate, PC / V2 8 mm				
solid	stranded		I	U
	[mm ²]	AWG	[A]	[V]
0.2 - 4	0.2 - 2.5	24 - 12	-	-

Technical data				
H 7,5	H 15	H 35	H 52	
1.2 W	1.4 W	-	2 W	
1.3 W	1.5 W	-	2.7 W	
Polycarbonate fiber reinforced / V0 Polycarbonate fiber reinforced PC-F / V0 Polycarbonate, PC / V2 8 mm				
solid	stranded		I	U
	[mm ²]	AWG	[A]	[V]
0.2 - 4	0.2 - 2.5	24 - 12	-	-

Technical data				
H 7,5	H 15	H 35	H 52	
1.3 W	1.5 W	2.1 W	2.7 W	
1.4 W	1.6 W	2.7 W	4 W	
Polycarbonate fiber reinforced / V0 Polycarbonate fiber reinforced PC-F / V0 Polycarbonate, PC / V2 8 mm				
solid	stranded		I	U
	[mm ²]	AWG	[A]	[V]
0.2 - 4	0.2 - 2.5	24 - 12	-	-

Ordering data		
Type	Order No.	Pcs. / Pkt.
EMG 12-LG	2907910	10
EMG 12-LG/SET	2942962	10
EMG 12-B2	2948306	10

Ordering data		
Type	Order No.	Pcs. / Pkt.
EMG 15-LG	2908508	10
EMG 15-LG/SET	2942975	10
EMG 15-B3	2947815	10

Ordering data		
Type	Order No.	Pcs. / Pkt.
EMG 17-LG	2946078	10
EMG 17-LG-7,5	2944106	10
EMG 17-LG/O	2942409	10
EMG 17-LG/SET	2942988	10
EMG 17-B3	2946081	10

Accessories		
EMG 12-H 7,5MM KLAR	2947116	10
EMG 12-H 15MM KLAR	2948296	10
EMG 12-H 52MM GN	2947129	10
P 1-EMG 12	2947187	5
MKDS 3/ 2	1711026	100
EMG-KA	2941510	50
EMG-GKS 12	2947035	50

Accessories		
EMG 15-H 7,5MM KLAR	2947828	10
EMG 15-H 15MM KLAR	2947831	10
EMG 15-H 52MM GN	2947844	10
P 1-EMG 15	2947857	20
MKDS 3/ 3-EMG 15	1712698	50
GMKDS 3/ 2-EMG15	1731462	50
EMG-KA	2941510	50
EMG-GKS 12	2947035	50

Accessories		
EMG 17-H 7,5MM KLAR	2946094	10
EMG 17-H 15MM KLAR	2946104	10
EMG 17-H 35MM KLAR	2942221	10
EMG 17-H 52MM GN	2946117	10
P 1-EMG 17	2946120	5
MKDS 3/ 3	1711039	100
GMKDS 3/ 2	1731022	100
EMG-KA	2941510	50
EMG-SGKS 10	2947585	50
EMG-GKS 12	2947035	50

Notes:
Tightening torque of terminal block screws refer to page 854.
Marking systems and mounting materials: see Catalog 5.
1) For information on power dissipation, see page 770.

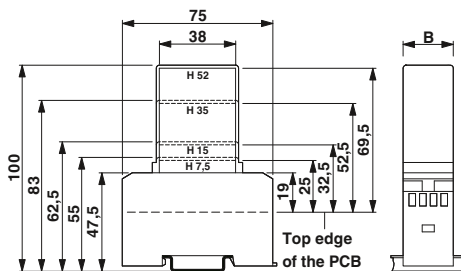

B= Width



8-pos., width: 22.5 mm

Power dissipation P_V at 20°C in horizontal mounting position¹⁾

Mounted in rows without spacing
Mounted in rows with min. 20 mm spacing

Type of housing
Electronic housings
Green cover
Transparent cover
Stripping length
Connection data

Technical data			
H 7,5	H 15	H 35	H 52
1.4 W	1.6 W	2.3 W	3 W
1.6 W	1.8 W	2.9 W	4.1 W
Polycarbonate fiber reinforced / V0 Polycarbonate fiber reinforced PC-F / V0 Polycarbonate, PC / V2 8 mm			
solid	stranded		I U
	[mm ²]	AWG	[A] [V]
0.2 - 4	0.2 - 2.5	24 - 12	- -

Description	Grid [mm]	No. of pos.	Width [mm]
Electronic housing , for PCB insertion, without screw connection terminal blocks and cover			
With universal foot	5	8	22.5
With snap foot for DIN rail EN 60715	5	8	25
	5	10	30
	5	14	37.5
Electronic housing set , consisting of electronic housings and printed circuit termination blocks			
	5	8	22.5
	5	8	25
	5	10	30
	5	14	37.5
Custom circuit module , consisting of housing, connecting terminal blocks MKDS 3 and printed circuit board with solder tags, for soldering in electronic components			
	5		

Ordering data		
Type	Order No.	Pcs. / Pkt.
EMG 22-LG	2946133	10
EMG 22-LG/SET	2942991	10
EMG 22-B4	2946146	10

Covering hood, for the contact and dust-protected encapsulation of the components
Height 7.5 mm, transparent
Height 15 mm, transparent
Height 35 mm, transparent
Height 52 mm, green
PCB, for assembling electronic components

5.0 mm pitch, color: green

Terminal block/screw cover, set consisting of 50 strips each for terminal blocks and screw openings, 1 strip covers 12 terminal points

Intermediate element, to enlarge the assembly space

Equipment marker

Accessories		
Type	Order No.	Pcs. / Pkt.
EMG 22-H 7,5MM KLAR	2946159	10
EMG 22-H 15MM KLAR	2946162	10
EMG 22-H 35MM KLAR	2942771	10
EMG 22-H 52MM GN	2946175	10
P 1-EMG 22	2946188	5
MKDS 3/ 2	1711026	100
MKDS 3/ 3	1711039	100
MKDS 3/ 4	1711042	50
EMG-KA	2941510	50
EMG-SGKS 10	2947585	50
EMG-GKS 12	2947035	50
EMG-GKS 22	2941594	50



8-pos., width: 25 mm



10-pos., width: 30 mm



14-pos., width: 37.5 mm

Technical data				
H 7,5	H 15	H 35	H 52	
1.4 W	1.6 W	-	3.2 W	
1.6 W	1.8 W	-	4.5 W	
Polycarbonate fiber reinforced / V0				
Polycarbonate, PC / V0				
Polycarbonate, PC / V2				
8 mm				
solid	stranded		I	U
	[mm ²]	AWG	[A]	[V]
0.2 - 4	0.2 - 2.5	24 - 12	-	-

Technical data				
H 7,5	H 15	H 35	H 52	
1.5 W	1.7 W	-	3.6 W	
1.7 W	1.9 W	-	4.9 W	
Polycarbonate fiber reinforced / V0				
Polycarbonate fiber reinforced PC-F / V0				
Polycarbonate, PC / V2				
8 mm				
solid	stranded		I	U
	[mm ²]	AWG	[A]	[V]
0.2 - 4	0.2 - 2.5	24 - 12	-	-

Technical data				
H 7,5	H 15	H 35	H 52	
1.6 W	1.9 W	2.6 W	4 W	
1.8 W	2.1 W	3.5 W	5.4 W	
Polycarbonate fiber reinforced / V0				
Polycarbonate fiber reinforced PC-F / V0				
Polycarbonate, PC / V2				
8 mm				
solid	stranded		I	U
	[mm ²]	AWG	[A]	[V]
0.2 - 4	0.2 - 2.5	24 - 12	-	-

Ordering data		
Type	Order No.	Pcs. / Pkt.
EMG 25-LG	2948319	5
EMG 25-LG/SET	2943000	10
EMG 25-B4	2948335	10

Ordering data		
Type	Order No.	Pcs. / Pkt.
EMG 30-LG	2947860	5
EMG 30-LG/SET	2940016	5
EMG 30-B5	2947873	10

Ordering data		
Type	Order No.	Pcs. / Pkt.
EMG 37-LG	2947051	5
EMG 37-LG/SET	2940029	10
EMG 37-B7	2947064	5

Accessories		
EMG 25-H 7,5MM KLAR	2947132	5
EMG 25-H 15MM KLAR	2948322	5
EMG 25-H 52MM GN	2947145	5
P 1-EMG 25	2947190	20
MKDS 3/ 2	1711026	100
MKDS 3/ 3	1711039	100
MKDS 3/ 4	1711042	50
EMG-KA	2941510	50
EMG 25-ZE	2941808	5
EMG-SGKS 10	2947585	50
EMG-GKS 12	2947035	50
EMG-GKS 22	2941594	50

Accessories		
EMG 30-H 7,5MM KLAR	2947886	5
EMG 30-H 15MM KLAR	2947899	5
EMG 30-H 52MM GN	2947909	5
P 1-EMG 30	2947912	10
MKDS 3/ 2	1711026	100
MKDS 3/ 3	1711039	100
MKDS 3/ 4	1711042	50
EMG-KA	2941510	50
EMG-SGKS 10	2947585	50
EMG-GKS 12	2947035	50
EMG-GKS 22	2941594	50

Accessories		
EMG 37-H 7,5MM KLAR	2947158	5
EMG 37-H 15MM KLAR	2947161	5
EMG 37-H 35MM KLAR	2942768	5
EMG 37-H 52MM GN	2947174	5
P 1-EMG 37	2947077	5
MKDS 3/ 2	1711026	100
MKDS 3/ 3	1711039	100
MKDS 3/ 4	1711042	50
EMG-KA	2941510	50
EMG-SGKS 10	2947585	50
EMG-GKS 12	2947035	50
EMG-GKS 22	2941594	50

Notes:
Tightening torque of terminal block screws refer to page 854.
Marking systems and mounting materials: see Catalog 5.
1) For information on power dissipation, see page 770.

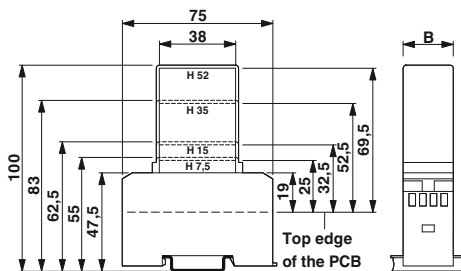

B= Width



16-pos., width: 45 mm

Power dissipation P_V at 20°C in horizontal mounting position ¹⁾
Mounted in rows without spacing
Mounted in rows with min. 20 mm spacing
Type of housing
Electronic housings
Green cover
Transparent cover
Stripping length
Connection data

Technical data				
H 7,5	H 15	H 35	H 52	
2 W	2.5 W	3.5 W	4.6 W	
2.4 W	2.9 W	4.4 W	5.7 W	
Polycarbonate fiber reinforced / V0				
Polycarbonate fiber reinforced PC-F / V0				
Polycarbonate, PC / V2				
8 mm				
solid	stranded		I	U
	[mm ²]	AWG	[A]	[V]
0.2 - 4	0.2 - 2.5	24 - 12	-	-

Description	Grid [mm]	No. of pos.	Width [mm]
Electronic housing , for PCB insertion, without screw connection terminal blocks and cover	5.08	16	45
	5	18	50
	5	28	75
	5	34	90
Electronic housing , for PCB insertion, without screw connection terminal blocks and cover			45
			50
			75
			90
Electronic housing set , consisting of electronic housings and printed circuit termination blocks	5.08	16	45
	5	18	50
	5	28	75
	5	34	90
Custom circuit module , consisting of housing, Connecting terminal blocks MKDS 3 and printed circuit board with solder tags, for soldering in electronic components	5.08		

Ordering data		
Type	Order No.	Pcs. / Pkt.
EMG 45-LG	2946191	5
EMG 45-LG/O	2942315	5
EMG 45-LG/SET	2940032	5
EMG 45-B8	2946201	5

Covering hood , for the contact and dust-protected encapsulation of the components		
Height 7.5 mm, transparent		
Height 15 mm, transparent		
Height 35 mm, transparent		
Height 52 mm, green		
PCB , for assembling electronic components		
5.08 mm pitch , color: green	2	
	3	
	4	
Intermediate element , to enlarge the assembly space		
Terminal block/screw cover , set consisting of 50 strips each for terminal blocks and screw openings, 1 strip covers 12 terminal points		
Equipment marker	12	
	22	

Accessories		
Type	Order No.	Pcs. / Pkt.
EMG 45-H 7,5MM KLAR	2946214	5
EMG 45-H 15MM KLAR	2946227	5
EMG 45-H 35MM KLAR	2942140	5
EMG 45-H 52MM GN	2946230	5
P 1-EMG 45	2946243	5
MKDS 3/ 2-5,08	1711725	100
MKDS 3/ 3-5,08	1711738	100
MKDS 3/ 4-5,08	1712805	50
EMG 45-ZE	2941811	5
EMG-KA	2941510	50
EMG-GKS 12	2947035	50
EMG-GKS 22	2941594	50



18-pos., width: 50 mm



28-pos., width: 75 mm



34-pos., width: 90 mm

Technical data				
H 7,5	H 15	H 35	H 52	
2.3 W	2.8 W	-	4.7 W	
2.6 W	3.4 W	-	6 W	
Polycarbonate fiber reinforced / V0				
Polycarbonate fiber reinforced PC-F / V0				
Polycarbonate, PC / V2				
8 mm				
solid	stranded		I	U
	[mm ²]	AWG	[A]	[V]
0.2 - 4	0.2 - 2.5	24 - 12	-	-

Technical data				
H 7,5	H 15	H 35	H 52	
3.3 W	3.8 W	-	4.9 W	
3.9 W	4.8 W	-	6.3 W	
Polycarbonate fiber reinforced / V0				
Polycarbonate fiber reinforced PC-F / V0				
Polycarbonate, PC / V2				
8 mm				
solid	stranded		I	U
	[mm ²]	AWG	[A]	[V]
0.2 - 4	0.2 - 2.5	24 - 12	-	-

Technical data				
H 7,5	H 15	H 35	H 52	
4.1 W	5 W	-	6.1 W	
4.6 W	5.7 W	-	7.1 W	
Polycarbonate fiber reinforced / V0				
Polycarbonate fiber reinforced PC-F / V0				
Polycarbonate, PC / V2				
8 mm				
solid	stranded		I	U
	[mm ²]	AWG	[A]	[V]
0.2 - 4	0.2 - 2.5	24 - 12	-	-

Ordering data		
Type	Order No.	Pcs. / Pkt.
EMG 50-LG	2947242	5
EMG 50-LG/O	2940870	5
EMG 50-LG/SET	2940045	5
EMG 50-B9	2947268	5

Ordering data		
Type	Order No.	Pcs. / Pkt.
EMG 75-LG	2947378	5
EMG 75-LG/O	2941879	5
EMG 75-LG/SET	2940058	10
EMG 75-B14	2947381	2

Ordering data		
Type	Order No.	Pcs. / Pkt.
EMG 90-LG	2946256	5
EMG 90-LG/O	2941581	5
EMG 90-LG/SET	2907884	5
EMG 90-B17	2946269	5

Accessories		
EMG 50-H 7,5MM KLAR	2947925	5
EMG 50-H 15MM KLAR	2947938	5
EMG 50-H 52MM GN	2947941	5
P 1-EMG 50	2947255	5
MKDS 3/ 2	1711026	100
MKDS 3/ 3	1711039	100
MKDS 3/ 4	1711042	50
EMG-KA	2941510	50
EMG-GKS 12	2947035	50
EMG-GKS 22	2941594	50

Accessories		
EMG 75-H 7,5MM KLAR	2947954	5
EMG 75-H 15MM KLAR	2947967	5
EMG 75-H 52MM GN	2947970	5
P 1-EMG 75	2947394	5
MKDS 3/ 2	1711026	100
MKDS 3/ 3	1711039	100
MKDS 3/ 4	1711042	50
EMG-KA	2941510	50
EMG-GKS 12	2947035	50
EMG-GKS 22	2941594	50

Accessories		
EMG 90-H 7,5MM KLAR	2945396	5
EMG 90-H 15MM KLAR	2945406	5
EMG 90-H 52MM GN	2944300	5
P 1-EMG 90	2946272	1
MKDS 3/ 2	1711026	100
MKDS 3/ 3	1711039	100
MKDS 3/ 4	1711042	50
EMG 90-ZE	2941824	5
EMG-KA	2941510	50
EMG-GKS 12	2947035	50
EMG-GKS 22	2941594	50

Basic housings for universal use

EMG system component housing

Notes:
Tightening torque of terminal block screws refer to page 854.
Marking systems and mounting materials: see Catalog 5.
1) For information on power dissipation, see page 770.

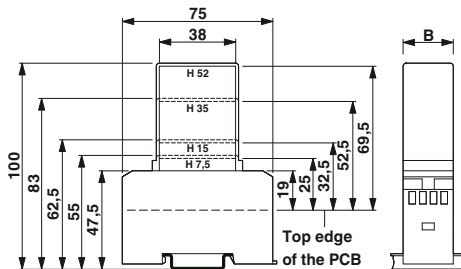

B= Width



38-pos., width: 100 mm

Power dissipation P_v at 20°C in horizontal mounting position ¹⁾	H 7,5	H 15	H 35	H 52
Mounted in rows without spacing	6.9 W	8 W	-	8.9 W
Mounted in rows with min. 20 mm spacing	7.8 W	8.4 W	-	9.8 W
Type of housing	Polycarbonate fiber reinforced / V0			
Electronic housings	Polycarbonate fiber reinforced PC-F / V0			
Green cover	Polycarbonate, PC / V2			
Transparent cover	8 mm			
Stripping length	solid	stranded	I	U
Connection data		[mm ²]	AWG	[A] [V]
	0.2 - 4	0.2 - 2.5	24 - 12	-

Technical data				
H 7,5	H 15	H 35	H 52	
6.9 W	8 W	-	8.9 W	
7.8 W	8.4 W	-	9.8 W	
Polycarbonate fiber reinforced / V0				
Polycarbonate fiber reinforced PC-F / V0				
Polycarbonate, PC / V2				
8 mm				
	solid	stranded	I	U
		[mm ²]	AWG	[A] [V]
	0.2 - 4	0.2 - 2.5	24 - 12	-

Description	Grid [mm]	No. of pos.	Width [mm]
Electronic housing , for PCB insertion, without screw connection terminal blocks and cover	5	38	100
	5	48	125
	5	58	150
Electronic housing , for PCB insertion, without screw connection terminal blocks and cover			100
			150
Electronic housing , for PCB insertion, without screw connection terminal blocks and cover			100
			125
			150
Electronic housing set , consisting of electronic housings and printed circuit termination blocks	5	38	100
			150
Custom circuit module , consisting of housing, Connecting terminal blocks MKDS 3 and printed circuit board with solder tags, for soldering in electronic components			100
	5		150

Ordering data		
Type	Order No.	Pcs. / Pkt.
EMG100-LG	2947080	5
EMG100-LG/O	2907567	5
EMG100-LG/MSTB	2907570	5
EMG100-LG/SET	2906283	5
EMG100-B19	2947093	2

Covering hood , for the contact and dust-protected encapsulation of the components	Height 7.5 mm, transparent		
	Height 15 mm, transparent		
	Height 35 mm, transparent		
	Height 52 mm, green		
PCB , for assembling electronic components			
5.0 mm pitch , color: green		2	
		3	
		4	
Terminal block/screw cover , set consisting of 50 strips each for terminal blocks and screw openings, 1 strip covers 12 terminal points			
Equipment marker		12	
		22	

Accessories		
Type	Order No.	Pcs. / Pkt.
EMG100-H 7,5MM KLAR	2944193	5
EMG100-H 15MM KLAR	2943152	5
EMG100-H 35MM KLAR	2942218	5
EMG100-H 52MM GN	2944724	5
P 1-EMG100	2947103	5
MKDS 3/ 2	1711026	100
MKDS 3/ 3	1711039	100
MKDS 3/ 4	1711042	50
EMG-KA	2941510	50
EMG-GKS 12	2947035	50
EMG-GKS 22	2941594	50



48-pos., width: 125 mm



58-pos., width: 150 mm

Technical data				
H 7,5	H 15	H 35	H 52	
9.5 W	10.6 W	-	11.6 W	
11 W	12.4 W	-	13 W	
Polycarbonate fiber reinforced / V0				
Polycarbonate fiber reinforced PC-F / V0				
Polycarbonate, PC / V2				
8 mm				
solid	stranded		I	U
	[mm²]	AWG	[A]	[V]
0.2 - 4	0.2 - 2.5	24 - 12	-	-

Technical data				
H 7,5	H 15	H 35	H 52	
12.3 W	13.1 W	-	13.6 W	
13.1 W	13.8 W	-	14.9 W	
Polycarbonate fiber reinforced / V0				
Polycarbonate fiber reinforced PC-F / V0				
Polycarbonate, PC / V2				
8 mm				
solid	stranded		I	U
	[mm²]	AWG	[A]	[V]
0.2 - 4	0.2 - 2.5	24 - 12	-	-

Ordering data		
Type	Order No.	Pcs. / Pkt.
EMG125-LG	2947983	2
EMG125-LG/MSTB	2943288	2
EMG125-B24	2947996	2

Ordering data		
Type	Order No.	Pcs. / Pkt.
EMG150-LG	2946023	2
EMG150-LG/O	2906571	2
EMG150-LG/MSTB	2907596	2
EMG150-B29	2946036	2

Accessories		
EMG125-H 7,5MM KLAR	2943194	5
EMG125-H 15MM KLAR	2943181	5
EMG125-H 52MM GN	2943518	5
P 1-EMG125	2946010	5
MKDS 3/ 2	1711026	100
MKDS 3/ 3	1711039	100
MKDS 3/ 4	1711042	50
EMG-KA	2941510	50
EMG-GKS 12	2947035	50
EMG-GKS 22	2941594	50

Accessories		
EMG150-H 7,5MM KLAR	2943178	5
EMG150-H 15MM KLAR	2943165	5
EMG150-H 52MM GN	2943521	5
P 1-EMG150	2946049	5
MKDS 3/ 2	1711026	100
MKDS 3/ 3	1711039	100
MKDS 3/ 4	1711042	50
EMG-KA	2941510	50
EMG-GKS 12	2947035	50
EMG-GKS 22	2941594	50

Basic housings for universal use



EG beaker-type component housing

EG component housing is a range of industrial design housing in which a large number of professional industrial electronic components can be accommodated. This housing series includes a whole range of special functional features that support the production of series devices as well as practical applications in the control cabinet.

Key features:

- Tool-free mounting
- Functional and industry-oriented housing technology
- Optimum accommodation of electronic components with graded pitches with a design width of 22.5 mm, 45 mm, 67.5 mm, and 90 mm
- Practical and easy-to-wire conductor connection using extra finely stranded sturdy screw terminal blocks up to 2.5 mm²
- Shock and contamination-proof accommodation of electronic components (IP40 housing, IP20 terminal blocks)
- Fast snap-on mounting on symmetrical DIN rails according to EN 60715
- Date of manufacture and material and part identification embossed on housing (recyclability)

Materials

In the case of EG... electronics housing, you can choose between the standard EG...ABS version and the EG...PC version. The ABS version is suitable for maximum operating temperatures of up to 80°C.

The EG...PC version offers the following features:

- Inflammability class V0 according to UL 94
- Can be used up to a maximum operating temperature of 115°C
- Integrated metal foot catch, which ensures a firm hold on the DIN rail even at high ambient temperatures

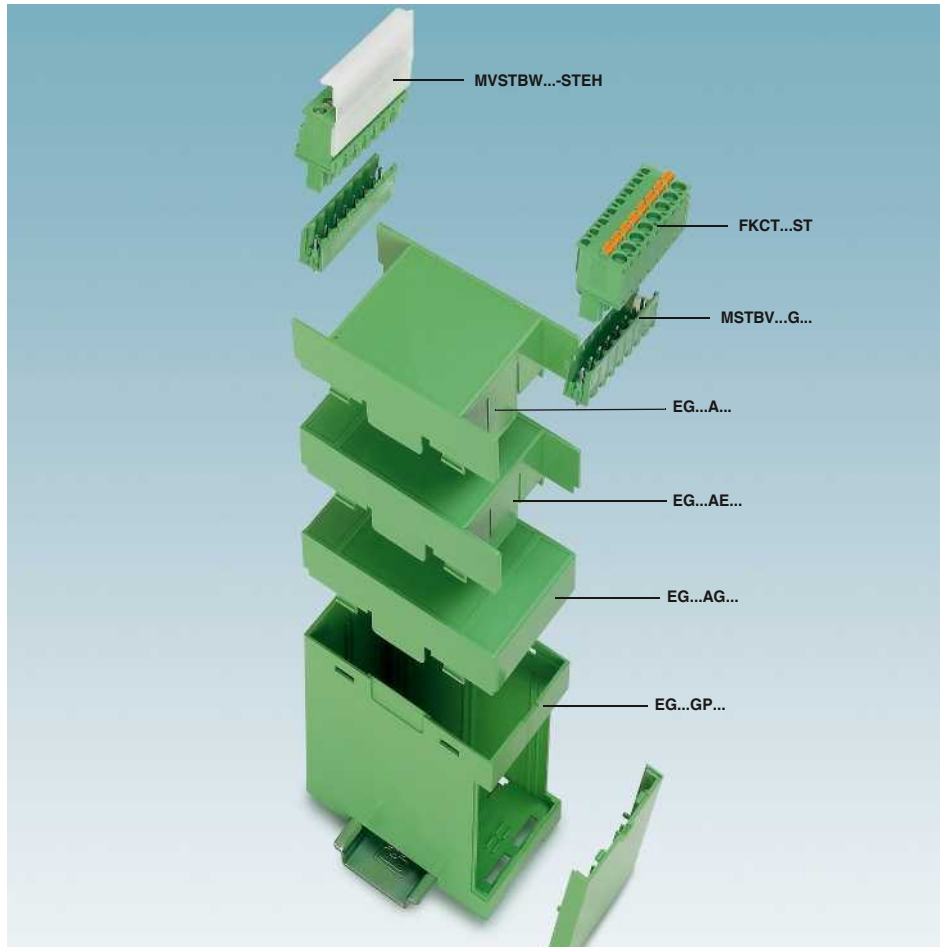

Construction principle

The exploded view shows the construction principle of the housing. The base accommodates horizontally or vertically assembled PCBs including the connection elements. The cover is snapped onto the base securely and reliably.

Mounting

EG beaker-type component housing is aligned by snapping it onto symmetrical DIN rails according to EN 60715. It is removed by drawing back the foot element.

Accommodating electronic components

According to requirements, EG component housing can be combined with different types of individual housing elements. The housing bases are available with or without a test opening on the front. Housing with a test opening offers the option of tuning or readjusting pre-assembled devices during function testing or operation, e.g., by means of internal potentiometers or jumper panels.

A number of PCB guides in the housing provide flexibility for accommodating complex electronic components.

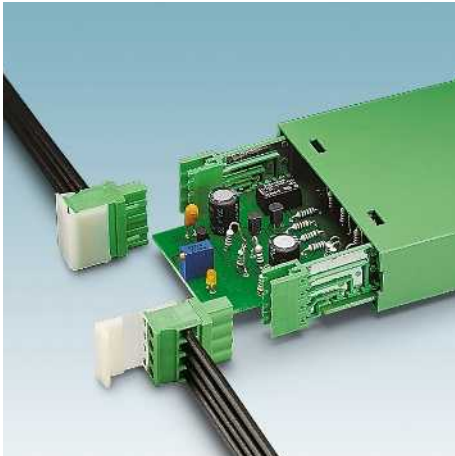

The PCBs installed in EG component housing are rectangular.

Details of PCB dimensions and assembly areas, as well as their position in the housing can be found in the Download Center at www.phoenixcontact.net/products.

COMBICON headers with right-angled pin strip enable device designs with just one vertically inserted PCB with optimum use of space.

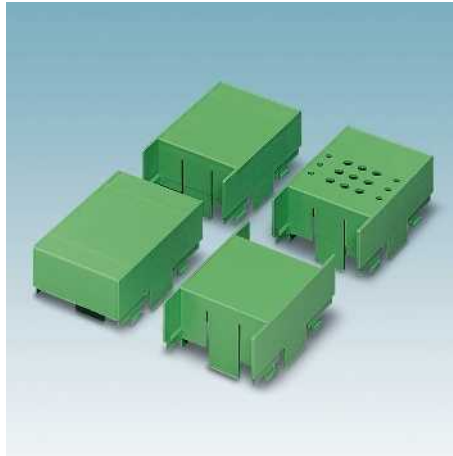

Covers

The covers, which are snapped onto the housing base, are either closed or have connection options on one or both sides. In addition, holes can be made in the front, e.g., for LEDs, potentiometer axes, etc. For this application, the cover offers the option of inserting a PCB underneath the holes.

Conductor connections

The connection elements fit the housing design perfectly and are available in the following versions:

- Sturdy 2.5 mm² screw connections in the form of the MKKDSH 3 PCB terminal block with 5 mm pitch
- Practical plug-in screw connection using COMBICON

The COMBICON connections are available in the following versions:

- COMBICON headers for use on horizontal or vertical PCBs
- COMBICON plugs with or without a hinged release aid

The connection elements can always be assembled together with the electronic components on the PCB and soldered together.

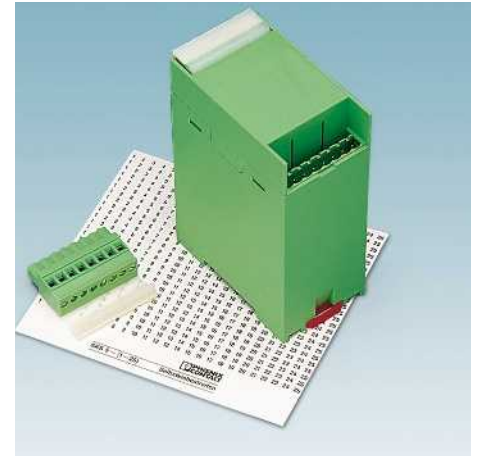

Marking

The connection terminal blocks are marked on the marking areas provided using standard and individually printed SK 5 marker strips. With larger orders, direct printing on the housing is also possible.

Basic housings for universal use

EG beaker-type component housing

More housing dimensions, the layout of the PCBs, their dimensions and assembly areas can be found in the download center at:
www.phoenixcontact.net/products

Notes:
Tightening torque of terminal block screws refer to page 854.
Marking systems and mounting materials: see Catalog 5.
COMBICON plug connectors may only be activated under no load conditions. If for operating reasons small loads must be switched, empirical values are available upon request.
1) For information on power dissipation, see page 770.
2) Please observe the current carrying capacity curves. Further current carrying capacity curves on request.

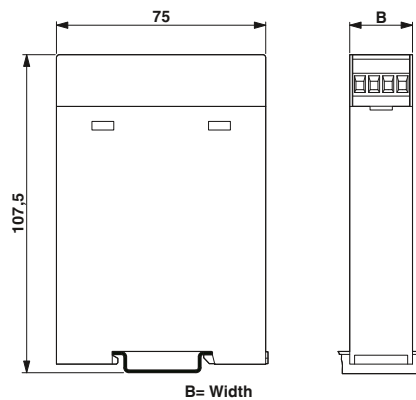

8-pos., width: 22.5 mm



Power dissipation P_v at 20°C in horizontal mounting position¹⁾

Mounted in rows without spacing
 Mounted in rows with min. 20 mm spacing

Type of housing
 Electronic housings
 Connection data

MKKDS...
 MSTBV...
 FKCT...

Technical data

EG 22,5-G/ABS GN					
Acryl butadiene styrene (ABS) / HB					
	solid	stranded	AWG	I	U
				[A]	[V]
1.7 W	-	-	24 - 12	24 ²⁾	250
2.7 W	-	-	24 - 12	12	250
0.2 - 4		0.2 - 2.5	24 - 12	12	250
0.2 - 2.5		0.2 - 2.5	24 - 12	12	250
0.2 - 2.5		0.2 - 2.5	24 - 12	12	250

Description	Grid [mm]	No. of pos.	Width [mm]
Housing base , with snap-on foot			
Housing base , with snap-on foot and test opening with side cover			
Housing cover , for connection on one side			
Housing cover , for connection on both sides			
Housing cover , closed			

Ordering data

Type	Order No.	Pcs. / Pkt.
EG 22,5-G/ABS GN	2764043	10
EG 22,5-GP/ABS GN	2764056	10
EG 22,5-AE/ABS GN	2907046	25
EG 22,5-A/ABS GN	2764072	25
EG 22,5-AG/ABS GN	2906636	10

COMBICON headers, with right-angled pin strip

Right
 Left

COMBICON headers

COMBICON plug
 5.0 mm pitch

4
 8
 9
 13
 17

COMBICON plug
 5.08 mm pitch

4
 8

COMBICON spring-cage plugs, with test connection, 5.0 mm pitch

COMBICON spring-cage plugs, with test connection, 5.08 mm pitch

COMBICON plug, with hinged release aid

Coding section, for COMBICON headers, is inserted into the recess on the header

Coding profile, for COMBICON headers, is inserted into the slot on the plug, red insulating material

Printed circuit termination block, for soldering into the printed circuit board, 5.0 mm pitch

2-pos.
 3-pos.
 8-pos.

Accessories

	Order No.	Pcs. / Pkt.
MSTBO 2,5/ 4-GR-5,08	1847123	50
MSTBO 2,5/ 4-GL-5,08	1850453	50
MSTBV 2,5/ 4-G	1753479	250
MVSTBW 2,5/ 4-ST	1792540	50
MVSTBW 2,5/ 4-ST-5,08	1792773	50
FKCT 2,5/ 4-ST	1909236	50
FKCT 2,5/ 4-ST-5,08	1902136	50
MVSTBW 2,5/ 4-STEH	1784299	50
MVSTBW 2,5/ 4-STEH-5,08	1851850	50
CR-MSTB	1734401	100
CP-MSTB	1734634	100
MKKDSH 3/ 2	1721045	50
MKKDSH 3/ 3	1721346	50



16-pos., width: 45 mm



26-pos., width: 67.5 mm



34-pos., width: 90 mm



Technical data					
EG 45-G/ABS GN					
3.4 W	-	-	-	-	-
6.1 W	-	-	-	-	-
Acryl butadiene styrene (ABS) / HB					
solid	stranded		I	U	
	[mm ²]	AWG	[A]	[V]	
0.2 - 4	0.2 - 2.5	24 - 12	24 ²⁾	250	
0.2 - 2.5	0.2 - 2.5	24 - 12	12	250	
0.2 - 2.5	0.2 - 2.5	24 - 12	12	250	

Technical data					
EG 67,5-G/ABS GN					
5 W	-	-	-	-	-
7.5 W	-	-	-	-	-
Acryl butadiene styrene (ABS) / HB					
solid	stranded		I	U	
	[mm ²]	AWG	[A]	[V]	
0.2 - 4	0.2 - 2.5	24 - 12	24 ²⁾	250	
0.2 - 2.5	0.2 - 2.5	24 - 12	12	250	
0.2 - 2.5	0.2 - 2.5	24 - 12	12	250	

Technical data					
EG 90-G/ABS GN					
6 W	-	-	-	-	-
9.1 W	-	-	-	-	-
Acryl butadiene styrene (ABS) / HB					
solid	stranded		I	U	
	[mm ²]	AWG	[A]	[V]	
0.2 - 4	0.2 - 2.5	24 - 12	24 ²⁾	250	
0.2 - 2.5	0.2 - 2.5	24 - 12	12	250	
0.2 - 2.5	0.2 - 2.5	24 - 12	12	250	

Ordering data		
Type	Order No.	Pcs. / Pkt.
EG 45-G/ABS GN	2764140	10
EG 45-GP/ABS GN	2764153	10
EG 45-AE/ABS GN	2764409	10
EG 45-A/ABS GN	2764179	10
EG 45-AG/ABS GN	2907363	10

Ordering data		
Type	Order No.	Pcs. / Pkt.
EG 67,5-G/ABS GN	2764292	5
EG 67,5-GP/ABS GN	2764302	5
EG 67,5-AE/ABS GN	2907347	10
EG 67,5-A/ABS GN	2764357	10
EG 67,5-AG/ABS GN	2907376	10

Ordering data		
Type	Order No.	Pcs. / Pkt.
EG 90-G/ABS GN	2764328	10
EG 90-GP/ABS GN	2764315	10
EG 90-AE/ABS GN	2907350	10
EG 90-A/ABS GN	2764399	10
EG 90-AG/ABS GN	2907389	10

Accessories		
MSTBO 2,5/ 8-GR-5,08	1847165	50
MSTBO 2,5/ 8-GL-5,08	1850495	50
MSTBV 2,5/ 8-G	1753550	100
MVSTBW 2,5/ 8-ST	1792582	50
MVSTBW 2,5/ 8-ST-5,08	1792812	50
FKCT 2,5/ 8-ST	1909278	50
FKCT 2,5/ 8-ST-5,08	1902178	50
MVSTBW 2,5/ 8-STEH	1784309	50
CR-MSTB	1734401	100
CP-MSTB	1734634	100
MKKDSH 3/ 2	1721045	50
MKKDSH 3/ 3	1721346	50
MKKDSH 3/ 8	1703283	50

Accessories		
MSTBV 2,5/13-G	1753657	50
MVSTBW 2,5/ 4-ST	1792540	50
MVSTBW 2,5/ 9-ST	1792595	50
MVSTBW 2,5/13-ST	1792634	50
FKCT 2,5/13-ST	1909320	50
FKCT 2,5/13-ST-5,08	1902220	50
MVSTBW 2,5/ 4-STEH	1784299	50
MVSTBW 2,5/ 9-STEH	1763401	50
CR-MSTB	1734401	100
CP-MSTB	1734634	100
MKKDSH 3/ 2	1721045	50
MKKDSH 3/ 3	1721346	50
MKKDSH 3/ 8	1703283	50

Accessories		
MSTBV 2,5/17-G	1753738	50
MVSTBW 2,5/ 8-ST	1792582	50
MVSTBW 2,5/ 9-ST	1792595	50
MVSTBW 2,5/17-ST	1792676	50
FKCT 2,5/17-ST	1909362	50
FKCT 2,5/17-ST-5,08	1902262	50
MVSTBW 2,5/ 8-STEH	1784309	50
MVSTBW 2,5/ 9-STEH	1763401	50
CR-MSTB	1734401	100
CP-MSTB	1734634	100
MKKDSH 3/ 2	1721045	50
MKKDSH 3/ 3	1721346	50
MKKDSH 3/ 8	1703283	50

Basic housings for universal use

EG beaker-type component housing

More housing dimensions, the layout of the PCBs, their dimensions and assembly areas can be found in the download center at:
www.phoenixcontact.net/products

Notes:
Tightening torque of terminal block screws refer to page 854.
Marking systems and mounting materials: see Catalog 5.
COMBICON plug connectors may only be activated under no load conditions. If for operating reasons small loads must be switched, empirical values are available upon request.
1) For information on power dissipation, see page 770.
2) Please observe the current carrying capacity curves. Further current carrying capacity curves on request.

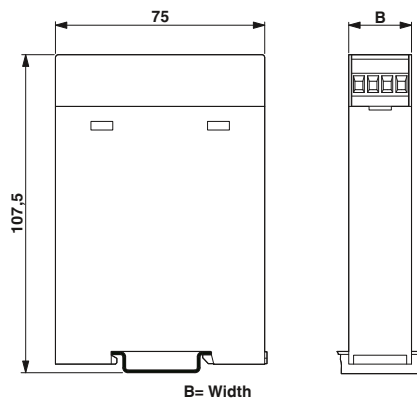

8-pos., width: 22.5 mm



Power dissipation P_v at 20°C in horizontal mounting position¹⁾

Mounted in rows without spacing
 Mounted in rows with min. 20 mm spacing

Type of housing
 Electronic housings
 Connection data

MKKDS...
 MSTBV...
 FKCT...

Technical data

EG 22,5-GMF/PC GN		EG 22,5-GMFP/PC GN		EG 22,5-AE/PC GN		EG 22,5-A/PC GN		EG 22,5-AG/PC GN	
1.7 W	-	-	-	-	-	-	-	-	-
2.7 W	-	-	-	-	-	-	-	-	-
polycarbonate / V0									
solid		stranded		I		U			
[mm ²]		AWG		[A]		[V]			
0.2 - 4	0.2 - 2.5	24 - 12	24 ²⁾	250					
0.2 - 2.5	0.2 - 2.5	24 - 12	12	250					
0.2 - 2.5	0.2 - 2.5	24 - 12	12	250					

Description	Grid [mm]	No. of pos.	Width [mm]
Lower housing part , with metal foot catch			
Housing base , with metal foot catch and test opening with side cover			
Housing cover For connection on one side			
Housing cover For connection on both sides			
Housing cover , closed			

Ordering data

Type	Order No.	Pcs. / Pkt.
EG 22,5-GMF/PC GN	2764797	10
EG 22,5-GMFP/PC GN	2764807	10
EG 22,5-AE/PC GN	2764810	10
EG 22,5-A/PC GN	2764823	10
EG 22,5-AG/PC GN	2764836	25

COMBICON headers, with right-angled pin strip

Right
 Left

COMBICON headers

COMBICON plug

5.0 mm pitch

4
 8
 9
 13
 17

COMBICON plug

5.08 mm pitch

4
 8

COMBICON spring-cage plugs, with test connection, 5.0 mm pitch

COMBICON spring-cage plugs, with test connection, 5.08 mm pitch

COMBICON plug, with hinged release aid

Coding section, for COMBICON headers, is inserted into the recess on the header

Coding profile, for COMBICON headers, is inserted into the slot on the plug, red insulating material

Printed circuit termination block, for soldering into the printed circuit board, 5.0 mm pitch

2-pos.
 3-pos.
 8-pos.

Accessories

Type	Order No.	Pcs. / Pkt.
MSTBO 2,5/ 4-GR-5,08	1847123	50
MSTBO 2,5/ 4-GL-5,08	1850453	50
MSTBV 2,5/ 4-G	1753479	250
MVSTBV 2,5/ 4-ST	1792540	50
MVSTBW 2,5/ 4-ST-5,08	1792773	50
FKCT 2,5/ 4-ST	1909236	50
FKCT 2,5/ 4-ST-5,08	1902136	50
MVSTBV 2,5/ 4-STEH	1784299	50
MVSTBV 2,5/ 4-STEH-5,08	1851850	50
CR-MSTB	1734401	100
CP-MSTB	1734634	100
MKKDSH 3/ 2	1721045	50
MKKDSH 3/ 3	1721346	50



16-pos., width: 45 mm



26-pos., width: 67.5 mm



34-pos., width: 90 mm



Technical data					
EG 45-GMF/PC GN					
3.4 W	-	-	-	-	-
6.1 W	-	-	-	-	-
polycarbonate / V0					
solid	stranded	AWG	I [A]	U [V]	
[mm ²]					
0.2 - 4	0.2 - 2.5	24 - 12	24 ²⁾	250	
0.2 - 2.5	0.2 - 2.5	24 - 12	12	250	
0.2 - 2.5	0.2 - 2.5	24 - 12	12	250	

Technical data					
EG 67,5-GMF/PC GN					
5 W	-	-	-	-	-
7.5 W	-	-	-	-	-
polycarbonate / V0					
solid	stranded	AWG	I [A]	U [V]	
[mm ²]					
0.2 - 4	0.2 - 2.5	24 - 12	24 ²⁾	250	
0.2 - 2.5	0.2 - 2.5	24 - 12	12	250	
0.2 - 2.5	0.2 - 2.5	24 - 12	12	250	

Technical data					
EG 90-GMF/PC GN					
6 W	-	-	-	-	-
9.1 W	-	-	-	-	-
polycarbonate / V0					
solid	stranded	AWG	I [A]	U [V]	
[mm ²]					
0.2 - 4	0.2 - 2.5	24 - 12	24 ²⁾	250	
0.2 - 2.5	0.2 - 2.5	24 - 12	12	250	
0.2 - 2.5	0.2 - 2.5	24 - 12	12	250	

Ordering data		
Type	Order No.	Pcs. / Pkt.
EG 45-GMF/PC GN	2764849	10
EG 45-GMFP/PC GN	2764852	10
EG 45-AE/PC GN	2764865	10
EG 45-A/PC GN	2764878	10
EG 45-AG/PC GN	2764881	10

Ordering data		
Type	Order No.	Pcs. / Pkt.
EG 67,5-GMF/PC GN	2764894	10
EG 67,5-GMFP/PC GN	2764917	10
EG 67,5-AE/PC GN	2764920	10
EG 67,5-A/PC GN	2764933	10
EG 67,5-AG/PC GN	2764946	10

Ordering data		
Type	Order No.	Pcs. / Pkt.
EG 90-GMF/PC GN	2764959	10
EG 90-GMFP/PC GN	2764962	10
EG 90-AE/PC GN	2764975	10
EG 90-A/PC GN	2764988	10
EG 90-AG/PC GN	2764991	10

Accessories		
MSTBO 2,5/ 8-GR-5,08	1847165	50
MSTBO 2,5/ 8-GL-5,08	1850495	50
MSTBV 2,5/ 8-G	1753550	100
MVSTBW 2,5/ 8-ST	1792582	50
MVSTBW 2,5/ 8-ST-5,08	1792812	50
FKCT 2,5/ 8-ST	1909278	50
FKCT 2,5/ 8-ST-5,08	1902178	50
MVSTBW 2,5/ 8-STEH	1784309	50
CR-MSTB	1734401	100
CP-MSTB	1734634	100
MKKDSH 3/ 2	1721045	50
MKKDSH 3/ 3	1721346	50
MKKDSH 3/ 8	1703283	50

Accessories		
MSTBV 2,5/13-G	1753657	50
MVSTBW 2,5/ 4-ST	1792540	50
MVSTBW 2,5/ 9-ST	1792595	50
MVSTBW 2,5/13-ST	1792634	50
FKCT 2,5/13-ST	1909320	50
FKCT 2,5/13-ST-5,08	1902220	50
MVSTBW 2,5/ 4-STEH	1784299	50
MVSTBW 2,5/ 9-STEH	1763401	50
CR-MSTB	1734401	100
CP-MSTB	1734634	100
MKKDSH 3/ 2	1721045	50
MKKDSH 3/ 3	1721346	50
MKKDSH 3/ 8	1703283	50

Accessories		
MSTBV 2,5/17-G	1753738	50
MVSTBW 2,5/ 8-ST	1792582	50
MVSTBW 2,5/ 9-ST	1792595	50
MVSTBW 2,5/17-ST	1792676	50
FKCT 2,5/17-ST	1909362	50
FKCT 2,5/17-ST-5,08	1902262	50
MVSTBW 2,5/ 8-STEH	1784309	50
MVSTBW 2,5/ 9-STEH	1763401	50
CR-MSTB	1734401	100
CP-MSTB	1734634	100
MKKDSH 3/ 2	1721045	50
MKKDSH 3/ 3	1721346	50
MKKDSH 3/ 8	1703283	50

Basic housings for universal use

Universal UEG component housing

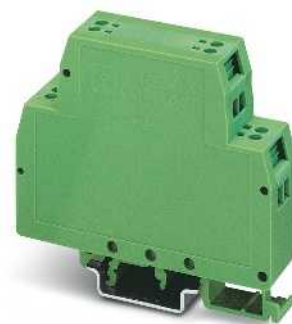
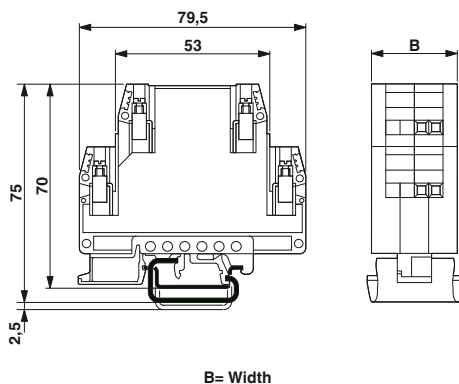
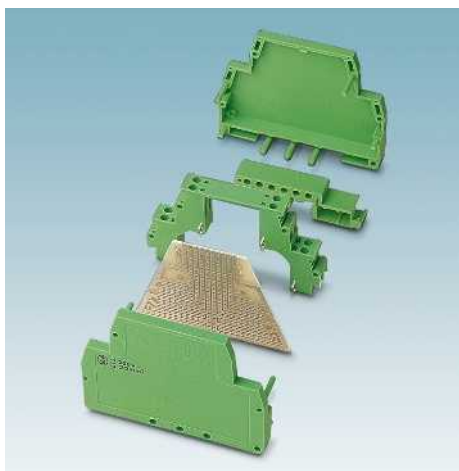

8-pos. with screw connection, width: 20 mm

The universal UEG electronic housing can be supplied in two design widths with screw or slip-on connection.

Main features:

- Housing width of 20 mm or 30 mm
 - Up to 16 connections on two levels
 - Economical series production, since the base element and the assembled PCB are soldered by machine
 - Efficient assembly, thanks to overlapping housing parts
 - Installation of one or two PCBs in the housing
 - Can be snapped onto commercially available NS 35/7,5 and NS 35/15 DIN rails
- Universal P1-UEG... PCBs are available for laboratory samples and small series.

More housing dimensions, the layout of the PCBs, their dimensions and assembly areas can be found in the download center at:
www.phoenixcontact.net/products

Notes:
Tightening torque of terminal block screws refer to page 854.
Marking systems and mounting materials: see Catalog 5.
1) For information on power dissipation, see page 770.
2) The nominal voltage applies to fully insulated slip-on sleeves. Voltage and current values are affected by the configuration of the printed circuit board.

Power dissipation P_v at 20°C in horizontal mounting position ¹⁾	UEG 20			
Mounted in rows without spacing	4 W	-	-	-
Mounted in rows with min. 20 mm spacing	6 W	-	-	-
Type of housing	Polyamide (PA 6.6) / V0			
Electronic housings	8 mm			
Stripping length				
Connection data	solid	stranded	I	U
		[mm ²]	AWG	[A]
	0.2 - 4	0.2 - 2.5	24 - 12	10
				500

Description
Electronic housing , fully equipped with 4 screw or 4 slip-on connections per side, for one printed circuit board
Electronic housing , fully equipped with 4 screw or 4 slip-on connections per side, for one printed circuit board
Electronic housing , fully equipped with 8 screw or 8 slip-on connections per side, for two printed circuit boards

PCB , for custom fitting electronic components
Insulating sleeve , as shock protection for 6.3 mm slip-on sleeves; slide over the cable first For 6.3 mm slip-on sleeves For 2.8 mm slip-on sleeves
Loop bridge , 50-pos., divisible, max. bridging distance 60 mm, 0.5 mm ² , insulation, black
Loop bridge , 50-pos., divisible, max. bridging distance 60 mm, 0.5 mm ² , insulation, gray
Zack marker strip, 10-section, unprinted : pack contains enough to label 100 terminal blocks

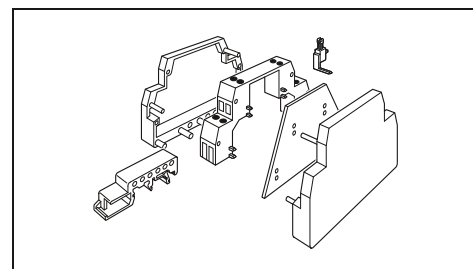

Technical data				
UEG 20				
4 W	-	-	-	-
6 W	-	-	-	-
Polyamide (PA 6.6) / V0				
8 mm				
solid	stranded	I	U	
	[mm ²]	AWG	[A]	[V]
0.2 - 4	0.2 - 2.5	24 - 12	10	500

Ordering data		
Type	Order No.	Pcs. / Pkt.
UEG 20	2790211	10

Accessories		
P 1-UEG	2790224	10
DB 50- 90 BK	2820916	1
DB 50- 90 GY	2820929	1
ZB 5 :UNBEDRUCKT	1050004	10



8- and 16-pos. with screw connection, width: 30 mm

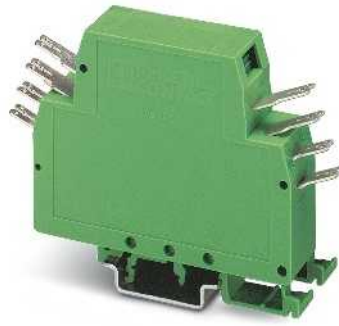

8-pos. with slotted 6.3/2.8 mm slip-on connection, width: 20 mm

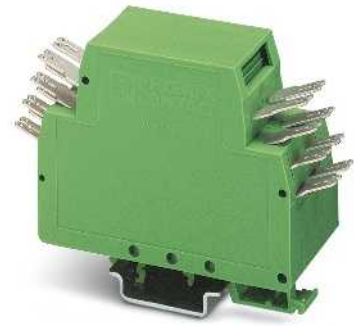

8- and 16-pos. with slotted 6.3/2.8 mm slip-on connection, width: 30 mm

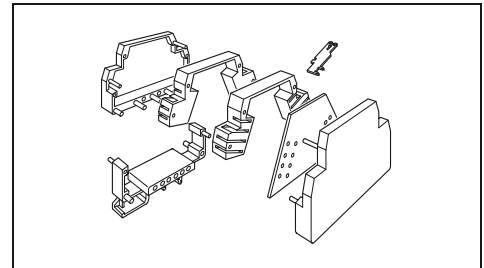
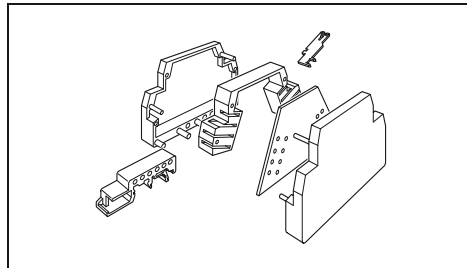
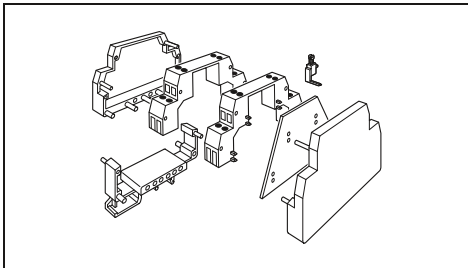

Technical data					
UEG 30/1		UEG 30/2			
4 W	4 W	-	-	-	-
7.2 W	7.2 W	-	-	-	-
Polyamide (PA 6.6) / V0					
8 mm					
solid	stranded		I	U	
	[mm ²]	AWG	[A]	[V]	
0.2 - 4	0.2 - 2.5	24 - 12	10	500	

Technical data					
UEG 20-FS/FS					
4.8 W	-	-	-	-	-
8 W	-	-	-	-	-
Polyamide (PA 6.6) / V0					
8 mm					
solid	stranded		I	U	
	[mm ²]	AWG	[A]	[V]	
0.2 - 4	0.2 - 2.5	24 - 12	10	500 ²⁾	

Technical data					
UEG 30/1-FS/FS		UEG 30/2-FS/FS			
4.8 W	4.8 W	-	-	-	-
8 W	8 W	-	-	-	-
Polyamide (PA 6.6) / V0					
8 mm					
solid	stranded		I	U	
	[mm ²]	AWG	[A]	[V]	
0.2 - 4	0.2 - 2.5	24 - 12	10	500 ²⁾	

Ordering data		
Type	Order No.	Pcs. / Pkt.
UEG 30/1	2790871	10
UEG 30/2	2790240	10

Ordering data		
Type	Order No.	Pcs. / Pkt.
UEG 20-FS/FS	2790266	10

Ordering data		
Type	Order No.	Pcs. / Pkt.
UEG 30/1-FS/FS	2790884	10
UEG 30/2-FS/FS	2790279	10

Accessories		
Type	Order No.	Pcs. / Pkt.
P 1-UEG	2790224	10
DB 50- 90 BK	2820916	1
DB 50- 90 GY	2820929	1
ZB 5 :UNBEDRUCKT	1050004	10

Accessories		
Type	Order No.	Pcs. / Pkt.
P 1-UEG-FS/FS	2790428	10
PT/FS 6,3	0604707	500
PT/FS 2,8	1406700	500
ZB 5 :UNBEDRUCKT	1050004	10

Accessories		
Type	Order No.	Pcs. / Pkt.
P 1-UEG-FS/FS	2790428	10
PT/FS 6,3	0604707	500
PT/FS 2,8	1406700	500
ZB 5 :UNBEDRUCKT	1050004	10

Basic housings for universal use

Universal UEGM component housing



The UEGM electronic housings supplement the UEG range and offer an enlarged internal area.

Main features:

- Four housing widths from 22.5 mm to 40 mm
- Choice of screw connections and/or slip-on connections
- Can be snapped onto commercially available NS 35/7,5 and NS 35/15 DIN rails
- Economical series production, since the base element and the assembled PCB are soldered by machine
- Efficient assembly, thanks to overlapping housing parts
- Complex electronic circuits can be integrated, with up to 24 connections on two levels

A P1-UEGM PCB is available for laboratory samples and small series.

More housing dimensions, the layout of the PCBs, their dimensions and assembly areas can be found in the download center at:

www.phoenixcontact.net/products

Notes:
Tightening torque of terminal block screws refer to page 854.
Marking systems and mounting materials: see Catalog 5.
1) For information on power dissipation, see page 770.
2) The nominal voltage applies to fully insulated slip-on sleeves. Voltage and current values are affected by the configuration of the printed circuit board.

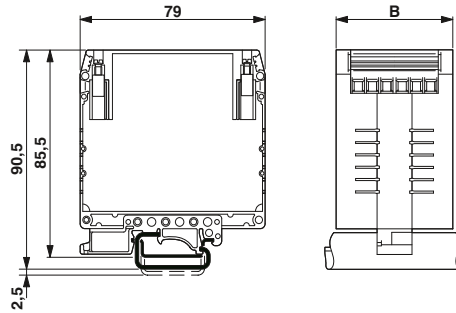

B= Width



6-pos. with screw connection, width: 22.5 mm, 25 mm, and 27.5 mm

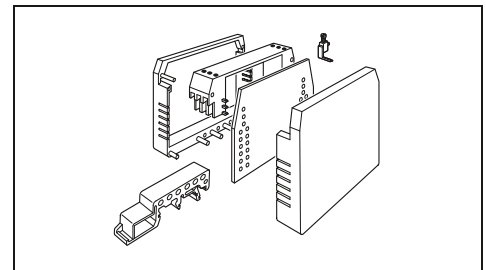

Power dissipation P_V at 20°C in horizontal mounting position ¹⁾
Mounted in rows without spacing
Mounted in rows with min. 20 mm spacing
Type of housing
Electronic housings
Stripping length
Connection data

Technical data				
UEGM 22,5	UEGM 25			
4 W	4 W	-	-	
10 W	10 W	-	-	
Polyamide (PA 6.6) / V0				
8 mm				
solid	stranded		I	U
	[mm ²]	AWG	[A]	[V]
0.2 - 4	0.2 - 2.5	24 - 12	10	500

Description
Electronic housing , fully equipped with 3 screw or 6 slip-on connections per side, for one printed circuit board
22.5 mm wide
Electronic housing , fully equipped with 3 screw or 6 slip-on connections per side, for one printed circuit board
25 mm wide
27.5 mm wide
Electronic housing , fully equipped with 3 screw or 6 slip-on connections per side, for one printed circuit board
40 mm wide
Electronic housing , fully equipped with 6 screw or 12 slip-on connections per side, for two printed circuit boards
40 mm wide

Ordering data		
Type	Order No.	Pcs. / Pkt.
UEGM 22,5	2792002	10
UEGM 25	2792015	10
UEGM 27,5-SMD	2757063	10

PCB , for custom fitting electronic components
Insulating sleeve , as shock protection for 6.3 mm slip-on sleeves; slide over the cable first
For 6.3 mm slip-on sleeves
For 2.8 mm slip-on sleeves
Metal for slip-on connection , to increase the number of positions
Loop bridge , 50-pos., divisible, max. bridging distance 60 mm, 0.5 mm ² , insulation, black
Loop bridge , 50-pos., divisible, max. bridging distance 60 mm, 0.5 mm ² , insulation, gray

Accessories		
P 1-UEGM	Order No.	Pcs. / Pkt.
	2792109	10
PT/FS 6,3	0604707	500
PT/FS 2,8	1406700	500
UEG-MT-FS	2790389	100
DB 50- 90 BK	2820916	1
DB 50- 90 GY	2820929	1



6- and 12-pos. with screw connection, width: 40 mm



12-pos. with slotted 6.3/2.8 mm slip-on connection, width: 22.5 mm and 25 mm

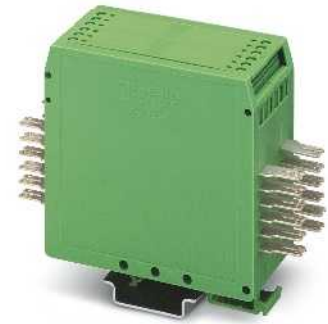

12- and 24-pos. with slotted 6.3/2.8 mm slip-on connection, width: 40 mm

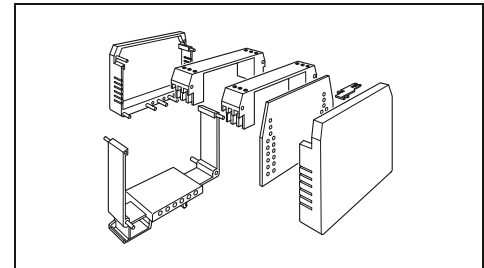
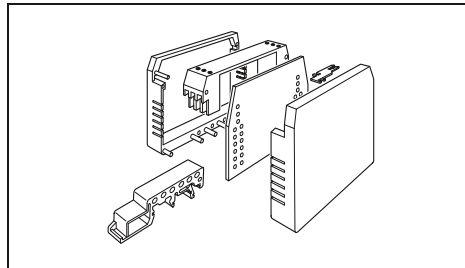
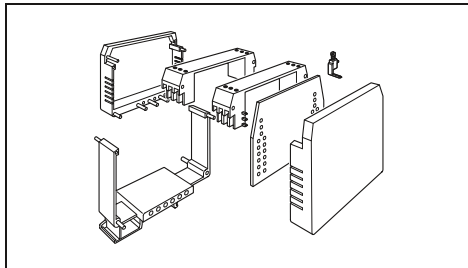

Technical data					
UEGM 40/1	UEGM 40/2				
5.2 W	5.2 W	-	-		
11.2 W	11.2 W	-	-		
Polyamide (PA 6.6) / V0					
8 mm					
solid	stranded		I	U	
	[mm ²]	AWG	[A]	[V]	
0.2 - 4	0.2 - 2.5	24 - 12	10	500	

Technical data					
UEGM 22,5-FS/FS	UEGM 25-FS/FS				
4 W	4 W	-	-		
10 W	10 W	-	-		
Polyamide (PA 6.6) / V0					
-					
solid	stranded		I	U	
	[mm ²]	AWG	[A]	[V]	
0.2 - 4	0.2 - 2.5	24 - 12	10	500 ²⁾	

Technical data					
UEGM 40/1-FS/FS	UEGM 40/2-FS/FS				
5.2 W	5.2 W	-	-		
11.2 W	11.2 W	-	-		
Polyamide (PA 6.6) / V0					
-					
solid	stranded		I	U	
	[mm ²]	AWG	[A]	[V]	
0.2 - 4	0.2 - 2.5	24 - 12	10	500 ²⁾	

Ordering data		
Type	Order No.	Pcs. / Pkt.
UEGM 40/1	2792112	10
UEGM 40/2	2792028	10

Ordering data		
Type	Order No.	Pcs. / Pkt.
UEGM 22,5-FS/FS	2792073	10
UEGM 25-FS/FS	2792086	10

Ordering data		
Type	Order No.	Pcs. / Pkt.
UEGM 40/1-FS/FS	2792125	10
UEGM 40/2-FS/FS	2792099	10

Accessories		
P 1-UEGM	2792109	10
PT/FS 6,3	0604707	500
PT/FS 2,8	1406700	500
UEG-MT-FS	2790389	100
DB 50- 90 BK	2820916	1
DB 50- 90 GY	2820929	1

Accessories		
P 1-UEGM	2792109	10
PT/FS 6,3	0604707	500
PT/FS 2,8	1406700	500

Accessories		
P 1-UEGM	2792109	10
PT/FS 6,3	0604707	500
PT/FS 2,8	1406700	500

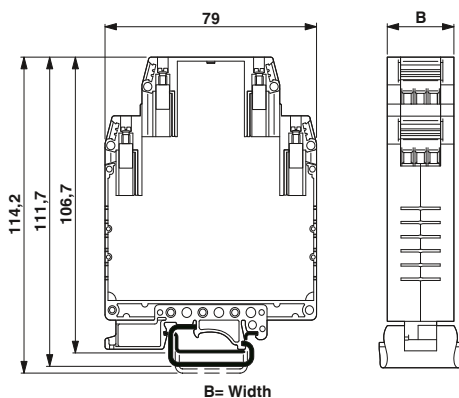
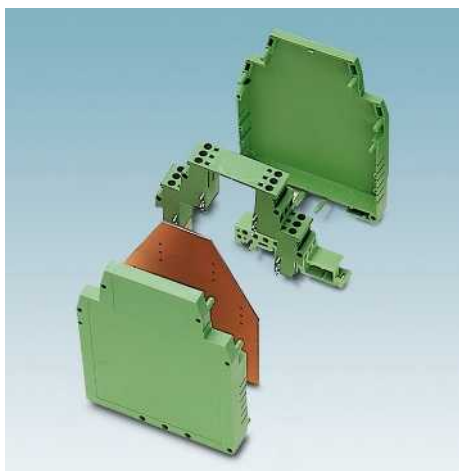

12-pos. with screw connection, widths:
22.5 mm, 25 mm, and 27.5 mm



The UEGH double-level electronic housing offers double connection options for extensive electronic circuits.

Main features:

- Six housing widths from 22.5 mm to 45 mm
 - 12 or 24 screw connections available
 - Increased number of positions, thanks to optional UEGM-MT FS slip-on connections
 - Can accommodate up to two PCBs
 - UEGH...-SMD versions offer space for PCBs equipped with SMDs on both sides
 - Efficient assembly, thanks to overlapping housing parts
 - Can be snapped onto commercially available NS 35/7,5 and NS 35/15 DIN rails
- A P1-UEGH PCB is available for laboratory samples and small series

More housing dimensions, the layout of the PCBs, their dimensions and assembly areas can be found in the download center at:

www.phoenixcontact.net/products

Notes:
Tightening torque of terminal block screws refer to page 854.
Marking systems and mounting materials: see Catalog 5.
¹⁾ For information on power dissipation, see page 770.

Power dissipation P_V at 20°C in horizontal mounting position¹⁾

Mounted in rows without spacing
Mounted in rows with min. 20 mm spacing

Type of housing
Electronic housings
Stripping length
Connection data

Technical data				
UEGH 22,5	UEGH 25	UEGH 27,5-SMD		
4.6 W	4.8 W	5 W	-	
6.7 W	7.2 W	7.5 W	-	
Polyamide (PA 6.6) / V0				
8 mm				
		solid	stranded	
				I U
		[mm ²]	AWG	[A] [V]
		0.2 - 4	0.2 - 2.5	24 - 12 10 500

Description	Grid [mm]	No. of pos.	Width [mm]
Electronic double-level housing , fully equipped with 6 screw connections per side, for one PCB			
	5	12	22.5
	5	12	25
Electronic double-level housing , fully equipped with 6 screw connections per side, for one printed circuit board, with a wider side element for equipping the PCB with SMD components			
	5	12	27.5
Electronic double-level housing , fully equipped with 6 screw connections per side, for one PCB			
	5	12	40
Electronic double-level housing , fully equipped with 12 screw connections per side, for two PCBs			
	5	24	40
Electronic double-level housing , 6 screw connections per side, with a wider side element for equipping the PCB with SMD components			
	5	12	42.5
Electronic double-level housing , fully equipped with 12 screw connections per side, for two printed circuit boards, with a wider side element for equipping the PCB with SMD components			
	5	24	42.5
Electronic double-level housing , fully equipped with 12 screw connections per side, for two printed circuit boards, for mounting two 7.5 mm side elements			
	5	24	45

Ordering data

Type	Order No.	Pcs. / Pkt.
UEGH 22,5	2757102	10
UEGH 25	2757115	10
UEGH 27,5-SMD	2757128	10

PCB , for custom fitting electronic components	
Loop bridge , 50-pos., divisible, max. bridging distance 60 mm, 0.5 mm ² , insulation, black	
Loop bridge , 50-pos., divisible, max. bridging distance 60 mm, 0.5 mm ² , insulation, gray	
Metal for slip-on connection , to increase the number of positions	
Zack marker strip, 10-section, unprinted : pack contains enough to label 100 terminal blocks	5

Accessories

P 1-UEGH	2757335	10
DB 50- 90 BK	2820916	1
DB 50- 90 GY	2820929	1
UEG-MT-FS	2790389	100
ZB 5 :UNBEDRUCKT	1050004	10



12- and 24-pos. with screw connection,
widths: 40 mm, 42.5 mm, and 45 mm



Technical data

UEGH 40/1	UEGH 40/2	UEGH 42,5/1-SMD	UEGH 45/2-SMD
6.1 W	6.1 W	6.3 W	6.5 W
9.1 W	9.1 W	9.5 W	9.8 W

Polyamide (PA 6.6) / V0
8 mm

solid	stranded		I	U
	[mm ²]	AWG	[A]	[V]
0.2 - 4	0.2 - 2.5	24 - 12	10	500

Ordering data

Type	Order No.	Pcs. / Pkt.
UEGH 40/1	2757144	10
UEGH 40/2	2757131	10
UEGH 42,5/1-SMD	2757157	10
UEGH 42,5/2-SMD	2757160	10
UEGH 45/2-SMD	2757173	10

Accessories

P 1-UEGH	2757335	10
DB 50- 90 BK	2820916	1
DB 50- 90 GY	2820929	1
UEG-MT-FS	2790389	100
ZB 5 :UNBEDRUCKT	1050004	10

Basic housings for universal use

Universal component housing UEGM-MSTB

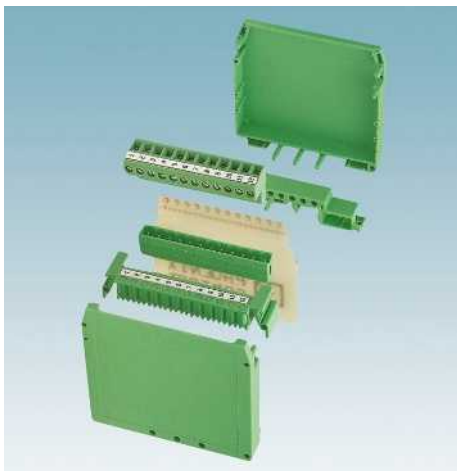

The UEGM-MSTB electronic housing supplements the UEG range by offering an additional pluggable version

Main features:

- The integrated pin strip makes it possible to use 2- to 12-pos. COMBICON plug-in connectors
- Integration of 3 mm LEDs (max. leg length of 29 mm)
- LED cutouts that are not required can be closed with UEGM MSTB-BS filler plugs
- Plug-in connection can be coded to prevent incorrect polarity using CP-MSTB/CR-MSTB
- Efficient assembly, thanks to overlapping housing parts
- Can be snapped onto commercially available NS 35/7,5 and NS 35/15 DIN rails
- The MSTB-BL coding tab can be used to cover individual contact pins in order to form sections on the pin strip.

More housing dimensions, the layout of the PCBs, their dimensions and assembly areas can be found in the download center at:
www.phoenixcontact.net/products

Notes:
Tightening torque of terminal block screws refer to page 854.
Marking systems and mounting materials: see Catalog 5.
COMBICON plug-in connectors may only be activated under no load conditions. If for operating reasons small loads must be switched, empirical values are available upon request.
Voltage and current values are affected by the configuration of the printed circuit board.
¹⁾ For information on power dissipation, see page 770.
²⁾ Please observe the derating curves. Derating curves of further combination options on request.

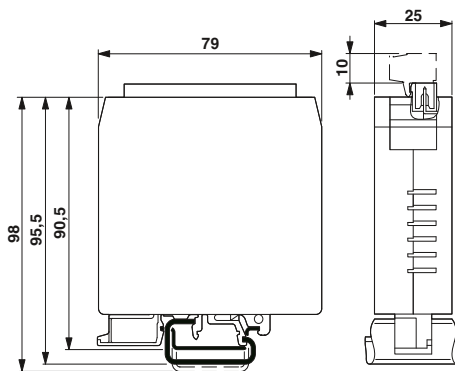

12-pos. with pluggable connection, width: 22.5 mm

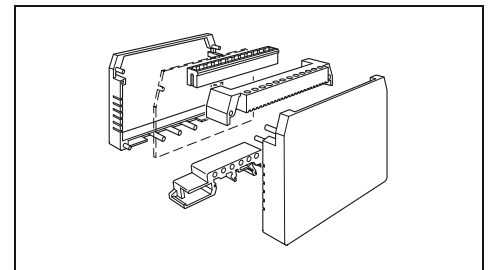

Power dissipation P_v at 20°C in horizontal mounting position ¹⁾
Mounted in rows without spacing
Mounted in rows with min. 20 mm spacing
Type of housing
Electronic housings
Connection data
MSTBT 2,5/...

Description	Grid [mm]	No. of pos.	Width [mm]
Electronic housings , with 12-position COMBICON pin strip, can be additionally equipped with 3 mm LED light indicator		12	25
COMBICON connector	5.08	12	

Coding tab , for MSTB headers, for dividing headers, plugged onto the header pin, made from green insulation material			
Cover cap , for closing LED cutouts which are not required			
Coding profile , for COMBICON headers, is inserted into the slot on the plug, red insulating material		1	
Coding section , for COMBICON headers, is inserted into the recess on the header		1	
Marker pen, not refillable , for manual marking, line thickness 0.5 mm			
Zack marker strip, 10-section, unprinted : pack contains enough to label 100 terminal blocks			

Technical data				
UEGM-MSTB				
4 W	-	-	-	
10 W	-	-	-	
Polyamide (PA 6.6) / V0				
solid	stranded	AWG	I [A]	U [V]
[mm ²]				
0.2 - 2.5	0.2 - 2.5	24 - 12	12 ²⁾	250

Ordering data		
Type	Order No.	Pcs. / Pkt.
UEGM-MSTB	2781453	10
MSTBT 2,5/12-ST-5,08	1781085	50

Accessories		
MSTB-BL	1755477	100
UEGM-MSTB-BS	2781466	60
CP-MSTB	1734634	100
CR-MSTB	1734401	100
B-STIFT	1051993	10
ZB 5 :UNBEDRUCKT	1050004	10

Multifunctional housings



With lots of installation space, a simple PCB contour, and robust design, these housing ranges provide ample space for large components and PCBs.



ME-PLC housing range

- Your advantages at a glance:
- Hard soldered or plug-in PCB connection technology
 - Removable tray for convenience when plugging in and removing connection technology
 - Optional with DIN rail connector
 - Hinged cover for uniform front panel
 - Robust DIN rail, 105 mm wide



CM housing range

- Your advantages at a glance:
- Robust housing type
 - Receptacle housing with vents
 - A variety of cover designs
 - Housing designs for wall mounting
 - Individual housing concepts for flexibility where PCB connection technology is concerned



UEG-EU housing

- Your advantages at a glance:
- For European-format cards (160 x 100 mm)
 - Direct fastening of PCB with secure screw connection
 - Frame design concept for convenient expansion of installation space
 - Individual housing concepts for flexibility where PCB connection technology is concerned



EFG housing

- Your advantages at a glance:
- Half-shell design with fitted cover in three parts
 - PCBs fitted with SMDs on both sides can be integrated
 - Secure screw connection between housing and PCB
 - Individual housing concepts for flexibility where PCB connection technology is concerned

ME PLC

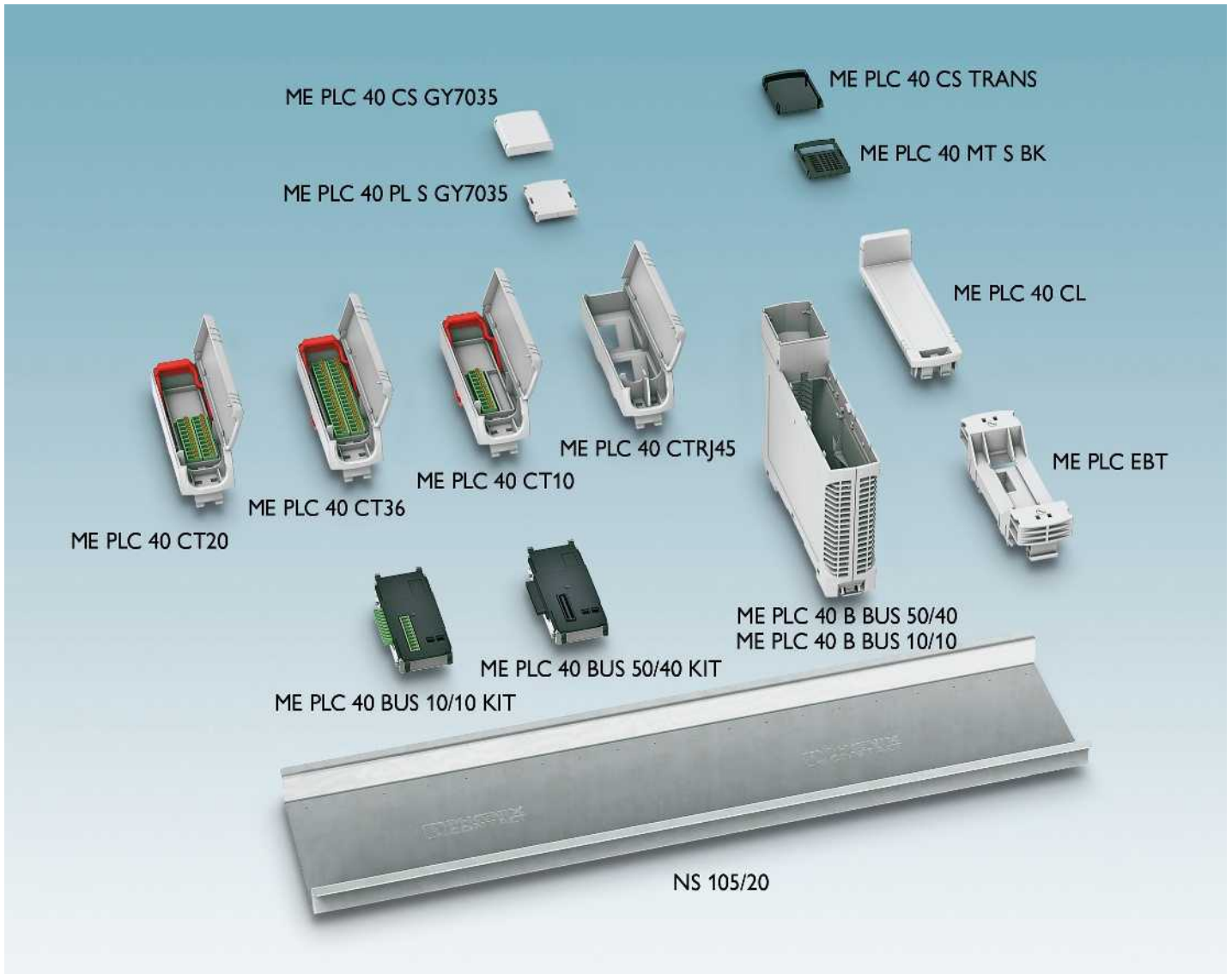

The ME PLC consists of a housing base with a design width of 40 mm that can be combined with various plug-in connection technology modules. The connection technology modules are supplied fully pre-assembled with FKCN 2,5... plug-in connectors. These plug-in connectors provide a quick push-in spring-cage connection for conductor cross sections of up to 2.5 mm².

A universal cover for fixed wiring or indicators and operating elements can also be snapped on with very little effort.

The ME-PLC housing can also be combined with DIN rail connectors. Two versions of the bus connector are available: 50-pos. in the DIN rail and 40-pos. in the device or 10-pos. in the DIN rail and 10-pos. in the device.

Both bus connector versions are supplied as a mounting kit, i.e., without PCB and unmounted. This means that individual and application-specific PCB designs can be integrated easily.

Together with a large PCB assembly area, this housing system offers a high level of functionality for a wide range of applications.

The wide DIN rail ensures a secure hold.

Order key for DIN rail NS 105/20:

Quantity	Order No.	Length [mm]
1	2201508	40
		Min. 40 mm
		Max. 2000 mm

ME-PLC

N

Notes:

1) Data sheets for the plug-in connectors are available from www.phoenixcontact.net/products

Description

Housing base, suitable for 50/40 bus connector, color: light gray

Housing base, suitable for 10/10 bus connector, color: light gray

Universal cover, long design, color: light gray

Connection technology carrier, fully assembled with FKCN 2 x 10-pos., cover and release lever, incl. fitted cover; corresponding header: 1 x CCDN 2,5/10-G1 P26 THR (173435)

Connection technology carrier, fully assembled with FKCN 2 x 18-pos., cover and release lever, incl. fitted cover; corresponding header: 1 x CCDN 2,5/18-G1 P26 THR (173436)

Connection technology carrier, fully assembled with FKCN 1 x 10-pos., cover and release lever, incl. fitted cover; corresponding header: MSTBA 2,5/10-G (1757543)

Connection technology carrier for RJ45 connection, pre-assembled with cover and release lever; incl. fitted cover and 2 x RJ45 connector plugs

Cover, short design, color: light gray

Cover, short design, color: transparent

Fitted plate, for assembly underneath the cover in short design, color: light gray

Matrix with defined engagement mechanism, for assembly underneath the cover in short design, color: black

Bus connector set consisting of 50-pos. and 40-pos. plug-in connectors, plastic upper part and base, plus metal clamp for mounting on DIN rail, without PCB¹⁾

Bus connector set consisting of 2 x 10-pos. plug-in connectors, plastic upper part and base, plus metal clamp for mounting on DIN rail, without PCB¹⁾

End brackets for DIN rail mounting, incl. mounting screws

DIN rail, unperforated, 105 x 20 mm, galvanized and thick layer passivated, cut to customer-specific length, specify length in [mm] as per order key

Ordering data

Type	Order No.	Pcs. / Pkt.
ME PLC 40 B BUS 50/40 GY7035	2201500	10
ME PLC 40 B BUS 10/10 GY7035	2201499	10
ME PLC 40 CL GY7035	2201505	10
ME PLC 40 CT20 GY7035	2201493	10
ME PLC 40 CT36 GY7035	2201494	10
ME PLC 40 CT10 GY7035	2201492	10
ME PLC 40 CTRJ45 GY7035	2201495	10

Accessories

ME PLC 40 CS GY7035	2201490	10
ME PLC 40 CS TRANS	2201491	10
ME PLC 40 PL S GY7035	2201497	10
ME PLC 40 MT S BK	2201496	10
ME PLC 40 BUS 50/40 KIT BK	2201502	10
ME PLC 40 BUS 10/10 KIT BK	2201503	10
ME PLC EBT GY7035	2201498	10
NS 105/20 UNPERF	2201508	1



CM compact component housing

CM component housing is a comprehensive housing range for designing industrial power electronics to suit control cabinet requirements. The different housing versions make it possible to integrate not only power electronics in the housing, but also standard transformer types with L-shaped cores.

Common features of all CM housing:

- Robust housing technology
- Individual accommodation of electronic components in various module versions with 50 to 200 mm pitch
- Flexible accommodation of different connection elements (from high-position plug-in connectors to electronic PCBs)
- Shock and contamination-proof accommodation of electronic components
- Easy snap-on mounting on symmetrical DIN rails according to EN 60715

Construction principle

The exploded view shows the construction principle of CM housing. The assembled PCB can be inserted in the different guide slots in the housing base. The covering hood is then simply snapped into the housing base.

It is also possible to screw the covering hood and the housing base together.



Accommodating electronic components

The various housing versions enable optimum adaptation to the required PCB area and the required connection technology.

For mounting transformers, spacing bolts are provided in the larger housing versions, onto which the transformers can be screwed.

The PCB is rectangular. **Details of PCB dimensions and assembly areas can be found in the Download Center at www.phoenixcontact.com.**

Housing technology

The covering hoods for CM 175 with a design height of 35 mm and CM 200 with a design height of 55 mm are always provided with vents. CM housing is designed to accommodate PCBs, which can be used as bus PCBs, for example, in the bottom of the housing.

Individual housing parts that differ from the standard range are available on request.

Mounting

All CM housing is aligned by simply snapping it onto symmetrical DIN rails according to EN 60715. It can be removed by drawing back the orange engagement latch.

There is also the option of using mounting feet instead of DIN rails. The corresponding spacer elements are included with CM 125 - 200 housing.

Conductor connections

CM electronics housing is supplied without recesses for connection elements.

It is therefore possible to make the appropriate recesses in the housing to suit the requirements of the relevant electronic component and connection element. These recesses can be produced in the factory on request.

- Standard (with vents)
- On request

Covering hoods

Types

Type Design width [mm]	Covering hoods				Types				
	12.5 mm	30 mm	35 mm	55 mm	With vents and spacing bolts	Without vents, with spacing bolts	With vents, without spacing bolts	Without vents, without spacing bolts	With vents, spacing bolts, and device holder
CM 50 50 mm	●	●					●	○	
CM 62 62 mm			●		○	○	●	○	
CM 75 75 mm	●		●		○		●		
CM 90 90 mm	●				○	○	●	○	
CM 125 125 mm	●		●		●	○	●	○	●
CM 175 175 mm			●		●	○			●
CM 200 200 mm				●	●	○			●

Multifunctional housings for complex electronics

CM compact component housing

More housing dimensions, the layout of the PCBs, their dimensions and assembly areas can be found in the download center at:
www.phoenixcontact.net/products

Notes:
 1) For information on power dissipation, see page 770.



Design widths: 50 and 75 mm



Design widths: 62 and 90 mm

	Technical data				Technical data			
	CM 50-LG/H 12,5/BO BK	CM 50-LG/H 30/BO BK	CM 75-LG/H 12,5/BO BK	CM 75-LG/H 35/BO BK	CM 90-LG/H 12,5/BO BK	CM 62-LG/H 35/BO BK		
Power dissipation P _v at 20°C in horizontal mounting position ¹⁾								
Mounted in rows without spacing	25 W	26.8 W	31.7 W	40.3 W	37 W	20.8 W	-	-
Mounted in rows with min. 20 mm spacing	38.3 W	39 W	41.2 W	52.5 W	48.1 W	24.4 W	-	-
Type of housing	Polycarbonate fiber reinforced / V0				Polycarbonate fiber reinforced / V0			
Electronic housings								
Description	Ordering data			Ordering data				
	Type	Order No.	Pcs. / Pkt.	Type	Order No.	Pcs. / Pkt.		
Electronic module , for PCB insertion with covering hood 12.5 mm high Vents Vents Plus spacer pins	CM 50-LG/H 12,5/BO BK CM 75-LG/H 12,5/BO BK	2943592 2943602	5 5	CM 90-LG/H 12,5/BO BK	2944876	4		
Electronic module , for PCB insertion, with covering hood 30 mm high Vents	CM 50-LG/H 30/BO BK	2942878	5					
Electronic module , for PCB insertion, with covering hood 35 mm high Vents Plus spacer pins Plus device holder	CM 75-LG/H 35/BO BK	2942881	5	CM 62-LG/H 35/BO BK	2944863	5		
Electronic module , for PCB insertion, with covering hood 55 mm high Plus device holder								



Design width: 125 mm



Design width: 175 mm



Design width: 200 mm

Technical data			
CM125-LG/H 12,5/BO BK	CM125-LG/H 35/BO/DB/GH BK	-	-
69 W	84,4 W	-	-
89.7 W	109.7 W	-	-
Polycarbonate fiber reinforced / V0			

Technical data			
CM175-LG/H 35/BO/DB/GH BK	-	-	-
120 W	-	-	-
160 W	-	-	-
Polycarbonate fiber reinforced / V0			

Technical data			
CM200-LG/H 55/BO/DB/GH BK	-	-	-
160 W	-	-	-
200 W	-	-	-
Polycarbonate fiber reinforced / V0			

Ordering data		
Type	Order No.	Pcs. / Pkt.
CM125-LG/H 12,5/BO BK	2942894	5
CM125-LG/H 12,5/BO/DB BK	2943055	5
CM125-LG/H 35/BO BK	2942904	5
CM125-LG/H 35/BO/DB BK	2941691	5
CM125-LG/H 35/BO/DB/GH BK	2941840	5

Ordering data		
Type	Order No.	Pcs. / Pkt.
CM175-LG/H 35/BO/DB/GH BK	2941507	5

Ordering data		
Type	Order No.	Pcs. / Pkt.
CM200-LG/H 55/BO/DB/GH BK	2941853	1

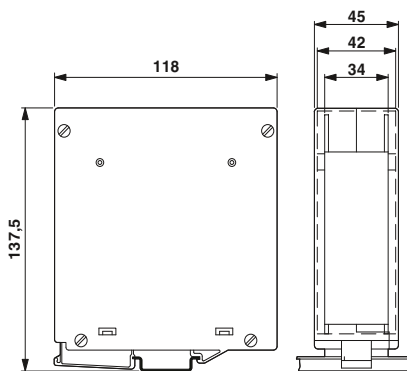

Any number of positions, width: 45 mm

The EFG 45 housing consists of two half shells and a set of three front plates. The front plate insert can be processed and printed cost-effectively.

Two PCBs with components on both sides can be integrated into the EFG 45 housing. A distance of 4.0 mm is available between the PCB and the inner side of the housing in order to be able to also use PCBs equipped with SMD on both sides. Complex functions can be implemented on a PCB surface of 112 x 115 mm.

The electronics assembly in the housing is significantly simplified by the half shell design and the front plate insert. The PCBs and the housing are screwed into place. This makes them highly stable.

The EFG 45 housing is snap-locked onto the symmetrical DIN rail in acc. with EN 60715.

Details of PCB layout, dimensions, and assembly areas can be found in the download center at

www.phoenixcontact.net/products.

Notes:
Tightening torque of terminal block screws refer to page 854.
¹⁾ 400 V is achieved when the pitch spacer RZ 2,5-FRONT 2,5-H(V) is inserted.
²⁾ For information on power dissipation, see page 770.
³⁾ Current carrying capacity curve upon request.

Power dissipation P_v at 20°C in horizontal mounting position²⁾

Mounted in rows without spacing
Mounted in rows with min. 20 mm spacing

Type of housing
Electronic housings

Connection data

FRONT 2,5-H/ ...

Description

Electronic housing, for insertion of two printed circuit boards

Without screw connection terminal blocks

PCB and COMBICON termination blocks, color: green



Technical data

EFG 45-LG/BS				
GY				
9.5 W	-	-	-	-
11.5 W	-	-	-	-
polycarbonate / V0				
solid	stranded		I	U
	[mm ²]	AWG	[A]	[V]
0.2 - 2.5	0.2 - 2.5	24 - 14	24 ³⁾	250 ¹⁾

Ordering data

Type	Order No.	Pcs. / Pkt.
EFG 45-LG/BS GY	2757474	5

Accessories

FRONT 2,5-H/SA 5	1700008	50
------------------	---------	----

**Universal component housing
UEG-EU**



The rail-mountable UEG-EU component housing accepts European-format cards (160 x 100 mm).

Main features:

- Direct mounting of the PCB on the UEG-EU BE base element with B 2.2 x 9.5 DIN ISO 1481 sheet-metal screws
 - Individual UEG-EU-BE base elements can be added in a row to extend the installation space
 - UEG-EU-VS connection pins ensure the necessary stability
 - Snap-in mounting on commercially available EN DIN rails
 - We will be happy to provide custom cut-outs in the base element for connection elements
- In order to install PCBs with tall components, it is possible to mount several individual base elements in rows. Engaging metal pins ensures the necessary stability.

More housing dimensions, the layout of the PCBs, their dimensions and assembly areas can be found in the download center at:
www.phoenixcontact.net/products

Notes:
1) For information on power dissipation, see page 770.

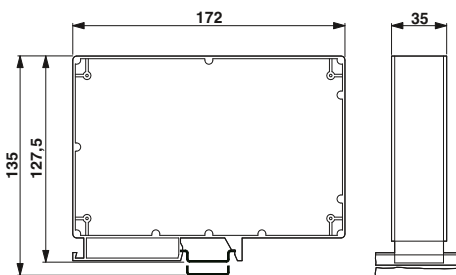

Any number of positions, for European-format cards, width: 35 mm

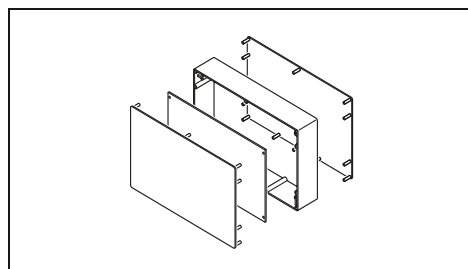

Power dissipation P _v at 20°C in horizontal mounting position ¹⁾	Mounted in rows without spacing
	Mounted in rows with min. 20 mm spacing
Type of housing	Electronic housings

Description

Electronic housing, comprising: base element with snap-on foot, for mounting on NS 35 DIN rails, 35 mm wide

Side element, two pieces required, for closing the base element on both sides, 1.5 mm thick

Connection pin, for engaging several base elements to form one unit; 12 necessary per element, brass

Technical data			
UEG-EU-BE			
8.9 W	-	-	-
18.3 W	-	-	-
Polyamide fiber reinforced / HB			

Ordering data		
Type	Order No.	Pcs. / Pkt.
UEG-EU-BE	2956819	5
UEG-EU-SE	2956822	5

Accessories		
Type	Order No.	Pcs. / Pkt.
UEG-EU-VS	5028883	100

Housing profile

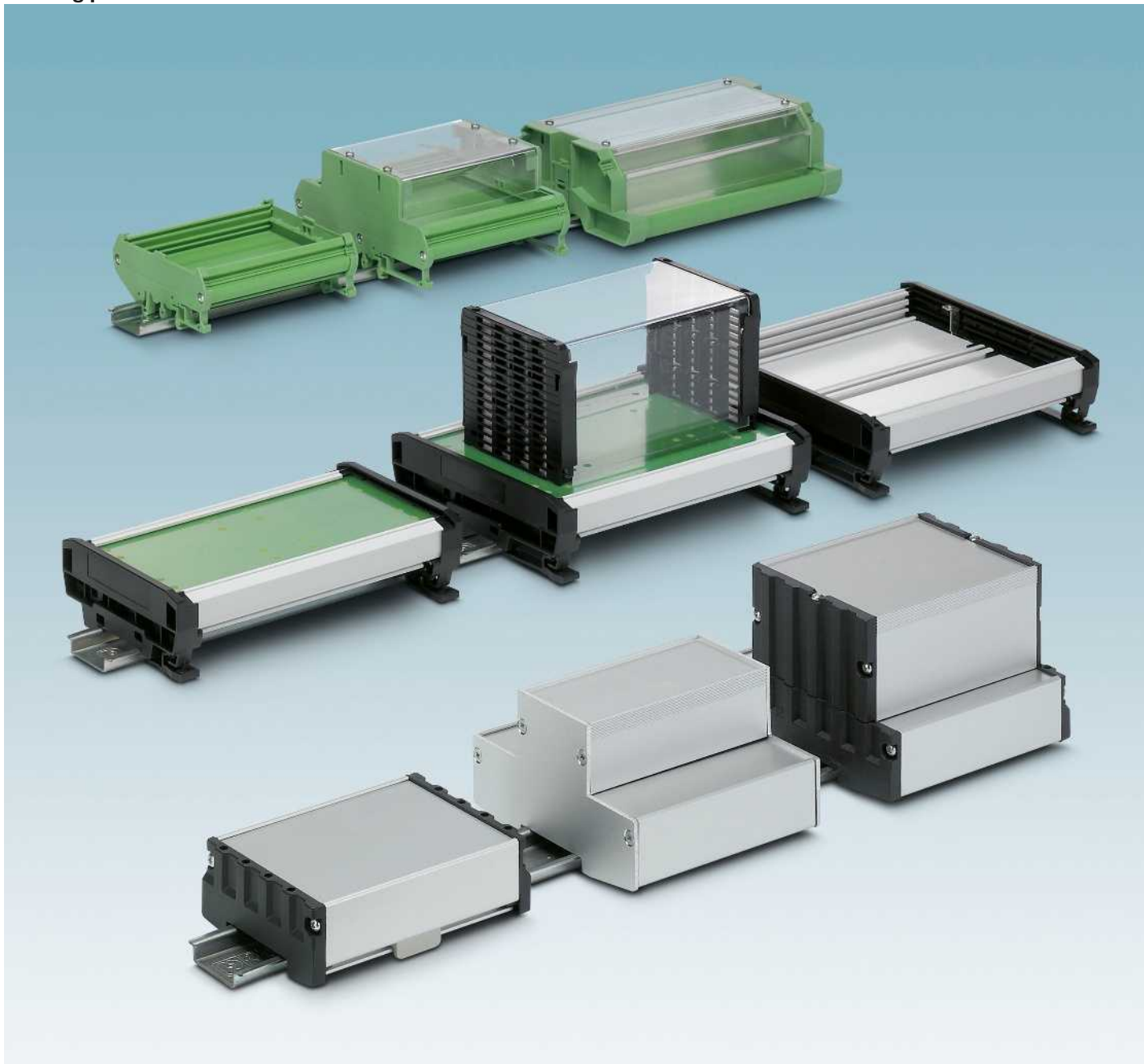

The profile housings offer maximum flexibility. Cut to length to the centimeter, made from plastic and metal, and featuring covering hoods, these housing ranges can be customized for individual device concepts.



UM-ALU housing range

- Your advantages at a glance:
- Material: aluminum
 - Profile housing can be screwed together with side sections
 - Basic profile width 72 mm or 100.5 mm
 - Individual profile length
 - Selection of cover profiles
 - Optional PE contacting
 - Freely selectable connection technology



UM-PRO and UM-Basic housing range

- Your advantages at a glance:
- Material: plastic polyamide (UM-PRO) and PVC (UM-Basic)
 - Profile housing can be snapped together with side sections
 - Basic profile width: 72, 108, and 122 mm
 - Individual profile length



UM profiles housing range

- Your advantages at a glance:
- Material: plastic PVC
 - Profile housing can be screwed together with side sections
 - Basic profile width: 25, 45, 72, 100, 108, and 122 mm
 - Individual profile length



UMK housing range

- Your advantages at a glance:
- Material: plastic polyamide
 - Plug-in elements snap together with no need for tools
 - Individual elements 11.25, 22.5, and 45 mm wide



UM plug-in modules housing range

- Your advantages at a glance:
- Material: plastic polyamide
 - Plug-in elements snap together with no need for tools
 - Secure pin connection with metal pins
 - Individual elements 16.5 and 35 mm wide



DIN rails – UTA and EM adapters

- Your advantages at a glance:
- Material: zinc die-cast and plastic polyamide
 - Secure DIN rail mounting for devices without mounting foot

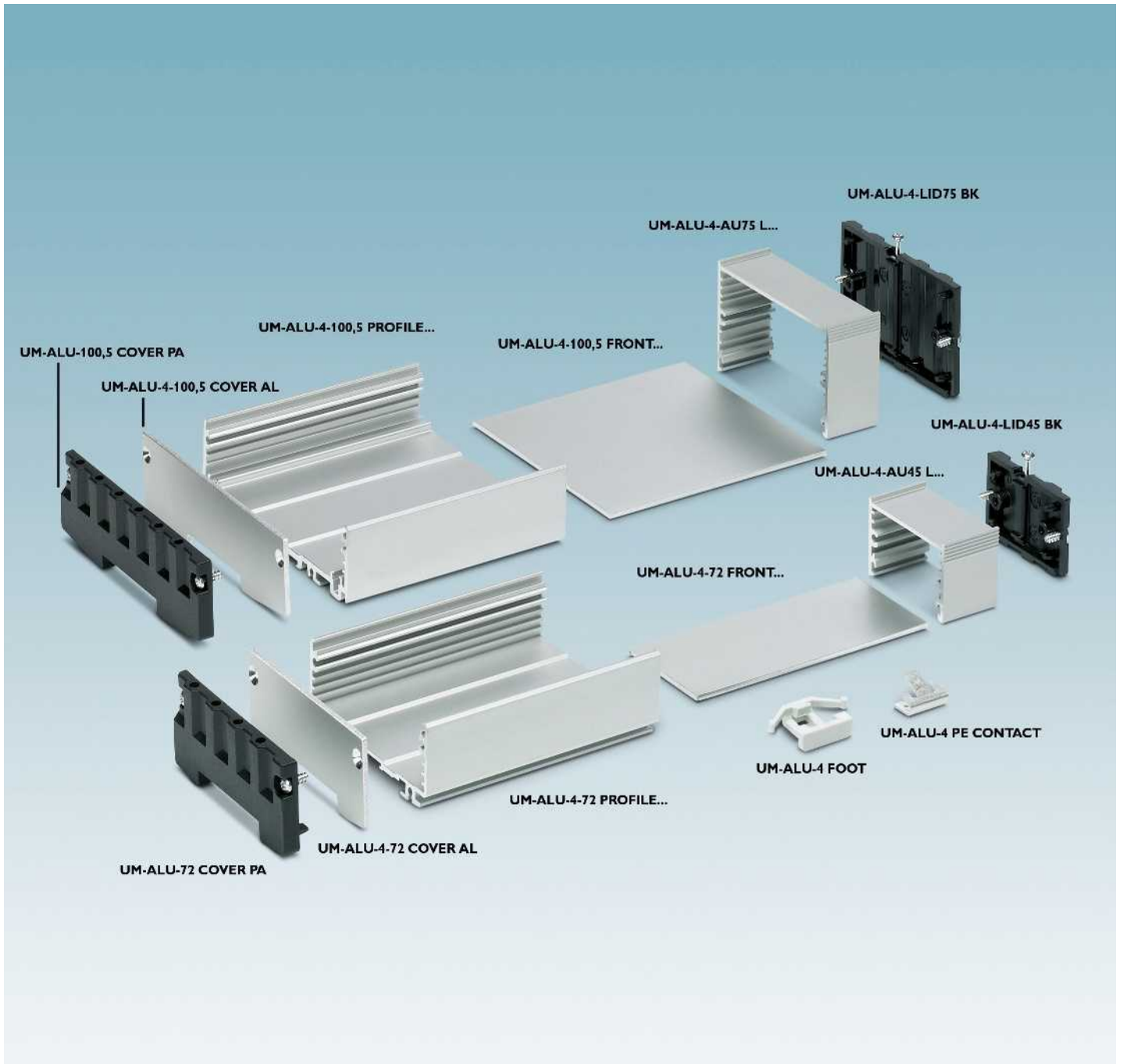

The rugged UM-ALU housing series, which is made from anodized aluminum, provides protection for your electronics against mechanical stress, electromagnetic interference, and thermal influences.

The housings are particularly well-suited for use in temperature ranges from minus 40°C up to 100°C and offer maximum shock protection of IP40 according to DIN EN 60529.



Rugged press-drawn section

Both the basic profiles and the hood profiles are made of an anodized aluminum press-drawn section. In addition to mechanical strength, the material's outstanding properties also include an extremely high level of heat resistance and shielding against disruptive radiation and noise emission.

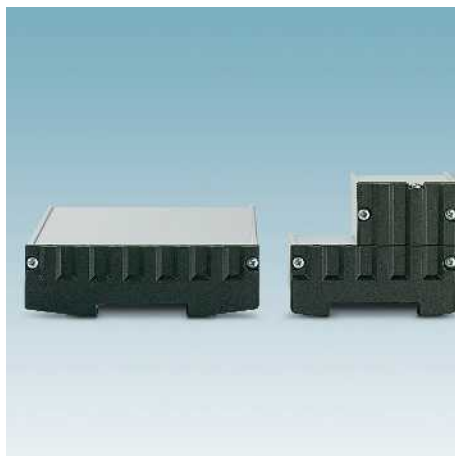

Variability in shape

A myriad of housing combinations can be formed by combining a basic profile with one of the two hood profiles, which can be flexibly positioned. The available or custom-specific lengths ensure professional and tailor-made electronic housing.

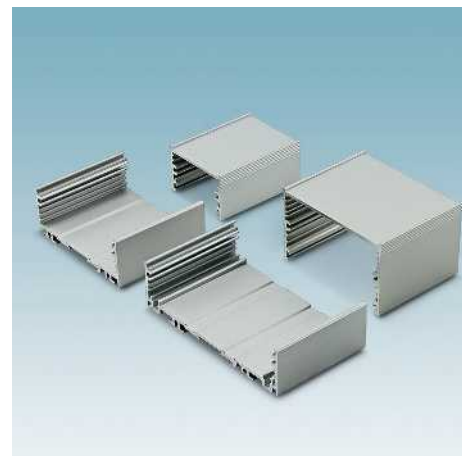

Unrestricted assembly

Multiple PCB levels in the basic and hood profiles provide electronics engineers with the required flexibility for positioning various components or modules.



PE contacting

An optional PE contact can also be provided on the basic profile. The press-in method penetrates the anodized layer and provides a conductive connection between the housing and the DIN rail. Contacting is carried out via standard cable lugs for flat plugs according to DIN 46244-A6.3



DIN rail mounting

The freely-positionable foot element is used for fixing to the DIN rail. The housing is reliably secured, as usual, by swinging it into place and latching. Best of all - no tools are needed for removal and it can be carried out effectively "blind" - simply gently push the housing vertically in respect to the DIN rail and tilt it out. Depending on the application, several foot elements can be mounted and used per housing.



Individuality from the works

In addition to the products which can be ordered from the catalog, we offer an extensive range of additional services from special profile lengths through additional mechanical processing and printing, and even membrane keypads.

Profile racks and adapters

UM-ALU 4 aluminum profile housing

Notes:

For **SF-TX-SET** (Order No. 1212539) and **SF-M-Set** (Order No. 1212543) screwdriver set, see www.phoenixcontact.net/products



Aluminum basic profile
Width: 72 mm



Aluminum basic profile
Width: 100.5 mm

Description	Ordering data			Ordering data		
	Type	Order No.	Pcs. / Pkt.	Type	Order No.	Pcs. / Pkt.
Basic profile, one-piece						
Length 42.5 mm	UM-ALU 4-72 PROFILE 42,5	2200917	1	UM-ALU 4-100,5 PROFILE 42,5	2200935	1
Length 60 mm	UM-ALU 4-72 PROFILE 60	2200918	1	UM-ALU 4-100,5 PROFILE 60	2200936	1
Length 95 mm	UM-ALU 4-72 PROFILE 95	2200919	1	UM-ALU 4-100,5 PROFILE 95	2200937	1
Length 130 mm	UM-ALU 4-72 PROFILE 130	2200920	1	UM-ALU 4-100,5 PROFILE 130	2200938	1
Length 165 mm	UM-ALU 4-72 PROFILE 165	2200921	1	UM-ALU 4-100,5 PROFILE 165	2200939	1
Length 200 mm	UM-ALU 4-72 PROFILE 200	2200922	1	UM-ALU 4-100,5 PROFILE 200	2200940	1
Length 235 mm	UM-ALU 4-72 PROFILE 235	2200923	1	UM-ALU 4-100,5 PROFILE 235	2200941	1
Length 990 mm	UM-ALU 4-72 PROFILE 990	2200924	1	UM-ALU 4-100,5 PROFILE 990	2200942	1
Basic profile front plate						
Length 42.5 mm	UM-ALU 4-72 FRONT 42,5	2200925	1	UM-ALU 4-100,5 FRONT 42,5	2200943	1
Length 60 mm	UM-ALU 4-72 FRONT 60	2200926	1	UM-ALU 4-100,5 FRONT 60	2200944	1
Length 95 mm	UM-ALU 4-72 FRONT 95	2200927	1	UM-ALU 4-100,5 FRONT 95	2200945	1
Length 130 mm	UM-ALU 4-72 FRONT 130	2200928	1	UM-ALU 4-100,5 FRONT 130	2200946	1
Length 165 mm	UM-ALU 4-72 FRONT 165	2200929	1	UM-ALU 4-100,5 FRONT 165	2200947	1
Length 200 mm	UM-ALU 4-72 FRONT 200	2200930	1	UM-ALU 4-100,5 FRONT 200	2200948	1
Length 235 mm	UM-ALU 4-72 FRONT 235	2200931	1	UM-ALU 4-100,5 FRONT 235	2200949	1
Length 990 mm	UM-ALU 4-72 FRONT 990	2200932	1	UM-ALU 4-100,5 FRONT 990	2200950	1
Side plate set , including snap-on foot with screws for basic profile, anodized aluminum	UM-ALU 4-72 COVER AL	2200933	1	UM-ALU 4-100,5 COVER AL	2200951	1
Profile cap set , including snap-on foot with screws for polyamide basic profile, black	UM-ALU 4-72 COVER PA BK	2200934	1	UM-ALU 4-100,5 COVER PA BK	2200952	1
Module cap set , including mounting screws, polyamide, black, 75 mm	UM-ALU 4 LID75 PA BK	2200972	1	UM-ALU 4 LID75 PA BK	2200972	1
	Accessories			Accessories		
Grounding clamp for making contact with DIN rail	UM-ALU 4 PE CONTACT	2200973	5	UM-ALU 4 PE CONTACT	2200973	5
Snap-in element for DIN rail including screw	UM-ALU 4 FOOT	2200974	5	UM-ALU 4 FOOT	2200974	5

UM-ALU 4 aluminum profile housing



Aluminum hood profile, width: 45 mm

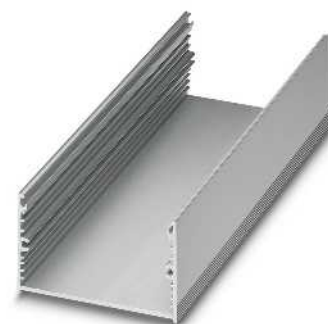

Aluminum hood profile, width: 75 mm

Description	Ordering data			Ordering data		
	Type	Order No.	Pcs. / Pkt.	Type	Order No.	Pcs. / Pkt.
Module profile one-piece (U-shape), anodized aluminum, width 45 mm, for mounting on black profile cap set (COVER PA) Length 25 mm Length 42.5 mm Length 60 mm Length 95 mm Length 130 mm Length 165 mm Length 200 mm Length 235 mm Module profile , one-piece (U-shape), anodized aluminum, width 75 mm Length 25 mm Length 42.5 mm Length 60 mm Length 95 mm Length 130 mm Length 165 mm Length 200 mm Length 235 mm Length 990 mm Module cap set , including mounting screws, polyamide, black, 45 mm Module cap set , including mounting screws, polyamide, black, 75 mm	UM-ALU 4 AU45 L25 UM-ALU 4 AU45 L42,5 UM-ALU 4 AU45 L60 UM-ALU 4 AU45 L95 UM-ALU 4 AU45 L130 UM-ALU 4 AU45 L165 UM-ALU 4 AU45 L200 UM-ALU 4 AU45 L235	2200953 2200954 2200955 2200956 2200957 2200958 2200959 2200960	1 1 1 1 1 1 1 1	UM-ALU 4 AU75 L25 UM-ALU 4 AU75 L42,5 UM-ALU 4 AU75 L60 UM-ALU 4 AU75 L95 UM-ALU 4 AU75 L130 UM-ALU 4 AU75 L165 UM-ALU 4 AU75 L200 UM-ALU 4 AU75 L235 UM-ALU 4 AU75 L990	2200962 2200963 2200964 2200965 2200966 2200967 2200968 2200969 2200970	1 1 1 1 1 1 1 1 1
	UM-ALU 4 LID45 PA BK	2200971	1			
	UM-ALU 4 LID75 PA BK	2200972	1	UM-ALU 4 LID75 PA BK	2200972	1
	Accessories			Accessories		
Grounding clamp for making contact with DIN rail	UM-ALU 4 PE CONTACT	2200973	5	UM-ALU 4 PE CONTACT	2200973	5
Snap-in element for DIN rail including screw	UM-ALU 4 FOOT	2200974	5	UM-ALU 4 FOOT	2200974	5

UM-PRO and UM-BASIC press-drawn section panel mounting bases



UM-PRO and UM-BASIC press-drawn section housing, available in three versions (72/108/122), combines short assembly times and maximum flexibility when choosing the connection technology. Thanks to the plastic polyamide and special profile geometry, UM-PRO is suitable for operating temperatures of up to 100°C and higher mechanical loads.

Made from halogen-free high-temperature plastic, UM-PRO profile housing meets the requirements for UL device approval and marketing on the US market.

The low-profile design supports the assembly of flat electronic modules and their mounting on standard DIN rails or directly on the panel. The top PCB can have components assembled up to the edge and fixed by means of a quick-action mechanism. Other customer benefits include further options, such as the free positioning of covering hoods or the selectable BUS option for connecting modules.

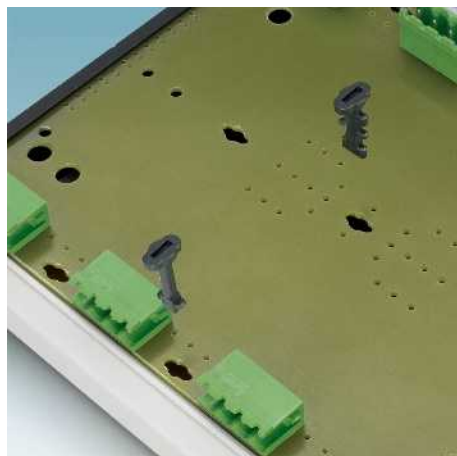

Fast housing assembly: plugging instead of screwing

The fact that profile pieces can be snapped quickly and securely in place using UM-PRO...COVER side parts helps mitigate increasing cost pressures during the final device assembly stages.

Integration of various connection technologies

Since the top PCB fits flush against the side of the profile, it can have components assembled up to the edge. This PCB can also be secured with the UM-PRO PCB S(C)-LOCK locking element. The connectors remain freely accessible for wiring by the end customer.

Integrated PE contact

The UM-PRO PE CONTACT potential ground contact, which can be integrated on either side, establishes an electrical connection between the inserted PCB and the DIN rail. This eliminates the need for additional PE terminal blocks and extensive cabling work.

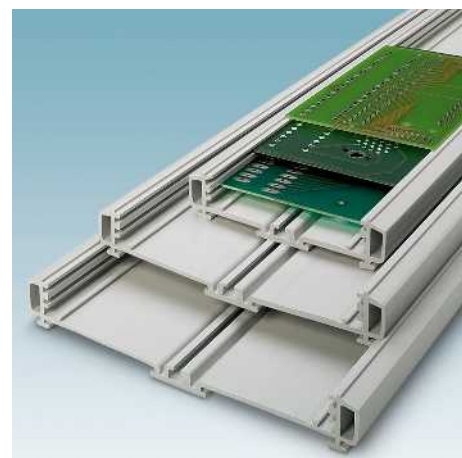

Flexible positioning of covering hoods

The ability to position the covering hoods as required means that sensitive areas on the board can be protected independently. The UM-PRO LID... snap-in lids are easy to mount and remove using just a screwdriver. It is easy to combine connection technologies with a variety of space requirements.

BUS cross contacting of housing

The integrated design of the standard MINI COMBICON connector plugs at the lowest PCB level supports cost-effective device networking.

Variability in assembly

Three guides in the profile enable PCB arrangements on different levels and combinations with a front cover, for example.

Profile racks and adapters

UM-PRO and UM-BASIC press-drawn section panel mounting base



Main properties and benefits

- Plug-in assembly reduces assembly time and thereby saves costs
- The 72/108 and 122 mm widths provide compatible high-end alternatives to popular UM profiles
- Temperature range up to 100°C extends the possible fields of application (UM-PRO)
- Well-designed profile geometry increases the form stability
- 3 profile guideways support various PCB configurations
- Mounting close to the edge provides wiring advantages
- Freely positionable rear covering hoods offer flexibility
- PE contacts that can be fitted on both sides ensure safety
- Device communication can be extended by BUS cross contacting
- Marking area for standard SK strips or marking foil TML (max. height 6 mm)
- Additional marking of PCB with Phoenix module marker carrier PMB (bore hole diameter 4 mm)
- Additional foot elements increase mechanical stability

Housing dimensions can be found in the Download Center at:
www.phoenixcontact.net/products.

Notes:

More information on the housing:

UM-PRO profile made from PA-GF HT, inflammability class V0 (UL 94)
 UM-BASIC profile made from PVC, inflammability class V0 (UL 94)
 UM-PRO COVER and UM-PRO LID lateral elements made from polyamide PA, inflammability class V0 (UL 94) U-shaped profile covers made from PC, inflammability class V0 (UL 94).

¹⁾ Please indicate the desired length in [cm].



Press-drawn section, 72 mm wide



Ordering data

Type	Order No.	Pcs. / Pkt.
UM-PRO PROFILE	2200148	1
UM-BASIC PROFILE	2200149	1
UM-PRO 72 COVER-L BK	2200151	10
UM-PRO 72 COVER-R BK	2200152	10
UM-PRO A/U N 73 CM	2200310	1
UM-PRO A/U 73 CM	2200311	1
UM-PRO A/U 92 CM	2200312	1
UM-PRO LID-73N BK	2200174	10
UM-PRO LID-73 BK	2200173	10
UM-PRO LID-92 BK	2200172	10

Accessories

UM-PRO 72 FOOT BK	2200153	10
UM-PRO PE CONTACT L1	2200161	20
UM-PRO PE CONTACT L2	2200162	20
UM-PRO PE CONTACT L3	2200163	20
UM-PRO PCB S-LOCK BK	2200168	100
UM-PRO PCB C-LOCK L1 BK	2200164	50
UM-PRO PCB C-LOCK L2 BK	2200165	50
UM-PRO PCB C-LOCK L3 BK	2200166	50
UM-PRO MOUNT BK	2200171	10
SZF 0-0,4X2,5	1204504	10

Description

Press-drawn section cut to customer-specific length.
 color: light gray (similar to RAL 7035)
 Specify length in [cm] according to order key

Lateral elements with mounting foot for NS35 DIN rails, with groove for accommodating PE contact metal, can be inserted in UM-PRO/UM-BASIC profiles, color: black (similar to RAL 9005)

Version: left, width: 72 mm
 Version: left, width: 108 mm
 Version: left, width: 122 mm
 Version: right, width: 72 mm
 Version: right, width: 108 mm
 Version: right, width: 122 mm

U-shaped profile cover, low version, high-temperature-resistant PC material, 73 mm wide (internal dimensions: 69 mm)¹⁾

U-shaped profile cover, high version, high-temperature-resistant PC material, 73 mm wide (internal dimensions: 69 mm). Please observe the order key

U-shaped profile cover, high-temperature-resistant PC material, 92 mm wide (internal dimensions: 88 mm)

Latching cover black, for lateral sealing of profile covers (2 units are required for each hood) for:

UM-PRO A/U N 73 CM
 UM-PRO A/U 73 CM
 UM-PRO A/U 92 CM

Foot element for DIN rails, for mounting under press-drawn section

Width: 72 mm
 Width: 108 mm
 Width: 122 mm

PE contact metal for snapping into lateral elements, includes mounting screw (head diameter 6 mm)

Version for top PCB level

Version for middle PCB level

Version for bottom PCB level

Add-on element for fixing PCBs

Version for top PCB, lateral, black

Version for top PCB, central, black

Version for middle PCB, central, black

Version for bottom PCB, central, black

Mounting flange, for direct wall mounting. Color: black

Screwdriver



Press-drawn section, 108 mm wide



Press-drawn section, 122 mm wide



Ordering data

Type	Order No.	Pcs. / Pkt.
UM-PRO PROFILE	2200148	1
UM-BASIC PROFILE	2200149	1
UM-PRO 108 COVER-L BK	2200155	10
UM-PRO 108 COVER-R BK	2200156	10
UM-PRO A/U N 73 CM	2200310	1
UM-PRO A/U 73 CM	2200311	1
UM-PRO A/U 92 CM	2200312	1
UM-PRO LID-73N BK	2200174	10
UM-PRO LID-73 BK	2200173	10
UM-PRO LID-92 BK	2200172	10

Ordering data

Type	Order No.	Pcs. / Pkt.
UM-PRO PROFILE	2200148	1
UM-BASIC PROFILE	2200149	1
UM-PRO 122 COVER-L BK	2200158	10
UM-PRO 122 COVER-R BK	2200159	10
UM-PRO A/U N 73 CM	2200310	1
UM-PRO A/U 73 CM	2200311	1
UM-PRO A/U 92 CM	2200312	1
UM-PRO LID-73N BK	2200174	10
UM-PRO LID-73 BK	2200173	10
UM-PRO LID-92 BK	2200172	10

Accessories

UM-PRO 108 FOOT BK	2200157	10
UM-PRO PE CONTACT L1	2200161	20
UM-PRO PE CONTACT L2	2200162	20
UM-PRO PE CONTACT L3	2200163	20
UM-PRO PCB S-LOCK BK	2200168	100
UM-PRO PCB C-LOCK L1 BK	2200164	50
UM-PRO PCB C-LOCK L2 BK	2200165	50
UM-PRO PCB C-LOCK L3 BK	2200166	50
UM-PRO MOUNT BK	2200171	10
SZF 0-0,4X2,5	1204504	10

Accessories

UM-PRO 122 FOOT BK	2200160	10
UM-PRO PE CONTACT L1	2200161	20
UM-PRO PE CONTACT L2	2200162	20
UM-PRO PE CONTACT L3	2200163	20
UM-PRO PCB S-LOCK BK	2200168	100
UM-PRO PCB C-LOCK L1 BK	2200164	50
UM-PRO PCB C-LOCK L2 BK	2200165	50
UM-PRO PCB C-LOCK L3 BK	2200166	50
UM-PRO MOUNT BK	2200171	10
SZF 0-0,4X2,5	1204504	10

Profile racks and adapters

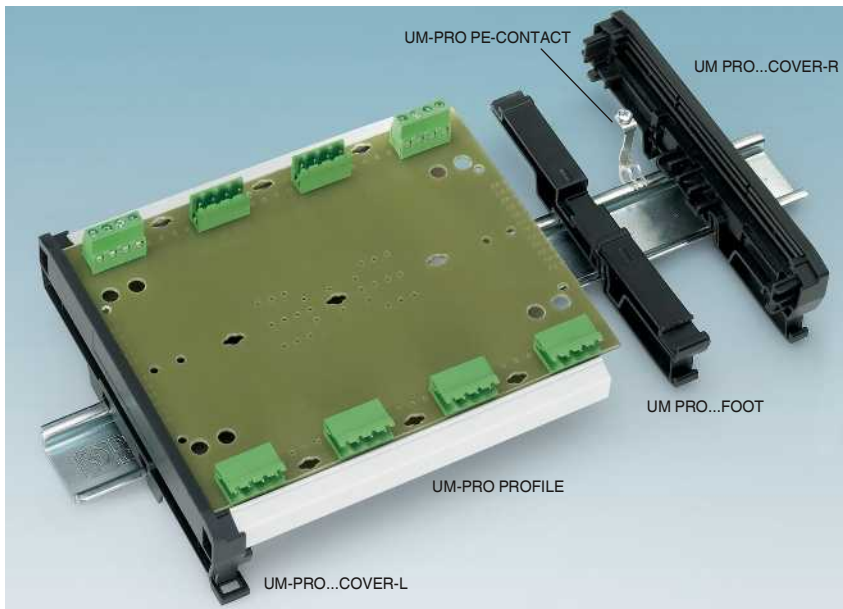

Order key for UM-PRO and UM-BASIC

Pcs.	Order No.	Profile width	Length [cm]	Color
1	22 00 14 8	UM-PRO UM-PRO 72 ≅ 72 mm UM-PRO 108 ≅ 108 mm UM-PRO 122 ≅ 122 mm	22,5 3.0 cm, minimum 100.0 cm, maximum	GY7035 GY7035 ≅ Light gray

General note:

The area available for assembly is reduced by 3.1 mm at both edges of the press-drawn sections.

Ordering information:

In order to determine the profile length, 1.6 cm must be subtracted from the PCB length.
 The overall length of the module, i.e., including the lateral elements, is equal to the PCB length plus 0.4 cm.
 The maximum length of a profile cover is the PCB length minus 1.9 cm.
 When using the UM-PRO PE-CONTACT, the maximum length is reduced by a further 0.91 cm per contact.

Ordering example:

For a PCB of 160 x 107.5 x 1.5 mm, the profile length is:
 2200148/UM-PRO 108/14,4/GY7035

Order key for profile covers

Pcs.	Order No.	Width of cover [mm]	Length [cm]
1	22 00 31 1	AU 73 AU 73 ≅ 73 mm	8,4 3.0 cm, minimum 100.0 cm, maximum

UM-PRO and UM-BASIC PCBs

A = Drill hole for optional PE contact; B = For optional S-LOCK PCB lock in top level;
 C = For optional C-LOCK PCB lock (all levels)

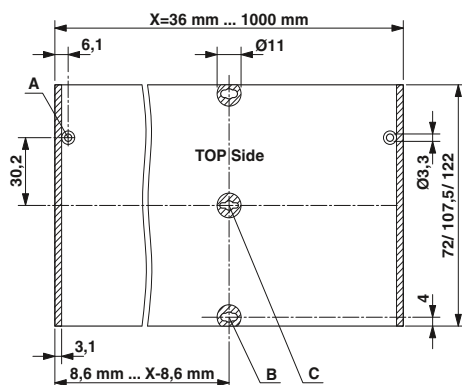

Profile racks and adapters



UM press-drawn section panel mounting bases

Individual adaptation of UM press-drawn sections to the dimensions of PCBs means that a host of electronic circuits can be made DIN-rail mountable.

UM profile housing consists of the following components: UM... press-drawn section, UM...SE lateral elements in various widths and heights, UM...FE foot elements, and UM profile covers for UM 100, UM 108, and UM 122.

Depending on the desired module length and the space required, the press-drawn section can be cut to size individually and combined with lateral and foot elements to form a module.

Six graded profile versions are available for PCB widths of 22 mm, 42 mm, 72 mm, 100 mm, 107.5 mm, and 122 mm.

The modules are mounted on commercially available  or  DIN rails (UM 25 and UM 45 only on  DIN rails) or directly on the mounting plate with the UMK-BF mounting flange.

Marking grooves ensure clear identification of the module with standard marking materials (ZB 5).

The standard color of press-drawn sections is green.

Additional advantages of UM press-drawn sections:

- Inexpensive as a result of reducing the number of separate housing parts
- Flexible size and shape
- High degree of mechanical stability by screwing the lateral elements to the profile
- Profile cover can provide protection for the electronics in UM 100, UM 108, and UM 122 versions

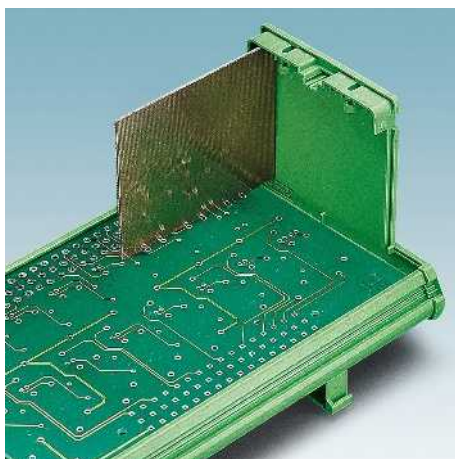
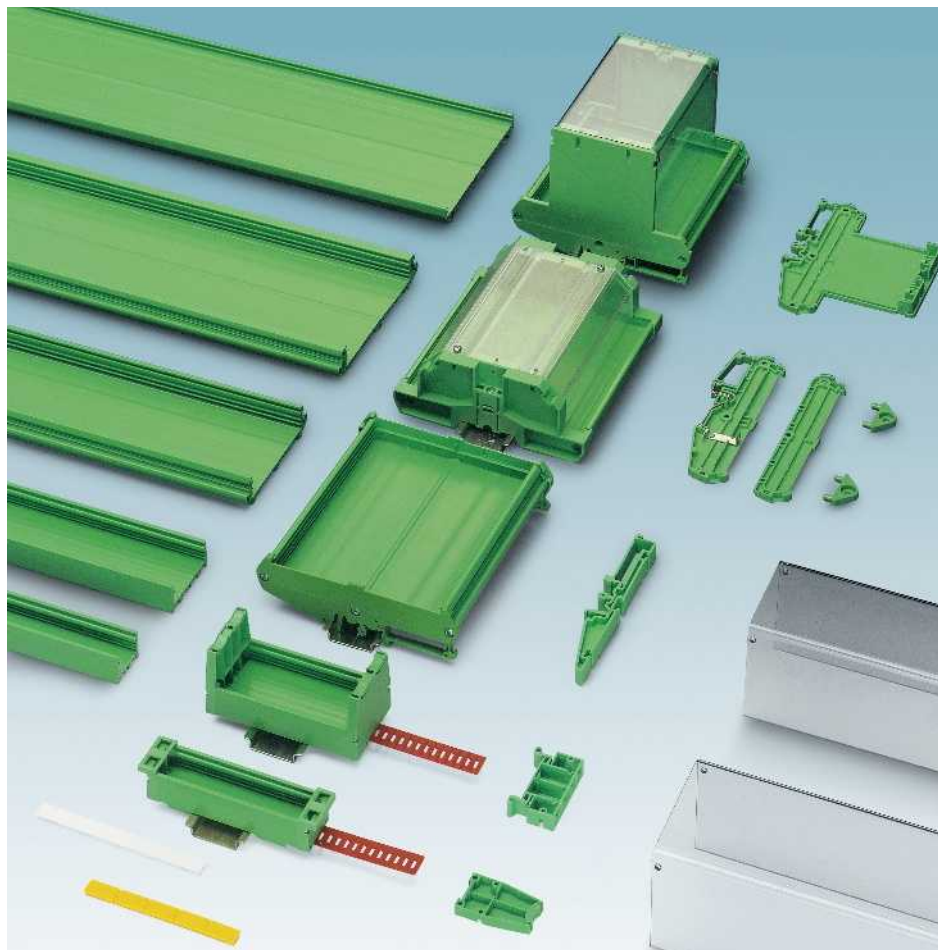

More capacity

UM 100 and 108 press-drawn sections with cover for optional extension of vertically-mounted PCBs.

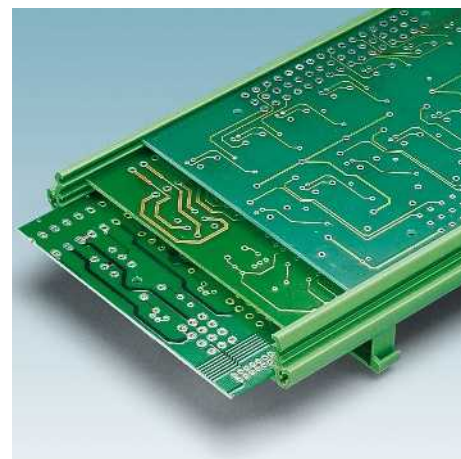

Free positioning of PCBs

PCB guides on up to three levels support compact electronic circuits, e.g., using SMD technology.



Custom length

The profiles can be cut without rigid pitch divisions to within a millimeter, so that the housing profile can be tailored to fit the electronics.



Potential earth contact

The PE contact integrated into the lateral element connects the inserted PCB to the DIN rail. What this means for you:

- Excellent EMC properties
- No need for an additional PE terminal block when shielded sensor cables are used

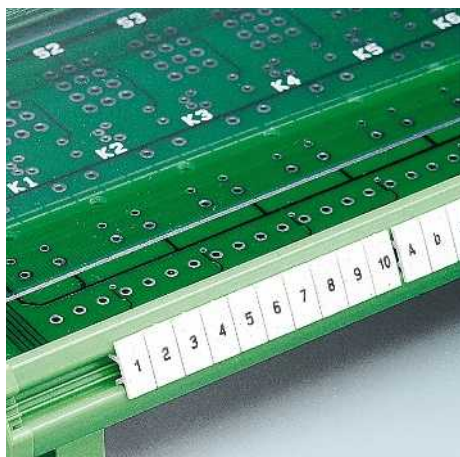

Clear marking

The marker groove provided on both sides means that the profile can be marked flexibly and individually with ZB 5 marking material.

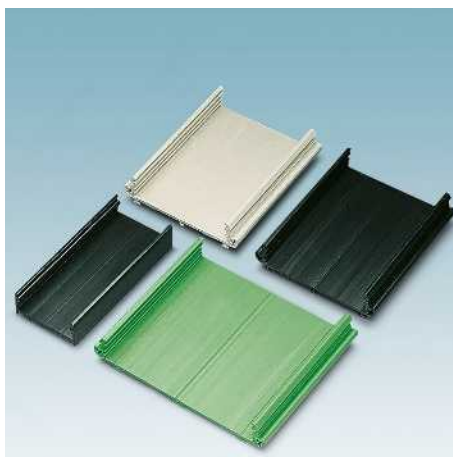

Choice of shape and color

In addition to the standard green color, UM 45 and UM 108 press-drawn sections are available in black, UM 72 in black, light gray, and beige, and UM 122 in light gray and black.

Accessories

Optional transparent UM...A/U profile covers are available for press-drawn section panel mounting bases in design widths UM 100, UM 108, and UM 122.

Different UM...SE... lateral elements are used, depending on the cover selected. These elements can be supplied with or without a foot and with optional integrated potential earth contact. Guide slots are integrated in the tall lateral elements. This means that additional PCBs can be arranged vertically on the base PCB.

Transparent UM...A/U U-profile covers come in various lengths, depending on the length of the profile.

Using the UMK-BF mounting flange, modules can be mounted directly on the wall. Extra UM...-FE foot elements increase the overall stability of longer modules.

Degree of protection

By using optional UM...-A/U covers, shock and contamination-proof electronic modules can be created. The degree of protection of housing and terminal blocks protected in this way corresponds to IP20 (according to IEC 60529/EN 60529).

Materials

Housing and transparent covers are made from extruded PVC (UL 94 - V0). This material has an excellent price/performance ratio. The maximum permissible operating temperature is 50°C. Covers ending in HT are made from high-temperature-resistant thermoplastic PC (UL 94-V0).

Conductor connections

A host of possibilities for external conductor connection are available, thanks to the wide range of electronic PCB terminal blocks, screw, COMBICON, spade, and spring-cage connections.

Profile racks and adapters

UM profile panel mounting base

The UM 25 and UM 45 compact press-drawn sections offer a variety of options for installing electronic modules in situations where there is not much installation space available.

The slim UM 25 and UM 45 modules are mounted transversely in relation to the DIN rail.

A special UM 25/45-FEO 200 foot element is used for this purpose. This arrangement is suitable for module lengths of 8 - 20 cm. The positive latch in the foot element can be prepared for the required module length.

An additional side element is available for the UM 45 module. This enables the module to be mounted longitudinally on the NS 35 DIN rail in any length.

The press-drawn sections are manufactured to the required length and are available in lengths up to 100 cm.

Further advantages:

- Quick assembly
- The UMK-BF mounting flange enables the modules to be mounted directly on the wall
- UM ...-SES side element offers options for marking with Phoenix Contact SS-ZB marking material (see also catalog 5)
- Cable fixing through the UM ...-SEK side element (fixed with cable ties, not supplied as standard)

Housing dimensions can be found in the Download Center at:
www.phoenixcontact.net/products.

Notes:
Information concerning the housing:
PVC profile, inflammability class V0 (UL 94)
Polyamide PA side elements, inflammability class V0 (UL 94)
1) To define the profile length and width, please observe the order key.



For 25 mm wide PCBs

Type of housing	Electronic housings
-----------------	---------------------

Description
Drawn section Fixed length 100 cm Cut to length according to customer specifications ¹⁾
Side supporting element , must be mounted at right angles to the NS 35 to support the housing
Side element With marker groove, 11 mm wide, marking with SS-ZB. Without marker groove, 6 mm wide
Side element , with cable tie, 6 mm wide, fixed using cable ties, not included in the delivery
Side element , with foot, 10 mm wide, mounted longitudinally to the NS 35, marking with SS-ZB
Without PCB guide in side element
Foot element , is inserted in the profile, limit stop with screw, mounted at right angles to the NS 35

Marker tags , 5-section, unprinted, marking with X-PEN, M-PEN, plotter or BKMT 20 x 8 label	white
	yellow
Mounting flange , for mounting directly on the wall	

Technical data		
PVC / V0		

Ordering data		
Type	Order No.	Pcs. / Pkt.
UM 25-PROFIL 100CM	2915795	1
UM -PROFIL	2952020	1
UM 25-SES	2959285	10
UM 25-SEK	2959298	10
UM 25/45-FEO 200	2959434	10

Accessories		
SS-ZB WH	5031171	50
SS-ZB YE	5031650	50
UMK-BF	2976077	50



For 45 mm wide PCBs

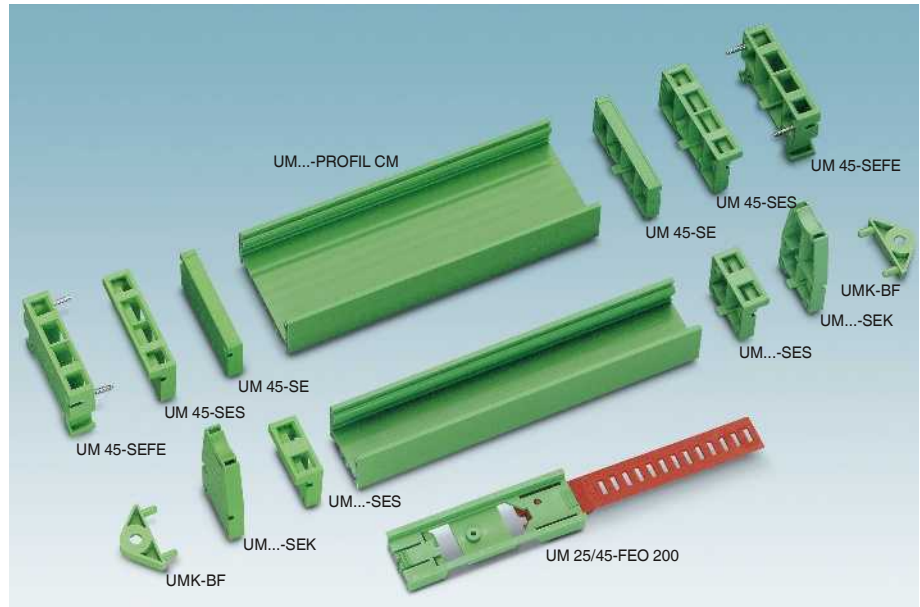

Assembly of the UM 25 and UM 45 profiles

Order key for UM profiles:

Quantity	Order No.	Profile width	Length [cm]	Color
1	29 52 02 0	UM 108	22,5	GN6021
		UM 25 ≅ 25 mm UM 45 ≅ 45 mm UM 72 ≅ 72 mm UM 100 ≅ 100 mm UM 108 ≅ 108 mm UM 122 ≅ 122 mm	Min. 3.0 cm Max. 100.0 cm	GN6021 ≅ Pale green BK9005 ≅ Jet black GY7032 ≅ Pebble gray GY7035 ≅ Light gray

General note:

The area that can be equipped is reduced once by 3 mm at the edges of the profiles.

Ordering notes:

In order to determine the profile length, 0.3 cm must be subtracted from the PCB length. The exception is when a side element with the ending O.N. is used; here the profile length is the same as that of the PCB.

Technical data

PVC / V0

Ordering data

Type	Order No.	Pcs. / Pkt.
UM 45-PROFIL 100CM	2914550	1
UM -PROFIL	2952020	1
UM 45-SEAS	2907554	10
UM 45-SES	2959308	10
UM 45-SE	2906131	10
UM 45-SEK	2959311	10
UM 45-SEFE	2907826	10
UM 45-SEFE O.N.	2959793	10
UM 25/45-FEO 200	2959434	10

Accessories

SS-ZB WH	5031171	50
SS-ZB YE	5031650	50
UMK-BF	2976077	50

Profile racks and adapters

UM profile panel mounting base

The UM 72, UM 100, and UM 108 press-drawn sections offer three levels for PCBs for flexible positioning or SMD technology (for example).

Very small UM ...-LG 10 modules, measuring 10 x 90 mm or 10 x 125 mm, can be created by combining two side elements. The press-drawn sections are manufactured to the required length and are available in lengths up to 100 cm.

Optional UM 108 A/U... transparent covers in two heights and with widths of 60 and 73 mm are available for the UM 100 and UM 108. Guide slots are integrated into the tall side elements. This means that additional printed circuit boards can be arranged vertically on the base printed circuit board.

Further advantages:

- Fast installation on conventional NS 35 or NS 32 DIN rails
- The modules can be marked with Phoenix marking material in the label grooves provided
- Side elements with potential-earth contact from the PCB to the DIN rail (EMC)
- A host of options for external conductor connection, see chapter COMBICON control

Housing dimensions can be found in the Download Center at:
www.phoenixcontact.net/products.

Notes:
Information concerning the housing:
PVC profile, inflammability class V0 (UL 94).
Polyamide PA side elements, inflammability class V0 (UL 94).
U-shaped PVC profile covers, inflammability class HB (UL 94).
U-shaped PC profile covers, high-temperature resistant, inflammability class V0 (UL 94).
1) To define the profile length and width, please observe the order key.
2) Please indicate the desired length in [cm].



For 72 mm wide PCBs

Type of housing
Electronic housings

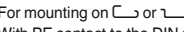
Description
Drawn section Fixed length 100 cm
Cut to length according to customer specifications ¹⁾
Side element with foot , 5 mm wide, right hand side, for mounting NS 32 or NS 35...
Side element with foot , 5 mm wide, left hand side
For mounting on  , With PE contact to the DIN rail
Side element , 5 mm wide
Foot element , for mounting on NS 35 or NS 32, under the UM 72 or UM 108 profile housing

Side element, with foot, tall version, right hand, For 60 mm wide U-shaped cover for 73 mm wide U-shaped cover
Side element, with foot, flat version, right hand for 73 mm wide U-shaped cover
Side element, with foot, flat version, left hand for 73 mm wide U-shaped cover With PE contact to the DIN rail
Side element, flat version, without foot green
Side element, tall version, without foot For 60 mm wide U-shaped cover for 73 mm wide U-shaped cover
Side element, with foot, tall version, left hand, For 60 mm wide U-shaped cover With PE contact to the DIN rail for 73 mm wide U-shaped cover With PE contact to the DIN rail
U profile cover, tall version , widths of 60 mm (internal dimension 56 mm) and 73 mm (internal dimension 69 mm) are available. Please note the ordering example and the order key.
U-shaped cover, flat version , high-temperature resistant PC material, 73 mm wide (internal dimensions 69 mm) ²⁾
Mounting flange , for mounting directly on the wall

10 mm wide module, consisting of two side elements, PCB dimensions: 8 x 72 or 8 x 107.5 mm

Technical data	
PVC / V0	

Ordering data		
Type	Order No.	Pcs. / Pkt.
UM 72-PROFIL 100CM	2907583	1
UM -PROFIL	2952020	1
UM 72-SEFE/R	2959353	10
UM 72-SEFE/L	2959340	10
UM 72-SEPEF/L	2906487	10
UM 72-SE	2959337	10
UM 72-FE	2959382	10

Accessories		
Type	Order No.	Pcs. / Pkt.
UMK-BF	2976077	50
8 UM 72-LG 10	2959366	10



For 107.5 mm wide PCBs

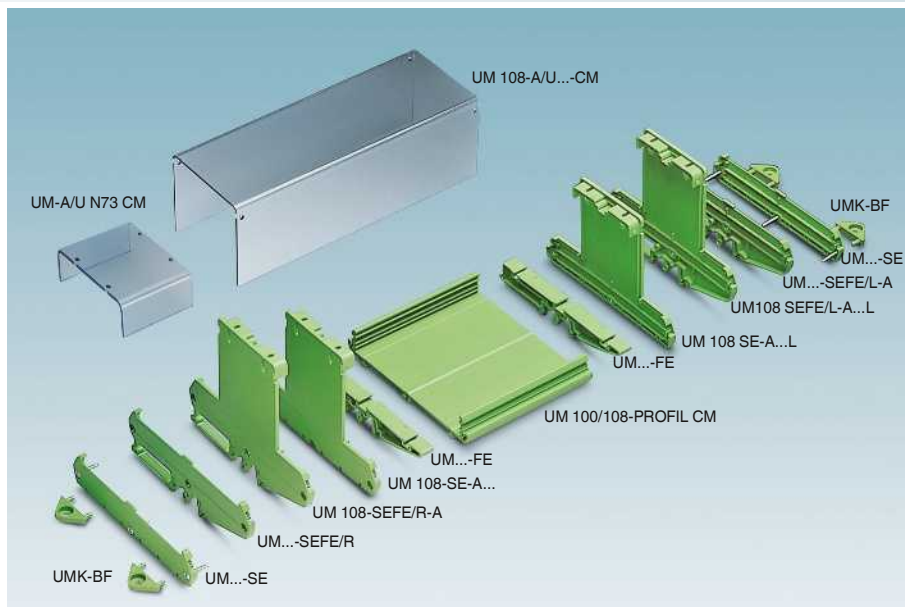

Assembly of the UM 72 and UM 100/108 press-drawn sections

Order key for UM profile covers

Pcs.	Order No.	Width Cover [mm]	/ Length [cm]
1	28 54 89 8	AU73	8,4
		AU60 ≅ 60 mm	3,0 cm, minimum
		AU73 ≅ 73 mm	100,0 cm, maximum

General information on UM 72, UM 100/108

Use the same housing accessory elements (lateral elements, U-shaped profile covers, etc.) for the UM 100 profile as for the UM 108 profile

Instead of the foot elements and the lateral elements, two lateral elements with foot can be used. Corresponding screws are supplied as standard with lateral elements.

Ordering example:
For an 87.5 x 107.5 x 1.5 PCB, the profile length is 8.4 cm.

The following parts are required for a module including the cover:

- 1 x Press-drawn section
Order key 2952020/UM108/8,4/GN6021
- 1 x UM profile cover
Order key 2854898/U73/8,4
- 1 x Lateral element with foot, left
Order No. 29 59 73 5
- 1 x Lateral element with foot, right
Order No. 29 59 71 9

Ordering information:

The PCB area available for assembly is reduced by 2 mm at each edge of the press-drawn sections and on the front of the lateral elements in the tall version.

In order to determine the profile length, 0.35 cm must be subtracted from the PCB length.

The overall length of the module, i.e., including the lateral elements, is equal to the profile length plus 0.3 cm per lateral element.

For the UM 108-A/U profile cover, specify the same length as for the UM 100/108-PROFIL... press-drawn section.

A minimum profile length of 3 cm is required to ensure assembly.

Technical data

PVC / V0

Ordering data

Type	Order No.	Pcs. / Pkt.
UM100-PROFIL 100CM	2914563	1
UM108-PROFIL 100CM	2907525	1
UM -PROFIL	2952020	1
UM108-SEFE/R	2959683	10
UM108-SEFE/L	2959696	10
UM108-SEPEF/L	2906490	10
UM108-SE	2959476	10
UM108-FE	2959463	10

Accessories

UM108-SEFE/R-A60	2959706	10
UM108-SEFE/R-A73	2959719	10
UM108 N-SEFE/R-A73	2709354	10
UM108 N-SEFE/L-A73	2709367	10
UM108 N-SEPEF/L-A73	2709370	10
UM108 N-SE-A73	2709383	10
UM108-SE-A60	2959748	10
UM108-SE-A73	2959751	10
UM108-SEFE/L-A60	2959722	10
UM108-SEPEF/L-A60	2906500	10
UM108-SEFE/L-A73	2959735	10
UM108-SEPEF/L-A73	2906513	10
UM108-A/U CM	2854898	1
UM-A/U N 73 CM	2706852	1
UMK-BF	2976077	50
UM108-LG 10	2959780	10

Profile racks and adapters

UM profile panel mounting base



The UM 122 press-drawn section is particularly suitable for the installation of bulky industrial electronics.

Very small UM 122-LG 13 modules, measuring 13 x 127.5 mm, can be created by snapping on two side elements. The press-drawn section is manufactured to the required length and is available in lengths up to 100 cm.

By using the UM 122-A/U 92 profile cover, shock and dust-proof electronic modules can be created. The cover can be cut to suit your requirements and can be labeled with the AP-ES insert strips using the grooves inside. To prevent the cover from being unintentionally removed, a seal can be integrated.

Further advantages:

- Can be snapped onto commercially available NS 35/7,5 and NS 35/15 DIN rails
- A host of options for external conductor connection, see chapter COMBICON control

Housing dimensions can be found in the Download Center at: www.phoenixcontact.net/products.

Notes:
Order information for UM 122
In order to determine the profile length, 0.95 cm must be subtracted from the PCB length. The length of the cover corresponds to the PCB length minus 0.18 cm. The overall length of the module, i.e. including the side elements, corresponds to the profile length plus 1.35 cm per side element. A minimum profile length of 3 cm is required to guarantee mounting.
The printed circuit board area available for components is reduced by 2 mm at the edges of the profiles and on the front of the side elements.
The profile cover must be chosen at 0.77 cm longer than the drawn section.
Information concerning the housing:
PVC profile, inflammability class V0 (UL 94).
Polyamide PA side elements, inflammability class V0 (UL 94).
Profile cover PC, inflammability class V2 (UL 94).
¹⁾ To define the profile length and width, please observe the order key.

Type of housing
Electronic housings

Description
Drawn section Fixed length 100 cm Cut to length according to customer specifications ¹⁾
Side element with foot , 5 mm wide, right hand side, for mounting NS 32 or NS 35...
Side element with foot , 5 mm wide, left hand side, for mounting on NS 32 or NS 35...
13 mm wide module , consisting of two side elements, PCB dimensions: 11.7 x 122 mm
Side element , with screw fixture to attach cover UM 122 to NS 35
U profile cover , for UM 122, 92 mm wide
Foot element , for UM 122 profile housing

Phoenix module marker carrier , for marking modules and PCBs, for hole diameters 3.9 to 4.1 mm, thickness of the housing wall or PCB: 1.5 to 2.0 mm, lettering field: 29.8 x 8 mm
Insert strips , for group marking, for sliding into the cover profile AP 2 and AP 3, cardboard, lettering field: 35 x 500 mm
Marker pen, not refillable , for manual marking, line thickness 0.5 mm



For 122 mm wide PCBs

Technical data		
PVC / V0		
Ordering data		
Type	Order No.	Pcs. / Pkt.
UM122-PROFIL 100CM	2914576	1
UM -PROFIL	2952020	1
UM122-SEFE/R	2908786	10
UM122-SEFE/L	2908773	10
UM122-LG 13	2908809	10
UM122-SEMFE-A92	2909442	10
UM122-A/U92	2909455	1
UM122-FE	2909471	10
Accessories		
PMB	1004364	50
AP-ES	5022685	10
B-STIFT	1051993	10

The **UM...** profile panel mounting bases are available in the following fixed lengths:

Description	Type	Order No.	Pcs. Pkt.
Design width 25 mm Fixed length 100 cm	UM 25-PROFIL 100 CM	29 15 79 5	1
Design width 45 mm Fixed length 100 cm	UM 45-PROFIL 100 CM	29 14 55 0	1
Design width 72 mm Fixed length 100 cm	UM 72-PROFIL 100 CM	29 07 58 3	1
Design width 100 mm Fixed length 100 cm	UM 100-PROFIL 100 CM	29 14 56 3	1
Design width 108 mm Fixed length 100 cm	UM 108-PROFIL 100 CM	29 07 52 5	1
Design width 122 mm Fixed length 100 cm	UM 122-PROFIL 100 CM	29 14 57 6	1

Profile racks and adapters

UMK plug-in module panel mounting base

The compact UMK custom circuit modules are used for individually constructing simple adaptation and interconnection functions as well as comprehensive electronic circuits that can be installed on DIN rails. They comprise various single elements with different dimensions and functions.

Depending on the desired module size and the space requirement, various individual elements are linked together into one module. The UMK base elements are available in widths of 11.25 mm, 22.5 mm and 45 mm. Two side elements with a width of 11.25 mm each produce – when engaged – the smallest module of 22.5 x 77 mm. Adding together base elements of various widths results in the particular module dimension required. One or more foot elements are provided depending on the module size.

The advantages are:

- Fast assembly due to the pluggable module principle. The tight engagement of the individual elements ensures that they are securely connected
- Thanks to the universal foot, the modules snap onto commercially available EN DIN rails
- The mounting flange enables mounting directly on the wall
- The modules can be marked using the marking grooves in the side element as well as with the Phoenix Contact module marker PMB, which snaps into a hole (4 mm Ø) in the PCB
- For a host of options for external conductor connection, see chapter on COMBICON control

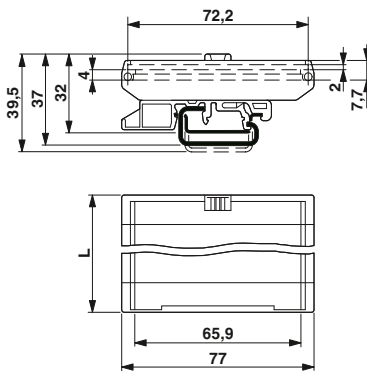

Type of housing	Electronic housings
Description	<p>Side element, 11.25 mm wide, with marker groove</p> <p>Side element, 11.25 mm wide, without marker groove</p> <p>Base element, 11.25 mm wide</p> <p>Base element, 22.5 mm wide</p> <p>Base element, 45 mm wide</p> <p>Foot element, for mounting on a NS 32 or NS 35..., can be inserted into base and side element</p> <p>Mounting flange, for mounting directly on the wall</p>



Technical data		
Polyamide / V2		
Ordering data		
Type	Order No.	Pcs. / Pkt.
UMK-SE 11,25	2970002	10
UMK-SE 11,25-1	2970442	50
UMK-BE 11,25	2971535	10
UMK-BE 22,5	2970028	10
UMK-BE 45	2970015	10
UMK-FE	2970031	10
UMK-BF	2976077	50

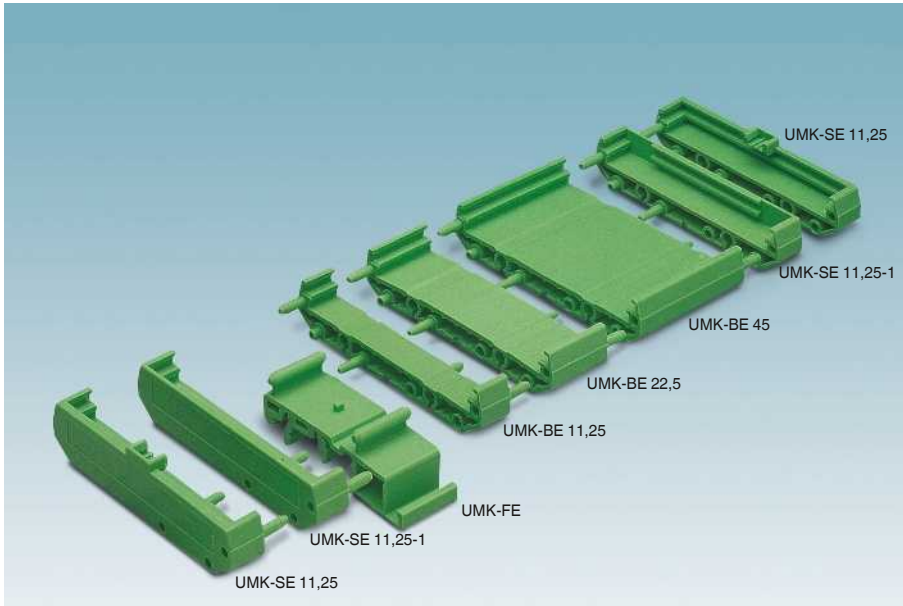

Assembly of the UMK universal modules

PCB dimensions [mm]	Module width L[mm]	Side element UMK-SE...	Base element UMK-BE 11,25	Base element UMK-BE 22,5	Base element UMK-BE 45	Foot element UMK-FE
20.00 x 72 x 1.5	22.50	2	–	–	–	1
31.25 x 72 x 1.5	33.75	2	1	–	–	1
42.50 x 72 x 1.5	45.00	2	–	1	–	2
53.75 x 72 x 1.5	56.25	2	1	1	–	2
65.00 x 72 x 1.5	67.50	2	–	–	1	2
76.25 x 72 x 1.5	78.75	2	1	–	1	2
87.50 x 72 x 1.5	90.00	2	–	1	1	2
98.75 x 72 x 1.5	101.25	2	1	1	1	2
110.00 x 72 x 1.5	112.50	2	–	–	2	2
121.25 x 72 x 1.5	123.75	2	1	–	2	2
132.50 x 72 x 1.5	135.00	2	–	1	2	2
143.75 x 72 x 1.5	146.25	2	1	1	2	3
155.00 x 72 x 1.5	157.50	2	–	–	3	3
166.25 x 72 x 1.5	168.75	2	1	–	3	3
177.50 x 72 x 1.5	180.00	2	–	1	3	3

Note on printed circuit board assembly:

The area that can be equipped is reduced once by 3 mm at the edges of the base elements and by 1.6 mm at the front of the side elements.

Profile racks and adapters

UM plug-in module panel mounting base

The UM universal modules are suitable for accommodating one printed circuit board for the construction of individual electronic circuits, e.g. programmable controls. They comprise individual elements with various dimensions and functions. By arranging the individual base elements in a row, the printed circuit board surface can be multiplied. Metal pins engage the individual base elements to form a sturdy unit. The various base elements are available with or without ribs to support the printed circuit board. Depending on the module size, one or more base elements can be fitted with a snap foot, which easily engages on EN DIN rails.

The side elements close the aligned base elements on both sides and are available in four designs:

- The UM-SE side element
- The UM-SE-A 60 high side element for 60 mm wide U-shaped covers and
- The UM-SE-A73/N low side element for 73 mm wide U-shaped covers
- The UM-SE-A 73 high side element for 73 mm wide U-shaped covers

The high lateral elements are available with or without a guide slot for the mechanical fixing of PCBs arranged perpendicular to the base board.

The length of the transparent U-shaped covers is decided on a case-to-case basis. A comprehensive product range is available for the conductor connection. See the COMBICON control chapter.

Notes:
Information concerning the housing:
U-profile cover UM-A/U73... made of PVC/HB (UL 94)
U-profile cover UM-A/U73-HT CM made of PC/V0 (UL 94)
U-profile cover UM-A/U N73 CM made of PC/V0 (UL 94)
¹⁾ Please indicate the desired length in [cm]



With ribs for mechanical PCB support

Type of housing	Electronic housings
-----------------	---------------------

Description
Universal module , individual assembly, consisting of: Base element with snap-on foot, for mounting on NS 35... or NS 32 DIN rail.
With ribs, L = 35 mm
Without ribs, L = 35 mm
Without snap-on foot, with ribs, L = 35 mm
Without ribs, L = 35 mm, without snap-on foot
With ribs, L = 16.5 mm, without snap-on foot
Without ribs, L = 16.5 mm, without snap-on foot
Connection pin , brass, for engaging several base elements to form one unit, 4 units necessary per element
Side element , for closing both ends of the base element UM-BEFE
Side element , flat version for 73 mm wide profile cover

Side element , tall version For 60 mm wide U-shaped cover for 73 mm wide U-shaped cover
Side element , high profile, with guide grooves for vertically arranged printed circuit boards For 60 mm wide U-shaped cover for 73 mm wide U-shaped cover
U profile cover , tall version, PVC. Please note the order key.
U-shaped cover , tall version, high-temperature resistant PC material ¹⁾
U-shaped cover , flat version, high-temperature resistant PC material, 73 mm wide (internal dimensions 69 mm) ¹⁾
Transparent hood , for one base element, UM-BEFE (with 2 UM-SE) snaps on, 60 mm wide, 50 mm high



Technical data		
Polyamide / V0		
Ordering data		
Type	Order No.	Pcs. / Pkt.
UM-BEFE 35	2955564	10
UM-BE 35	2955577	10
UM-BE 16,5	2956903	50
UM-VS	2955580	50
UM-SE	2955593	10
UM-SE-A73/N	2962256	10
Accessories		
UM-SE-A60	2955616	10
UM-SE-A73	2955603	10
UM-SE-A60-R	2956893	10
UM-SE-A73-R	2956741	10
UM-A/U CM	2854885	1
UM-A/U 73-HT CM	2853310	1
UM-A/U N 73 CM	2706852	1
UM-H	2955441	10



Without ribs



Technical data

Polyamide / V0

Ordering data

Type	Order No.	Pcs. / Pkt.
UM-BEFE 35-1	2956660	10
UM-BE 35-1	2956657	10
UM-BE 16,5-1	2958053	50
UM-VS	2955580	50
UM-SE 1	2958147	10
UM-SE-A73/N	2962256	10

Accessories

UM-SE-A60	2955616	10
UM-SE-A73	2955603	10
UM-SE-A60-R	2956893	10
UM-SE-A73-R	2956741	10
UM-A/U CM	2854885	1
UM-A/U 73-HT CM	2853310	1
UM-A/U N 73 CM	2706852	1
UM-H	2955441	10

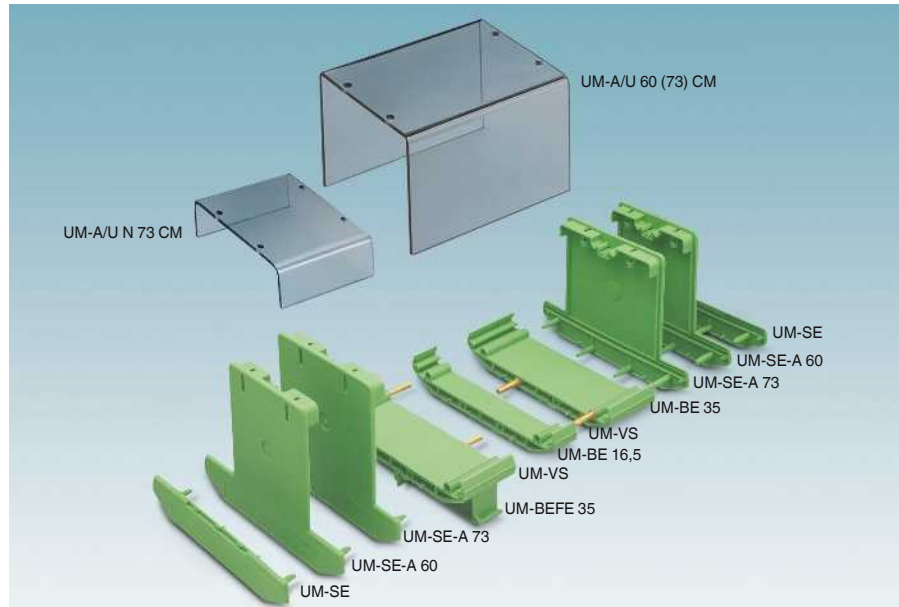

Assembly of UM modules - base element with ribs

PCB dimensions [mm]	Module length L [cm]	Base element UM-BEFE 35 UM-BEFE 35-1	Base element UM-BE 35 UM-BE 35-1	Base element UM-BE 16,5 UM-BE 16,5-1	Lateral element UM-SE A 60 UM-SE A 73 UM-SE-A 73	Length [cm] of U-shaped profile cover UM-A/U 60(73)...
38.5 x 107.5 x 1.5	4.0	1	-	-	2	3.5
55.0 x 107.5 x 1.5	5.65	1	-	1	2	5.15
73.5 x 107.5 x 1.5	7.5	2	-	-	2	7.0
90.0 x 107.5 x 1.5	9.15	2	-	1	2	8.65
108.5 x 107.5 x 1.5	11.0	2	1	-	2	10.5
125.0 x 107.5 x 1.5	12.65	2	1	1	2	12.15
143.5 x 107.5 x 1.5	14.5	2	2	-	2	14.0
160.0 x 107.5 x 1.5	16.15	2	2	1	2	15.65
178.5 x 107.5 x 1.5	18.0	3	2	-	2	17.5

Note on PCB assembly:

The area available for assembly is reduced by 3 mm at the edges of the base elements and by 1.6 mm at the front edge of the lateral elements.

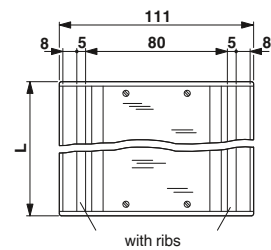
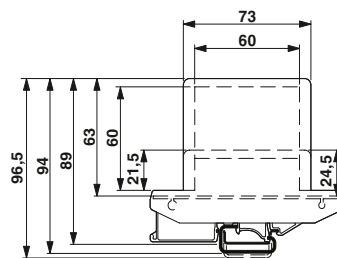

Profile racks and adapters

DIN rail adapter UTA, DIN rail adapter EM-MP/SISM

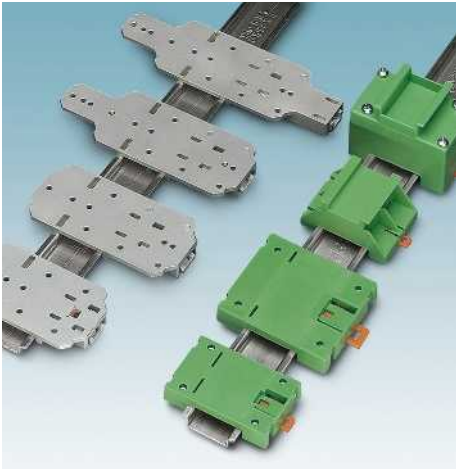

The UTA universal DIN rail adapters enable devices such as power supply units or sensor/actuator boxes to be snapped onto standard DIN rails in accordance with EN 60715.

The sturdy metal design with corrosion-resistant surface ensures a long service life and a secure grip even under extreme loads.

The EM-MP and SISM DIN-rail mountable mounting plates made from polycarbonate plastic are specially designed for small transformers of up to approx. 100 VA and offer additional installation space for interconnecting cables or electronic circuits.

Details concerning the dimensions of the DIN rail adapters can be found in the downloadcenter at

www.phoenixcontact.net/products.



Universal DIN rail adapter

		Technical data		
Type of housing	Electronic housings	Zinc die-cast / -		
		Ordering data		
Description		Type	Order No.	Pcs. / Pkt.
	Universal DIN rail adapter, for screwing on switchgear	UTA 89	2853970	5
		UTA 107	2853983	5
		UTA 130	2706412	5
		UTA 136	2853996	5
		UTA 159	2854018	5
		UTA 184	2854021	5
	Mounting plate, enclosed design, to snap on switchgear			
	Mounting plate, for screwing on switchgear (M4 fastening thread)			



Mounting plate, closed design



Mounting plate, low design



Mounting plate, flat design

Technical data		
Polyamide fiber reinforced / V2		

Ordering data		
---------------	--	--

Type	Order No.	Pcs. / Pkt.
EM-MPG 45	2944177	10

Technical data		
Polyamide fiber reinforced / V2		

Ordering data		
---------------	--	--

Type	Order No.	Pcs. / Pkt.
SISM 45	2942865	10
SISM 45 H	2940139	10

Technical data		
Polyamide fiber reinforced / V2		

Ordering data		
---------------	--	--

Type	Order No.	Pcs. / Pkt.
EM-MP 45N	2943712	10
EM-MP 70	2942742	10

Housing handheld

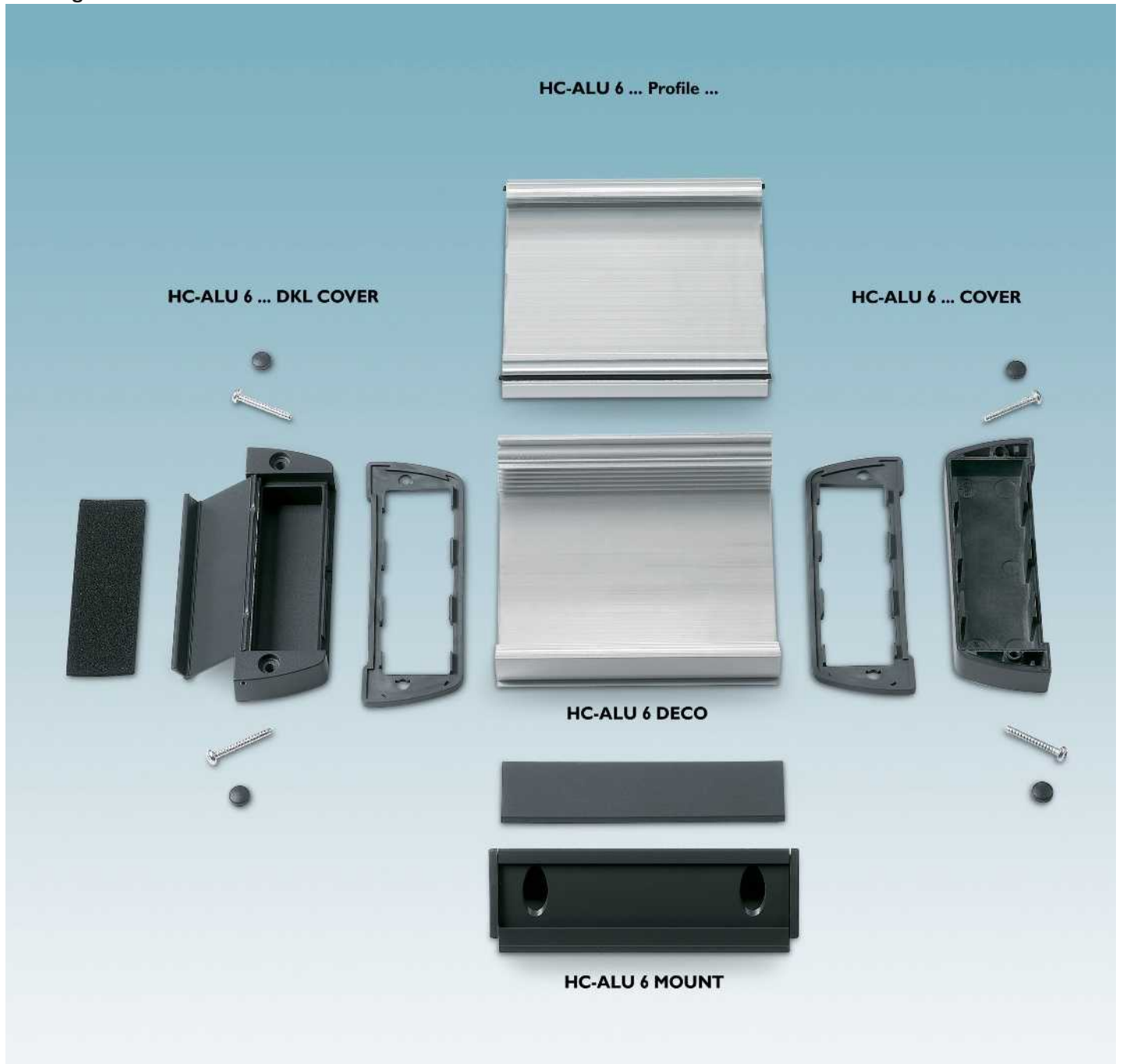

HC-ALU handheld housings, which are made from aluminum, provide protection for your electronics against both spray water and thermal and mechanical stress in the field.

The housing is particularly suitable for temperature ranges from -40°C to $+70^{\circ}\text{C}$ and offers IP65 protection according to DIN EN 60529.



Split press-drawn section

The split housing enables the integration of elements which protrude through the front surface. Both profile halves securely latch together, making integrating a membrane keypad or display child's play.

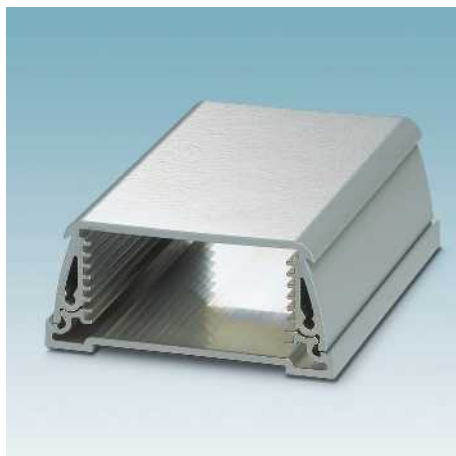

Ergonomic design

The trapezoidal external shape of the housing improves ergonomics for the device operator. The level, smooth side of the housing also facilitates printing.

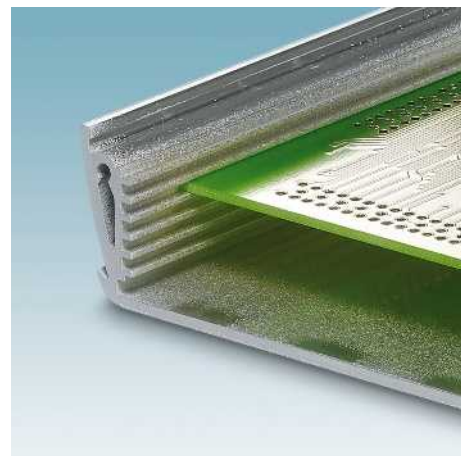

Unrestricted assembly

All PCBs have the same external dimensions and can be securely fixed in various locations in the housing. This provides the required flexibility for positioning various components or modules.



Intelligent interface

The COVERS have a 2 mm recessed surface for accommodating slides or labels. The version with mounting cover allows optional installation of plug-in connectors or sockets.

For improved EMC properties, an alternative version is available with a metal-filled seal.



Individual use

The sophisticated range of accessories opens up diverse applications. Decorative strips suitable for printing can be inserted into the grooves on the side of the housing. With the matching wall fastening, the housing can be used as a wall, operation, or front plate solution.



Added value from the works

In addition to the products which can be ordered from the catalog, we offer an extensive range of additional services from special profile lengths through additional mechanical processing and printing, and even membrane keypads.

Handheld housings for use in the field

HC-ALU 6... handheld aluminum profile housing



Aluminum profile
Width: 53.5 mm



Aluminum profile
Width: 78 mm

Description	Ordering data			Ordering data		
	Type	Order No.	Pcs. / Pkt.	Type	Order No.	Pcs. / Pkt.
Silver split profile , including cord seal						
Length 100 mm	HC-ALU 6-53,5 PROFILE 100	2200887	1	HC-ALU 6-78 PROFILE 100	2200892	1
Length 150 mm	HC-ALU 6-53,5 PROFILE 150	2200888	1	HC-ALU 6-78 PROFILE 150	2200893	1
Length 200 mm	HC-ALU 6-53,5 PROFILE 200	2200889	1	HC-ALU 6-78 PROFILE 200	2200894	1
Length 1000 mm	HC-ALU 6-53,5 PROFILE 1000	2200890	1	HC-ALU 6-78 PROFILE 1000	2200895	1
End cover , graphite gray, with screws and seal						
	HC-ALU 6-53,5 COVER GY	2200891	1	HC-ALU 6-78 COVER GY	2200896	1
End cover, graphite gray, with hinged flap, screws and seal						
	HC-ALU 6-53,5 DKL-COVER GY	2201121	1	HC-ALU 6-78 DKL-COVER GY	2201122	1
	Accessories			Accessories		
EMC seal , black	HC-ALU 6-53,5 SEAL EMC	2200907	10	HC-ALU 6-78 SEAL EMC	2200908	10
Decorative strip , dark gray, length = 98.4 mm	HC-ALU 6 DECO 100 GY	2200914	10	HC-ALU 6 DECO 100 GY	2200914	10
Decorative strip , dark gray, length = 148.4 mm						
	HC-ALU 6 DECO 150 GY	2200915	10	HC-ALU 6 DECO 150 GY	2200915	10
Decorative strip , dark gray, length = 198.4 mm	HC-ALU 6 DECO 200 GY	2200916	10	HC-ALU 6 DECO 200 GY	2200916	10
Panel fastening , including cover caps, for 100 mm profile section, graphite gray	HC-ALU 6 MOUNT 100 GY	2200911	2	HC-ALU 6 MOUNT 100 GY	2200911	2
Panel fastening , including cover caps, for 150 mm profile section, graphite gray	HC-ALU 6 MOUNT 150 GY	2200912	2	HC-ALU 6 MOUNT 150 GY	2200912	2
Panel fastening , including cover caps, for 200 mm profile section, graphite gray	HC-ALU 6 MOUNT 200 GY	2200913	2	HC-ALU 6 MOUNT 200 GY	2200913	2
Screwdriver set , Torx® with drill bit, 6-part, incl. rack, contents: TX 8 x 60; TX 10 x 80; TX 15 x 80; TX 20 x 100; TX 25 x 100; TX 30 x 115	SF-TXH SET	1212538	1	SF-TXH SET	1212538	1
Bit screwdriver set with quick-action chuck , 89 mm long slotted/cross-recessed (PZ and PH)/hex / Torx® bits, 17-part, in folding belt pouch, contents: PH 1,2,3 x 89; PZ 1,2,3 x 89; SL 1.5 x 5.5 x 89; TX 10-30 x 89; SW 3,4,5,6 x 89						
	SF-M SET	1212543	1	SF-M SET	1212543	1



Aluminum profile
Width: 100.5 mm



Aluminum profile
Width: 161 mm

Ordering data		
Type	Order No.	Pcs. / Pkt.
HC-ALU 6-100,5 PROFILE 100	2200897	1
HC-ALU 6-100,5 PROFILE 150	2200898	1
HC-ALU 6-100,5 PROFILE 200	2200899	1
HC-ALU 6-100,5 PROFILE 1000	2200900	1
HC-ALU 6-100,5 COVER GY	2200901	1
HC-ALU 6-100,5 DKL-COVER GY	2201123	1

Ordering data		
Type	Order No.	Pcs. / Pkt.
HC-ALU 6-161 PROFILE 100	2200902	1
HC-ALU 6-161 PROFILE 150	2200903	1
HC-ALU 6-161 PROFILE 200	2200904	1
HC-ALU 6-161 PROFILE 1000	2200905	1
HC-ALU 6-161 COVER GY	2200906	1

Accessories		
HC-ALU 6-100,5 SEAL EMC	2200909	10
HC-ALU 6 DECO 100 GY	2200914	10
HC-ALU 6 DECO 150 GY	2200915	10
HC-ALU 6 DECO 200 GY	2200916	10
HC-ALU 6 MOUNT 100 GY	2200911	2
HC-ALU 6 MOUNT 150 GY	2200912	2
HC-ALU 6 MOUNT 200 GY	2200913	2
SF-TXH SET	1212538	1
SF-M SET	1212543	1

Accessories		
HC-ALU 6-161 SEAL EMC	2200910	10
HC-ALU 6 DECO 100 GY	2200914	10
HC-ALU 6 DECO 150 GY	2200915	10
HC-ALU 6 DECO 200 GY	2200916	10
HC-ALU 6-161 MOUNT 100 GY	2201327	2
UM-ALU 6-161 MOUNT 150 GY	2201332	2
UM-ALU 6-161 MOUNT 200 GY	2201334	2
SF-TXH SET	1212538	1
SF-M SET	1212543	1

Technical data

Notes on power dissipation

Power dissipation values should be used as a guide only. They are largely dependent on:

- The PCB arrangement in the housing
- The position of components (as a source of heat)
- The number of assembled PCBs in the housing
- The mounting position of the housing

Reduction factor depending on the ambient temperature

Since the maximum permissible power dissipation decreases as the ambient temperature increases, the listed reduction factor (K_t) must be taken into account when calculating the permissible power dissipation.

Formula for calculating the power dissipation depending on the ambient temperature $P_{vtu} = P_{vt} \times K_t$
Explanations:

P_v = Power dissipation
 t_u = Ambient temperature
 $t = 20^\circ\text{C}$
 K_t = Reduction factor

Example:

Power dissipation at 40°C
 $P_{v40^\circ\text{C}} = P_{v20^\circ\text{C}} \times K_t = 10.8 \text{ W} \times 0.81$
 $= 8.75 \text{ W}$

Reduction factor for CM compact component housing

Ambient temperature [$^\circ\text{C}$]

	20	30	40	50	60
K_t	1	0.83	0.65	0.48	0.33

Reduction factor for ME/ME BUS/ME TBUS/ME MAX modular component housing

Ambient temperature [$^\circ\text{C}$]

	20	30	40	50	60
K_t	1	0.91	0.81	0.7	0.57

Reduction factor for EG beaker-type component housing

Ambient temperature [$^\circ\text{C}$]

	20	30	40	50	60
K_t	1	0.80	0.62	0.47	0.30

Reduction factor for UEGH universal component housing

Ambient temperature [$^\circ\text{C}$]

	0	10	20	30	40	50	60
K_t	1.15	1.08	1	0.91	0.81	0.71	0.59

Reduction factor for UEG-EU universal component housing

Ambient temperature [°C]

	20	30	40	50	60
K_i	1	0.87	0.75	0.58	0.49

Reduction factor for UEGM universal component housing

Ambient temperature [°C]

	20	30	40	50	60	70	80
K_i	1	0.8	0.64	0.51	0.41	0.33	0.26

Reduction factor for UEG universal component housing

Ambient temperature [°C]

	20	30	40	40	60	70	80
K_i	1	0.78	0.61	0.48	0.37	0.29	0.23

Reduction factor for EFG single component housing

Ambient temperature [°C]

	20	30	40	50	60
K_i	1	0.90	0.78	0.66	0.55

Reduction factor for EMG system component housing

Ambient temperature [°C]

	20	30	40	50	60
K_i	1	0.8	0.64	0.51	0.41

Reduction factor for BC installation component housing

Ambient temperature [°C]

	20	30	40	50	60	70
K_i	1	0.84	0.72	0.60	0.48	0.38

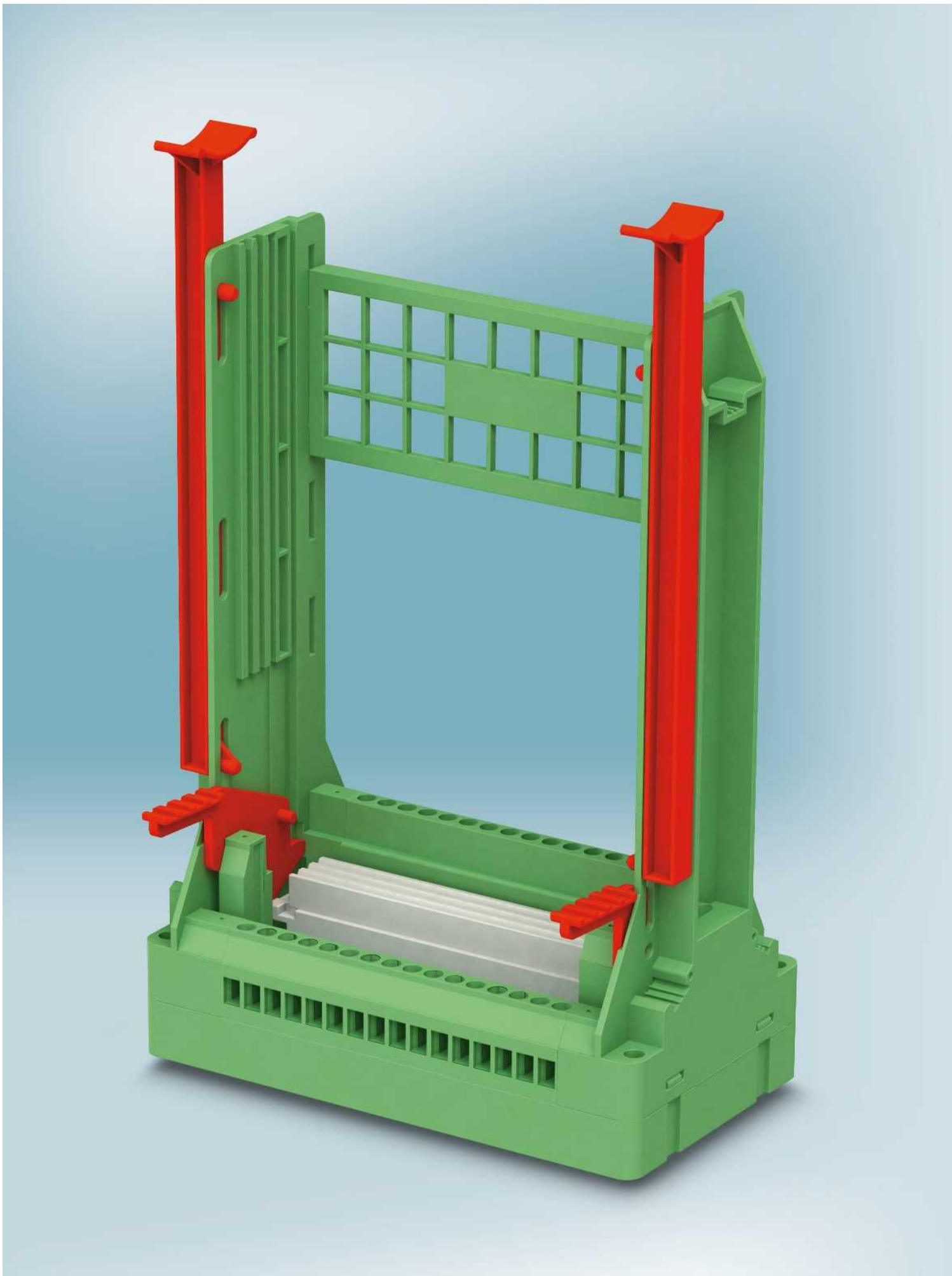

Plug-in card blocks and socket strips according to DIN 41617 and IEC 60603-2/DIN 41612

SKBI plug-in card blocks

SKBI plug-in card blocks for plug-in connectors according to DIN 41617 and IEC 60603-2/DIN 41612 can be used to mount single or double European-format cards at any location in the control cabinet and wire them easily via a screw connection. The PCB is reliably supported in the rugged insulating housing and is automatically held in position by engagement catches which prevent it from falling out. The easy-to-operate ejectors make releasing the PCB easy, even where space is limited.

SFLY/FRONT-SFL screw-type socket strips

The SFLY and FRONT-SFL socket strips with screw connection at the rear have been developed for use in 19" racks. They are suitable for D and F design 32-pos. pin strips according to IEC 60603-2/DIN 41612. The special feature of the Y-shaped SFLY screw-type socket strip is the angled arrangement of the terminal blocks. In addition to user-friendly handling and a clear view during connection, the conductors can be laid in this "cable duct" without taking up any additional space.

Socket strip with spring-cage connection FRONT-ZFL 1,5/...

The FRONT-ZFL 1,5 D32 socket strip with a spring-cage connection at the rear has been specially developed for use in 19" racks. The installation dimensions and the marking of the individual terminal points meet the requirements of IEC 60603-2/DIN 41612 for design D32.

General

SKBI plug-in card blocks	776
For plug-in connectors according to DIN 41617 and IEC 60603-2/DIN 41612	

SFLY screw-type socket strips	788
For pin strips according to IEC 60603-2/DIN 41612	

Socket strips with FRONT-ZFL spring-cage connection	789
For plug-in connectors according to IEC 60603-2/DIN 41612	

FRONT-ZFL socket strip

FRONT-SFL screw-type socket strips	790
---	------------

General

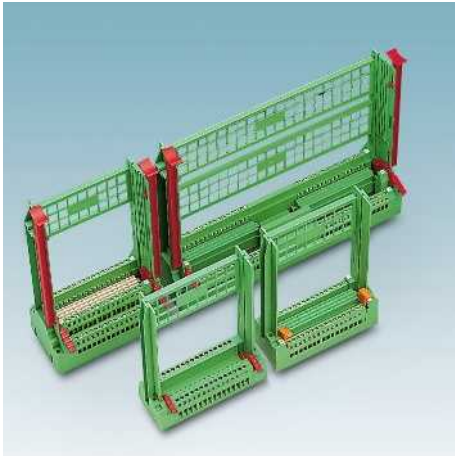

General

Industrial electronics are a fixed component of conventional control engineering. PCBs in 100 x 160 mm European format are primarily used here.

Increased safety requirements and the higher density of components and connections are speeding up the trend toward the indirect contacting principle using pin strips according to DIN 41617 and IEC 60603-2/DIN 41612.

Plug-in cards are usually grouped together in the electronic racks of 19" cabinets. Although these types of racks are practical for many PCBs, they are expensive:

- If only one, two or three cards are installed and connected.
- If the PCB is distributed, thereby saving wiring in the control cabinet.
- If older systems are later modernized by adding one or two electronic cards.

Racks are expensive, bulky, and can only be accessed from the rear or with the aid of a complex swing frame. In addition, connections can often only be made with the Wire-Wrap® or TERMI-POINT® connection technologies, which are not suitable for heavy currents.

These disadvantages are overcome by Phoenix Contact SKBI plug-in card blocks. They can be used to mount single or double European-format cards at any location in the control cabinet and wire them easily via a screw connection.

The PCB is reliably supported in the sturdy insulating housing and is automatically held in position by engagement catches which protect it from vibrations. The easy-to-operate ejectors make releasing the PCB easy, even where space is limited.

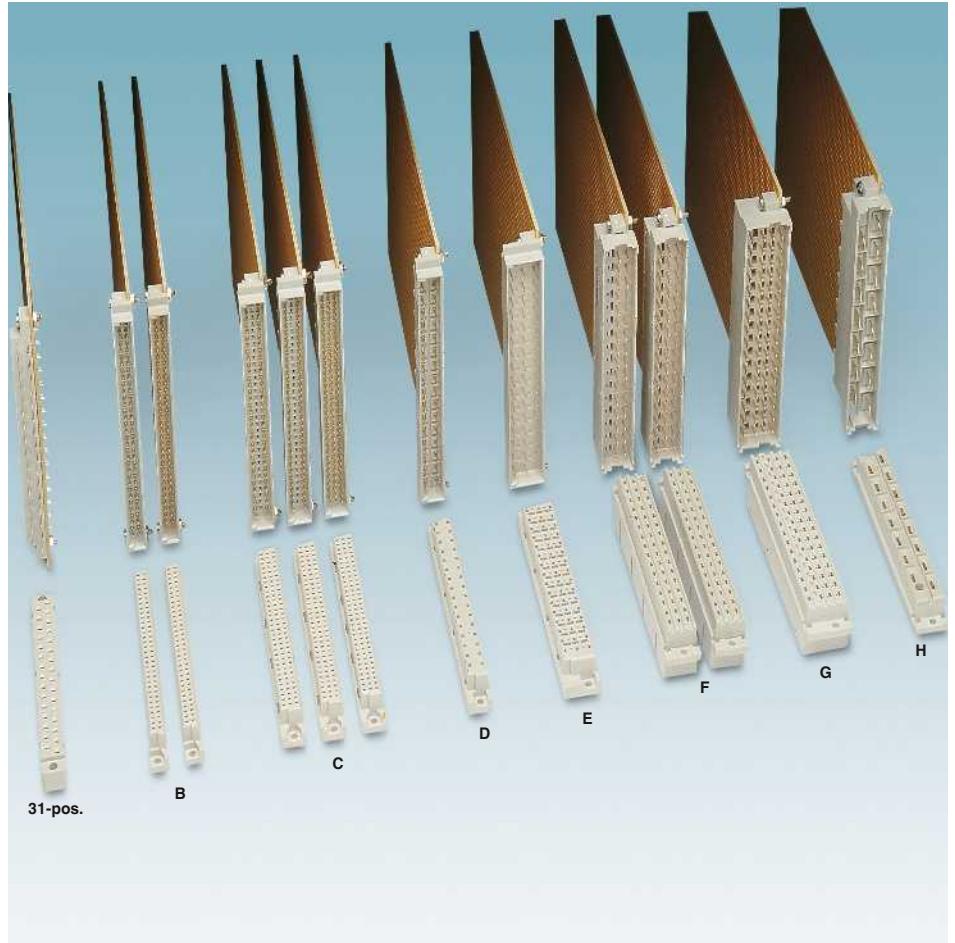

Plug-in connectors according to DIN 41617 and IEC 60603-2/DIN 41612

With the introduction of the 100 x 160 mm European format, the 31-pos. pin strip according to DIN 41617 was commonly used at the beginning of the 1960s as an indirect plug-in connector. The exposed, round pins in a metric 5 mm zigzag arrangement are typical of these connectors.

The rapid developments in industrial electronics, i.e., the increasing packing density of electronic components on the PCB, required greater numbers of contacts. Moreover, safety requirements were designed for increased protection of the contact pins against mechanical damage and contamination. This led to the development of the plug-in connector according to IEC 60603-2/DIN 41617.

All types in this range are based on a pitch of 2.54 mm (one tenth of an inch). The seven vertical rows are marked z to f, the individual pins of the lines are marked 1 to 32 from top to bottom. All contacts are gold-plated. The standards also require that plug-in connectors consisting of pin and socket strips and made by different manufacturers should be compatible with one another.

Over time, two types with different contact assignments have emerged:

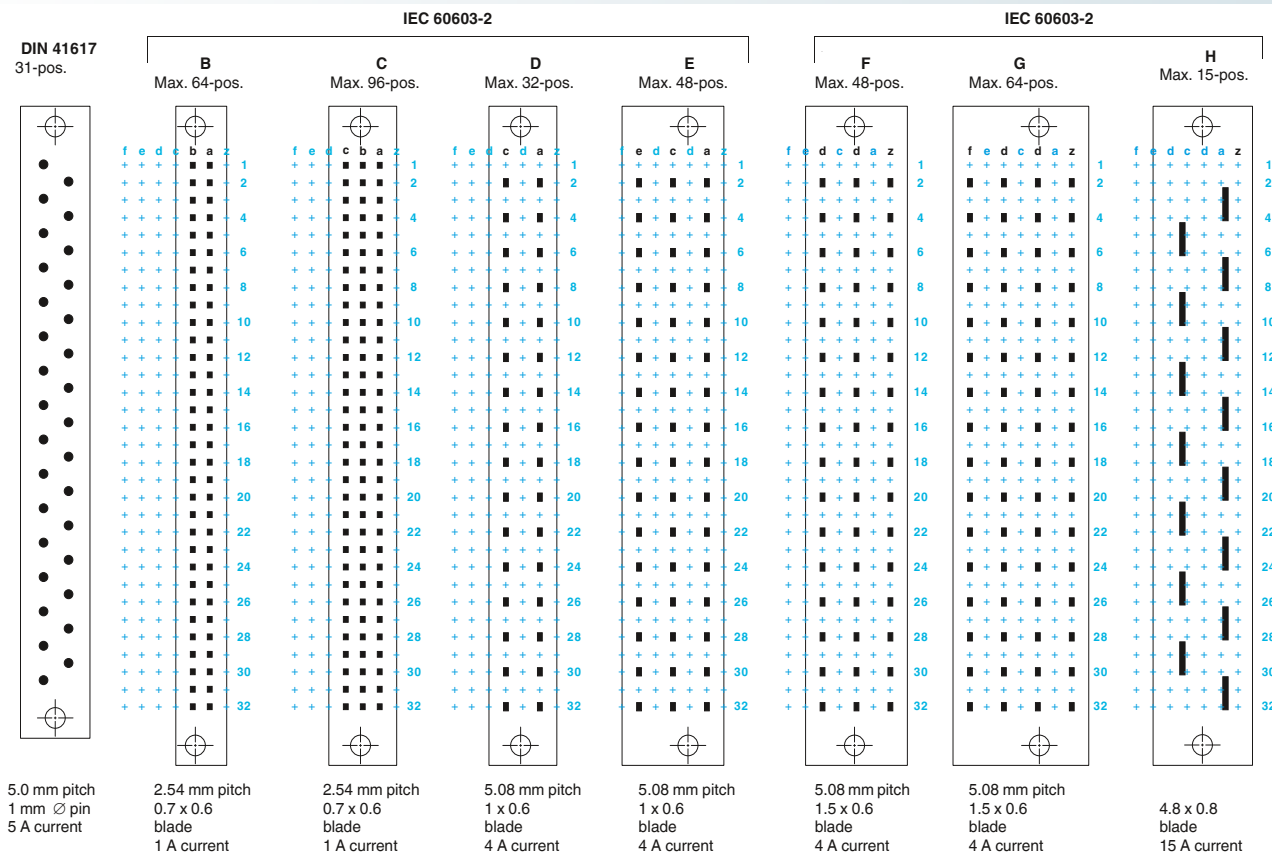

Series 1

Series 1 plug-in connectors are available both as a high-position version with closely spaced contacts and 1 A current carrying capacity, and (for industrial power electronics) with a smaller number of positions, a large 5.08 mm contact pitch, and contacts capable of carrying up to 4 A.

Type B

This 64-pos. plug-in connector results from the complete use of rows a and b. The contacts are dimensioned for a current carrying capacity of 1 A. The position spacing means that these connectors can be used for voltages up to 125 V according to DIN VDE 0110/Gr. B. In the 32-pos. version, only the even-numbered positions are used.

Type C

Adding row c produces this 96-pos. plug-in connector. If only the two outer rows, a and c, are used, the alternative type, C 64, results.

If this is further reduced to just the even-numbered positions of rows a and c, type C 32 with a 5.08 mm horizontal and vertical spacing of the 1 A contacts results. A nominal voltage of 250 V is thereby achieved according to DIN VDE 0110/Gr. C.

Type D

This connector has the same dimensions and the same contact arrangement (even-numbered positions in rows a and c) as type C 32. The only difference is the reinforced

contacts, which are capable of carrying a current of up to 4 A.

Type E

Adding rows d and e to type D 32 results in the 48-pos. connector with 4 A contacts with 5.08 mm pitch. This means that all even-numbered positions in rows a, c, and e are used.

Series 2

For series 2 plug-in connectors, the pitch of the rear connections in both directions is 5.08 mm. The row spacing on the plug-in side is just 3.81 mm. In addition, the creepage distances to ground are increased by raising the housing at the rear, resulting in a different wiring level from that of series 1.

The contacts are all capable of carrying up to 4 A. For this reason, series 2 plug-in connectors are primarily used in industrial power electronics.

The fixing hole is almost exactly in the center of the strip. The trick to this is that another contact row, marked z, is added in front of row a. (This comes from regarding the alphabet as a closed ring and counting backwards from a.)

Type F

In addition to the complete 48-pos. design which uses all even-numbered positions in rows z, b, and d, the DIN standard also includes a partially assembled 32-pos. version in rows z and b. Occasionally, to ensure larger mutual insulation distances, the positions in rows z and d may be used.

Type G

This type results from adding pitch rows e and f, while still using only the even-numbered positions.

Type H

These 15-pos. high-current strips have the same dimensions as types C and F. However, they are distinguished by a different plug-in geometry and amplified contacts with a current carrying capacity of 15 A.

Other types

In addition to the strips equipped with the same type of contacts, there are mixed types, e.g., H 7/F 24, shortened versions such as C 1/2, and inverted type R. All these, however, play a secondary role in practical industrial applications.

More details available on request.

Plug-in card blocks

SKBI plug-in card blocks

31-pos. plug-in card block for European-format cards with indirect connection in accordance with DIN 41617

PCBs with 31-pos. connectors in accordance with DIN 41617 with the characteristic zig-zag layout of the round pins are still widely used.

In the case of the SKBI 31 plug-in card block, the pins make contact with gold-plated fork springs, which are floating, i.e. mechanically decoupled from the terminal point. This makes the contact resistance very stable and lower than 2 mΩ.

In order to prevent incorrect insertion of the PCBs and the plug-in card blocks, specific contact pins are cut off and the corresponding contact holes are closed with CS/SKBI coding pins.



31-pos., in acc. with DIN 41617

General data	
Pitch	5 mm
Pin diameter	1.00 mm
Voltage	250 V
Current	5 A
Stripping length	8 mm
Screw thread	M3
Torque	0.5 Nm ... 0.6 Nm
Connection data solid / stranded / AWG	0.2 ... 4 mm ² / 0.2 ... 2.5 mm ² / 24 - 12

Description	
Plug-in card block, 31-pos. , for indirect connection in accordance with IEC 60603-1/DIN 41617, including guide rails, engagement catches and ejector, with standardized marking on both connection sides, as well as fixing screws M4	

Snap-on foot , for horizontal or vertical mounting of the blocks on the NS 35/7.5-DIN rail
Coding pin , plastic, is subsequently inserted into a contact of the SKBI, color: Red
Screwdriver Blade: 0.6 x 3.5 x 100 mm, length: 181 mm



Technical data

Pitch	5 mm
Pin diameter	1.00 mm
Voltage	250 V
Current	5 A
Stripping length	8 mm
Screw thread	M3
Torque	0.5 Nm ... 0.6 Nm
Connection data solid / stranded / AWG	0.2 ... 4 mm ² / 0.2 ... 2.5 mm ² / 24 - 12

Ordering data

Type	Order No.	Pcs. / Pkt.
SKBI 31	2201519	1

Accessories

SF-SKBI 31/32	2261009	10
CS-SKBI	2204082	100
SZS 0,6X3,5	1205053	10

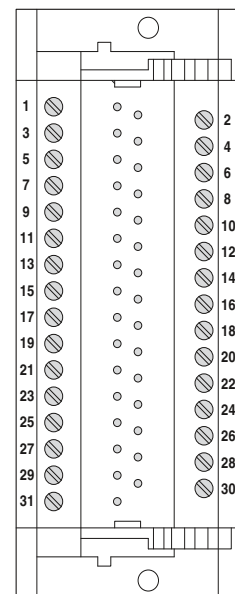
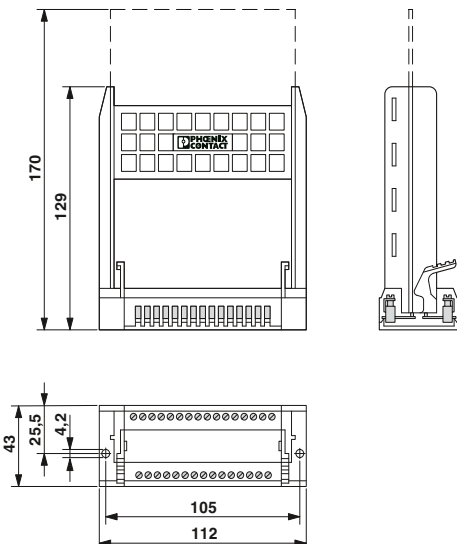

Plug-in card blocks

SKBI plug-in card blocks

32-pos. plug-in card blocks for European-format cards with indirect connection in accordance with IEC 60603-2/DIN 41612

The three blocks in this series permit insertion of PCBs with pin strip designs C, D, and F in accordance with IEC 60603-2/DIN 41612. The blocks are labeled according to the standard and have spring-loaded engagement catches, which do not, however, act as ejectors.



32-pos., type C



General data	
Pitch	5,08 mm
Knife dimensions	0.7 x 0.6 mm
Voltage	250 V
Current	1 A
Stripping length	8 mm
Screw thread	M3
Torque	0.5 Nm ... 0.6 Nm
Connection data solid / stranded / AWG	0.2 ... 4 mm ² / 0.2 ... 2.5 mm ² / 24 - 12

Technical data

Pitch	5,08 mm
Knife dimensions	0.7 x 0.6 mm
Voltage	250 V
Current	1 A
Stripping length	8 mm
Screw thread	M3
Torque	0.5 Nm ... 0.6 Nm
Connection data solid / stranded / AWG	0.2 ... 4 mm ² / 0.2 ... 2.5 mm ² / 24 - 12

Description	
Plug-in card block, 32-pos. , for indirect connection in accordance with IEC 60603-2/DIN 41612, complete with guide rails and engagement catches, without ejector, with standardized marking on both connection sides, as well as M4 mounting screws	

Ordering data

Type	Order No.	Pcs. / Pkt.
SKBI 32/C	2261038	1

Snap-on foot , for horizontal or vertical mounting of the blocks on the NS 35/7.5-DIN rail
Coding pin , plastic, is subsequently inserted into a contact of the SKBI, color: Red

Accessories

SF-SKBI 31/32	2261009	10
CS-SKBI	2204082	100

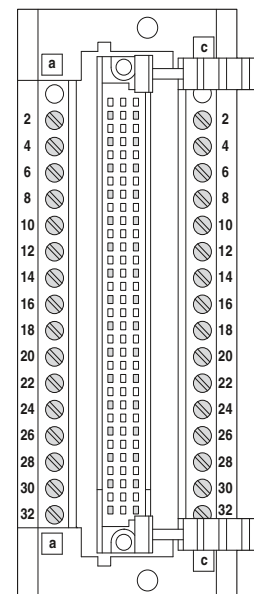
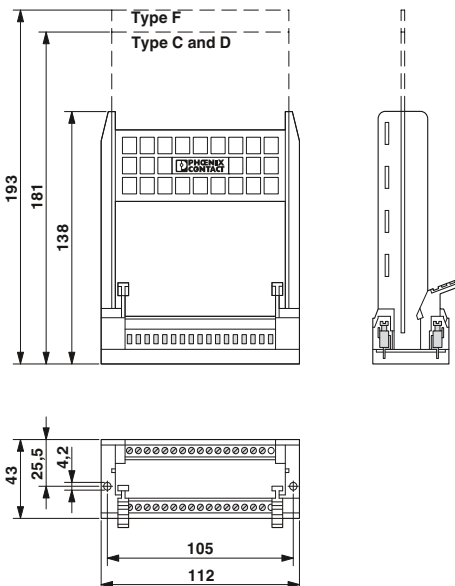



32-position, type D



32-pos., type F, equipped in rows z and b



32-pos., type F, equipped in rows z and d



Technical data		
5.08 mm		
1 x 0.6 mm		
250 V		
4 A		
8 mm		
M3		
0.5 Nm ... 0.6 Nm		
0.2 ... 4 mm ² / 0.2 ... 2.5 mm ² / 24 - 12		
Ordering data		
Type	Order No.	Pcs. / Pkt.
SKBI 32/D	2261054	1
Accessories		
Type	Order No.	Pcs. / Pkt.
SF-SKBI 31/32	2261009	10

Technical data		
5.08 mm		
1.5 x 0.6 mm		
250 V (in acc. with DIN VDE 0110/Gr.B)		
4 A		
8 mm		
M3		
0.5 Nm ... 0.6 Nm		
0.2 ... 4 mm ² / 0.2 ... 2.5 mm ² / 24 - 12		
Ordering data		
Type	Order No.	Pcs. / Pkt.
SKBI 32/F/ZB	2261096	1
Accessories		
Type	Order No.	Pcs. / Pkt.
SF-SKBI 31/32	2261009	10

Technical data		
5.08 mm		
1.5 x 0.6 mm		
250 V (in acc. with DIN VDE 0110/Gr.B)		
4 A		
8 mm		
M3		
0.5 Nm ... 0.6 Nm		
0.2 ... 4 mm ² / 0.2 ... 2.5 mm ² / 24 - 12		
Ordering data		
Type	Order No.	Pcs. / Pkt.
SKBI 32/F/ZD	2261106	1
Accessories		
Type	Order No.	Pcs. / Pkt.
SF-SKBI 31/32	2261009	10

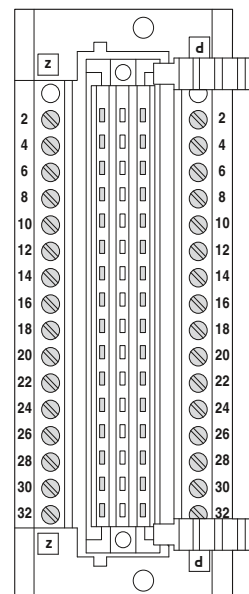
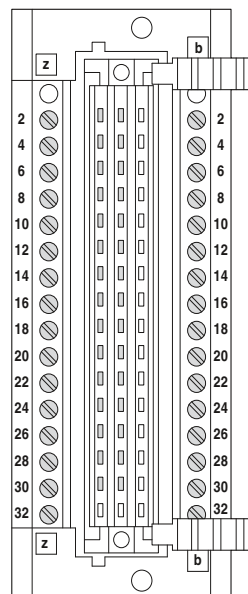
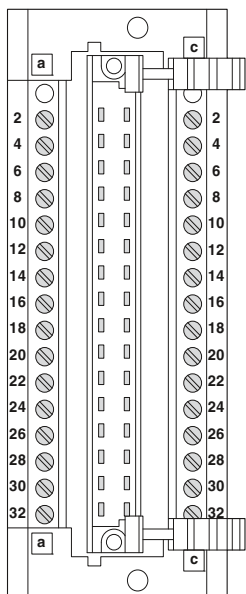

Plug-in card blocks

SKBI plug-in card blocks

64-pos. plug-in card blocks for European-format cards with indirect connection in accordance with IEC 60603-2/DIN 41612

These plug-in card blocks have double-level screw connection terminal block rows on both sides. The offset arrangement of the levels improves the conductor accessibility and the legibility of labels. The robust overall design of the block ensures sturdy support also for heavy PCBs. These are held in place by engagement catches with an ejector that can be operated from the front.



64-pos., type B



General data	
Pitch	2.54 mm
Knife dimensions	0.7 x 0.6 mm
Voltage	125 V (in acc. with DIN VDE 0110/Gr.B)
Current	1 A
Stripping length	8 mm
Screw thread	M3
Torque	0.5 Nm ... 0.6 Nm
Connection data solid / stranded / AWG	0.2 ... 4 mm ² / 0.2 ... 2.5 mm ² / 24 - 12

Technical data

Pitch	2.54 mm
Knife dimensions	0.7 x 0.6 mm
Voltage	125 V (in acc. with DIN VDE 0110/Gr.B)
Current	1 A
Stripping length	8 mm
Screw thread	M3
Torque	0.5 Nm ... 0.6 Nm
Connection data solid / stranded / AWG	0.2 ... 4 mm ² / 0.2 ... 2.5 mm ² / 24 - 12

Description	
Plug-in card block , 64-pos., for indirect connection in accordance with IEC 60603-2/DIN 41612, complete with guide rails, engagement catches, and ejector, with standardized marking on both connection sides, as well as M4 mounting screws	

Ordering data

Type	Order No.	Pcs. / Pkt.
SKBI 64/B64	2263023	1

Snap-on foot , for horizontal or vertical mounting of the blocks on the NS 35/7.5-DIN rail
Screwdriver Blade: 0.6 x 3.5 x 100 mm, length: 181 mm

Accessories

SF-SKBI 64	2263007	10
SZS 0,6X3,5	1205053	10

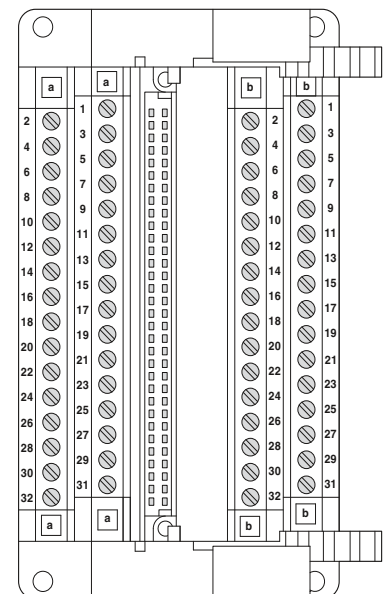
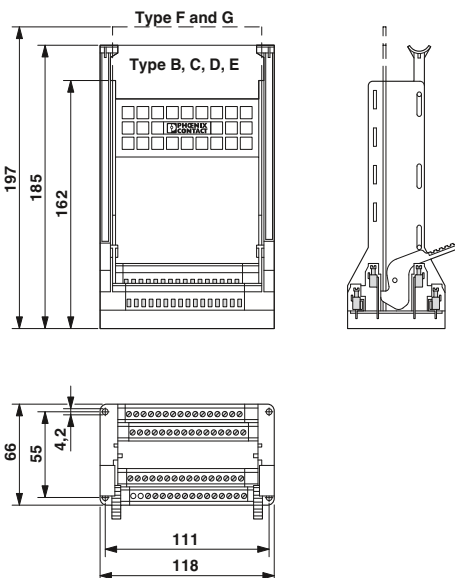



32-pos., type C, equipped in the even numbers of positions in rows a and c

64-pos., type C, equipped in rows a and c



Technical data	
5.08 mm	
0.7 x 0.6 mm	
250 V (surge voltage category III/contamination class 2)	
1 A	
8 mm	
M3	
0.5 Nm ... 0.6 Nm	
0.2 ... 4 mm ² / 0.2 ... 2.5 mm ² / 24 - 12	

Technical data	
2.54 mm	
0.7 x 0.6 mm	
125 V (in acc. with DIN VDE 0110/Gr.B)	
1 A	
8 mm	
M3	
0.5 Nm ... 0.6 Nm	
0.2 ... 4 mm ² / 0.2 ... 2.5 mm ² / 24 - 12	

Ordering data		
Type	Order No.	Pcs. / Pkt.
SKBI 64/C32	2265034	1

Ordering data		
Type	Order No.	Pcs. / Pkt.
SKBI 64/C64	2263036	1

Accessories		
Type	Order No.	Pcs. / Pkt.
SF-SKBI 64	2263007	10
SZS 0,6X3,5	1205053	10

Accessories		
Type	Order No.	Pcs. / Pkt.
SF-SKBI 64	2263007	10
SZS 0,6X3,5	1205053	10

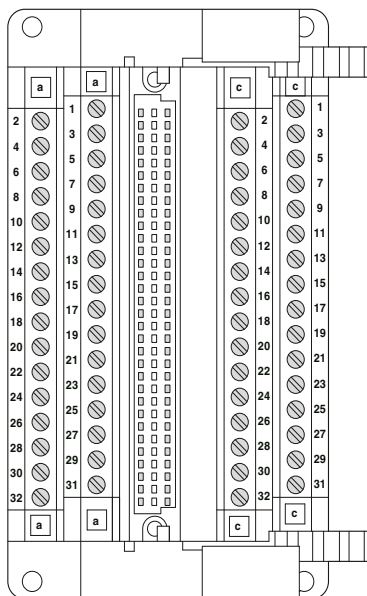
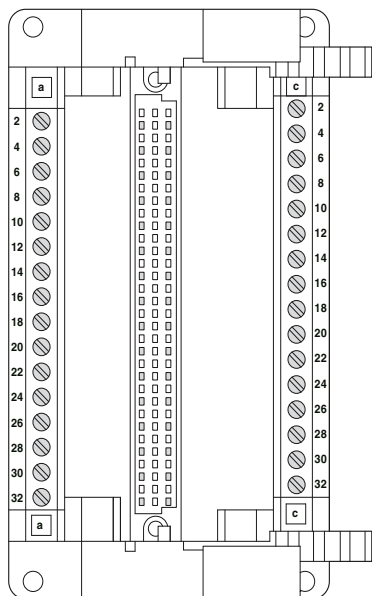

Plug-in card blocks

SKBI plug-in card blocks

Plug-in card blocks for European-format cards with indirect connection in accordance with IEC 60603-2/DIN 41612

These plug-in card blocks have screw connection terminal block rows on both sides. Additional marking makes it easier to connect the conductors. The robust overall design of the block ensures sturdy support for heavy PCBs as well. These are held in place by engagement catches with an ejector that can be operated from the front.



32-pos., type D, equipped in rows a and c



General data	
Pitch	5,08 mm
Knife dimensions	1 x 0.6 mm
Voltage	250 V (surge voltage category III/contamination class 2)
Current	4 A
Stripping length	8 mm
Screw thread	M3
Torque	0.5 Nm ... 0.6 Nm
Connection data solid / stranded / AWG	0.2 ... 4 mm ² / 0.2 ... 2.5 mm ² / 24 - 12

Technical data

Pitch	5,08 mm
Knife dimensions	1 x 0.6 mm
Voltage	250 V (surge voltage category III/contamination class 2)
Current	4 A
Stripping length	8 mm
Screw thread	M3
Torque	0.5 Nm ... 0.6 Nm
Connection data solid / stranded / AWG	0.2 ... 4 mm ² / 0.2 ... 2.5 mm ² / 24 - 12

Description	
Plug-in card block , 64-pos., for indirect connection in accordance with IEC 60603-2/DIN 41612, complete with guide rails, engagement catches, and ejector, with standardized marking on both connection sides, as well as M4 mounting screws	

Ordering data

Type	Order No.	Pcs. / Pkt.
SKBI 64/D32	2265050	1

Snap-on foot , for horizontal or vertical mounting of the blocks on the NS 35/7.5-DIN rail

Accessories

SF-SKBI 64	2263007	10
SZS 0,6X3,5	1205053	10

Screwdriver Blade: 0,6 x 3.5 x 100 mm, length: 181 mm

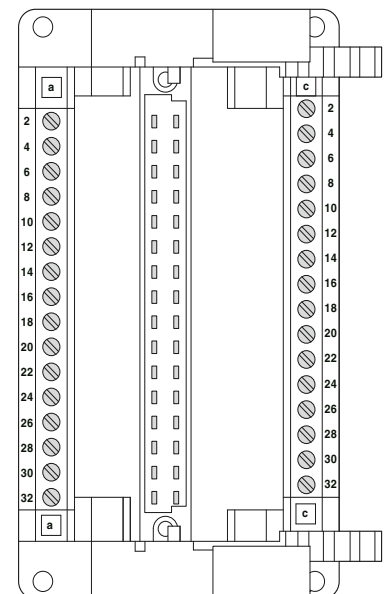
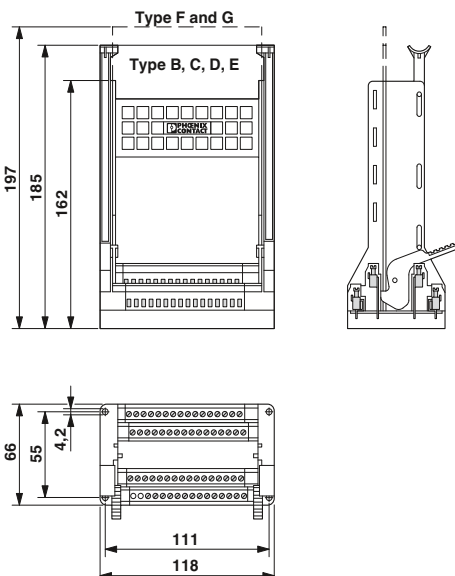



48-pos., type E, equipped in rows a, c, and e



48-pos., type F, equipped in rows z, b, and d



64-pos., type G, equipped in rows z, b, d, and f



Technical data	
5.08 mm	
1 x 0.6 mm	
250 V (surge voltage category III/contamination class 2)	
4 A	
8 mm	
M3	
0.5 Nm ... 0.6 Nm	
0.2 ... 4 mm ² / 0.2 ... 2.5 mm ² / 24 - 12	

Technical data	
5.08 mm	
1.5 x 0.6 mm	
250 V (in acc. with DIN VDE 0110/Gr.B)	
4 A	
8 mm	
M3	
0.5 Nm ... 0.6 Nm	
0.2 ... 4 mm ² / 0.2 ... 2.5 mm ² / 24 - 12	

Technical data	
5.08 mm	
1.5 x 0.6 mm	
250 V (in acc. with DIN VDE 0110/Gr.B)	
4 A	
8 mm	
M3	
0.5 Nm ... 0.6 Nm	
0.2 ... 4 mm ² / 0.2 ... 2.5 mm ² / 24 - 12	

Ordering data		
Type	Order No.	Pcs. / Pkt.
SKBI 64/E48	2264080	1

Ordering data		
Type	Order No.	Pcs. / Pkt.
SKBI 64/F48	2264093	1

Ordering data		
Type	Order No.	Pcs. / Pkt.
SKBI 64/G64	2263117	1

Accessories		
Type	Order No.	Pcs. / Pkt.
SF-SKBI 64	2263007	10
SZS 0,6X3,5	1205053	10

Accessories		
Type	Order No.	Pcs. / Pkt.
SF-SKBI 64	2263007	10
SZS 0,6X3,5	1205053	10

Accessories		
Type	Order No.	Pcs. / Pkt.
SF-SKBI 64	2263007	10
SZS 0,6X3,5	1205053	10

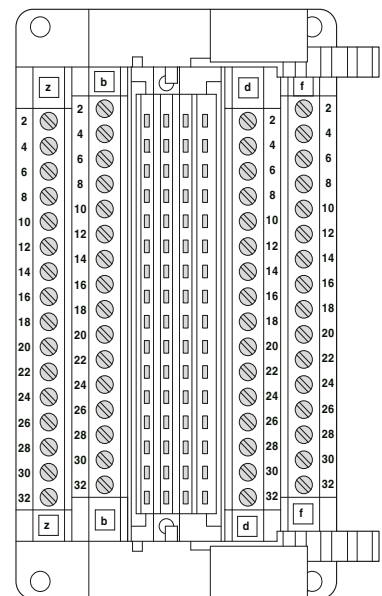
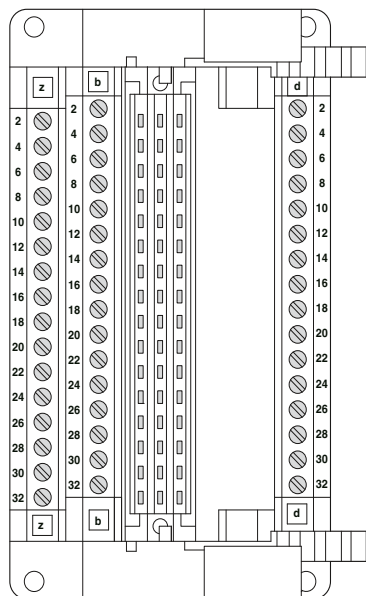
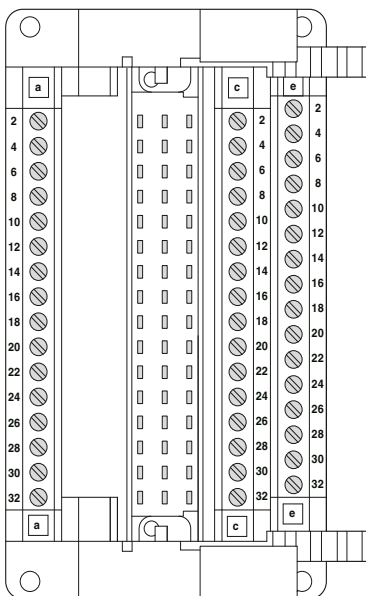

Plug-in card blocks

SKBI plug-in card blocks

15-pos. plug-in card blocks for European-format cards with H15 high-current socket strip in accordance with IEC 60603-2/DIN 41612

With these plug-in card blocks, single 19" power supply racks, e.g. switched-mode power supply units, can be mounted at any point in the control cabinet and easily wired with a screw connection. Every position of the H 15 high-current socket strip is assigned with either two 2.5 mm² MKDS 3, or one 4 mm² MKDS 5 connection terminal block. The robust overall design of the blocks ensures sturdy support also for heavy PCBs. After insertion, these are automatically secured against vibrations with two engagement catches with an ejector that can be operated from the front.



15-pos., 2.5 mm² connection cross section

General data

Knife dimensions
Voltage

Current
Stripping length
Screw thread

Torque
Connection data solid / stranded / AWG



Technical data

4,8 x 0,8 mm
250 V (surge voltage category III/contamination class 2)

15 A
8 mm
M3
0,5 Nm ... 0,6 Nm
0,2 ... 4 mm² / 0,2 ... 2,5 mm² / 24 - 12

Description

Plug-in card block, with MKDS 3 screw terminal blocks and connection terminal blocks, and H15 high-current socket strip for indirect control in accordance with IEC 60603-2/DIN 41612, complete with guide rails, engagement catches, and ejector, with standardized marking on both connection sides, as well as M4 mounting screws

Plug-in card block, with MKDS 5 screw connection terminal blocks and H15 high-current socket strip for indirect connection in accordance with IEC 60603-2/DIN 41612, complete with guide rails, engagement catches, and ejector, with standardized marking on both connection sides, as well as M4 mounting screws

Ordering data

Type	Order No.	Pcs. / Pkt.
SKBI 64/H15-MKDS3	2269140	1

Accessories

SF-SKBI 64	2263007	10
SZS 0,6X3,5	1205053	10

Snap-on foot, for horizontal or vertical mounting of the blocks on the NS 35/7.5-DIN rail

Screwdriver

Blade: 0,6 x 3,5 x 100 mm, length: 181 mm

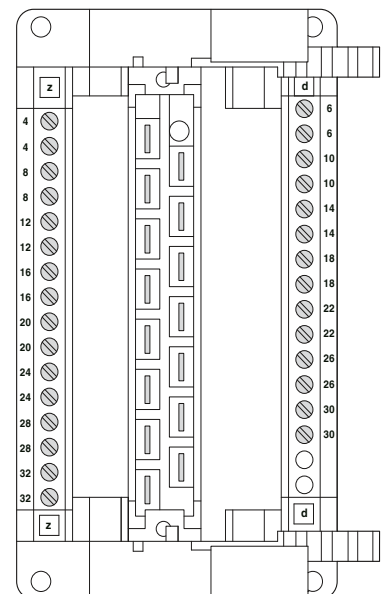
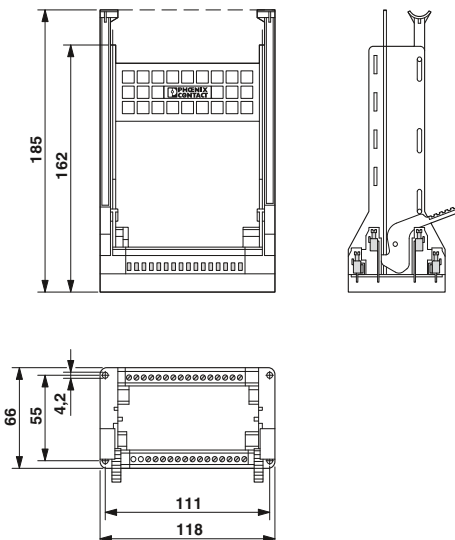



15-pos., 4 mm² connection cross section



Technical data

4.8 x 0.8 mm
 500 V (surge voltage category III/contamination class 2)
 15 A
 8 mm
 M3
 0.5 Nm ... 0.6 Nm
 0.2 ... 6 mm² / 0.2 ... 4 mm² / 24 - 10

Ordering data

Type	Order No.	Pcs. / Pkt.
SKBI 64/H15-MKDS5	2269153	1

Accessories

SF-SKBI 64	2263007	10
SZS 0,6X3,5	1205053	10

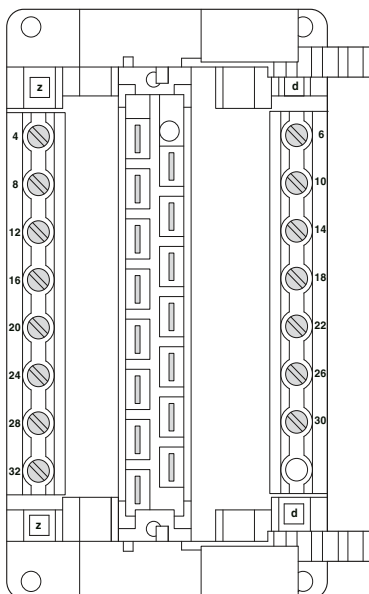

Plug-in card blocks

SKBI plug-in card blocks

128-pos. plug-in card blocks for double European-format cards with indirect connection in accordance with IEC 60603-2/DIN 41612.

The desire to accommodate more and more components on one PCB has made the double European format (160 x 233.4 mm) very popular. However, with this PCB format, 19" racks become very expensive if only one, two or three PCBs must be accommodated in the control cabinet. The SKBI 128 is mounted reliably on the base with five screws, and its rigid, rugged design safely supports the valuable PCBs, which are held in place by two engagement catches with an ejector which can be operated from the front.

Notes:

Note:

Current and voltage specifications are determined by the plug-in connector used.

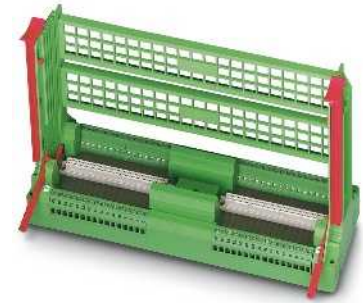

Different types from 64- to 128-pos.

General data	
Stripping length	8 mm
Screw thread	M3
Torque	0.5 Nm ... 0.6 Nm
Connection data solid / stranded / AWG	0.2 ... 4 mm ² / 0.2 ... 2.5 mm ² / 24 - 12



Technical data

8 mm
M3
0.5 Nm ... 0.6 Nm
0.2 ... 4 mm ² / 0.2 ... 2.5 mm ² / 24 - 12

Ordering data

Description

Plug-in card block, for indirect connection in accordance with IEC 60603-2/DIN 41612, complete with guide rails, engagement catches, and ejector, with standardized marking on both connection sides, as well as M4 mounting screws with plug-in connectors

Type	Order No.	Pcs. / Pkt.
SKBI 128-B64/B64	2268028	1
SKBI 128-C32/C32	2270032	1
SKBI 128-C64/C64	2268031	1
SKBI 128-D32/D32	2270058	1
SKBI 128-E48/E48	2269085	1
SKBI 128-F48/F48	2269098	1
SKBI 128-G64/G64	2268112	1

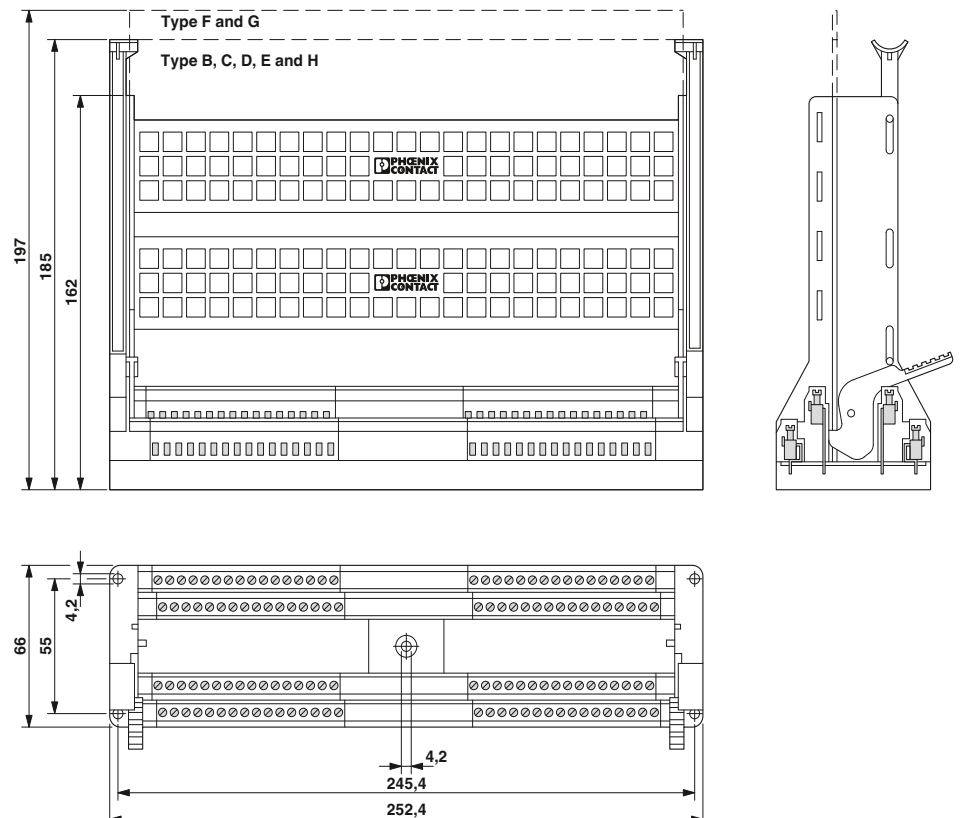

Screw-type socket strips

Socket strip with screw connection SFLY 2,5/D 32

The SFLY 2,5/... Y-shaped socket strip with a screw connection at the rear has been developed for use in 19" racks. It is suitable for use with pin strip types D 32 or F 32 according to IEC 60603-2/DIN 41612.

The socket strips have partially gold-plated contact springs which conform to requirement category 3 in acc. with IEC 60603-2/DIN 41612. The screw connections are designed in accordance with the tension sleeve principle for 2.5 mm² connection cross sections.



32-position, type D



32-pos., type F, equipped in rows z and b

General data

Voltage	250 V
Current	4 A
Stripping length	8 mm
Screw thread	M3
Torque	0.5 Nm ... 0.6 Nm
Connection data solid / stranded / AWG	0.2 ... 4 mm ² / 0.2 ... 2.5 mm ² / 24 - 12
Surge voltage category / insulating material group	- / I
Insulation material	PA
Inflammability class in acc. with UL 94	V2
Temperature indices (RTI/TI)	120/100

Description

Screw-type socket strip, type D, 32-position, fully equipped in rows a + c, with standardized marking on both connection sides, one 2.5 mm² screw connection per position

Screw-type socket strip, type F, with standardized marking on both connection sides, 1 screw connection per position 2.5 mm²
32-position, equipped in rows z + b

Technical data

Technical data

Voltage	250 V
Current	4 A
Stripping length	8 mm
Screw thread	M3
Torque	0.5 Nm ... 0.6 Nm
Connection data solid / stranded / AWG	0.2 ... 4 mm ² / 0.2 ... 2.5 mm ² / 24 - 12
Surge voltage category / insulating material group	- / I
Insulation material	PA
Inflammability class in acc. with UL 94	V2
Temperature indices (RTI/TI)	120/100

Ordering data

Ordering data

Type	Order No.	Pcs. / Pkt.
SFLY 2,5/D32	2285467	10

Type	Order No.	Pcs. / Pkt.
SFLY 2,5/F32/ZB	2285506	10

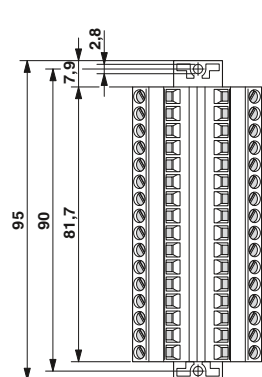
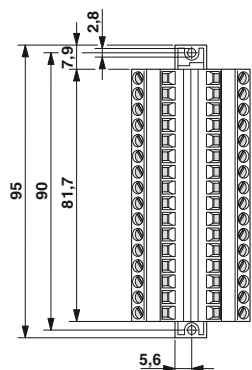
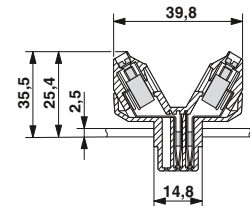
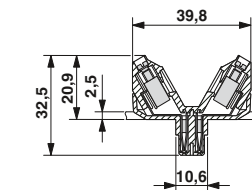

Socket strip with spring-cage connection FRONT-ZFL 1,5/D 32

The FRONT-ZFL 1,5/D32 socket strip with a spring-cage connection at the rear has been specially developed for use in 19" racks. The installation dimensions and the marking of the individual terminal points fulfill the requirements of IEC 60603-2/DIN 41612 for design D32.

The compact spring-cage technology allows solid and stranded conductors up to 1.5 mm² to be connected. With a nominal voltage of 250 V, currents of up to 4 A can be transmitted reliably.

When the FRONT-ZFL 1,5/D32 was being developed, care was taken to ensure clear separation between the conductor connection and the actuation opening, to permit simple and quick conductor connections. The integrated test connection with a 1 mm diameter makes it possible to constantly monitor the connected PCB.

On the plug-in card side, the socket strip has partially gold-plated contact forks that conform to requirement class 2 in acc. with IEC 60603-2/DIN 41612.

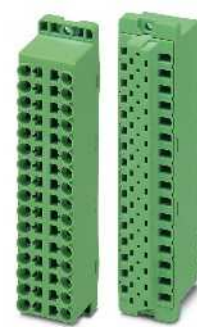

32-position, type D



General data	
Voltage	250 V
Current	4 A
Stripping length	11 mm
Rated surge voltage / pollution degree	4 kV / -
Surge voltage category / insulating material group	- / I
Insulation material	PBT
Inflammability class in acc. with UL 94	V0
Temperature indices (RTI/TI)	140/120
Certification data	
UL	[V] / [A] / AWG 300 / 4 / 24 - 16

Technical data		
Voltage	250 V	
Current	4 A	
Stripping length	11 mm	
Rated surge voltage / pollution degree	4 kV / -	
Surge voltage category / insulating material group	- / I	
Insulation material	PBT	
Inflammability class in acc. with UL 94	V0	
Temperature indices (RTI/TI)	140/120	
Certification data		
UL	[V] / [A] / AWG 300 / 4 / 24 - 16	

Description	
Spring-cage socket strip, type D , 32-position, fully equipped in series	
a + c, one 1.5 mm ² spring-cage connection per position	

Ordering data		
Type	Order No.	Pcs. / Pkt.
FRONT-ZFL 1,5/D32	2201632	10

Test plug, consisting of 1 mm Ø test pin, conductor length 150 mm and socket Ø 2 mm	
Screwdriver	
Blade: 0,6 x 3,5 x 100 mm, length: 181 mm	

Accessories		
Type	Order No.	Pcs. / Pkt.
MPS-MT 1-S	1944372	1
SZF 1-0,6X3,5	1204517	10

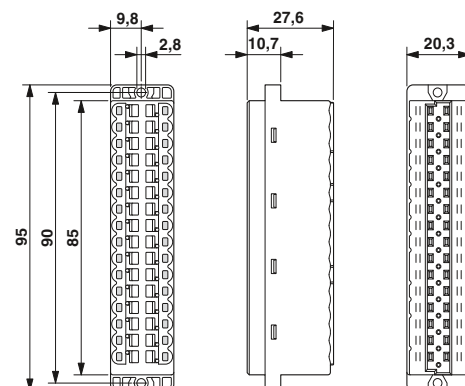

Screw-type socket strips

Screw-type socket strips FRONT-SFL 2,5/...

The FRONT-SFL 2,5 socket strips with a screw connection at the rear are suitable for use in 19" racks. They are available in designs D32 or F32 and F48 in accordance with IEC 60603-2/DIN 41612.

The screw connections, which can be operated from the front, are designed for a connection cross section of 2.5 mm² per position and integrated into the compact housing (3 x pitch per line) in a practical way. The partially gold-plated contact springs conform to requirement category 3 in acc. with IEC 60603-2/DIN 41612.

The asymmetrical design of the socket part ensures optimum use of the space on the printed circuit board and allows the strips to be aligned directly in the rack without gaps.

Each terminal block is marked according to the standard. Individual marking is possible using the self-adhesive strips SK 5.



32-pos., type D, equipped in rows a and c



General data	
Voltage	250 V
Current	4 A
Stripping length	10 mm
Screw thread	M2,5
Torque	0,4 Nm ... 0,5 Nm
Connection data solid / stranded / AWG	0,2 ... 4 mm ² / 0,2 ... 2,5 mm ² / 24 - 12
Insulation material	PA
Inflammability class in acc. with UL 94	V2
Temperature indices (RTI/TI)	120/100
Certification data	
UL	[V] / [A] / AWG 250 / 4 / 30 - 12

Technical data

Voltage	250 V
Current	4 A
Stripping length	10 mm
Screw thread	M2,5
Torque	0,4 Nm ... 0,5 Nm
Connection data solid / stranded / AWG	0,2 ... 4 mm ² / 0,2 ... 2,5 mm ² / 24 - 12
Insulation material	PA
Inflammability class in acc. with UL 94	V2
Temperature indices (RTI/TI)	120/100

Ordering data

Description	Type	Order No.	Pcs. / Pkt.
Screw-type socket strip, type D , 32-position, fully equipped in rows a + c , with standardized marking on both connection sides, one 2.5 mm ² screw connection per position	FRONT-SFL 2,5/D32	2285593	10
Screw-type socket strip, type F , 48-position, fully equipped in rows z, b + d , one 2.5 mm ² screw connection per position			
Screw-type socket strip, type F , 32-position, partially equipped in rows z + b , one 2.5 mm ² screw connection per position			
Screw-type socket strip, type F , 32-position, partially equipped in rows z + d , one 2.5 mm ² screw connection per position			

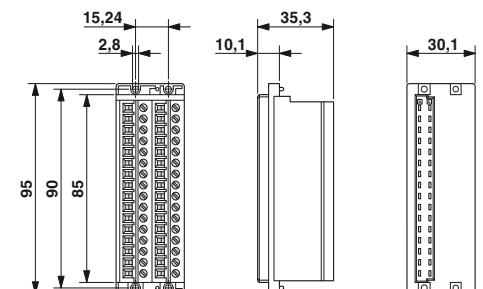



48-pos., type F, equipped in rows z, b, and d



32-pos., type F, equipped in rows z and b



32-pos., type F, equipped in rows z and d



Technical data
250 V
4 A
10 mm
M2,5
0.4 Nm ... 0.5 Nm
0.2 ... 4 mm ² / 0.2 ... 2.5 mm ² / 24 - 12
PA
V2
120/100
250 / 4 / 30 - 12

Technical data
250 V
4 A
10 mm
M2,5
0.4 Nm ... 0.5 Nm
0.2 ... 4 mm ² / 0.2 ... 2.5 mm ² / 24 - 12
PA
V2
120/100
250 / 4 / 30 - 12

Technical data
250 V
4 A
10 mm
M2,5
0.4 Nm ... 0.5 Nm
0.2 ... 4 mm ² / 0.2 ... 2.5 mm ² / 24 - 12
PA
V2
120/100
250 / 4 / 30 - 12

Ordering data		
Type	Order No.	Pcs. / Pkt.
FRONT-SFL 2,5/F48	2285603	10

Ordering data		
Type	Order No.	Pcs. / Pkt.
FRONT-SFL 2,5/F32/ZB	2285577	10

Ordering data		
Type	Order No.	Pcs. / Pkt.
FRONT-SFL 2,5/F32/ZD	2285580	10

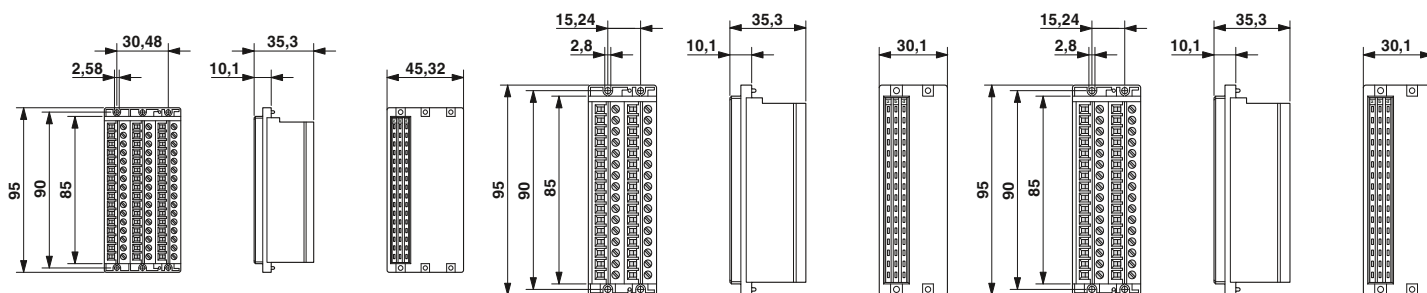

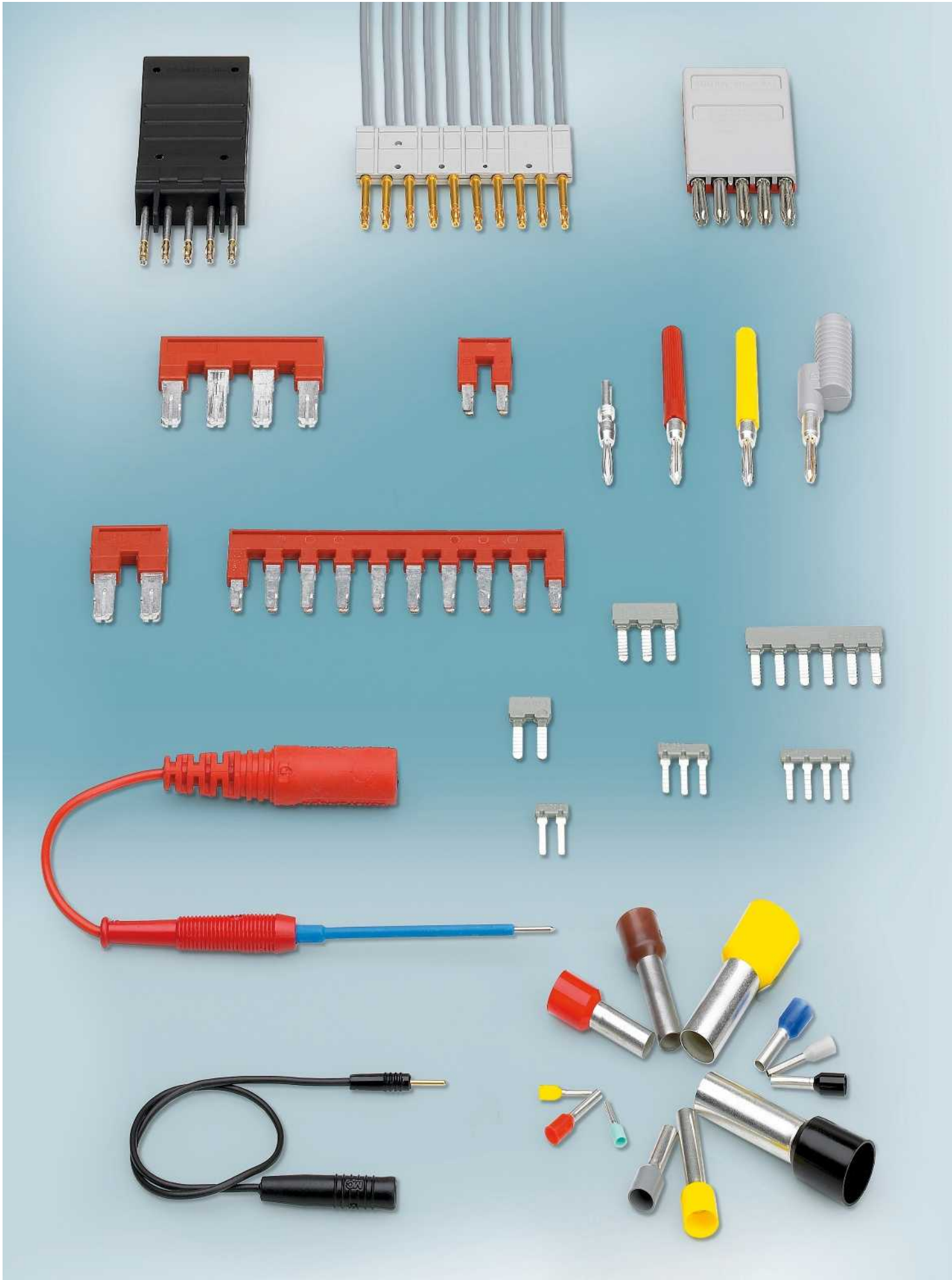

Marking material, tool, test plug

A comprehensive range of accessories is available for COMBICON PCB terminal blocks and plug-in connectors.

Test plug

Single and multi-position test plugs with spring-loaded lamellar contact enable easy and safe contacting of COMBICON plug-in connectors and PCB terminal blocks with a test connection.

Insertion bridges and fixed bridges

Bridges enable potential distribution to several terminal points or complete a circuit for testing purposes.

SK marking strips

10-section marker strips are used for the consecutive numbering of PCB terminal blocks and plug-in connectors. The self-adhesive strips are arranged in several rows on a handy card and are available in all corresponding pitches.

Tools

Press-in stamp sets are available for the correct mounting of press-in pin strips.

Other tools for using PCB terminal blocks and plug-in connectors as well as for crimping ferrules and crimp contacts can be found under the accessories listed on the relevant product pages.

General	794
SK marker cards	796
ZB/ZBF zack marker strips	804
Device marking	808
Conductor and cable marking	818
Printers	820
Press-in devices	826
Crimp inserts	827
Pull-out aids for crimp connectors	828
Insertion bridges	829
Fixed bridges	830
Test plug	832
Ferrules	834
Mounting flanges	836
MSTB coding tab	837
FLRP/ICV pair of guide rails	837
FKC pull-out aid	837
Dimensional drawings	838



Marking solutions for electronics and device production

Phoenix Contact offers marking solutions that are tailored to your requirements for clear component identification and consistent traceability in the production process.

We offer materials and printing systems that are customized to meet the specific challenges encountered when marking:

- PCBs
- Housings
- PCB terminal blocks and plug-in connectors
- Conductors and cables

The complete marking portfolio for electronics and device production.

The data for producing the markings is sent to the relevant printer by the CLIP PROJECT marking software which is supplied as standard. Quick and easy manual data entry or user-friendly transfer from CAE systems, spreadsheet programs, and word processing programs is supported.

If you are unable to find the appropriate markers for your application in the following catalog part, please visit our e-shop or contact us directly.

In order to handle peaks in demand, for example, you can also order materials ready printed from Phoenix Contact. To do this, use the ordering option in CLIP PROJECT or order via the e-shop.



High resistance

High-quality marking materials guarantee high resistance to aggressive media and thereby ensure clear and permanent legibility.

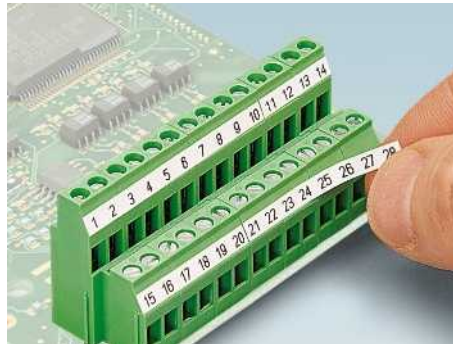

Marking after installation

Unprinted PCB terminal blocks can be marked quickly and clearly even after they have been installed using TML and SK marking strips.

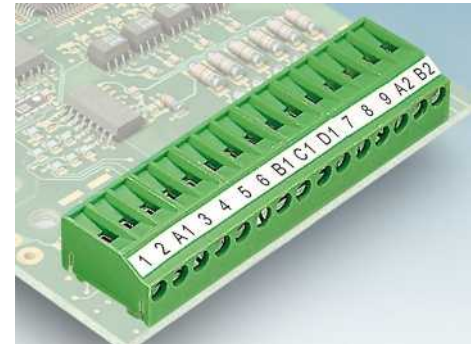

Individual marking

Even very specific marking requirements such as special characters can be met with ease.



Reliable marking

Labels that are resistant to high temperatures ensure reliable marking of components and PCBs during the production process and beyond.



Protection against static discharge

ESD-safe labels can be used to mark components and PCBs that are at risk from electrostatic discharge.



Protection against tampering

As these rating plates clearly show attempts at tampering, they cannot be reused.



Versatile use

With self-laminating labels, both round and flat-ribbon cables can be marked clearly and without abrasion. The portfolio includes various other conductor markings.



Easy and universal

The THERMOMARK printing systems together with the CLIP PROJECT software offer custom marking options for your production process. Excellent printing quality and optimum printing accuracy increase device acceptance among users.

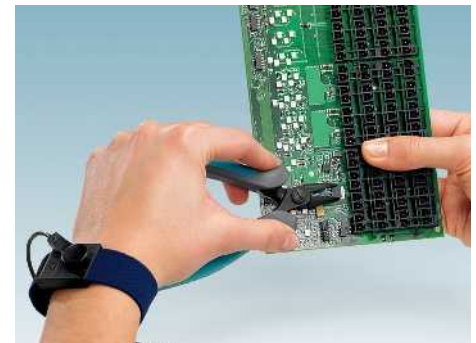

ESD safe

MICROFOX ...ESD pliers are suitable for working on sensitive components, as the electrostatic energy is discharged safely by the special grip material.

SK marker cards

Self-adhesive marker strips for terminal blocks without a marker groove

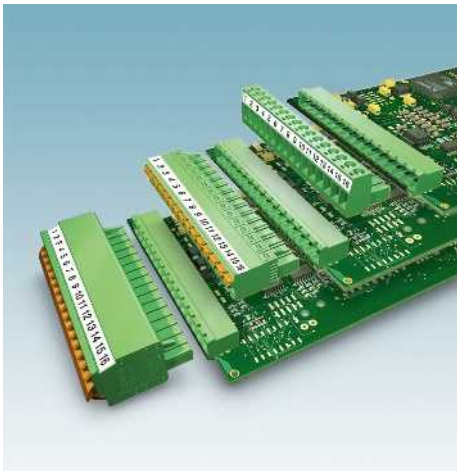

- The SK range of self-adhesive labels can be used to label products that do not feature a marker groove
- The markers that are supplied on rolls can be quickly and cost-effectively labeled using THERMOMARK printers
- The markers that are supplied as cards can be easily labeled using standard laser printers
- Ideal for marking COMBICON plug-in connectors
- Marking service: Phoenix Contact can custom-label SK markers in accordance with your requirements

PRINTED
FOR YOU



Markers labeled with 2.54 mm pitch

General data

Material	
Temperature range	[°C]
Wipe resistance	
Components	

Description

Marker card, printed horizontally, self-adhesive, 10-section marking stripes, 14 identical decades marked with 1-10, 11-20, etc. up to 91-100, adequate for 140 terminal blocks (SK 2,54...-SK 3,81...max. 2 characters per terminal)

white

Marker card, self-adhesive, marked according to customer specifications, 14-section marker strips, max. 25-pos. marking (SK...P2,54 to SK...P3,81 max. 2 characters per pos.)

white

Marker card, unprinted, DIN A4 format, pitch as desired, self-adhesive, with 50 perforated marker strips, strip length of 185 mm

white

Self-adhesive marker strips, unprinted, continuous, material off the roll, for marking with thermal transfer printer, can be separated using cutter, pitch as desired, strip length of up to 1000 mm, 14 strips, strip height of 2.8 mm, 1 roll = 90 m

white

Technical data

Polyester
-40 ... 150
DIN EN 61010-1 (VDE 0411-1)
free from silicone and halogen

Ordering data

Type	Order No.	Pcs. / Pkt.
SK 2,54/2,8:FORTL.ZAHLEN	0804853	10
SK 2,8 REEL P2,54 WH CUS	0825120	1
SK U/2,8 WH:UNBEDRUCKT	0803883	10
SK 2,8 WH:REEL	0805205	1



PRINTED
FOR YOU



Markers labeled with 3.5 mm pitch

PRINTED
FOR YOU

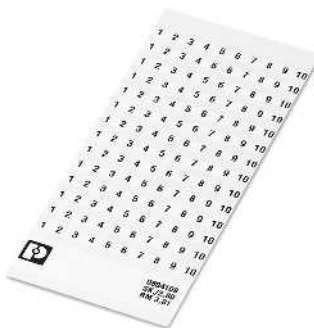

Markers labeled with 3.81 mm pitch

PRINTED
FOR YOU

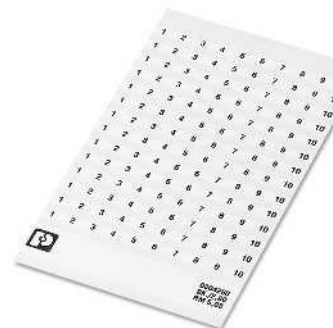

Markers labeled with 5.08 mm pitch

Technical data
Polyester -40 ... 150 DIN EN 61010-1 (VDE 0411-1) free from silicone and halogen

Technical data
Polyester -40 ... 150 DIN EN 61010-1 (VDE 0411-1) free from silicone and halogen

Technical data
Polyester -40 ... 150 DIN EN 61010-1 (VDE 0411-1) free from silicone and halogen

Ordering data		
Type	Order No.	Pcs. / Pkt.
SK 3,5/2,8:FORTL.ZAHLEN	0804073	10
SK 2,8 REEL P3,5 WH CUS	0825121	1
SK U/2,8 WH:UNBEDRUCKT	0803883	10
SK 2,8 WH:REEL	0805205	1

Ordering data		
Type	Order No.	Pcs. / Pkt.
SK 3,81/2,8:FORTL.ZAHLEN	0804109	10
SK 2,8 REEL P3,81 WH CUS	0825122	1
SK U/2,8 WH:UNBEDRUCKT	0803883	10
SK 2,8 WH:REEL	0805205	1

Ordering data		
Type	Order No.	Pcs. / Pkt.
SK 5,08/2,8:FORTL.ZAHLEN	0804280	10
SK 2,8 REEL P5,08 WH CUS	0825123	1
SK U/2,8 WH:UNBEDRUCKT	0803883	10
SK 2,8 WH:REEL	0805205	1

SK marker cards

Self-adhesive marker strips for terminal blocks without a marker groove

- The SK range of self-adhesive labels can be used to label products that do not feature a marker groove
- Marking service: Phoenix Contact can custom-label SK markers in accordance with your requirements

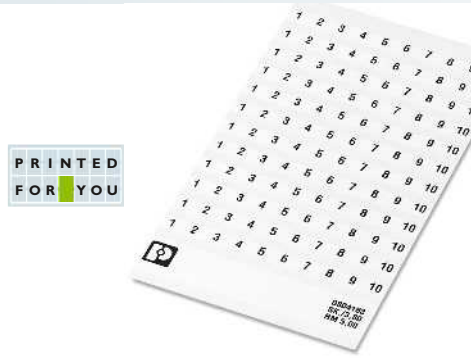

Markers labeled with 5 mm pitch

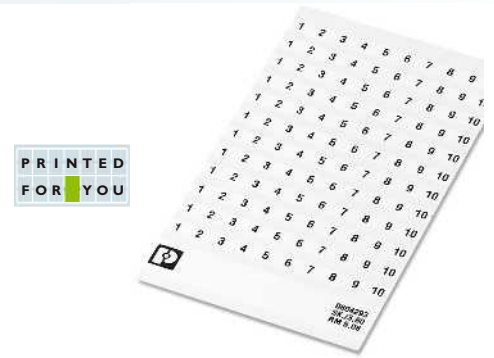

Markers labeled with 5.08 mm pitch

General data		Technical data			Technical data		
Material		Polyester			Polyester		
Temperature range	[°C]	-40 ... 150			-40 ... 150		
Wipe resistance		DIN EN 61010-1 (VDE 0411-1)			DIN EN 61010-1 (VDE 0411-1)		
Components		free from silicone and halogen			free from silicone and halogen		
Description		Ordering data			Ordering data		
	Color	Type	Order No.	Pcs. / Pkt.	Type	Order No.	Pcs. / Pkt.
Marker card, printed horizontally , self-adhesive, 10-section marker strip, 12 identical decades marked, for example, with 1-10, 11-20 etc. up to 91-100, sufficient for 120 terminal blocks							
	white	SK 5/3,8:FORTL.ZAHLEN	0804183	10	SK 5,08/3,8:FORTL.ZAHLEN	0804293	10
Marker card, self-adhesive, marked according to customer specifications , 12-section marker strips, max. 25-pos. marking per strip							
	white	SK 3,8 REEL P5 WH CUS	0825124	1	SK 3,8 REEL P5,08 WH CUS	0825125	1
Marker card, unprinted , DIN A4 format, pitch as desired, self-adhesive, with 40 perforated marker strips, strip length of 185 mm							
	white	SK U/3,8 WH:UNBEDRUCKT	0803906	10	SK U/3,8 WH:UNBEDRUCKT	0803906	10
Self-adhesive marker strips, unprinted, continuous , material off the roll, for marking with thermal transfer printer, can be separated using cutter, pitch as desired, strip length of up to 1000 mm, 12 strips, strip height of 3.8 mm, 1 roll = 90 m							
	white	SK 3,8 WH:REEL	0805218	1	SK 3,8 WH:REEL	0805218	1

SK marker cards

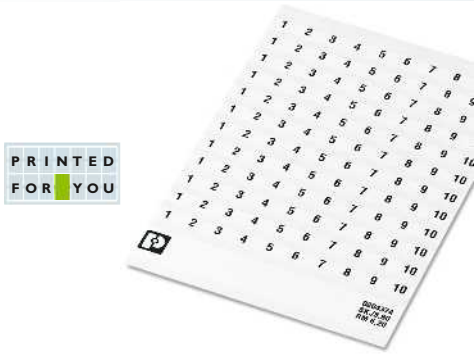

Markers labeled with 6.2 mm pitch

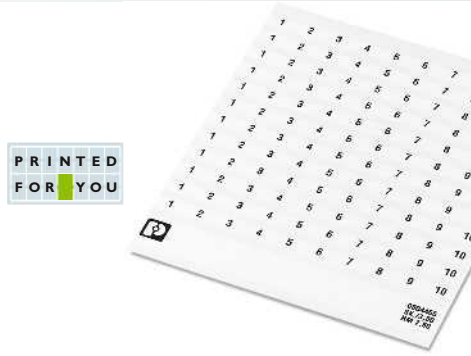

Markers labeled with 7.5 mm pitch

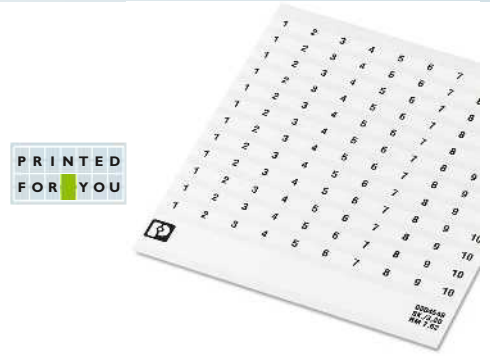

Markers labeled with 7.62 mm pitch

Technical data
Polyester -40 ... 150 DIN EN 61010-1 (VDE 0411-1) free from silicone and halogen

Technical data
Polyester -40 ... 150 DIN EN 61010-1 (VDE 0411-1) free from silicone and halogen

Technical data
Polyester -40 ... 150 DIN EN 61010-1 (VDE 0411-1) free from silicone and halogen

Ordering data		
Type	Order No.	Pcs. / Pkt.
SK 6,2/3,8:FORTL.ZAHLEN	0804374	10
SK 3,8 REEL P6,2 WH CUS	0825126	1
SK U/3,8 WH:UNBEDRUCKT	0803906	10
SK 3,8 WH:REEL	0805218	1

Ordering data		
Type	Order No.	Pcs. / Pkt.
SK 7,5/3,8:FORTL.ZAHLEN	0804455	10
SK 3,8 REEL P7,5 WH CUS	0825127	1
SK U/3,8 WH:UNBEDRUCKT	0803906	10
SK 3,8 WH:REEL	0805218	1

Ordering data		
Type	Order No.	Pcs. / Pkt.
SK 7,62/3,8:FORTL.ZAHLEN	0804549	10
SK 3,8 REEL P7,62 WH CUS	0825128	1
SK U/3,8 WH:UNBEDRUCKT	0803906	10
SK 3,8 WH:REEL	0805218	1

SK marker cards

Self-adhesive marker strips for terminal blocks without a marker groove

- The SK range of self-adhesive labels can be used to label products that do not feature a marker groove
- Marking service: Phoenix Contact can custom-label all TMT markers in accordance with your requirements

PRINTED
FOR YOU



Markers labeled with 7.5 mm pitch

PRINTED
FOR YOU



Markers labeled with 7.62 mm pitch

General data		Technical data			Technical data		
Material		Polyester			Polyester		
Temperature range	[°C]	-40 ... 150			-40 ... 150		
Wipe resistance		DIN EN 61010-1 (VDE 0411-1)			DIN EN 61010-1 (VDE 0411-1)		
Components		free from silicone and halogen			free from silicone and halogen		
Description		Ordering data			Ordering data		
	Color	Type	Order No.	Pcs. / Pkt.	Type	Order No.	Pcs. / Pkt.
Marker card, printed horizontally , self-adhesive, 10-section marker strip, 10 identical decades marked 1-10, 11-20 etc. up to 91-100, for example, sufficient for 100 terminal blocks							
	white	SK 7,5/5:FORTL.ZAHLEN	0804468	10	SK 7,62/5:FORTL.ZAHLEN	0804552	10
Marker card, self-adhesive, marked according to customer specifications , 10-section marker strips, max. 25-pos. marking per strip							
	white	SK 5,0 REEL P7,5 WH CUS	0825131	1	SK 5,0 REEL P7,62 WH CUS	0825132	1
Marker card, unprinted , DIN A4 format, pitch as desired, self-adhesive, with 35 perforated marker strips, strip length of 185 mm							
	white	SK U/5,0 WH:UNBEDRUCKT	0803922	10	SK U/5,0 WH:UNBEDRUCKT	0803922	10
Self-adhesive marker strips, unprinted, continuous , material off the roll, for marking with thermal transfer printer, can be separated using cutter, pitch as desired, strip length of up to 1000 mm, 10 strips, strip height of 5.0 mm, 1 roll = 90 m							
	white	SK 5,0 WH:REEL	0805221	1	SK 5,0 WH:REEL	0805221	1

Self-adhesive marker strips for terminal blocks without a marker groove



Markers with a strip length of up to 1000 mm



Markers with a strip length of up to 185 mm

General data		Technical data			Technical data		
Can be printed with:		THERMOMARK ROLL • THERMOMARK ROLL X1 • THERMOMARK X1.1 • THERMOMARK X1.2 • THERMOMARK S1.1			CMS-P1-PLOTTER • Office printing systems		
Material		Polyester			Polyester		
Temperature range		-40 ... 150			-40 ... 150		
Wipe resistance		DIN EN 61010-1 (VDE 0411-1)			DIN EN 61010-1 (VDE 0411-1)		
Components		free from silicone and halogen			free from silicone and halogen		
Description		Ordering data			Ordering data		
Color		Type	Order No.	Pcs. / Pkt.	Type	Order No.	Pcs. / Pkt.
<p>Self-adhesive marker strips, unprinted, continuous, material off the roll, for marking with thermal transfer printer, can be separated using cutter, pitch as desired, strip length of up to 1000 mm, 14 strips, strip height of 2.8 mm, 1 roll = 90 m</p> <p>white</p>		SK 2,8 WH:REEL	0805205	1			
<p>Self-adhesive marker strips, unprinted, continuous, material off the roll, for marking with thermal transfer printer, can be separated using cutter, pitch as desired, strip length of up to 1000 mm, 12 strips, strip height of 3.8 mm, 1 roll = 90 m</p> <p>white</p>		SK 3,8 WH:REEL	0805218	1			
<p>Self-adhesive marker strips, unprinted, continuous, material off the roll, for marking with thermal transfer printer, can be separated using cutter, pitch as desired, strip length of up to 1000 mm, 10 strips, strip height of 5.0 mm, 1 roll = 90 m</p> <p>white</p>		SK 5,0 WH:REEL	0805221	1			
<p>Self-adhesive marker strips, unprinted, continuous, material off the roll, for marking with thermal transfer printer, can be separated using cutter, pitch as desired, strip length of up to 1000 mm, 7 strips, strip height of 10 mm, 1 roll = 90 m</p> <p>white</p>		SK 10,0 WH:REEL	0812188	1			
<p>Marker card, unprinted, DIN A4 format, pitch as desired, self-adhesive, with 50 perforated marker strips, strip length of 185 mm</p> <p>white</p>					SK U/2,8 WH:UNBEDRUCKT	0803883	10
<p>Marker card, unprinted, DIN A4 format, pitch as desired, self-adhesive, with 40 perforated marker strips, strip length of 185 mm</p> <p>white</p>					SK U/3,8 WH:UNBEDRUCKT	0803906	10
<p>Marker card, unprinted, DIN A4 format, pitch as desired, self-adhesive, with 35 perforated marker strips, strip length of 185 mm</p> <p>white</p>					SK U/5,0 WH:UNBEDRUCKT	0803922	10

SK marker cards

Self-adhesive marker strips for terminal blocks without a marker groove



Thermal transfer for rolls



Unlabeled

– The TML marking range offers self-adhesive marker strips for marking products that do not have a marker groove

General data

Can be printed with:

Number of individual labels per strip

Material

Temperature range

Wipe resistance

Components

[°C]

Technical data

THERMOMARK ROLL • THERMOMARK ROLL X1 • THERMOMARK X1.1 • THERMOMARK X1.2 • THERMOMARK S1.1

1

Polyester

-40 ... 150

DIN EN 61010-1 (VDE 0411-1)

free from silicone and halogen

Ordering data

Description	Color	Type	Order No.	Pcs. / Pkt.
Self-adhesive marker strips, unprinted				
1 roll = 2500 strips, lettering field size: 104 x 2.8 mm	white	TML (104X2,8)R	0801832	1
1 roll = 2500 strips, lettering field size: 104 x 3.8 mm	white	TML (104X3,8)R	0801833	1
1 roll = 2500 strips, lettering field size: 104 x 5 mm	white	TML (104X5)R	0801834	1
1 roll = 1500 strips, lettering field size: 104 x 10 mm	white	TML (104X10)R	0801835	1

N

Self-adhesive marker strips for terminal blocks without marker groove, continuous

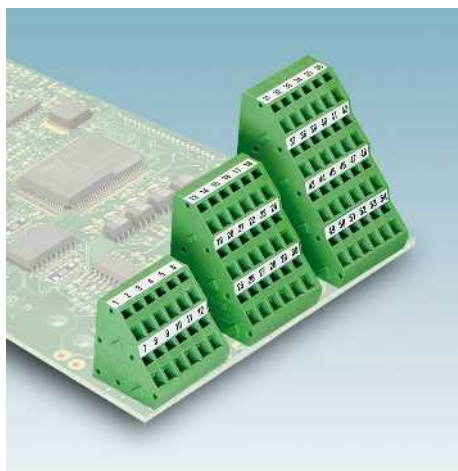

Thermal transfer for rolls



Unlabeled

- The TML marking range offers self-adhesive marker strips for marking products that do not have a marker groove
- The marker strips are automatically perforated or cut to the required length during the printing process

General data	
Can be printed with:	
Number of individual labels per strip	
Material	
Temperature range	[°C]
Wipe resistance	
Components	

Technical data	
THERMOMARK ROLL • THERMOMARK ROLL X1 • THERMOMARK X1.1 • THERMOMARK X1.2 • THERMOMARK S1.1	
14	
Polyester	
-40 ... 150	
DIN EN 61010-1 (VDE 0411-1)	
free from silicone and halogen	

Description	Color
Self-adhesive marker strips, unprinted, continuous	
1 roll = 30 m continuous, strip height: 2.8 mm	white
1 roll = 30 m continuous, strip height: 3.8 mm	white
1 roll = 30 m continuous, strip height: 5 mm	white
1 roll = 30 m continuous, strip height: 7 mm	white
1 roll = 30 m continuous, strip height: 10 mm	white

Ordering data		
Type	Order No.	Pcs. / Pkt.
TML (EX2,8)R	0801836	1
TML (EX3,8)R	0801837	1
TML (EX5)R	0801838	1
TML (EX7)R	0830837	1
TML (EX10)R	0801839	1

ZB/ZBF Zack marker strip

Zack marker strip terminal marking for a vertical marker groove

- The ZB zack marker strip system is a marking solution for modular terminal blocks and electronic modules with vertical marker grooves
- Marking service: Phoenix Contact can custom-label all zack marker strip markers in accordance with your requirements



Plotter

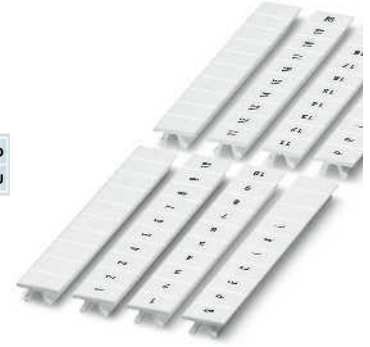

Markers for a terminal block width of 7.5 mm

Notes:
 1) 10 identically marked strips make up one packing unit (PU).

General data	
Can be printed with:	
Material	
Inflammability class according to UL 94	
Temperature range	[°C]
Wipe resistance	
Components	

Technical data	
Can be printed with:	CMS-P1-PLOTTER
Material	PA
Inflammability class according to UL 94	V2
Temperature range	-40 ... 100
Wipe resistance	DIN EN 61010-1 (VDE 0411-1)
Components	free from silicone and halogen

Description	Color
Zack marker strip, 10-section, unprinted: pack contains enough to label 100 terminal blocks	
as above, however, large batch, sufficient for 1000 terminal blocks	white white
Zack marker strip, printed horizontally, 10-section, with consecutive numbers, e.g. 1-10, 11-20, etc. up to 91-100¹⁾	white
Zack marker strip, printed horizontally, 10-section, with same numbers, e.g. 1/1/1, 2/2/2, etc. up to 100/100/100¹⁾	white
Zack marker strip, 10-section, printed horizontally: with L1, L2, L3, N, PE ¹⁾	white white
Zack marker strip, printed vertically, 10-section, with consecutive numbers, e.g. 1-10, 11-20, etc. up to 91-100¹⁾	white
Zack marker strip, special printing, 10-section, divisible, marking according to customer requirements, please specify the desired marking with order	white

Ordering data		
Type	Order No.	Pcs. / Pkt.
ZB 7,5:UNBEDRUCKT	0803948	10
ZB 7,5 CUS	0824994	1

Marker pen, refillable, for manual marking, 0.35 mm line thickness, can be refilled with CMS-INK-TR-C 5, delivered without ink
Magazine, for CMS-P1-PLOTTER

Accessories		
Type	Order No.	Pcs. / Pkt.
X-PEN 0,35	0811228	1
CMS-P1-M/ZB	5144699	1

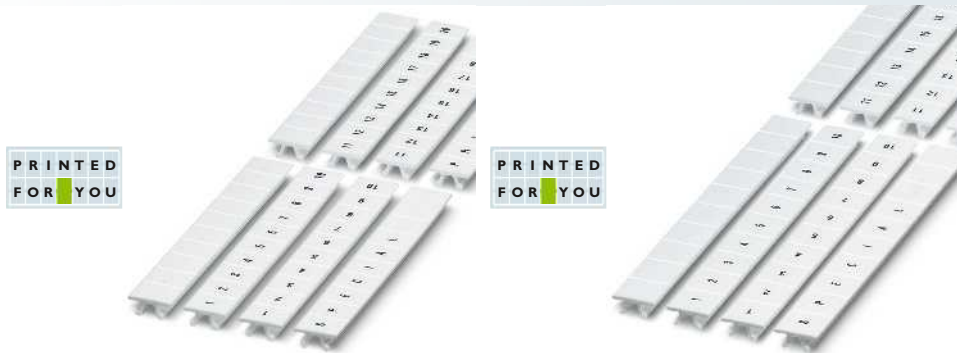

Markers for a terminal block width of 7.62 mm

Markers for a terminal block width of 10.2 mm

Technical data
CMS-P1-PLOTTER PA V2 -40 ... 100 DIN EN 61010-1 (VDE 0411-1) free from silicone and halogen

Technical data
CMS-P1-PLOTTER PA V2 -40 ... 100 DIN EN 61010-1 (VDE 0411-1) free from silicone and halogen

Ordering data		
Type	Order No.	Pcs. / Pkt.
ZB 7,62:UNBEDRUCKT	1054000	10
ZB 7,62/WH-100:UNBEDRUCKT	5060922	100
ZB 7,62,LGS:FORTL.ZAHLEN	1054233	10
ZB 7,62 CUS	0824997	1

Ordering data		
Type	Order No.	Pcs. / Pkt.
ZB 10:UNBEDRUCKT	1053001	10
ZB10/WH-100:UNBEDRUCKT	5060883	100
ZB10,LGS:FORTL.ZAHLEN	1053014	10
ZB10,LGS:GLEICHE ZAHLEN	1053030	10
ZB10,LGS:L1-N,PE	1053412	10
ZB10,LGS:U-N	1053438	10
ZB10,QR:FORTL.ZAHLEN	1053027	10
ZB 10 CUS	0824941	1

Accessories		
Type	Order No.	Pcs. / Pkt.
X-PEN 0,35	0811228	1
CMS-P1-M/ZB	5144699	1

Accessories		
Type	Order No.	Pcs. / Pkt.
X-PEN 0,35	0811228	1
CMS-P1-M/ZB	5144699	1

ZB/ZBF Zack marker strip

Terminal block and module marking with flat Zack marker strip



Plotter

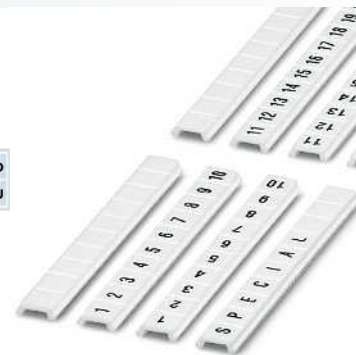

Markers for a terminal block width of 5.2 mm

The ZBF flat Zack marker strip is designed for marking terminal blocks, equipment and smaller modules with Phoenix Contact marker grooves.

The flat Zack marker strip is available in all common pitches as labeled or unlabeled versions.

Further pitches and markings are possible on request.

Notes:
 1) 10 identically marked strips make up one packing unit (PU).

General data	
Can be printed with:	
Material	
Inflammability class according to UL 94	
Temperature range	[°C]
Wipe resistance	
Components	

Technical data	
CMS-P1-PLOTTER	
PA	
V2	
-40 ... 100	
DIN EN 61010-1 (VDE 0411-1)	
free from silicone and halogen	

Description	Color
Zack flat marker strip, 10-section, unprinted: for individual marking with TML (101X4,2)R TR, X-PEN or CMS-P1- PLOTTER, sufficient for marking 100 terminal blocks per pack	white white
Flat Zack marker strip, 10-section, printed horizontally: with consecutive numbers, e.g. 1-10, 11-20, etc. up to 91-100 ¹⁾	white
Zack marker strip, flat, printed horizontally, 10-section, with even numbers, e.g. 2-20, 22-40, etc. up to 82-100 ¹⁾	white
Zack marker strip, flat, printed horizontally, 10-section, with odd numbers, e.g. 1-19, 21-39, etc. up to 81-99 ¹⁾	white
Zack marker strip, flat, printed vertically, 10-section, with consecutive numbers, e.g. 1-10, 11-20, etc. up to 91-100 ¹⁾	white
Zack marker strip, flat, special printing, 10-section, divisible, marking according to customer requirements, please specify the desired marking with order	white
Marker pen, refillable, for manual marking, 0.35 mm line thickness, can be refilled with CMS-INK-TR-C 5, delivered without ink	
Magazine, for CMS-P1-PLOTTER	

Ordering data		
Type	Order No.	Pcs. / Pkt.
ZBF 5:UNBEDRUCKT	0808642	10
ZBF 5/WH-100:UNBEDRUCKT	0808668	100
ZBF 5,LGS:FORTL.ZAHLEN	0808671	10
ZBF 5,LGS:GERADE ZAHLEN	0810821	10
ZBF 5,LGS:UNGERADE ZAHLEN	0810863	10
ZBF 5,QR:FORTL.ZAHLEN	0808697	10
ZBF 5 CUS	0825025	1
Accessories		
X-PEN 0,35	0811228	1
CMS-P1-M/ZBF	5144709	1

ZB/ZBF Zack marker strip

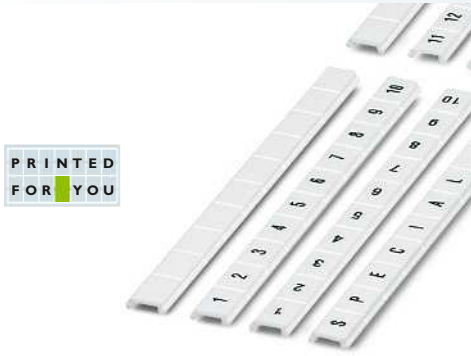

Markers for a terminal block width of 7.5 mm

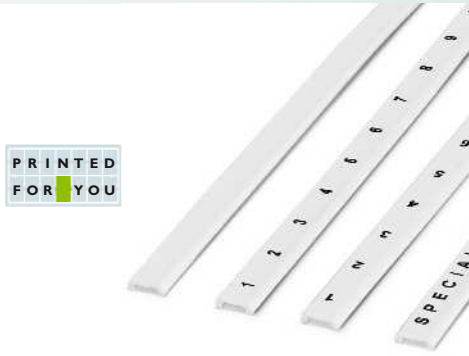

Markers for a terminal block width of 10.2 mm

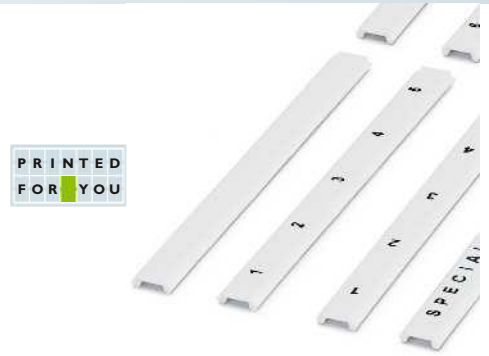

Markers for a terminal block width of 15 mm

Technical data
CMS-P1-PLOTTER PA V2 -40 ... 100 DIN EN 61010-1 (VDE 0411-1) free from silicone and halogen

Technical data
CMS-P1-PLOTTER PA V2 -40 ... 100 DIN EN 61010-1 (VDE 0411-1) free from silicone and halogen

Technical data
CMS-P1-PLOTTER PA V2 -40 ... 100 DIN EN 61010-1 (VDE 0411-1) free from silicone and halogen

Ordering data		
Type	Order No.	Pcs. / Pkt.
ZBF 7,5:UNBEDRUCKT	0809942	10
ZBF 7,5,LGS:FORTL.ZAHLEN	0809955	10
ZBF 7,5,QR:FORTL.ZAHLEN	0809968	10
ZBF 7,5 CUS	0825028	1

Ordering data		
Type	Order No.	Pcs. / Pkt.
ZBF10:UNBEDRUCKT	0809997	10
ZBF10,LGS:FORTL.ZAHLEN	0810009	10
ZBF10,QR:FORTL.ZAHLEN	0810025	10
ZBF10 CUS	0825031	1

Ordering data		
Type	Order No.	Pcs. / Pkt.
ZBF 15:UNBEDRUCKT	0811202	10
ZBF 15 CUS	0825019	1

Accessories		
Type	Order No.	Pcs. / Pkt.
X-PEN 0,35	0811228	1
CMS-P1-M/ZBF	5144709	1

Accessories		
Type	Order No.	Pcs. / Pkt.
X-PEN 0,35	0811228	1
CMS-P1-M/ZBF	5144709	1

Accessories		
Type	Order No.	Pcs. / Pkt.
X-PEN 0,35	0811228	1
CMS-P1-M/ZBF	5144709	1

Device marking

Stick-on device marking



- EML ... self-adhesive device markers have been specially developed to allow the marking of various types of operating equipment in control, system, and control cabinet engineering applications
- Precise printing quality and good adhesive properties
- If high-quality ink ribbons are used, the marking is resistant to solvents, making it suitable for use even under harsh industrial conditions
- A wide range of marker sizes and colors are available for custom designs
- The special packaging protects rolls that have already been started from the dirt found in industrial environments
- The EML ... materials are UL-listed
- **Designation example:**
EML (10X4)R...
Lettering field size: 10 x 4 mm
Type of packaging: roll

Notes:
The THERMOMARK ROLL-ERH external media hub is required for RL rolls, see under "Printers" on page 820.
For additional label sizes, see the product area on our website at www.phoenixcontact.net/products

Can be printed with:



Thermal transfer for rolls



Unlabeled, white



General data	
Can be printed with:	
Material	
Temperature range	[°C]
Wipe resistance	
Components	

Technical data	
THERMOMARK ROLL • THERMOMARK ROLL X1 • THERMOMARK X1.1 • THERMOMARK X1.2 • THERMOMARK S1.1	
Polyester	
-40 ... 150	
DIN EN 61010-1 (VDE 0411-1)	
free from silicone and halogen	

Description	Color
Labels	
10,000 labels per roll	
10,000 labels per roll	
2500 labels per roll	
2500 labels per roll	
2500 labels per roll	
10,000 labels per roll	
2500 labels per roll	
2500 labels per roll	
2500 labels per roll	
2500 labels per roll	
2500 labels per roll	
2500 labels per roll	
2500 labels per roll	
2500 labels per roll	
2500 labels per roll	
2500 labels per roll	
2500 labels per roll	
2500 labels per roll	
1000 labels per roll	
2500 labels per roll	
2500 labels per roll	
1000 labels per roll	
1000 labels per roll	
1000 labels per roll	
1000 labels per roll	
400 labels per roll	
2500 labels per roll	
300 labels per roll	
300 labels per roll	
250 labels per roll	
Labels, on large roll	
10,000 labels per roll	
10,000 labels per roll	
10,000 labels per roll	
10,000 labels per roll	
3000 labels per roll	
3000 labels per roll	
2500 labels per roll	
1000 labels per roll	
Labels, round, 17.5 mm diameter	
2500 labels per roll	white
Continuous labels, on large roll	
Width: 37 mm, length: 90 m	transparent
Continuous labels, on large roll, length: 90 m	
Width: 100 mm, length: 90 m	

Ordering data		
Type	Order No.	Pcs. / Pkt.
EML (10X4)R	0815583	1
EML (10X7)R	0816663	1
EML (15X9)R	0815677	1
EML (16,5X5)R	0816702	1
EML (16X7)R	0818001	1
EML (17,5X8)R	0816744	1
EML (19X6)R	0816760	1
EML (20X8)R	0816786	1
EML (25,4X12,7)R	0816825	1
EML (30X20)R	0816922	1
EML (38X17)R	0816951	1
EML (40X8)R	0816980	1
EML (40X25)R	0818027	1
EML (51X25)R	0817028	1
EML (70X32)R	0817060	1
EML (70X50)R	0817099	1
EML (90X5)R	0817109	1
EML (100X40)R	0800286	1
EML (100X73)R	0817125	1
EML (100X90)R	0817154	1
EML (16,5X5)RL	0816113	1
EML (25,4X12,7)RL	0816087	1
EML (38,1X19)RL	0816171	1
EML (50,8X25,4)RL	0816184	1
EML (69,8X31,8)RL	0816197	1
EML (D17,5)R	0815774	1
EML (37XE)RL TR	0815716	1



Unlabeled, yellow



Unlabeled, silver



Technical data
THERMOMARK ROLL • THERMOMARK ROLL X1 • THERMOMARK X1.1 • THERMOMARK X1.2 • THERMOMARK S1.1
Polyester
-40 ... 150
DIN EN 61010-1 (VDE 0411-1)
free from silicone and halogen

Technical data
THERMOMARK ROLL • THERMOMARK ROLL X1 • THERMOMARK X1.1 • THERMOMARK X1.2 • THERMOMARK S1.1
Polyester
-40 ... 150
DIN EN 61010-1 (VDE 0411-1)
free from silicone and halogen

Ordering data

Ordering data

Type	Order No.	Pcs. / Pkt.
EML (10X7)R YE	0816676	1
EML (15X6) R YE	0819288	1
EML (15X9)R YE	0816045	1
EML (16,5X5)R YE	0816728	1
EML (16X7)R YE	0816731	1
EML (17,5X8)R YE	0816757	1
EML (20X7)R YE	0816773	1
EML (20X8)R YE	0816799	1
EML (25,4X12,7)R YE	0816838	1
EML (26,5X17,5)R YE	0816896	1
EML (30X20)R YE	0816935	1
EML (40X25)R YE	0816977	1
EML (51X25)R YE	0817031	1
EML (70X32)R YE	0817073	1
EML (100X73)R YE	0817138	1
EML (16,5X5)RL YE	0816126	1
EML (17,5X8)RL YE	0816139	1
EML (18X7)RL YE	0802733	1
EML (76,2X6,5)RL YE	0816207	1
EML (100XE)RL SR	0815787	1

Type	Order No.	Pcs. / Pkt.
EML (15X9)R SR	0816032	1
EML (21,5X21,5)R SR	0816812	1
EML (26,5X7,5)R SR	0816841	1
EML (26,5X12)R SR	0816854	1
EML (26,5X17,5)R SR	0816883	1
EML (26,5X18,5)R SR	0816906	1
EML (26,5X26,5)R SR	0816919	1
EML (40X15)R SR	0815729	1
EML (51X25)R SR	0817002	1
EML (70X32)R SR	0817057	1
EML (70X50)R SR	0817086	1
EML (100X40)R SR	0802697	1
EML (100X73)R SR	0817112	1
EML (100X90)R SR	0817141	1
EML (101,6X25,4)RL SR	0815790	1

Device marking

Stick-on device marking, for high-temperature applications



- White polyimide labels with high level of temperature resistance
- Continuous temperature range of -40°C to +180°C, up to +300°C temporarily, for up to 60 seconds
- For marking PCBs, can be used in all industrial soldering processes
- High weathering and chemical resistance
- The marking material is UL listed
- Protection against tampering: the labels cannot be removed without disintegrating
- **Designation example:**
EML-HT (8x8)R
Lettering field size: 8 x 8 mm
Type of packaging: roll
- Single-web large roll with 8000 or 10,000 labels (see figure below)

Notes:
The THERMOMARK-RIBBON 110-EML-HT ink ribbon is required for marking EM-LHT... high-temperature labels, see under "Printers", page 821
If large rolls are processed with the THERMOMARK ROLL, the external THERMOMARK ROLL-ERH media hub must be used.



Can be printed with:



Thermal transfer for rolls



Unlabeled

General data	
Can be printed with:	
Material	
Temperature range	[°C]
Wipe resistance	
Components	

Technical data	
THERMOMARK ROLL • THERMOMARK ROLL X1 • THERMOMARK X1.1 • THERMOMARK X1.2 • THERMOMARK S1.1	
Polyimide	
-40 ... 180	
DIN EN 61010-1 (VDE 0411-1)	
free from silicone and halogen	

Ordering data	
Description	Color
High-temperature labels	
4000 labels per roll	white
4000 labels per roll	white
4000 labels per roll	white
4000 labels per roll	white
4000 labels per roll	white
2500 labels per roll	white
2500 labels per roll	white
1000 labels per roll	white
2500 labels per roll	white
1000 labels per roll, round, 12 mm diameter	white

Ordering data		
Type	Order No.	Pcs. / Pkt.
EML-HT (8X8)R	0800340	1
EML-HT (15X6)R	0830644	1
EML-HT (15X15)R	0800341	1
EML-HT (20X7)R	0830645	1
EML-HT (24X4)R	0830646	1
EML-HT (25X8)R	0830647	1
EML-HT (25,4X12,7)R	0830648	1
EML-HT (32X10)R	0830649	1
EML-HT (35X6,5)R	0830650	1
EML-HT (40X15)R	0800339	1
EML-HT (45X5)R	0800337	1
EML-HT (50X10)R	0800338	1
EML-HT (D12)R	0801376	1

High-temperature labels, on large roll	
10,000 labels per roll	white
10,000 labels per roll	white
8000 labels per roll	white
10,000 labels per roll	white
10,000 labels per roll	white
10,000 labels per roll	white
10,000 labels per roll	white
10,000 labels per roll	white
10,000 labels per roll	white
10,000 labels per roll	white
8000 labels per roll	white
10,000 labels per roll	white
10,000 labels per roll	white

High-temperature label, labeled acc. to customer specifications	
4 labels per strip	white
5 labels per strip	white
4 labels per strip	white
4 labels per strip	white
2 labels per strip	white
2 labels per strip	white
3 labels per strip	white
2 labels per strip	white
2 labels per strip	white
2 labels per strip	white
2 labels per strip	white
4 labels per strip	white
1 label per strip	white

Ink ribbon, specifically for high-temperature labels, EML-HT...	black
--	-------

Accessories		
THERMOMARK-RIBBON 110-EML-HT	0800342	1



Unlabeled, on large roll



Labeled according to customer specifications

Technical data

THERMOMARK ROLL • THERMOMARK ROLL X1 • THERMOMARK X1.1 • THERMOMARK X1.2 • THERMOMARK S1.1
 Polyimide
 -40 ... 180
 DIN EN 61010-1 (VDE 0411-1)
 free from silicone and halogen

Technical data

-
 Polyimide
 -40 ... 180
 DIN EN 61010-1 (VDE 0411-1)
 free from silicone and halogen

Ordering data

Type	Order No.	Pcs. / Pkt.
EML-HT (8X8)RL-T	0830651	1
EML-HT (15X6)RL-T	0830652	1
EML-HT (15X15)RL-T	0830653	1
EML-HT (20X7)RL-T	0830654	1
EML-HT (24X4)RL-T	0830655	1
EML-HT (25X8)RL-T	0830656	1
EML-HT (25,4X12,7)RL-T	0830657	1
EML-HT (32X10)RL-T	0830658	1
EML-HT (35X6,5)RL-T	0830659	1
EML-HT (40X15)RL-T	0830660	1
EML-HT (45X5)RL-T	0830661	1
EML-HT (50X10)RL-T	0830662	1

Ordering data

Type	Order No.	Pcs. / Pkt.
EML-HT (8X8)R CUS	0830169	1
EML-HT (15X6)R CUS	0830663	1
EML-HT (15X15)R CUS	0830170	1
EML-HT (20X7)R CUS	0830664	1
EML-HT (24X4)R CUS	0830665	1
EML-HT (25X8)R CUS	0830666	1
EML-HT (25,4X12,7)R CUS	0830667	1
EML-HT (32X10)R CUS	0830668	1
EML-HT (35X6,5)R CUS	0830669	1
EML-HT (40X15)R CUS	0830168	1
EML-HT (45X5)R CUS	0830166	1
EML-HT (50X10)R CUS	0830167	1

Accessories

THERMOMARK-RIBBON 110-EML-HT	0800342	1
------------------------------	---------	---

Accessories

--	--	--

Device marking

Stick-on device marking, for ESD applications



Can be printed with:



Thermal transfer for rolls



Unlabeled

N

- Safe marking for sensitive components on PCBs
- Static dissipative adhesive: prevents transmission of voltage and protects the component against electrostatic discharge
- Marking service: Phoenix Contact can custom-mark all EML-ESD ... markers according to your requirements
- **Designation example:**
EML-ESD (8x8)R
Lettering field size: 8 x 8 mm
Type of packaging: roll

Notes:
If large rolls are processed with the THERMOMARK ROLL, the external THERMOMARK ROLL-ERH media hub must be used.

General data	
Can be printed with:	
Material	
Temperature range	[°C]
Wipe resistance	
Components	

Technical data	
THERMOMARK ROLL • THERMOMARK ROLL X1 • THERMOMARK S1.1 • THERMOMARK X1.1 • THERMOMARK X1.2	
Polyester	
-40 ... 150	
DIN EN 61010-1 (VDE 0411-1)	
free from silicone and halogen	

Description	Color
Device marking, roll	
4000 labels per roll	white
4000 labels per roll	white
4000 labels per roll	white
4000 labels per roll	white
4000 labels per roll	white
4000 labels per roll	white
2500 labels per roll	white
2500 labels per roll	white
2500 labels per roll	white
2500 labels per roll	white
2500 labels per roll	white
2500 labels per roll	white
2500 labels per roll	white
1000 labels per roll	white
Device marking, roll	
10,000 labels per roll	white
10,000 labels per roll	white
8,000 labels per roll	white
10,000 labels per roll	white
10,000 labels per roll	white
10,000 labels per roll	white
10,000 labels per roll	white
10,000 labels per roll	white
10,000 labels per roll	white
10,000 labels per roll	white
8,000 labels per roll	white
10,000 labels per roll	white
10,000 labels per roll	white
Device marking, roll, marked according to customer specifications	
4 labels per strip	white
5 labels per strip	white
4 labels per strip	white
4 labels per strip	white
2 labels per strip	white
2 labels per strip	white
3 labels per strip	white
2 labels per strip	white
2 labels per strip	white
2 labels per strip	white
2 labels per strip	white
2 labels per strip	white
1 label per strip	white

Ordering data		
Type	Order No.	Pcs. / Pkt.
EML-ESD (8X8)R	0830564	1
EML-ESD (15X6)R	0830565	1
EML-ESD (15X15)R	0830566	1
EML-ESD (20X7)R	0830567	1
EML-ESD (24X4)R	0830568	1
EML-ESD (25X8)R	0830569	1
EML-ESD (25,4X12,7)R	0830570	1
EML-ESD (32X10)R	0830571	1
EML-ESD (35X6,5)R	0830572	1
EML-ESD (40X15)R	0830573	1
EML-ESD (45X5)R	0830574	1
EML-ESD (50X10)R	0830575	1



Unlabeled, on large roll

N



Labeled according to customer specifications

N

Technical data

THERMOMARK ROLL • THERMOMARK ROLL X1 • THERMOMARK S1.1 • THERMOMARK X1.1 • THERMOMARK X1.2
 Polyester
 -40 ... 150
 DIN EN 61010-1 (VDE 0411-1)
 free from silicone and halogen

Technical data

-
 Polyester
 -40 ... 150
 DIN EN 61010-1 (VDE 0411-1)
 free from silicone and halogen

Ordering data

Type	Order No.	Pcs. / Pkt.
EML-ESD (8X8)RL-T	0830576	1
EML-ESD (15X6)RL-T	0830577	1
EML-ESD (15X15)RL-T	0830578	1
EML-ESD (20X7)RL-T	0830579	1
EML-ESD (24X4)RL-T	0830580	1
EML-ESD (25X8)RL-T	0830581	1
EML-ESD (25,4X12,7)RL-T	0830582	1
EML-ESD (32X10)RL-T	0830583	1
EML-ESD (35X6,5)RL-T	0830584	1
EML-ESD (40X15)RL-T	0830585	1
EML-ESD (45X5)RL-T	0830586	1
EML-ESD (50X10)RL-T	0830587	1

Ordering data

Type	Order No.	Pcs. / Pkt.
EML-ESD (8X8)R CUS	0830588	1
EML-ESD (15X6)R CUS	0830589	1
EML-ESD (15X15)R CUS	0830590	1
EML-ESD (20X7)R CUS	0830591	1
EML-ESD (24X4)R CUS	0830592	1
EML-ESD (25X8)R CUS	0830593	1
EML-ESD (25,4X12,7)R CUS	0830594	1
EML-ESD (32X10)R CUS	0830595	1
EML-ESD (35X6,5)R CUS	0830596	1
EML-ESD (40X15)R CUS	0830597	1
EML-ESD (45X5)R CUS	0830598	1
EML-ESD (50X10)R CUS	0830599	1

Device marking

Stick-on device marking, removable

Can be printed with:

N



Thermal transfer for rolls



Unlabeled

- Particularly suitable for temporary marking
- The labels adhere well and reliably, and can be removed easily and residue-free if required
- The labels cannot be reused following removal
- Marking service: Phoenix Contact can custom-mark all EML-RM ... markers according to your requirements
- **Designation example:**
EML-RM (8x8)R
Lettering field size: 8 x 8 mm
Type of packaging: roll

Notes:
If large rolls are processed with the THERMOMARK ROLL, the external THERMOMARK ROLL-ERH media hub must be used.

General data	
Can be printed with:	
Material	
Temperature range	[°C]
Wipe resistance	
Components	

Technical data	
THERMOMARK ROLL • THERMOMARK ROLL X1 • THERMOMARK X1.1 • THERMOMARK X1.2 • THERMOMARK S1.1	
Polyester	
-40 ... 120	
DIN EN 61010-1 (VDE 0411-1)	
free from silicone and halogen	

Description	Color
Labels, removable	
4000 labels per roll	white
4000 labels per roll	white
4000 labels per roll	white
4000 labels per roll	white
4000 labels per roll	white
4000 labels per roll	white
2500 labels per roll	white
2500 labels per roll	white
2500 labels per roll	white
2500 labels per roll	white
2500 labels per roll	white
2500 labels per roll	white
1000 labels per roll	white
Labels, on large roll, removable	
10,000 labels per roll	white
10,000 labels per roll	white
8,000 labels per roll	white
10,000 labels per roll	white
10,000 labels per roll	white
10,000 labels per roll	white
10,000 labels per roll	white
10,000 labels per roll	white
10,000 labels per roll	white
8,000 labels per roll	white
10,000 labels per roll	white
10,000 labels per roll	white
Labels, removable, marked according to customer specifications	
4 labels per strip	white
5 labels per strip	white
4 labels per strip	white
4 labels per strip	white
2 labels per strip	white
2 labels per strip	white
3 labels per strip	white
2 labels per strip	white
2 labels per strip	white
2 labels per strip	white
2 labels per strip	white
2 labels per strip	white
1 label per strip	white

Ordering data		
Type	Order No.	Pcs. / Pkt.
EML-RM (8X8)R	0830528	1
EML-RM (15X6)R	0830529	1
EML-RM (15X15)R	0830530	1
EML-RM (20X7)R	0830531	1
EML-RM (24X4)R	0830532	1
EML-RM (25X8)R	0830533	1
EML-RM (25,4X12,7)R	0830534	1
EML-RM (32X10)R	0830535	1
EML-RM (35X6,5)R	0830536	1
EML-RM (40X15)R	0830537	1
EML-RM (45X5)R	0830538	1
EML-RM (50X10)R	0830539	1

Ink ribbon , length: 300 m, width: 110 mm	black
--	-------

Accessories		
THERMOMARK-RIBBON 110	5145384	1



Unlabeled, on large roll



Labeled according to customer specifications

Technical data

THERMOMARK ROLL • THERMOMARK ROLL X1 • THERMOMARK X1.1 • THERMOMARK X1.2 • THERMOMARK S1.1
 Polyester
 -40 ... 120
 DIN EN 61010-1 (VDE 0411-1)
 free from silicone and halogen

Technical data

-
 Polyester
 -40 ... 120
 DIN EN 61010-1 (VDE 0411-1)
 free from silicone and halogen

Ordering data

Type	Order No.	Pcs. / Pkt.
EML-RM (8X8)RL-T	0830540	1
EML-RM (15X6)RL-T	0830541	1
EML-RM (15X15)RL-T	0830542	1
EML-RM (20X7)RL-T	0830543	1
EML-RM (24X4)RL-T	0830544	1
EML-RM (25X8)RL-T	0830545	1
EML-RM (25,4X12,7)RL-T	0830546	1
EML-RM (32X10)RL-T	0830547	1
EML-RM (35X6,5)RL-T	0830548	1
EML-RM (40X15)RL-T	0830549	1
EML-RM (45X5)RL-T	0830550	1
EML-RM (50X10)RL-T	0830551	1

Ordering data

Type	Order No.	Pcs. / Pkt.
EML-RM (8X8)R CUS	0830552	1
EML-RM (15X6)R CUS	0830553	1
EML-RM (15X15)R CUS	0830554	1
EML-RM (20X7)R CUS	0830555	1
EML-RM (24X4)R CUS	0830556	1
EML-RM (25X8)R CUS	0830557	1
EML-RM (25,4X12,7)R CUS	0830558	1
EML-RM (32X10)R CUS	0830559	1
EML-RM (35X6,5)R CUS	0830560	1
EML-RM (40X15)R CUS	0830561	1
EML-RM (45X5)R CUS	0830562	1
EML-RM (50X10)R CUS	0830563	1

Accessories

THERMOMARK-RIBBON 110	5145384	1
-----------------------	---------	---

Accessories

--	--	--

Device marking

Stick-on device marking, with anti-tamper protection



- Tamper-proof label, can be used as a rating plate or seal, for example
- When peeled off, part of the metallic layer comes away, leaving behind a triangular pattern on both the label and the surface
- The safety function is reliable up to 80°C
- Marking service: Phoenix Contact can custom-label all EMLS ... markers in accordance with your requirements
- The EMLS ... materials are UL-listed
- **Designation example:**
EMLS (15x9)R SR
 Lettering field size: 15 x 9 mm
 Type of packaging: roll

Can be printed with:



Thermal transfer for rolls



Unlabeled



Technical data

General data

Can be printed with:

Material
 Temperature range
 Wipe resistance
 Components

[°C]

THERMOMARK ROLL • THERMOMARK ROLL X1 • THERMOMARK X1.1 • THERMOMARK X1.2 • THERMOMARK S1.1
 Polyester
 -40 ... 150
 DIN EN 61010-1 (VDE 0411-1)
 free from silicone and halogen

Ordering data

Description	Color	Type	Order No.	Pcs. / Pkt.
Safety labels				
2500 labels per roll	silver	EMLS (15X9)R SR	0800347	1
2500 labels per roll	silver	EMLS (19X6)R SR	0800343	1
1000 labels per roll	silver	EMLS (20X20)R SR	0800344	1
1000 labels per roll	silver	EMLS (26,5X12)R SR	0800353	1
1000 labels per roll	silver	EMLS (38,1X19)R SR	0800354	1
1000 labels per roll	silver	EMLS (40X8)R SR	0800348	1
1000 labels per roll	silver	EMLS (40X15)R SR	0800345	1
500 labels per roll	silver	EMLS (60X30)R SR	0800355	1
500 labels per roll	silver	EMLS (70X32)R SR	0800346	1
100 labels per roll	silver	EMLS (70X150)R SR	0800351	1
250 labels per roll	silver	EMLS (76X51)R SR	0800350	1
250 labels per roll	silver	EMLS (85X32)R SR	0800356	1

Stick-on device marking, with anti-tamper protection

- All EMLS ... device markers can also be supplied marked according to customer requirements



Labeled according to customer specifications



General data	
Can be printed with:	-
Material	Polyester
Temperature range	-40 ... 150 [°C]
Wipe resistance	DIN EN 61010-1 (VDE 0411-1)
Components	free from silicone and halogen

Technical data

Ordering data

Description	Color	Type	Order No.	Pcs. / Pkt.
Safety label, labeled acc. to customer specifications				
4 labels per strip	silver	EMLS (15X9)R SR CUS	0830175	1
4 labels per strip	silver	EMLS (19X6)R SR CUS	0830171	1
4 labels per strip	silver	EMLS (20X20)R SR CUS	0830172	1
2 labels per strip	silver	EMLS (26,5X12)R SR CUS	0830179	1
2 labels per strip	silver	EMLS (38,1X19)R SR CUS	0830180	1
2 labels per strip	silver	EMLS (40X8)R SR CUS	0830176	1
2 labels per strip	silver	EMLS (40X15)R SR CUS	0830173	1
1 label per strip	silver	EMLS (60X30)R SR CUS	0830181	1
1 label per strip	silver	EMLS (70X32)R SR CUS	0830174	1
1 label per strip	silver	EMLS (70X150)R SR CUS	0830178	1
1 label per strip	silver	EMLS (76X51)R SR CUS	0830177	1
1 label per strip	silver	EMLS (85X32)R SR CUS	0830182	1

Conductor and cable marking

Self-adhesive conductor marking with transparent protective foil

Can be printed with:



Thermal transfer for rolls



Marker for conductor diameters of up to 46 mm, unlabeled

- The cable marker labels consist of a marking field and a transparent protective foil
- The protective foil is wound over the marking and provides permanent protection against dirt and abrasion
- The cable marker labels do not increase the cross section of the cable, allowing the cable to be subsequently drawn through cable ducts, for example
- High-quality marking image created by thermal transfer printing
- Quick and easy handling
- Resistant to solvents

General data

Can be printed with:

Material	
Temperature range	[°C]
Wipe resistance	
Components	

Technical data

THERMOMARK ROLL • THERMOMARK ROLL X1 • THERMOMARK X1.1 • THERMOMARK X1.2 • THERMOMARK S1.1
 PVC
 -50 ... 110
 DIN EN 61010-1 (VDE 0411-1)
 Silicone-free

Ordering data

Description	Color	Type	Order No.	Pcs. / Pkt.
Cable marker labels				
5000 labels, up to 3 mm Ø	white	WML 3 (13X10)R	0800073	1
3000 labels, up to 5 mm Ø	white	WML 5 (25X10)R	0817523	1
3000 labels, up to 5 mm Ø	yellow	WML 5 (25X10)R YE	0830673	1
7000 labels, up to 6 mm Ø	white	WML 6 (13X13)R	0816252	1
7000 labels, up to 6 mm Ø	yellow	WML 6 (13X13)R YE	0830674	1
4000 labels, up to 7.5 mm Ø	white	WML 7,5 (13X13)R	0800074	1
1500 labels, up to 7.5 mm Ø	white	WML 7,5 (17X9)R	0828444	1
2100 labels, up to 7.5 mm Ø	white	WML 7,5 (25X13)R	0800075	1
1000 labels, up to 12 mm Ø	white	WML 12 (25X19)R	0800076	1
1500 labels, up to 14 mm Ø	white	WML 14 (25X19)R	0817536	1
1500 labels, up to 14 mm Ø	yellow	WML 14 (25X19)R YE	0817549	1
1000 labels, up to 14 mm Ø	white	WML 14 (38X19)R	0817552	1
1500 labels, up to 14 mm Ø	yellow	WML 14 (38X19)R YE	0830675	1
2500 labels, up to 18 mm Ø	white	WML 18 (12X12)R	0817507	1
500 labels, up to 20 mm Ø	white	WML 20 (31X25)R	0828457	1
900 labels, up to 22 mm Ø	white	WML 22 (25X25)R	0800078	1
500 labels, up to 36 mm Ø	white	WML 36 (25X38)R	0817510	1
250 labels, up to 46 mm Ø	white	WML 46 (25X38)R	0800067	1
Cable marker labels, on large roll				
10,000 labels, up to 5 mm Ø	white	WML 5 (25X10)RL	0830676	1
15,000 labels, up to 6 mm Ø	white	WML 6 (13X13)RL	0830677	1
5000 labels, up to 14 mm Ø	white	WML 14 (25X19)RL	0830678	1
3000 labels, up to 14 mm Ø	white	WML 14 (38X19)RL	0830679	1



Self-adhesive conductor marking with transparent protective foil

- All WML ... cable marker labels can also be supplied labeled according to customer requirements

PRINTED
FOR YOU



Markers for conductor diameters of up to 36 mm, labeled acc. to customer specifications

Technical data

General data		Technical data	
Material		PVC	
Temperature range	[°C]	-50 ... 110	
Wipe resistance		DIN EN 61010-1 (VDE 0411-1)	
Components		Silicone-free	

Ordering data

Description	Color	Type	Order No.	Pcs. / Pkt.
Cable marker labels, labeled according to customer requirements				
Up to 3 mm Ø, 4 labels per strip	white	WML 3 (13X10)R CUS	0824884	1
Up to 5 mm Ø, 3 labels per strip	white	WML 5 (25X10)R CUS	0824885	1
Up to 5 mm Ø, 3 labels per strip	yellow	WML 5 (25X10)R YE CUS	0830680	1
Up to 6 mm Ø, 7 labels per strip	white	WML 6 (13X13)R CUS	0824886	1
Up to 6 mm Ø, 7 labels per strip	yellow	WML 6 (13X13)R YE CUS	0830681	1
Up to 7.5 mm Ø, 7 labels per strip	white	WML 7,5 (13X13)R CUS	0824887	1
Up to 7.5 mm Ø, 4 labels per strip	white	WML 7,5 (17X9)R CUS	0828991	1
Up to 7.5 mm Ø, 3 labels per strip	white	WML 7,5 (25X13)R CUS	0824888	1
Up to 12 mm Ø, 3 labels per strip	white	WML 12 (25X19)R CUS	0824889	1
Up to 14 mm Ø, 3 labels per strip	white	WML 14 (25X19)R CUS	0824890	1
Up to 14 mm Ø, 3 labels per strip	yellow	WML 14 (25X19)R YE CUS	0824891	1
Up to 14 mm Ø, 2 labels per strip	white	WML 14 (38X19)R CUS	0824892	1
Up to 14 mm Ø, 2 labels per strip	yellow	WML 14 (38X19)R YE CUS	0830682	1
Up to 18 mm Ø, 7 labels per strip	white	WML 18 (12X12)R CUS	0824894	1
Up to 20 mm Ø, 2 labels per strip	white	WML 20 (31X25)R CUS	0828992	1
Up to 22 mm Ø, 3 labels per strip	white	WML 22 (25X25)R CUS	0824895	1
Up to 36 mm Ø, 3 labels per strip	white	WML 36 (25X38)R CUS	0824896	1

Printers

THERMOMARK ROLL, thermal transfer printer for material off the roll



Thermal transfer for rolls



CCC

- The THERMOMARK ROLL can print markers supplied on rolls in the context of terminal, conductor, cable, and device marking applications
- For all labels and shrink sleeves
- Maintenance-free operation with tried-and-tested thermal transfer printing technology
- High-quality, fast marking
- Easy operating concept based on straightforward touchscreen entry
- USB and Ethernet connections
- Easy to control with the CLIP PROJECT software

Notes:
An application video can be found in the download area for the relevant product on our website at www.phoenixcontact.net/products.

Dimensions	
	[mm]
General data	
Print resolution	[dpi]
Max. print width	[mm]
Max. printing length	[mm]
Power supply	[V]
Weight	[kg]
Operating systems	

Description	Color
Thermal transfer printer for material off the roll , including European power cable, US power cable, USB cable, DVD with CLIP PROJECT ADVANCED, CD with multilingual user manual/driver/firmware, A5 printed English/German user manual, one roll of EML (20x8) labels containing 1000 labels, one ink ribbon (50 meters)	gray

Cutter, can be retrofitted, for precise cutting of continuous media into required lengths

Cutter, can be retrofitted, for perforating continuous media

Transport case

External media hub, for roll diameters of 150 mm to 305 mm

External media hub, for roll diameters of up to 500 mm

Ink ribbon , length: 300 m, width: 110 mm	black	THERMOMARK-RIBBON 110	5145384	1
	blue	THERMOMARK-RIBBON 110 BU	0829544	1
	green	THERMOMARK-RIBBON 110 GN	0829542	1
	red	THERMOMARK-RIBBON 110 RD	0829543	1

Ink ribbon, specifically for high-temperature labels, EML-HT...
black

Ink ribbon, specifically for WMS... shrink sleeves, length: 300 m, width: 110 mm
black
white

Ink ribbon, specifically for WMS... shrink sleeves, length: 300 m, width: 64 mm
black
white

Technical data		
Width	Length	Height
253	320	189

300 dpi
104
1000
100 ... 240 / 50 Hz ... 60 Hz
4
MS Windows XP SP3, MS Windows Vista, MS Windows 7 (32/64-bit), MS Windows 8 (32/64-bit)

Ordering data

Type	Order No.	Pcs. / Pkt.
THERMOMARK ROLL	5146477	1

Accessories

THERMOMARK ROLL-CUTTER	5146422	1
THERMOMARK ROLL-CUTTER/P	5146435	1
TL CASE	0800613	1
THERMOMARK ROLL-ERH	5146448	1
THERMOMARK-ERH 500	5146309	1
THERMOMARK-RIBBON 110	5145384	1
THERMOMARK-RIBBON 110 BU	0829544	1
THERMOMARK-RIBBON 110 GN	0829542	1
THERMOMARK-RIBBON 110 RD	0829543	1
THERMOMARK-RIBBON 110-EML-HT	0800342	1
THERMOMARK-RIBBON 110-WMSU	0801358	1
THERMOMARK-RIBBON 110-WMSU WH	0801359	1
THERMOMARK-RIBBON 64-WMSU	0801360	1
THERMOMARK-RIBBON 64-WMSU WH	0801361	1

THERMOMARK ROLL X1, thermal transfer printer for material off the roll



Thermal transfer for rolls



The THERMOMARK ROLL X1 printer is suitable for marking large quantities and offers the following features:

- Also accommodates large rolls; inside the printer housing, the label rolls are protected against environmental influences such as dust and dirt
- For all labels and shrink sleeves
- Maintenance-free operation with tried-and-tested thermal transfer printing technology
- High-quality, fast marking
- Easy operating concept based on straightforward touchscreen entry
- USB and Ethernet connections
- Easy to control with the CLIP PROJECT software
- Printing and dispensing labels on request or automatically after removing the label with the THERMOMARK ROLL X1 - DISPENSER

Cutting to length or perforating is easy

- Continuous media can be cut or perforated with a high degree of positioning accuracy (see figure below)



Dimensions	[mm]
General data	
Temperature range	[°C] 5 ... 40
Print resolution	[dpi] 300 dpi
Max. print width	[mm] 104
Max. printing length	[mm] 1000
Interfaces	10/100 Mbps Ethernet / USB 2.0
Power supply	[V] 100 ... 240 / 50 Hz ... 60 Hz
Weight	[kg] 5
Operating systems	MS Windows XP SP3, MS Windows Vista, MS Windows 7 (32/64-bit), MS Windows 8 (32/64-bit)

Technical data		
Width	Length	Height
264	412	245

Description	Color
Thermal transfer printer for material off the roll , including European power cable, US power cable, USB cable, DVD with CLIP PROJECT ADVANCED, CD with multilingual user manual/driver/firmware, A5 printed English/German user manual, one roll of EML (20x8) labels containing 1000 labels, one ink ribbon (50 meters)	gray

Ordering data		
Type	Order No.	Pcs. / Pkt.
THERMOMARK ROLL X1	5146723	1

Cutter, can be retrofitted, for precise cutting of continuous media into required lengths

Perforation device, can be retrofitted, for perforating and cutting continuous media

Accessories

Ink ribbon , length: 300 m, width: 110 mm	black	THERMOMARK-RIBBON 110	5145384	1
	blue	THERMOMARK-RIBBON 110 BU	0829544	1
	green	THERMOMARK-RIBBON 110 GN	0829542	1
	red	THERMOMARK-RIBBON 110 RD	0829543	1
Ink ribbon , specifically for high-temperature labels, EML-HT...				
	black	THERMOMARK-RIBBON 110-EML-HT	0800342	1
Ink ribbon , specifically for WMS... shrink sleeves, length: 300 m, width: 110 mm				
	black	THERMOMARK-RIBBON 110-WMSU	0801358	1
	white	THERMOMARK-RIBBON 110-WMSU WH	0801359	1
Ink ribbon , specifically for WMS... shrink sleeves, length: 300 m, width: 64 mm				
	black	THERMOMARK-RIBBON 64-WMSU	0801360	1
	white	THERMOMARK-RIBBON 64-WMSU WH	0801361	1
Ink ribbon , specifically for cable markers for assembly with cable binders, WMTB HF..., length: 300 m, width: 110 mm				
	black	THERMOMARK-RIBBON 110-WMTB HF	5148007	1
Transport case	silver	THERMOMARK ROLL X1-CASE	5146724	1

THERMOMARK ROLL X1 CUTTER	5146765	1
THERMOMARK ROLL X1 CUTTER/P	5146766	1

Hand tools

MICROFOX electronics pliers



Miniature precision pliers feature the following:

- Ergonomically designed two-component grip for fatigue-proof and non-slip use
- Manufactured from high-grade special tool steel
- Opening spring for uniform, smooth opening
- Through-connected joint for permanent stability and optimum distribution of force
- Mirror-polished and oiled metal surfaces, which provide maximum rust protection

Cutting pliers

- Additional inductive hardened cutting for long-term, stable cutting performance
- Precision-ground for exact cutting applications with minimum effort
- Various head shapes, even for areas that are difficult to access

Gripping and bending pliers

- Smooth grip to prevent damage to components when gripping and bending

Notes:
 Technical data regarding cutting capacity, see www.phoenixcontact.net/products



Diagonal cutter, with chamfer



Ordering data

Description	Type	Order No.	Pcs. / Pkt.
Electronic diagonal cutter , round head, with chamfer, with opening spring	MICROFOX-SB	1212489	1
Electronic diagonal cutter , tapered head, angled (21°), without chamfer, with opening spring	MICROFOX-SP	1212488	1
Electronic diagonal cutter , tapered head, without chamfer, with opening spring, non-reflective phosphate-treated surface, punched version	MICROFOX-SP-1	1212487	1
Electronic front cutter , without chamfer, with opening spring			
Electronic front cutter , 20° angle, without chamfer, with opening spring			
Electronic needle-nose pliers , smooth grip, with opening spring			
Electronic needle-nose pliers , 45° angle, smooth grip, with opening spring			
Electronic flat-nose pliers , smooth grip, with opening spring			
Electronic round-nose pliers , smooth grip, with opening spring			



Front cutter



Needle-nose pliers



Flat/round-nose pliers



Ordering data		
Type	Order No.	Pcs. / Pkt.
MICROFOX-E	1212494	1
MICROFOX-EO	1212495	1

Ordering data		
Type	Order No.	Pcs. / Pkt.
MICROFOX-P	1212491	1
MICROFOX-PC	1212492	1

Ordering data		
Type	Order No.	Pcs. / Pkt.
MICROFOX-F	1212493	1
MICROFOX-R	1212490	1

Hand tools

MICROFOX ESD electronics pliers

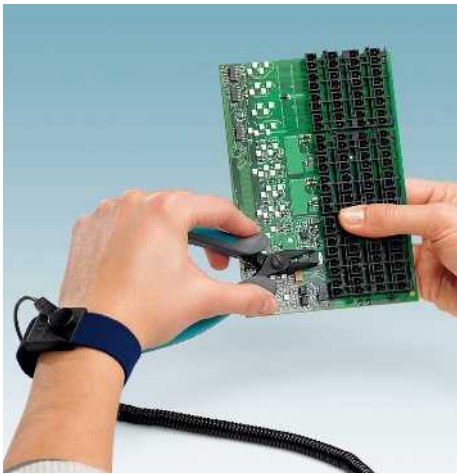

ESD MICROFOX pliers offer the following features:

- The special conductive plastic grip ensures slow and safe removal of electrostatic energy according to standards and directives such as DIN EN 61340-5
- Ergonomically designed two-component grip for fatigue-proof and non-slip use
- Manufactured from high-grade special tool steel
- Opening spring for uniform, smooth opening
- Screwed precision-joint for permanent stability and optimum results
- Mirror-polished and phosphate-treated metal surfaces for optimum rust protection and no glare when working

Cutting pliers

- Additional inductive hardened cutting for long-term, stable cutting performance
- Precision-ground for exact cutting applications with minimum effort
- Various head shapes, even for areas that are difficult to access

Gripping and bending pliers

- Smooth grip to prevent damage to components when gripping and bending



Notes:
 Technical data regarding cutting capacity, see www.phoenixcontact.net/products



ESD diagonal cutter



Ordering data

Description
ESD electronic diagonal cutter, round head, without chamfer, with opening spring
ESD electronic front cutter, without chamfer, with opening spring
ESD electronic needle-nose pliers, smooth grip, with opening spring
ESD electronic needle-nose pliers, 45° angle, smooth grip, with opening spring
ESD electronic flat-nose pliers, smooth grip, with opening spring
ESD electronic round-nose pliers, smooth grip, with opening spring

Type	Order No.	Pcs. / Pkt.
MICROFOX-S ESD	1212480	1



ESD front cutter



ESD needle-nose pliers



ESD flat/round-nose pliers



Ordering data		
Type	Order No.	Pcs. / Pkt.
MICROFOX-E ESD	1212485	1

Ordering data		
Type	Order No.	Pcs. / Pkt.
MICROFOX-P ESD	1212482	1
MICROFOX-PC ESD	1212483	1

Ordering data		
Type	Order No.	Pcs. / Pkt.
MICROFOX-F ESD	1212484	1
MICROFOX-R ESD	1212481	1



Stamp holder for EMC header



Stamp set for EMCV header

Description	Ordering data			Ordering data		
	Type	Order No.	Pcs. / Pkt.	Type	Order No.	Pcs. / Pkt.
Stamp holder , for EMC press-in pin strips, for upper and lower stamp	EMC 1,5-SH	1877258	1			
Stamp set , for EMCV press-in pin strips, consisting of upper and lower stamp for 3.81 mm pitch, 2 to 16-pos.				EMCV 1,5-SS 1	1877274	1



Stamp holder for EMSTB header



Stamp set for EMSTBVA header

Description	Ordering data			Ordering data		
	Type	Order No.	Pcs. / Pkt.	Type	Order No.	Pcs. / Pkt.
Stamp holder , for EMSTB press-in pin strips, for upper and lower stamp	EMSTB 2,5-SH	1877203	1			
Stamp set , for EMSTBVA press-in pin strips, consisting of lower stamp 2 to 24 pos. and upper stamp 2 to 16-pos.				EMSTBVA 2,5-SS-1-5,08	1877216	1



Module socket contact for MSTBC pin strip



Module pin contact for ICC connector

Description	Ordering data			Ordering data		
	Type	Order No.	Pcs. / Pkt.	Type	Order No.	Pcs. / Pkt.
<p>Module socket contact, is inserted into the connector after the conductor has been crimped; for conductors from</p> <p>0.5 to 1.0 mm² 0.5 to 1.0 mm² ribbon contacts 1.5 to 2.5 mm² 1.5 to 2.5 mm² ribbon contacts</p> <p>Module pin contact, is inserted into the connector after the conductor has been crimped; for conductors from</p> <p>0.5 to 1.0 mm² 0.5 to 1.0 mm² ribbon contacts 1.5 to 2.5 mm² 1.5 to 2.5 mm² ribbon contacts</p>	<p>MSTBC-MT 0,5-1,0 MSTBC-MT 0,5-1,0 BA MSTBC-MT 1,5-2,5 MSTBC-MT 1,5-2,5 BA</p>	<p>3190564 3190645 3190551 3190658</p>	<p>100 4000 100 3500</p>	<p>ICC-MT 0,5-1,0 ICC-MT 0,5-1,0 BA ICC-MT 1,5-2,5 ICC-MT 1,5-2,5 BA</p>	<p>3190577 3190603 3190580 3190593</p>	<p>100 4000 100 4000</p>



Module socket contact for MCC pin strip



Module socket Contact for PCC pin strip

Description	Ordering data			Ordering data		
	Type	Order No.	Pcs. / Pkt.	Type	Order No.	Pcs. / Pkt.
<p>Module socket contact, is inserted into the plug component after the conductor has been crimped; for conductors from</p> <p>0.2 to 0.34 mm² 0.2 to 0.34 mm² ribbon contacts 0.5 to 1.0 mm² 0.5 to 1.0 mm² ribbon contacts</p> <p>Module socket contact, 0.5 - 1 mm² for wires from 0.5 ... 1.0 mm²</p> <p>For conductors from 1.5 ... 2.5 mm²</p>	<p>MCC-MT 0,2-0,35 MCC-MT 0,2-0,35 (0,0) BA MCC-MT 0,5-1,0 MCC-MT 0,5-1,0 BAND</p>	<p>1859988 1923717 1859991 1898622</p>	<p>100 8000 100 6500</p>	<p>STG-MTN 0,5-1,0 STG-MTN 0,5-1,0 BA STG-MTN 1,5-2,5 STG-MTN 1,5-2,5 BAND</p>	<p>3190438 3190629 3190506 3190632</p>	<p>100 4000 100 3300</p>

Pullout aids



Pull-out aid for plugs with crimp contact, pitch 5.08 mm

Ordering data

Description	Type	Order No.	Pcs. / Pkt.
<p>Pull-out aid for MSTBC 2,5/... and ICC 2,5/..., for snapping into the latching chambers of the plug, can be labeled with ZB 6</p> <p>2-pos. 4-pos. 8-pos. 12-pos.</p>	<p>STZ 2-MSTBC-5,08 STZ 4-MSTBC-5,08 STZ 8-MSTBC-5,08 STZ 12-MSTBC-5,08</p>	<p>1810529 1810532 1810516 1810503</p>	<p>50 50 50 50</p>

Notes:

1) Different numbers of positions can be supplied for MCC 1/...ST on request



Pull-out aid for plugs with crimp contact, pitch 3.81/7.62 mm

Ordering data

Description	Type	Order No.	Pcs. / Pkt.
<p>Pull-out aid for MCC 1/...ST.. and for PCC 4/...ST..., for snapping into the latching chambers of the plug, can be labeled with ZB 6;1)</p> <p>2-pos. 3 to 4-pos. 5- to 7-pos. 8- to 12-pos.</p>	<p>STZ 2-PCC 4-7,62 STZ 3-PCC 4-7,62 STZ 5-PCC 4-7,62 GN STZ 8-PCC 4-7,62</p>	<p>1840214 1840227 1842005 1840230</p>	<p>50 50 50 50</p>



Insertion bridge for plugs featuring screw connection with 3.81 mm pitch



Insertion bridge with long contact zone for plugs featuring screw connection with 5 or 5.08 mm pitch

Description	Ordering data			Ordering data		
	Type	Order No.	Pcs. / Pkt.	Type	Order No.	Pcs. / Pkt.
Insertion bridge , fully insulated, for plugs with a 3.81 mm pitch						
2-pos.	EBPL 2-3,81	1733495	50			
3-pos.	EBPL 3-3,81	1733505	50			
4-pos.	EBPL 4-3,81	1733518	50			
Insertion bridge , insulated						
2-pos.				EBL 2- 5	2303145	10
3-pos.				EBL 3- 5	2303158	10

Notes:

Please refer to the notes for the bridges, refer to page 37



Insertion bridge for PCB terminal blocks and plugs featuring screw connection with 5.0 or 5.08 mm pitch

Description	Ordering data		
	Type	Order No.	Pcs. / Pkt.
Insertion bridge , fully insulated, for plug-in connectors with 5.0 or 5.08 mm pitch			
2-pos.	EBP 2- 5	1733169	10
3-pos.	EBP 3- 5	1733172	10
4-pos.	EBP 4- 5	1733185	10
5-pos.	EBP 5- 5	1733198	10
6-pos.	EBP 6- 5	1733208	10

Fixed bridges

Notes:
 Please refer to the notes for the bridges, refer to page 37.
 *) Current carrying capacity 20 A. Laboratory data sheet available on request.



Fixed bridge, for ZFKDS 4 PCB terminal blocks, 7.5 mm pitch



Fixed bridge, for ZFKDS 4 PCB terminal blocks, 10 mm pitch

Description
Fixed bridge , for ZFKDS 4 PCB terminal blocks, fully insulated, 7.5 mm pitch ¹⁾
2-pos.
3-pos.
4-pos.
5-pos.
10-pos.
Fixed bridge , for ZFKDS 4 PCB terminal blocks, fully insulated, 10 mm pitch ¹⁾
2-pos.
3-pos.
4-pos.
5-pos.
10-pos.

Ordering data		
Type	Order No.	Pcs. / Pkt.
FBSK 2-7,5	1928343	50
FBSK 3-7,5	1928356	50
FBSK 4-7,5	1928369	10
FBSK 5-7,5	1928372	50
FBSK 10-7,5	1928385	50

Ordering data		
Type	Order No.	Pcs. / Pkt.
FBSK 2-10	1928398	50
FBSK 3-10	1928408	50
FBSK 4-10	1928411	50
FBSK 5-10	1928424	10
FBSK 10-10	1928437	50

Notes:
 Please refer to the notes for the bridges, refer to page 37
 *) Current carrying capacity 57 A. Laboratory data sheet available on request.



Fixed bridge, for ZFKDS 10 PCB terminal blocks, 10 mm pitch



Fixed bridge, for ZFKDS 10 PCB terminal blocks, 10 mm pitch

Description
Fixed bridge , for ZFKDS 10 PCB terminal blocks, fully insulated, 10 mm pitch ¹⁾
2-pos.
3-pos.
4-pos.
Fixed bridge , for ZFKDS 10 PCB terminal blocks, fully insulated, pitch: 15 mm ¹⁾
2-pos.
3-pos.
4-pos.

Ordering data		
Type	Order No.	Pcs. / Pkt.
FBSK 2-10/ZFKDS 10	1986644	50
FBSK 3-10/ZFKDS 10	1986657	10
FBSK 4-10/ZFKDS 10	1986660	10

Ordering data		
Type	Order No.	Pcs. / Pkt.
FBSK 2-15/ZFKDS 10	1986699	50
FBSK 3-15/ZFKDS 10	1986686	50
FBSK 4-15/ZFKDS 10	1986673	50



2.3 mm test plugs



Test plug, consisting of 1 mm Ø test pin and 2 mm Ø socket

		Ordering data			Ordering data		
Description	Color	Type	Order No.	Pcs. / Pkt.	Type	Order No.	Pcs. / Pkt.
Test plug metal part, 2.3 mm Ø		MPS-MT	0201744	10			
Insulating sleeve, for MPS metal part	white	MPS-IH WH	0201663	10			
	red	MPS-IH RD	0201676	10			
	blue	MPS-IH BU	0201689	10			
	yellow	MPS-IH YE	0201692	10			
	green	MPS-IH GN	0201702	10			
	gray	MPS-IH GY	0201728	10			
	black	MPS-IH BK	0201731	10			
Test plug, consisting of 1 mm Ø test pin, conductor length 150 mm and socket Ø 2 mm					MPS-MT 1-S	1944372	1
					MPS-MT 1-S4-B RD	1982800	50



4 mm test plugs



Reducing plug

		Ordering data			Ordering data			
Description	Color	Type	Order No.	Pcs. / Pkt.	Type	Order No.	Pcs. / Pkt.	
Test plug, consisting of: Metal part for 4 mm Ø socket hole And		PS-MT	0311647	10				
Insulating sleeve for PS metal part	white	PS-IH WH	0311566	10				
	red	PS-IH RD	0311579	10				
	blue	PS-IH BU	0311582	10				
	yellow	PS-IH YE	0311595	10				
	green	PS-IH GN	0311605	10				
	violet	PS-IH VT	0311618	10				
	gray	PS-IH GY	0311621	10				
		black	PS-IH BK	0311634	10			
	Reducing plug, for connecting a 4 mm Ø test plug to a 2.3 mm Ø test plug socket	gray				RPS	0201647	10

Test plug

Notes:

COMBICON select

You will find the possible plug-in connector combinations in COMBICON select at: www.phoenixcontact.net/products



5-position test plug



Technical data

Technical data
 Single-wire/terminal point, stranded
 Single-wire/terminal point, AWG
 Nominal current I_N
 Nominal voltage U_N

0.14 mm² - 0.75 mm²
 26 - 18
 2 A
 125 V

Ordering data

Description

Test plug, 5-pos., 5/5,08 mm pitch with 2 mm Ø test pins, gold-plated test pins

Test plug, 10-pos., 5/5,08 mm pitch with 2 mm Ø lamellar pins and 10 firmly welded 1 m test conductors, gold-plated lamellar pins

Test plug, 5-position, 5/5.08 mm pitch, with special multiple-spring wire plug, makes contact in the connection space

Test plug, 5-position, 7.5/7.62 mm pitch, with special multiple-spring wire plug, makes contact in the connection space

Type	Order No.	Pcs. / Pkt.
ST-MKDSP 3/5	1718207	10

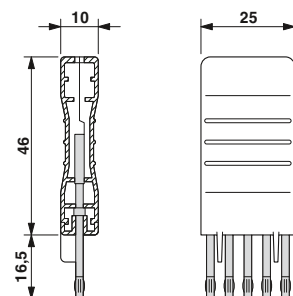

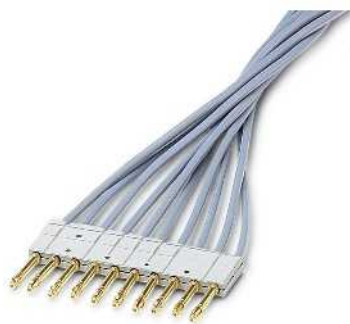

10-pos. test plug, with 10 welded-on test conductors



5-pos. test plug, 5/0/5.08 mm pitch, makes contact in the conductor connection space



5-pos. test plug, 7.5/7.62 mm pitch, makes contact in the conductor connection space



Technical data

Technical data

Technical data

0.75 mm²
-
2 A
125 V

0.75 mm²
-
2 A
25 V

0.75 mm²
-
2 A
25 V

Ordering data

Ordering data

Ordering data

Type	Order No.	Pcs. / Pkt.
SPB 10-MKDSP	1301355	5

Type	Order No.	Pcs. / Pkt.
SPB 5-MKDS 3	1301216	10

Type	Order No.	Pcs. / Pkt.
SPB 5-GMKDS 3	1301203	10

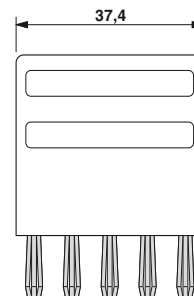
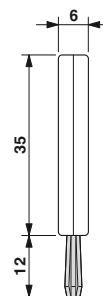
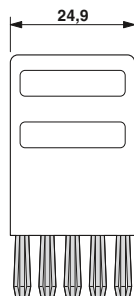
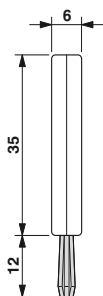
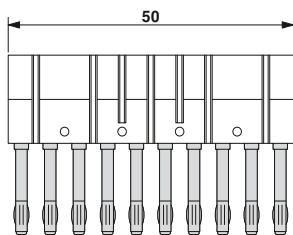
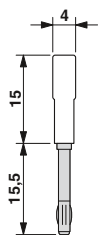

Ferrules

Ferrules without insulating collar, according to DIN 46228-1

- The ferrules without plastic sleeve are made from soft tin-plated electrolytic copper
- The dimensions of the ferrules conform to DIN 46228-1
- The A 0,25.. can also be used to process conductors with a cross section of 0.14 mm²

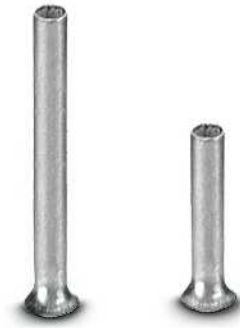
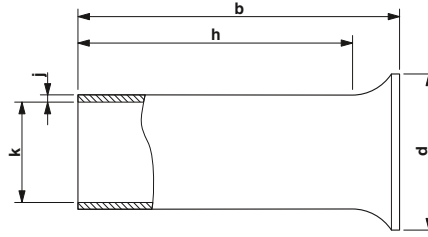

Conductor cross sections from 0.14 to 35 mm²

Notes:
 1) These ferrules are not included in DIN 46228-4:1990-09.



General data

Material / coating

Technical data

Technical data

E-CU / tin-plated (galvanic)

Ordering data

Description	Cross section		Color
	[mm ²]	AWG	
Ferrules, without plastic sleeves, CSA-certified			
	0.25 ¹⁾	24	silver
	0.25 ¹⁾	24	silver
	0.34 ¹⁾	22	silver
	0.5	20	silver
	0.5 ¹⁾	20	silver
	0.5	20	silver
	0.75	18	silver
	0.75 ¹⁾	18	silver
	0.75	18	silver
	1	18	silver
	1 ¹⁾	18	silver
	1	18	silver
	1.5	16	silver
	1.5	16	silver
	1.5	16	silver
	1.5	16	silver
	1.5	16	silver
	2.5	14	silver
	2.5	14	silver
	2.5	14	silver
	4	12	silver
	4	12	silver
	4	12	silver
	6	10	silver
	6	10	silver
	10	8	silver
	10	8	silver
	16	6	silver
	25 ¹⁾	4	silver
	25	4	silver
	25	4	silver
	25 ¹⁾	4	silver
	35	2	silver
	35 ¹⁾	2	silver

Dimensions [mm]							
a	b	d	h	i	j	k	
-	5.00	1.70	4.30	-	0.15	0.80	
-	7.00	1.70	6.30	-	0.15	0.80	
-	7.00	1.80	6.30	-	0.15	0.90	
-	6.00	2.10	5.30	-	0.15	1.00	
-	8.00	2.10	7.30	-	0.15	1.00	
-	10.00	2.10	9.30	-	0.15	1.00	
-	6.00	2.30	5.30	-	0.15	1.20	
-	8.00	2.30	7.30	-	0.15	1.20	
-	10.00	2.30	9.30	-	0.15	1.20	
-	6.00	2.50	5.30	-	0.15	1.40	
-	8.00	2.50	7.30	-	0.15	1.40	
-	10.00	2.50	9.30	-	0.15	1.40	
-	7.00	2.80	6.00	-	0.15	1.70	
-	10.00	2.80	9.00	-	0.15	1.80	
-	12.00	2.80	11.00	-	0.15	1.70	
-	15.00	2.80	14.00	-	0.15	1.70	
-	18.00	2.80	17.00	-	0.15	1.70	
-	7.00	3.40	6.00	-	0.15	2.20	
-	12.00	3.40	11.00	-	0.15	2.20	
-	18.00	3.40	17.00	-	0.15	2.20	
-	9.00	4.00	8.00	-	0.20	2.80	
-	12.00	4.00	11.00	-	0.20	2.80	
-	18.00	4.00	17.00	-	0.20	2.80	
-	10.00	4.70	9.00	-	0.20	3.50	
-	12.00	4.70	11.00	-	0.20	3.50	
-	12.00	5.80	10.80	-	0.20	4.50	
-	18.00	5.80	16.80	-	0.20	4.50	
-	12.00	7.50	10.50	-	0.20	5.80	
-	12.00	9.50	10.00	-	0.20	7.30	
-	15.00	9.50	13.00	-	0.20	7.30	
-	18.00	9.50	16.00	-	0.20	7.30	
-	20.00	9.50	18.00	-	0.20	7.30	
-	18.00	11.00	16.00	-	0.20	8.30	
-	20.00	11.00	18.00	-	0.20	8.30	

Type	Order No.	Pcs. / Pkt.
A 0,25-5	3202465	1000
A 0,25-7	3202478	1000
A 0,34-7	3009202	1000
A 0,5-6	3200218	1000
A 0,5-8	3202481	1000
A 0,5-10	3202494	1000
A 0,75-6	3200221	1000
A 0,75-8	3202504	1000
A 0,75-10	3200234	1000
A 1-6	3200247	1000
A 1-8	3202517	1000
A 1-10	3200250	1000
A 1,5-7	3200263	1000
A 1,5-10	3200276	1000
A 1,5-12	3202588	1000
A 1,5-15	3202591	1000
A 1,5-18	3202601	1000
A 2,5-7	3200289	1000
A 2,5-12	3200292	1000
A 2,5-18	3202821	1000
A 4-9	3200302	1000
A 4-12	3200315	1000
A 4-18	3202834	1000
A 6-10	3202520	500
A 6-12	3200328	500
A 10-12	3200331	500
A 10-18	3200344	500
A 16-12	3200425	100
A 25-12	3200357	100
A 25-15	3200360	100
A 25-18	3200373	100
A 25-20	3200386	100
A 35-18	3200399	100
A 35-20	3200409	100

Ferrules with insulating collar, according to DIN 46228-4

- The ferrules with plastic sleeve are made from soft tin-plated electrolytic copper
- The insulation reliability of close connections is increased and the splicing of wires is prevented
- The AI 0,25.. can also be used to process conductors with a cross section of 0.14 mm²

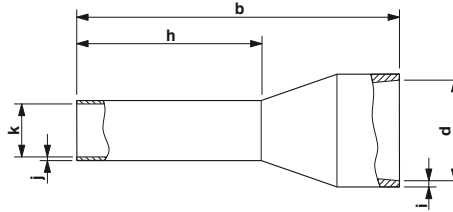

Notes:
 1) These ferrules are not included in DIN 46228-4:1990-09.



Conductor cross sections from 0.14 to 120 mm²

General data	
Material / coating	
Plastic sleeve material	
Long/short-term temperature	

Technical data							
a	b	d	h	i	j	k	

Technical data	
E-CU / tin-plated (galvanic)	
polypropylene	
105 °C / 120 °C	

Description	Cross section		Color
	[mm ²]	AWG	
Ferrules, with plastic sleeve, color range as per DIN 46228-4: 1990-09, CSA-certified			
	0.25 ¹⁾	22	yellow
	0.25 ¹⁾	22	yellow
	0.5	20	white
	0.5	20	white
	0.5	20	white
	0.5	20	white
	0.5 ¹⁾	20	white
	0.75	18	gray
	0.75	18	gray
	0.75	18	gray
	0.75	18	gray
	0.75	18	gray
	1	18	red
	1	18	red
	1	18	red
	1	18	red
	1	18	red
	1.5 ¹⁾	16	black
	1.5	16	black
	1.5	16	black
	1.5	16	black
	1.5	16	black
	1.5	16	black
	1.5	16	black
	2.5	14	blue
	2.5	14	blue
	2.5 ¹⁾	14	blue
	2.5	14	blue
	2.5	14	blue
	4	12	gray
	4	12	gray
	4	12	gray
	6	10	yellow
	6	10	yellow
	10	8	red
	10	8	red
	16	6	blue
	16	6	blue
	25	4	yellow
	25	4	yellow
	25	4	yellow
	35	2	red
	35	2	red
	35	2	red
	50	1/0	blue
	50	1/0	blue
	70 ¹⁾	2	yellow
	95 ¹⁾	4	red
	120 ¹⁾	5	blue

Dimensions [mm]							
a	b	d	h	i	j	k	
-	10.50	2.00	6.00	0.25	0.15	0.80	
-	12.50	2.00	8.00	0.25	0.15	0.80	
-	12.00	2.50	6.00	0.25	0.15	1.10	
-	14.00	2.50	8.00	0.25	0.15	1.10	
-	14.00	2.50	8.00	0.25	0.15	1.10	
-	16.00	2.50	10.00	0.25	0.15	1.10	
-	18.00	2.50	12.00	0.25	0.15	1.10	
-	12.00	2.80	6.00	0.25	0.15	1.30	
-	14.00	2.80	8.00	0.25	0.15	1.30	
-	14.00	2.80	8.00	0.25	0.15	1.30	
-	16.00	2.80	10.00	0.25	0.15	1.30	
-	18.00	2.80	12.00	0.25	0.15	1.30	
-	12.00	3.00	6.00	0.30	0.15	1.50	
-	14.00	3.00	8.00	0.30	0.15	1.50	
-	14.00	3.00	8.00	0.30	0.15	1.50	
-	16.00	3.00	10.00	0.30	0.15	1.50	
-	18.00	3.00	12.00	0.30	0.15	1.50	
-	12.00	3.40	6.00	0.30	0.15	1.80	
-	14.00	3.40	8.00	0.30	0.15	1.80	
-	14.00	3.40	8.00	0.30	0.15	1.80	
-	18.00	3.40	10.00	0.30	0.15	1.80	
-	18.50	3.40	12.00	0.30	0.15	1.80	
-	24.00	3.40	18.00	0.30	0.15	1.80	
-	14.00	4.20	8.00	0.30	0.15	2.30	
-	14.00	4.20	8.00	0.30	0.15	2.30	
-	17.00	4.20	10.00	0.30	0.15	2.30	
-	18.00	4.20	12.00	0.30	0.15	2.30	
-	24.00	4.20	18.00	0.30	0.15	2.30	
-	17.00	4.80	10.00	0.30	0.20	2.80	
-	19.00	4.80	12.00	0.30	0.20	2.80	
-	26.00	4.80	18.00	0.30	0.20	2.80	
-	20.00	6.20	12.00	0.30	0.20	3.50	
-	26.00	6.20	18.00	0.30	0.20	3.50	
-	22.00	7.50	12.00	0.30	0.20	4.60	
-	28.00	7.50	18.00	0.30	0.20	4.60	
-	24.00	8.80	12.00	0.40	0.20	5.80	
-	28.00	8.80	18.00	0.40	0.20	5.80	
-	30.00	11.00	16.00	0.50	0.20	7.30	
-	32.00	11.00	18.00	0.50	0.20	7.30	
-	35.00	11.00	22.00	0.50	0.20	7.30	
-	30.00	12.50	16.00	0.50	0.20	8.30	
-	32.00	12.50	18.00	0.50	0.20	8.30	
-	39.00	12.50	25.00	0.50	0.20	8.30	
-	36.00	15.00	20.00	0.60	0.35	10.30	
-	40.00	15.00	25.00	0.60	0.35	10.30	
-	37.00	16.00	20.00	0.60	0.35	12.70	
-	44.00	18.00	25.00	0.60	0.35	14.70	
-	48.00	21.00	27.00	0.70	0.45	16.70	

Ordering data		
Type	Order No.	Pcs. / Pkt.
AI 0,25- 6 YE	3203024	100
AI 0,25- 8 YE	3203037	100
AI 0,5 - 6 WH	3200687	100
AI 0,5 - 8 WH	3200014	100
AI 0,5 - 8 WH -1000	3200881	1000
AI 0,5 -10 WH	3201275	100
AI 0,5 -12 WH	3200506	100
AI 0,75- 6 GY	3200690	100
AI 0,75- 8 GY	3200519	100
AI 0,75- 8 GY -1000	3200894	1000
AI 0,75-10 GY	3201288	100
AI 0,75-12 GY	3200849	100
AI 1 - 6 RD	3200742	100
AI 1 - 8 RD	3200030	100
AI 1 - 8 RD -1000	3200904	1000
AI 1 -10 RD	3200182	100
AI 1 -12 RD	3200674	100
AI 1,5 - 6 BK	3200755	100
AI 1,5 - 8 BK	3200043	100
AI 1,5 - 8 BK -1000	3200917	1000
AI 1,5 -10 BK	3200195	100
AI 1,5 -12 BK	3201482	100
AI 1,5 -18 BK	3200056	100
AI 2,5 - 8 BU	3200522	100
AI 2,5 - 8 BU -1000	3200920	1000
AI 2,5 -10 BU	3202533	100
AI 2,5 -12 BU	3200962	100
AI 2,5 -18 BU	3200580	100
AI 4 -10 GY	3200535	100
AI 4 -12 GY	3200959	100
AI 4 -18 GY	3200593	100
AI 6 -12 YE	3200548	100
AI 6 -18 YE	3200603	100
AI 10 -12 RD	3200551	100
AI 10 -18 RD	3200616	100
AI 16 -12 BU	3200564	100
AI 16 -18 BU	3200629	100
AI 25 -16 YE	3200577	50
AI 25 -18 YE	3201505	50
AI 25 -22 YE	3200700	50
AI 35 -16 RD	3200441	50
AI 35 -18 RD	3201495	50
AI 35 -25 RD	3200713	50
AI 50 -20 BU	3200454	50
AI 50 -25 BU	3200726	25
AI 70 -20 YE	3201848	25
AI 95 -25 RD	3201853	25
AI120 -27 BU	3201822	25

Notes:

Please refer to the notes for the mounting flanges on page 36.



Additional fastening for horizontal and vertical MSTB headers

Description	Ordering data		
	Type	Order No.	Pcs. / Pkt.
Mounting flange , for fixing both ends of the header onto the PCB, with M2 x 14 screws and nuts	MSTB-BF	1759981	50
Coding tab , for MSTB headers, for dividing headers, plugged onto the header pin, made from green insulation material			
Pair of guide rails , inserted into the groove of ICV ...-G, for accommodating a printed circuit board (mother/daughter PCB connection) height: 86 mm, hole diameter: 3.4 mm			
Strain relief , for 5.08 mm pitch FKIC plugs, snapped into the latching chambers of the connection plugs			
4 to 7-pos. ≥ 8-pos.			



Insertable coding tab



Pair of guide rails for ICV...G



Pull-out aid for FKC plug with 5.08 mm pitch



Ordering data			Ordering data			Ordering data		
Type	Order No.	Pcs. / Pkt.	Type	Order No.	Pcs. / Pkt.	Type	Order No.	Pcs. / Pkt.
MSTB-BL	1755477	100						
			FLRP/ICV 80	1808353	10			
						STZ 4-FKC-5,08	1876877	50
						STZ 8-FKC-5,08	1876880	50

Sheet metal cutout dimensions/drilling diagrams/dimensional drawings

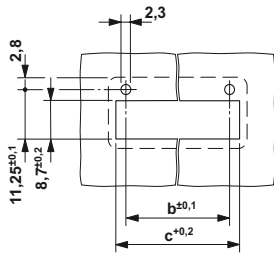

Sheet metal cutout dimensions for DFK-MC 1,5/...-GF, see page 240.

Number of positions	b	c
2	13.81	18.50
3	17.62	22.30
4	21.43	26.10
5	25.24	29.90
6	29.05	33.80
7	32.86	37.60
8	36.67	41.40
9	40.48	45.10
10	44.29	49.00
11	48.10	52.80
12	51.91	56.60
13	55.72	60.40
14	59.53	64.20
15	63.34	68.00
16	67.15	71.90

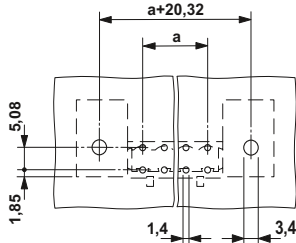

Drilling diagram for ICV 2,5/...-G-5,08 with FLRP-ICV 80, see page 333.

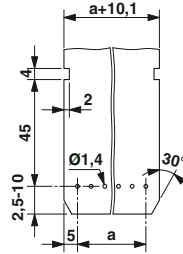

PCB cutout for ICV 2,5/...-G-5,08 with FLRP-ICV 80, see page 333.

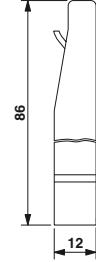

FLRP-ICV 80, see page 332.

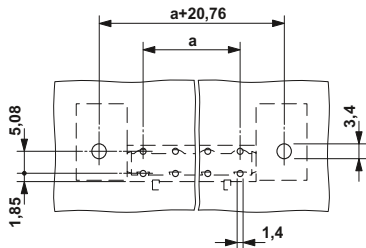

Drilling diagram for GICV 2,5/...-G-7,62 with FLRP-ICV, see page 347.

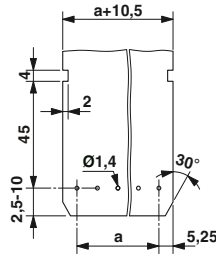

PCB cutout for GICV 2,5/...-G-5,08 with FLRP-ICV 80, see page 347.

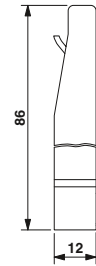

FLRP-ICV 80, see page 346.

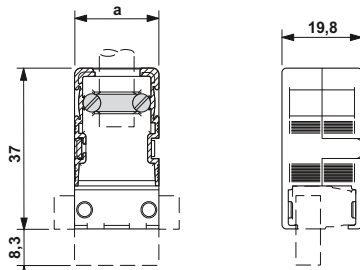

KGG-MSTB 2,5/..., see page 348.

Cable housing	Plugs
KGG-MSTB 2,5/3	GMSTB 2,5/2-ST*
KGG-MSTB 2,5/4	GMSTB 2,5/3-ST
KGG-MSTB 2,5/6	GMSTB 2,5/4-ST*
KGG-MSTB 2,5/7	GMSTB 2,5/5-ST
KGS-MSTB 2,5/9	GMSTB 2,5/6-ST*
KGS-MSTB 2,5/10	GMSTB 2,5/7-ST
KGS-MSTB 2,5/12	GMSTB 2,5/8-ST*
KGS-MSTB 2,5/13	GMSTB 2,5/9-ST
KGS-MSTB 2,5/15	GMSTB 2,5/10-ST*
KGS-MSTB 2,5/16	GMSTB 2,5/11-ST
KGS-MSTB 2,5/18	GMSTB 2,5/12-ST*

KGG-MSTB 2,5 and KGS-MSTB 2,5 can be combined with GMSTB 2,5/...ST and GMSTB 2,5/...ST-7,62.

* The cable housing pitch is approximately 2 mm wider than that of the plugs.

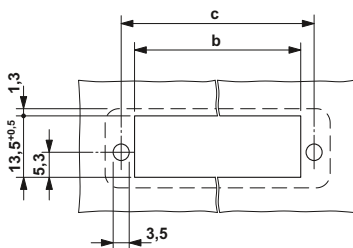

Sheet metal cutout dimensions for IC-DFR..., see page 350.

Number of positions	b	c
2	21.00	26.83
3	26.08	31.91
4	31.16	36.99
5	36.24	42.07
6	41.32	47.15
7	46.40	52.23
8	51.48	57.31
9	56.56	62.39
10	61.64	67.47
11	66.72	72.55
12	71.80	77.63
13	76.88	82.71
14	81.96	87.79
15	87.04	92.87
16	92.12	97.95

Sheet metal cutout dimensions/drilling diagrams/dimensional drawings

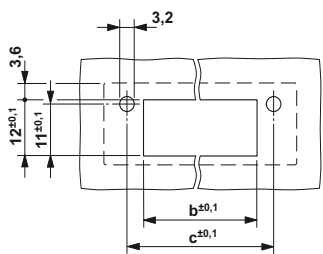

Sheet metal cutouts for DFK-MSTB 2,5/...-G, see page 352.

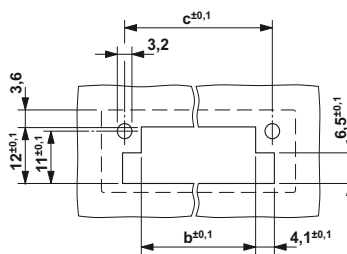

Sheet metal cutouts for DFK-MSTB 2,5/...-GF, see page 353.

Number of positions	5.0 pitch		5.08 pitch	
	b	c	b	c
2	12.7	20	13.18	20.32
3	17.7	25	18.26	25.40
4	22.7	30	23.34	30.48
5	27.7	35	28.42	35.56
6	32.7	40	33.50	40.64
7	37.7	45	38.58	45.72
8	42.7	50	43.66	50.80
9	47.7	55	48.74	55.88
10	52.7	60	53.82	60.96
11	57.7	65	58.90	66.04
12	62.7	70	63.98	71.12
13	67.7	75	69.06	76.20
14	72.7	80	74.14	81.28
15	77.7	85	79.22	86.36
16	82.7	90	84.30	91.44

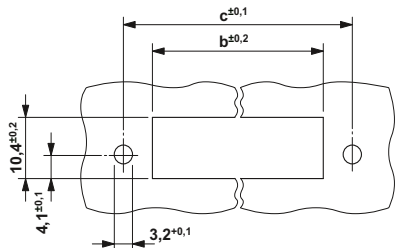

Sheet metal cutout dimensions for DFK-MSTB(V)A 2,5/...-G(F), see page 354.

Number of positions	DFK...-G		DFK...-GF	
	b	c	b	c
2	12.54	19.76	20.65	29.92
3	17.62	24.84	25.73	35.00
4	22.70	29.92	30.81	40.08
5	27.78	35.00	35.89	45.16
6	32.86	40.08	40.97	50.24
7	37.94	45.16	46.05	55.32
8	43.02	50.24	51.13	60.40
9	48.10	55.32	56.21	65.48
10	53.18	60.40	61.29	70.56
11	58.26	65.48	66.37	75.64
12	63.34	70.56	71.45	80.72
13	68.42	75.64	76.53	85.80
14	73.50	80.72	81.61	90.88
15	78.58	85.80	86.69	95.96
16	83.66	90.88	91.77	101.04

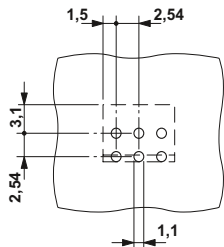

Drilling diagram for MPT 0,5/...-2,54, 2 to 3-pos. The 2 and 3-pos. versions have an additional locating pin (1.5 mm long) to support the mechanical load.

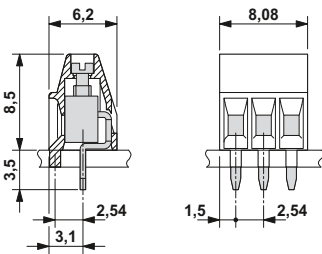

MPT 0,5/...-2,54, 2 to 3-pos., see page 83.

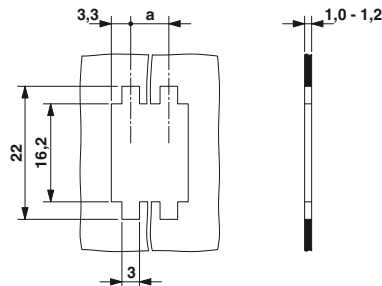

Panel feed-through for CIOC...FL, see page 65. Dimension a = 6.5 mm

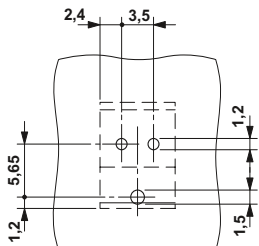

Drilling diagram for MKDSFW 1,5/2-3,5

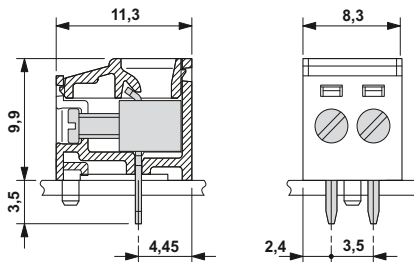

MKDSFW 1,5/2-3,5 with locating pin, see page 87.

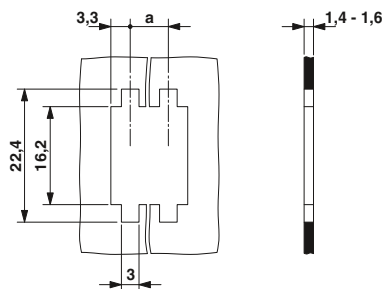

Panel feed-through for CIOC...FL, see page 65. Dimension a = 6.5 mm

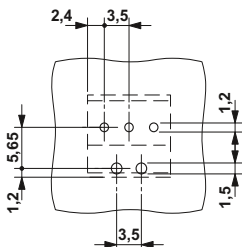

Drilling diagram for MKDSFW 1,5/3-3,5

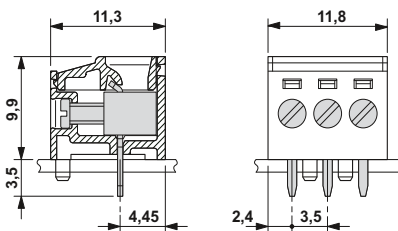

MKDSFW 1,5/3-3,5 with locating pin, see page 87.

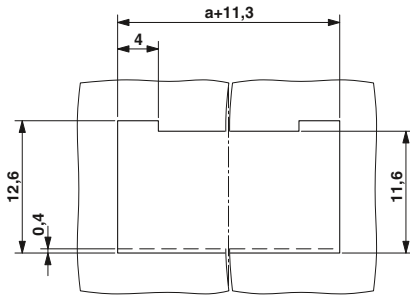

DMC 1,5/...-G1F-3,5-LR P20THR, see page 186.

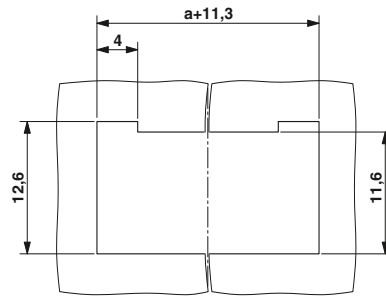

DMCV 1,5/...-G1F-3,5-LR P20THR, see page 187.

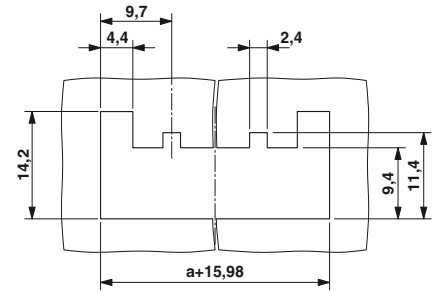

CC(V)2,5/...-GF-5,08-LR P26THR, see page 299.

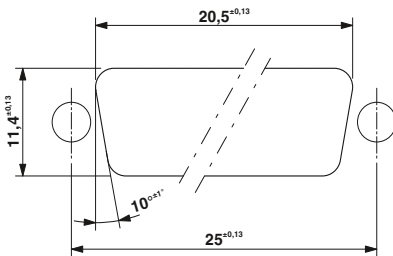

Mounting cutout according to DIN 41652-3
for panel thickness of up to 2.0 mm
PSC 1,5/3..M(-PE)
See page 251.

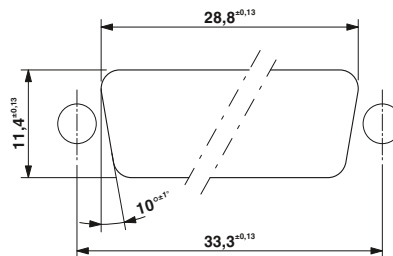

Mounting cutout according to DIN 41652-3
for panel thickness of up to 2.0 mm
PSC 1,5/5..M(-PE)
See page 251.

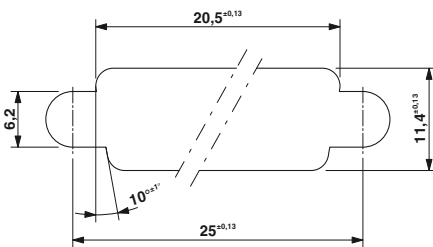

Mounting cutout according to DIN 41652-3
for panel thickness of up to 4.5 mm
PSC 1,5/3..M(-PE)
See page 251.

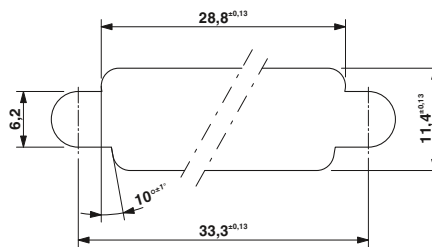

Mounting cutout according to DIN 41652-3
for panel thickness of up to 4.5 mm
PSC 1,5/5..M(-PE)
See page 251.

Quality in quantity



Integrated management system

The aim of the Phoenix Contact integrated management system is to coordinate all the requirements regarding products, processes, and organization.

Statutory and regulatory requirements, as well as those of international standards and our customers, are met and, in some cases, even exceeded in all phases of the product lifecycle.

In the Phoenix Contact management system, the integration of quality, environmental protection, and safety in the workplace is monitored each year for conformance by internationally recognized independent bodies. Certification in accordance with international standards ISO 9001, ISO 14001, and BS OHSAS 18001 is the result of our corporate philosophy of meeting the needs of our customers, staff, and environment as best as possible. They serve as the basis for innovative products with the familiar high Phoenix quality standard, actively practiced environmental protection, and responsibility in the field of occupational health and safety. It goes without saying that we integrate all further requirements of standards, international approvals or special customer requirements into our company processes.

This system provides a building block for the success of the Phoenix Contact Group and its products and services.

CE marking

The CE mark was introduced as an important instrument for the free movement of goods and services within the single European market. By attaching the mark to a product, the manufacturer confirms that it complies with all applicable European Union (EU) directives. EC directives describe the product properties with regard to device safety and avoiding danger. These are legally binding regulations of the European Union (EU). In other words, compliance

with the requirements is a **statutory condition for marketing the product within the EU.**

Where applicable, the products that our company currently manufactures fall within the scope of the following directives:

- 2006/95/EC
Electrical equipment designed for use within certain voltage limits (Low Voltage Directive)
- 2004/108/EC
Electromagnetic compatibility (EMC Directive)
- 2006/42/EC
Safety of machinery (Machinery Directive)
- 94/9/EC
Equipment and protective systems intended for use in potentially explosive areas (ATEX Directive 100a)
- 1999/5/EC
Radio and telecommunications terminal equipment (R&TTE)

The standards upon which the specified directives are based have been part of our standard of development for a long time. This guarantees conformance with European directives. The numbers of the directives indicate their version at the time of publication. In the event of changes to directives and/or standards, our products will undergo conformity assessment again in good time and a new declaration of conformity will be issued promptly. The current declarations for each product can also be found in our Download Center.

The EMC Directive occupies a special place among the European directives listed. It defines electromagnetic compatibility as a fundamental property of devices based on mandatory guidelines. European Law therefore acknowledges the electromagnetic compatibility of devices and systems as an important condition for error-free operation of machinery and systems. Phoenix Contact is one of the leading international companies in surge protection, and therefore possesses broad expertise in EMC. This expertise and the experience gained over years of developing and applying industrial interface and communication technology have resulted in our products having an extremely high standard of quality with regard to electromagnetic compatibility. It was with a view to providing other companies with this expertise that our associate company, Phoenix Testlab, was founded. Phoenix Testlab GmbH is an independent, accredited service provider offering EMC testing that conforms to European standards. At Phoenix Testlab,

devices are also tested with regard to their electrical safety, mechanical influences, and their behavior in relation to environmental influences. Furthermore, Phoenix Testlab is a “Notified Body” in accordance with EMC Directive 2004/108/EC and according to R&TTE Directive 1999/5/EC for radio and telecommunications terminal equipment. As a “Telecom Certification Body” (TCB), Phoenix Testlab may also approve these products for markets in the USA, Canada, and Japan.

Standards and regulations

All relevant standards and regulations are used as the basis for the development and maintenance of our products.

International standards are subject to continuous changes as a result of harmonization and new developments. In line with this process, the current version of all standards that are relevant to our products is documented on the Internet at www.phoenixcontact.net/products.

Online product information service on the web

Phoenix Contact's product range is growing constantly.

Due to our commitment to product monitoring, all products are subject to improvement.

The Internet is an ideal platform to quickly communicate new product developments and improvements to the market.

You can quickly access the relevant Phoenix Contact website for your region via www.phoenixcontact.com. Here, you will always find the latest overview of products, solutions, and services from Phoenix Contact. This includes technical documents, such as data sheets and user manuals, the latest driver and demo software, plus a means of contacting the appropriate contact person directly.

Note:

Subject to changes that serve the purpose of technical progress.

Connection cross section

The connection capacity for plug-in connectors and PCB terminal blocks is documented in the technical data. The connection capacity defines the conductor cross section which can be connected for conductors in solid (single and multi-strand) or stranded (fine-strand) versions. Cross section ranges are also specified for the use of ferrules. In addition, ranges where two conductors in solid and stranded versions are to be simultaneously connected are also mentioned.

Phoenix Contact PCB terminal blocks and plug-in connectors are designed to allow copper conductors to be connected to them untreated. "Special treatment" or

the use of ferrules is not required. "Special treatment" includes tin-plating the litz wires of a conductor, using cable lugs, bending the eyes, etc. However, it does not include straightening the conductor before inserting it into the terminal block or twisting a multi-strand conductor in order to consolidate its ends.

If ferrules are nevertheless used to protect stranded conductors against splicing, the connection capacity of the stranded conductor is generally reduced by one level. Conductors must not be soldered ("soldering all litz wires of a conductor together").

It is always recommended that you use Phoenix Contact CRIMPFOX crimping tools to crimp ferrules.

Structure and dimensions of connecting cables



Cross section [mm ²]	Single-strand		Multi-strand		Fine-strand		Gauge No. AWG	American Wire Gauge [AWG]					
	Diameter Max. dimension	Number of wires	Diameter Max. dimension	Number of wires (minimum number)	Diameter Max. dimension	Number of wires (guide value)		[∅ mm]	Solid wires [circ. miles]	[mm ²]	[∅ mm]	Stranded wires [circ. miles]	[mm ²]
0.2	0.5	1	-	-	-	-	24	0.51	404	0.21	-	-	-
0.5	0.9	1	1.1	7	1.1	16	20	0.81	1022	0.52	0.97	1111	0.56
0.75	1.0	1	1.2	7	1.3	24	18	1.02	1620	0.82	1.16	1600	0.82
1	1.2	1	1.4	7	1.5	32	(17)	1.15	2050	1.04			
-	-	-	-	-	-	-	16	1.29	2580	1.31	1.50	2580	1.32
1.5	1.5	1	1.7	7	1.8	30	(15)	1.45	3260	1.65			
-	-	-	-	-	-	-	14	1.63	4110	2.08	1.85	4100	2.09
2.5	1.9	1	2.2	7	2.3	50	(13)	1.83	5180	2.63			
-	-	-	-	-	-	-	12	2.05	6530	3.31	2.41	6500	3.32
4	2.4	1	2.7	7	2.9	56	(11)	2.30	8230	4.17			
-	-	-	-	-	-	-	10	2.59	10380	5.26	2.95	10530	5.37
6	2.9	1	3.3	7	3.9	84	(9)	2.91	13100	6.63			
-	-	-	-	-	-	-	8	3.26	16510	8.37	3.73	16625	8.48
10	3.7	1	4.2	7	5.1	80	(7)	3.67	20800	10.56	4.15	20820	10.55
-	-	-	-	-	-	-	6	4.12	26240	13.30	4.67	26250	13.39
16	4.6	1	5.3	7	6.3	126	(5)	4.62	33100	16.77	5.24	33100	16.77
-	-	-	-	-	-	-	4	5.19	41740	21.15	5.90	41650	21.24
25	-	-	6.6	7	7.8	196	3	5.83	52600	26.67	6.61	52630	26.67
35	-	-	7.9	7	9.2	276	2	6.54	66360	33.62	7.42	66150	33.74
-	-	-	-	-	-	-	1	7.35	83690	42.41	8.33	83706	42.69
50	-	-	9.1	19	11	396	0	8.25	105600	53.51	9.35	104640	53.36
70	-	-	11	19	13.1	360	00	9.27	133100	67.44	10.52	132300	67.47

Degrees of protection according to DIN EN 60529





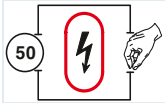



Definition:

IP (Ingress Protection) protection according to DIN EN 60529 is defined by two digits (e.g., IP54), the meaning of which is explained in the following tables.

Degree of protection against access to dangerous parts and against solid foreign objects

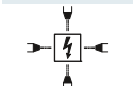
First digit	Short description	Example	Definition
0	Not protected		
1	Protected against solid foreign objects		Protected against touching dangerous parts with the back of the hand. Protection against ingress of solid foreign objects with $\varnothing > 50$ mm.
2	Protected against solid foreign objects with $\varnothing 12.5$ mm or more		Protected against touching dangerous parts with a finger. Protection against ingress of solid foreign objects with $\varnothing > 12.5$ mm.
3	Protected against solid foreign objects with $\varnothing 2.5$ mm or more		Protected against touching dangerous parts with a tool. Protection against ingress of solid foreign objects with $\varnothing > 2.5$ mm.
4	Protected against solid foreign objects with $\varnothing 1$ mm or more		Protected against touching dangerous parts with a wire. Protection against ingress of solid foreign objects with $\varnothing > 1$ mm.
5	Protected against dust		Protected against touching dangerous parts with a wire. The ingress of dust is not completely prevented, but dust may not enter in such an amount that the satisfactory operation of the device or its safety is impaired.
6	Dust-proof		Protected against touching dangerous parts with a wire. No ingress of dust.

Degree of protection against water

Second digit	Short description	Example	Definition
0	Not protected		
1	Protected against dripping water		Vertically falling drops shall have no effect.
2	Protected against dripping water if the housing is inclined at an angle of up to 15°		Vertically falling drops shall have no effect if the housing is inclined at an angle of up to 15° either side of the vertical.
3	Protected against spray water		Water that is sprayed at an angle of up to 60° either side of the perpendicular shall have no harmful effect.
4	Protected against splash water		Water that splashes against the housing from any direction shall have no harmful effect.
5	Protected against jet water		Water that is directed as a jet against the housing from every direction shall have no harmful effect.
6	Protected against powerful jet water		Water that is directed as a strong jet against the housing from every direction shall have no harmful effect.
7	Protected against the effect of temporary submersion in water		Water may not penetrate in a harmful quantity when the housing is temporarily submerged in water under standard pressure and time conditions.
8	Protected against the effect of continuous submersion in water		Water may not penetrate in a harmful quantity when the housing is submerged in water continuously under conditions to be agreed between the manufacturer and user.
9K	Protected against water during high-pressure and jet-stream cleaning		Water that is directed against the housing under extremely high pressure from every direction shall have no harmful effect. (Example: IP69K according to DIN 40050 Part 9)

Degree of protection, properties of plastic, approvals

For safety reasons, electrical equipment must be protected against external influences. This is the job of the housing, which protects electrical equipment against contact, the penetration of solid objects, dust, and moisture.

The following table contains possible combinations of degrees of protection according to DIN EN 60529 which can be practically applied to housing.

		Protection against water	No protection	Protection against vertically falling dripping water	Protection against dripping water if the housing is inclined at an angle of up to 15°	Protection against spray water from all directions, even when inclined at an angle of up to 60°	Protection against splash water from all directions	Protection against jet water from all directions	Protection against powerful jet water from all directions	Protection against temporary submersion	Protection against the effects of continuous submersion in water	Protected against water during high-pressure and jet-stream cleaning (DIN 40050-9)
Shock protection	Foreign object protection	IP0x	IP00	IPx1	IPx2	IPx3	IPx4	IPx5	IPx6	IPx7	IPx8	IPx9K
No shock protection	No protection against solid foreign objects	IP0x	IP00									
Back of hand safe	Protection against solid foreign objects > 50 mm Ø	IP1x	IP10	IP11	IP12							
Touch proof	Protection against solid foreign objects > 12.5 mm Ø	IP2x	IP20	IP21	IP22	IP23						
Protection against touching with tools, wires, etc. > 2.5 mm Ø	Protection against solid foreign objects > 2.5 mm Ø	IP3x	IP30	IP31	IP32	IP33						
Protection against touching with tools, wires, etc. > 1 mm Ø	Protection against solid foreign objects > 1.5 mm Ø	IP4x	IP40	IP41	IP42	IP43	IP44					
Protection against touching with tools, wires, etc. > 1 mm Ø	Protection against harmful dust accumulations inside the device	IP5x	IP50				IP54	IP55				
Protection against touching with tools, wires, etc. > 1 mm Ø	No ingress of dust	IP6x	IP60					IP65	IP66	IP67	IP68	IP69K

Degree of protection, properties of plastic, approvals

Our insulation housing is made from various thermoplastic materials. Depending on the application, the best-suited material is selected based on its electrical and mechanical properties.

All plastics used by Phoenix Contact are RoHS-compliant.

All plastics used at Phoenix Contact have been listed with UL (Underwriters Laboratories Inc.) in the USA.

Behavior of plastics under the influence of temperature (operating temperatures)

All plastics undergo thermal aging when they are subjected to heat over long periods. This process causes changes in the mechanical and electrical properties of the material. External influences, e.g., radiation, additional mechanical, chemical or electrical stresses, amplify this effect. All characteristic data included in the table has been determined using samples and so provides a good means of drawing comparisons between different plastics. However, applying these characteristics to an evaluation of molded plastic parts is only possible to a limited extent, and can only give the designer a rough guide when it comes to selecting a plastic material. This catalog uses RTI Elec according to UL746B as an assessment criterion for temperature resistance.

Insulation materials

Polyamide: PA and PA-GF

Polyamide has excellent electrical, mechanical, and chemical properties even at high operating temperatures. Brief peak temperatures up to approximately 200°C are permitted as a result of heat aging stabilization. The absorption of water makes the plastic flexible and resistant to breakage, even at low temperatures.

Fiber-reinforced polyamides feature greater rigidity and hardness as well as operating temperatures higher than those of non-reinforced materials.

Polyamide for high-temperature applications: PA HT and PA-GF HT

Special high-temperature-resistant types of polyamide are used in non-reinforced or fiberglass-reinforced variants for reflow applications. These high-temperature polyamides combine the excellent electrical properties of polyamide and the requirements of the reflow soldering process for temperature resistance.

Liquid crystal polymers: LCP GF

LCP combines high temperature stability with excellent dimensional stability and creeping resistance for products used in reflow processes. LCP has exceptional mechanical properties across a wide temperature range and a very low thermal expansion.

Polyester: PBT and PBT-GF

We use thermoplastic polyester in non-reinforced and fiberglass-reinforced variants for special applications which require increased dimensional and form stability.

In addition to the high operating temperature, the material is characterized by good mechanical strength and hardness, as well as excellent notched impact strength. PBT does not absorb moisture from its surroundings. PBT is therefore particularly suitable for strips, for example, which are soldered onto PCBs.

Polycarbonate: PC

Polycarbonate combines many advantages such as rigidity, impact strength, transparency, dimensional stability, good insulation properties, and resistance to heat.

The amorphous material only absorbs moisture to a very limited degree, and is used for items such as large, rigid electronic component housing.

In its transparent form, polycarbonate is particularly suitable for use as cover profiles or marking materials.

Acrylonitrile butadiene styrene: ABS

We use ABS for products which must have good impact and notched impact properties in addition to high mechanical stability and rigidity. The products are also characterized by their special surface quality and hardness.

ABS is suitable for coating metallic surfaces, e.g., nickel.

Polyvinyl chloride: PVC

While most thermoplastic materials are processed with injection molding using ready-to-use molding and extrusion material, PVC is processed as a powder in the extruder. This is why it is used in our profile products. PVC is also self-extinguishing without flame protection and has high mechanical strength but is notch-sensitive.

Polyoxymethylene: POM

Polyoxymethylene is a technical material that combines high rigidity with mechanical stability, excellent elastic properties, high tenacity, dimensional accuracy, and exceptional sliding friction behavior.

Polyethylene: PE

Polyethylene is characterized by excellent chemical resistance and electrical insulation properties. PE is thermoplastic and can therefore be processed using almost all procedures. Furthermore, PE has excellent tenacity even at low temperatures and a good elongation at break.

Polypropylene: PP

PP has higher rigidity, hardness, and stability and is more heat-resistant than PE. PP is not as tough at low temperatures, however.

Thermoplastic polyurethane: TPU and TPU-GF

TPU is characterized by excellent electrical properties, a good surface feel, a high degree of flexibility over a wide temperature range, and high resistance to wear. Thermoplastic polyurethanes are also elastic and low-temperature impact resistant.

In contrast to non-reinforced materials, fiberglass-reinforced TPU is characterized by high rigidity and hardness.

Irradiated ethylene-propylene-diene polymer/polypropylene: EPDM-PP

EPDM-PP is a polymer blend of PP and irradiated EPDM. EPDM-PP is a rubber-like material which can be processed using thermoplastic procedures. EPDM-PP combines high temperature resistance, a low compression set, and excellent resistance to abrasion and chemicals.

Acrylonitrile butadiene styrene rubber: NBR

NBR is a rubber with excellent resistance to aging. It also features excellent resistance to abrasion and low plastic flow. Its elasticity is lower than other rubbers.

Fluorinated rubber: FPM

FPM rubbers are characterized by very high temperature resistance, but behave less favorably at low temperatures than other rubbers.

Chlorine-butadiene rubber: CR

CR rubber stands out against other rubbers with its excellent resistance to weather and ozone.

Properties	Standard	Unit	PA	PA GF	PA HT	PA GF HT	PBT	PBT GF	LCP GF	PC	ABS	PVC	POM	PP	UP
RTI Elec ¹⁾	UL 746B	°C	≥ 105	≥ 105	≥ 105	≥ 105	≥ 105	≥ 105	≥ 130	≥ 105	≥ 80	≥ 50	≥ 105	65	50
Minimum temperature for use (without mechanical load)		°C	-40	-40	-40	-40	-40	-40	-40	-40	-40	-15	-40	-40	-40
Dielectric strength	IEC 60243-1/ DIN VDE 0303-21	kV/cm	600	400		> 200	400	400		> 300	850		850		
Creep resistance CTI...	IEC 60112/ DIN VDE 0303-1		600	400	≥ 250	225	600	225	175	175	600	600	600		
Creep resistance CTI...M	IEC 60112/ DIN VDE 0303-1		550	250			600	225		175	600	600	600		
Inflammability class	UL 94	HB - V0	V2, V0	HB, V0	V0	V0	V0	V0	V0	V2, V0		V0	HB	HB	HB
Tropical and termite resistance			Good	Good			Good			Good					

1) Possible at "≥" higher temperatures, but not recommended due to increased aging of plastics and insufficient current carrying capacity.

Properties	Standard	Unit	TPU	TPU GF	EPDM/PP
RTI Elec	UL 746B	°C	50	50	100
Minimum temperature for use (without mechanical load)		°C	-40	-40	-40
Dielectric strength	IEC 60243-1/ DIN VDE 0303-21	kV/cm	35	35	
Creep resistance CTI...	IEC 60112/ DIN VDE 0303-1		600	600	600
Creep resistance CTI...M	IEC 60112/ DIN VDE 0303-1		600		
Inflammability class	UL 94	HB - V0	V2	HB	HB
Chemical resistance	See chemical resistance table				

Properties	Standard	Unit	NBR	FPM	CR
Operating temperature		°C	£ 100	£ 200	£ 100
Minimum temperature for use (without mechanical load)		°C	-40	-25	-40
Dielectric strength	IEC 60243-1/ DIN VDE 0303-21	kV/cm	Not relevant as these are sealing materials		
Creep resistance CTI...	IEC 60112/ DIN VDE 0303-1				
Creep resistance CTI...M	IEC 60112/ DIN VDE 0303-1				
Inflammability class	UL 94	HB - V0			

Technical information

Degree of protection, properties of plastic, approvals

Chemicals	Plastics																	
	Concentration in %	Temperature in °C	PA 66/PA 6	PA 66 GF	PA 46 GF	PC GF	POM	NBR	PP	EPDM	PBT	PUR	PUR irradiated*	PVC-P (soft)	PE-LD	TPU	FPM (Viton)	CR (neoprene)
Acetaldehyde			0	0	0	-	0	-	-	0		+	+	+	0	0	-	0
Acetate			+	+	+	0	0	-	+	+	0	+	+	-	-	-	-	-
Acetic acid	20		-	-	0	0	0	-	+	+	0	0	0	0	+	-	-	0
Acetone		20	+				+	-	+	+	0	0	0	-	+	-	-	0
Acetophenone			+	+	+	0	0	-	+	0	0	+	+	-	-	-	-	-
Alcohols			0	0	0	0	+	0	+	+	+	+	+	-	+	+	0	+
Aldehyde			0	0	0	-	0	-	-	0		+	+	+	0	-	0	0
Alkalis, strong			0	-	-	-	+	-	+		+	-	-	+	0	0	-	-
Alkalis, weak			+	+	+	-	+	0	+	+	+	+	+	+	0	0	-	0
Amines			+	+	+	-	0	-	-	0	+	+	+	+	0	-	-	-
Ammonia	10	20	+				+	0	+	+	+	+	+	0	0	0	-	+
Benzaldehyde			0	0	0	-	0	-	-	0		+	+	+	0	0	-	0
Benzene		20	+	+	+	0	+	0	-	+	+	+	+	-	-	-	-	-
Benzol		50	+	+	+	+	0	-	0	-	+	0	0	-	0	-	0	-
Benzophenone		20	+	+	+	0	0	-	+	0	0	+	+	-	-	-	+	-
Boracic acid	100	20	0				0	+		+	+	0	0	0	+	+	+	+
Brake fluid		100	+				+	-		+	+	-	-	0	+	-	-	-
Butyric acid			-	-	0	0	+	0	+	+	+	0	0	+	+	-	0	0
Citric acid	10		+				+	+	+	+	+			+	+	+	+	+
Cyclohexanone			+	+	+	0	0	-	+	0	0	+	+	-	-	-	-	-
Detergent alkalis	2	100	0				+	+		+	+	+	+	-	+	+	+	0
Diesel oil			+				+	+	+	-	+	+	+	-	+	-	-	-
Diethylamine			+	+	+	-	0	-	-	0	+	+	+	+	-	-	-	-
Dimethylamine			+	+	+	-	0	-	-	0	+	+	+	+	0	-	-	-
Ester			+	+	+	0	-	-	-	0	+			-	+	-	-	-
Ethanol			0	0	0	0	+	0	+	+	+	+	+	-	+	+	+	+
Ether			+	+	+	-	0	-	0	0	+	+	+	-	0	+	+	-
Formaldehyde			0	0	0	-	0	-	-	0		+	+	+	0	0	+	0
Formic acid			-	-	0	0	+	-	+	+	0	0	-	-	0	0	+	+
Fuels			+	+	+	0	+	0	0	-	+	+	+	-	-	-	-	-
Gear oil		100	+				+	+		-	+	+	+	+	+	-	+	-
Glacial acetic acid		50		-	-	-	-	-	0	+	-	-	-	-	+	-	-	-
Greases			+	+	+	+	+	+	0	0				0	+	-	+	0
Halogens (fluorine, chlorine, bromine, iodine)			-	-	-	+	-	-	-	-	-	-	-	-	-	-	-	+
Hydraulic oil		20	+				0	+		-	+	+	+	-	+	-	+	-
Hydrocarbons, aliphatic			+	+	+	+	+	+	0	0	+	+	+	-	+	+	+	-
Hydrocarbons, aromatic			+	+	+	-	0	-	0	0	0	+	+	-	-	-	+	-
Hydrocarbons, chlorinated			0	0	0	-	+	-	-	-	0	-	-	-	-	-	+	-
Hydrocarbons, unsaturated chlorinated			0	0	0	-	+	-	-	-	0	0	0	-	-	-	+	-
Hydrochloric acid		20	-				-	0	+	0	0	-	-	-	+	0	+	0
Inorganic salt solutions			+	+	+	-	+	+	+	+	+	+	+	+	+	+	+	+
Kerosene		20	+				+				+	+	+	-	0	-	+	-
Ketones			+	+	+	0	0	-	+	0	0	+	+	-	-	-	-	-
Lactic acid	10	20	+				+	+	+	+	+	+	+	-	+	+	+	+
Machine oil			+				+				+	+	+	0	+	-	+	-
Metal chloride			+	+	+	-	+	+	+	+	+	+	+	+	+	+	+	+
Metal nitrate			+	+	+	-	+	+	+	+	+	+	+	+	+	+	+	+
Metal sulfate			+	+	+	-	+	+	+	+	+	+	+	+	+	+	+	+
Methanol			0	0	0	0	+	0	+	+	+	+	+	-	+	+	-	+
Methylamine			+	+	+	-	0	-	-	0	+	+	+	+	0	0	-	-
Mineral oil			+	+	+		+	+	+	+	+	+	+	-	+	-	+	-
Motor oil		120	+	+	+	0	+	+	+	-	+	+	+	-	+	-	+	-
Nitric acid	30	20	-	0	-	0	-	-	+	0	0	0	0	-	+	-	+	-
Nitrobenzene			0				0	-		0	+	-	-	-	0	+	0	-
Ozone			0	0	0	-	0	-	+	+	+	0	0	+	+	0	+	-
Potassium hydroxide solution			+	+	+	-	+	0	+		-	+	+	+	0	+	+	-
Propyl alcohol			0	0	0	0	+	0	+	+	+	+	+	-	+	+	+	+
Seawater		20	+	+	+	+	+	+	+	+	+	+	+	-	+	+	+	+
Sodium hydroxide solution		50	0	0	+	-	+	+	+	+	-	+	+	+	0	0	0	0
Sulfuric acid		50	0	0	0	-	0	-	-	+	+	0	0	+	+	0	+	-
Turpentine			0	0	0	+	-	+	-	+	-	0	0	-	-	-	+	-
UV resistance			+	+	+	0	0	-	-		+	+	+	0	0	+	+	
Water (dist.)		20												+				
Water, cold			+	+	+	+	+	+	+	+	+	+	+	+	+	+	+	+
Water, hot			-	-	-	-	+	+	+	+	-	+	+	+	+	0	+	0

- Not resistant
0 Moderately resistant
+ Resistant

* The irradiated PUR type is generally more resistant than the non-irradiated type. This cannot be quantified and must be checked in individual cases.

The information in the table has been gathered from the recommendations of our plastic suppliers.

Since individual operating conditions can also affect the usability of each product, this information should be used as a guide only.

For applications where no prior experience exists, we recommend that the user carries out preliminary tests.

Insulation coordination for equipment within low-voltage systems

Dimensioning of air and creepage distances according to DIN EN 60664-1/VDE 0110-1.

This part of the standard, based on IEC 60664, contains specifications for the insulation coordination of items of equipment in low-voltage systems. This part is applicable for items to be used at a height of up to 2000 m above sea level. This basic safety standard is primarily aimed at technical committees, and if suitable product directives are not available for an item, it can be used at one's own responsibility. International and European product standards cited in this catalog contain specifications for insulation coordination in accordance with DIN EN 60664/VDE 0110-1.

Insulation coordination

Insulation coordination includes the selection of electrical insulation properties for items as regards intended applications and ambient conditions. Separate requirements must be applied for air and creepage distances and for rigid insulation. The surge voltages to be expected, characteristics of surge protective devices, and pollution at the intended site must be considered when dimensioning clearances. Clearances are then dimensioned according to the external or internal surge voltages to be expected. Different surge voltages, grouped into categories, i.e., a value that determines an impulse withstand voltage, ascertain the required clearance directly. These surge voltage categories (I to IV) are mainly based on a statistical study, and are used for the items that are directly supplied by low-voltage networks. Definitions of the individual categories are provided below as an extract of DIN EN 60664/VDE 0110-1.

The clearances can be calculated according to Table 2 (minimum clearances) depending on the homogeneity level of the field between the electrodes (case A – non-homogeneous field, case B – homogeneous field).

Clearances according to case A are capable of withstanding the assigned surge voltages under all conditions. Items that are dimensioned according to case A can therefore be used without any further testing. Clearance values according to case B are based on ideal conditions. Clearance values which fall between case A and case B must be proven by means of a surge voltage test.

The voltages present, the properties of insulation materials, the pollution to be expected, and safety measures against pollution are considered when dimensioning creepage distances.

The effect of pollution is considered when determining the air and creepage distances according to three intensity levels (pollution degree 1 to 3).

The creepage distance is based on the rated voltage that is derived from the working voltage or nominal mains voltage. The minimum creepage distances are assigned to the rated voltages according to the pollution degree in Table 4.

If the respective product descriptions do not contain any additional specifications, the products presented in this catalog are dimensioned for surge voltage category III and pollution degree 3 according to this regulation (DIN EN 60664-1/VDE 0110-1).

Surge voltage categories I to IV

– Items in **surge voltage category IV** can be used at the terminal point of the installation.

Note: examples of such items include electricity meters and primary devices for overcurrent protection.

– Items in **surge voltage category III** can be used in fixed installations and are intended for such cases where there are special requirements for the reliability and availability of the items.

Note: examples of such items include switches in fixed installations and items for industrial use with permanent connection to the fixed installation.

– Items in **surge voltage category II** are power-consuming items that are supplied by the fixed installation.

Note: examples of such items include household appliances, portable tools, other domestic appliances, and similar devices.

– Items in **surge voltage category I** can be connected to circuits where measures have been taken to limit the surge voltages to a suitable lower value.

Pollution degrees 1 to 4

The following four pollution degrees have been defined for the micro-environment in order to determine air and creepage distances:

– Pollution degree 1

No contamination or only dry, non-conductive contamination is present. The contamination has no influence.

– Pollution degree 2

Only non-conductive contamination is present. Temporary conductivity due to condensation must occasionally be taken into consideration, however.

– Pollution degree 3

Conductive contamination or dry, non-conductive contamination is present which becomes conductive, since condensation is expected.

– Pollution degree 4

Permanent conductivity is present, caused by conductive dust, rain or moisture.

Insulation material

DIN EN 60664/VDE 0110-1 classifies insulation materials into four groups depending on their CTI values that were obtained using solution A in accordance with IEC 60112. These are:

Insulation material group I:

$600 \leq CTI$

Insulation material group II:

$400 \leq CTI < 600$

Insulation material group IIIa:

$175 \leq CTI < 400$

Insulation material group IIIb:

$100 \leq CTI < 175$

The comparative tracking index of the creepage distance must have been determined based on suitable samples using test solution A as specified in DIN IEC 60112.

The proof tracking index of the creepage distance (PTI) is used as proof of the creepage current properties of insulation materials.

Technical information

Degree of protection, properties of plastic, approvals

Dimensioning of clearances

Schematic for determining clearances

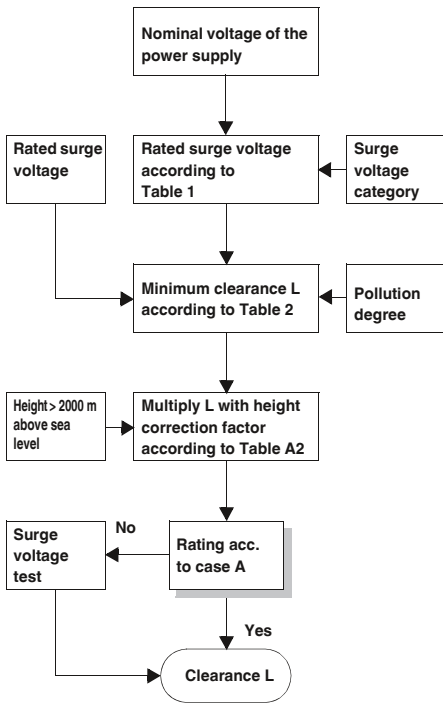

Height in m	Normal air pressure in kPa	Multiplication factor for gaps
2000	80.0	1.00
3000	70.0	1.14
4000	62.0	1.29
5000	54.0	1.48
6000	47.0	1.70
7000	41.0	1.95
8000	35.5	2.25
9000	30.5	2.62
10000	26.5	3.02
15000	12.0	6.67
20000	5.5	14.50

Rated surge voltages for items that are directly supplied by the low-voltage network (extract from Table 1)

Nominal voltage of the power supply system ¹⁾ (mains) acc. to IEC 60038 ³⁾ [V]		Conductor-neutral conductor voltage derived from the total nominal AC voltage or nominal DC voltage [V]	Rated surge voltage ²⁾ [V] Surge voltage category ⁴⁾			
Three-phase	Single-phase		I	II	III	IV
	120 to 240	50	330	500	800	1500
		100	500	800	1500	2500
		150	800	1500	2500	4000
230/400 277/480		300	1500	2500	4000	6000
400/690		600	2500	4000	6000	8000
1000		1000	4000	6000	8000	12000

¹⁾ Refer to Appendix B for application in existing deviating low-voltage networks and their nominal voltages.

²⁾ Items with this rated surge voltage may be used in systems in accordance with IEC 60364-4-443.

³⁾ The slash, i.e., /, indicates a three-phase 4-conductor system. The lower value is the conductor-to-neutral conductor voltage, whereas the higher value is the conductor-to-conductor voltage. When only one value is specified, it refers to a three-phase 3-conductor system, and indicates the conductor-to-conductor voltage.

⁴⁾ Refer to 2.2.2.1.1 for an explanation of surge voltage categories.

Minimum clearances for surge voltages (extract from Table 2)

Required impulse withstand voltage ^{1) 5)}	Condition A Non-homogeneous field (refer to 1.3.15)			Condition B Homogeneous field (refer to 1.3.14)		
	Pollution degree ⁶⁾			Pollution degree ⁶⁾		
	1 [mm]	2 [mm]	3 [mm]	1 [mm]	2 [mm]	3 [mm]
0.33 ²⁾	0.01	0.2 ^{3) 4)}	0.8 ⁴⁾	0.01	0.2 ^{3) 4)}	0.8 ⁴⁾
0.40	0.02			0.02		
0.5 ²⁾	0.04			0.04		
0.60	0.06			0.06		
0.80 ²⁾	0.10			0.10		
1.0	0.15		0.15			
1.2	0.25	0.25	0.2			
1.5 ²⁾	0.5	0.5	0.3	0.3		
2.0	1.0	1.0	0.45	0.45		
2.5 ²⁾	1.5	1.5	0.6	0.6		
3.0	2.0	2.0	0.8	0.8		
4.0 ²⁾	3	3	3	1.2	1.2	1.2
5.0	4	4	4	1.5	1.5	1.5
6.0 ²⁾	5.5	5.5	5.5	2	2	2
8.0 ²⁾	8	8	8	3	3	3
10	11	11	11	3.5	3.5	3.5
12 ²⁾	14	14	14	4.5	4.5	4.5
15	18	18	18	5.5	5.5	5.5
20	25	25	25	8	8	8
25	33	33	33	10	10	10
30	40	40	40	12.5	12.5	12.5
40	60	60	60	17	17	17
50	75	75	75	22	22	22
60	90	90	90	27	27	27
80	130	130	130	35	35	35
100	170	170	170	45	45	45

¹⁾ This voltage is:

- For function insulation: the highest surge voltage expected for the clearance
- For basic insulation, if influenced directly or considerably by surge voltages from the low-voltage network: the item's rated surge voltage
- For a different basic insulation: the highest surge voltage possible in the circuit

²⁾ Preferred values

³⁾ For PCBs, the values of pollution degree 1 are applicable, except that no deviation below the value of 0.04 mm is permitted, as specified in Table 4.

⁴⁾ Minimum clearances for pollution degrees 2 and 3 are based on the corresponding creepage distances. This resistance is reduced due to the effects of humidity.

⁵⁾ Values can be interpolated for parts or circuits within items that are subjected to surge voltages.

⁶⁾ The distances for pollution degree 4 are equal to those for pollution degree 3, except that the minimum clearance is 1.6 mm.

Current carrying capacity

Standard IEC 60947-7-1/
EN 60947-7-1/DIN VDE 0611-1 specifies the test currents for the individual conductor cross sections listed in the adjacent table. The corresponding currents are listed with the connection data for the individual products.

Test currents according to IEC 60947-7-1/EN 60947-7-1, Table 5

Rated cross section	[mm ²]	0.2	0.5	0.75	1.0	1.5	2.5	4	6	10	16
Test current	[A]	4	6	9	13.5	17.5	24	32	41	57	76
Rated cross section	[mm ²]	25	35	50	70	95	120	150	185	240	300
Test current	[A]	101	125	150	192	232	269	309	353	415	520

Dimensioning of creepage distances

Schematic for determining creepage distances

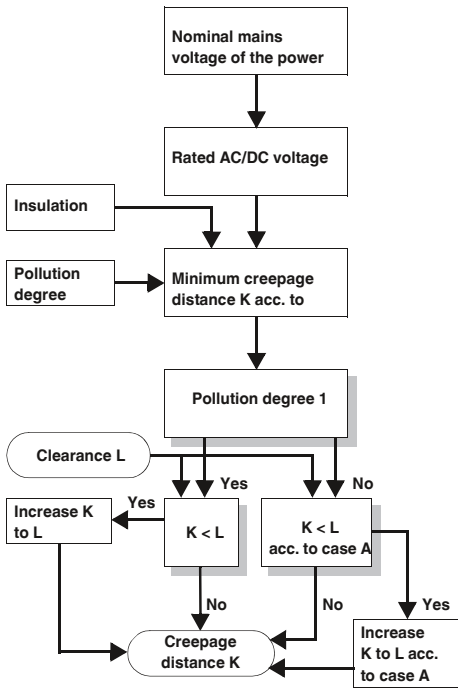

Single-phase 3 or 2-conductor AC or DC voltage systems (extract from Table 3a)

Nominal voltage of the power supply system (mains) *)	Voltages for Table 4	
	for conductor-conductor insulation 1)	for conductor-ground insulation 1)
	All systems	3-conductor systems center point grounded
[V]	[V]	[V]
12.5	12.5	-
24	25	-
25	32	-
30	50	-
42	-	-
48	-	-
50 **)	-	-
60	63	-
30 - 60	63	32
100 **)	100	-
110	125	-
120	-	-
150 **)	160	-
220	250	-
110 - 220	250	125
220 - 240	-	-
300 **)	320	-
220 - 440	500	250
600 **)	630	-
480 - 960	1000	500
1000 **)	1000	-

1) Conductor-ground insulation levels for non-grounded systems or those grounded through impedance correspond to conductor-conductor insulation levels as the operating voltage of every conductor to ground can, in practice, reach the conductor-conductor voltage. This is due to the fact that the actual voltage to ground is determined by the insulation resistance and the capacitive reactance of each conductor to ground. A low (but permissible) insulation resistance of one conductor can thereby practically ground it and increase the other two to conductor-conductor voltage to ground.

*) Refer to 2.2.1 for correlation with the rated voltage.

**) These values correspond to the values in Table 1.

Three-phase 4 or 3-conductor AC voltage systems (extract from Table 3b)

Nominal voltage of the power supply system (mains) *)	Voltages for Table 4		
	for conductor-conductor insulation	Insulation for conductor-ground	
	All systems	Three-phase 4-conductor systems with grounded neutral conductor 2)	Three-phase 3-conductor systems non-grounded 1) or conductor grounded
[V]	[V]	[V]	[V]
60	63	32	63
110/120/127	125	80	125
150 **)	160	-	160
208	200	125	200
220/230/240	250	160	250
300 **)	320	-	320
380/400/415	400	250	400
440	500	250	400
480/500	500	320	500
575	630	400	630
600 **)	630	-	630
660/690	630	400	630
720/830	800	500	800
960	1000	630	1000
1000 **)	1000	-	1000

1) Conductor-ground insulation levels for non-grounded systems or those grounded through impedance correspond to conductor-conductor insulation levels as the operating voltage of every conductor to ground can, in practice, reach the conductor-conductor voltage. This is due to the fact that the actual voltage to ground is determined by the insulation resistance and the capacitive reactance of each conductor to ground. A low (but permissible) insulation resistance of one conductor can thereby practically ground it and increase the other two to conductor-conductor voltage to ground.

2) For items designed for use in three-phase 4-conductor and three-phase 3-conductor systems, grounded as well as non-grounded, only the values for 3-conductor systems may be used.

*) Refer to 2.2.1 for correlation with the rated voltage.

**) These values correspond to the values in Table 1.

Creepage distances to prevent failures occurring due to creepage (extract from Table 4)







































Voltage 1) r.m.s. value	Minimum creepage distances									
	Printed circuits		Pollution degree							
	Pollution degree		1	2			3			
	All insulation material groups	All insulation material groups except IIIb	All insulation material groups	Insulation material group			Insulation material group			
[V]	[mm]	[mm]	[mm]	I [mm]	II [mm]	III [mm]	I [mm]	II [mm]	III 2) [mm]	
10	0.025	0.04	0.08	0.40	0.40	0.40	1.00	1.00	1.00	
12.5	0.025	0.04	0.09	0.42	0.42	0.42	1.05	1.05	1.05	
16	0.025	0.04	0.10	0.45	0.45	0.45	1.10	1.10	1.10	
20	0.025	0.04	0.11	0.48	0.48	0.48	1.20	1.20	1.20	
25	0.025	0.04	0.125	0.50	0.50	0.50	1.25	1.25	1.25	
32	0.025	0.04	0.14	0.53	0.53	0.53	1.30	1.30	1.30	
40	0.025	0.04	0.16	0.56	0.80	1.10	1.4	1.6	1.8	
50	0.025	0.04	0.18	0.60	0.85	1.20	1.5	1.7	1.9	
63	0.040	0.63	0.20	0.63	0.90	1.25	1.6	1.8	2.0	
80	0.063	0.10	0.22	0.67	0.95	1.3	1.7	1.9	2.1	
100	0.10	0.16	0.25	0.71	1.00	1.4	1.8	2.0	2.2	
125	0.16	0.25	0.28	0.75	1.05	1.5	1.9	2.1	2.4	
160	0.25	0.40	0.32	0.80	1.1	1.6	2.0	2.2	2.5	
200	0.40	0.63	0.42	1.00	1.4	2.0	2.5	2.8	3.2	
250	0.56	1.00	0.56	1.25	1.8	2.5	3.2	3.6	4.0	
320	0.75	1.60	0.75	1.60	2.2	3.2	4.0	4.5	5.0	
400	1.00	2.00	1.00	2.00	2.8	4.0	5.0	5.6	6.3	
500	1.30	2.50	1.30	2.50	3.6	5.0	6.3	7.1	8.0	
630	1.80	3.20	1.8	3.2	4.5	6.3	8.0	9	10.0	
800	2.40	4.00	2.4	4.0	5.6	8.0	10.0	11	12.5	
1000	3.20	5.00	3.2	5.0	7.1	10	12.5	14	16.0	
1250			4.2	6.3	9	12.5	16	18	20	
1600			5.6	8	11	16	20	22	25	
2000			7.5	10	14	20	25	28	32	
2500			10	12.5	18	25	32	36	40	
3200			12.5	16	22	32	40	45	50	
4000			16	20	28	40	50	56	63	
5000			20	25	36	50	63	71	80	
6300			25	32	45	63	80	90	100	
8000			32	40	56	80	100	110	125	
10000			40	50	71	100	125	140	160	

- 1) This voltage is:
- a) For function insulation: the working voltage
 - b) For basic and additional insulation of a circuit supplied directly by the low-voltage network: either the voltage selected from Table 3a or 3b on the basis of the rated voltage of the equipment or the rated insulation voltage
 - c) For basic and additional insulation of systems, equipment and internal circuits which are not supplied directly from the mains: the highest r.m.s. value of the voltage that, within the bounds of the rated data, can occur in the system, the equipment or the internal circuit, when supplied with rated voltage and in the case of the most unfavorable combination of operating conditions.
- 2) For pollution degree 3, insulation material group IIIb is not recommended for use if voltages are greater than 630 V.

Technical information

Degree of protection, properties of plastic, approvals

Overview of approval bodies and safety marks

Certification bodies and approvals		Country code	Explosion protection		Country code	Ship classification societies		Country code
	IECEE CB Scheme (in combination with certifying body)	International		FM Approvals	US		Bureau Veritas	FR
CCA	CENELEC Certification Agreement (CCA inspection report) (in combination with certifying body)	EU		DEKRA Certification B.V.	NL		Germanischer Lloyd AG	DE
	Canadian Standards Association (CSA)	CA		Physikalisch-Technische Bundesanstalt	DE		Lloyd's Register EMEA	GB
 	Underwriters Laboratories Inc. (UL)	US		QS Schaffhausen	CH		Nippon Kaiji Kyokai	JP
 	Underwriters Laboratories Inc. (UL) - UL approval for Canada -	CA		VTT Expert Services Oy	FI		Det Norske Veritas	NO
 	Underwriters Laboratories Inc. (UL) Combined logo - UL approval for the USA and Canada -	US CA		IBExU Institut für Sicherheitstechnik GmbH	DE		Polski Rejestr Statków	PL
	INSIEME PER LA QUALITA'E LA SICUREZZA	IT		TÜV Rheinland do Brasil	BR		Russian Maritime Register of Shipping	RU
	Gosudarstvenne Komitet Standartov (GOST)	RU		Underwriters Laboratories Inc. (UL)	US		Korean Register of Shipping	KR
	DEKRA Certification B.V.	NL		TÜV Nord	DE		American Bureau of Shipping	US
	Österreichischer Verband für Elektrotechnik	AT		DEKRA EXAM GmbH	DE			
	South African Bureau of Standards	ZA						
	electrosuisse SEV Verband für Elektro-, Energie- und Informationstechnik	CH						
 	Verband Deutscher Elektrotechniker e.V. (VDE) - Approval of drawings - Reports with production monitoring	DE						
 	Berufsgenossenschaft (BG) GS - Geprüfte Sicherheit	DE						
	TÜV Rheinland Industrie Service GmbH	DE						

Note:

Subject to changes that serve the purpose of technical progress.

Shock protection

Touch proof

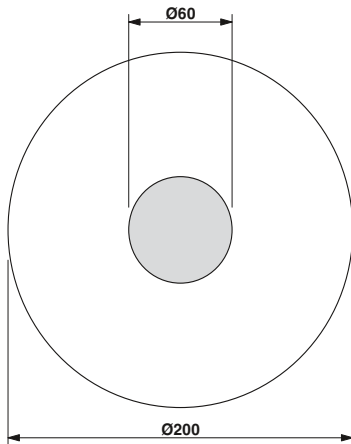

Back of hand safety

Example: pressure actuation

The accident prevention regulations BGV A 2 issued by the German employer's liability insurance association for precision mechanics and electrical engineering apply to the operators of electrical systems and are aimed at the prevention of electrical accidents by means of special safety requirements.

These regulations contain specifications regarding the safety distances for work, operation, and occasional handling in the proximity of "live parts" in low-voltage systems up to 1000 V ~ or 1500 V –.

Work with live parts is only permitted once they have been de-energized. Operational activities are only permitted in the vicinity of live parts if these parts are de-energized or are protected against direct contact (§ 6). The following safety measures are applicable when working in close proximity to live parts:

- Provision of the de-energized state for the duration of the work
- Ensure shock protection is in place in the form of covers or barriers during the work
- Assurance that proximity limits will not be violated (§ 7)

The term "occasional handling" has been introduced for the operation of elements such as pushbuttons, rocker arms or rotary buttons in the proximity of live parts.

In VDE 0105-1, this is covered by "operation with partial protection against direct contact".

Detailed specifications for "occasional handling" can be found in DIN EN 50274. This specifies to what degree live parts in the proximity of operating elements are to be protected against contact. The basis for this is the definition of a "protection area for occasional handling"; this is the area into which the user must reach in order to handle the machine.

The most important thing is that an area formed by an even envelope curve 30 mm in radius must surround the live parts. This area must be **touch proof**, i.e., the live parts of the electrical device must not be within reach of the VDE test finger in accordance with IEC 60529/ DIN VDE 0470-1 (test finger).



Back of hand safety is specified for the "rest of the area" up to 100 mm around the operating element. **Back of hand safety** means that when a force of 50 N is applied to a ball with a diameter of 50 mm, this does not come into contact with the live parts of the equipment. No special measures for shock protection are provided outside this area.

Note: systems and equipment that are operated with SELV up to 25 V ~ or 60 V – are considered to be protected against direct contact.

According to BGV A 2, there is no need to test the condition of the system prior to initial startup if the company has confirmation from the manufacturer or installer that the electrical systems and equipment conform to BGV A 2. The confirmation required relates to systems and equipment that have been installed and are ready for operation and can only be issued by the installer or installation company. The manufacturer of the electrical equipment can only issue a confirmation that products have been produced in accordance with the relevant electrotechnical regulations stipulated in BGV A 2. The installer must bear this in mind when selecting the equipment to be used.

In the field of connection technology, Phoenix Contact offers a wide range of products that are touch proof or that can be protected against contact using covers. Depending on the conditions, all of this must be taken into account when selecting the individual types of terminal block and accessories.

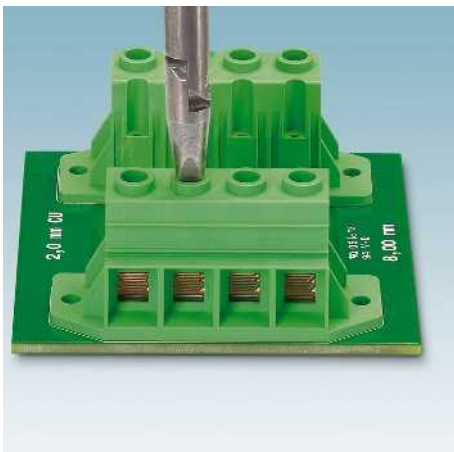

Base and derating curve, test setup, ambient temperature

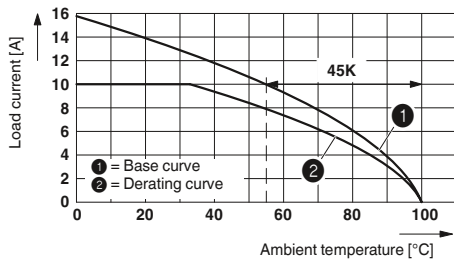

Current carrying capacity

The technical data shows a rated current strength that does not impair functionality when the ambient temperature and corresponding conductor cross section are taken into account, or does not cause thermal damage to the product. Here, “ambient temperature” refers to the temperature measured in the immediate vicinity of the terminal block. In the application, it is necessary to consider heat sources near the terminal block (e.g., high-load resistors or similar) in particular, which affect the terminal block through radiant heat and/or heat conduction over the conductive path.

EN 60998-1 “Connecting devices for low-voltage circuits for household and similar purposes” limits the permissible heat increase of the conductive parts of terminal points to 45 K. When the upper temperature limit of the insulation material – here, always assumed to be 100°C – is taken into account, these values yield a current carrying capacity dependent on the ambient temperature: the “base curve”. Here, the current carrying capacity curve documented according to DIN EN 60512-5-2 shows a current for plug-in connectors that has been reduced by a derating factor of 0.8 from the base curve: the derating curve. For Phoenix Contact PCB terminal blocks, the base curve can be used for the current carrying capacity without the derating factor.

For the application-specific representation of the current carrying capacity of plug-in connectors, determining the derating curve based on various numbers of positions and conductor cross sections has proven itself beyond the method presented in the standard.

Tightening torque of terminal block screws

Tightening torque values have been determined in accordance with IEC 60999-1 for PCB terminal blocks and plug-in connectors with screw connection. The tightening torques provide a secure connection between the conductor and terminal block. They also take into account the stability of the soldering pin and soldering spot, the function of which must not be impaired during the clamping progress.

Anti-rotation protection

2 and 3-pos. terminal blocks in particular are often subjected to high tightening torques, which cannot be absorbed by a few solder pins. Usually these terminal blocks must be supported during conductor connection (held with one hand, housing support). If this is not possible, versions with additional anti-rotation pins are available for many terminal blocks.

Extract from IEC 60999, Table 4

The torque according to IEC and the recommended tightening torque for Phoenix Contact terminal blocks are specified.

Thread	Head screw with slot	
	Torque [Nm]	Recommended tightening torque [Nm]
M2.5 (M2.6)	0.4	0.4 - 0.5
M3	0.5	0.5 - 0.6
M3.5	0.8	0.8 - 1.0
M4	1.2	1.2 - 1.5

Current carrying capacity of conductive paths

The current carrying capacity of the conductive paths on the PCB is decisive for device safety and performance. The width and thickness of a conductive path depend to a large extent on the current strength, the resultant heat loss, the maximum temperature of the PCB, and the ambient temperature.

The conductive path dimensions are defined in IEC 60326-3/DIN IEC 60326-3 taking into consideration the above-mentioned factors based on current load curves. Both the conductive path width and thickness are taken into consideration in this representation. The following layer thickness values have become established for the conductive path thickness: 35 μm , 70 μm , and 105 μm , whereby 35 μm and 70 μm are recommended in industrial applications.

Regulations

The international and national standards listed below are of particular relevance for the production of PCBs. Extracts from these standards have been included in various sections, but we recommend that you obtain copies of the standards quoted: IEC 60664/IEC 60664A/DIN VDE 0110-1 – Insulation coordination for equipment within low-voltage systems; basic specifications

IEC 60664/IEC 60664A/VDE 0110-2 – Insulation coordination for equipment within low-voltage systems; dimensioning of air and creepage distances

IEC 60097/EN 60097/DIN EN 60097 – Grid systems for printed circuits

IEC 60249-1/EN 60249-1/DIN EN 60249-1 – Base materials for printed circuits - Part 1: Test methods (and other individual regulations)

IEC 60326-3/DIN IEC 60326-3

– PCBs - Part 3: Design and use of PCBs

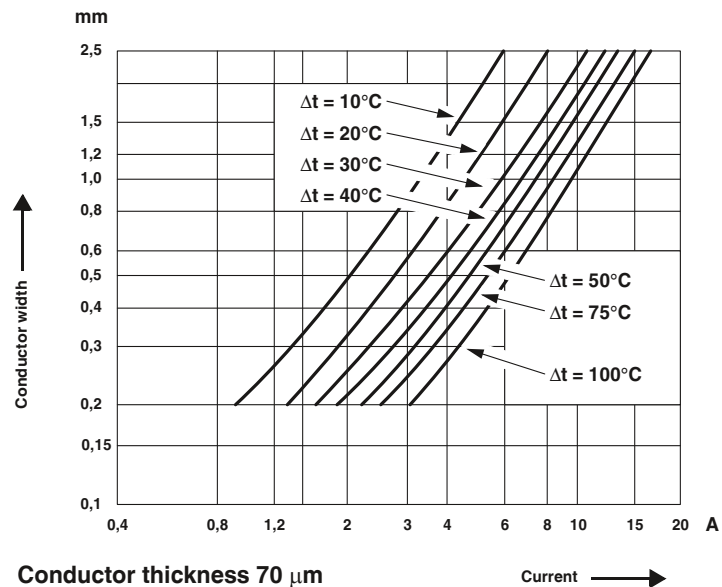
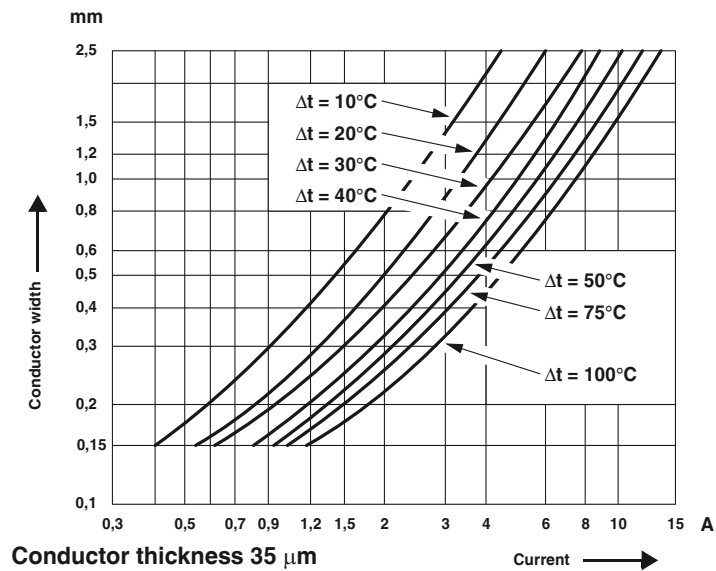

Δt = Heating of the PCB as a result of the current

Index

Alphabetical

Type	Order No.	Page	Type	Order No.	Page	Type	Order No.	Page	Type	Order No.	Page
A			AI 35 -25 RD	3200713	835	CC 2,5/ 8-GF-5,08-LR P26THR	1792685	299	CCDN 2,5/ 7-G1F-5,08 P26 THR	1753352	307
A 0,25- 5	3202465	834	AI 50 -20 BU	3200454	835	CC 2,5/ 9-GF-5,08 P26THR	1954760	299	CCDN 2,5/ 8-G1 P26 THR	1734339	306
A 0,25- 7	3202478	834	AI 50 -25 BU	3200726	835	CC 2,5/ 9-GF-5,08 P26THR88	1954870	303	CCDN 2,5/ 8-G1-5,08 P26 THR	1753190	306
A 0,34- 7	3009202	834	AI 70 -20 YE	3201848	835	CC 2,5/ 9-GF-5,08-LR P26THR	1792698	299	CCDN 2,5/ 8-G1F P26 THR	1734504	307
A 0,5- 6	3200218	834									
A 0,5- 8	3202481	834	AI 95 -25 RD	3201853	835	CC 2,5/10-GF-5,08 P26THR	1954773	299	CCDN 2,5/ 8-G1F-5,08 P26 THR	1753365	307
A 0,5-10	3202494	834	AI120 -27 BU	3201822	835	CC 2,5/10-GF-5,08 P26THR88	1954883	303	CCDN 2,5/ 9-G1 P26 THR	1734342	306
A 0,75- 6	3200221	834	AP-ES	5022685	758	CC 2,5/10-GF-5,08-LR P26THR	1792708	299	CCDN 2,5/ 9-G1-5,08 P26 THR	1753200	306
A 0,75- 8	3202504	834				CC 2,5/11-GF-5,08 P26THR	1954786	299	CCDN 2,5/ 9-G1F P26 THR	1734517	307
A 0,75-10	3200234	834	B			CC 2,5/11-GF-5,08 P26THR88	1954896	303	CCDN 2,5/ 9-G1F-5,08 P26 THR	1753378	307
A 1 - 6	3200247	834	B-STIFT	1051993	728	CC 2,5/11-GF-5,08-LR P26THR	1792711	299	CCDN 2,5/10-G1 P26 THR	1734355	306
A 1 - 8	3202517	834	BC 107,6 DKL R KMGY	2896173	699	CCA 2,5/ 2-G-5,08 P26THR	1954919	298	CCDN 2,5/11-G1 P26 THR	1734368	306
A 1 - 10	3200250	834	BC 107,6 DKL S TRANS	2896131	699	CCA 2,5/ 2-G-5,08 P26THR32	1955031	302	CCDN 2,5/11-G1-5,08 P26 THR	1753226	306
			BC 107,6 OT U11 KMGY	2896076	699	CCA 2,5/ 2-G-5,08 RNP26THR	1955167	299	CCDN 2,5/11-G1F P26 THR	1734533	307
A 1,5- 7	3200263	834	BC 107,6 OT U22 KMGY	2896089	699	CCA 2,5/ 2-G-5,08 RNP26THR32	1955277	303	CCDN 2,5/11-G1F-5,08 P26 THR	1753394	307
A 1,5-10	3200276	834	BC 107,6 UT HBUS BK	2896270	699	CCA 2,5/ 3-G-5,08 P26THR	1954922	298	CCDN 2,5/12-G1 P26 THR	1734371	306
A 1,5-12	3202588	834	BC 161,6 DKL R KMGY	2278539	700	CCA 2,5/ 3-G-5,08 P26THR32	1955044	302	CCDN 2,5/12-G1-5,08 P26 THR	1753239	306
A 1,5-15	3202591	834	BC 161,6 DKL S TRANS	2278542	700	CCA 2,5/ 3-G-5,08 RNP26THR	1955170	299	CCDN 2,5/12-G1F P26 THR	1734546	307
A 1,5-18	3202601	834	BC 161,6 OT 00020 KMGY	2201450	701	CCA 2,5/ 3-G-5,08 RNP26THR32	1955280	303	CCDN 2,5/12-G1F-5,08 P26 THR	1753404	307
A 2,5- 7	3200289	834	BC 161,6 OT 00022 KMGY	2201454	701	CCA 2,5/ 4-G-5,08 P26THR	1954935	298	CCDN 2,5/13-G1 P26 THR	1734384	306
A 2,5-12	3200292	834	BC 161,6 OT 00200 KMGY	2201451	701	CCA 2,5/ 4-G-5,08 P26THR56	1955057	302	CCDN 2,5/13-G1-5,08 P26 THR	1753242	306
A 2,5-18	3202821	834	BC 161,6 OT U11 KMGY	2278513	700	CCA 2,5/ 4-G-5,08 RNP26THR	1955183	299	CCDN 2,5/13-G1F P26 THR	1734559	307
A 4 - 9	3200302	834	BC 161,6 OT U22 KMGY	2278526	700	CCA 2,5/ 4-G-5,08 RNP26THR56	1955293	303	CCDN 2,5/13-G1F-5,08 P26 THR	1753417	307
A 4 -12	3200315	834	BC 161,6 UT HBUS BK	2278500	700	CCA 2,5/ 5-G-5,08 P26THR	1954948	298	CCDN 2,5/14-G1 P26 THR	1734397	306
A 4 -18	3202834	834	BC 17,6 BS U11 KMGY	2896186	698	CCA 2,5/ 5-G-5,08 P26THR56	1955060	302	CCDN 2,5/14-G1-5,08 P26 THR	1753255	306
A 6 -10	3202520	834	BC 17,6 BS U22 KMGY	2896199	698	CCA 2,5/ 5-G-5,08 RNP26THR	1955196	299	CCDN 2,5/14-G1F P26 THR	1734562	307
A 6 -12	3200328	834	BC 17,8 DKL R KMGY	2896144	698	CCA 2,5/ 5-G-5,08 RNP26THR56	1955303	303	CCDN 2,5/14-G1F-5,08 P26 THR	1753420	307
A 10 -12	3200331	834	BC 17,8 DKL S TRANS	2896102	698	CCA 2,5/ 6-G-5,08 P26THR	1954951	298	CCDN 2,5/15-G1 P26 THR	1734407	306
A 10 -18	3200344	834	BC 17,8 OTU MKD50 KMGY	2279732	698	CCA 2,5/ 6-G-5,08 P26THR56	1955073	302	CCDN 2,5/15-G1-5,08 P26 THR	1753268	306
A 16 -12	3200425	834	BC 17,8 UT HBUS BK	2896241	698	CCA 2,5/ 6-G-5,08 RNP26THR	1955206	299	CCDN 2,5/15-G1F P26 THR	1734575	307
A 25 -12	3200357	834	BC 35,6 BS U11 KMGY	2896209	698	CCA 2,5/ 6-G-5,08 RNP26THR56	1955316	303	CCDN 2,5/15-G1F-5,08 P26 THR	1753433	307
A 25 -15	3200360	834	BC 35,6 BS U22 KMGY	2896212	698	CCA 2,5/ 7-G-5,08 P26THR	1954977	298	CCDN 2,5/16-G1 P26 THR	1734410	306
A 25 -18	3200373	834	BC 35,6 DKL R KMGY	2896157	698	CCA 2,5/ 7-G-5,08 P26THR56	1955086	302	CCDN 2,5/16-G1-5,08 P26 THR	1753271	306
A 25 -20	3200386	834	BC 35,6 DKL S TRANS	2896115	698	CCA 2,5/ 7-G-5,08 RNP26THR	1955219	299	CCDN 2,5/16-G1F P26 THR	1734588	307
A 35 -18	3200399	834	BC 35,6 OT U11 KMGY	2896034	698	CCA 2,5/ 7-G-5,08 RNP26THR56	1955329	303	CCDN 2,5/16-G1F-5,08 P26 THR	1753446	307
AI 0,25- 6 YE	3200409	834	BC 35,6 OT U22 KMGY	2896047	698	CCA 2,5/ 8-G-5,08 P26THR	1954980	298	CCV 2,5/ 2-GF-5,08 P26THR	1955633	301
AI 0,25- 8 YE	3203024	835	BC 35,6 UT HBUS BK	2896254	698	CCA 2,5/ 8-G-5,08 P26THR56	1955099	302	CCV 2,5/ 2-GF-5,08 P26THR32	1955743	305
AI 0,25- 8 YE	3203037	835	BC 53,6 BS U11 KMGY	2896225	699	CCA 2,5/ 8-G-5,08 RNP26THR	1955222	299	CCV 2,5/ 2-GF-5,08-LR P26THR	1792737	301
AI 0,5- 6 WH	3200687	835	BC 53,6 BS U22 KMGY	2896238	699	CCA 2,5/ 8-G-5,08 RNP26THR88	1955332	303	CCV 2,5/ 3-GF-5,08 P26THR	1955646	301
AI 0,5- 8 WH	3200014	835	BC 53,6 DKL R KMGY	2896432	699	CCA 2,5/ 9-G-5,08 P26THR	1954993	298	CCV 2,5/ 3-GF-5,08 P26THR56	1955756	305
AI 0,5- 8 WH-1000	3200881	835	BC 53,6 DKL S TRANS	2896445	699	CCA 2,5/ 9-G-5,08 P26THR88	1955109	302	CCV 2,5/ 3-GF-5,08-LR P26THR	1792740	301
AI 0,5-10 WH	3201275	835	BC 53,6 OT U11 KMGY	2896416	699	CCA 2,5/ 9-G-5,08 RNP26THR	1955235	299	CCV 2,5/ 4-GF-5,08 P26THR	1955659	301
AI 0,5-12 WH	3200506	835	BC 53,6 OT U22 KMGY	2896429	699	CCA 2,5/ 9-G-5,08 RNP26THR88	1955345	303	CCV 2,5/ 4-GF-5,08 P26THR56	1955769	305
AI 0,75- 6 GY	3200690	835	BC 53,6 UT HBUS BK	2896403	699	CCA 2,5/10-G-5,08 P26THR	1955002	298	CCV 2,5/ 4-GF-5,08-LR P26THR	1792753	301
AI 0,75- 8 GY	3200519	835	BC 71,6 DKL R KMGY	2896160	699	CCA 2,5/10-G-5,08 P26THR88	1955112	302	CCV 2,5/ 5-GF-5,08 P26THR	1955662	301
AI 0,75- 8 GY-1000	3200894	835	BC 71,6 DKL S TRANS	2896128	699	CCA 2,5/10-G-5,08 RNP26THR	1955248	299	CCV 2,5/ 5-GF-5,08 P26THR56	1955772	305
AI 0,75-10 GY	3201288	835	BC 71,6 OT U11 KMGY	2896050	699	CCA 2,5/10-G-5,08 RNP26THR88	1955358	303	CCV 2,5/ 5-GF-5,08-LR P26THR	1792766	301
AI 0,75-12 GY	3200849	835	BC 71,6 OT U22 KMGY	2896063	699	CCA 2,5/11-G-5,08 P26THR	1955015	298	CCV 2,5/ 6-GF-5,08 P26THR	1955675	301
AI 1 - 6 RD	3200742	835	BC 71,6 UT HBUS BK	2896267	699	CCA 2,5/11-G-5,08 P26THR88	1955125	302	CCV 2,5/ 6-GF-5,08-LR P26THR56	1955785	305
AI 1 - 8 RD	3200030	835	BL2-2,54/16-ST	2896335	698	CCA 2,5/11-G-5,08 RNP26THR	1955251	299	CCV 2,5/ 6-GF-5,08-LR P26THR	1792779	301
AI 1 - 8 RD-1000	3200904	835	BMKLT 14X12 WH	0813789	685	CCA 2,5/11-G-5,08 RNP26THR88	1955361	303	CCV 2,5/ 7-GF-5,08 P26THR	1955688	301
AI 1 -10 RD	3200182	835	BMKLT 19X12 WH	0813792	686	CCA 2,5/12-G-5,08 P26THR	1955028	298	CCV 2,5/ 7-GF-5,08 P26THR88	1955798	305
AI 1 -12 RD	3200674	835	BMKLT 31,5X12 WH	0813802	687	CCA 2,5/12-G-5,08 P26THR88	1955138	302	CCV 2,5/ 7-GF-5,08-LR P26THR	1792782	301
AI 1,5- 6 BK	3200755	835	BMKLT 41,5X12 WH	0813815	688	CCA 2,5/12-G-5,08 RNP26THR	1955264	299	CCV 2,5/ 8-GF-5,08 P26THR	1955691	301
AI 1,5- 8 BK	3200043	835				CCA 2,5/12-G-5,08 RNP26THR88	1955374	303	CCV 2,5/ 8-GF-5,08 P26THR88	1955808	305
AI 1,5- 8 BK-1000	3200917	835				CCDN 2,5/ 2-G1 P26 THR	1734280	306	CCV 2,5/ 8-GF-5,08-LR P26THR	1792795	301
AI 1,5-10 BK	3200195	835				CCDN 2,5/ 2-G1-5,08 P26 THR	1753132	306	CCV 2,5/ 9-GF-5,08 P26THR	1955701	301
AI 1,5-12 BK	3201482	835				CCDN 2,5/ 2-G1F P26 THR	1734449	307	CCV 2,5/ 9-GF-5,08 P26THR88	1955811	305
AI 1,5-18 BK	3200056	835	CC 2,5/ 2-GF-5,08 P26THR	1954692	299	CCDN 2,5/ 2-G1F-5,08 P26 THR	1753307	307	CCV 2,5/ 9-GF-5,08-LR P26THR	1792805	301
AI 2,5- 8 BU	3200522	835	CC 2,5/ 2-GF-5,08 P26THR32	1954809	303	CCDN 2,5/ 3-G1 P26 THR	1734287	306	CCV 2,5/10-GF-5,08 P26THR	1955714	301
AI 2,5- 8 BU-1000	3200920	835	CC 2,5/ 2-GF-5,08-LR P26THR	1792627	299	CCDN 2,5/ 3-G1-5,08 P26 THR	1753145	306	CCV 2,5/10-GF-5,08 P26THR88	1955824	305
AI 2,5-10 BU	3202533	835	CC 2,5/ 3-GF-5,08 P26THR	1954702	299	CCDN 2,5/ 3-G1F P26 THR	1734452	307	CCV 2,5/10-GF-5,08-LR P26THR	1792818	301
AI 2,5-12 BU	3200962	835	CC 2,5/ 3-GF-5,08 P26THR56	1954812	303	CCDN 2,5/ 3-G1F-5,08 P26 THR	1753310	307	CCV 2,5/11-GF-5,08 P26THR	1955727	301
AI 2,5-18 BU	3200580	835	CC 2,5/ 3-GF-5,08-LR P26THR	1792630	299	CCDN 2,5/ 4-G1 P26 THR	1734290	306	CCV 2,5/11-GF-5,08 P26THR88	1955837	305
AI 4 -10 GY	3200535	835	CC 2,5/ 4-GF-5,08 P26THR	1954715	299	CCDN 2,5/ 4-G1-5,08 P26 THR	1753158	306	CCV 2,5/11-GF-5,08-LR P26THR	1792821	301
AI 4 -12 GY	3200959	835	CC 2,5/ 4-GF-5,08 P26THR56	1954825	303	CCDN 2,5/ 4-G1F P26 THR	1734465	307	CCV 2,5/12-GF-5,08 P26THR	1955730	301
AI 4 -18 GY	3200593	835	CC 2,5/ 4-GF-5,08-LR P26THR	1792643	299	CCDN 2,5/ 4-G1F-5,08 P26 THR	1753323	307	CCV 2,5/12-GF-5,08 P26THR88	1955840	305
AI 6 -12 YE	3200548	835	CC 2,5/ 5-GF-5,08 P26THR	1954728	299	CCDN 2,5/ 5-G1 P26 THR	1734300	306	CCV 2,5/12-GF-5,08-LR P26THR	1792834	301
AI 6 -18 YE	3200603	835	CC 2,5/ 5-GF-5,08 P26THR56	1954838	303	CCDN 2,5/ 5-G1-5,08 P26 THR	1753161	306	CCV 2,5/ 5-GF-5,08 P26THR56	1955785	305
AI 10 -12 RD	3200551	835	CC 2,5/ 5-GF-5,08-LR P26THR	1792656	299						

Type	Order No.	Page	Type	Order No.	Page	Type	Order No.	Page	Type	Order No.	Page
CCVA 2,5/4-G-5,08 RNP26THR	1956108	301	CM125-LG/H 12,5/BO/DB BK	2943055	737	DFK-IPC 16/8-GFU-10,16	1702879	579	DFK-MSTB 2,5/8-G	0707060	352
CCVA 2,5/4-G-5,08RNP26THR88	1956218	305	CM125-LG/H 35/BO BK	2942904	737	DFK-IPC 16/8-GFU-SH-10,16	1702950	581	DFK-MSTB 2,5/8-G-5,08	0707057	352
CCVA 2,5/5-G-5,08 P26THR	1955882	300	CM125-LG/H 35/BO/DB BK	2941691	737	DFK-IPC 16/8-GU-10,16	1702552	579	DFK-MSTB 2,5/8-GF	0710086	353
CCVA 2,5/5-G-5,08 P26THR88	1955992	304	CM125-LG/H 35/BO/DB/GH BK	2941840	737	DFK-IPC 16/8-ST-10,16	1703755	584	DFK-MSTB 2,5/8-GF-5,08	0710235	353
CCVA 2,5/5-G-5,08 RNP26THR	1956111	301	CM175-LG/H 35/BO/DB/GH BK	2941507	737	DFK-IPC 16/8-STF-10,16	1703836	585	DFK-MSTB 2,5/9-G	0707167	352
CCVA 2,5/5-G-5,08RNP26THR88	1956221	305	CM200-LG/H 55/BO/DB/GH BK	2941853	737	DFK-IPC 16/8-STF-SH-10,16	1703991	585	DFK-MSTB 2,5/9-G-5,08	0707303	352
CCVA 2,5/6-G-5,08 P26THR	1955895	300	CMS-P1-MZB	5144699	804	DFK-IPC 16/9-G-10,16	1702484	578	DFK-MSTB 2,5/9-GF	0710099	353
CCVA 2,5/6-G-5,08 P26THR88	1956001	304	CMS-P1-MZBF	5144709	806	DFK-IPC 16/9-GF-10,16	1702808	579	DFK-MSTB 2,5/9-GF-5,08	0710248	353
CCVA 2,5/6-G-5,08 RNP26THR	1956124	301	CP-MSTB	1734634	674	DFK-IPC 16/9-GF-SH-10,16	1703043	580	DFK-MSTB 2,5/10-G	0707170	352
CCVA 2,5/6-G-5,08RNP26THR88	1956234	305	CR MSTBO-G1	2199618	674	DFK-IPC 16/9-GFU-10,16	1702882	579	DFK-MSTB 2,5/10-G-5,08	0707316	352
CCVA 2,5/7-G-5,08 P26THR	1955905	300	CR-MSTB	1734401	718	DFK-IPC 16/9-GFU-SH-10,16	1702963	581	DFK-MSTB 2,5/10-GF	0710109	353
CCVA 2,5/7-G-5,08 P26THR88	1956014	304	CS-SKBI	2204082	776	DFK-IPC 16/9-GU-10,16	1702565	579	DFK-MSTB 2,5/10-GF-5,08	0710251	353
CCVA 2,5/7-G-5,08 RNP26THR	1956137	301				DFK-IPC 16/9-ST-10,16	1703768	584	DFK-MSTB 2,5/11-G	0707183	352
CCVA 2,5/7-G-5,08RNP26THR88	1956247	305				DFK-IPC 16/9-STF-10,16	1703849	585	DFK-MSTB 2,5/11-G-5,08	0707329	352
CCVA 2,5/8-G-5,08 P26THR	1955918	300				DFK-IPC 16/9-STF-SH-10,16	1704000	585	DFK-MSTB 2,5/11-GF	0710112	353
CCVA 2,5/8-G-5,08 P26THR88	1956027	304	D			DFK-IPC 35 HC/ 2-GF-15,00	1784965	593	DFK-MSTB 2,5/11-GF-5,08	0710264	353
CCVA 2,5/8-G-5,08 RNP26THR	1956140	301	DB 50-90 BK	2820916	722	DFK-IPC 35 HC/ 3-GF-15,00	1784978	593	DFK-MSTB 2,5/12-G	0707196	352
CCVA 2,5/8-G-5,08RNP26THR88	1956250	305	DB 50-90 GY	2820929	722	DFK-IPC 35 HC/ 4-GF-15,00	1784981	593	DFK-MSTB 2,5/12-G-5,08	0707332	352
CCVA 2,5/9-G-5,08 P26THR	1955921	300	DFK 4	0708357	639	DFK-IPC 35 HC/ 5-GF-15,00	1784994	593	DFK-MSTB 2,5/12-GF	0710125	353
CCVA 2,5/9-G-5,08 P26THR88	1956030	304	DFK 4-PE	0708315	639	DFK-IPC 35 HC/ 6-GF-15,00	1785003	593	DFK-MSTB 2,5/12-GF-5,08	0710277	353
CCVA 2,5/9-G-5,08 RNP26THR	1956153	301	DFK 4-SI(5X20) BK	0709301	639	DFK-IPC 16/2-G-10,16	1703056	581	DFK-MSTB 2,5/13-G	0707206	352
CCVA 2,5/9-G-5,08RNP26THR88	1956263	305	DFK 4-SI(6,3X32) BK	0708344	639	DFK-IPC 16/2-GF-10,16	1703218	581	DFK-MSTB 2,5/13-G-5,08	0707345	352
CCVA 2,5/10-G-5,08 P26THR	1955934	300	DFK 5-9,5	0706605	641	DFK-IPC 16/3-G-10,16	1703069	581	DFK-MSTB 2,5/13-GF	0710138	353
CCVA 2,5/10-G-5,08 P26THR88	1956043	304	DFK-IPC 16/2-G-10,16	1702413	578	DFK-IPC 16/3-GF-10,16	1703221	581	DFK-MSTB 2,5/13-GF-5,08	0710280	353
CCVA 2,5/10-G-5,08 RNP26THR	1956166	301	DFK-IPC 16/2-GF-10,16	1702730	579	DFK-IPC 16/4-G-10,16	1703072	581	DFK-MSTB 2,5/14-G	0707219	352
CCVA 2,5/10-G-5,08RNP26THR88	1956276	305	DFK-IPC 16/2-GF-SH-10,16	1702976	580	DFK-IPC 16/4-GF-10,16	1703234	581	DFK-MSTB 2,5/14-G-5,08	0707358	352
CCVA 2,5/11-G-5,08 P26THR	1955947	300	DFK-IPC 16/2-GFU-10,16	1702811	579	DFK-IPC 16/5-G-10,16	1703085	581	DFK-MSTB 2,5/14-GF	0710141	353
CCVA 2,5/11-G-5,08 P26THR88	1956056	304	DFK-IPC 16/2-GFU-SH-10,16	1702895	581	DFK-IPC 16/5-GF-10,16	1703247	581	DFK-MSTB 2,5/14-GF-5,08	0710293	353
CCVA 2,5/11-G-5,08 RNP26THR	1956179	301	DFK-IPC 16/2-GU-10,16	1702497	579	DFK-IPC 16/6-G-10,16	1703098	581	DFK-MSTB 2,5/15-G	0707222	352
CCVA 2,5/11-G-5,08RNP26THR88	1956289	305	DFK-IPC 16/2-ST-10,16	1703690	584	DFK-IPC 16/6-GF-10,16	1703250	581	DFK-MSTB 2,5/15-G-5,08	0707361	352
CCVA 2,5/12-G-5,08 P26THR	1955950	300	DFK-IPC 16/2-STF-10,16	1703771	585	DFK-IPC 16/7-G-10,16	1703108	581	DFK-MSTB 2,5/15-GF	0710154	353
CCVA 2,5/12-G-5,08 P26THR88	1956069	304	DFK-IPC 16/2-STF-SH-10,16	1703933	585	DFK-IPC 16/7-GF-10,16	1703263	581	DFK-MSTB 2,5/15-GF-5,08	0710303	353
CCVA 2,5/12-G-5,08 RNP26THR	1956182	301	DFK-IPC 16/3-G-10,16	1702426	578	DFK-IPC 16/8-G-10,16	1703111	581	DFK-MSTB 2,5/16-G	0707235	352
CCVA 2,5/12-G-5,08RNP26THR88	1956292	305	DFK-IPC 16/3-GF-10,16	1702743	579	DFK-IPC 16/8-GF-10,16	1703276	581	DFK-MSTB 2,5/16-G-5,08	0707374	352
CIOC 3-1-FV-A	1701551	67	DFK-IPC 16/3-GF-SH-10,16	1702989	580	DFK-IPC 16/9-G-10,16	1703124	581	DFK-MSTB 2,5/16-GF	0710167	353
CIOC 3-20-1,2-F	1701400	65	DFK-IPC 16/3-GFU-10,16	1702824	579	DFK-IPC 16/9-GF-10,16	1703289	581	DFK-MSTB 2,5/16-GF-5,08	0710316	353
CIOC 3-20-1,2-M	1701393	65	DFK-IPC 16/3-GFU-SH-10,16	1702905	581	DFK-IPC 35 HC/ 2-GF-15,00	1793600	593	DFK-MSTBA 2,5/2-G-5,08	1898839	354
CIOC 3-20-1,6-F	1701402	65	DFK-IPC 16/3-GU-10,16	1702507	579	DFK-IPC 35 HC/ 3-GF-15,00	1793613	593	DFK-MSTBA 2,5/2-GF-5,08	1898981	355
CIOC 3-20-1,6-FL	1701404	65	DFK-IPC 16/3-ST-10,16	1703700	584	DFK-IPC 35 HC/ 4-GF-15,00	1793626	593	DFK-MSTBA 2,5/3-G-5,08	1898842	354
CIOC 3-20-1,6-M	1701394	65	DFK-IPC 16/3-STF-10,16	1703784	585	DFK-IPC 35 HC/ 5-GF-15,00	1793639	593	DFK-MSTBA 2,5/3-G-5,08	1898994	355
CIOC 3-20-2,0-F	1701403	65	DFK-IPC 16/3-STF-SH-10,16	1703946	585	DFK-IPC 35 HC/ 6-GF-15,00	1793642	593	DFK-MSTBA 2,5/4-G-5,08	1898855	354
CIOC 3-20-2,0-M	1701396	65	DFK-IPC 16/4-G-10,16	1702439	578	DFK-MC 1,5/2-GF-3,81	1829345	240	DFK-MSTBA 2,5/4-GF-5,08	1899003	355
CIOC 3-24-1,0-F	1701397	65	DFK-IPC 16/4-GF-10,16	1702756	579	DFK-MC 1,5/3-GF-3,81	1829358	240	DFK-MSTBA 2,5/5-G-5,08	1898868	354
CIOC 3-24-1,0-M	1701390	65	DFK-IPC 16/4-GF-SH-10,16	1702992	580	DFK-MC 1,5/4-GF-3,81	1829361	240	DFK-MSTBA 2,5/5-GF-5,08	1899016	355
CIOC 3-24-1,2-F	1701398	65	DFK-IPC 16/4-GFU-10,16	1702837	579	DFK-MC 1,5/5-GF-3,81	1829374	240	DFK-MSTBA 2,5/6-G-5,08	1898871	354
CIOC 3-24-1,2-M	1701391	65	DFK-IPC 16/4-GFU-SH-10,16	1702918	581	DFK-MC 1,5/6-GF-3,81	1829387	240	DFK-MSTBA 2,5/6-GF-5,08	1899029	355
CIOC 3-24-1,6-F	1701399	65	DFK-IPC 16/4-GU-10,16	1702510	579	DFK-MC 1,5/7-GF-3,81	1829390	240	DFK-MSTBA 2,5/7-G-5,08	1898884	354
CIOC 3-24-1,6-M	1701392	65	DFK-IPC 16/4-ST-10,16	1703713	584	DFK-MC 1,5/8-GF-3,81	1827596	240	DFK-MSTBA 2,5/7-GF-5,08	1899032	355
CIOC 3-4-FV	1701552	67	DFK-IPC 16/4-STF-10,16	1703797	585	DFK-MC 1,5/9-GF-3,81	1829400	240	DFK-MSTBA 2,5/8-G-5,08	1898897	354
CIOC 4-1-FH-SMD-B R32	1701322	67	DFK-IPC 16/4-STF-SH-10,16	1703959	585	DFK-MC 1,5/10-GF-3,81	1829413	240	DFK-MSTBA 2,5/8-GF-5,08	1899045	355
CIOC 4-1-FV-A	1701388	67	DFK-IPC 16/5-G-10,16	1702442	578	DFK-MC 1,5/11-GF-3,81	1829426	240	DFK-MSTBA 2,5/9-G-5,08	1898907	354
CIOC 4-1-LIH	1701362	69	DFK-IPC 16/5-GF-10,16	1702769	579	DFK-MC 1,5/12-GF-3,81	1829439	240	DFK-MSTBA 2,5/9-GF-5,08	1899058	355
CIOC 4-1-LIV	1701375	69	DFK-IPC 16/5-GF-SH-10,16	1703001	580	DFK-MC 1,5/13-GF-3,81	1829442	240	DFK-MSTBA 2,5/10-G-5,08	1898910	354
CIOC 4-18-LI	1701359	69	DFK-IPC 16/5-GFU-10,16	1702840	579	DFK-MC 1,5/14-GF-3,81	1829455	240	DFK-MSTBA 2,5/10-GF-5,08	1899061	355
CIOC 4-20-1,2-F	1701171	65	DFK-IPC 16/5-GFU-SH-10,16	1702921	581	DFK-MC 1,5/15-GF-3,81	1829468	240	DFK-MSTBA 2,5/11-G-5,08	1898923	354
CIOC 4-20-1,2-FL	1701294	65	DFK-IPC 16/5-GU-10,16	1702523	579	DFK-MC 1,5/16-GF-3,81	1829471	240	DFK-MSTBA 2,5/11-GF-5,08	1899074	355
CIOC 4-20-1,2-M	1701058	65	DFK-IPC 16/5-ST-10,16	1703726	584	DFK-MSTB 2,5/2-G	0707109	352	DFK-MSTBA 2,5/12-G-5,08	1898936	354
CIOC 4-20-1,6-F	1701197	65	DFK-IPC 16/5-STF-10,16	1703807	585	DFK-MSTB 2,5/2-G-5,08	0707248	352	DFK-MSTBA 2,5/12-GF-5,08	1899087	355
CIOC 4-20-1,6-FL	1701317	65	DFK-IPC 16/5-STF-SH-10,16	1703962	585	DFK-MSTB 2,5/2-GF	0710028	353	DFK-MSTBA 2,5/13-G-5,08	1898949	354
CIOC 4-20-1,6-M	1701074	65	DFK-IPC 16/6-G-10,16	1702455	578	DFK-MSTB 2,5/2-GF-5,08	0710170	353	DFK-MSTBA 2,5/13-GF-5,08	1899090	355
CIOC 4-20-2,0-F	1701210	65	DFK-IPC 16/6-GF-10,16	1702772	579	DFK-MSTB 2,5/3-G	0707112	352	DFK-MSTBA 2,5/14-G-5,08	1898952	354
CIOC 4-20-2,0-FL	1701333	65	DFK-IPC 16/6-GF-SH-10,16	1703014	580	DFK-MSTB 2,5/3-G-5,08	0707251	352	DFK-MSTBA 2,5/14-GF-5,08	1899100	355
CIOC 4-20-2,0-M	1701090	65	DFK-IPC 16/6-GFU-10,16	1702853	579	DFK-MSTB 2,5/3-GF	0710031	353	DFK-MSTBA 2,5/15-G-5,08	1898965	354
CIOC 4-24-1,0-F	1701113	65	DFK-IPC 16/6-GFU-SH-10,16	1702934	581	DFK-MSTB 2,5/3-GF-5,08	0710183	353	DFK-MSTBA 2,5/15-GF-5,08	1899113	355
CIOC 4-24-1,0-FL	1701236	65	DFK-IPC 16/6-GU-10,16	1702536	579	DFK-MSTB 2,5/4-G	0707125	352	DFK-MSTBA 2,5/16-G-5,08	1898978	354
CIOC 4-24-1,0-M	1700994	65	DFK-IPC 16/6-ST-10,16	1703739	584	DFK-MSTB 2,5/4-G-5,08	0707264	352	DFK-MSTBA 2,5/16-GF-5,08	1899126	355
CIOC 4-24-1,2-F	1701139	65	DFK-IPC 16/6-STF-10,16	1703810	585	DFK-MSTB 2,5/4-GF	0710044	353	DFK-MSTBA 2,5/2-G-5,08	1899139	355
CIOC 4-24-1,2-FL	1701252										

Index

Alphabetical

Type	Order No.	Page	Type	Order No.	Page	Type	Order No.	Page	Type	Order No.	Page
DFK-MSTBVA 2,5/9-G-5,08	1899207	355	DFK-PC 5/4-G-7,62	1727605	544	DFK-PC 5/12-STF-SH-7,62	1716823	549	DFK-PCV 6-16/6-GF-10,16	1702293	577
DFK-MSTBVA 2,5/9-GF-5,08	1899359	355	DFK-PC 5/4-GF-7,62	1727715	545	DFK-PC 6-16/2-G-10,16	1701456	574	DFK-PCV 6-16/7-G-10,16	1702141	577
DFK-MSTBVA 2,5/10-G-5,08	1899210	355	DFK-PC 5/4-GF-SH-7,62	1716085	546	DFK-PC 6-16/2-GU-10,16	1701537	575	DFK-PCV 6-16/7-GF-10,16	1702303	577
DFK-MSTBVA 2,5/10-GF-5,08	1899362	355	DFK-PC 5/4-GFU-7,62	1727935	545	DFK-PC 6-16/2-GF-SH-10,16	1701935	576	DFK-PCV 6-16/8-G-10,16	1702154	577
DFK-MSTBVA 2,5/11-G-5,08	1899223	355	DFK-PC 5/4-GFU-SH-7,62	1716195	547	DFK-PC 6-16/2-GFU-10,16	1701692	575	DFK-PCV 6-16/8-GF-10,16	1702316	577
DFK-MSTBVA 2,5/11-GF-5,08	1899375	355	DFK-PC 5/4-GU-7,62	1727825	545	DFK-PC 6-16/2-GFU-SH-10,16	1702015	577	DFK-PCV 6-16/9-G-10,16	1702167	577
DFK-MSTBVA 2,5/12-G-5,08	1899236	355	DFK-PC 5/4-ST-7,62	1716522	548	DFK-PC 6-16/2-GU-10,16	1701618	575	DFK-PCV 6-16/9-GF-10,16	1702329	577
DFK-MSTBVA 2,5/12-GF-5,08	1899388	355	DFK-PC 5/4-STF-7,62	1716632	549	DFK-PC 6-16/3-G-10,16	1701469	574	DFK-DP-4	0708616	639
DFK-MSTBVA 2,5/13-G-5,08	1899249	355	DFK-PC 5/4-STF-SH-7,62	1716742	549	DFK-PC 6-16/3-GF-10,16	1701540	575	DFMC 1,5/2-ST-3,5	1790108	184
DFK-MSTBVA 2,5/13-GF-5,08	1899391	355	DFK-PC 5/5-G-7,62	1727618	544	DFK-PC 6-16/3-GF-SH-10,16	1701948	576	DFMC 1,5/2-ST-3,5-LR	1790483	185
DFK-MSTBVA 2,5/14-G-5,08	1899252	355	DFK-PC 5/5-GF-7,62	1727728	545	DFK-PC 6-16/3-GFU-10,16	1701702	575	DFMC 1,5/2-STF-3,5	1790292	185
DFK-MSTBVA 2,5/14-GF-5,08	1899401	355	DFK-PC 5/5-GF-SH-7,62	1716098	546	DFK-PC 6-16/3-GFU-SH-10,16	1702028	577	DFMC 1,5/3-ST-3,5	1790111	184
DFK-MSTBVA 2,5/15-G-5,08	1899265	355	DFK-PC 5/5-GFU-7,62	1727948	545	DFK-PC 6-16/3-GU-10,16	1701621	575	DFMC 1,5/3-ST-3,5-LR	1790496	185
DFK-MSTBVA 2,5/15-GF-5,08	1899414	355	DFK-PC 5/5-GFU-SH-7,62	1716205	547	DFK-PC 6-16/4-G-10,16	1701472	574	DFMC 1,5/3-STF-3,5	1790302	185
DFK-MSTBVA 2,5/16-G-5,08	1899278	355	DFK-PC 5/5-GU-7,62	1727838	545	DFK-PC 6-16/4-GF-10,16	1701553	575	DFMC 1,5/4-ST-3,5	1790124	184
DFK-MSTBVA 2,5/16-GF-5,08	1899427	355	DFK-PC 5/5-ST-7,62	1716535	548	DFK-PC 6-16/4-GF-SH-10,16	1701951	576	DFMC 1,5/4-ST-3,5-LR	1790506	185
DFK-PC 16/2-ST-10,16	1703373	582	DFK-PC 5/5-STF-7,62	1716645	549	DFK-PC 6-16/4-GFU-10,16	1701715	575	DFMC 1,5/4-STF-3,5	1790315	185
DFK-PC 16/2-STF-10,16	1703454	583	DFK-PC 5/5-STF-SH-7,62	1716755	549	DFK-PC 6-16/4-GFU-SH-10,16	1702031	577	DFMC 1,5/5-ST-3,5	1790137	184
DFK-PC 16/2-STF-SH-10,16	1703616	583	DFK-PC 5/6-G-7,62	1727621	544	DFK-PC 6-16/4-GU-10,16	1701634	575	DFMC 1,5/5-ST-3,5-LR	1790519	185
DFK-PC 16/3-ST-10,16	1703386	582	DFK-PC 5/6-GF-7,62	1727731	545	DFK-PC 6-16/5-G-10,16	1701485	574	DFMC 1,5/5-STF-3,5	1790328	185
DFK-PC 16/3-STF-10,16	1703467	583	DFK-PC 5/6-GF-SH-7,62	1716108	546	DFK-PC 6-16/5-GF-10,16	1701566	575	DFMC 1,5/6-ST-3,5	1790140	184
DFK-PC 16/3-STF-SH-10,16	1703629	583	DFK-PC 5/6-GFU-7,62	1727951	549	DFK-PC 6-16/5-GF-SH-10,16	1701964	576	DFMC 1,5/6-ST-3,5-LR	1790522	185
DFK-PC 16/4-ST-10,16	1703399	582	DFK-PC 5/6-GFU-SH-7,62	1716218	547	DFK-PC 6-16/5-GFU-10,16	1701728	575	DFMC 1,5/6-STF-3,5	1790031	185
DFK-PC 16/4-STF-10,16	1703470	583	DFK-PC 5/6-GU-7,62	1727841	545	DFK-PC 6-16/5-GFU-SH-10,16	1702044	577	DFMC 1,5/7-ST-3,5	1790153	184
DFK-PC 16/4-STF-SH-10,16	1703632	583	DFK-PC 5/6-ST-7,62	1716548	549	DFK-PC 6-16/5-GU-10,16	1701647	575	DFMC 1,5/7-ST-3,5-LR	1790535	185
DFK-PC 16/5-ST-10,16	1703409	582	DFK-PC 5/6-STF-7,62	1716658	548	DFK-PC 6-16/6-G-10,16	1701498	574	DFMC 1,5/7-STF-3,5	1790344	185
DFK-PC 16/5-STF-10,16	1703483	583	DFK-PC 5/6-STF-SH-7,62	1716768	549	DFK-PC 6-16/6-GF-10,16	1701579	575	DFMC 1,5/8-ST-3,5	1790166	184
DFK-PC 16/5-STF-SH-10,16	1703645	583	DFK-PC 5/7-G-7,62	1727634	544	DFK-PC 6-16/6-GF-SH-10,16	1701977	576	DFMC 1,5/8-ST-3,5-LR	1790548	185
DFK-PC 16/6-ST-10,16	1703412	582	DFK-PC 5/7-GF-7,62	1727744	545	DFK-PC 6-16/6-GFU-10,16	1701731	575	DFMC 1,5/8-STF-3,5	1790357	185
DFK-PC 16/6-STF-10,16	1703496	583	DFK-PC 5/7-GF-SH-7,62	1716111	546	DFK-PC 6-16/6-GFU-SH-10,16	1702057	577	DFMC 1,5/9-ST-3,5	1790179	184
DFK-PC 16/6-STF-SH-10,16	1703658	583	DFK-PC 5/7-GFU-7,62	1727964	545	DFK-PC 6-16/6-GU-10,16	1701650	575	DFMC 1,5/9-ST-3,5-LR	1790551	185
DFK-PC 16/7-ST-10,16	1703425	582	DFK-PC 5/7-GFU-SH-7,62	1716221	547	DFK-PC 6-16/7-G-10,16	1701508	574	DFMC 1,5/9-STF-3,5	1790360	185
DFK-PC 16/7-STF-10,16	1703506	583	DFK-PC 5/7-GU-7,62	1727854	545	DFK-PC 6-16/7-GF-10,16	1701582	575	DFMC 1,5/10-ST-3,5	1790182	184
DFK-PC 16/7-STF-SH-10,16	1703661	583	DFK-PC 5/7-ST-7,62	1716551	548	DFK-PC 6-16/7-GF-SH-10,16	1701980	576	DFMC 1,5/10-ST-3,5-LR	1790564	185
DFK-PC 16/8-ST-10,16	1703438	582	DFK-PC 5/7-STF-7,62	1716661	549	DFK-PC 6-16/7-GFU-10,16	1701744	575	DFMC 1,5/10-STF-3,5	1790373	185
DFK-PC 16/8-STF-10,16	1703519	583	DFK-PC 5/7-STF-SH-7,62	1716771	549	DFK-PC 6-16/7-GFU-SH-10,16	1702060	577	DFMC 1,5/11-ST-3,5	1790195	184
DFK-PC 16/8-STF-SH-10,16	1703674	583	DFK-PC 5/8-G-7,62	1727647	544	DFK-PC 6-16/7-GU-10,16	1701663	575	DFMC 1,5/11-ST-3,5-LR	1790577	185
DFK-PC 16/9-ST-10,16	1703441	582	DFK-PC 5/8-GF-7,62	1727757	545	DFK-PC 6-16/8-G-10,16	1701511	574	DFMC 1,5/11-STF-3,5	1790386	185
DFK-PC 16/9-STF-10,16	1703522	583	DFK-PC 5/8-GF-SH-7,62	1716124	546	DFK-PC 6-16/8-GF-10,16	1701595	575	DFMC 1,5/12-ST-3,5	1790205	184
DFK-PC 16/9-STF-SH-10,16	1703687	583	DFK-PC 5/8-GFU-7,62	1727977	545	DFK-PC 6-16/8-GF-SH-10,16	1701993	576	DFMC 1,5/12-ST-3,5-LR	1790580	185
DFK-PC 4/2-G-7,62-FS4,8	1861154	519	DFK-PC 5/8-GFU-SH-7,62	1716234	547	DFK-PC 6-16/8-GFU-10,16	1701757	575	DFMC 1,5/12-STF-3,5	1790399	185
DFK-PC 4/2-GF-7,62	1840557	518	DFK-PC 5/8-GU-7,62	1727867	545	DFK-PC 6-16/8-GFU-SH-10,16	1702073	577	DFMC 1,5/13-ST-3,5	1790218	184
DFK-PC 4/3-G-7,62-FS4,8	1861167	519	DFK-PC 5/8-ST-7,62	1716564	548	DFK-PC 6-16/8-GU-10,16	1701676	575	DFMC 1,5/13-ST-3,5-LR	1790593	185
DFK-PC 4/3-GF-7,62	1840560	518	DFK-PC 5/8-STF-7,62	1716674	549	DFK-PC 6-16/9-G-10,16	1701524	574	DFMC 1,5/13-STF-3,5	1790409	185
DFK-PC 4/4-G-7,62-FS4,8	1861170	519	DFK-PC 5/8-STF-SH-7,62	1716784	549	DFK-PC 6-16/9-GF-10,16	1701605	575	DFMC 1,5/14-ST-3,5	1790221	184
DFK-PC 4/4-GF-7,62	1840573	518	DFK-PC 5/9-G-7,62	1727650	544	DFK-PC 6-16/9-GF-SH-10,16	1702002	576	DFMC 1,5/14-ST-3,5-LR	1790603	185
DFK-PC 4/5-G-7,62-FS4,8	1861183	519	DFK-PC 5/9-GF-7,62	1727760	545	DFK-PC 6-16/9-GFU-10,16	1701760	575	DFMC 1,5/14-STF-3,5	1790412	185
DFK-PC 4/5-GF-7,62	1840586	518	DFK-PC 5/9-GF-SH-7,62	1716137	546	DFK-PC 6-16/9-GFU-SH-10,16	1702086	577	DFMC 1,5/15-ST-3,5	1790234	184
DFK-PC 4/6-G-7,62-FS4,8	1861196	519	DFK-PC 5/9-GFU-7,62	1727980	545	DFK-PC 6-16/9-GU-10,16	1701689	575	DFMC 1,5/15-ST-3,5-LR	1790616	185
DFK-PC 4/6-GF-7,62	1840599	518	DFK-PC 5/9-GFU-SH-7,62	1716247	547	DFK-PCV 5/2-G-7,62	1716299	547	DFMC 1,5/15-STF-3,5	1790425	185
DFK-PC 4/7-G-7,62-FS4,8	1861206	519	DFK-PC 5/9-GU-7,62	1727870	545	DFK-PCV 5/2-GF-7,62	1716399	547	DFMC 1,5/16-ST-3,5	1790247	184
DFK-PC 4/7-GF-7,62	1840609	518	DFK-PC 5/9-ST-7,62	1716577	548	DFK-PCV 5/3-G-7,62	1716292	547	DFMC 1,5/16-ST-3,5-LR	1790629	185
DFK-PC 4/8-G-7,62-FS4,8	1861219	519	DFK-PC 5/9-STF-7,62	1716687	549	DFK-PCV 5/3-GF-7,62	1716409	547	DFMC 1,5/16-STF-3,5	1790438	185
DFK-PC 4/8-GF-7,62	1840612	518	DFK-PC 5/9-STF-SH-7,62	1716797	549	DFK-PCV 5/4-G-7,62	1716302	547	DMC 1,5/2-G1-3,5 P20THR	1786837	186
DFK-PC 4/9-G-7,62-FS4,8	1861222	519	DFK-PC 5/10-G-7,62	1727663	544	DFK-PCV 5/4-GF-7,62	1716412	547	DMC 1,5/2-G1-3,5 P20THR R24-1	1816137	188
DFK-PC 4/9-GF-7,62	1840625	518	DFK-PC 5/10-GF-7,62	1727773	545	DFK-PCV 5/5-G-7,62	1716315	547	DMC 1,5/2-G1F-3,5-LR P20THR	1787014	187
DFK-PC 4/10-G-7,62-FS4,8	1861235	519	DFK-PC 5/10-GF-SH-7,62	1716140	546	DFK-PCV 5/5-GF-7,62	1716425	547	DMC 1,5/2-G1F-3,5-LRP20THRR44	1818504	189
DFK-PC 4/10-GF-7,62	1840638	518	DFK-PC 5/10-GFU-7,62	1727993	545	DFK-PCV 5/6-G-7,62	1716328	547	DMC 1,5/3-G1-3,5 P20THR	1786840	186
DFK-PC 4/11-G-7,62-FS4,8	1861248	519	DFK-PC 5/10-GFU-SH-7,62	1716250	547	DFK-PCV 5/6-GF-7,62	1716438	547	DMC 1,5/3-G1-3,5 P20THR R24-2	1816140	188
DFK-PC 4/11-GF-7,62	1840641	518	DFK-PC 5/10-GU-7,62	1727883	545	DFK-PCV 5/7-G-7,62	1716331	547	DMC 1,5/3-G1F-3,5-LR P20THR	1787027	187
DFK-PC 4/12-G-7,62-FS4,8	1861251	519	DFK-PC 5/10-ST-7,62	1716580	548	DFK-PCV 5/7-GF-7,62	1716441	547	DMC 1,5/3-G1F-3,5-LRP20THRR44	1818517	189
DFK-PC 4/12-GF-7,62	1840654	518	DFK-PC 5/10-STF-7,62	1716690	549	DFK-PCV 5/8-G-7,62	1716344	547	DMC 1,5/4-G1-3,5 P20THR	1786853	186
DFK-PC 5/2-G-7,62	1727582	544	DFK-PC 5/10-STF-SH-7,62	1716807	549	DFK-PCV 5/8-GF-7,62	1716454	547	DMC 1,5/4-G1-3,5 P20THR R44	1816153	188
DFK-PC 5/2-GF-7,62	1727692	545	DFK-PC 5/11-G-7,62	1727676	544	DFK-PCV 5/9-G-7,62	1716357	547	DMC 1,5/4-G1F-3,5-LR P20THR	1787030	187
DFK-PC 5/2-GF-SH-7,62	1716089	546	DFK-PC 5/11-GF-7,62	1727786	545	DFK-PCV 5/9-GF-7,62	1716467	547	DMC 1,5/4-G1F-3,5-LRP20THRR44	1818520	189
DFK-PC 5/2-GFU-7,62	1727919	545	DFK-PC 5/11-GF-SH-7,62	1716753	546	DFK-PCV 5/10-G-7,62	1716360	547	DMC 1,5/5-G1-3,5 P20THR	1786866	186
DFK-PC 5/2-GFU-SH-7,62	1716179	547	DFK-PC 5/11-GFU-7,62	1728002	545	DFK-PCV 5/10-GF-7,62	1716470	547	DMC 1,5/5-G1-3,5 P20THR R44	1816166	188
DFK-PC 5/2-GU-7,62	1727809	545	DFK-PC 5/11-GFU-SH-7,62	1716263	547	DFK-PCV 5/11-G-7,62	1716373	547	DMC 1,5/5-G1F-3,5-LR P20THR	1787043	187
DFK-PC 5/2-ST-7,62	1716506	548	DFK-PC 5/11-GU-7,62	1727896	545	DFK-PCV 5/11-GF-7,62	1716483	547	DMC 1,5/5-G1F-3,5-LRP20THRR56	1818533	189
DFK-PC 5/2-STF-7,62	1716616	549	DFK-PC 5/11-ST-7,62	1716593	548	DFK-PCV 5/12-G-7,62	1716386	547	DMC 1,5/5-G1-3,5 P20THR	1786879	186
DFK-PC 5/2-STF-SH-7,62	1716726	549	DFK-PC 5/11-STF-7,62	1716700	549	DFK-PCV 5/12-GF-7,62	1716496	547	DMC 1,5/6-G1-3,5 P20THR R44	181847	

Index

Alphabetical

Type	Order No.	Page	Type	Order No.	Page	Type	Order No.	Page	Type	Order No.	Page
EMG 45-H 7,5MM KLAR	2946214	712	EML (20X8)R	0816786	808	EML-ESD (8X8)RL-T	0830576	813	EMLS (26,5X12)R SR	0800353	816
EMG 45-H 15MM KLAR	2946227	712	EML (20X8)R YE	0816799	809	EML-HT (15X15)R	0800341	810	EMLS (26,5X12)R SR CUS	0830179	817
EMG 45-H 35MM KLAR	2942140	712	EML (21,5X21,5)R SR	0816812	809	EML-HT (15X15)R CUS	0830170	811	EMLS (38,1X19)R SR	0800354	816
EMG 45-H 52MM GN	2946230	712	EML (25,4X12,7)R	0816825	808	EML-HT (15X15)RL-T	0830653	811	EMLS (38,1X19)R SR CUS	0830180	817
EMG 45-LG	2946191	712	EML (25,4X12,7)R YE	0816838	809	EML-HT (15X6)R	0830644	810	EMLS (40X15)R SR	0800345	816
EMG 45-LG/O	2942315	712	EML (26,5X12)R SR	0816854	809	EML-HT (15X6)R CUS	0830663	811	EMLS (40X15)R SR CUS	0830173	817
EMG 45-LG/SET	2940032	712	EML (26,5X17,5)R SR	0816883	809	EML-HT (15X6)RL-T	0830652	811	EMLS (40X8)R SR	0800348	816
EMG 45-ZE	2941811	712	EML (26,5X17,5)R YE	0816896	809	EML-HT (20X7)R	0830645	810	EMLS (40X8)R SR CUS	0830176	817
EMG 50-B9	2947268	713	EML (26,5X18,5)R SR	0816906	809	EML-HT (20X7)R CUS	0830664	811	EMLS (60X30)R SR	0800355	816
EMG 50-H 7,5MM KLAR	2947925	713	EML (26,5X26,5)R SR	0816919	809	EML-HT (20X7)RL-T	0830654	811	EMLS (60X30)R SR CUS	0830181	817
EMG 50-H 15MM KLAR	2947938	713	EML (26,5X7,5)R SR	0816841	809	EML-HT (24X4)R	0830646	810	EMLS (70X150)R SR	0800351	816
EMG 50-H 52MM GN	2947941	713	EML (30X20)R	0816922	808	EML-HT (24X4)R CUS	0830665	811	EMLS (70X150)R SR CUS	0830178	817
EMG 50-LG	2947242	713	EML (30X20)R YE	0816935	809	EML-HT (24X4)RL-T	0830655	811	EMLS (70X32)R SR	0800346	816
EMG 50-LG/O	2940870	713	EML (37XE)RL TR	0815716	808	EML-HT (25,4X12,7)R	0830648	810	EMLS (70X32)R SR CUS	0830174	817
EMG 50-LG/SET	2940045	713	EML (38,1X19)RL	0816171	808	EML-HT (25,4X12,7)R CUS	0830667	811	EMLS (76X51)R SR	0800350	816
EMG 75-B14	2947381	713	EML (38X17)R	0816951	808	EML-HT (25,4X12,7)RL-T	0830657	811	EMLS (76X51)R SR CUS	0830177	817
EMG 75-H 7,5MM KLAR	2947954	713	EML (40X15)R SR	0815729	809	EML-HT (25X8)R	0830647	810	EMLS (85X32)R SR	0800356	816
EMG 75-H 15MM KLAR	2947967	713	EML (40X25)R	0818027	808	EML-HT (25X8)R CUS	0830666	811	EMLS (85X32)R SR CUS	0830182	817
EMG 75-H 52MM GN	2947970	713	EML (40X25)R YE	0816977	809	EML-HT (25X8)RL-T	0830656	811	EMSTB 2,5-SH	1877203	826
EMG 75-LG	2947378	713	EML (40X8)R	0816980	808	EML-HT (32X10)R	0830649	810	EMSTB 2,5/ 2-GF	1900073	311
EMG 75-LG/O	2941879	713	EML (50,8X25,4)RL	0816184	808	EML-HT (32X10)R CUS	0830668	811	EMSTB 2,5/ 2-GF-5,08	1899618	311
EMG 75-LG/SET	2940058	713	EML (51X25)R	0817028	808	EML-HT (32X10)RL-T	0830658	811	EMSTB 2,5/ 3-GF	1900086	311
EMG 90-B17	2946269	713	EML (51X25)R SR	0817002	809	EML-HT (35X6,5)R	0830650	810	EMSTB 2,5/ 3-GF-5,08	1899621	311
EMG 90-H 7,5MM KLAR	2945396	713	EML (51X25)R YE	0817031	809	EML-HT (35X6,5)R CUS	0830669	811	EMSTB 2,5/ 4-GF	1900099	311
EMG 90-H 15MM KLAR	2945406	713	EML (69,8X31,8)RL	0816197	808	EML-HT (35X6,5)RL-T	0830659	811	EMSTB 2,5/ 4-GF-5,08	1899634	311
EMG 90-H 52MM GN	2944300	713	EML (70X32)R	0817060	808	EML-HT (40X15)R	0800339	810	EMSTB 2,5/ 5-GF	1900109	311
EMG 90-LG	2946256	713	EML (70X32)R SR	0817057	809	EML-HT (40X15)R CUS	0830168	811	EMSTB 2,5/ 5-GF-5,08	1899647	311
EMG 90-LG/O	2941581	713	EML (70X32)R YE	0817073	809	EML-HT (40X15)RL-T	0830660	811	EMSTB 2,5/ 6-GF	1900112	311
EMG 90-LG/SET	2907884	713	EML (70X50)R	0817099	808	EML-HT (45X5)R	0800337	810	EMSTB 2,5/ 6-GF-5,08	1899650	311
EMG 90-ZE	2941824	713	EML (70X50)R SR	0817086	809	EML-HT (45X5)R CUS	0830166	811	EMSTB 2,5/ 7-GF	1900125	311
EMG-GKS 12	2947035	709	EML (76,2X6,5)RL YE	0816207	809	EML-HT (45X5)RL-T	0830661	811	EMSTB 2,5/ 7-GF-5,08	1899663	311
EMG-GKS 22	2941594	710	EML (90X5)R	0817109	808	EML-HT (50X10)R	0800338	810	EMSTB 2,5/ 8-GF	1900138	311
EMG-KA	2941510	708	EML (D17,5)R	0815774	808	EML-HT (50X10)R CUS	0830167	811	EMSTB 2,5/ 8-GF-5,08	1899676	311
EMG-SGKS 10	2947585	708	EML (100X40)R	0800286	808	EML-HT (50X10)RL-T	0830662	811	EMSTB 2,5/ 9-GF	1900141	311
EMG100-B19	2947093	714	EML (100X40)R SR	0802697	809	EML-HT (8X8)R	0800340	810	EMSTB 2,5/ 9-GF-5,08	1899689	311
EMG100-H 7,5MM KLAR	2944193	714	EML (15X6) R YE	0819288	809	EML-HT (8X8)R CUS	0830169	811	EMSTB 2,5/10-GF	1900154	311
EMG100-H 15MM KLAR	2943152	714	EML (18X7)RL YE	0802733	809	EML-HT (8X8)RL-T	0830651	811	EMSTB 2,5/10-GF-5,08	1899692	311
EMG100-H 35MM KLAR	2942218	714	EML (25,4X12,7)RL	0816087	808	EML-HT (D12)R	0801376	810	EMSTB 2,5/11-GF	1900167	311
EMG100-H 52MM GN	2944724	714	EML (29X29)R-ME	0828172	674	EML-RM (15X15)R	0830530	814	EMSTB 2,5/11-GF-5,08	1899702	311
EMG100-LG	2947080	714	EML (44X42)R-ME	0828279	674	EML-RM (15X15)R CUS	0830554	815	EMSTB 2,5/12-GF	1900170	311
EMG100-LG/MSTB	2907570	714	EML (44X49)R-ME	0828169	674	EML-RM (15X15)RL-T	0830542	815	EMSTB 2,5/12-GF-5,08	1899715	311
EMG100-LG/O	2907567	714	EML (44X53)R-ME	0828156	674	EML-RM (15X6)R	0830529	814	EMSTB 2,5/13-GF	1900183	311
EMG100-LG/SET	2906283	714	EML (44X64)R-ME	0828266	674	EML-RM (15X6)R CUS	0830553	815	EMSTB 2,5/13-GF-5,08	1899728	311
EMG125-B24	2947996	715	EML (44X72)R-ME	0828143	674	EML-RM (15X6)RL-T	0830541	815	EMSTB 2,5/14-GF	1900196	311
EMG125-H 7,5MM KLAR	2943194	715	EML (44X76)R-ME	0828130	674	EML-RM (20X7)R	0830531	814	EMSTB 2,5/14-GF-5,08	1899731	311
EMG125-H 15MM KLAR	2943181	715	EML-ESD (15X15)R	0830566	812	EML-RM (20X7)R CUS	0830555	815	EMSTB 2,5/15-GF	1900206	311
EMG125-H 52MM GN	2943518	715	EML-ESD (15X15)R CUS	0830590	813	EML-RM (20X7)RL-T	0830543	815	EMSTB 2,5/15-GF-5,08	1899744	311
EMG125-LG	2947983	715	EML-ESD (15X15)RL-T	0830578	813	EML-RM (24X4)R	0830532	814	EMSTB 2,5/16-GF	1900219	311
EMG125-LG/MSTB	2943288	715	EML-ESD (15X6)R	0830565	812	EML-RM (24X4)R CUS	0830556	815	EMSTB 2,5/16-GF-5,08	1899757	311
EMG150-B29	2946036	715	EML-ESD (15X6)R CUS	0830589	813	EML-RM (24X4)RL-T	0830544	815	EMSTBA 2,5/ 2-G	1899841	310
EMG150-H 7,5MM KLAR	2943178	715	EML-ESD (15X6)RL-T	0830577	813	EML-RM (25,4X12,7)R	0830534	814	EMSTBA 2,5/ 2-G-5,08	1880300	310
EMG150-H 15MM KLAR	2943165	715	EML-ESD (20X7)R	0830567	812	EML-RM (25,4X12,7)R CUS	0830558	815	EMSTBA 2,5/ 3-G	1899854	310
EMG150-H 52MM GN	2943521	715	EML-ESD (20X7)R CUS	0830591	813	EML-RM (25,4X12,7)RL-T	0830546	815	EMSTBA 2,5/ 3-G-5,08	1880313	310
EMG150-LG	2946023	715	EML-ESD (20X7)RL-T	0830579	813	EML-RM (25X8)R	0830533	814	EMSTBA 2,5/ 4-G	1899867	310
EMG150-LG/MSTB	2907596	715	EML-ESD (24X4)R	0830568	812	EML-RM (25X8)R CUS	0830557	815	EMSTBA 2,5/ 4-G-5,08	1880326	310
EMG150-LG/O	2906571	715	EML-ESD (24X4)R CUS	0830592	813	EML-RM (25X8)RL-T	0830545	815	EMSTBA 2,5/ 5-G	1899870	310
EML (100X73)R	0817125	808	EML-ESD (24X4)RL-T	0830580	813	EML-RM (32X10)R	0830535	814	EMSTBA 2,5/ 5-G-5,08	1880339	310
EML (100X73)R SR	0817112	809	EML-ESD (25,4X12,7)R	0830570	812	EML-RM (32X10)R CUS	0830559	815	EMSTBA 2,5/ 6-G	1899883	310
EML (100X73)R YE	0817138	809	EML-ESD (25,4X12,7)R CUS	0830594	813	EML-RM (32X10)RL-T	0830547	815	EMSTBA 2,5/ 6-G-5,08	1880342	310
EML (100X90)R	0817154	808	EML-ESD (25,4X12,7)RL-T	0830582	813	EML-RM (35X6,5)R	0830536	814	EMSTBA 2,5/ 7-G	1899896	310
EML (100X90)R SR	0817141	809	EML-ESD (25X8)R	0830569	812	EML-RM (35X6,5)R CUS	0830560	815	EMSTBA 2,5/ 7-G-5,08	1880355	310
EML (100XE)RL SR	0815787	809	EML-ESD (25X8)R CUS	0830593	813	EML-RM (35X6,5)RL-T	0830548	815	EMSTBA 2,5/ 8-G	1899906	310
EML (101,6X25,4)RL SR	0815790	809	EML-ESD (25X8)RL-T	0830581	813	EML-RM (40X15)R	0830537	814	EMSTBA 2,5/ 8-G-5,08	1880368	310
EML (10X4)R	0815583	808	EML-ESD (32X10)R	0830571	812	EML-RM (40X15)R CUS	0830561	815	EMSTBA 2,5/ 9-G	1899919	310
EML (10X7)R	0816663	808	EML-ESD (32X10)R CUS	0830595	813	EML-RM (40X15)RL-T	0830549	815	EMSTBA 2,5/ 9-G-5,08	1880371	310
EML (10X7)R YE	0816676	809	EML-ESD (32X10)RL-T	0830583	813	EML-RM (45X5)R	0830538	814	EMSTBA 2,5/10-G	1899922	310
EML (15X9)R	0815677	808	EML-ESD (35X6,5)R	0830572	812	EML-RM (45X5)R CUS	0830562	815	EMSTBA 2,5/10-G-5,08	1880384	310
EML (15X9)R SR	0816032	809	EML-ESD (35X6,5)R CUS	0830596	813	EML-RM (45X5)RL-T	0830550	815	EMSTBA 2,5/11-G	1899935	310
EML (15X9)R YE	0816045	809	EML-ESD (35X6,5)RL-T	0830584	813	EML-RM (50X10)R	0830539	814	EMSTBA 2,5/11-G-5,08	1880397	310
EML (16,5X5)R	0816702	808	EML-ESD (40X15)R	0830573	812	EML-RM (50X10)R CUS	0830663	815	EMSTBA 2,5/12-G	1899948	310
EML (16,5X5)R YE	0816728	809	EML-ESD (40X15)R CUS	0830597	813	EML-RM (50X10)RL-T	0830551	815	EMSTBA 2,5/12-G-5,08	1880407	310
EML (16,5X5)RL	0816113	808	EML-ESD (40X15)RL-T	0830585	813	EML-RM (8X8)R	0830528	814	EMSTBA 2,5/13-G	1899951	310
EML (16,5X5)RL YE	0816126	809	EML-ESD (45X5)R	0830574	812	EML-RM (8X8)R CUS	0830552	815	EMSTBA 2,5/13-G-5,08	1880410	310
EML (16X7)R	0818001	808	EML-ESD (45X5)R CUS	0830598	813	EML-RM (8X8)RL-T	0830540	815	EMSTBA 2,5/		

Type	Order No.	Page	Type	Order No.	Page	Type	Order No.	Page	Type	Order No.	Page
EMSTBV 2,5/2-GF-5,08	1915217	311	FBSK 3-10/ZFKDS 10	1986657	830	FK-MCP 1,5/9-ST-3,81-LR	1817495	199	FK-MPT 0,5/9-3,5	1891137	403
EMSTBV 2,5/3-GF	1914068	311	FBSK 3-15/ZFKDS 10	1986686	830	FK-MCP 1,5/9-STF-3,5	1940169	199	FK-MPT 0,5/9-3,5-H	1928835	404
EMSTBV 2,5/3-GF-5,08	1898648	311	FBSK 4-10/ZFKDS 10	1986660	830	FK-MCP 1,5/9-STF-3,81	1851300	199	FK-MPT 0,5/9-ICA-3,5	1930399	404
EMSTBV 2,5/4-GF	1914071	311	FBSK 4-15/ZFKDS 10	1986673	830	FK-MCP 1,5/10-ST-3,5	1939989	198	FK-MPT 0,5/9-ICVA-3,5	1930548	405
EMSTBV 2,5/4-GF-5,08	1915233	311	FFKDS/H-2,54	1791826	145	FK-MCP 1,5/10-ST-3,5-LR	1817314	199	FK-MPT 0,5/9-ST-3,5	1913992	403
EMSTBV 2,5/5-GF	1914084	311	FFKDS/H-3,81	1789650	145	FK-MCP 1,5/10-ST-3,81	1851122	198	FK-MPT 0,5/10-3,5	1891140	403
EMSTBV 2,5/5-GF-5,08	1915246	311	FFKDS/H1-5,08	1790335	147	FK-MCP 1,5/10-ST-3,81-LR	1817505	199	FK-MPT 0,5/10-3,5-H	1928848	403
EMSTBV 2,5/6-GF	1915107	311	FFKDS/H2-5,08	1790461	147	FK-MCP 1,5/10-STF-3,5	1940172	199	FK-MPT 0,5/10-ICA-3,5	1930409	404
EMSTBV 2,5/6-GF-5,08	1915259	311	FFKDS/V-2,54	1791813	145	FK-MCP 1,5/10-STF-3,81	1851313	199	FK-MPT 0,5/10-ICVA-3,5	1930551	405
EMSTBV 2,5/7-GF	1915110	311	FFKDS/V-3,81	1789647	147	FK-MCP 1,5/11-ST-3,5	1939992	198	FK-MPT 0,5/10-ST-3,5	1914001	403
EMSTBV 2,5/7-GF-5,08	1915262	311	FFKDS/V1-5,08	1790319	149	FK-MCP 1,5/11-ST-3,5-LR	1817327	199	FK-MPT 0,5/11-3,5	1891153	403
EMSTBV 2,5/8-GF	1915123	311	FFKDS/V2-5,08	1790348	149	FK-MCP 1,5/11-ST-3,81	1851135	198	FK-MPT 0,5/11-3,5-H	1928851	403
EMSTBV 2,5/8-GF-5,08	1915275	311	FFKDSA/H1-7,62	1790351	149	FK-MCP 1,5/11-ST-3,81-LR	1817518	199	FK-MPT 0,5/11-ICA-3,5	1930412	404
EMSTBV 2,5/9-GF	1915136	311	FFKDSA/H2-7,62	1790458	151	FK-MCP 1,5/11-ST-3,5	1940185	199	FK-MPT 0,5/11-ICVA-3,5	1930564	405
EMSTBV 2,5/9-GF-5,08	1915288	311	FFKDSA/V1-7,62	1790364	151	FK-MCP 1,5/11-STF-3,81	1851326	199	FK-MPT 0,5/11-ST-3,5	1914027	403
EMSTBV 2,5/10-GF	1915149	311	FFKDSA/V2-7,62	1790377	151	FK-MCP 1,5/12-ST-3,5	1940004	198	FK-MPT 0,5/12-3,5	1891166	403
EMSTBV 2,5/10-GF-5,08	1915291	311	FFKDSA1/H-5,08	1791868	145	FK-MCP 1,5/12-ST-3,5-LR	1817330	199	FK-MPT 0,5/12-3,5-H	1928864	403
EMSTBV 2,5/11-GF	1915112	311	FFKDSA1/H-6,35	1789634	145	FK-MCP 1,5/12-ST-3,81	1851148	198	FK-MPT 0,5/12-ICA-3,5	1930425	404
EMSTBV 2,5/11-GF-5,08	1915301	311	FFKDSA1/H1-7,62	1790513	147	FK-MCP 1,5/12-ST-3,81-LR	1817521	199	FK-MPT 0,5/12-ICVA-3,5	1930577	405
EMSTBV 2,5/12-GF	1915165	311	FFKDSA1/H2-7,62	1790500	147	FK-MCP 1,5/12-STF-3,5	1940198	199	FK-MPT 0,5/12-ST-3,5	1914030	403
EMSTBV 2,5/12-GF-5,08	1915314	311	FFKDSA1/V-5,08	1791855	145	FK-MCP 1,5/12-STF-3,81	1851339	199	FK-MPT 0,5/13-3,5	1891179	403
EMSTBV 2,5/13-GF	1915178	311	FFKDSA1/V-6,35	1789621	147	FK-MCP 1,5/13-ST-3,5	1940017	198	FK-MPT 0,5/13-3,5-H	1928877	403
EMSTBV 2,5/13-GF-5,08	1915327	311	FFKDSA1/V1-7,62	1790490	149	FK-MCP 1,5/13-ST-3,5-LR	1817343	199	FK-MPT 0,5/13-ICA-3,5	1930438	404
EMSTBV 2,5/14-GF	1915181	311	FFKDSA1/V2-7,62	1790487	149	FK-MCP 1,5/13-ST-3,81	1851151	198	FK-MPT 0,5/13-ICVA-3,5	1930580	405
EMSTBV 2,5/14-GF-5,08	1915330	311	FK-MC 0,5/2-ST-2,5	1881325	168	FK-MCP 1,5/13-ST-3,81-LR	1817534	199	FK-MPT 0,5/13-ST-3,5	1914043	403
EMSTBV 2,5/15-GF	1915194	311	FK-MC 0,5/3-ST-2,5	1881338	168	FK-MCP 1,5/13-STF-3,5	1940208	199	FK-MPT 0,5/14-3,5	1891182	403
EMSTBV 2,5/15-GF-5,08	1915343	311	FK-MC 0,5/4-ST-2,5	1881341	168	FK-MCP 1,5/13-STF-3,81	1851342	199	FK-MPT 0,5/14-3,5-H	1928880	403
EMSTBV 2,5/16-GF	1915204	311	FK-MC 0,5/5-ST-2,5	1881354	168	FK-MCP 1,5/14-ST-3,5	1940020	198	FK-MPT 0,5/14-ICA-3,5	1930441	404
EMSTBV 2,5/16-GF-5,08	1915356	311	FK-MC 0,5/6-ST-2,5	1881367	168	FK-MCP 1,5/14-ST-3,5-LR	1817356	199	FK-MPT 0,5/14-ICVA-3,5	1930593	405
EMSTBVA 2,5-SS-1-5,08	1877216	826	FK-MC 0,5/7-ST-2,5	1881370	168	FK-MCP 1,5/14-ST-3,81	1851164	198	FK-MPT 0,5/14-ST-3,5	1914056	403
EMSTBVA 2,5/2-G	1914852	311	FK-MC 0,5/8-ST-2,5	1881383	168	FK-MCP 1,5/14-ST-3,81-LR	1817547	199	FK-MPT 0,5/15-3,5	1891195	403
EMSTBVA 2,5/2-G-5,08	1895919	311	FK-MC 0,5/9-ST-2,5	1881396	168	FK-MCP 1,5/14-STF-3,5	1940211	199	FK-MPT 0,5/15-3,5-H	1928893	403
EMSTBVA 2,5/3-G	1914865	311	FK-MC 0,5/10-ST-2,5	1881406	168	FK-MCP 1,5/14-STF-3,81	1851355	199	FK-MPT 0,5/15-ICA-3,5	1930454	404
EMSTBVA 2,5/3-G-5,08	1895922	311	FK-MC 0,5/11-ST-2,5	1881419	168	FK-MCP 1,5/15-ST-3,5	1940033	198	FK-MPT 0,5/15-ICVA-3,5	1930603	405
EMSTBVA 2,5/4-G	1914878	311	FK-MC 0,5/12-ST-2,5	1881422	168	FK-MCP 1,5/15-ST-3,5-LR	1817369	199	FK-MPT 0,5/15-ST-3,5	1914069	403
EMSTBVA 2,5/4-G-5,08	1895935	311	FK-MCP 1,5/2-ST-3,5	1939918	198	FK-MCP 1,5/15-ST-3,81	1851177	198	FK-MPT 0,5/16-3,5	1912025	403
EMSTBVA 2,5/5-G	1914881	311	FK-MCP 1,5/2-ST-3,5-LR	1817233	199	FK-MCP 1,5/15-ST-3,81-LR	1817550	199	FK-MPT 0,5/16-3,5-H	1928903	403
EMSTBVA 2,5/5-G-5,08	1895948	311	FK-MCP 1,5/2-ST-3,81	1851041	198	FK-MCP 1,5/15-STF-3,5	1940224	199	FK-MPT 0,5/16-ICA-3,5	1930467	404
EMSTBVA 2,5/6-G	1914894	311	FK-MCP 1,5/2-ST-3,81-LR	1817424	199	FK-MCP 1,5/15-STF-3,81	1851368	199	FK-MPT 0,5/16-ICVA-3,5	1930616	405
EMSTBVA 2,5/6-G-5,08	1895951	311	FK-MCP 1,5/2-STF-3,5	1940091	199	FK-MCP 1,5/16-ST-3,5	1940046	198	FK-MPT 0,5/16-ST-3,5	1914072	403
EMSTBVA 2,5/7-G	1914904	311	FK-MCP 1,5/2-STF-3,81	1851232	199	FK-MCP 1,5/16-ST-3,5-LR	1817372	199	FKC 2,5 HC/ 2-ST	1942154	494
EMSTBVA 2,5/7-G-5,08	1895964	311	FK-MCP 1,5/3-ST-3,5	1939921	198	FK-MCP 1,5/16-ST-3,81	1851180	198	FKC 2,5 HC/ 2-ST-5,08	1942374	494
EMSTBVA 2,5/8-G	1914917	311	FK-MCP 1,5/3-ST-3,5-LR	1817246	199	FK-MCP 1,5/16-ST-3,81-LR	1817563	199	FKC 2,5 HC/ 2-STF	1942264	495
EMSTBVA 2,5/8-G-5,08	1895977	311	FK-MCP 1,5/3-ST-3,81	1851054	198	FK-MCP 1,5/16-STF-3,5	1940237	199	FKC 2,5 HC/ 2-STF-5,08	1942484	495
EMSTBVA 2,5/9-G	1914920	311	FK-MCP 1,5/3-ST-3,81-LR	1817437	199	FK-MCP 1,5/16-STF-3,81	1851371	199	FKC 2,5 HC/ 3-ST	1942167	494
EMSTBVA 2,5/9-G-5,08	1895980	311	FK-MCP 1,5/3-STF-3,5	1940101	199	FK-MPT 0,5/2-3,5	1891069	403	FKC 2,5 HC/ 3-ST-5,08	1942387	494
EMSTBVA 2,5/10-G	1914933	311	FK-MCP 1,5/3-STF-3,81	1851245	199	FK-MPT 0,5/2-3,5-H	1928767	403	FKC 2,5 HC/ 3-STF	1942277	495
EMSTBVA 2,5/10-G-5,08	1895993	311	FK-MCP 1,5/4-ST-3,5	1939934	198	FK-MPT 0,5/2-ICA-3,5	1930328	404	FKC 2,5 HC/ 3-STF-5,08	1942497	495
EMSTBVA 2,5/11-G	1914946	311	FK-MCP 1,5/4-ST-3,5-LR	1817259	199	FK-MPT 0,5/2-ICVA-3,5	1930470	405	FKC 2,5 HC/ 4-ST	1942170	494
EMSTBVA 2,5/11-G-5,08	1895903	311	FK-MCP 1,5/4-ST-3,81	1851067	198	FK-MPT 0,5/2-ST-3,5	1913921	403	FKC 2,5 HC/ 4-ST-5,08	1942390	494
EMSTBVA 2,5/12-G	1914959	311	FK-MCP 1,5/4-ST-3,81-LR	1817440	199	FK-MPT 0,5/3-3,5	1891072	403	FKC 2,5 HC/ 4-STF	1942280	495
EMSTBVA 2,5/12-G-5,08	1895961	311	FK-MCP 1,5/4-STF-3,5	1940114	199	FK-MPT 0,5/3-3,5-H	1928770	403	FKC 2,5 HC/ 4-STF-5,08	1942507	495
EMSTBVA 2,5/13-G	1914962	311	FK-MCP 1,5/4-STF-3,81	1851258	199	FK-MPT 0,5/3-ICA-3,5	1930331	404	FKC 2,5 HC/ 5-ST	1942183	494
EMSTBVA 2,5/13-G-5,08	1895929	311	FK-MCP 1,5/5-ST-3,5	1939947	198	FK-MPT 0,5/3-ICVA-3,5	1930483	405	FKC 2,5 HC/ 5-ST-5,08	1942400	494
EMSTBVA 2,5/14-G	1914975	311	FK-MCP 1,5/5-ST-3,5-LR	1817262	199	FK-MCP 1,5/5-ST-3,5	1913934	403	FKC 2,5 HC/ 5-STF	1942293	495
EMSTBVA 2,5/14-G-5,08	1895932	311	FK-MCP 1,5/5-ST-3,81	1851070	198	FK-MPT 0,5/4-3,5	1891085	403	FKC 2,5 HC/ 5-STF-5,08	1942510	495
EMSTBVA 2,5/15-G	1914988	311	FK-MCP 1,5/5-ST-3,81-LR	1817453	199	FK-MPT 0,5/4-3,5-H	1928783	403	FKC 2,5 HC/ 6-ST	1942196	494
EMSTBVA 2,5/15-G-5,08	1895945	311	FK-MCP 1,5/5-STF-3,5	1940127	199	FK-MPT 0,5/4-ICA-3,5	1930344	404	FKC 2,5 HC/ 6-ST-5,08	1942413	494
EMSTBVA 2,5/16-G	1914991	311	FK-MCP 1,5/5-STF-3,81	1851261	199	FK-MPT 0,5/4-ICVA-3,5	1930496	405	FKC 2,5 HC/ 6-STF	1942303	495
EMSTBVA 2,5/16-G-5,08	1895958	311	FK-MCP 1,5/6-ST-3,5	1939950	198	FK-MPT 0,5/4-ST-3,5	1913947	403	FKC 2,5 HC/ 6-STF-5,08	1942523	495
ESL 15X5	0822592	675	FK-MCP 1,5/6-ST-3,5-LR	1817275	199	FK-MPT 0,5/5-3,5	1891098	403	FKC 2,5 HC/ 7-ST	1942206	494
ESL 20X5	0822589	675	FK-MCP 1,5/6-ST-3,81	1851083	198	FK-MPT 0,5/5-3,5-H	1928796	403	FKC 2,5 HC/ 7-ST-5,08	1942426	494
			FK-MCP 1,5/6-ST-3,81-LR	1817466	199	FK-MPT 0,5/5-ICA-3,5	1930357	404	FKC 2,5 HC/ 7-STF	1942316	495
			FK-MCP 1,5/6-STF-3,5	1940130	199	FK-MPT 0,5/5-ICVA-3,5	1930506	405	FKC 2,5 HC/ 7-STF-5,08	1942536	495
			FK-MCP 1,5/6-STF-3,81	1851274	199	FK-MPT 0,5/5-ST-3,5	1913950	403	FKC 2,5 HC/ 8-ST	1942219	494
			FK-MCP 1,5/7-ST-3,5	1939960	198	FK-MPT 0,5/6-3,5	1891108	403	FKC 2,5 HC/ 8-ST-5,08	1942439	494
			FK-MCP 1,5/7-ST-3,5-LR	1817288	199	FK-MPT 0,5/6-3,5-H	1928806	403	FKC 2,5 HC/ 8-STF	1942329	495
			FK-MCP 1,5/7-ST-3,81	1851096	198	FK-MPT 0,5/6-ICA-3,5	1930360	404	FKC 2,5 HC/ 8-STF-5,08	1942549	495
F			FK-MCP 1,5/7-ST-3,81-LR	1817479	199	FK-MPT 0,5/6-ICVA-3,5	1930519	405	FKC 2,5 HC/ 9-ST	1942222	494
FBSK 2-10	1928398	830	FK-MCP 1,5/7-STF-3,5	1940143	199	FK-MPT 0,5/6-ST-3,5	1913963	403	FKC 2,5 HC/ 9-ST-5,08	1942442</	

Index

Alphabetical

Type	Order No.	Page	Type	Order No.	Page	Type	Order No.	Page	Type	Order No.	Page
FKC 2,5 HC/12-ST	1942251	494	FKC 2,5/10-ST-5,08-RF EX	1796186	371	FKCN 2,5/ 9-ST-5,08	1754636	278	FKCS 2,5/14-ST-5,08	1975192	276
FKC 2,5 HC/12-ST-5,08	1942471	494	FKC 2,5/10-ST-RF	1947133	275	FKCN 2,5/ 9-STF	1733039	279	FKCS 2,5/14-STF	1975040	277
FKC 2,5 HC/12-STF	1942361	495	FKC 2,5/10-STF	1910607	275	FKCN 2,5/ 9-STF-5,08	1754869	279	FKCS 2,5/14-STF-5,08	1975383	277
FKC 2,5 HC/12-STF-5,08	1942581	495	FKC 2,5/10-STF-5,08	1873281	275	FKCN 2,5/10-ST	1732823	278	FKCS 2,5/15-ST	1974863	276
FKC 2,5/ 2-ST	1910351	274	FKC 2,5/10-STF-5,08 EX	1796076	274	FKCN 2,5/10-ST-5,08	1754649	278	FKCS 2,5/15-ST-5,08	1975202	276
FKC 2,5/ 2-ST-5,08	1873058	274	FKC 2,5/11-ST	1910445	274	FKCN 2,5/10-STF	1733042	279	FKCS 2,5/15-STF	1975053	277
FKC 2,5/ 2-ST-5,08-LR	1792517	275	FKC 2,5/11-ST-5,08	1873142	274	FKCN 2,5/10-STF-5,08	1754872	279	FKCS 2,5/15-STF-5,08	1975396	277
FKC 2,5/ 2-ST-5,08-RF	1925692	275	FKC 2,5/11-ST-5,08-LR	1792601	275	FKCN 2,5/11-ST	1732833	278	FKCS 2,5/16-ST	1974876	276
FKC 2,5/ 2-ST-5,08-RF EX	1796102	371	FKC 2,5/11-ST-5,08-RF	1925786	275	FKCN 2,5/11-ST-5,08	1754652	278	FKCS 2,5/16-ST-5,08	1975215	276
FKC 2,5/ 2-ST-RF	1947052	275	FKC 2,5/11-ST-5,08-RF EX	1796199	371	FKCN 2,5/11-STF	1733058	279	FKCS 2,5/16-STF	1975066	277
FKC 2,5/ 2-STF	1910526	275	FKC 2,5/11-ST-RF	1947146	275	FKCN 2,5/11-STF-5,08	1754885	279	FKCS 2,5/16-STF-5,08	1975406	277
FKC 2,5/ 2-STF-5,08	1873207	275	FKC 2,5/11-STF	1910610	275	FKCN 2,5/12-ST	1732836	278	FKCT 2,5/ 2-ST	1909210	277
FKC 2,5/ 2-STF-5,08 EX	1795996	371	FKC 2,5/11-STF-5,08	1873294	275	FKCN 2,5/12-ST-5,08	1754665	278	FKCT 2,5/ 2-ST-5,08	1902110	277
FKC 2,5/ 3-ST	1910364	274	FKC 2,5/11-STF-5,08 EX	1796089	371	FKCN 2,5/12-STF	1733055	279	FKCT 2,5/ 3-ST	1909401	277
FKC 2,5/ 3-ST-5,08	1873061	274	FKC 2,5/12-ST	1910458	274	FKCN 2,5/12-STF-5,08	1754898	279	FKCT 2,5/ 2-STF-5,08	1902301	277
FKC 2,5/ 3-ST-5,08-LR	1792520	275	FKC 2,5/12-ST-5,08	1873155	274	FKCN 2,5/13-ST	1732849	278	FKCT 2,5/ 3-ST	1909223	277
FKC 2,5/ 3-ST-5,08-RF	1925702	275	FKC 2,5/12-ST-5,08-LR	1792614	275	FKCN 2,5/13-ST-5,08	1754678	278	FKCT 2,5/ 3-ST-5,08	1902123	277
FKC 2,5/ 3-ST-5,08-RF EX	1796115	371	FKC 2,5/12-ST-5,08-RF	1925799	275	FKCN 2,5/13-STF	1733068	279	FKCT 2,5/ 4-STF	1909414	277
FKC 2,5/ 3-ST-RF	1947065	275	FKC 2,5/12-ST-5,08-RF EX	1796209	371	FKCN 2,5/13-STF-5,08	1754908	279	FKCT 2,5/ 3-STF-5,08	1902314	277
FKC 2,5/ 3-STF	1910539	275	FKC 2,5/12-ST-RF	1947159	275	FKCN 2,5/14-ST	1732852	278	FKCT 2,5/ 4-ST	1909236	277
FKC 2,5/ 3-STF-5,08	1873210	275	FKC 2,5/12-STF	1910623	275	FKCN 2,5/14-ST-5,08	1754681	278	FKCT 2,5/ 4-ST-5,08	1902136	277
FKC 2,5/ 3-STF-5,08 EX	1796005	371	FKC 2,5/12-STF-5,08	1873304	275	FKCN 2,5/14-STF	1733071	279	FKCT 2,5/ 5-STF	1909427	277
FKC 2,5/ 4-ST	1910377	274	FKC 2,5/12-STF-5,08 EX	1796092	371	FKCN 2,5/14-STF-5,08	1754911	279	FKCT 2,5/ 4-STF-5,08	1902327	277
FKC 2,5/ 4-ST-5,08	1873074	274	FKC 2,5/13-ST	1910461	274	FKCN 2,5/15-ST	1732865	278	FKCT 2,5/ 5-ST	1909249	277
FKC 2,5/ 4-ST-5,08-LR	1792533	275	FKC 2,5/13-ST-5,08	1873168	274	FKCN 2,5/15-ST-5,08	1754694	278	FKCT 2,5/ 5-ST-5,08	1902149	277
FKC 2,5/ 4-ST-5,08-RF	1925715	275	FKC 2,5/13-ST-5,08-LR	1810900	275	FKCN 2,5/15-STF	1733084	279	FKCT 2,5/ 5-STF	1909430	277
FKC 2,5/ 4-ST-5,08-RF EX	1796128	371	FKC 2,5/13-ST-5,08-RF	1925809	275	FKCN 2,5/15-STF-5,08	1754924	279	FKCT 2,5/ 5-STF-5,08	1902330	277
FKC 2,5/ 4-ST-RF	1947078	275	FKC 2,5/13-ST-RF	1947162	275	FKCN 2,5/16-ST	1732878	278	FKCT 2,5/ 6-ST	1909252	277
FKC 2,5/ 4-STF	1910542	275	FKC 2,5/13-STF	1910636	275	FKCN 2,5/16-ST-5,08	1754704	278	FKCT 2,5/ 6-ST-5,08	1902152	277
FKC 2,5/ 4-STF-5,08	1873223	275	FKC 2,5/13-STF-5,08	1873317	275	FKCN 2,5/16-STF	1733097	279	FKCT 2,5/ 6-STF	1909443	277
FKC 2,5/ 4-STF-5,08 EX	1796018	371	FKC 2,5/14-ST	1910474	274	FKCN 2,5/16-STF-5,08	1754937	279	FKCT 2,5/ 6-STF-5,08	1902343	277
FKC 2,5/ 5-ST	1910380	274	FKC 2,5/14-ST-5,08	1873171	274	FKCS 2,5/ 2-ST	1974737	276	FKCT 2,5/ 7-ST	1909265	277
FKC 2,5/ 5-ST-5,08	1873087	274	FKC 2,5/14-ST-5,08-LR	1810913	275	FKCS 2,5/ 2-ST-5,08	1975079	276	FKCT 2,5/ 7-ST-5,08	1902165	277
FKC 2,5/ 5-ST-5,08-LR	1792546	275	FKC 2,5/14-ST-5,08-RF	1925812	275	FKCS 2,5/ 2-STF	1974928	277	FKCT 2,5/ 7-STF	1909456	277
FKC 2,5/ 5-ST-5,08-RF	1925728	275	FKC 2,5/14-ST-5,08-RF EX	1947175	275	FKCS 2,5/ 2-STF-5,08	1975260	277	FKCT 2,5/ 7-STF-5,08	1902356	277
FKC 2,5/ 5-ST-5,08-RF EX	1796131	371	FKC 2,5/14-STF	1910649	275	FKCS 2,5/ 3-ST	1974740	276	FKCT 2,5/ 8-ST	1909278	277
FKC 2,5/ 5-ST-RF	1947081	275	FKC 2,5/14-STF-5,08	1873320	275	FKCS 2,5/ 3-ST-5,08	1975082	276	FKCT 2,5/ 8-ST-5,08	1902178	277
FKC 2,5/ 5-STF	1910555	275	FKC 2,5/15-ST	1910487	274	FKCS 2,5/ 3-STF	1974931	277	FKCT 2,5/ 8-STF	1909469	277
FKC 2,5/ 5-STF-5,08	1873236	275	FKC 2,5/15-ST-5,08	1873184	274	FKCS 2,5/ 3-STF-5,08	1975273	277	FKCT 2,5/ 8-STF-5,08	1902369	277
FKC 2,5/ 5-STF-5,08 EX	1796021	371	FKC 2,5/15-ST-5,08-LR	1810926	275	FKCS 2,5/ 4-ST	1974753	276	FKCT 2,5/ 9-ST	1909281	277
FKC 2,5/ 6-ST	1910393	274	FKC 2,5/15-ST-5,08-RF	1925825	275	FKCS 2,5/ 4-ST-5,08	1975095	276	FKCT 2,5/ 9-ST-5,08	1902181	277
FKC 2,5/ 6-ST-5,08	1873090	274	FKC 2,5/15-ST-RF	1947188	275	FKCS 2,5/ 4-STF	1974944	277	FKCT 2,5/ 9-STF	1909472	277
FKC 2,5/ 6-ST-5,08-LR	1792559	275	FKC 2,5/15-STF	1910652	275	FKCS 2,5/ 4-STF-5,08	1975286	277	FKCT 2,5/ 9-STF-5,08	1902372	277
FKC 2,5/ 6-ST-5,08-RF	1925731	275	FKC 2,5/15-STF-5,08	1873333	275	FKCS 2,5/ 5-ST	1974766	276	FKCT 2,5/10-ST	1909294	277
FKC 2,5/ 6-ST-5,08-RF EX	1796144	371	FKC 2,5/16-ST	1910490	274	FKCS 2,5/ 5-ST-5,08	1975105	276	FKCT 2,5/10-ST-5,08	1902194	277
FKC 2,5/ 6-ST-RF	1947094	275	FKC 2,5/16-ST-5,08	1873197	274	FKCS 2,5/ 5-STF	1974957	277	FKCT 2,5/10-STF	1909485	277
FKC 2,5/ 6-STF	1910568	275	FKC 2,5/16-ST-5,08-LR	1810939	275	FKCS 2,5/ 5-STF-5,08	1975299	277	FKCT 2,5/10-STF-5,08	1902385	277
FKC 2,5/ 6-STF-5,08	1873249	275	FKC 2,5/16-ST-5,08-RF	1925838	275	FKCS 2,5/ 6-ST	1974779	276	FKCT 2,5/11-ST	1909304	277
FKC 2,5/ 6-STF-5,08 EX	1796034	371	FKC 2,5/16-ST-RF	1947191	275	FKCS 2,5/ 6-ST-5,08	1975118	276	FKCT 2,5/11-ST-5,08	1902204	277
FKC 2,5/ 7-ST	1910403	274	FKC 2,5/16-STF	1910665	275	FKCS 2,5/ 6-STF	1974960	277	FKCT 2,5/11-STF	1909498	277
FKC 2,5/ 7-ST-5,08	1873100	274	FKC 2,5/16-STF-5,08	1873346	275	FKCS 2,5/ 6-STF-5,08	1975309	277	FKCT 2,5/11-STF-5,08	1902398	277
FKC 2,5/ 7-ST-5,08-LR	1792562	275	FKCN 2,5/ 2-ST	1732742	278	FKCS 2,5/ 7-ST	1974782	276	FKCT 2,5/12-ST	1909317	277
FKC 2,5/ 7-ST-5,08-RF	1925744	275	FKCN 2,5/ 2-ST-5,08	1754568	278	FKCS 2,5/ 7-ST-5,08	1975121	276	FKCT 2,5/12-ST-5,08	1902217	277
FKC 2,5/ 7-ST-5,08-RF EX	1796157	371	FKCN 2,5/ 2-STF	1732962	279	FKCS 2,5/ 7-STF	1974973	277	FKCT 2,5/12-STF	1909508	277
FKC 2,5/ 7-ST-RF	1947104	275	FKCN 2,5/ 2-STF-5,08	1754791	279	FKCS 2,5/ 7-STF-5,08	1975312	277	FKCT 2,5/12-STF-5,08	1902408	277
FKC 2,5/ 7-STF	1910571	275	FKCN 2,5/ 3-ST	1732755	278	FKCS 2,5/ 8-ST	1974795	276	FKCT 2,5/13-ST	1909320	277
FKC 2,5/ 7-STF-5,08	1873252	275	FKCN 2,5/ 3-ST-5,08	1754571	278	FKCS 2,5/ 8-ST-5,08	1975134	276	FKCT 2,5/13-ST-5,08	1902220	277
FKC 2,5/ 7-STF-5,08 EX	1796047	371	FKCN 2,5/ 3-STF	1732975	279	FKCS 2,5/ 8-STF	1974986	277	FKCT 2,5/13-STF	1909511	277
FKC 2,5/ 8-ST	1910416	274	FKCN 2,5/ 3-STF-5,08	1754801	279	FKCS 2,5/ 8-STF-5,08	1975325	277	FKCT 2,5/13-STF-5,08	1902411	277
FKC 2,5/ 8-ST-5,08	1873113	274	FKCN 2,5/ 4-ST	1732768	278	FKCS 2,5/ 9-ST	1974805	276	FKCT 2,5/14-ST	1909333	277
FKC 2,5/ 8-ST-5,08-LR	1792575	275	FKCN 2,5/ 4-ST-5,08	1754584	278	FKCS 2,5/ 9-ST-5,08	1975147	276	FKCT 2,5/14-ST-5,08	1902233	277
FKC 2,5/ 8-ST-5,08-RF	1925757	275	FKCN 2,5/ 4-STF	1732988	279	FKCS 2,5/ 9-STF	1974999	277	FKCT 2,5/14-STF	1909524	277
FKC 2,5/ 8-ST-5,08-RF EX	1796160	371	FKCN 2,5/ 4-STF-5,08	1754814	279	FKCS 2,5/ 9-STF-5,08	1975338	277	FKCT 2,5/14-STF-5,08	1902424	277
FKC 2,5/ 8-ST-RF	1947117	275	FKCN 2,5/ 5-ST	1732771	278	FKCS 2,5/10-ST	1974818	276	FKCT 2,5/15-ST	1909346	277
FKC 2,5/ 8-STF	1910584	275	FKCN 2,5/ 5-ST-5,08	1754597	278	FKCS 2,5/10-ST-5,08	1975150	276	FKCT 2,5/15-ST-5,08	1902246	277
FKC 2,5/ 8-STF-5,08	1873265	275	FKCN 2,5/ 5-STF	1732991	279	FKCS 2,5/10-STF	1975008	277	FKCT 2,5/15-STF	1909537	277
FKC 2,5/ 8-STF-5,08 EX	1796050	371	FKCN 2,5/ 5-STF-5,08	1754827	279	FKCS 2,5/10-STF-5,08	1975341	277	FKCT 2,5/15-STF-5,08	1902437	277
FKC 2,5/ 9-ST	1910429	274	FKCN 2,5/ 6-ST	1732784	278	FKCS 2,5/11-ST	1974821	276	FKCT 2,5/16-ST	1909359	277
FKC 2,5/ 9-ST-5,08	1873126	274	FKCN 2,5/ 6-ST-5,08	1754607	278	FKCS 2,5/11-ST-5,08	1975163	276	FKCT 2,5/16-ST-5,08	1902259	277
FKC 2,5/ 9-ST-5,08-LR	1792588	275	FKCN 2,5/ 6-STF	1733000	279	FKCS 2,5/11-STF	1975011	277	FKCT 2,5/16-STF	1909540	277
FKC 2											

Type	Order No.	Page	Type	Order No.	Page	Type	Order No.	Page	Type	Order No.	Page
FKCVR 2,5/ 3-STF-5,08	1874112	281	FKCVW 2,5/ 9-STF-5,08	1873870	281	FKIC 2,5/ 5-STF-5,08 EX	1810256	373	FKICS 2,5/ 5-STD-5,08-RN	1808750	289
FKCVR 2,5/ 4-ST	1909731	280	FKCVW 2,5/10-ST	1910115	281	FKIC 2,5/ 6-ST	1910717	286	FKICS 2,5/ 5-STF	1981623	289
FKCVR 2,5/ 4-ST-5,08	1873977	280	FKCVW 2,5/10-ST-5,08	1873731	281	FKIC 2,5/ 6-ST-5,08	1873391	286	FKICS 2,5/ 5-STF-5,08	1981924	289
FKCVR 2,5/ 4-STF	1909906	281	FKCVW 2,5/10-STF	1910283	281	FKIC 2,5/ 6-ST-5,08-RN	1925906	287	FKICS 2,5/ 6-ST	1981487	288
FKCVR 2,5/ 4-STF-5,08	1874125	281	FKCVW 2,5/10-STF-5,08	1873883	281	FKIC 2,5/ 6-STF	1910869	287	FKICS 2,5/ 6-ST-5,08	1981788	288
FKCVR 2,5/ 5-ST	1909744	280	FKCVW 2,5/11-ST	1910128	281	FKIC 2,5/ 6-STF-5,08	1873540	287	FKICS 2,5/ 6-STD-5,08-RN	1808763	289
FKCVR 2,5/ 5-ST-5,08	1873980	280	FKCVW 2,5/11-ST-5,08	1873741	281	FKIC 2,5/ 6-STF-5,08 EX	1810269	373	FKICS 2,5/ 6-STF	1981636	289
FKCVR 2,5/ 5-STF	1909919	281	FKCVW 2,5/11-STF	1910296	281	FKIC 2,5/ 7-ST	1910720	286	FKICS 2,5/ 6-STF-5,08	1981937	289
FKCVR 2,5/ 5-STF-5,08	1874138	281	FKCVW 2,5/11-STF-5,08	1873896	281	FKIC 2,5/ 7-ST-5,08	1873401	286	FKICS 2,5/ 7-ST	1981940	288
FKCVR 2,5/ 6-ST-5,08	1873993	280	FKCVW 2,5/12-ST	1910131	281	FKIC 2,5/ 7-ST-5,08-RN	1925919	287	FKICS 2,5/ 7-ST-5,08	1981791	288
FKCVR 2,5/ 6-STF-5,08	1874141	281	FKCVW 2,5/12-ST-5,08	1873757	281	FKIC 2,5/ 7-STF	1910872	287	FKICS 2,5/ 7-STD-5,08-RN	1808776	289
FKCVR 2,5/ 7-ST	1909760	280	FKCVW 2,5/12-STF	1910306	281	FKIC 2,5/ 7-STF-5,08	1873553	287	FKICS 2,5/ 7-STF	1981649	289
FKCVR 2,5/ 7-ST-5,08	1874002	280	FKCVW 2,5/12-STF-5,08	1873906	281	FKIC 2,5/ 7-STF-5,08 EX	1810272	373	FKICS 2,5/ 7-STF-5,08	1981940	289
FKCVR 2,5/ 7-STF	1909935	281	FKCVW 2,5/13-ST	1910144	281	FKIC 2,5/ 8-ST	1910733	286	FKICS 2,5/ 8-ST	1981500	288
FKCVR 2,5/ 7-STF-5,08	1874154	281	FKCVW 2,5/13-ST-5,08	1873760	281	FKIC 2,5/ 8-ST-5,08	1873414	286	FKICS 2,5/ 8-ST-5,08	1981801	288
FKCVR 2,5/ 8-ST	1909773	280	FKCVW 2,5/13-STF	1910319	281	FKIC 2,5/ 8-ST-5,08-RN	1925922	287	FKICS 2,5/ 8-STD-5,08-RN	1808789	289
FKCVR 2,5/ 8-ST-5,08	1874015	280	FKCVW 2,5/13-STF-5,08	1873919	281	FKIC 2,5/ 8-STF	1910885	287	FKICS 2,5/ 8-STF	1981652	289
FKCVR 2,5/ 9-STF	1909948	281	FKCVW 2,5/14-ST	1910157	281	FKIC 2,5/ 8-STF-5,08	1873566	287	FKICS 2,5/ 8-STF-5,08	1981953	289
FKCVR 2,5/ 9-STF-5,08	1874167	281	FKCVW 2,5/14-ST-5,08	1873773	281	FKIC 2,5/ 8-STF-5,08 EX	1810285	373	FKICS 2,5/ 9-ST	1981513	288
FKCVR 2,5/ 9-ST	1909786	280	FKCVW 2,5/14-STF	1910322	281	FKIC 2,5/ 9-ST	1910746	286	FKICS 2,5/ 9-ST-5,08	1981814	288
FKCVR 2,5/ 9-ST-5,08	1874028	280	FKCVW 2,5/14-STF-5,08	1873922	281	FKIC 2,5/ 9-ST-5,08	1873427	286	FKICS 2,5/ 9-STD-5,08-RN	1808792	289
FKCVR 2,5/ 9-STF	1909951	281	FKCVW 2,5/15-ST	1910160	281	FKIC 2,5/ 9-ST-5,08-RN	1925935	287	FKICS 2,5/ 9-STF	1981665	289
FKCVR 2,5/ 9-STF-5,08	1874170	281	FKCVW 2,5/15-ST-5,08	1873786	281	FKIC 2,5/ 9-STF	1910898	287	FKICS 2,5/ 9-STF-5,08	1981966	289
FKCVR 2,5/10-ST	1909799	280	FKCVW 2,5/15-STF	1910335	281	FKIC 2,5/ 9-STF-5,08	1873579	287	FKICS 2,5/10-ST	1981526	288
FKCVR 2,5/10-ST-5,08	1874031	280	FKCVW 2,5/15-STF-5,08	1873935	281	FKIC 2,5/ 9-STF-5,08 EX	1810298	373	FKICS 2,5/10-ST-5,08	1981827	288
FKCVR 2,5/10-STF	1909964	281	FKCVW 2,5/16-ST	1910173	281	FKIC 2,5/10-ST	1910759	286	FKICS 2,5/10-STD-5,08-RN	1808802	289
FKCVR 2,5/10-STF-5,08	1874183	281	FKCVW 2,5/16-ST-5,08	1873799	281	FKIC 2,5/10-ST-5,08	1873430	286	FKICS 2,5/10-STF	1981678	289
FKCVR 2,5/11-ST	1909809	280	FKCVW 2,5/16-STF	1910348	281	FKIC 2,5/10-ST-5,08-RN	1925948	287	FKICS 2,5/10-STF-5,08	1981979	289
FKCVR 2,5/11-ST-5,08	1874044	280	FKCVW 2,5/16-STF-5,08	1873948	281	FKIC 2,5/10-STF	1910908	287	FKICS 2,5/11-ST	1981539	288
FKCVR 2,5/11-STF	1909977	281	FKDSD 2,5/ 2-L KMGY	2200315	153	FKIC 2,5/10-STF-5,08	1873582	287	FKICS 2,5/11-ST-5,08	1981830	288
FKCVR 2,5/11-STF-5,08	1874196	281	FKDSD 2,5/ 2-R KMGY	2200316	153	FKIC 2,5/10-STF-5,08 EX	1810308	373	FKICS 2,5/11-STD-5,08-RN	1808815	289
FKCVR 2,5/12-ST	1909812	280	FKDSD 2,5/ 3-L KMGY	2200318	153	FKIC 2,5/11-ST	1910762	286	FKICS 2,5/11-STF	1981681	289
FKCVR 2,5/12-ST-5,08	1874057	280	FKDSD 2,5/ 3-R KMGY	2200317	153	FKIC 2,5/11-ST-5,08	1873443	286	FKICS 2,5/11-STF-5,08	1981982	289
FKCVR 2,5/12-STF	1909980	281	FKDSD 2,5/ 4-L KMGY	2200319	153	FKIC 2,5/11-ST-5,08-RN	1925951	287	FKICS 2,5/12-ST	1981542	288
FKCVR 2,5/12-STF-5,08	1874206	281	FKDSD 2,5/ 4-R KMGY	2200320	153	FKIC 2,5/11-STF	1910911	287	FKICS 2,5/12-ST-5,08	1981843	288
FKCVR 2,5/13-ST	1909825	280	FKIC 2,5 HC/ 2-ST-5,08	1942594	495	FKIC 2,5/11-STF-5,08	1873595	287	FKICS 2,5/12-STD-5,08-RN	1808828	289
FKCVR 2,5/13-ST-5,08	1874060	280	FKIC 2,5 HC/ 2-STF-5,08	1942701	495	FKIC 2,5/11-STF-5,08 EX	1810311	373	FKICS 2,5/12-STF	1981694	289
FKCVR 2,5/13-STF	1909993	281	FKIC 2,5 HC/ 3-ST-5,08	1942604	495	FKIC 2,5/12-ST	1910775	286	FKICS 2,5/12-STF-5,08	1981995	289
FKCVR 2,5/13-STF-5,08	1874219	281	FKIC 2,5 HC/ 3-STF-5,08	1942714	495	FKIC 2,5/12-ST-5,08	1873456	286	FKICS 2,5/13-ST	1981555	288
FKCVR 2,5/14-ST	1909838	280	FKIC 2,5 HC/ 4-ST-5,08	1942617	495	FKIC 2,5/12-ST-5,08-RN	1925964	287	FKICS 2,5/13-ST-5,08	1981856	288
FKCVR 2,5/14-ST-5,08	1874073	280	FKIC 2,5 HC/ 4-STF-5,08	1942727	495	FKIC 2,5/12-STF	1910924	287	FKICS 2,5/13-STD-5,08-RN	1808831	289
FKCVR 2,5/14-STF	1910005	281	FKIC 2,5 HC/ 5-ST-5,08	1942620	495	FKIC 2,5/12-STF-5,08	1873605	287	FKICS 2,5/13-STF	1981704	289
FKCVR 2,5/14-STF-5,08	1874222	281	FKIC 2,5 HC/ 5-STF-5,08	1942730	495	FKIC 2,5/12-STF-5,08 EX	1810324	373	FKICS 2,5/13-STF-5,08	1982004	289
FKCVR 2,5/15-ST	1909841	280	FKIC 2,5 HC/ 6-ST-5,08	1942633	495	FKIC 2,5/13-ST	1910788	286	FKICS 2,5/14-ST	1981568	288
FKCVR 2,5/15-ST-5,08	1874086	280	FKIC 2,5 HC/ 6-STF-5,08	1942743	495	FKIC 2,5/13-ST-5,08	1873469	286	FKICS 2,5/14-ST-5,08	1981869	288
FKCVR 2,5/15-STF	1910018	281	FKIC 2,5 HC/ 7-ST-5,08	1942646	495	FKIC 2,5/13-ST-5,08-RN	1925977	287	FKICS 2,5/14-STD-5,08-RN	1808844	289
FKCVR 2,5/15-STF-5,08	1874235	281	FKIC 2,5 HC/ 7-STF-5,08	1942756	495	FKIC 2,5/13-STF	1910937	287	FKICS 2,5/14-STF	1981717	289
FKCVR 2,5/16-ST	1909854	280	FKIC 2,5 HC/ 8-ST-5,08	1942659	495	FKIC 2,5/13-STF-5,08	1873618	287	FKICS 2,5/14-STF-5,08	1982017	289
FKCVR 2,5/16-ST-5,08	1874099	280	FKIC 2,5 HC/ 8-STF-5,08	1942769	495	FKIC 2,5/14-ST	1910791	286	FKICS 2,5/15-ST	1981571	288
FKCVR 2,5/16-STF	1910021	281	FKIC 2,5 HC/ 9-ST-5,08	1942662	495	FKIC 2,5/14-ST-5,08	1873472	286	FKICS 2,5/15-ST-5,08	1981872	288
FKCVR 2,5/16-STF-5,08	1874248	281	FKIC 2,5 HC/ 9-STF-5,08	1942772	495	FKIC 2,5/14-ST-5,08-RN	1925980	287	FKICS 2,5/15-STD-5,08-RN	1808857	289
FKCVW 2,5/ 2-ST	1910034	281	FKIC 2,5 HC/10-ST-5,08	1942675	495	FKIC 2,5/14-STF	1910940	287	FKICS 2,5/15-STF	1981720	289
FKCVW 2,5/ 2-ST-5,08	1873650	281	FKIC 2,5 HC/10-STF-5,08	1942785	495	FKIC 2,5/14-STF-5,08	1873621	287	FKICS 2,5/15-STF-5,08	1982020	289
FKCVW 2,5/ 2-STF	1910209	281	FKIC 2,5 HC/11-ST-5,08	1942688	495	FKIC 2,5/15-ST	1910801	286	FKICS 2,5/16-ST	1981584	288
FKCVW 2,5/ 2-STF-5,08	1873809	281	FKIC 2,5 HC/11-STF-5,08	1942798	495	FKIC 2,5/15-ST-5,08	1873485	286	FKICS 2,5/16-ST-5,08	1981885	288
FKCVW 2,5/ 3-ST	1910047	281	FKIC 2,5 HC/12-ST-5,08	1942691	495	FKIC 2,5/15-ST-5,08-RN	1925993	287	FKICS 2,5/16-STD-5,08-RN	1808860	289
FKCVW 2,5/ 3-ST-5,08	1873663	281	FKIC 2,5 HC/12-STF-5,08	1942808	495	FKIC 2,5/15-STF	1910953	287	FKICS 2,5/16-STF	1981733	289
FKCVW 2,5/ 3-STF	1910212	281	FKIC 2,5/ 2-ST	1910678	286	FKIC 2,5/15-STF-5,08	1873634	287	FKICS 2,5/16-STF-5,08	1982033	289
FKCVW 2,5/ 3-STF-5,08	1873812	281	FKIC 2,5/ 2-ST-5,08	1873359	286	FKIC 2,5/16-ST	1910814	286	FLRP/ICV 80	1808353	837
FKCVW 2,5/ 4-ST	1910050	281	FKIC 2,5/ 2-ST-5,08-RN	1925867	287	FKIC 2,5/16-ST-5,08	1873498	286	FMC 0,5/ 2-ST-2,54	1821096	174
FKCVW 2,5/ 4-ST-5,08	1873676	281	FKIC 2,5/ 2-STF	1910827	287	FKIC 2,5/16-ST-5,08-RN	1926002	287	FMC 0,5/ 2-ST-2,54 C1	1706263	175
FKCVW 2,5/ 4-STF	1910225	281	FKIC 2,5/ 2-STF-5,08	1873508	287	FKIC 2,5/16-STF	1910966	287	FMC 0,5/ 2-ST-2,54 C2	1706243	175
FKCVW 2,5/ 4-STF-5,08	1873825	281	FKIC 2,5/ 2-STF-5,08 EX	1810227	373	FKIC 2,5/16-STF-5,08	1873647	287	FMC 0,5/ 3-ST-2,54	1821106	174
FKCVW 2,5/ 5-ST	1910063	281	FKIC 2,5/ 3-ST	1910681	286	FKICS 2,5/ 2-ST	1981445	288	FMC 0,5/ 3-ST-2,54 C1	1706262	175
FKCVW 2,5/ 5-ST-5,08	1873689	281	FKIC 2,5/ 3-ST-5,08	1873362	286	FKICS 2,5/ 2-ST-5,08	1981746	288	FMC 0,5/ 3-ST-2,54 C2	1706242	175
FKCVW 2,5/ 5-STF	1910238	281	FKIC 2,5/ 3-ST-5,08-RN	1925870	287	FKICS 2,5/ 2-STD-5,08-RN	1808721	289	FMC 0,5/ 4-ST-2,54	1821119	174
FKCVW 2,5/ 5-STF-5,08	1873838	281	FKIC 2,5/ 3-STF	1910830	287	FKICS 2,5/ 2-STF	1981597	289	FMC 0,5/ 4-ST-2,54 C1	1706261	175
FKCVW 2,5/ 6-ST-5,08	1873692	281	FKIC 2,5/ 3-STF-5,08	1873511	287	FKICS 2,5/ 2-STF-5,08	1981898	289	FMC 0,5/ 4-ST-2,54 C2	1706241	175
FKCVW 2,5/ 6-STF-5,08	1873841	281	FKIC 2,5/ 3-STF-5,08 EX	1810230	373	FKICS 2,5/ 3-ST	1981458	288	FMC 0,5/ 5-ST-2,54	1821122	174

Index

Alphabetical

Type	Order No.	Page	Type	Order No.	Page	Type	Order No.	Page	Type	Order No.	Page
FMC 0,5/9-ST-2,54	1821164	174	FMC 1,5/13-ST-3,5-RF	1952131	201	FRONT 2,5-V/SA10/9	1704907	115	FRONT-MSTB 2,5/ 7-ST	1779466	269
FMC 0,5/9-ST-2,54 C1	1706254	175	FMC 1,5/13-ST-3,81	1748082	200	FRONT 2,5-V/SA10/10	1700778	115	FRONT-MSTB 2,5/ 7-ST-5,08	1777332	269
FMC 0,5/9-ST-2,54 C2	1706236	175	FMC 1,5/13-STF-3,5	1966208	201	FRONT 2,5-V/SA10/11	1773293	115	FRONT-MSTB 2,5/ 7-STF	1779699	269
FMC 0,5/10-ST-2,54	1821177	174	FMC 1,5/13-STF-3,81	1748464	201	FRONT 2,5-V/SA10/12	1931741	115	FRONT-MSTB 2,5/ 7-STF-5,08	1777853	269
FMC 0,5/10-ST-2,54 C1	1706253	175	FMC 1,5/14-ST-3,5	1952380	200	FRONT 4-H-6,35	1703050	459	FRONT-MSTB 2,5/ 8-ST	1779479	269
FMC 0,5/10-ST-2,54 C2	1706234	175	FMC 1,5/14-ST-3,5-RF	1952144	201	FRONT 4-H-7,62	1703034	461	FRONT-MSTB 2,5/ 8-ST-5,08	1777345	269
FMC 0,5/11-ST-2,54	1821180	174	FMC 1,5/14-ST-3,81	1748095	200	FRONT 4-V-6,35	1703063	459	FRONT-MSTB 2,5/ 8-STF	1779709	269
FMC 0,5/11-ST-2,54 C1	1706252	175	FMC 1,5/14-STF-3,5	1966211	201	FRONT 4-V-7,62	1703021	461	FRONT-MSTB 2,5/ 8-STF-5,08	1777798	269
FMC 0,5/11-ST-2,54 C2	1706233	175	FMC 1,5/14-STF-3,81	1748477	201	FRONT-GMSTB 2,5/ 2-ST-7,62	1806119	335	FRONT-MSTB 2,5/ 9-ST	1779482	269
FMC 0,5/12-ST-2,54	1821193	174	FMC 1,5/15-ST-3,5	1952393	200	FRONT-GMSTB 2,5/ 2-STF-7,62	1805987	335	FRONT-MSTB 2,5/ 9-ST-5,08	1777358	269
FMC 0,5/12-ST-2,54 C1	1706250	175	FMC 1,5/15-ST-3,5-RF	1952157	201	FRONT-GMSTB 2,5/ 3-ST-7,62	1806122	335	FRONT-MSTB 2,5/ 9-STF	1779712	269
FMC 0,5/12-ST-2,54 C2	1706232	175	FMC 1,5/15-ST-3,81	1748105	200	FRONT-GMSTB 2,5/ 3-STF-7,62	1805990	335	FRONT-MSTB 2,5/ 9-STF-5,08	1777866	269
FMC 0,5/13-ST-2,54	1821203	174	FMC 1,5/15-STF-3,5	1966224	201	FRONT-GMSTB 2,5/ 4-ST-7,62	1806135	335	FRONT-MSTB 2,5/ 10-ST	1779495	269
FMC 0,5/13-ST-2,54 C1	1706249	175	FMC 1,5/15-STF-3,81	1748480	201	FRONT-GMSTB 2,5/ 4-STF-7,62	1806009	335	FRONT-MSTB 2,5/ 10-ST-5,08	1777361	269
FMC 0,5/13-ST-2,54 C2	1706230	175	FMC 1,5/16-ST-3,5	1952403	200	FRONT-GMSTB 2,5/ 5-ST-7,62	1806148	335	FRONT-MSTB 2,5/ 10-STF	1779725	269
FMC 0,5/14-ST-2,54	1821216	174	FMC 1,5/16-ST-3,5-RF	1952160	201	FRONT-GMSTB 2,5/ 5-STF-7,62	1806038	335	FRONT-MSTB 2,5/ 10-STF-5,08	1777879	269
FMC 0,5/14-ST-2,54 C1	1706247	175	FMC 1,5/16-ST-3,81	1748118	200	FRONT-GMSTB 2,5/ 6-ST-7,62	1806151	335	FRONT-MSTB 2,5/ 11-ST	1779505	269
FMC 0,5/14-ST-2,54 C2	1706229	175	FMC 1,5/16-STF-3,5	1966237	201	FRONT-GMSTB 2,5/ 6-STF-7,62	1806041	335	FRONT-MSTB 2,5/ 11-ST-5,08	1777374	269
FMC 0,5/15-ST-2,54	1821229	174	FMC 1,5/16-STF-3,81	1748493	201	FRONT-GMSTB 2,5/ 7-ST-7,62	1806164	335	FRONT-MSTB 2,5/ 11-STF	1779738	269
FMC 0,5/15-ST-2,54 C1	1706246	175	FMCD 1,5/ 3-ST-3,5	1738814	201	FRONT-GMSTB 2,5/ 7-STF-7,62	1806054	335	FRONT-MSTB 2,5/ 11-STF-5,08	1777882	269
FMC 0,5/15-ST-2,54 C2	1706227	175	FMCD 1,5/ 4-ST-3,5	1738827	201	FRONT-GMSTB 2,5/ 8-ST-7,62	1806177	335	FRONT-MSTB 2,5/ 12-ST	1779518	269
FMC 0,5/16-ST-2,54	1821232	174	FMCD 1,5/ 5-ST-3,5	1738830	201	FRONT-GMSTB 2,5/ 8-STF-7,62	1806067	335	FRONT-MSTB 2,5/ 12-ST-5,08	1777387	269
FMC 0,5/16-ST-2,54 C1	1706245	175	FMCD 1,5/ 6-ST-3,5	1738843	201	FRONT-GMSTB 2,5/ 9-ST-7,62	1806180	335	FRONT-MSTB 2,5/ 12-STF	1779741	269
FMC 0,5/16-ST-2,54 C2	1706226	175	FMCD 1,5/ 7-ST-3,5	1738856	201	FRONT-GMSTB 2,5/ 9-STF-7,62	1806070	335	FRONT-MSTB 2,5/ 12-STF-5,08	1777895	269
FMC 1,5/ 2-ST-3,5	1952267	200	FMCD 1,5/ 8-ST-3,5	1738869	201	FRONT-GMSTB 2,5/ 10-ST-7,62	1806193	335	FRONT-MSTB 2,5/ 13-ST	1779521	269
FMC 1,5/ 2-ST-3,5-RF	1952021	201	FMCD 1,5/ 9-ST-3,5	1738872	201	FRONT-GMSTB 2,5/ 10-STF-7,62	1806083	335	FRONT-MSTB 2,5/ 13-ST-5,08	1777390	269
FMC 1,5/ 2-ST-3,81	1745894	200	FMCD 1,5/ 10-ST-3,5	1738885	201	FRONT-GMSTB 2,5/ 11-ST-7,62	1806203	335	FRONT-MSTB 2,5/ 13-STF	1779754	269
FMC 1,5/ 2-STF-3,5	1966091	201	FMCD 1,5/ 11-ST-3,5	1738898	201	FRONT-GMSTB 2,5/ 11-STF-7,62	1806096	335	FRONT-MSTB 2,5/ 13-STF-5,08	1777905	269
FMC 1,5/ 2-STF-3,81	1748354	201	FMCD 1,5/ 12-ST-3,5	1738908	201	FRONT-GMSTB 2,5/ 12-ST-7,62	1806216	335	FRONT-MSTB 2,5/ 14-ST	1779534	269
FMC 1,5/ 3-ST-3,5	1952270	200	FMCD 1,5/ 13-ST-3,5	1738911	201	FRONT-GMSTB 2,5/ 12-STF-7,62	1806106	335	FRONT-MSTB 2,5/ 14-ST-5,08	1777400	269
FMC 1,5/ 3-ST-3,5-RF	1952034	201	FMCD 1,5/ 14-ST-3,5	1738924	201	FRONT-MC 1,5/ 2-ST-3,81	1850660	194	FRONT-MSTB 2,5/ 14-STF	1779767	269
FMC 1,5/ 3-STF-3,5	1745904	200	FMCD 1,5/ 15-ST-3,5	1738937	201	FRONT-MC 1,5/ 2-STF-3,81	1850851	195	FRONT-MSTB 2,5/ 14-STF-5,08	1777918	269
FMC 1,5/ 3-STF-3,5	1966101	201	FMCD 1,5/ 16-ST-3,5	1738940	201	FRONT-MC 1,5/ 3-ST-3,81	1850673	194	FRONT-MSTB 2,5/ 15-ST	1779547	269
FMC 1,5/ 3-STF-3,81	1748367	201	FOPT 2,2-R	1907924	436	FRONT-MC 1,5/ 3-STF-3,81	1850864	195	FRONT-MSTB 2,5/ 15-ST-5,08	1777413	269
FMC 1,5/ 4-ST-3,5	1952283	200	FOPT 2,2-T	1907911	437	FRONT-MC 1,5/ 4-ST-3,81	1850686	194	FRONT-MSTB 2,5/ 15-STF	1779770	269
FMC 1,5/ 4-ST-3,5-RF	1952047	201	FRONT 2,5-H/SA 5	1700008	738	FRONT-MC 1,5/ 4-STF-3,81	1850877	195	FRONT-MSTB 2,5/ 15-STF-5,08	1777921	269
FMC 1,5/ 4-ST-3,81	1745917	200	FRONT 2,5-H/SA 5-EX	1701159	158	FRONT-MC 1,5/ 5-ST-3,81	1850699	194	FRONT-MSTB 2,5/ 16-ST	1779550	269
FMC 1,5/ 4-STF-3,5	1966114	201	FRONT 2,5-H/SA 5/ 2	1868665	114	FRONT-MC 1,5/ 5-STF-3,81	1850880	195	FRONT-MSTB 2,5/ 16-ST-5,08	1777426	269
FMC 1,5/ 4-STF-3,81	1748370	201	FRONT 2,5-H/SA 5/ 3	1700121	114	FRONT-MC 1,5/ 6-ST-3,81	1850709	194	FRONT-MSTB 2,5/ 16-STF	1779783	269
FMC 1,5/ 5-ST-3,5	1952296	200	FRONT 2,5-H/SA 5/ 4	1700781	114	FRONT-MC 1,5/ 6-STF-3,81	1850893	195	FRONT-MSTB 2,5/ 16-STF-5,08	1777934	269
FMC 1,5/ 5-ST-3,5-RF	1952050	201	FRONT 2,5-H/SA 5/ 5	1724660	114	FRONT-MC 1,5/ 7-ST-3,81	1850712	194	FRONT-SFL 2,5/D32	2285593	790
FMC 1,5/ 5-ST-3,81	1745920	200	FRONT 2,5-H/SA 5/ 6	1891975	114	FRONT-MC 1,5/ 7-STF-3,81	1850903	195	FRONT-SFL 2,5/F32/ZB	2285577	791
FMC 1,5/ 5-STF-3,5	1966127	201	FRONT 2,5-H/SA 5/ 7	1988257	114	FRONT-MC 1,5/ 8-ST-3,81	1850725	194	FRONT-SFL 2,5/F32/ZD	2285580	791
FMC 1,5/ 5-STF-3,81	1748383	201	FRONT 2,5-H/SA 5/ 8	1724673	114	FRONT-MC 1,5/ 8-STF-3,81	1850916	195	FRONT-SFL 2,5/F48	2285603	791
FMC 1,5/ 6-ST-3,5	1952306	200	FRONT 2,5-H/SA 5/ 9	1744109	114	FRONT-MC 1,5/ 9-ST-3,81	1850738	194	FRONT-ZFL 1,5/D32	2201632	789
FMC 1,5/ 6-ST-3,5-RF	1952063	201	FRONT 2,5-H/SA 5/ 10	1773264	114	FRONT-MC 1,5/ 9-STF-3,81	1850929	195			
FMC 1,5/ 6-ST-3,81	1748011	200	FRONT 2,5-H/SA 5/ 11	1701382	114	FRONT-MC 1,5/ 10-ST-3,81	1850741	194			
FMC 1,5/ 6-STF-3,5	1966130	201	FRONT 2,5-H/SA 5/ 12	1892893	114	FRONT-MC 1,5/ 10-STF-3,81	1850932	195			
FMC 1,5/ 6-STF-3,81	1748396	201	FRONT 2,5-H/SA10-EX	1700325	159	FRONT-MC 1,5/ 11-ST-3,81	1850754	194			
FMC 1,5/ 7-ST-3,5	1952319	200	FRONT 2,5-H/SA10/ 2	1724657	115	FRONT-MC 1,5/ 11-STF-3,81	1850945	195			
FMC 1,5/ 7-ST-3,5-RF	1952076	201	FRONT 2,5-H/SA10/ 3	1904215	115	FRONT-MC 1,5/ 12-ST-3,81	1850767	194			
FMC 1,5/ 7-ST-3,81	1748024	200	FRONT 2,5-H/SA10/ 4	1773170	115	FRONT-MC 1,5/ 12-STF-3,81	1850958	195			
FMC 1,5/ 7-STF-3,5	1966143	201	FRONT 2,5-H/SA10/ 5	1773183	115	FRONT-MC 1,5/ 13-ST-3,81	1850770	194	GFKC 2,5/ 2-ST-7,5	1939413	340
FMC 1,5/ 7-STF-3,81	1748406	201	FRONT 2,5-H/SA10/ 6	1773206	115	FRONT-MC 1,5/ 13-STF-3,81	1850961	195	GFKC 2,5/ 2-ST-7,62	1939633	340
FMC 1,5/ 8-ST-3,5	1952322	200	FRONT 2,5-H/SA10/ 7	1773219	115	FRONT-MC 1,5/ 14-ST-3,81	1850783	194	GFKC 2,5/ 2-STF-7,62	1939743	341
FMC 1,5/ 8-ST-3,5-RF	1952089	201	FRONT 2,5-H/SA10/ 8			FRONT-MC 1,5/ 14-STF-3,81	1850974	195	GFKC 2,5/ 2-STF-7,62 EX	1796212	381
FMC 1,5/ 8-ST-3,81	1748037	200	FRONT 2,5-H/SA10/ 9	1773222	115	FRONT-MC 1,5/ 15-ST-3,81	1850796	194	GFKC 2,5/ 3-ST-7,5	1939426	340
FMC 1,5/ 8-STF-3,5	1966156	201	FRONT 2,5-H/SA10/ 10	1773235	115	FRONT-MC 1,5/ 15-STF-3,81	1850987	195	GFKC 2,5/ 3-ST-7,62	1939646	340
FMC 1,5/ 8-STF-3,81	1748419	201	FRONT 2,5-H/SA10/ 11	1773248	115	FRONT-MC 1,5/ 16-ST-3,81	1850806	194	GFKC 2,5/ 3-STF-7,62	1939756	341
FMC 1,5/ 9-ST-3,5	1952335	200	FRONT 2,5-H/SA10/ 12	1773251	115	FRONT-MC 1,5/ 16-STF-3,81	1850990	195	GFKC 2,5/ 3-STF-7,62 EX	1796225	381
FMC 1,5/ 9-ST-3,5-RF	1952092	201	FRONT 2,5-V/SA 5-EX	1701162	159	FRONT-MSTB 2,5/ 2-ST	1779411	269	GFKC 2,5/ 4-ST-7,5	1939439	340
FMC 1,5/ 9-ST-3,81	1748040	200	FRONT 2,5-V/SA 5/ 2	1700244	115	FRONT-MSTB 2,5/ 2-ST-5,08	1777280	269	GFKC 2,5/ 4-ST-7,62	1939659	340
FMC 1,5/ 9-STF-3,5	1966169	201	FRONT 2,5-V/SA 5/ 3	1700134	115	FRONT-MSTB 2,5/ 2-STF	1779644	269	GFKC 2,5/ 4-STF-7,62	1939769	341
FMC 1,5/ 9-STF-3,81	1748422	201	FRONT 2,5-V/SA 5/ 4	1888250	115	FRONT-MSTB 2,5/ 2-STF-5,08	1777808	269	GFKC 2,5/ 4-STF-7,62 EX	1796238	381
FMC 1,5/ 10-ST-3,5	1952348	200	FRONT 2,5-V/SA 5/ 5	1700354	115	FRONT-MSTB 2,5/ 3-ST	1779424	269	GFKC 2,5/ 5-ST-7,5	1939442	340
FMC 1,5/ 10-ST-3,5-RF	1952102	201	FRONT 2,5-V/SA 5/ 6	1700231	115	FRONT-MSTB 2,5/ 3-ST-5,08	1777293	269	GFKC 2,5/ 5-ST-7,62	1939662	340
FMC 1,5/ 10-ST-3,81	1748053	200	FRONT 2,5-V/SA 5/ 7	1724152	115	FRONT-MSTB 2,5/ 3-STF	1779657	269	GFKC 2,5/ 5-STF-7,62	1939772	341
FMC 1,5/ 10-STF-3,5	1966172	201	FRONT 2,5-V/SA 5/ 8	1700710	115	FRONT-MSTB 2,5/ 3-STF-5,08	1777811	269	GFKC 2,5/ 5-STF-7,62 EX	1796241	381
FMC 1,5/ 10-STF-3,81	1748435	201	FRONT 2,5-V/SA 5/ 9</								

Type	Order No.	Page	Type	Order No.	Page	Type	Order No.	Page	Type	Order No.	Page
GFKC 2,5/9-ST-7,5	1939484	340	GIC 2,5/8-GF-7,62	1859043	347	GMKDSP 3/3-7,62	1732733	123	GMSTB 2,5/9-GF-7,62	1806290	343
GFKC 2,5/9-ST-7,62	1939701	340	GIC 2,5/8-ST-7,62	1828867	338	GMSTB 2,5 HCV/2-ST-7,62	1714278	502	GMSTB 2,5/9-GF-7,62 EX	1795954	383
GFKC 2,5/9-STF-7,62	1939811	341	GIC 2,5/8-STF-7,62	1858934	339	GMSTB 2,5 HCV/2-ST-7,62-LR	1812759	503	GMSTB 2,5/9-ST	1766958	334
GFKC 2,5/9-STF-7,62 EX	1796283	381	GIC 2,5/8-STGF-7,62	1849943	339	GMSTB 2,5 HCV/3-ST-7,62	1714281	502	GMSTB 2,5/9-ST-7,62	1767070	334
GFKC 2,5/10-ST-7,5	1939497	340	GIC 2,5/9-G-7,62	1828744	346	GMSTB 2,5 HCV/3-ST-7,62-LR	1812762	503	GMSTB 2,5/9-STF-7,62	1858837	335
GFKC 2,5/10-ST-7,62	1939714	340	GIC 2,5/9-GF-7,62	1859056	347	GMSTB 2,5 HCV/4-ST-7,62	1714294	502	GMSTB 2,5/9-STF-7,62 EX	1795844	379
GFKC 2,5/10-STF-7,62	1939824	341	GIC 2,5/9-ST-7,62	1828870	338	GMSTB 2,5 HCV/4-ST-7,62-LR	1812775	503	GMSTB 2,5/10-G	1766097	342
GFKC 2,5/10-STF-7,62 EX	1796296	381	GIC 2,5/9-STF-7,62	1858947	339	GMSTB 2,5 HCV/5-ST-7,62	1714304	502	GMSTB 2,5/10-G-7,62	1766204	342
GFKC 2,5/11-ST-7,5	1939507	340	GIC 2,5/9-STGF-7,62	1849956	339	GMSTB 2,5 HCV/5-ST-7,62-LR	1812788	503	GMSTB 2,5/10-GF-7,62	1806300	343
GFKC 2,5/11-ST-7,62	1939727	340	GIC 2,5/10-G-7,62	1828757	346	GMSTB 2,5 HCV/6-ST-7,62	1714317	502	GMSTB 2,5/10-GF-7,62 EX	1795967	383
GFKC 2,5/11-STF-7,62	1939837	341	GIC 2,5/10-GF-7,62	1859069	347	GMSTB 2,5 HCV/6-ST-7,62-LR	1812791	503	GMSTB 2,5/10-ST	1766961	334
GFKC 2,5/11-STF-7,62 EX	1796306	381	GIC 2,5/10-ST-7,62	1828883	338	GMSTB 2,5 HCV/7-ST-7,62	1714320	502	GMSTB 2,5/10-ST-7,62	1767083	334
GFKC 2,5/12-ST-7,5	1939510	340	GIC 2,5/10-STF-7,62	1858950	339	GMSTB 2,5 HCV/7-ST-7,62-LR	1812801	503	GMSTB 2,5/10-STF-7,62	1858840	335
GFKC 2,5/12-ST-7,62	1939730	340	GIC 2,5/10-STGF-7,62	1849969	339	GMSTB 2,5 HCV/8-ST-7,62	1714333	502	GMSTB 2,5/10-STF-7,62 EX	1795857	379
GFKC 2,5/12-STF-7,62	1939840	341	GIC 2,5/11-G-7,62	1828760	346	GMSTB 2,5 HCV/8-ST-7,62-LR	1812814	503	GMSTB 2,5/11-G	1766107	342
GFKC 2,5/12-STF-7,62 EX	1796319	381	GIC 2,5/11-GF-7,62	1859072	347	GMSTB 2,5 HCV/9-ST-7,62	1714346	502	GMSTB 2,5/11-G-7,62	1766217	342
GFKIC 2,5/2-ST-7,62	1761603	341	GIC 2,5/11-ST-7,62	1828896	338	GMSTB 2,5 HCV/10-ST-7,62	1714359	502	GMSTB 2,5/11-GF-7,62	1806313	343
GFKIC 2,5/3-ST-7,62	1761616	341	GIC 2,5/11-STF-7,62	1858963	339	GMSTB 2,5 HCV/10-ST-7,62-LR	1812830	503	GMSTB 2,5/11-GF-7,62 EX	1795970	383
GFKIC 2,5/4-ST-7,62	1761629	341	GIC 2,5/11-STGF-7,62	1849972	339	GMSTB 2,5 HCV/11-ST-7,62	1714362	502	GMSTB 2,5/11-ST	1766974	334
GFKIC 2,5/5-ST-7,62	1761632	341	GIC 2,5/12-G-7,62	1828773	346	GMSTB 2,5 HCV/11-ST-7,62-LR	1812843	503	GMSTB 2,5/11-ST-7,62	1767096	334
GFKIC 2,5/6-ST-7,62	1761645	341	GIC 2,5/12-GF-7,62	1859085	347	GMSTB 2,5 HCV/12-ST-7,62	1714375	502	GMSTB 2,5/11-STF-7,62	1858853	335
GFKIC 2,5/7-ST-7,62	1761658	341	GIC 2,5/12-ST-7,62	1828906	338	GMSTB 2,5 HCV/12-ST-7,62-LR	1812856	503	GMSTB 2,5/11-STF-7,62 EX	1795860	379
GFKIC 2,5/8-ST-7,62	1761661	341	GIC 2,5/12-STF-7,62	1858976	339	GMSTB 2,5/2-G	1766013	342	GMSTB 2,5/12-G	1766110	342
GFKIC 2,5/9-ST-7,62	1761674	341	GIC 2,5/12-STGF-7,62	1849985	339	GMSTB 2,5/2-G-7,62	1766123	342	GMSTB 2,5/12-G-7,62	1766220	342
GFKIC 2,5/10-ST-7,62	1761687	341	GICV 2,5 HC/2-G-7,62	1756485	507	GMSTB 2,5/2-GF-7,62	1806229	343	GMSTB 2,5/12-GF-7,62	1806326	343
GFKIC 2,5/11-ST-7,62	1761690	341	GICV 2,5 HC/3-G-7,62	1756498	507	GMSTB 2,5/2-GF-7,62 EX	1795886	383	GMSTB 2,5/12-GF-7,62 EX	1795983	383
GFKIC 2,5/12-ST-7,62	1761700	341	GICV 2,5 HC/4-G-7,62	1756508	507	GMSTB 2,5/2-ST	1766880	334	GMSTB 2,5/12-ST	1766987	334
GIC 2,5 HC/2-G-7,62	1745784	506	GICV 2,5 HC/5-G-7,62	1756511	507	GMSTB 2,5/2-ST-7,62	1766990	334	GMSTB 2,5/12-ST-7,62	1767106	334
GIC 2,5 HC/3-G-7,62	1745797	506	GICV 2,5 HC/6-G-7,62	1756524	507	GMSTB 2,5/2-STF-7,62	1858769	335	GMSTB 2,5/12-STF-7,62	1858866	335
GIC 2,5 HC/4-G-7,62	1745807	506	GICV 2,5 HC/7-G-7,62	1756537	507	GMSTB 2,5/2-STF-7,62 EX	1795776	379	GMSTB 2,5/12-STF-7,62 EX	1795873	379
GIC 2,5 HC/5-G-7,62	1745810	506	GICV 2,5 HC/8-G-7,62	1756540	507	GMSTB 2,5/3-G	1766026	342	GMSTBA 2,5 HC/2-G-7,62	1728853	504
GIC 2,5 HC/6-G-7,62	1745823	506	GICV 2,5 HC/9-G-7,62	1756553	507	GMSTB 2,5/3-G-7,62	1766136	342	GMSTBA 2,5 HC/2-G-7,62-LR	1812869	505
GIC 2,5 HC/7-G-7,62	1745836	506	GICV 2,5 HC/10-G-7,62	1756566	507	GMSTB 2,5/3-GF-7,62	1806232	343	GMSTBA 2,5 HC/3-G-7,62	1728866	504
GIC 2,5 HC/8-G-7,62	1745849	506	GICV 2,5 HC/11-G-7,62	1756579	507	GMSTB 2,5/3-GF-7,62 EX	1795899	383	GMSTBA 2,5 HC/3-G-7,62-LR	1812872	505
GIC 2,5 HC/9-G-7,62	1745852	506	GICV 2,5 HC/12-G-7,62	1756582	507	GMSTB 2,5/3-ST	1766893	334	GMSTBA 2,5 HC/4-G-7,62	1728879	504
GIC 2,5 HC/10-G-7,62	1745865	506	GICV 2,5/2-G-7,62	1828919	347	GMSTB 2,5/3-ST-7,62	1767012	334	GMSTBA 2,5 HC/4-G-7,62-LR	1812885	505
GIC 2,5 HC/11-G-7,62	1745878	506	GICV 2,5/2-GF-7,62	1859098	347	GMSTB 2,5/3-STF-7,62	1858772	335	GMSTBA 2,5 HC/5-G-7,62	1728882	504
GIC 2,5 HC/12-G-7,62	1745881	506	GICV 2,5/3-G-7,62	1828922	347	GMSTB 2,5/3-STF-7,62 EX	1795789	379	GMSTBA 2,5 HC/5-G-7,62-LR	1812898	505
GIC 2,5 HCV/2-ST-7,62	1745629	503	GICV 2,5/3-GF-7,62	1859108	347	GMSTB 2,5/4-G	1766039	342	GMSTBA 2,5 HC/6-G-7,62	1728895	504
GIC 2,5 HCV/3-ST-7,62	1745632	503	GICV 2,5/4-G-7,62	1828935	347	GMSTB 2,5/4-G-7,62	1766149	342	GMSTBA 2,5 HC/6-G-7,62-LR	1812908	505
GIC 2,5 HCV/4-ST-7,62	1745645	503	GICV 2,5/4-GF-7,62	1859111	347	GMSTB 2,5/4-GF-7,62	1806245	343	GMSTBA 2,5 HC/7-G-7,62	1728905	504
GIC 2,5 HCV/5-ST-7,62	1745658	503	GICV 2,5/5-G-7,62	1828948	347	GMSTB 2,5/4-GF-7,62 EX	1795909	383	GMSTBA 2,5 HC/7-G-7,62-LR	1812911	505
GIC 2,5 HCV/6-ST-7,62	1745661	503	GICV 2,5/5-GF-7,62	1859124	347	GMSTB 2,5/4-ST	1766903	334	GMSTBA 2,5 HC/8-G-7,62	1728918	504
GIC 2,5 HCV/7-ST-7,62	1745674	503	GICV 2,5/6-G-7,62	1828951	347	GMSTB 2,5/4-ST-7,62	1767025	334	GMSTBA 2,5 HC/8-G-7,62-LR	1812924	505
GIC 2,5 HCV/8-ST-7,62	1745687	503	GICV 2,5/6-GF-7,62	1859137	347	GMSTB 2,5/4-STF-7,62	1858785	335	GMSTBA 2,5 HC/9-G-7,62	1728921	504
GIC 2,5 HCV/9-ST-7,62	1745690	503	GICV 2,5/7-G-7,62	1828964	347	GMSTB 2,5/4-STF-7,62 EX	1795792	379	GMSTBA 2,5 HC/9-G-7,62-LR	1812937	505
GIC 2,5 HCV/10-ST-7,62	1745700	503	GICV 2,5/7-GF-7,62	1859140	347	GMSTB 2,5/5-G	1766042	342	GMSTBA 2,5 HC/10-G-7,62	1728934	504
GIC 2,5 HCV/11-ST-7,62	1745713	503	GICV 2,5/8-G-7,62	1828977	347	GMSTB 2,5/5-G-7,62	1766152	342	GMSTBA 2,5 HC/10-G-7,62-LR	1812940	505
GIC 2,5 HCV/12-ST-7,62	1745726	503	GICV 2,5/8-GF-7,62	1859153	347	GMSTB 2,5/5-GF-7,62	1806258	343	GMSTBA 2,5 HC/11-G-7,62	1728947	504
GIC 2,5/2-G-7,62	1828676	346	GICV 2,5/9-G-7,62	1828980	347	GMSTB 2,5/5-GF-7,62 EX	1795912	383	GMSTBA 2,5 HC/11-G-7,62-LR	1812953	505
GIC 2,5/2-GF-7,62	1858989	347	GICV 2,5/9-GF-7,62	1859166	347	GMSTB 2,5/5-ST	1766916	334	GMSTBA 2,5 HC/12-G-7,62	1728950	504
GIC 2,5/2-ST-7,62	1828809	338	GICV 2,5/10-G-7,62	1828993	347	GMSTB 2,5/5-ST-7,62	1767038	334	GMSTBA 2,5 HC/12-G-7,62-LR	1812966	505
GIC 2,5/2-STF-7,62	1858879	339	GICV 2,5/10-GF-7,62	1859179	347	GMSTB 2,5/5-STF-7,62	1858798	335	GMSTBA 2,5/2-G	1766343	343
GIC 2,5/2-STGF-7,62	1849888	339	GICV 2,5/11-G-7,62	1829002	347	GMSTB 2,5/5-STF-7,62 EX	1795802	379	GMSTBA 2,5/2-G-7,62	1766233	343
GIC 2,5/3-G-7,62	1828689	346	GICV 2,5/11-GF-7,62	1859182	347	GMSTB 2,5/6-G	1766055	342	GMSTBA 2,5/3-G	1766356	343
GIC 2,5/3-GF-7,62	1858992	347	GICV 2,5/12-G-7,62	1829015	347	GMSTB 2,5/6-G-7,62	1766165	342	GMSTBA 2,5/3-G-7,62	1766246	343
GIC 2,5/3-ST-7,62	1828812	338	GICV 2,5/12-GF-7,62	1859195	347	GMSTB 2,5/6-GF-7,62	1806261	343	GMSTBA 2,5/4-G	1766369	343
GIC 2,5/3-STF-7,62	1858882	339	GMKDS 1,5/2	1717020	121	GMSTB 2,5/6-GF-7,62 EX	1795925	383	GMSTBA 2,5/4-G-7,62	1766259	343
GIC 2,5/3-STGF-7,62	1849891	339	GMKDS 1,5/2-7,62	1717229	121	GMSTB 2,5/6-ST	1766929	334	GMSTBA 2,5/5-G	1766372	343
GIC 2,5/4-G-7,62	1828692	346	GMKDS 1,5/3	1717033	121	GMSTB 2,5/6-ST-7,62	1767041	334	GMSTBA 2,5/5-G-7,62	1766262	343
GIC 2,5/4-GF-7,62	1859001	347	GMKDS 1,5/3-7,62	1717732	121	GMSTB 2,5/6-STF-7,62	1858808	335	GMSTBA 2,5/6-G	1766385	343
GIC 2,5/4-ST-7,62	1828825	338	GMKDS 3/2	1731022	123	GMSTB 2,5/6-STF-7,62 EX	1795815	379	GMSTBA 2,5/6-G-7,62	1766275	343
GIC 2,5/4-STF-7,62	1858895	339	GMKDS 3/2-7,62	1731721	123	GMSTB 2,5/7-G	1766068	342	GMSTBA 2,5/7-G	1766398	343
GIC 2,5/4-STGF-7,62	1849901	339	GMKDS 3/2-EMG15	1731462	709	GMSTB 2,5/7-G-7,62	1766178	342	GMSTBA 2,5/7-G-7,62	1766288	343
GIC 2,5/5-G-7,62	1828702	346	GMKDS 3/3	1731035	123	GMSTB 2,5/7-GF-7,62	1806274	343	GMSTBA 2,5/8-G	1766408	343
GIC 2,5/5-GF-7,62	1859014	347	GMKDS 3/3-7,62	1731734	123	GMSTB 2,5/7-GF-7,62 EX	1795938	383	GMSTBA 2,5/8-G-7,62	1766291	343
GIC 2,5/5-ST-7,62	1828838	338	GMKDSN 1,5/2-7,62	1707027	119	GMSTB 2,5/7-ST	1766932	334	GMSTBA 2,5/9-G	1766411	343
GIC 2,5/5-STF-7,62	1858905	339	GMKDSN 1,5/3-7,62	1707030	119	GMSTB 2,5/7-ST-7,62	1767054	334	GMSTBA 2,5/9-G-7,62	1766301	343
GIC 2,5/5-STGF-7,62	1849914	339									

Index

Alphabetical

Type	Order No.	Page	Type	Order No.	Page	Type	Order No.	Page	Type	Order No.	Page
GMSTBO 2,5 HV/3-GL-7,25 THRR44	2200263	511	GMSTBVA 2,5/ 7-G	1766712	345	GMVSTBW 2,5/ 6-STF-7,62	1848038	337	HC-ALU 6-53,5 COVER GY	2200891	768
GMSTBO 2,5 HV/3-GR-7,25 THRR44	2200262	511	GMSTBVA 2,5/ 7-G-7,62	1766822	345	GMVSTBW 2,5/ 6-STF-7,62 EX	1810049	379	HC-ALU 6-53,5 DKL-COVER GY	2201121	768
GMSTBT 2,5 HV/2-ST-7,25 GY7035	2199757	508	GMSTBVA 2,5/ 8-G	1766725	345	GMVSTBW 2,5/ 7-ST	1737864	337	HC-ALU 6-53,5 PROFILE 100	2200887	768
GMSTBT 2,5 HV/3-ST-7,25 GY7035	2199553	508	GMSTBVA 2,5/ 8-G-7,62	1766835	345	GMVSTBW 2,5/ 7-ST-7,62	1832468	337	HC-ALU 6-53,5 PROFILE 1000	2200890	768
GMSTBV 2,5/ 2-G	1766453	344	GMSTBVA 2,5/ 9-G	1766738	345	GMVSTBW 2,5/ 7-STF-7,62	1848041	337	HC-ALU 6-53,5 PROFILE 150	2200888	768
GMSTBV 2,5/ 2-G-7,62	1766563	344	GMSTBVA 2,5/ 9-G-7,62	1766848	345	GMVSTBW 2,5/ 7-STF-7,62 EX	1810052	379	HC-ALU 6-53,5 PROFILE 200	2200889	768
GMSTBV 2,5/ 2-GF-7,62	1829154	345	GMSTBVA 2,5/ 10-G	1766741	345	GMVSTBW 2,5/ 8-ST	1737877	337	HC-ALU 6-53,5 SEAL EMC	2200907	768
GMSTBV 2,5/ 2-GF-7,62 EX	1796665	383	GMSTBVA 2,5/ 10-G-7,62	1766851	345	GMVSTBW 2,5/ 8-ST-7,62	1832471	337	HC-ALU 6-78 COVER GY	2200896	768
GMSTBV 2,5/ 3-G	1766466	344	GMSTBVA 2,5/ 11-G	1766754	345	GMVSTBW 2,5/ 8-STF-7,62	1848054	337	HC-ALU 6-78 DKL-COVER GY	2201122	768
GMSTBV 2,5/ 3-G-7,62	1766576	344	GMSTBVA 2,5/ 11-G-7,62	1766864	345	GMVSTBW 2,5/ 8-STF-7,62 EX	1810065	379	HC-ALU 6-78 PROFILE 100	2200892	768
GMSTBV 2,5/ 3-GF-7,62	1829167	345	GMSTBVA 2,5/ 12-G	1766767	345	GMVSTBW 2,5/ 9-ST	1737880	337	HC-ALU 6-78 PROFILE 1000	2200895	768
GMSTBV 2,5/ 3-GF-7,62 EX	1796678	383	GMSTBVA 2,5/ 12-G-7,62	1766877	345	GMVSTBW 2,5/ 9-ST-7,62	1832484	337	HC-ALU 6-78 PROFILE 150	2200893	768
GMSTBV 2,5/ 4-G	1766479	344	GMVSTBR 2,5 HV/ 2-ST-7,62	1774454	500	GMVSTBW 2,5/ 9-STF-7,62	1848067	337	HC-ALU 6-78 PROFILE 200	2200894	768
GMSTBV 2,5/ 4-G-7,62	1766589	344	GMVSTBR 2,5 HV/ 3-ST-7,62	1993954	500	GMVSTBW 2,5/ 9-STF-7,62 EX	1810078	379	HC-ALU 6-78 SEAL EMC	2200908	768
GMSTBV 2,5/ 4-GF-7,62	1829170	345	GMVSTBR 2,5 HV/ 4-ST-7,62	1774467	500	GMVSTBW 2,5/ 10-ST	1737893	337	HDFK 95-F/Z	0714037	621
GMSTBV 2,5/ 4-GF-7,62 EX	1796681	383	GMVSTBR 2,5/ 2-ST	1737709	336	GMVSTBW 2,5/ 10-ST-7,62	1832497	337	HDFK 50	0708739	617
GMSTBV 2,5/ 5-G	1766482	344	GMVSTBR 2,5/ 2-ST-7,62	1832523	336	GMVSTBW 2,5/ 10-STF-7,62	1848070	337	HDFK 50-VP	0709123	619
GMSTBV 2,5/ 5-G-7,62	1766592	344	GMVSTBR 2,5/ 2-STF-7,62	1847880	337	GMVSTBW 2,5/ 10-STF-7,62 EX	1810081	379	HDFK 50-VP/Z	0711218	619
GMSTBV 2,5/ 5-GF-7,62	1829183	345	GMVSTBR 2,5/ 2-STF-7,62 EX	1809898	379	GMVSTBW 2,5/ 11-ST	1737903	337	HDFK 50/Z	0705017	617
GMSTBV 2,5/ 5-GF-7,62 EX	1796694	383	GMVSTBR 2,5/ 3-ST	1737712	336	GMVSTBW 2,5/ 11-ST-7,62	1832507	337	HDFK 95	0709534	620
GMSTBV 2,5/ 6-G	1766495	344	GMVSTBR 2,5/ 3-ST-7,62	1832536	336	GMVSTBW 2,5/ 11-STF-7,62	1848083	337	HDFK 95-F	0709644	621
GMSTBV 2,5/ 6-G-7,62	1766602	344	GMVSTBR 2,5/ 3-STF-7,62	1847893	337	GMVSTBW 2,5/ 11-STF-7,62 EX	1810094	379	HDFK 95-F/VP	0709916	619
GMSTBV 2,5/ 6-GF-7,62	1829196	345	GMVSTBR 2,5/ 3-STF-7,62 EX	1809908	379	GMVSTBW 2,5/ 12-ST	1737916	337	HDFK 95-F/VP/Z	0717076	619
GMSTBV 2,5/ 6-GF-7,62 EX	1796704	383	GMVSTBR 2,5/ 4-ST	1737725	336	GMVSTBW 2,5/ 12-ST-7,62	1832510	337	HDFK 95/Z	0717364	620
GMSTBV 2,5/ 7-G	1766505	344	GMVSTBR 2,5/ 4-ST-7,62	1832549	336	GMVSTBW 2,5/ 12-STF-7,62	1848096	337	HDFKV 50/Z	0714095	617
GMSTBV 2,5/ 7-G-7,62	1766615	344	GMVSTBR 2,5/ 4-STF-7,62	1847903	337	GMVSTBW 2,5/ 12-STF-7,62 EX	1810104	379	HDFKV 95-F/Z	0714118	621
GMSTBV 2,5/ 7-GF-7,62	1829206	345	GMVSTBR 2,5/ 4-STF-7,62 EX	1809911	379	GSMKDS 3/ 2	1733020	123	HDFKV 95/Z	0714105	621
GMSTBV 2,5/ 7-GF-7,62 EX	1796717	383	GMVSTBR 2,5/ 5-ST	1737738	336	GSMKDS 3/ 2-7,62	1733729	123	HDFKV 10-TWIN	0709550	623
GMSTBV 2,5/ 8-G	1766518	344	GMVSTBR 2,5/ 5-ST-7,62	1832552	336	GSMKDS 3/ 3	1733033	123	HDFKV 25-TWIN	0709563	623
GMSTBV 2,5/ 8-G-7,62	1766628	344	GMVSTBR 2,5/ 5-STF-7,62	1847916	337	GSMKDS 3/ 3-7,62	1733732	123	HDFKV 50	0708522	617
GMSTBV 2,5/ 8-GF-7,62	1829219	345	GMVSTBR 2,5/ 5-STF-7,62 EX	1809924	379	GSMKDSN 1,5/ 2-7,62	1718605	119	HDFKV 50-VP	0708580	619
GMSTBV 2,5/ 8-GF-7,62 EX	1796720	383	GMVSTBR 2,5/ 6-ST	1737741	336	GSMKDSN 1,5/ 3-7,62	1718618	119	HDFKV 50-VP/Z	0717212	619
GMSTBV 2,5/ 9-G	1766521	344	GMVSTBR 2,5/ 6-ST-7,62	1832565	336	GSMKDSN 1,5/ 4-7,62	1718621	119	HDFKV 95	0709547	621
GMSTBV 2,5/ 9-G-7,62	1766631	344	GMVSTBR 2,5/ 6-STF-7,62	1847929	337	GSMKDSN 1,5/ 5-7,62	1718634	119	HDFKV 95-F	0709673	621
GMSTBV 2,5/ 9-GF-7,62	1829222	345	GMVSTBR 2,5/ 6-STF-7,62 EX	1809937	379	GSMKDSN 1,5/ 6-7,62	1718647	119			
GMSTBV 2,5/ 9-GF-7,62 EX	1796733	383	GMVSTBR 2,5/ 7-ST	1737754	336	GSMKDSN 1,5/ 7-7,62	1718650	119			
GMSTBV 2,5/ 10-G	1766534	344	GMVSTBR 2,5/ 7-ST-7,62	1832578	336	GSMKDSN 1,5/ 8-7,62	1718663	119			
GMSTBV 2,5/ 10-G-7,62	1766644	344	GMVSTBR 2,5/ 7-STF-7,62	1847932	337	GSMKDSN 1,5/ 9-7,62	1718676	119			
GMSTBV 2,5/ 10-GF-7,62	1829235	345	GMVSTBR 2,5/ 7-STF-7,62 EX	1809940	379	GSMKDSN 1,5/ 10-7,62	1718689	119			
GMSTBV 2,5/ 10-GF-7,62 EX	1796746	383	GMVSTBR 2,5/ 8-ST	1737767	336	GSMKDSN 1,5/ 11-7,62	1718692	119			
GMSTBV 2,5/ 11-G	1766547	344	GMVSTBR 2,5/ 8-ST-7,62	1832581	336	GSMKDSN 1,5/ 12-7,62	1718702	119	IBS RL FOC	2725147	436
GMSTBV 2,5/ 11-G-7,62	1766657	344	GMVSTBR 2,5/ 8-STF-7,62	1847945	337	GSMKDSN 1,5/ 2	1718029	121	IC 2,5 HC/ 2-G-5,08	1943302	498
GMSTBV 2,5/ 11-GF-7,62	1829248	345	GMVSTBR 2,5/ 8-STF-7,62 EX	1809953	379	GSMKDSN 1,5/ 2-7,62	1718728	121	IC 2,5 HC/ 2-GF-5,08	1943425	498
GMSTBV 2,5/ 11-GF-7,62 EX	1796759	383	GMVSTBR 2,5/ 9-ST	1737770	336	GSMKDSN 1,5/ 3	1718032	121	IC 2,5 HC/ 3-G-5,08	1943315	498
GMSTBV 2,5/ 12-G	1766550	344	GMVSTBR 2,5/ 9-ST-7,62	1832594	336	GSMKDSN 1,5/ 3-7,62	1718731	121	IC 2,5 HC/ 3-GF-5,08	1943438	499
GMSTBV 2,5/ 12-G-7,62	1767119	344	GMVSTBR 2,5/ 9-STF-7,62	1847958	337				IC 2,5 HC/ 4-G-5,08	1943328	498
GMSTBV 2,5/ 12-GF-7,62	1829251	345	GMVSTBR 2,5/ 9-STF-7,62 EX	1809966	379				IC 2,5 HC/ 4-GF-5,08	1943441	498
GMSTBV 2,5/ 12-GF-7,62 EX	1796762	383	GMVSTBR 2,5/ 10-ST	1737783	336				IC 2,5 HC/ 5-G-5,08	1943331	498
GMSTBVA 2,5 HC/ 2-G-7,62	1792397	505	GMVSTBR 2,5/ 10-ST-7,62	1832604	336				IC 2,5 HC/ 5-GF-5,08	1943454	499
GMSTBVA 2,5 HC/ 2-G-7,62-LR	1812979	505	GMVSTBR 2,5/ 10-STF-7,62	1847961	337				IC 2,5 HC/ 6-G-5,08	1943344	498
GMSTBVA 2,5 HC/ 3-G-7,62	1767979	505	GMVSTBR 2,5/ 10-STF-7,62 EX	1809979	379				IC 2,5 HC/ 6-GF-5,08	1943467	498
GMSTBVA 2,5 HC/ 3-G-7,62-LR	1812982	505	GMVSTBR 2,5/ 11-ST	1737796	336				IC 2,5 HC/ 7-G-5,08	1943360	498
GMSTBVA 2,5 HC/ 4-G-7,62	1758179	505	GMVSTBR 2,5/ 11-ST-7,62	1832617	336	HBUS 107,6-16P-1S BK	2896306	702	IC 2,5 HC/ 7-GF-5,08	1943470	499
GMSTBVA 2,5 HC/ 4-G-7,62-LR	1812995	505	GMVSTBR 2,5/ 11-STF-7,62	1847974	337	HBUS 161,6-16P-1S BK	2278555	702	IC 2,5 HC/ 8-G-5,08	1943373	498
GMSTBVA 2,5 HC/ 5-G-7,62	1773455	505	GMVSTBR 2,5/ 11-STF-7,62 EX	1809982	379	HBUS 35,6-16P-1S BK	2896283	702	IC 2,5 HC/ 8-GF-5,08	1943483	498
GMSTBVA 2,5 HC/ 5-G-7,62-LR	1813004	505	GMVSTBR 2,5/ 12-ST	1737806	336	HBUS 35,6-16P-2S BK	2896319	702	IC 2,5 HC/ 9-G-5,08	1943386	498
GMSTBVA 2,5 HC/ 6-G-7,62	1767050	505	GMVSTBR 2,5/ 12-ST-7,62	1832620	336	HBUS 53,6-16P-1S BK	2896458	702	IC 2,5 HC/ 9-GF-5,08	1943496	498
GMSTBVA 2,5 HC/ 6-G-7,62-LR	1813017	505	GMVSTBR 2,5/ 12-STF-7,62	1847987	337	HBUS 53,6-16P-3S BK	2896322	702	IC 2,5 HC/ 10-G-5,08	1943399	498
GMSTBVA 2,5 HC/ 7-G-7,62	1792407	505	GMVSTBR 2,5/ 12-STF-7,62 EX	1809995	379	HBUS 71,6-16P-1S BK	2896296	702	IC 2,5 HC/ 10-GF-5,08	1943506	498
GMSTBVA 2,5 HC/ 7-G-7,62-LR	1813020	505	GMVSTBW 2,5 HV/ 2-ST-7,62	1771910	501	HBUS-B SET BK	2278173	698	IC 2,5 HC/ 11-G-5,08	1943409	498
GMSTBVA 2,5 HC/ 8-G-7,62	1792410	505	GMVSTBW 2,5 HV/ 3-ST-7,62	1993967	501	HC-ALU 6 DECO 100 GY	2200914	768	IC 2,5 HC/ 11-GF-5,08	1943519	498
GMSTBVA 2,5 HC/ 8-G-7,62-LR	1813033	505	GMVSTBW 2,5 HV/ 4-ST-7,62	1927221	501	HC-ALU 6 DECO 150 GY	2200915	768	IC 2,5 HC/ 12-G-5,08	1943412	498
GMSTBVA 2,5 HC/ 9-G-7,62	1792423	505	GMVSTBW 2,5/ 2-ST	1737819	337	HC-ALU 6 DECO 200 GY	2200916	768	IC 2,5 HC/ 12-GF-5,08	1943522	498
GMSTBVA 2,5 HC/ 9-G-7,62-LR	1813046	505	GMVSTBW 2,5/ 2-ST-7,62	1832413	337	HC-ALU 6 MOUNT 100 GY	2200911	768	IC 2,5/ 2-G-5,08	1786404	332
GMSTBVA 2,5 HC/ 10-G-7,62	1792436	505	GMVSTBW 2,5/ 2-STF-7,62	1847990	337	HC-ALU 6 MOUNT 150 GY	2200912	768	IC 2,5/ 2-GF-5,08	1825129	333
GMSTBVA 2,5 HC/ 10-G-7,62-LR	1813059	505	GMVSTBW 2,5/ 2-STF-7,62 EX	1810007	379	HC-ALU 6 MOUNT 200 GY	2200913	768	IC 2,5/ 2-GF-5,08 EX	1810337	377
GMSTBVA 2,5 HC/ 11-G-7,62	1792449	505	GMVSTBW 2,5/ 3-ST	1737822	337	HC-ALU 6-100,5 COVER GY	2200901	769	IC 2,5/ 2-ST-5,08	1786174	272
GMSTBVA 2,5 HC/ 11-G-7,62-LR	1813062	505	GMVSTBW 2,5/ 3-ST-7,62	1832426	337	HC-ALU 6-100,5 DKL-COVER GY	2201123	769	IC 2,5/ 2-STF-5,08	1825310	273
GMSTBVA 2,5 HC/ 12-G-7,62	1792452	505	GMVSTBW 2,5/ 3-STF-7,62	1848009	337	HC-ALU 6-100,5 PROFILE 100	2200897	769	IC 2,5/ 2-STF-5,08 EX	1810117	373
GMSTBVA 2,5 HC/ 12-G-7,62-LR	1813075	505	GMVSTBW 2,5/ 3-STF-7								

Type	Order No.	Page	Type	Order No.	Page	Type	Order No.	Page	Type	Order No.	Page
IC 2,5/ 4-ST-5,08	1786190	272	IC-DFR 2	1852024	350	ICV 2,5/ 5-G-5,08	1785971	333	IMC 1,5/13-G-3,81	1862687	238
IC 2,5/ 4-STF-5,08	1825336	273	IC-DFR 3	1852037	350	ICV 2,5/ 5-GF-5,08	1825271	333	IMC 1,5/13-ST-3,81	1857993	196
IC 2,5/ 4-STF-5,08 EX	1810133	373	IC-DFR 4	1852040	350	ICV 2,5/ 5-GF-5,08 EX	1810476	377	IMC 1,5/13-STGF-3,81	1858141	197
IC 2,5/ 4-STGF-5,08	1825527	273	IC-DFR 5	1852053	350	ICV 2,5/ 6-G-5,08	1785984	333	IMC 1,5/14-G-3,81	1862690	238
IC 2,5/ 5-G-5,08	1786433	332	IC-DFR 6	1852066	350	ICV 2,5/ 6-GF-5,08	1825734	333	IMC 1,5/14-ST-3,81	1858002	196
IC 2,5/ 5-GF-5,08	1825158	333	IC-DFR 7	1852079	350	ICV 2,5/ 6-GF-5,08 EX	1810489	377	IMC 1,5/14-STGF-3,81	1858154	197
IC 2,5/ 5-GF-5,08 EX	1810366	377	IC-DFR 8	1852082	350	ICV 2,5/ 7-G-5,08	1785997	377	IMC 1,5/15-G-3,81	1862700	238
IC 2,5/ 5-ST-5,08	1786200	272	IC-DFR 9	1852095	350	ICV 2,5/ 7-GF-5,08	1825747	333	IMC 1,5/15-ST-3,81	1858015	196
IC 2,5/ 5-STF-5,08	1825349	273	IC-DFR 10	1852105	350	ICV 2,5/ 7-GF-5,08 EX	1810492	377	IMC 1,5/15-STGF-3,81	1858167	197
IC 2,5/ 5-STF-5,08 EX	1810146	373	IC-DFR 11	1852118	350	ICV 2,5/ 8-G-5,08	1786006	333	IMC 1,5/16-G-3,81	1862713	238
IC 2,5/ 5-STGF-5,08	1825530	273	IC-DFR 12	1852121	350	ICV 2,5/ 8-GF-5,08	1825750	333	IMC 1,5/16-ST-3,81	1858028	196
IC 2,5/ 6-G-5,08	1786446	332	IC-DFR 13	1852134	350	ICV 2,5/ 8-GF-5,08 EX	1810502	377	IMC 1,5/16-STGF-3,81	1858170	197
IC 2,5/ 6-GF-5,08	1825161	333	IC-DFR 14	1852147	350	ICV 2,5/ 9-G-5,08	1786019	333	IMCV 1,5/ 2-G-3,81	1875425	239
IC 2,5/ 6-GF-5,08 EX	1810379	377	IC-DFR 15	1852150	350	ICV 2,5/ 9-GF-5,08	1825763	333	IMCV 1,5/ 3-G-3,81	1875438	239
IC 2,5/ 6-ST-5,08	1786213	272	IC-DFR 16	1852163	350	ICV 2,5/ 9-GF-5,08 EX	1810515	377	IMCV 1,5/ 4-G-3,81	1875441	239
IC 2,5/ 6-STF-5,08	1825352	273	ICC 2,5/ 2-STZ-5,08	1823846	296	ICV 2,5/ 10-G-5,08	1786022	333	IMCV 1,5/ 5-G-3,81	1875454	239
IC 2,5/ 6-STF-5,08 EX	1810159	373	ICC 2,5/ 2-STZF-5,08	1823383	297	ICV 2,5/ 10-GF-5,08	1825776	333	IMCV 1,5/ 6-G-3,81	1875467	239
IC 2,5/ 6-STGF-5,08	1825542	273	ICC 2,5/ 3-STZ-5,08	1823859	296	ICV 2,5/ 10-GF-5,08 EX	1810528	377	IMCV 1,5/ 7-G-3,81	1875470	239
IC 2,5/ 7-G-5,08	1786459	332	ICC 2,5/ 3-STZF-5,08	1823396	297	ICV 2,5/ 11-G-5,08	1786035	333	IMCV 1,5/ 8-G-3,81	1875483	239
IC 2,5/ 7-GF-5,08	1825174	333	ICC 2,5/ 4-STZ-5,08	1823862	296	ICV 2,5/ 11-GF-5,08	1825789	333	IMCV 1,5/ 9-G-3,81	1875496	239
IC 2,5/ 7-GF-5,08 EX	1810382	377	ICC 2,5/ 4-STZF-5,08	1823406	297	ICV 2,5/ 11-GF-5,08 EX	1810531	377	IMCV 1,5/ 10-G-3,81	1875506	239
IC 2,5/ 7-ST-5,08	1786226	272	ICC 2,5/ 5-STZ-5,08	1823875	296	ICV 2,5/ 12-G-5,08	1786048	333	IMCV 1,5/ 11-G-3,81	1875519	239
IC 2,5/ 7-STF-5,08	1825365	273	ICC 2,5/ 5-STZF-5,08	1823419	297	ICV 2,5/ 12-GF-5,08	1825792	333	IMCV 1,5/ 12-G-3,81	1875522	239
IC 2,5/ 7-STF-5,08 EX	1810162	373	ICC 2,5/ 6-STZ-5,08	1823888	296	ICV 2,5/ 12-GF-5,08 EX	1810544	377	IMCV 1,5/ 13-G-3,81	1875535	239
IC 2,5/ 7-STGF-5,08	1825556	273	ICC 2,5/ 6-STZF-5,08	1823422	297	ICV 2,5/ 13-G-5,08	1786051	333	IMCV 1,5/ 14-G-3,81	1875548	239
IC 2,5/ 8-G-5,08	1786462	332	ICC 2,5/ 7-STZ-5,08	1823891	296	ICV 2,5/ 13-GF-5,08	1825802	333	IMCV 1,5/ 15-G-3,81	1875551	239
IC 2,5/ 8-GF-5,08	1825187	333	ICC 2,5/ 7-STZF-5,08	1823435	297	ICV 2,5/ 14-G-5,08	1786064	333	IMCV 1,5/ 16-G-3,81	1875564	239
IC 2,5/ 8-GF-5,08 EX	1810395	377	ICC 2,5/ 8-STZ-5,08	1823901	296	ICV 2,5/ 14-GF-5,08	1825815	333	IPC 16/ 2-G-10,16	1969535	570
IC 2,5/ 8-ST-5,08	1786239	272	ICC 2,5/ 8-STZF-5,08	1823448	297	ICV 2,5/ 15-G-5,08	1786077	333	IPC 16/ 2-GFU-10,16	1969933	571
IC 2,5/ 8-STF-5,08	1825378	273	ICC 2,5/ 9-STZ-5,08	1823914	296	ICV 2,5/ 15-GF-5,08	1825828	333	IPC 16/ 2-GFU-10,16	1969852	571
IC 2,5/ 8-STF-5,08 EX	1810175	373	ICC 2,5/ 9-STZF-5,08	1823451	297	ICV 2,5/ 16-G-5,08	1786080	333	IPC 16/ 2-GU-10,16	1969852	571
IC 2,5/ 8-STGF-5,08	1825569	273	ICC 2,5/ 10-STZ-5,08	1823927	296	ICV 2,5/ 16-GF-5,08	1825831	333	IPC 16/ 2-ST-10,16	1969373	558
IC 2,5/ 9-G-5,08	1786475	332	ICC 2,5/ 10-STZF-5,08	1823464	297	IDC 0,3/ 2-3,81	1706170	154	IPC 16/ 2-STF-10,16	1969454	559
IC 2,5/ 9-GF-5,08	1825190	333	ICC 2,5/ 11-STZ-5,08	1823930	296	IDC 0,3/ 3-3,81	1706183	154	IPC 16/ 2-STGF-10,16	1975817	560
IC 2,5/ 9-GF-5,08 EX	1810405	377	ICC 2,5/ 11-STZF-5,08	1823477	297	IDC 0,3/ 4-3,81	1706196	154	IPC 16/ 3-G-10,16	1969548	570
IC 2,5/ 9-ST-5,08	1786242	272	ICC 2,5/ 12-STZ-5,08	1823943	296	IDC 0,3/ 5-3,81	1706206	154	IPC 16/ 3-GF-10,16	1969629	571
IC 2,5/ 9-STF-5,08	1825381	273	ICC 2,5/ 12-STZF-5,08	1823480	297	IDC 0,3/ 6-3,81	1706219	154	IPC 16/ 3-GFU-10,16	1969946	571
IC 2,5/ 9-STF-5,08 EX	1810188	373	ICC 2,5/ 13-STZ-5,08	1823956	296	IDC 0,3/ 7-3,81	1706222	154	IPC 16/ 3-GU-10,16	1969865	571
IC 2,5/ 9-STGF-5,08	1825572	273	ICC 2,5/ 13-STZF-5,08	1823493	297	IDC 0,3/ 8-3,81	1706235	154	IPC 16/ 3-ST-10,16	1969386	558
IC 2,5/ 10-G-5,08	1786488	332	ICC 2,5/ 14-STZ-5,08	1823969	296	IDC 0,3/ 9-3,81	1706248	154	IPC 16/ 3-STF-10,16	1969467	559
IC 2,5/ 10-GF-5,08	1825200	333	ICC 2,5/ 14-STZF-5,08	1823503	297	IDC 0,3/ 10-3,81	1706251	154	IPC 16/ 3-STF-SH-10,16	1737323	559
IC 2,5/ 10-GF-5,08 EX	1810418	377	ICC 2,5/ 15-STZ-5,08	1823972	296	IDC 0,3/ 11-3,81	1706264	154	IPC 16/ 3-STGF-10,16	1975820	560
IC 2,5/ 10-ST-5,08	1786255	272	ICC 2,5/ 15-STZF-5,08	1823516	297	IDC 0,3/ 12-3,81	1706277	154	IPC 16/ 4-G-10,16	1969551	570
IC 2,5/ 10-STF-5,08	1825394	273	ICC 2,5/ 16-STZ-5,08	1823985	296	IMC 1,5/ 2-G-3,81	1862577	238	IPC 16/ 4-GF-10,16	1969632	571
IC 2,5/ 10-STF-5,08 EX	1810191	373	ICC 2,5/ 16-STZF-5,08	1823529	297	IMC 1,5/ 2-ST-3,81	1857883	196	IPC 16/ 4-GFU-10,16	1969959	571
IC 2,5/ 10-STGF-5,08	1825585	273	ICC-MT 0,5-1,0	3190577	827	IMC 1,5/ 2-ST-3,81 AU	1943263	692	IPC 16/ 4-GU-10,16	1969878	571
IC 2,5/ 11-G-5,08	1786491	332	ICC-MT 0,5-1,0 BA	3190603	827	IMC 1,5/ 2-STGF-3,81	1858031	197	IPC 16/ 4-ST-10,16	1969399	558
IC 2,5/ 11-GF-5,08	1825213	333	ICC-MT 1,5-2,5	3190580	827	IMC 1,5/ 3-G-3,81	1862580	238	IPC 16/ 4-STF-10,16	1969470	559
IC 2,5/ 11-GF-5,08 EX	1810421	377	ICC-MT 1,5-2,5 BA	3190593	827	IMC 1,5/ 3-ST-3,81	1857896	196	IPC 16/ 4-STF-SH-10,16	1970346	559
IC 2,5/ 11-ST-5,08	1786268	272	ICV 2,5 HC/ 2-G-5,08	1943535	499	IMC 1,5/ 3-STGF-3,81	1858044	197	IPC 16/ 4-STGF-10,16	1975833	560
IC 2,5/ 11-STF-5,08	1825404	273	ICV 2,5 HC/ 2-GF-5,08	1943645	499	IMC 1,5/ 4-G-3,81	1862593	238	IPC 16/ 4-STGF-SH-10,16	1975891	561
IC 2,5/ 11-STF-5,08 EX	1810201	373	ICV 2,5 HC/ 3-G-5,08	1943548	499	IMC 1,5/ 4-ST-3,81	1857906	196	IPC 16/ 5-G-10,16	1969564	570
IC 2,5/ 11-STGF-5,08	1825598	273	ICV 2,5 HC/ 3-GF-5,08	1943658	499	IMC 1,5/ 4-STGF-3,81	1858057	197	IPC 16/ 5-GF-10,16	1969645	571
IC 2,5/ 12-G-5,08	1786501	332	ICV 2,5 HC/ 4-G-5,08	1943551	499	IMC 1,5/ 5-G-3,81	1862603	238	IPC 16/ 5-GFU-10,16	1969962	571
IC 2,5/ 12-GF-5,08	1825226	333	ICV 2,5 HC/ 4-GF-5,08	1943661	499	IMC 1,5/ 5-ST-3,81	1857919	196	IPC 16/ 5-GU-10,16	1969881	571
IC 2,5/ 12-GF-5,08 EX	1810434	377	ICV 2,5 HC/ 5-G-5,08	1943564	499	IMC 1,5/ 5-ST-3,81 AU	1943276	692	IPC 16/ 5-ST-10,16	1969409	558
IC 2,5/ 12-ST-5,08	1786271	272	ICV 2,5 HC/ 5-GF-5,08	1943674	499	IMC 1,5/ 5-ST-3,81 GY7035 AU	1719707	692	IPC 16/ 5-STF-10,16	1969483	559
IC 2,5/ 12-STF-5,08	1825417	273	ICV 2,5 HC/ 6-G-5,08	1943577	499	IMC 1,5/ 5-STGF-3,81	1858060	197	IPC 16/ 5-STGF-10,16	1975846	560
IC 2,5/ 12-STF-5,08 EX	1810214	373	ICV 2,5 HC/ 6-GF-5,08	1943687	499	IMC 1,5/ 6-G-3,81	1862616	238	IPC 16/ 6-G-10,16	1969577	570
IC 2,5/ 12-STGF-5,08	1825608	273	ICV 2,5 HC/ 7-G-5,08	1943580	499	IMC 1,5/ 6-ST-3,81	1857922	196	IPC 16/ 6-GF-10,16	1969658	571
IC 2,5/ 13-G-5,08	1786514	332	ICV 2,5 HC/ 7-GF-5,08	1943690	499	IMC 1,5/ 6-STGF-3,81	1858073	197	IPC 16/ 6-GFU-10,16	1969975	571
IC 2,5/ 13-GF-5,08	1825239	333	ICV 2,5 HC/ 8-G-5,08	1943593	499	IMC 1,5/ 7-G-3,81	1862629	238	IPC 16/ 6-GU-10,16	1969894	571
IC 2,5/ 13-ST-5,08	1786284	272	ICV 2,5 HC/ 8-GF-5,08	1943700	499	IMC 1,5/ 7-ST-3,81	1857935	196	IPC 16/ 6-ST-10,16	1969412	558
IC 2,5/ 13-STF-5,08	1825420	273	ICV 2,5 HC/ 9-G-5,08	1943603	499	IMC 1,5/ 7-STGF-3,81	1858086	197	IPC 16/ 6-STF-10,16	1969496	559
IC 2,5/ 13-STGF-5,08	1825611	273	ICV 2,5 HC/ 9-GF-5,08	1943713	499	IMC 1,5/ 8-G-3,81	1862632	238	IPC 16/ 6-STGF-10,16	1975859	560
IC 2,5/ 14-G-5,08	1786527	332	ICV 2,5 HC/ 10-G-5,08	1943616	499	IMC 1,5/ 8-ST-3,81	1857948	196	IPC 16/ 7-G-10,16	1969580	570
IC 2,5/ 14-GF-5,08	1825242	333	ICV 2,5 HC/ 10-GF-5,08	1943726	499	IMC 1,5/ 8-STGF-3,81	1858099	197	IPC 16/ 7-GF-10,16	1969661	571
IC 2,5/ 14-ST-5,08	1786297	272	ICV 2,5 HC/ 11-G-5,08	1943629	499	IMC 1,5/ 9-G-3,81	1862645	238	IPC 16/ 7-GFU-10,16	1969988	571
IC 2,5/ 14-STF-5,08</											

Index

Alphabetical

Type	Order No.	Page	Type	Order No.	Page	Type	Order No.	Page	Type	Order No.	Page
IPC 16/ 9-G-10,16	1969603	570	IPC 5/ 8-STGCL-7,62	1718326	527	ISPC 16/ 3-ST-10,16	1748558	564	KGG-MC 1,5/12	1834440	243
IPC 16/ 9-GF-10,16	1969687	571	IPC 5/ 8-STGF-7,62	1709322	527	ISPC 16/ 3-STF-10,16	1748639	565	KGG-MC 1,5/13	1834453	243
IPC 16/ 9-GFU-10,16	1970003	571	IPC 5/ 9-G-7,62	1708459	540	ISPC 16/ 3-STGF-10,16	1748710	565	KGG-MC 1,5/14	1834466	243
IPC 16/ 9-GU-10,16	1969920	571	IPC 5/ 9-GF-7,62	1708569	541	ISPC 16/ 4-ST-10,16	1748561	564	KGG-MC 1,5/15	1834479	243
IPC 16/ 9-ST-10,16	1969441	558	IPC 5/ 9-GFU-7,62	1708789	541	ISPC 16/ 4-STF-10,16	1748642	565	KGG-MC 1,5/16	1834482	243
IPC 16/ 9-STF-10,16	1969522	559	IPC 5/ 9-GU-7,62	1708679	541	ISPC 16/ 4-STGF-10,16	1748723	565	KGG-MSTB 2,5/ 2	1803934	348
IPC 16/ 9-STGF-10,16	1975888	560	IPC 5/ 9-ST-7,62	1709115	526	ISPC 16/ 5-ST-10,16	1748574	564	KGG-MSTB 2,5/ 3	1803947	348
IPC 35 HC/ 2-GF-15,00	1784910	592	IPC 5/ 9-STF-7,62	1709225	527	ISPC 16/ 5-STF-10,16	1748655	565	KGG-MSTB 2,5/ 4	1803882	349
IPC 35 HC/ 2-STF-15,00	1784790	588	IPC 5/ 9-STGCL-7,62	1718339	527	ISPC 16/ 5-STGF-10,16	1748736	565	KGG-MSTB 2,5/ 5	1803895	349
IPC 35 HC/ 2-STGF-15,00	1784855	589	IPC 5/ 9-STGF-7,62	1709335	527	ISPC 16/ 6-ST-10,16	1748587	564	KGG-MSTB 2,5/ 6	1803905	349
IPC 35 HC/ 3-GF-15,00	1784923	592	IPC 5/10-G-7,62	1708462	540	ISPC 16/ 6-STF-10,16	1748668	565	KGG-MSTB 2,5/ 7	1803918	349
IPC 35 HC/ 3-STF-15,00	1784800	588	IPC 5/10-GF-7,62	1708572	541	ISPC 16/ 6-STGF-10,16	1748749	565	KGG-MSTB 2,5/ 8	1803921	349
IPC 35 HC/ 3-STGF-15,00	1784868	589	IPC 5/10-GFU-7,62	1708792	541	ISPC 16/ 7-ST-10,16	1748590	564	KGG-PC 4/ 3	1837227	523
IPC 35 HC/ 4-GF-15,00	1784936	592	IPC 5/10-GU-7,62	1708682	541	ISPC 16/ 7-STF-10,16	1748671	565	KGG-PC 4/ 3-F	1837324	523
IPC 35 HC/ 4-STF-15,00	1784813	588	IPC 5/10-ST-7,62	1709128	526	ISPC 16/ 7-STGF-10,16	1748752	565	KGG-PC 4/ 4	1837230	522
IPC 35 HC/ 4-STF-SH-15,00	1784842	589	IPC 5/10-STF-7,62	1709238	527	ISPC 16/ 8-ST-10,16	1748600	564	KGG-PC 4/ 4-F	1837337	523
IPC 35 HC/ 4-STGF-15,00	1784871	589	IPC 5/10-STGCL-7,62	1718342	527	ISPC 16/ 8-STF-10,16	1748684	565	KGG-PC 4/ 5	1837243	523
IPC 35 HC/ 4-STGF-SH-15,00	1784907	589	IPC 5/10-STGF-7,62	1709348	527	ISPC 16/ 8-STGF-10,16	1748765	565	KGG-MSTB 2,5/ 5-F	1837340	522
IPC 35 HC/ 5-GF-15,00	1784949	592	IPC 5/11-G-7,62	1708475	540	ISPC 16/ 9-ST-10,16	1748613	564	KGS-MSTB 2,5/ 8	1783779	349
IPC 35 HC/ 5-STF-15,00	1784826	588	IPC 5/11-GF-7,62	1708585	541	ISPC 16/ 9-STF-10,16	1748697	565	KGS-MSTB 2,5/ 9	1783782	349
IPC 35 HC/ 5-STGF-15,00	1784884	589	IPC 5/11-GFU-7,62	1708802	541	ISPC 16/ 9-STGF-10,16	1748778	565	KGS-MSTB 2,5/10	1783740	349
IPC 35 HC/ 6-GF-15,00	1784952	592	IPC 5/11-GU-7,62	1708695	541	ISPC 5/ 2-STF-7,62	1748972	535	KGS-MSTB 2,5/11	1783805	349
IPC 35 HC/ 6-STF-15,00	1784839	588	IPC 5/11-ST-7,62	1709131	526	ISPC 5/ 2-STGCL-7,62	1748862	534	KGS-MSTB 2,5/12	1783818	349
IPC 35 HC/ 6-STGF-15,00	1784897	589	IPC 5/11-STF-7,62	1709241	527	ISPC 5/ 2-STGF-7,62	1749201	535	KGS-MSTB 2,5/13	1783821	349
IPC 5/ 2-G-7,62	1708381	540	IPC 5/11-STGCL-7,62	1718355	527	ISPC 5/ 3-STF-7,62	1748985	535	KGS-MSTB 2,5/14	1783834	349
IPC 5/ 2-GF-7,62	1708491	541	IPC 5/11-STGF-7,62	1709351	527	ISPC 5/ 3-STGCL-7,62	1748875	534	KGS-MSTB 2,5/15	1783847	349
IPC 5/ 2-GFU-7,62	1708718	541	IPC 5/12-G-7,62	1708488	540	ISPC 5/ 3-STGF-7,62	1749214	535	KGS-MSTB 2,5/16	1783850	349
IPC 5/ 2-GU-7,62	1708608	541	IPC 5/12-GF-7,62	1708598	541	ISPC 5/ 4-STF-7,62	1748998	535	KGS-PC 4/ 6	1837256	523
IPC 5/ 2-ST-7,62	1709047	526	IPC 5/12-GFU-7,62	1708815	541	ISPC 5/ 4-STGCL-7,62	1748888	534	KGS-PC 4/ 6-F	1837353	523
IPC 5/ 2-STF-7,62	1709157	527	IPC 5/12-GU-7,62	1708705	541	ISPC 5/ 4-STGF-7,62	1749227	535	KGS-PC 4/ 7	1837269	523
IPC 5/ 2-STGCL-7,62	1718261	527	IPC 5/12-ST-7,62	1709144	526	ISPC 5/ 5-STF-7,62	1749007	535	KGS-PC 4/ 7-F	1837366	523
IPC 5/ 2-STGF-7,62	1709267	527	IPC 5/12-STF-7,62	1709254	527	ISPC 5/ 5-STGCL-7,62	1748891	534	KGS-PC 4/ 8	1837272	523
IPC 5/ 3-G-7,62	1708394	540	IPC 5/12-STGCL-7,62	1718368	527	ISPC 5/ 5-STGF-7,62	1749230	535	KGS-PC 4/ 8-F	1837379	523
IPC 5/ 3-GF-7,62	1708501	541	IPC 5/12-STGF-7,62	1709364	527	ISPC 5/ 6-STF-7,62	1749010	535	KGS-PC 4/ 9	1837285	523
IPC 5/ 3-GFU-7,62	1708721	541	IPC 16/ 2-G-10,16	1969890	572	ISPC 5/ 6-STGCL-7,62	1748901	534	KGS-PC 4/ 9-F	1837382	523
IPC 5/ 3-GU-7,62	1708611	541	IPC 16/ 2-GF-10,16	1969771	573	ISPC 5/ 6-STGF-7,62	1749243	535	KGS-PC 4/10	1837298	523
IPC 5/ 3-ST-7,62	1709050	526	IPC 16/ 3-G-10,16	1969700	572	ISPC 5/ 7-STF-7,62	1749023	535	KGS-PC 4/10-F	1837395	523
IPC 5/ 3-STF-7,62	1709160	527	IPC 16/ 3-GF-10,16	1969784	573	ISPC 5/ 7-STGCL-7,62	1748914	534	KGS-PC 4/11	1837308	523
IPC 5/ 3-STGCL-7,62	1718274	527	IPC 16/ 4-G-10,16	1969713	572	ISPC 5/ 7-STGF-7,62	1749256	535	KGS-PC 4/11-F	1837405	523
IPC 5/ 3-STGF-7,62	1709270	527	IPC 16/ 4-GF-10,16	1969797	573	ISPC 5/ 8-STF-7,62	1749036	535	KGS-PC 4/12	1837311	523
IPC 5/ 4-G-7,62	1708404	540	IPC 16/ 5-G-10,16	1969726	572	ISPC 5/ 8-STGCL-7,62	1748927	534	KGS-PC 4/12-F	1837418	523
IPC 5/ 4-GF-7,62	1708514	541	IPC 16/ 5-GF-10,16	1969807	573	ISPC 5/ 8-STGF-7,62	1749269	535	KST-POF	1933011	436
IPC 5/ 4-GFU-7,62	1708734	541	IPC 16/ 6-G-10,16	1969739	572	ISPC 5/ 9-STF-7,62	1749049	535			
IPC 5/ 4-GU-7,62	1708624	541	IPC 16/ 6-GF-10,16	1969810	573	ISPC 5/ 9-STGCL-7,62	1748930	534			
IPC 5/ 4-ST-7,62	1709063	526	IPC 16/ 7-G-10,16	1969742	572	ISPC 5/ 9-STGF-7,62	1749272	535			
IPC 5/ 4-STF-7,62	1709173	527	IPC 16/ 7-GF-10,16	1969823	573	ISPC 5/10-STF-7,62	1749052	535			
IPC 5/ 4-STF-SH-7,62	1709380	528	IPC 16/ 8-G-10,16	1969755	572	ISPC 5/10-STGCL-7,62	1748943	534			
IPC 5/ 4-STGCL-7,62	1718287	527	IPC 16/ 8-GF-10,16	1969836	573	ISPC 5/10-STGF-7,62	1749285	535			
IPC 5/ 4-STGF-7,62	1709283	527	IPC 16/ 9-G-10,16	1969768	572	ISPC 5/11-STF-7,62	1749065	535	MC 0,5/ 2-G-2,5	1881448	172
IPC 5/ 4-STGF-SH-7,62	1709377	529	IPC 16/ 9-GF-10,16	1969849	573	ISPC 5/11-STGCL-7,62	1748956	534	MC 0,5/ 2-G-2,5 THT	1963421	170
IPC 5/ 5-G-7,62	1708417	540	IPC 35 HC/ 2-GF-15,00	1793558	593	ISPC 5/11-STGF-7,62	1749298	535	MC 0,5/ 2-G-2,5 THT R44	1963641	171
IPC 5/ 5-GF-7,62	1708527	541	IPC 35 HC/ 3-GF-15,00	1793561	593	ISPC 5/12-STF-7,62	1749078	535	MC 0,5/ 2-G-2,54 P20 THR R24	1821245	176
IPC 5/ 5-GFU-7,62	1708747	541	IPC 35 HC/ 4-GF-15,00	1793574	593	ISPC 5/12-STGCL-7,62	1748969	534	MC 0,5/ 2-G-2,54 P20THR24C1	1706225	178
IPC 5/ 5-GU-7,62	1708637	541	IPC 35 HC/ 5-GF-15,00	1793587	593	ISPC 5/12-STGF-7,62	1749308	535	MC 0,5/ 2-G-2,54 P20THR24C2	1706207	177
IPC 5/ 5-ST-7,62	1709076	526	IPC 35 HC/ 6-GF-15,00	1793590	593				MC 0,5/ 2-G-2,54 SMD R24	1821698	178
IPC 5/ 5-STF-7,62	1709186	527	IPC 5/ 2-G-7,62	1708828	542				MC 0,5/ 2-G-2,54 SMDR24C1	1706151	179
IPC 5/ 5-STGCL-7,62	1718290	527	IPC 5/ 2-GF-7,62	1708938	543				MC 0,5/ 2-G-2,54 SMDR24C2	1706131	179
IPC 5/ 5-STGF-7,62	1709296	527	IPC 5/ 3-G-7,62	1708831	542				MC 0,5/ 3-G-2,5	1881451	172
IPC 5/ 6-G-7,62	1708420	540	IPC 5/ 3-GF-7,62	1708941	543				MC 0,5/ 3-G-2,5 THT	1963434	170
IPC 5/ 6-GF-7,62	1708530	541	IPC 5/ 4-G-7,62	1708844	542				MC 0,5/ 3-G-2,5 THT R44	1963654	171
IPC 5/ 6-GFU-7,62	1708750	541	IPC 5/ 4-GF-7,62	1708954	543	KDS 2,5	1705016	117	MC 0,5/ 3-G-2,54 P20 THR R24	1821258	176
IPC 5/ 6-GU-7,62	1708640	541	IPC 5/ 5-G-7,62	1708857	542	KDS 2,5 BU	1705090	117	MC 0,5/ 3-G-2,54 P20THR24C1	1706224	178
IPC 5/ 6-ST-7,62	1709089	526	IPC 5/ 5-GF-7,62	1708967	543	KDS 3-MT	1780015	117	MC 0,5/ 3-G-2,54 P20THR24C2	1706205	178
IPC 5/ 6-STF-7,62	1709199	527	IPC 5/ 6-G-7,62	1708860	542	KDS 3-PMT	1780028	117	MC 0,5/ 3-G-2,54 SMD R24	1821708	177
IPC 5/ 6-STGCL-7,62	1718300	527	IPC 5/ 6-GF-7,62	1708970	543	KDS 4	1780507	127	MC 0,5/ 3-G-2,54 SMDR24C1	1706149	179
IPC 5/ 6-STGF-7,62	1709306	527	IPC 5/ 7-G-7,62	1708873	542	KDS10	1704020	457	MC 0,5/ 3-G-2,54 SMDR24C2	1706130	179
IPC 5/ 7-G-7,62	1708433	540	IPC 5/ 7-GF-7,62	1708983	543	KDS10-PE	1704033	457	MC 0,5/ 4-G-2,5	1881464	172
IPC 5/ 7-GF-7,62	1708543	541	IPC 5/ 8-G-7,62	1708886	542	KDS10-PE/SO	1704062	459	MC 0,5/ 4-G-2,5 THT	1963447	170
IPC 5/ 7-GFU-7,62	1708763	541	IPC 5/ 8-GF-7,62	1708996	543	KDS10/SO	1704059	457	MC 0,5/ 4-G-2,5 THT R44	1963667	171
IPC 5/ 7-GU-7,62	1708653	541	IPC 5/ 9-G-7,62	1708899	542	KDSP 4	1780536	127	MC 0,5/ 4-G-2,54 P20 THR R24	1821261	176
IPC 5/ 7-ST-7,62	1709092	526	IPC 5/ 9-GF-7,62	1709005	543	KGG-MC 1,5/ 2	1834343	242	MC 0,5/ 4-G-2,54 P20THR24C1	1706223	178
IPC 5/ 7-STF-7,62	1709209	527	IPC 5/10-G-7,62	1708909	542	KGG-MC 1,5/ 3	1834356	242	MC 0,5/ 4-G-2,54 P20THR24C2	1706204	178
IPC 5/ 7-STGCL-7,62	1718313	527	IPC 5/10-GF-7,62								

Type	Order No.	Page	Type	Order No.	Page	Type	Order No.	Page	Type	Order No.	Page
MC 0,5/5-G-2,54 P20THR24C2	1706203	178	MC 0,5/15-G-2,54 P20THR56C1	1706209	178	MC 1,5/3-ST-3,5	1840379	190	MC 1,5/5-GF-3,81-LR	1817835	225
MC 0,5/5-G-2,54 SMD R24	1821724	177	MC 0,5/15-G-2,54 P20THR56C2	1706190	178	MC 1,5/3-ST-3,5-LR	1816865	191	MC 1,5/5-GF-5,08	1847495	249
MC 0,5/5-G-2,54 SMDR24C1	1706146	179	MC 0,5/15-G-2,54 P20THR56C1	1821821	177	MC 1,5/3-ST-3,81	1803581	190	MC 1,5/5-ST-3,5	1840395	190
MC 0,5/5-G-2,54 SMDR24C2	1706128	179	MC 0,5/15-G-2,54 SMDR56C1	1706133	179	MC 1,5/3-ST-3,81-LR	1817055	191	MC 1,5/5-ST-3,5-LR	1816881	191
MC 0,5/6-G-2,5	1881480	172	MC 0,5/15-G-2,54 SMDR56C2	1706115	179	MC 1,5/3-ST-5,08	1836082	247	MC 1,5/5-ST-3,81	1803604	190
MC 0,5/6-G-2,5 THT	1963463	170	MC 0,5/16-G-2,54 P20 THR R72	1821384	176	MC 1,5/3-ST1-5,08	1900785	246	MC 1,5/5-ST-3,81 AU	1860883	692
MC 0,5/6-G-2,5 THT R44	1963683	171	MC 0,5/16-G-2,54 P20THR72C1	1706208	178	MC 1,5/3-ST1F-5,08	1900895	247	MC 1,5/5-ST-3,81 GY7035 AU	1719697	692
MC 0,5/6-G-2,54 P20 THR R44	1821287	176	MC 0,5/16-G-2,54 P20THR72C2	1706188	178	MC 1,5/3-STF-3,5	1847068	191	MC 1,5/5-ST-3,81-LR	1817071	191
MC 0,5/6-G-2,54 P20THR44C1	1706220	178	MC 0,5/16-G-2,54 SMD R72	1821834	177	MC 1,5/3-STF-3,81	1827716	191	MC 1,5/5-ST-5,08	1836105	247
MC 0,5/6-G-2,54 P20THR44C2	1706201	178	MC 0,5/16-G-2,54 SMDR72C1	1706132	179	MC 1,5/3-STF-5,08	1847369	247	MC 1,5/5-ST1-5,08	1900808	246
MC 0,5/6-G-2,54 SMD R44	1821737	177	MC 0,5/16-G-2,54 SMDR72C2	1706114	179	MC 1,5/3-STZ1-3,5	1768871	191	MC 1,5/5-ST1F-5,08	1900918	247
MC 0,5/6-G-2,54 SMDR44C1	1706145	179	MC 1,5/2-G-3,5	1844210	224	MC 1,5/3-STZ1-3,81	1768923	191	MC 1,5/5-STF-3,5	1847084	191
MC 0,5/6-G-2,54 SMDR44C2	1706127	179	MC 1,5/2-G-3,5 P14 THR	1788945	214	MC 1,5/4-G-3,5	1844236	224	MC 1,5/5-STF-3,81	1827732	191
MC 0,5/7-G-2,5	1881493	172	MC 1,5/2-G-3,5 P14 THRR32	1788958	208	MC 1,5/4-G-3,5 P14 THR	1788987	214	MC 1,5/5-STF-5,08	1847385	247
MC 0,5/7-G-2,5 THT	1963476	170	MC 1,5/2-G-3,5 P20 THRR32	1788738	210	MC 1,5/4-G-3,5 P14 THRR32	1788990	208	MC 1,5/5-STZ2-3,5	1767623	191
MC 0,5/7-G-2,5 THT R44	1963696	171	MC 1,5/2-G-3,5 P26 THR	1788505	216	MC 1,5/4-G-3,5 P20 THRR32	1788770	210	MC 1,5/5-STZ2-3,81	1768936	191
MC 0,5/7-G-2,54 P20 THR R44	1821290	176	MC 1,5/2-G-3,5 P26 THRR32	1788518	212	MC 1,5/4-G-3,5 P26 THR	1788547	216	MC 1,5/6-G-3,5	1844252	224
MC 0,5/7-G-2,54 P20THR44C1	1706218	178	MC 1,5/2-G-3,5-RN	1731675	225	MC 1,5/4-G-3,5 P26 THRR32	1788550	212	MC 1,5/6-G-3,5 P14 THR	1789025	214
MC 0,5/7-G-2,54 P20THR44C2	1706200	178	MC 1,5/2-G-3,81	1803277	224	MC 1,5/4-G-3,5-RN	1731691	225	MC 1,5/6-G-3,5 P14 THRR56	1789038	208
MC 0,5/7-G-2,54 SMD R44	1821740	177	MC 1,5/2-G-3,81 P14 THR	1782352	214	MC 1,5/4-G-3,81	1803293	224	MC 1,5/6-G-3,5 P20 THRR56	1788819	210
MC 0,5/7-G-2,54 SMDR44C1	1706144	179	MC 1,5/2-G-3,81 P14 THRR32	1722095	208	MC 1,5/4-G-3,81 P14 THR	1782378	214	MC 1,5/6-G-3,5 P26 THR	1788589	216
MC 0,5/7-G-2,54 SMDR44C2	1706126	179	MC 1,5/2-G-3,81 P20 THRR32	1782572	210	MC 1,5/4-G-3,81 P14 THRR32	1722118	208	MC 1,5/6-G-3,5 P26 THRR56	1788592	212
MC 0,5/8-G-2,5	1881503	172	MC 1,5/2-G-3,81 P26 THR	1721986	216	MC 1,5/4-G-3,81 P20 THRR32	1782598	210	MC 1,5/6-G-3,5-RN	1731714	225
MC 0,5/8-G-2,5 THT	1939303	170	MC 1,5/2-G-3,81 P26 THRR32	1782462	212	MC 1,5/4-G-3,81 P26 THR	1722008	216	MC 1,5/6-G-3,81	1803316	224
MC 0,5/8-G-2,5 THT R44	1963706	171	MC 1,5/2-G-5,08	1836189	248	MC 1,5/4-G-3,81 P26 THRR32	1782488	212	MC 1,5/6-G-3,81 P14 THR	1782394	214
MC 0,5/8-G-2,54 P20 THR R44	1821300	176	MC 1,5/2-GF-3,5	1843790	225	MC 1,5/4-G-5,08	1836202	248	MC 1,5/6-G-3,81 P14 THRR56	1702663	208
MC 0,5/8-G-2,54 P20THR44C1	1706217	178	MC 1,5/2-GF-3,5 P14 THR	1789601	215	MC 1,5/4-GF-3,5	1843813	225	MC 1,5/6-G-3,81 P20 THRR56	1782611	210
MC 0,5/8-G-2,54 P20THR44C2	1706199	178	MC 1,5/2-GF-3,5 P14 THRR32	1789614	209	MC 1,5/4-GF-3,5 P14 THR	1789643	215	MC 1,5/6-G-3,81 P26 THR	1722024	216
MC 0,5/8-G-2,54 SMD R44	1821753	177	MC 1,5/2-GF-3,5 P20 THRR32	1789397	211	MC 1,5/4-GF-3,5 P14 THRR56	1789656	209	MC 1,5/6-G-3,81 P26 THRR56	1782501	212
MC 0,5/8-G-2,54 SMDR44C1	1706143	179	MC 1,5/2-GF-3,5 P26 THR	1789164	217	MC 1,5/4-GF-3,5 P20 THRR56	1789436	211	MC 1,5/6-G-5,08	1836228	248
MC 0,5/8-G-2,54 SMDR44C2	1706124	179	MC 1,5/2-GF-3,5 P26 THRR32	1789177	213	MC 1,5/4-GF-3,5 P26 THR	1789203	217	MC 1,5/6-GF-3,5	1843839	225
MC 0,5/9-G-2,5	1881516	172	MC 1,5/2-GF-3,5-LR	1817615	225	MC 1,5/4-GF-3,5 P26 THRR56	1789216	213	MC 1,5/6-GF-3,5 P14 THR	1789685	215
MC 0,5/9-G-2,5 THT	1963492	170	MC 1,5/2-GF-3,81	1827868	225	MC 1,5/4-GF-3,5-LR	1817631	225	MC 1,5/6-GF-3,5 P14 THRR56	1789698	209
MC 0,5/9-G-2,5 THT R44	1963719	171	MC 1,5/2-GF-3,81 P14 THR	1781803	215	MC 1,5/4-GF-3,81	1827884	225	MC 1,5/6-GF-3,5 P20 THRR56	1789478	211
MC 0,5/9-G-2,54 P20 THR R44	1821313	176	MC 1,5/2-GF-3,81 P14 THRR32	1782132	209	MC 1,5/4-GF-3,81 P14 THR	1781829	215	MC 1,5/6-GF-3,5 P26 THR	1789245	217
MC 0,5/9-G-2,54 P20THR44C1	1706216	178	MC 1,5/2-GF-3,81 P20 THRR32	1782022	211	MC 1,5/4-GF-3,81 P14 THRR56	1782158	209	MC 1,5/6-GF-3,5 P26 THRR56	1789258	213
MC 0,5/9-G-2,54 P20THR44C2	1706198	178	MC 1,5/2-GF-3,81 P26 THR	1722150	217	MC 1,5/4-GF-3,81 P20 THRR56	1782048	211	MC 1,5/6-GF-3,5-LR	1817657	225
MC 0,5/9-G-2,54 SMD R44	1821766	177	MC 1,5/2-GF-3,81 P26 THRR32	1781913	213	MC 1,5/4-GF-3,81 P26 THR	1722176	217	MC 1,5/6-GF-3,81	1827907	225
MC 0,5/9-G-2,54 SMDR44C1	1706142	179	MC 1,5/2-GF-3,81-LR	1817806	225	MC 1,5/4-GF-3,81 P26 THRR56	1781939	213	MC 1,5/6-GF-3,81 P14 THR	1781845	215
MC 0,5/9-G-2,54 SMDR44C2	1706123	179	MC 1,5/2-GF-5,08	1847466	249	MC 1,5/4-GF-3,81-LR	1817822	225	MC 1,5/6-GF-3,81 P14 THRR56	1827174	209
MC 0,5/10-G-2,5	1881529	172	MC 1,5/2-ST-3,5	1840366	190	MC 1,5/4-GF-5,08	1847482	249	MC 1,5/6-GF-3,81 P20 THRR56	1782064	211
MC 0,5/10-G-2,5 THT	1963502	170	MC 1,5/2-ST-3,5-LR	1816852	191	MC 1,5/4-ST-3,5	1840382	190	MC 1,5/6-GF-3,81 P26 THR	1722202	217
MC 0,5/10-G-2,5 THT R44	1963722	171	MC 1,5/2-ST-3,81	1803578	190	MC 1,5/4-ST-3,5-LR	1816878	191	MC 1,5/6-GF-3,81 P26 THRR56	1781955	213
MC 0,5/10-G-2,54 P20 THR R56	1821326	176	MC 1,5/2-ST-3,81 AU	1851999	692	MC 1,5/4-ST-3,81	1803594	190	MC 1,5/6-GF-3,81-LR	1817848	225
MC 0,5/10-G-2,54 P20THR44C1	1706214	178	MC 1,5/2-ST-3,81-LR	1817042	191	MC 1,5/4-ST-3,81-LR	1817068	191	MC 1,5/6-GF-5,08	1847505	249
MC 0,5/10-G-2,54 P20THR44C2	1706197	178	MC 1,5/2-ST-5,08	1836079	247	MC 1,5/4-ST-5,08	1836095	247	MC 1,5/6-ST-3,5	1840405	190
MC 0,5/10-G-2,54 SMD R56	1821779	177	MC 1,5/2-ST1-5,08	1900772	246	MC 1,5/4-ST1-5,08	1900798	246	MC 1,5/6-STF-5,08	1816894	191
MC 0,5/10-G-2,54 SMDR44C1	1706140	179	MC 1,5/2-ST1F-5,08	1900882	247	MC 1,5/4-ST1F-5,08	1900905	247	MC 1,5/6-ST-3,81	1803617	190
MC 0,5/10-G-2,54 SMDR44C2	1706122	179	MC 1,5/2-STF-3,5	1847055	191	MC 1,5/4-STF-3,5	1847071	191	MC 1,5/6-ST-3,81-LR	1817084	191
MC 0,5/11-G-2,5	1881532	172	MC 1,5/2-STF-3,81	1827703	191	MC 1,5/4-STF-3,81	1827729	191	MC 1,5/6-ST-5,08	1836118	247
MC 0,5/11-G-2,5 THT	1963515	170	MC 1,5/2-STF-5,08	1847356	247	MC 1,5/4-STF-5,08	1847372	247	MC 1,5/6-ST1-5,08	1900811	246
MC 0,5/11-G-2,5 THT R44	1963735	171	MC 1,5/3-G-3,5	1844223	224	MC 1,5/4-STZ1-3,5	1767500	191	MC 1,5/6-ST1F-5,08	1900921	247
MC 0,5/11-G-2,54 P20 THR R56	1821339	176	MC 1,5/3-G-3,5 P14 THR	1788961	214	MC 1,5/4-STZ1-3,81	1767461	191	MC 1,5/6-STF-3,5	1847097	191
MC 0,5/11-G-2,54 P20THR56C1	1706213	178	MC 1,5/3-G-3,5 P14 THRR32	1788974	208	MC 1,5/5-G-3,5	1844249	224	MC 1,5/6-STF-3,81	1827745	191
MC 0,5/11-G-2,54 P20THR56C2	1706195	178	MC 1,5/3-G-3,5 P20 THRR32	1788754	210	MC 1,5/5-G-3,5 P14 THR	1789009	214	MC 1,5/6-STF-5,08	1847398	247
MC 0,5/11-G-2,54 SMD R56	1821782	177	MC 1,5/3-G-3,5 P26 THR	1788521	216	MC 1,5/5-G-3,5 P14 THRR56	1789012	208	MC 1,5/6-STZ2-3,5	1767610	191
MC 0,5/11-G-2,54 SMDR56C1	1706139	179	MC 1,5/3-G-3,5 P26 THRR32	1788534	212	MC 1,5/5-G-3,5 P20 THRR56	1788796	210	MC 1,5/6-STZ2-3,81	1767694	191
MC 0,5/11-G-2,54 SMDR56C2	1706120	179	MC 1,5/3-G-3,5-RN	1731688	225	MC 1,5/5-G-3,5 P26 THR	1788563	216	MC 1,5/7-G-3,5	1844265	224
MC 0,5/12-G-2,5	1881545	172	MC 1,5/3-G-3,81	1803280	224	MC 1,5/5-G-3,5 P26 THRR56	1788576	212	MC 1,5/7-G-3,5 P14 THR	1789041	214
MC 0,5/12-G-2,5 THT	1939316	170	MC 1,5/3-G-3,81 P14 THR	1782365	214	MC 1,5/5-G-3,5-RN	1731701	225	MC 1,5/7-G-3,5 P14 THRR56	1789054	208
MC 0,5/12-G-2,5 THT R44	1963748	171	MC 1,5/3-G-3,81 P14 THRR32	1722105	208	MC 1,5/5-G-3,81	1803303	224	MC 1,5/7-G-3,5 P20 THRR56	1788835	210
MC 0,5/12-G-2,54 P20 THR R56	1821342	176	MC 1,5/3-G-3,81 P20 THRR32	1782585	210	MC 1,5/5-G-3,81 P14 THR	1782381	214	MC 1,5/7-G-3,5 P26 THR	1788602	216
MC 0,5/12-G-2,54 P20THR56C1	1706212	178	MC 1,5/3-G-3,81 P26 THR	1721999	216	MC 1,5/5-G-3,81 P14 THRR56	1702662	208	MC 1,5/7-G-3,5 P26 THRR56	1788615	212
MC 0,5/12-G-2,54 P20THR56C2	1706194	178	MC 1,5/3-G-3,81 P26 THRR32	1782475	212	MC 1,5/5-G-3,81 P20 THRR56	1782608	210	MC 1,5/7-G-3,5-RN	1731727	225
MC 0,5/12-G-2,54 SMD R56	1821795	177	MC 1,5/3-G-5,08	1836192	248	MC 1,5/5-G-3,81 P26 THR	1722011	216	MC 1,5/7-G-3,81	1803329	224
MC 0,5/12-G-2,54 SMDR56C1	1706137	179									

Index

Alphabetical

Type	Order No.	Page	Type	Order No.	Page	Type	Order No.	Page	Type	Order No.	Page
MC 1,5/7-GF-3,81 P14 THRR56	1782187	209	MC 1,5/9-GF-3,81	1827936	225	MC 1,5/11-G-3,81 P26 THRR56	1782556	212	MC 1,5/13-STF-3,5	1847233	191
MC 1,5/7-GF-3,81 P20 THRR56	1782077	211	MC 1,5/9-GF-3,81 P14 THR	1781874	215	MC 1,5/11-G-5,08	1836273	248	MC 1,5/13-STF-3,81	1827813	191
MC 1,5/7-GF-3,81 P26 THR	1722215	217	MC 1,5/9-GF-3,81 P14 THRR72	1782200	209	MC 1,5/11-GF-3,5	1843884	225	MC 1,5/13-STZ4-3,81	1765557	191
MC 1,5/7-GF-3,81 P26 THRR56	1781968	213	MC 1,5/9-GF-3,81 P20 THRR72	1782093	211	MC 1,5/11-GF-3,5 P14 THR	1789782	215	MC 1,5/14-G-3,5	1844333	224
MC 1,5/7-GF-3,81-LR	1817851	225	MC 1,5/9-GF-3,81 P26 THR	1722231	217	MC 1,5/11-GF-3,5 P14 THRR72	1789795	209	MC 1,5/14-G-3,5-RN	1731798	224
MC 1,5/7-GF-5,08	1847518	249	MC 1,5/9-GF-3,81 P26 THRR72	1781984	213	MC 1,5/11-GF-3,5 P20 THRR72	1789575	211	MC 1,5/14-G-3,81	1803390	225
MC 1,5/7-ST-3,5	1840418	190	MC 1,5/9-GF-3,81-LR	1817877	225	MC 1,5/11-GF-3,5 P26 THR	1789342	217	MC 1,5/14-GF-3,5	1843910	225
MC 1,5/7-ST-3,5-LR	1816904	191	MC 1,5/9-GF-5,08	1847534	249	MC 1,5/11-GF-3,5 P26 THRR72	1789355	213	MC 1,5/14-GF-3,5-LR	1817738	225
MC 1,5/7-ST-3,81	1803620	190	MC 1,5/9-ST-3,5	1840434	190	MC 1,5/11-GF-3,5-LR	1817709	225	MC 1,5/14-GF-3,81	1827981	225
MC 1,5/7-ST-3,81-LR	1817097	191	MC 1,5/9-ST-3,5-LR	1816920	191	MC 1,5/11-GF-3,81	1827952	225	MC 1,5/14-GF-3,81-LR	1817929	225
MC 1,5/7-ST-5,08	1836121	247	MC 1,5/9-ST-3,81	1803646	190	MC 1,5/11-GF-3,81 P14 THR	1781890	215	MC 1,5/14-ST-3,5	1840489	190
MC 1,5/7-ST1-5,08	1900824	246	MC 1,5/9-ST-3,81-LR	1817110	191	MC 1,5/11-GF-3,81 P14 THRR72	1782226	209	MC 1,5/14-ST-3,5-LR	1816975	191
MC 1,5/7-ST1F-5,08	1900934	247	MC 1,5/9-ST-5,08	1836147	247	MC 1,5/11-GF-3,81 P20 THRR72	1782116	211	MC 1,5/14-ST-3,81	1803691	190
MC 1,5/7-STF-3,5	1847107	191	MC 1,5/9-ST1F-5,08	1900840	246	MC 1,5/11-GF-3,81 P26 THR	1722257	217	MC 1,5/14-ST-3,81-LR	1817165	191
MC 1,5/7-STF-3,81	1827758	191	MC 1,5/9-ST1F-5,08	1900950	247	MC 1,5/11-GF-3,81 P26 THRR72	1782006	213	MC 1,5/14-STF-3,5	1847246	191
MC 1,5/7-STF-5,08	1847408	247	MC 1,5/9-STF-3,5	1847194	191	MC 1,5/11-GF-3,81-LR	1817893	225	MC 1,5/14-STF-3,81	1827826	191
MC 1,5/7-STZ2-3,5	1768884	191	MC 1,5/9-STF-3,81	1827774	191	MC 1,5/11-GF-5,08	1847550	249	MC 1,5/15-G-3,5	1844346	224
MC 1,5/7-STZ2-3,81	1768949	191	MC 1,5/9-STF-5,08	1784724	247	MC 1,5/11-ST-3,5	1840450	190	MC 1,5/15-G-3,5-RN	1731808	225
MC 1,5/8-G-3,5	1844278	224	MC 1,5/9-STZ3-3,5	1768897	191	MC 1,5/11-ST-3,5-LR	1816946	191	MC 1,5/15-G-3,81	1803400	224
MC 1,5/8-G-3,5 P14 THR	1789067	214	MC 1,5/9-STZ3-3,81	1767665	191	MC 1,5/11-ST-3,81	1803662	190	MC 1,5/15-GF-3,5	1843923	225
MC 1,5/8-G-3,5 P14 THRR56	1789070	208	MC 1,5/10-G-3,5	1844294	224	MC 1,5/11-ST-3,81-LR	1817136	191	MC 1,5/15-GF-3,5-LR	1817741	225
MC 1,5/8-G-3,5 P20 THRR56	1788851	210	MC 1,5/10-G-3,5 P14 THR	1789106	214	MC 1,5/11-ST-5,08	1836163	247	MC 1,5/15-G-3,5-RN	1731808	225
MC 1,5/8-G-3,5 P26 THR	1788628	216	MC 1,5/10-G-3,5 P14 THRR56	1789119	208	MC 1,5/11-ST1-5,08	1900866	246	MC 1,5/15-GF-3,81-LR	1817932	225
MC 1,5/8-G-3,5 P26 THRR56	1788631	212	MC 1,5/10-G-3,5 P20 THRR56	1788893	210	MC 1,5/11-ST1F-5,08	1900976	247	MC 1,5/15-ST-3,5	1840492	190
MC 1,5/8-G-3,5-RN	1731730	225	MC 1,5/10-G-3,5 P26 THR	1788660	216	MC 1,5/11-STF-3,5	1847217	191	MC 1,5/15-ST-3,5-LR	1816988	191
MC 1,5/8-G-3,81	1803332	224	MC 1,5/10-G-3,5 P26 THRR56	1788673	212	MC 1,5/11-STF-3,81	1827790	191	MC 1,5/15-ST-3,81	1803701	190
MC 1,5/8-G-3,81 P14 THR	1782417	214	MC 1,5/10-G-3,5-RN	1731756	225	MC 1,5/11-STF-5,08	1847440	247	MC 1,5/15-ST-3,81-LR	1817178	191
MC 1,5/8-G-3,81 P14 THRR56	1702665	208	MC 1,5/10-G-3,81	1803558	224	MC 1,5/11-STZ4-3,5	1768907	191	MC 1,5/15-STF-3,5	1847259	191
MC 1,5/8-G-3,81 P20 THRR56	1782637	210	MC 1,5/10-G-3,81 P14 THR	1782433	214	MC 1,5/11-STZ4-3,81	1768965	191	MC 1,5/15-STF-3,81	1827839	191
MC 1,5/8-G-3,81 P26 THR	1722040	216	MC 1,5/10-G-3,81 P14 THRR56	1702667	208	MC 1,5/12-G-3,5	1844317	224	MC 1,5/16-G-3,5	1844359	224
MC 1,5/8-G-3,81 P26 THRR56	1782527	212	MC 1,5/10-G-3,81 P20 THRR56	1782653	210	MC 1,5/12-G-3,5 P14 THR	1789148	214	MC 1,5/16-G-3,5-RN	1731811	225
MC 1,5/8-G-5,08	1836244	248	MC 1,5/10-G-3,81 P26 THR	1722066	216	MC 1,5/12-G-3,5 P14 THRR72	1789151	208	MC 1,5/16-G-3,81	1803413	224
MC 1,5/8-GF-3,5	1843855	225	MC 1,5/10-G-3,81 P26 THRR56	1782543	212	MC 1,5/12-G-3,5 P20 THRR72	1788932	210	MC 1,5/16-GF-3,5	1843936	225
MC 1,5/8-GF-3,5 P14 THR	1789724	215	MC 1,5/10-G-5,08	1836260	248	MC 1,5/12-G-3,5 P26 THR	1788709	216	MC 1,5/16-GF-3,5-LR	1817754	225
MC 1,5/8-GF-3,5 P14 THRR56	1789737	209	MC 1,5/10-GF-3,5	1848371	225	MC 1,5/12-G-3,5 P26 THRR72	1788712	212	MC 1,5/16-GF-3,81	1828003	225
MC 1,5/8-GF-3,5 P20 THRR56	1789517	211	MC 1,5/10-GF-3,5 P14 THR	1789766	215	MC 1,5/12-G-3,5-RN	1731772	225	MC 1,5/16-GF-3,81-LR	1817945	225
MC 1,5/8-GF-3,5 P26 THR	1789287	217	MC 1,5/10-GF-3,5 P14 THRR72	1789779	209	MC 1,5/12-G-3,81	1803374	224	MC 1,5/16-ST-3,5	1840502	190
MC 1,5/8-GF-3,5 P26 THRR56	1789290	213	MC 1,5/10-GF-3,5 P20 THRR72	1789559	211	MC 1,5/12-G-3,81 P14 THR	1782459	214	MC 1,5/16-ST-3,5-LR	1816991	191
MC 1,5/8-GF-3,5-LR	1817673	225	MC 1,5/10-GF-3,5 P26 THR	1789326	217	MC 1,5/12-G-3,81 P14 THRR72	1702669	208	MC 1,5/16-ST-3,81	1803714	190
MC 1,5/8-GF-3,81	1827923	225	MC 1,5/10-GF-3,5 P26 THRR72	1789339	213	MC 1,5/12-G-3,81 P20 THRR72	1782679	210	MC 1,5/16-ST-3,81-LR	1817181	191
MC 1,5/8-GF-3,81 P14 THR	1781861	215	MC 1,5/10-GF-3,5-LR	1817699	225	MC 1,5/12-G-3,81 P26 THR	1722082	216	MC 1,5/16-STF-3,5	1847262	191
MC 1,5/8-GF-3,81 P14 THRR56	1782190	209	MC 1,5/10-GF-3,81	1827949	225	MC 1,5/12-G-3,81 P26 THRR72	1782569	212	MC 1,5/16-STF-3,81	1827942	191
MC 1,5/8-GF-3,81 P20 THRR56	1782080	211	MC 1,5/10-GF-3,81 P14 THR	1817887	215	MC 1,5/12-G-5,08	1836286	248	MCC 1/2-STZ-3,81	1852176	206
MC 1,5/8-GF-3,81 P26 THR	1722228	217	MC 1,5/10-GF-3,81 P14 THRR72	1782213	209	MC 1,5/12-GF-3,5	1843897	225	MCC 1/2-STZF-3,81	1852367	207
MC 1,5/8-GF-3,81 P26 THRR56	1781971	213	MC 1,5/10-GF-3,81 P20 THRR72	1782103	211	MC 1,5/12-GF-3,5 P14 THRR72	1789818	209	MCC 1/3-STZ-3,81	1852189	206
MC 1,5/8-GF-3,81-LR	1817864	225	MC 1,5/10-GF-3,81 P26 THR	1722244	217	MC 1,5/12-GF-3,5 P20 THRR72	1789591	211	MCC 1/3-STZF-3,81	1852370	207
MC 1,5/8-GF-5,08	1847521	249	MC 1,5/10-GF-3,81 P26 THRR72	1781997	213	MC 1,5/12-GF-3,5 P26 THR	1789368	215	MCC 1/4-STZ-3,81	1852192	206
MC 1,5/8-ST-3,5	1840421	190	MC 1,5/10-GF-3,81-LR	1817880	225	MC 1,5/12-GF-3,5 P26 THRR72	1789371	213	MCC 1/4-STZF-3,81	1852383	207
MC 1,5/8-ST-3,5-LR	1816917	191	MC 1,5/10-GF-5,08	1847547	249	MC 1,5/12-GF-3,5-LR	1817712	225	MCC 1/5-STZ-3,81	1852202	206
MC 1,5/8-ST-3,81	1803633	190	MC 1,5/10-LWL 1,5-3,5	1841161	244	MC 1,5/12-GF-3,81	1827965	225	MCC 1/5-STZF-3,81	1852396	207
MC 1,5/8-ST-3,81-LR	1817107	191	MC 1,5/10-LWL 1,5-3,81	1841174	245	MC 1,5/12-GF-3,81 P14 THR	1781900	215	MCC 1/6-STZ-3,81	1852215	206
MC 1,5/8-ST-5,08	1836134	247	MC 1,5/10-LWL 2,3-3,5	1841187	244	MC 1,5/12-GF-3,81 P14 THRR72	1782239	209	MCC 1/6-STZF-3,81	1852406	207
MC 1,5/8-ST1-5,08	1900837	246	MC 1,5/10-LWL 2,3-3,81	1841190	245	MC 1,5/12-GF-3,81 P20 THRR72	1782129	211	MCC 1/7-STZ-3,81	1852228	206
MC 1,5/8-ST1F-5,08	1900947	247	MC 1,5/10-LWL 4-3,5	1841200	244	MC 1,5/12-GF-3,81 P26 THR	1722260	217	MCC 1/7-STZF-3,81	1852419	207
MC 1,5/8-STF-3,5	1847181	191	MC 1,5/10-LWL 4-3,81	1841213	245	MC 1,5/12-GF-3,81 P26 THRR72	1782219	213	MCC 1/8-STZ-3,81	1852231	206
MC 1,5/8-STF-3,81	1827761	191	MC 1,5/10-ST-3,5	1840447	190	MC 1,5/12-GF-3,81-LR	1817903	225	MCC 1/8-STZF-3,81	1852422	207
MC 1,5/8-STF-5,08	1847411	247	MC 1,5/10-ST-3,5-LR	1816933	191	MC 1,5/12-GF-5,08	1847563	249	MCC 1/9-STZ-3,81	1852244	206
MC 1,5/8-STZ3-3,5	1765599	191	MC 1,5/10-ST-3,81	1803659	190	MC 1,5/12-ST-3,5	1840463	190	MCC 1/9-STZF-3,81	1852435	207
MC 1,5/8-STZ3-3,81	1768952	191	MC 1,5/10-ST-3,81 AU	1879599	692	MC 1,5/12-ST-3,5-LR	1816959	191	MCC 1/10-STZ-3,81	1852257	206
MC 1,5/9-G-3,5	1844281	224	MC 1,5/10-ST-3,81-LR	1817123	191	MC 1,5/12-ST-3,81	1803675	190	MCC 1/10-STZF-3,81	1852448	207
MC 1,5/9-G-3,5 P14 THR	1789083	214	MC 1,5/10-ST-5,08	1836150	247	MC 1,5/12-ST-3,81-LR	1817149	191	MCC 1/11-STZ-3,81	1852260	206
MC 1,5/9-G-3,5 P14 THRR56	1789096	208	MC 1,5/10-ST1-5,08	1900853	246	MC 1,5/12-ST-5,08	1836176	247	MCC 1/11-STZF-3,81	1852451	207
MC 1,5/9-G-3,5 P20 THRR56	1788877	210	MC 1,5/10-ST1F-5,08	1900963	247	MC 1,5/12-ST1-5,08	1900879	246	MCC 1/12-STZ-3,81	1852273	206
MC 1,5/9-G-3,5 P26 THR	1788644	216	MC 1,5/10-STF-3,5	1847204	191	MC 1,5/12-ST1F-5,08	1900989	247	MCC 1/12-STZF-3,81	1852464	207
MC 1,5/9-G-3,5 P26 THRR56	1788657	212	MC 1,5/10-STF-3,81	1827787	191	MC 1,5/12-STF-3,5	1847220	191	MCC 1/13-STZ-3,81	1852286	206
MC 1,5/9-G-3,5-RN	1731743	225	MC 1,5/10-STF-5,08	1847437	247	MC 1,5/12-STF-3,81	1827800	191	MCC 1/13-STZF-3,81	1852477	207
MC 1,5/9-G-3,81	1803345	224	MC 1,5/10-STZ4-3,5	1766255	191	MC 1,5/12-STF					

Type	Order No.	Page	Type	Order No.	Page	Type	Order No.	Page	Type	Order No.	Page
MCD 0,5/ 6-G1-2,5	1894846	173	MCDN 1,5/ 4-G1-3,5 P26THR	1953732	219	MCDNV 1,5/ 2-G1-3,5 RNP26THR	1952458	221	MCDNV 1,5/15-G1-3,81 P26THR	1750423	221
MCD 0,5/ 7-G1-2,5	1894859	173	MCDN 1,5/ 4-G1-3,5 RNP14THR	1953224	219	MCDNV 1,5/ 2-G1-3,81 P14THR	1750106	220	MCDNV 1,5/16-G1-3,5 P14THR	1953156	220
MCD 0,5/ 8-G1-2,5	1894862	173	MCDN 1,5/ 4-G1-3,5 RNP26THR	1953428	219	MCDNV 1,5/ 2-G1-3,5 P26THR	1750290	221	MCDNV 1,5/16-G1-3,5 P26THR	1952924	221
MCD 0,5/ 9-G1-2,5	1894875	173	MCDN 1,5/ 4-G1-3,81 P14THR	1749353	218	MCDNV 1,5/ 3-G1-3,5 P14THR	1952982	220	MCDNV 1,5/16-G1-3,5 RNP14THR	1952649	221
MCD 0,5/10-G1-2,5	1894888	173	MCDN 1,5/ 4-G1-3,81 P26THR	1749544	219	MCDNV 1,5/ 3-G1-3,5 P26THR	1952791	221	MCDNV 1,5/16-G1-3,5 RNP26THR	1952733	221
MCD 0,5/11-G1-2,5	1894891	173	MCDN 1,5/ 5-G1-3,5 P14THR	1953949	218	MCDNV 1,5/ 3-G1-3,5 RNP14THR	1952513	221	MCDNV 1,5/16-G1-3,81 P14THR	1750245	220
MCD 0,5/12-G1-2,5	1894901	173	MCDN 1,5/ 5-G1-3,5 P26THR	1953745	219	MCDNV 1,5/ 3-G1-3,5 RNP26THR	1952461	221	MCDNV 1,5/16-G1-3,81 P26THR	1750436	221
MCD 1,5/ 2-G-3,81	1829950	234	MCDN 1,5/ 5-G1-3,5 RNP14THR	1953237	219	MCDNV 1,5/ 3-G1-3,81 P14THR	1750119	220	MCDV 0,5/ 2-G1-2,5	1894914	173
MCD 1,5/ 2-G1-3,81	1843075	235	MCDN 1,5/ 5-G1-3,5 RNP26THR	1953554	219	MCDNV 1,5/ 3-G1-3,81 P26THR	1750300	221	MCDV 0,5/ 3-G1-2,5	1894927	173
MCD 1,5/ 2-G1F-3,81	1842911	235	MCDN 1,5/ 5-G1-3,81 P14THR	1749366	218	MCDNV 1,5/ 4-G1-3,5 P14THR	1952995	220	MCDV 0,5/ 4-G1-2,5	1894930	173
MCD 1,5/ 2-GF-3,81	1830101	235	MCDN 1,5/ 5-G1-3,81 P26THR	1749557	219	MCDNV 1,5/ 4-G1-3,5 P26THR	1952801	221	MCDV 0,5/ 5-G1-2,5	1894943	173
MCD 1,5/ 3-G-3,81	1829963	234	MCDN 1,5/ 6-G1-3,5 P14THR	1953952	218	MCDNV 1,5/ 4-G1-3,5 RNP14THR	1952526	221	MCDV 0,5/ 6-G1-2,5	1894956	173
MCD 1,5/ 3-G1-3,81	1843088	235	MCDN 1,5/ 6-G1-3,5 P26THR	1953758	219	MCDNV 1,5/ 4-G1-3,5 RNP26THR	1952474	221	MCDV 0,5/ 7-G1-2,5	1894969	173
MCD 1,5/ 3-G1F-3,81	1842924	235	MCDN 1,5/ 6-G1-3,5 RNP14THR	1953240	219	MCDNV 1,5/ 4-G1-3,81 P14THR	1750122	220	MCDV 0,5/ 8-G1-2,5	1894972	173
MCD 1,5/ 3-GF-3,81	1830114	235	MCDN 1,5/ 6-G1-3,5 RNP26THR	1953567	219	MCDNV 1,5/ 4-G1-3,81 P26THR	1750313	221	MCDV 0,5/ 9-G1-2,5	1894985	173
MCD 1,5/ 4-G-3,81	1829976	234	MCDN 1,5/ 6-G1-3,81 P14THR	1749379	218	MCDNV 1,5/ 5-G1-3,5 P14THR	1953004	220	MCDV 0,5/10-G1-2,5	1894988	173
MCD 1,5/ 4-G1-3,81	1843091	235	MCDN 1,5/ 6-G1-3,81 P26THR	1749560	219	MCDNV 1,5/ 5-G1-3,5 P26THR	1952814	221	MCDV 0,5/11-G1-2,5	1895007	173
MCD 1,5/ 4-G1F-3,81	1842937	235	MCDN 1,5/ 7-G1-3,5 P14THR	1953965	218	MCDNV 1,5/ 5-G1-3,5 RNP14THR	1952539	221	MCDV 0,5/12-G1-2,5	1895010	173
MCD 1,5/ 4-GF-3,81	1830127	235	MCDN 1,5/ 7-G1-3,5 P26THR	1953761	219	MCDNV 1,5/ 5-G1-3,5 RNP26THR	1952487	221	MCDV 1,5/ 2-G-3,81	1830402	236
MCD 1,5/ 5-G-3,81	1829989	234	MCDN 1,5/ 7-G1-3,5 RNP14THR	1953253	219	MCDNV 1,5/ 5-G1-3,81 P14THR	1750135	220	MCDV 1,5/ 2-G1-3,81	1847725	237
MCD 1,5/ 5-G1-3,81	1843101	235	MCDN 1,5/ 7-G1-3,5 RNP26THR	1953570	219	MCDNV 1,5/ 5-G1-3,81 P26THR	1750326	221	MCDV 1,5/ 2-G1F-3,81	1842762	237
MCD 1,5/ 5-G1F-3,81	1842940	235	MCDN 1,5/ 7-G1-3,81 P14THR	1749382	218	MCDNV 1,5/ 6-G1-3,5 P14THR	1953046	220	MCDV 1,5/ 2-GF-3,81	1830253	237
MCD 1,5/ 5-GF-3,81	1830130	235	MCDN 1,5/ 7-G1-3,81 P26THR	1749573	219	MCDNV 1,5/ 6-G1-3,5 P26THR	1952827	221	MCDV 1,5/ 3-G-3,81	1830415	236
MCD 1,5/ 6-G-3,81	1829992	234	MCDN 1,5/ 8-G1-3,5 P14THR	1953978	218	MCDNV 1,5/ 6-G1-3,5 RNP14THR	1952542	221	MCDV 1,5/ 3-G1-3,81	1847738	237
MCD 1,5/ 6-G1-3,81	1843114	235	MCDN 1,5/ 8-G1-3,5 P26THR	1953774	219	MCDNV 1,5/ 6-G1-3,5 RNP26THR	1952490	221	MCDV 1,5/ 3-G1F-3,81	1842775	237
MCD 1,5/ 6-G1F-3,81	1842953	235	MCDN 1,5/ 8-G1-3,5 RNP14THR	1953266	219	MCDNV 1,5/ 6-G1-3,81 P14THR	1750148	220	MCDV 1,5/ 3-GF-3,81	1830266	237
MCD 1,5/ 6-GF-3,81	1830143	235	MCDN 1,5/ 8-G1-3,5 RNP26THR	1953583	219	MCDNV 1,5/ 6-G1-3,81 P26THR	1750339	221	MCDV 1,5/ 4-G-3,81	1830428	236
MCD 1,5/ 7-G-3,81	1830004	234	MCDN 1,5/ 8-G1-3,81 P14THR	1749395	218	MCDNV 1,5/ 7-G1-3,5 P14THR	1953059	220	MCDV 1,5/ 4-G1-3,81	1847741	237
MCD 1,5/ 7-G1-3,81	1843127	235	MCDN 1,5/ 8-G1-3,81 P26THR	1749586	219	MCDNV 1,5/ 7-G1-3,5 P26THR	1952830	221	MCDV 1,5/ 4-G1F-3,81	1842788	237
MCD 1,5/ 7-G1F-3,81	1842966	235	MCDN 1,5/ 9-G1-3,5 P14THR	1953981	218	MCDNV 1,5/ 7-G1-3,5 RNP14THR	1952555	221	MCDV 1,5/ 4-GF-3,81	1830279	237
MCD 1,5/ 7-GF-3,81	1830156	235	MCDN 1,5/ 9-G1-3,5 P26THR	1953787	219	MCDNV 1,5/ 7-G1-3,5 RNP26THR	1952212	221	MCDV 1,5/ 5-G-3,81	1830431	236
MCD 1,5/ 8-G-3,81	1830017	234	MCDN 1,5/ 9-G1-3,5 RNP14THR	1953279	219	MCDNV 1,5/ 7-G1-3,81 P14THR	1750151	220	MCDV 1,5/ 5-G1-3,81	1847754	237
MCD 1,5/ 8-G1-3,81	1843130	235	MCDN 1,5/ 9-G1-3,5 RNP26THR	1953596	219	MCDNV 1,5/ 7-G1-3,81 P26THR	1750342	221	MCDV 1,5/ 5-G1F-3,81	1842791	237
MCD 1,5/ 8-G1F-3,81	1842979	235	MCDN 1,5/ 9-G1-3,81 P14THR	1749405	218	MCDNV 1,5/ 8-G1-3,5 P14THR	1953062	220	MCDV 1,5/ 5-GF-3,81	1830282	237
MCD 1,5/ 8-GF-3,81	1830169	235	MCDN 1,5/ 9-G1-3,81 P26THR	1749599	219	MCDNV 1,5/ 8-G1-3,5 P26THR	1952843	221	MCDV 1,5/ 6-G-3,81	1830444	236
MCD 1,5/ 9-G-3,81	1830020	234	MCDN 1,5/ 10-G1-3,5 P14THR	1953994	218	MCDNV 1,5/ 8-G1-3,5 RNP14THR	1952568	221	MCDV 1,5/ 6-G1-3,81	1847767	237
MCD 1,5/ 9-G1-3,81	1843143	235	MCDN 1,5/ 10-G1-3,5 P26THR	1953790	219	MCDNV 1,5/ 8-G1-3,5 RNP26THR	1952225	221	MCDV 1,5/ 6-G1F-3,81	1842801	237
MCD 1,5/ 9-G1F-3,81	1842982	235	MCDN 1,5/ 10-G1-3,5 RNP14THR	1953282	219	MCDNV 1,5/ 8-G1-3,81 P14THR	1750164	220	MCDV 1,5/ 6-GF-3,81	1830295	237
MCD 1,5/ 9-GF-3,81	1830172	235	MCDN 1,5/ 10-G1-3,5 RNP26THR	1953606	219	MCDNV 1,5/ 8-G1-3,81 P26THR	1750355	221	MCDV 1,5/ 7-G-3,81	1830457	236
MCD 1,5/ 10-G-3,81	1830033	234	MCDN 1,5/ 10-G1-3,81 P14THR	1749418	218	MCDNV 1,5/ 9-G1-3,5 P14THR	1953075	220	MCDV 1,5/ 7-G1-3,81	1847783	237
MCD 1,5/ 10-G1-3,81	1843156	235	MCDN 1,5/ 10-G1-3,81 P26THR	1749609	219	MCDNV 1,5/ 9-G1-3,5 P26THR	1952856	221	MCDV 1,5/ 7-G1F-3,81	1842814	237
MCD 1,5/ 10-G1F-3,81	1842995	235	MCDN 1,5/ 11-G1-3,5 P14THR	1954003	218	MCDNV 1,5/ 9-G1-3,5 RNP14THR	1952571	221	MCDV 1,5/ 7-GF-3,81	1830305	237
MCD 1,5/ 10-GF-3,81	1830185	235	MCDN 1,5/ 11-G1-3,5 P26THR	1953800	219	MCDNV 1,5/ 9-G1-3,5 RNP26THR	1952238	221	MCDV 1,5/ 8-G-3,81	1830460	236
MCD 1,5/ 11-G-3,81	1830046	234	MCDN 1,5/ 11-G1-3,5 RNP14THR	1953295	219	MCDNV 1,5/ 9-G1-3,81 P14THR	1750177	220	MCDV 1,5/ 8-G1-3,81	1847796	237
MCD 1,5/ 11-G1-3,81	1843169	235	MCDN 1,5/ 11-G1-3,5 RNP26THR	1953619	219	MCDNV 1,5/ 9-G1-3,81 P26THR	1750368	221	MCDV 1,5/ 8-G1F-3,81	1842827	237
MCD 1,5/ 11-G1F-3,81	1843004	235	MCDN 1,5/ 11-G1-3,81 P14THR	1749421	218	MCDNV 1,5/ 10-G1-3,5 P14THR	1953088	220	MCDV 1,5/ 8-GF-3,81	1830318	237
MCD 1,5/ 11-GF-3,81	1830198	235	MCDN 1,5/ 11-G1-3,81 P26THR	1749612	219	MCDNV 1,5/ 10-G1-3,81 P26THR	1952869	221	MCDV 1,5/ 9-G-3,81	1830473	236
MCD 1,5/ 12-G-3,81	1830059	234	MCDN 1,5/ 12-G1-3,5 P14THR	1954032	218	MCDNV 1,5/ 10-G1-3,5 RNP14THR	1952584	221	MCDV 1,5/ 9-G1-3,81	1847806	237
MCD 1,5/ 12-G1-3,81	1843172	235	MCDN 1,5/ 12-G1-3,5 P26THR	1953813	219	MCDNV 1,5/ 10-G1-3,5 RNP26THR	1952241	221	MCDV 1,5/ 9-G1F-3,81	1842830	237
MCD 1,5/ 12-G1F-3,81	1843017	235	MCDN 1,5/ 12-G1-3,5 RNP14THR	1953305	219	MCDNV 1,5/ 10-G1-3,81 P14THR	1750180	220	MCDV 1,5/ 9-GF-3,81	1830321	237
MCD 1,5/ 12-GF-3,81	1830208	235	MCDN 1,5/ 12-G1-3,5 RNP26THR	1953622	219	MCDNV 1,5/ 10-G1-3,81 P26THR	1750371	221	MCDV 1,5/ 10-G-3,81	1830486	236
MCD 1,5/ 13-G-3,81	1830062	234	MCDN 1,5/ 12-G1-3,81 P14THR	1749434	218	MCDNV 1,5/ 11-G1-3,5 P14THR	1953101	220	MCDV 1,5/ 10-G1-3,81	1847819	237
MCD 1,5/ 13-G1-3,81	1843185	235	MCDN 1,5/ 12-G1-3,81 P26THR	1749625	219	MCDNV 1,5/ 11-G1-3,5 P26THR	1952872	221	MCDV 1,5/ 10-G1F-3,81	1842843	237
MCD 1,5/ 13-G1F-3,81	1843033	235	MCDN 1,5/ 13-G1-3,5 P14THR	1954045	218	MCDNV 1,5/ 11-G1-3,5 RNP14THR	1952597	221	MCDV 1,5/ 10-GF-3,81	1830334	237
MCD 1,5/ 13-GF-3,81	1830211	235	MCDN 1,5/ 13-G1-3,5 P26THR	1953826	219	MCDNV 1,5/ 11-G1-3,5 RNP26THR	1952254	221	MCDV 1,5/ 11-G-3,81	1830499	236
MCD 1,5/ 14-G-3,81	1830075	234	MCDN 1,5/ 13-G1-3,5 RNP14THR	1953318	219	MCDNV 1,5/ 11-G1-3,81 P14THR	1750193	220	MCDV 1,5/ 11-G1-3,81	1847822	237
MCD 1,5/ 14-G1-3,81	1843198	235	MCDN 1,5/ 13-G1-3,5 RNP26THR	1953635	219	MCDNV 1,5/ 11-G1-3,81 P26THR	1750384	221	MCDV 1,5/ 11-G1F-3,81	1842856	237
MCD 1,5/ 14-G1F-3,81	1843046	235	MCDN 1,5/ 13-G1-3,81 P14THR	1749447	218	MCDNV 1,5/ 12-G1-3,5 P14THR	1953114	220	MCDV 1,5/ 11-GF-3,81	1830347	237
MCD 1,5/ 14-GF-3,81	1830224	235	MCDN 1,5/ 13-G1-3,81 P26THR	1749638	219	MCDNV 1,5/ 12-G1-3,5 P26THR	1952885	221	MCDV 1,5/ 12-G-3,81	1830509	236
MCD 1,5/ 15-G-3,81	1830088	234	MCDN 1,5/ 14-G1-3,5 P14THR	1954058	218	MCDNV 1,5/ 12-G1-3,5 RNP14THR	1952607	221	MCDV 1,5/ 12-G1-3,81	1847835	237
MCD 1,5/ 15-G1-3,81	1843208	235	MCDN 1,5/ 14-G1-3,5 P26THR	1953839	219	MCDNV 1,5/ 12-G1-3,5 RNP26THR	1952694	221	MCDV 1,5/ 12-G1F-3,81	1842869	237
MCD 1,5/ 15-G1F-3,81	1843059	235	MCDN 1,5/ 14-G1-3,5 RNP14THR	1953321	219	MCDNV 1,5/ 12-G1-3,81 P14THR	1750203	220	MCDV 1,5/ 12-GF-3,81	1830350	237
MCD 1,5/ 15-GF-3,81	1830237	235	MCDN 1,5/ 14-G1-3,5 RNP26THR	1953648	219	MCDNV 1,5/ 12-G1-3,81 P26THR	1750397	221	MCDV 1,5/ 13-G-3,81	1830512	236
MCD 1,5/ 16-G-3,81	1830091	234	MCDN 1,5/ 14-G1-3,81 P14THR	1749450	218	MCDNV 1,5/ 13-G1-3,5 P14THR	1953127	220	MCDV 1,5		

Index

Alphabetical

Type	Order No.	Page	Type	Order No.	Page	Type	Order No.	Page	Type	Order No.	Page
MCO 1,5/3-GL-3,81	1861730	230	MCV 0,5/8-G-2,54 SMD R44	1821601	177	MCV 1,5/2-GF-3,5 P20 THRR32	1780668	211	MCV 1,5/5-GF-3,5	1843253	227
MCO 1,5/3-GR-3,81	1861659	231	MCV 0,5/8-G-2,54 SMDR44C1	1706104	179	MCV 1,5/2-GF-3,5 P26 THR	1779064	217	MCV 1,5/5-GF-3,5 P14 THR	1779996	215
MCO 1,5/4-G1L-3,5 KMGY	2278364	232	MCV 0,5/8-G-2,54 SMDR44C2	1706087	179	MCV 1,5/2-GF-3,5 P26 THRR32	1779077	213	MCV 1,5/5-GF-3,5 P14 THRR56	1780008	209
MCO 1,5/4-G1R-3,5 KMGY	2278377	233	MCV 0,5/9-G-2,5	1881626	173	MCV 1,5/2-GF-3,5-LR	1817990	227	MCV 1,5/5-GF-3,5 P20 THRR56	1780723	211
MCO 1,5/4-GL-3,81	1861743	230	MCV 0,5/9-G-2,5 THT	1963609	171	MCV 1,5/2-GF-3,81	1830596	227	MCV 1,5/5-GF-3,5 P26 THR	1779129	217
MCO 1,5/4-GR-3,81	1861662	231	MCV 0,5/9-G-2,5 THT R44	1963829	171	MCV 1,5/2-GF-3,81 P14 THR	1707214	215	MCV 1,5/5-GF-3,5 P26 THRR56	1779132	213
MCO 1,5/5-G1L-3,5 KMGY	2278380	232	MCV 0,5/9-G-2,54 P20 THR R44	1821465	177	MCV 1,5/2-GF-3,81 P20 THRR32	1825775	211	MCV 1,5/5-GF-3,5-LR	1818025	227
MCO 1,5/5-G1R-3,5 KMGY	2278351	233	MCV 0,5/9-G-2,54 P20THRR56C1	1706179	179	MCV 1,5/2-GF-3,81 P26 THR	1707638	217	MCV 1,5/5-GF-3,81	1830622	227
MCO 1,5/5-GL-3,81	1861756	230	MCV 0,5/9-G-2,54 P20THRR56C2	1706160	179	MCV 1,5/2-GF-3,81 P26 THRR32	1713347	213	MCV 1,5/5-GF-3,81 P14 THR	1707243	215
MCO 1,5/5-GR-3,81	1861675	231	MCV 0,5/9-G-2,54 SMD R44	1821614	177	MCV 1,5/2-GF-3,81-LR	1818180	227	MCV 1,5/5-GF-3,81 P20 THRR56	1825801	211
MCO 1,5/6-GL-3,81	1861769	230	MCV 0,5/9-G-2,54 SMDR56C1	1706103	179	MCV 1,5/2-GF-5,08	1847615	249	MCV 1,5/5-GF-3,81 P26 THR	1707667	217
MCO 1,5/6-GR-3,81	1861688	231	MCV 0,5/9-G-2,54 SMDR56C2	1706085	179	MCV 1,5/3-G-3,5	1843619	226	MCV 1,5/5-GF-3,81 P26 THRR56	1713376	213
MCO 1,5/7-GL-3,81	1861772	230	MCV 0,5/10-G-2,5	1881639	173	MCV 1,5/3-G-3,5 P14 THR	1780215	215	MCV 1,5/5-GF-3,81-LR	1818216	227
MCO 1,5/7-GR-3,81	1861691	231	MCV 0,5/10-G-2,5 THT	1963612	171	MCV 1,5/3-G-3,5 P14 THRR32	1780228	209	MCV 1,5/5-GF-5,08	1847644	249
MCO 1,5/8-GL-3,81	1861785	230	MCV 0,5/10-G-2,5 THT R44	1963845	171	MCV 1,5/3-G-3,5 P20 THRR32	1780901	211	MCV 1,5/6-G-3,5	1843648	226
MCO 1,5/8-GR-3,81	1861701	231	MCV 0,5/10-G-2,54 P20 THR R56	1821478	177	MCV 1,5/3-G-3,5 P26 THR	1779381	217	MCV 1,5/6-G-3,5 P14 THR	1780273	215
MCO 1,5/9-GL-3,81	1861798	230	MCV 0,5/10-G-2,54 P20THRR56C1	1706178	179	MCV 1,5/3-G-3,5 P26 THRR32	1779394	213	MCV 1,5/6-G-3,5 P14 THRR56	1780286	209
MCO 1,5/9-GR-3,81	1861714	231	MCV 0,5/10-G-2,54 P20THRR56C2	1706159	179	MCV 1,5/3-G-3,5-RN	1731484	227	MCV 1,5/6-G-3,5 P20 THRR56	1780969	211
MCO 1,5/10-GL-3,81	1861808	230	MCV 0,5/10-G-2,54 SMD R56	1821627	177	MCV 1,5/3-G-3,81	1803439	226	MCV 1,5/6-G-3,5 P26 THR	1779446	217
MCO 1,5/10-GR-3,81	1861727	231	MCV 0,5/10-G-2,54 SMDR56C1	1706102	179	MCV 1,5/3-G-3,81 P14 THR	1707010	215	MCV 1,5/6-G-3,5 P26 THRR56	1779459	213
MCV 0,5/2-G-2,5	1881558	173	MCV 0,5/10-G-2,54 SMDR56C2	1706084	179	MCV 1,5/3-G-3,81 P14 THR R32	1728374	209	MCV 1,5/6-G-3,5-RN	1715232	227
MCV 0,5/2-G-2,5 THT	1963531	171	MCV 0,5/11-G-2,5	1881642	173	MCV 1,5/3-G-3,81 P20 THRR32	1825678	211	MCV 1,5/6-G-3,81	1803668	226
MCV 0,5/2-G-2,5 THT R44	1963751	171	MCV 0,5/11-G-2,5 THT	1963625	171	MCV 1,5/3-G-3,81 P26 THR	1707434	217	MCV 1,5/6-G-3,81 P14 THR	1707049	215
MCV 0,5/2-G-2,54 P20 THR R24	1821397	177	MCV 0,5/11-G-2,5 THT R44	1963858	171	MCV 1,5/3-G-3,81 P26 THRR32	1712843	213	MCV 1,5/6-G-3,81 P20 THRR56	1825704	211
MCV 0,5/2-G-2,54 P20THRR24C1	1706187	179	MCV 0,5/11-G-2,54 P20 THR R56	1821481	177	MCV 1,5/3-G-5,08	1836309	249	MCV 1,5/6-G-3,81 P26 THR	1707463	217
MCV 0,5/2-G-2,54 P20THRR24C2	1706169	179	MCV 0,5/11-G-2,54 P20THRR56C1	1706177	179	MCV 1,5/3-G-5,08	1843237	227	MCV 1,5/6-G-3,81 P26 THRR56	1712911	213
MCV 0,5/2-G-2,54 SMD R24	1821546	177	MCV 0,5/11-G-2,54 P20THRR56C2	1706158	179	MCV 1,5/3-GF-3,5 P14 THR	1779954	215	MCV 1,5/6-G-5,08	1836338	249
MCV 0,5/2-G-2,54 SMDR24C1	1706113	179	MCV 0,5/11-G-2,54 SMD R56	1821630	177	MCV 1,5/3-GF-3,5 P14 THRR56	1779967	209	MCV 1,5/6-GF-3,5	1843266	227
MCV 0,5/2-G-2,54 SMDR24C2	1706093	179	MCV 0,5/11-G-2,54 SMDR56C1	1706101	179	MCV 1,5/3-GF-3,5 P20 THRR56	1780684	211	MCV 1,5/6-GF-3,5 P14 THR	1780011	215
MCV 0,5/3-G-2,5	1881561	173	MCV 0,5/11-G-2,54 SMDR56C2	1706083	179	MCV 1,5/3-GF-3,5 P26 THR	1779080	217	MCV 1,5/6-GF-3,5 P14 THRR56	1780024	209
MCV 0,5/3-G-2,5 THT	1963544	171	MCV 0,5/12-G-2,5	1881655	173	MCV 1,5/3-GF-3,5 P26 THRR56	1779093	213	MCV 1,5/6-GF-3,5 P20 THRR56	1780749	211
MCV 0,5/3-G-2,5 THT R44	1963764	171	MCV 0,5/12-G-2,5 THT	1963638	171	MCV 1,5/3-GF-3,5-LR	1818009	227	MCV 1,5/6-GF-3,5 P26 THR	1779145	217
MCV 0,5/3-G-2,54 P20 THR R24	1821407	177	MCV 0,5/12-G-2,5 THT R44	1963861	171	MCV 1,5/3-GF-3,81	1830606	227	MCV 1,5/6-GF-3,5 P26 THRR56	1779158	213
MCV 0,5/3-G-2,54 P20THRR24C1	1706186	179	MCV 0,5/12-G-2,54 P20 THR R56	1821494	177	MCV 1,5/3-GF-3,81 P14 THR	1707227	215	MCV 1,5/6-GF-3,5-LR	1818038	227
MCV 0,5/3-G-2,54 P20THRR24C2	1706168	179	MCV 0,5/12-G-2,54 P20THRR56C1	1706175	179	MCV 1,5/3-GF-3,81 P20 THRR56	1825788	211	MCV 1,5/6-GF-3,81	1830635	227
MCV 0,5/3-G-2,54 SMD R24	1821559	177	MCV 0,5/12-G-2,54 P20THRR56C2	1706157	179	MCV 1,5/3-GF-3,81 P26 THR	1707641	217	MCV 1,5/6-GF-3,81 P14 THR	1707256	215
MCV 0,5/3-G-2,54 SMDR24C1	1706111	179	MCV 0,5/12-G-2,54 SMD R56	1821643	177	MCV 1,5/3-GF-3,81 P26 THRR56	1713350	213	MCV 1,5/6-GF-3,81 P20 THRR56	1825814	211
MCV 0,5/3-G-2,54 SMDR24C2	1706092	179	MCV 0,5/12-G-2,54 SMDR56C1	1706100	179	MCV 1,5/3-GF-3,81-LR	1818193	227	MCV 1,5/6-GF-3,81 P26 THR	1707670	217
MCV 0,5/4-G-2,5	1881574	173	MCV 0,5/12-G-2,54 SMDR56C2	1706081	179	MCV 1,5/3-GF-5,08	1847628	249	MCV 1,5/6-GF-3,81 P26 THRR56	1713389	213
MCV 0,5/4-G-2,5 THT	1963557	171	MCV 0,5/13-G-2,54 P20 THR R56	1821504	177	MCV 1,5/4-G-3,5	1843622	226	MCV 1,5/6-GF-3,81-LR	1818229	227
MCV 0,5/4-G-2,5 THT R44	1963777	171	MCV 0,5/13-G-2,54 P20THRR56C1	1706174	179	MCV 1,5/4-G-3,5 P14 THR	1780231	215	MCV 1,5/6-GF-5,08	1847657	249
MCV 0,5/4-G-2,54 P20 THR R24	1821410	177	MCV 0,5/13-G-2,54 P20THRR56C2	1706156	179	MCV 1,5/4-G-3,5 P14 THRR32	1780244	209	MCV 1,5/7-G-3,5	1843651	226
MCV 0,5/4-G-2,54 P20THRR24C1	1706185	179	MCV 0,5/13-G-2,54 SMD R56	1821656	177	MCV 1,5/4-G-3,5 P20 THRR32	1780927	211	MCV 1,5/7-G-3,5 P14 THR	1780299	215
MCV 0,5/4-G-2,54 P20THRR24C2	1706166	179	MCV 0,5/13-G-2,54 SMDR56C1	1706098	179	MCV 1,5/4-G-3,5 P26 THR	1779404	217	MCV 1,5/7-G-3,5 P14 THRR56	1780309	209
MCV 0,5/4-G-2,54 SMD R24	1821562	177	MCV 0,5/13-G-2,54 SMDR56C2	1706080	179	MCV 1,5/4-G-3,5 P26 THRR32	1779417	213	MCV 1,5/7-G-3,5 P20 THRR56	1780985	211
MCV 0,5/4-G-2,54 SMDR24C1	1706110	179	MCV 0,5/14-G-2,54 P20 THR R56	1821517	177	MCV 1,5/4-G-3,5-RN	1731497	227	MCV 1,5/7-G-3,5 P26 THR	1779462	217
MCV 0,5/4-G-2,54 SMDR24C2	1706091	179	MCV 0,5/14-G-2,54 P20THRR72C1	1706173	179	MCV 1,5/4-G-3,81	1803442	226	MCV 1,5/7-G-3,5 P26 THRR56	1779475	213
MCV 0,5/5-G-2,5	1881587	173	MCV 0,5/14-G-2,54 P20THRR72C2	1706155	179	MCV 1,5/4-G-3,81 P14 THR	1707023	215	MCV 1,5/7-G-3,5-RN	1731536	227
MCV 0,5/5-G-2,5 THT	1963560	171	MCV 0,5/14-G-2,54 SMD R56	1821669	177	MCV 1,5/4-G-3,81 P14 THR R32	1728387	209	MCV 1,5/7-G-3,81	1803471	226
MCV 0,5/5-G-2,5 THT R44	1963780	171	MCV 0,5/14-G-2,54 SMDR72C1	1706097	179	MCV 1,5/4-G-3,81 P20 THRR32	1825681	211	MCV 1,5/7-G-3,81 P14 THR	1707052	215
MCV 0,5/5-G-2,54 P20 THR R24	1821423	177	MCV 0,5/14-G-2,54 SMDR72C2	1706078	179	MCV 1,5/4-G-3,81 P26 THR	1707447	217	MCV 1,5/7-G-3,81 P20 THRR56	1825717	211
MCV 0,5/5-G-2,54 P20THRR44C1	1706184	179	MCV 0,5/15-G-2,54 P20 THR R56	1821520	177	MCV 1,5/4-G-3,81 P26 THRR32	1712872	213	MCV 1,5/7-G-3,81 P26 THR	1707476	217
MCV 0,5/5-G-2,54 P20THRR44C2	1706165	179	MCV 0,5/15-G-2,54 P20THRR72C1	1706172	179	MCV 1,5/4-G-5,08	1836312	249	MCV 1,5/7-G-3,81 P26 THRR56	1712937	213
MCV 0,5/5-G-2,54 SMD R24	1821575	177	MCV 0,5/15-G-2,54 P20THRR72C2	1706153	179	MCV 1,5/4-GF-3,5	1843240	227	MCV 1,5/7-G-5,08	1836341	249
MCV 0,5/5-G-2,54 SMDR44C1	1706108	179	MCV 0,5/15-G-2,54 SMD R56	1821672	177	MCV 1,5/4-GF-3,5 P14 THR	1779970	215	MCV 1,5/7-GF-3,5	1843279	227
MCV 0,5/5-G-2,54 SMDR44C2	1706090	179	MCV 0,5/15-G-2,54 SMDR72C1	1706096	179	MCV 1,5/4-GF-3,5 P14 THRR56	1779983	209	MCV 1,5/7-GF-3,5 P14 THR	1780037	215
MCV 0,5/6-G-2,5	1881590	173	MCV 0,5/16-G-2,54 SMDR72C2	1706077	179	MCV 1,5/4-GF-3,5 P20 THRR56	1780707	211	MCV 1,5/7-GF-3,5 P14 THRR56	1780040	209
MCV 0,5/6-G-2,5 THT	1963573	171	MCV 0,5/16-G-2,54 P20 THR R72	1821533	177	MCV 1,5/4-GF-3,5 P26 THR	1779103	217	MCV 1,5/7-GF-3,5 P20 THRR56	1780765	211
MCV 0,5/6-G-2,5 THT R44	1963793	171	MCV 0,5/16-G-2,54 P20THRR72C1	1706171	179	MCV 1,5/4-GF-3,5 P26 THRR56	1779116	213	MCV 1,5/7-GF-3,5 P26 THR	1779161	217
MCV 0,5/6-G-2,54 P20 THR R44	1821436	177	MCV 0,5/16-G-2,54 P20THRR72C2	1706152	179	MCV 1,5/4-GF-3,5-LR	1818012	227	MCV 1,5/7-GF-3,5 P26 THRR56	1779174	213
MCV 0,5/6-G-2,54 P20THRR44C1	1706182	179	MCV 0,5/16-G-2,54 SMD R72	1821685	177	MCV 1,5/4-GF-3,81	1830619	227	MCV 1,5/7-GF-3,5-LR	1818041	227
MCV 0,5/6-G-2,54 P20THRR44C2	1706164	179	MCV 0,5/16-G-2,54 SMDR72C1	1706094	179	MCV 1,5/4-GF-3,81 P14 THR	1707230	215	MCV 1,5/7-GF-3,81	1830648	227
MCV 0,5/6-G-2,54 SMD R44	1821588	177	MCV 0,5/16-G-2,54 SMDR72C2	1706076	179	MCV 1,5/4-GF-3,81 P20 THRR56	1825791	211			

Type	Order No.	Page	Type	Order No.	Page	Type	Order No.	Page	Type	Order No.	Page
MCV 1,5/ 8-G-3.81 P26 THRR56	1712940	213	MCV 1,5/11-G-3.81 P14 THR	1707094	215	MCVR 1,5/ 3-ST-3.81	1827130	192	MCVV 1,5/ 3-STF-3.5	1863013	193
MCV 1,5/ 8-G-5.08	1836354	249	MCV 1,5/11-G-3.81 P20 THRR72	1825759	211	MCVR 1,5/ 3-STF-3.5	1863314	193	MCVV 1,5/ 3-STF-3.81	1828508	193
MCV 1,5/ 8-GF-3.5	1843282	227	MCV 1,5/11-G-3.81 P26 THR	1707515	217	MCVR 1,5/ 3-STF-3.81	1828359	193	MCVV 1,5/ 4-ST-3.5	1862878	193
MCV 1,5/ 8-GF-3.5 P14 THR	1780053	215	MCV 1,5/11-G-3.81 P26 THRR72	1714003	213	MCVR 1,5/ 4-ST-3.5	1863178	192	MCVV 1,5/ 4-ST-3.81	1826995	193
MCV 1,5/ 8-GF-3.5 P14 THRR56	1780066	209	MCV 1,5/11-G-5.08	1836383	249	MCVR 1,5/ 4-ST-3.81	1827143	192	MCVV 1,5/ 4-STF-3.5	1863026	193
MCV 1,5/ 8-GF-3.5 P20 THRR56	1780781	211	MCV 1,5/11-GF-3.5	1843318	227	MCVR 1,5/ 4-STF-3.5	1863327	193	MCVV 1,5/ 4-STF-3.81	1828511	193
MCV 1,5/ 8-GF-3.5 P26 THR	1779187	217	MCV 1,5/11-GF-3.5 P14 THR	1707134	215	MCVR 1,5/ 4-STF-3.81	1828362	193	MCVV 1,5/ 5-ST-3.5	1862881	193
MCV 1,5/ 8-GF-3.5 P26 THRR56	1779190	213	MCV 1,5/11-GF-3.5 P14 THRR72	1780147	209	MCVR 1,5/ 5-ST-3.5	1863181	192	MCVV 1,5/ 5-ST-3.81	1827004	193
MCV 1,5/ 8-GF-3.5-LR	1818054	227	MCV 1,5/11-GF-3.5 P20 THRR72	1780846	211	MCVR 1,5/ 5-ST-3.81	1827156	192	MCVV 1,5/ 5-STF-3.5	1863039	193
MCV 1,5/ 8-GF-3.81	1830651	227	MCV 1,5/11-GF-3.5 P26 THR	1780118	217	MCVR 1,5/ 5-ST-3.81 AU	1893203	692	MCVV 1,5/ 5-STF-3.81	1828524	193
MCV 1,5/ 8-GF-3.81 P14 THR	1707272	215	MCV 1,5/11-GF-3.5 P26 THRR72	1780121	213	MCVR 1,5/ 5-ST-3.81 GY7035 AU	1719684	692	MCVV 1,5/ 6-ST-3.5	1862894	193
MCV 1,5/ 8-GF-3.81 P20 THRR56	1825830	211	MCV 1,5/11-GF-3.5-LR	1818083	227	MCVR 1,5/ 5-STF-3.5	1863330	193	MCVV 1,5/ 6-ST-3.81	1827017	193
MCV 1,5/ 8-GF-3.81 P26 THR	1707696	217	MCV 1,5/11-GF-3.81	1830680	227	MCVR 1,5/ 5-STF-3.81	1828375	192	MCVV 1,5/ 6-STF-3.5	1863042	193
MCV 1,5/ 8-GF-3.81 P26 THRR56	1713402	213	MCV 1,5/11-GF-3.81 P14 THR	1707308	215	MCVR 1,5/ 6-ST-3.5	1863194	193	MCVV 1,5/ 6-STF-3.81	1828537	193
MCV 1,5/ 8-GF-3.81-LR	1818245	227	MCV 1,5/11-GF-3.81 P20 THRR72	1825869	211	MCVR 1,5/ 6-ST-3.81	1827169	192	MCVV 1,5/ 7-ST-3.5	1862904	193
MCV 1,5/ 8-GF-5.08	1847673	249	MCV 1,5/11-GF-3.81 P26 THR	1707722	217	MCVR 1,5/ 6-STF-3.5	1863343	193	MCVV 1,5/ 7-ST-3.81	1827020	193
MCV 1,5/ 9-G-3.5	1843677	226	MCV 1,5/11-GF-3.81 P26 THRR72	1713431	213	MCVR 1,5/ 6-STF-3.81	1828388	193	MCVV 1,5/ 7-STF-3.5	1863055	193
MCV 1,5/ 9-G-3.5 P14 THR	1780338	215	MCV 1,5/11-GF-3.81-LR	1818274	227	MCVR 1,5/ 7-ST-3.5	1863204	192	MCVV 1,5/ 7-STF-3.81	1828543	193
MCV 1,5/ 9-G-3.5 P14 THRR56	1780341	209	MCV 1,5/11-GF-5.08	1847709	249	MCVR 1,5/ 7-ST-3.81	1827172	192	MCVV 1,5/ 8-ST-3.5	1862917	193
MCV 1,5/ 9-G-3.5 P20 THRR56	1781023	217	MCV 1,5/12-G-3.5	1843703	226	MCVR 1,5/ 7-STF-3.5	1863356	193	MCVV 1,5/ 8-ST-3.81	1827033	193
MCV 1,5/ 9-G-3.5 P26 THR	1779501	217	MCV 1,5/12-G-3.5 P14 THR	1780396	215	MCVR 1,5/ 7-STF-3.81	1828391	193	MCVV 1,5/ 8-STF-3.5	1863068	193
MCV 1,5/ 9-G-3.5 P26 THRR56	1779514	213	MCV 1,5/12-G-3.5 P14 THRR72	1780406	209	MCVR 1,5/ 8-ST-3.5	1863217	192	MCVV 1,5/ 8-STF-3.81	1828553	193
MCV 1,5/ 9-G-3.5-RN	1731552	227	MCV 1,5/12-G-3.5 P20 THRR72	1781081	211	MCVR 1,5/ 8-ST-3.81	1827185	192	MCVV 1,5/ 9-ST-3.5	1862920	193
MCV 1,5/ 9-G-3.81	1803497	226	MCV 1,5/12-G-3.5 P26 THR	1779569	217	MCVR 1,5/ 8-STF-3.5	1863369	193	MCVV 1,5/ 9-ST-3.81	1827046	193
MCV 1,5/ 9-G-3.81 P14 THR	1707078	215	MCV 1,5/12-G-3.5 P26 THRR72	1779572	213	MCVR 1,5/ 8-STF-3.81	1828401	193	MCVV 1,5/ 9-STF-3.5	1863071	193
MCV 1,5/ 9-G-3.81 P20 THRR56	1825733	211	MCV 1,5/12-G-3.5-RN	1731581	227	MCVR 1,5/ 9-ST-3.5	1863220	192	MCVV 1,5/ 9-STF-3.81	1828568	193
MCV 1,5/ 9-G-3.81 P26 THR	1707492	217	MCV 1,5/12-G-3.81	1803523	226	MCVR 1,5/ 9-ST-3.81	1827198	192	MCVV 1,5/10-ST-3.5	1862933	193
MCV 1,5/ 9-G-3.81 P26 THRR56	1713567	213	MCV 1,5/12-G-3.81 P14 THR	1707104	215	MCVR 1,5/ 9-STF-3.5	1863372	193	MCVV 1,5/10-ST-3.81	1827059	193
MCV 1,5/ 9-G-5.08	1836367	249	MCV 1,5/12-G-3.81 P20 THRR72	1825762	211	MCVR 1,5/ 9-STF-3.81	1828414	193	MCVV 1,5/10-STF-3.5	1863084	193
MCV 1,5/ 9-GF-3.5	1843295	227	MCV 1,5/12-G-3.81 P26 THR	1707528	217	MCVR 1,5/ 10-ST-3.5	1863233	192	MCVV 1,5/10-STF-3.81	1828579	193
MCV 1,5/ 9-GF-3.5 P14 THR	1780079	215	MCV 1,5/12-G-3.81 P26 THRR72	1712982	213	MCVR 1,5/ 10-ST-3.81	1827208	192	MCVV 1,5/11-ST-3.5	1862946	193
MCV 1,5/ 9-GF-3.5 P14 THRR56	1780082	209	MCV 1,5/12-G-5.08	1836396	249	MCVR 1,5/ 10-ST-3.81 AU	1893216	692	MCVV 1,5/11-ST-3.81	1827062	193
MCV 1,5/ 9-GF-3.5 P20 THRR56	1780084	211	MCV 1,5/12-GF-3.5	1843321	227	MCVR 1,5/10-ST-3.81 KMGY AU	1936186	692	MCVV 1,5/11-STF-3.5	1863097	193
MCV 1,5/ 9-GF-3.5 P26 THR	1779200	217	MCV 1,5/12-GF-3.5 P14 THR	1780176	215	MCVR 1,5/10-STF-3.5	1863385	193	MCVV 1,5/11-STF-3.81	1828582	193
MCV 1,5/ 9-GF-3.5 P26 THRR56	1779213	213	MCV 1,5/12-GF-3.5 P14 THRR72	1780189	209	MCVR 1,5/10-STF-3.81	1828427	193	MCVV 1,5/12-ST-3.5	1862959	193
MCV 1,5/ 9-GF-3.5-LR	1818067	227	MCV 1,5/12-GF-3.5 P20 THRR72	1780862	211	MCVR 1,5/11-ST-3.5	1863246	192	MCVV 1,5/12-ST-3.81	1827075	193
MCV 1,5/ 9-GF-3.81	1830664	227	MCV 1,5/12-GF-3.5 P26 THR	1780150	217	MCVR 1,5/11-ST-3.81	1827211	192	MCVV 1,5/12-STF-3.5	1863107	193
MCV 1,5/ 9-GF-3.81 P14 THR	1707285	215	MCV 1,5/12-GF-3.5 P26 THRR72	1780163	213	MCVR 1,5/11-STF-3.5	1863398	193	MCVV 1,5/12-STF-3.81	1828595	193
MCV 1,5/ 9-GF-3.81 P20 THRR72	1825843	211	MCV 1,5/12-GF-3.5-LR	1818096	227	MCVR 1,5/11-STF-3.81	1828430	193	MCVV 1,5/13-ST-3.5	1862962	193
MCV 1,5/ 9-GF-3.81 P26 THR	1707706	217	MCV 1,5/12-GF-3.81	1830693	227	MCVR 1,5/12-ST-3.5	1863259	192	MCVV 1,5/13-ST-3.81	1827088	193
MCV 1,5/ 9-GF-3.81 P26 THRR72	1713415	213	MCV 1,5/12-GF-3.81 P14 THR	1707311	215	MCVR 1,5/12-ST-3.81	1827224	192	MCVV 1,5/13-STF-3.5	1863110	193
MCV 1,5/ 9-GF-3.81-LR	1818258	227	MCV 1,5/12-GF-3.81 P20 THRR72	1825872	211	MCVR 1,5/12-STF-3.5	1863408	193	MCVV 1,5/13-STF-3.81	1828605	193
MCV 1,5/ 9-GF-5.08	1847686	249	MCV 1,5/12-GF-3.81 P26 THR	1707735	217	MCVR 1,5/12-STF-3.81	1828443	193	MCVV 1,5/14-ST-3.5	1862975	193
MCV 1,5/10-G-3.5	1843680	226	MCV 1,5/12-GF-3.81 P26 THRR72	1713444	213	MCVR 1,5/13-ST-3.5	1863262	192	MCVV 1,5/14-ST-3.81	1827091	193
MCV 1,5/10-G-3.5 P14 THR	1780354	215	MCV 1,5/12-GF-3.81-LR	1818287	227	MCVR 1,5/13-ST-3.81	1827237	192	MCVV 1,5/14-STF-3.5	1863123	193
MCV 1,5/10-G-3.5 P14 THRR56	1780367	209	MCV 1,5/12-GF-5.08	1847712	249	MCVR 1,5/13-STF-3.5	1863411	193	MCVV 1,5/14-STF-3.81	1828618	193
MCV 1,5/10-G-3.5 P20 THRR56	1781049	211	MCV 1,5/13-G-3.5	1843716	226	MCVR 1,5/13-STF-3.81	1828456	193	MCVV 1,5/15-ST-3.5	1862988	193
MCV 1,5/10-G-3.5 P26 THR	1779527	217	MCV 1,5/13-G-3.5-RN	1731594	227	MCVR 1,5/14-ST-3.5	1863275	192	MCVV 1,5/15-ST-3.81	1827101	193
MCV 1,5/10-G-3.5 P26 THRR56	1779530	213	MCV 1,5/13-G-3.81	1803536	226	MCVR 1,5/14-ST-3.81	1827240	192	MCVV 1,5/15-STF-3.5	1863136	193
MCV 1,5/10-G-3.5-RN	1731565	227	MCV 1,5/13-GF-3.5	1843334	227	MCVR 1,5/14-STF-3.5	1863424	193	MCVV 1,5/15-STF-3.81	1828621	193
MCV 1,5/10-G-3.81	1803507	226	MCV 1,5/13-GF-3.5-LR	1818106	227	MCVR 1,5/14-STF-3.81	1828469	193	MCVV 1,5/16-ST-3.5	1862991	193
MCV 1,5/10-G-3.81 P14 THR	1707081	215	MCV 1,5/13-GF-3.81	1830703	227	MCVR 1,5/15-ST-3.5	1863288	192	MCVV 1,5/16-ST-3.81	1827114	193
MCV 1,5/10-G-3.81 P14 THRR56	1754539	209	MCV 1,5/13-GF-3.81-LR	1818290	227	MCVR 1,5/15-ST-3.81	1827253	192	MCVV 1,5/16-STF-3.5	1863149	193
MCV 1,5/10-G-3.81 P20 THRR56	1825746	211	MCV 1,5/14-G-3.5	1843729	226	MCVR 1,5/15-STF-3.5	1863437	193	MCVV 1,5/16-STF-3.81	1828634	193
MCV 1,5/10-G-3.81 P26 THR	1707502	217	MCV 1,5/14-G-3.5-RN	1731604	227	MCVR 1,5/15-STF-3.81	1828472	193	MDSTB 2,5/ 2-G	1762046	326
MCV 1,5/10-G-3.81 P26 THRR56	1712966	213	MCV 1,5/14-G-3.81	1803549	226	MCVR 1,5/16-ST-3.5	1863291	192	MDSTB 2,5/ 2-G-5.08	1762062	326
MCV 1,5/10-G-5.08	1836370	249	MCV 1,5/14-GF-3.5	1843347	227	MCVR 1,5/16-ST-3.81	1827266	192	MDSTB 2,5/ 2-GF	1846690	327
MCV 1,5/10-GF-3.5	1843305	227	MCV 1,5/14-GF-3.5-LR	1818119	227	MCVR 1,5/16-STF-3.5	1863440	193	MDSTB 2,5/ 2-GF-5.08	1842364	327
MCV 1,5/10-GF-3.5 P14 THR	1780095	215	MCV 1,5/14-GF-3.81	1830716	227	MCVR 1,5/16-STF-3.81	1828485	193	MDSTB 2,5/ 3-G	1762059	326
MCV 1,5/10-GF-3.5 P14 THRR72	1780105	209	MCV 1,5/14-GF-3.81-LR	1818300	227	MCVU 1,5/ 2-GFD-3.81	1833027	241	MDSTB 2,5/ 3-G-5.08	1762075	326
MCV 1,5/10-GF-3.5 P20 THRR72	1780280	211	MCV 1,5/15-G-3.5	1843732	226	MCVU 1,5/ 3-GFD-3.81	1833030	241	MDSTB 2,5/ 3-G1	1736687	329
MCV 1,5/10-GF-3.5 P26 THR	1779226	217	MCV 1,5/15-G-3.5-RN	1731617	227	MCVU 1,5/ 4-GFD-3.81	1833043	241	MDSTB 2,5/ 4-G1-5.08	1762376	329
MCV 1,5/10-GF-3.5 P26 THRR72	1779239	213	MCV 1,5/15-G-3.81	1803552	226	MCVU 1,5/ 5-GFD-3.81	1833056	241	MDSTB 2,5/ 3-GF	1846700	327
MCV 1,5/10-GF-3.5-LR	1818070	227	MCV 1,5/15-GF-3.5	1843350	227	MCVU 1,5/ 6-GFD-3.81	1833069	241	MDSTB 2,5/ 3-GF-5.08	1842377	327
MCV 1,5/10-GF-3.81	1830677	227	MCV 1,5/15-GF-3.5-LR	1818122	227	MCVU 1,5/ 7-GFD-3.81	1833072	241	MDSTB 2,5/ 4-G	1846386	326
MCV 1,5/10-GF-3.81 P14 THR	1707298	215									

Index

Alphabetical

Type	Order No.	Page	Type	Order No.	Page	Type	Order No.	Page	Type	Order No.	Page
MDSTB 2,5/6-GF-5,08	1842403	327	MDSTBV 2,5/4-G1-5,08	1736755	329	MDSTBW 2,5/2-G-5,08	1802430	329	ME 22,5 UT GN	2907130	659
MDSTB 2,5/7-G	1846412	326	MDSTBV 2,5/4-GF	1846108	331	MDSTBW 2,5/3-G	1802427	329	ME 22,5 UT TBUS KMGY	2869524	667
MDSTB 2,5/7-G-5,08	1842568	326	MDSTBV 2,5/4-GF-5,08	1845659	331	MDSTBW 2,5/3-G-5,08	1802414	329	ME 22,5 UT/FE BUS/5 GN	2908744	663
MDSTB 2,5/7-G1	1762745	329	MDSTBV 2,5/5-G	1845963	330	MDSTBW 2,5/4-G	1846836	329	ME 22,5 UT/FE BUS/5+2 GN	2854209	663
MDSTB 2,5/7-G1-5,08	1762428	329	MDSTBV 2,5/5-G-5,08	1762004	330	MDSTBW 2,5/4-G-5,08	1842238	329	ME 22,5 UT/FE BUS/10 GN	2908755	663
MDSTB 2,5/7-GF	1846742	327	MDSTBV 2,5/5-GF	1846111	331	MDSTBW 2,5/5-G	1846649	329	ME 22,5 UT/FE BUS/10+2 GN	2854212	663
MDSTB 2,5/7-GF-5,08	1842416	327	MDSTBV 2,5/5-GF-5,08	1845662	331	MDSTBW 2,5/5-G-5,08	1840010	329	ME 22,5 UT/FE GN	2907114	659
MDSTB 2,5/8-G	1846425	326	MDSTBV 2,5/6-G	1845976	330	MDSTBW 2,5/6-G	1846852	329	ME 22,5 UTG GN	2907127	659
MDSTB 2,5/8-G-5,08	1840052	326	MDSTBV 2,5/6-G-5,08	1845523	330	MDSTBW 2,5/6-G-5,08	1842254	329	ME 22,5 UTG TBUS KMGY	2914806	667
MDSTB 2,5/8-G1	1846758	329	MDSTBV 2,5/6-G1	1762884	329	MDSTBW 2,5/7-G	1846865	329	ME 22,5 UTG/FE GN	2907101	659
MDSTB 2,5/8-G1-5,08	1762431	329	MDSTBV 2,5/6-G1-5,08	1762541	329	MDSTBW 2,5/7-G-5,08	1842267	329	ME 35 UT/FE GN	2907211	660
MDSTB 2,5/8-GF	1846755	327	MDSTBV 2,5/6-GF	1846124	331	MDSTBW 2,5/8-G	1846678	329	ME 35 UTG GN	2907208	660
MDSTB 2,5/8-GF-5,08	1842429	327	MDSTBV 2,5/6-GF-5,08	1845675	331	MDSTBW 2,5/8-G-5,08	1842270	329	ME 35 UTG/FE GN	2907224	660
MDSTB 2,5/9-G	1846438	326	MDSTBV 2,5/7-G	1845989	330	MDSTBW 2,5/9-G	1846881	329	ME 35 OT-MSTBO GN	2909639	671
MDSTB 2,5/9-G-5,08	1842584	326	MDSTBV 2,5/7-G-5,08	1845536	330	MDSTBW 2,5/9-G-5,08	1842283	329	ME 35 OT-MSTBO KMGY	2914864	671
MDSTB 2,5/9-G1	1762761	329	MDSTBV 2,5/7-G1	1762897	329	MDSTBW 2,5/10-G	1846894	329	ME 35 OT-MSTBO SET	2707738	671
MDSTB 2,5/9-G1-5,08	1762444	329	MDSTBV 2,5/7-G1-5,08	1762554	329	MDSTBW 2,5/10-G-5,08	1842296	329	ME 35 UT BUS/5 GN	2853637	663
MDSTB 2,5/9-GF	1846768	327	MDSTBV 2,5/7-GF	1846137	331	MDSTBW 2,5/11-G	1846904	329	ME 35 UT BUS/10 GN	2907640	663
MDSTB 2,5/9-GF-5,08	1842432	327	MDSTBV 2,5/7-GF-5,08	1845688	331	MDSTBW 2,5/11-G-5,08	1842306	329	ME 35 UT GN	2907198	660
MDSTB 2,5/10-G	1846441	326	MDSTBV 2,5/8-G	1845992	330	MDSTBW 2,5/12-G	1846917	329	ME 35 UT TBUS KMGY	2914819	667
MDSTB 2,5/10-G-5,08	1842597	327	MDSTBV 2,5/8-G-5,08	1845549	330	MDSTBW 2,5/12-G-5,08	1842319	329	ME 35 UT/FE BUS/5+2 GN	2735551	663
MDSTB 2,5/10-G1	1762774	329	MDSTBV 2,5/8-G1	1762907	329	ME 12,5 OT-MKDSO SET	2907457	670	ME 35 UT BUS/10+2 GN	2853640	663
MDSTB 2,5/10-G1-5,08	1762457	329	MDSTBV 2,5/8-G1-5,08	1762567	329	ME 12,5 OT-MSTBO GN	2906814	670	ME 35 UT/FE BUS/5 GN	2706771	663
MDSTB 2,5/10-GF	1846771	327	MDSTBV 2,5/8-GF	1846140	331	ME 12,5 OT-MSTBO SET	2907428	670	ME 35 UTG TBUS KMGY	2914822	667
MDSTB 2,5/10-GF-5,08	1842445	327	MDSTBV 2,5/8-GF-5,08	1845691	331	ME 12,5 OTU-MKDSO GN	2278856	670	ME 35 UTM	2908265	675
MDSTB 2,5/11-G	1846454	326	MDSTBV 2,5/9-G	1846001	330	ME 12,5 UT GN	2906759	658	ME 35 UTMG	2908275	675
MDSTB 2,5/11-G-5,08	1842607	326	MDSTBV 2,5/9-G-5,08	1845552	330	ME 12,5 UT/FE GN	2906791	658	ME 45 OT-1MSTBO GN	2709192	671
MDSTB 2,5/11-G1	1762787	329	MDSTBV 2,5/9-G1	1762910	329	ME 12,5 UTG GN	2906762	658	ME 45 OT-1MSTBO KMGY	2709299	671
MDSTB 2,5/11-G1-5,08	1762460	329	MDSTBV 2,5/9-G1-5,08	1762570	329	ME 12,5 UTG/FE GN	2906801	658	ME 45 OT-1MSTBO SET	2707754	671
MDSTB 2,5/11-GF	1846784	327	MDSTBV 2,5/9-GF	1846153	331	ME 17,5 OT-FKDSO KMGY	2200322	670	ME 45 OT-FKDSO KMGY	2200327	671
MDSTB 2,5/11-GF-5,08	1842458	327	MDSTBV 2,5/9-GF-5,08	1845701	331	ME 17,5 OT-MKDSO SET	2907460	670	ME 45 OT-MKDSO SET	2909345	671
MDSTB 2,5/12-G	1846467	326	MDSTBV 2,5/10-G	1846014	330	ME 17,5 OT-MSTBO GN	2906827	670	ME 45 OT-MSTBO GN	2909743	671
MDSTB 2,5/12-G-5,08	1842610	326	MDSTBV 2,5/10-G-5,08	1845565	330	ME 17,5 OT-MSTBO KMGY	2853747	670	ME 45 OT-MSTBO KMGY	2854429	671
MDSTB 2,5/12-G1	1762790	329	MDSTBV 2,5/10-G1	1762923	329	ME 17,5 OT-MSTBO SET	2907431	670	ME 45 OT-MSTBO SET	2909905	671
MDSTB 2,5/12-G1-5,08	1762703	329	MDSTBV 2,5/10-G1-5,08	1762583	329	ME 17,5 OT-MSTBO PS KMGY	2279253	670	ME 45 OTU-MKDSO GN	2279826	671
MDSTB 2,5/12-GF	1846797	327	MDSTBV 2,5/10-GF	1846166	331	ME 17,5 OTU-MKDSO GN	2278872	670	ME 45 OTU-MKDSO KMGY	2279923	671
MDSTB 2,5/12-GF-5,08	1842461	327	MDSTBV 2,5/10-GF-5,08	1845714	331	ME 17,5 OTU-MKDSO KMGY	2278940	670	ME 45 UT BUS/10 GN	2853682	664
MDSTB 2,5/13-G1	1762800	329	MDSTBV 2,5/11-G	1846027	330	ME 17,5 PLATE-MSTBO KMGY	2279266	670	ME 45 UT BUS/5 GN	2853679	664
MDSTB 2,5/13-G1-5,08	1762473	329	MDSTBV 2,5/11-G-5,08	1845578	330	ME 17,5 TBUS 1,5/5-ST-3,81 KMGY	2713645	666	ME 45 UT GN	2909361	660
MDSTB 2,5/14-G1	1762813	329	MDSTBV 2,5/11-G1	1762936	329	ME 17,5 UT GN	2906775	658	ME 45 UT TBUS KMGY	2869511	668
MDSTB 2,5/14-G1-5,08	1762486	329	MDSTBV 2,5/11-G1-5,08	1762596	329	ME 17,5 UT TBUS KMGY	2914783	666	ME 45 UT/FE BUS/5 GN	2709765	664
MDSTB 2,5/15-G1	1762826	329	MDSTBV 2,5/11-GF	1846179	331	ME 17,5 UT/FE BUS/5 GN	2908728	662	ME 45 UT/FE BUS/5+2 GN	2735577	664
MDSTB 2,5/15-G1-5,08	1762499	329	MDSTBV 2,5/11-GF-5,08	1845727	331	ME 17,5 UT/FE BUS/5+2 GN	2854186	662	ME 45 UT/FE BUS/10+2 GN	2735580	664
MDSTB 2,5/16-G1	1762839	329	MDSTBV 2,5/12-G	1846030	330	ME 17,5 UT/FE BUS/10 GN	2908731	662	ME 45 UT/FE GN	2909358	660
MDSTB 2,5/16-G1-5,08	1762509	329	MDSTBV 2,5/12-G-5,08	1845581	330	ME 17,5 UT/FE BUS/10+2 GN	2854199	662	ME 45 UTG GN	2909374	660
MDSTBA 2,5/2-G	1846519	327	MDSTBV 2,5/12-G1	1762949	329	ME 17,5 UT/FE GN	2906924	658	ME 45 UTG TBUS KMGY	2914848	668
MDSTBA 2,5/2-G-5,08	1842063	327	MDSTBV 2,5/12-G1-5,08	1762606	329	ME 17,5 UTG GN	2906788	658	ME 45 UTG/FE GN	2909387	660
MDSTBA 2,5/3-G	1846522	327	MDSTBV 2,5/12-GF	1846182	331	ME 17,5 UTG TBUS KMGY	2914796	666	ME 45 UTM GN	2853404	675
MDSTBA 2,5/3-G-5,08	1842076	327	MDSTBV 2,5/12-GF-5,08	1845730	331	ME 17,5 UTG/FE GN	2906937	658	ME 45 UTMG GN	2853417	675
MDSTBA 2,5/4-G	1846535	327	MDSTBV 2,5/13-G1	1762952	329	ME 22,5 F-UT BUS/5 GN	2735975	663	ME 6,2 TBUS-2 1,5/5-ST-3,81KMGY	2969401	683
MDSTBA 2,5/4-G-5,08	1842089	327	MDSTBV 2,5/13-G1-5,08	1762619	329	ME 22,5 F-UT BUS/5+2 GN	2706014	663	ME 67,5 OT-1MSTBO KMGY	2200522	672
MDSTBA 2,5/5-G	1846548	327	MDSTBV 2,5/14-G1	1762965	329	ME 22,5 F-UT BUS/10 GN	2735991	663	ME 67,5 UT TBUS KMGY	2200544	669
MDSTBA 2,5/5-G-5,08	1842092	327	MDSTBV 2,5/14-G1-5,08	1762622	329	ME 22,5 F-UT BUS/10+2 GN	2706030	663	ME 67,5 UT/FE BUS/10 KMGY	2200539	665
MDSTBA 2,5/6-G	1846551	327	MDSTBV 2,5/15-G1	1762978	329	ME 22,5 F-UT GN	2854131	659	ME 67,5 UT/FE BUS/10+2 KMGY	2200541	665
MDSTBA 2,5/6-G-5,08	1842102	327	MDSTBV 2,5/15-G1-5,08	1762635	329	ME 22,5 F-UT TBUS KMGY	2914835	667	ME 67,5 UT/FE BUS/5+2 KMGY	2200537	665
MDSTBA 2,5/7-G	1846564	327	MDSTBV 2,5/16-G1	1762981	329	ME 22,5 F-UT/FE GN	2854160	659	ME 67,5 UT/FE KMGY	2200535	661
MDSTBA 2,5/7-G-5,08	1842115	327	MDSTBV 2,5/16-G1-5,08	1762648	329	ME 22,5 F-UTG BUS/5 GN	2735988	663	ME 90 OT-1MSTBO KMGY	2200523	672
MDSTBA 2,5/8-G	1846577	327	MDSTBVA 2,5/2-G	1845785	331	ME 22,5 F-UTG BUS/5+2 GN	2706027	663	ME 90 UT TBUS KMGY	2200545	669
MDSTBA 2,5/8-G-5,08	1842128	327	MDSTBVA 2,5/2-G-5,08	1845332	331	ME 22,5 F-UTG BUS/10 GN	2736000	663	ME 90 UT/FE BUS/10 KMGY	2200540	665
MDSTBA 2,5/9-G	1846580	327	MDSTBVA 2,5/3-G	1845798	331	ME 22,5 F-UTG BUS/10+2 GN	2706043	663	ME 90 UT/FE BUS/10+2 KMGY	2200543	665
MDSTBA 2,5/9-G-5,08	1842131	327	MDSTBVA 2,5/3-G-5,08	1845345	331	ME 22,5 F-UTG GN	2854144	659	ME 90 UT/FE BUS/5+2 KMGY	2200538	665
MDSTBA 2,5/10-G	1846593	327	MDSTBVA 2,5/4-G	1845808	331	ME 22,5 F-UTG TBUS KMGY	2914851	667	ME 90 UT/FE KMGY	2200536	661
MDSTBA 2,5/10-G-5,08	1842144	327	MDSTBVA 2,5/4-G-5,08	1845358	331	ME 22,5 F-UTG/FE GN	2854157	659	ME B-12,5 3MSTBO GN	2709176	675
MDSTBA 2,5/11-G	1846603	327	MDSTBVA 2,5/5-G	1845811	331	ME 22,5 OT-1MSTBO GN	2709558	671	ME B-12,5 3MSTBO KMGY	2279787	675
MDSTBA 2,5/11-G-5,08	1842157	327	MDSTBVA 2,5/5-G-5,08	1845361	331	ME 22,5 OT-1MSTBO KMGY	2914877	671	ME B-12,5 FKDSO KMGY	2200565	674
MDSTBA 2,5/12-G	1846616	327	MDSTBVA 2,5/6-G	1845824	331	ME 22,5 OT-1MSTBO SET	2707741	671	ME B-12,5 MKDSO GN	2906872	674
MDSTBA 2,5/12-G-5,08	1842160	327	MDSTBVA 2,5/6-G-5,08	1845374	331	ME 22,5 OT-3MSTBO GN	2735962	671	ME B-12,5 MSTBO GN	2906856	674
MDSTBV 2,5/2-G	1763032	330	MDSTBVA 2,5/7-G	1845837	331	ME 22,5 OT-3MSTBO KMGY	2914880	671	ME B-12,5 MSTBO KMGY	2854801	674
MDSTBV 2,5/2-G-5,08	1763074	330	MDSTBVA 2,5/7-G-5,08	1845387	331	ME 22,5 OT-3MSTBO SET	2707767	671	ME B-17,5 FKDSO KMGY	2200566	675
MDSTBV 2,5/2-GF	1846085	331	MDSTBVA 2,5/8-G	1845840	331	ME 22,5 OT-FKDSO GN	2200323	671	ME B-17,5 MKDSO GN	2906885	675
MDSTBV 2,5/2-GF-5,08	1845633	331	MDSTBVA 2,5/8-G-5,08	1845390	331	ME 22,5 OT-MKDSO SET	2907473	671	ME B-17,5 MKDSO KMGY	2854115	675
MDSTBV 2,5/3-G	1763045	330	MDSTBVA 2,5/9-G	1845853							

Type	Order No.	Page	Type	Order No.	Page	Type	Order No.	Page	Type	Order No.	Page
ME B-SA/NS 35	2935959	692	ME PS-17,5 MC TRANS	2279842	675	MKDS 1,5/10-5,08	1715802	95	MKDS 5 HV/ 3-9,52-Z	1907429	445
ME B-SA/NS 35 KMGY	2706700	692	ME PS-22,5 FKCT TRANS	2279046	675	MKDS 1,5/12	1715129	95	MKDS 5/ 2-6,35	1714955	443
ME BUS FE CONTACT	2278076	685	ME PS-22,5 FMC TRANS	2279648	675	MKDS 1,5/12-5,08	1715828	95	MKDS 5/ 2-7,62	1868076	443
ME DH 27 NS 35 KMGY	2706289	692	ME PS-22,5 MC TRANS	2279745	675	MKDS 1/ 2-3,5	1751248	85	MKDS 5/ 2-9,5	1714971	443
ME DH 36 NS 35 KMGY	2706292	692	ME PS-22,5 MSTBT TRANS	2279062	675	MKDS 1/ 2-3,5 HT BK	1985807	75	MKDS 5/ 3-6,35	1714968	443
ME DH27 NS 35	2908760	692	ME PS-22,5 TVFKC TRANS	2279075	675	MKDS 1/ 2-3,81	1727010	85	MKDS 5/ 3-7,62	1704936	443
ME DH36 NS 35	2909895	692	ME PS-22,5 TVFKCL TRANS	2279088	675	MKDS 1/ 2-3,81 HT BK	1985823	75	MKDS 5/ 3-9,5	1714984	443
ME LP	2906908	658	ME TBUS PST 1,5/ 5-3,81	2279033	684	MKDS 1/ 2-3,81 SMD BK	1727230	82	MKDS 5N HV/ 2-ZB-6,35	1777545	445
ME MAX 12,5 3-3 TBUS KMGY	2279200	684	ME TBUS PST 1,5/ 5-3,81 THRR32	2914369	684	MKDS 1/ 3-3,5	1751251	85	MKDS 5N HV/ 3-ZB-6,35	1777558	445
ME MAX 12,5 3-3 TBUS KMGY	2279017	684	ME-SAS	2853899	674	MKDS 1/ 3-3,5 HT BK	1984950	75	MKDS 5N HV/ 4-ZB-6,35	1777561	445
ME MAX 17,5 2-2 KMGY	2713599	685	MICROFOX-E	1212494	823	MKDS 1/ 3-3,81	1727023	85	MKDS 5N HV/ 5-ZB-6,35	1777574	445
ME MAX 17,5 3-3 KMGY	2713612	685	MICROFOX-E ESD	1212485	825	MKDS 1/ 3-3,81 HT BK	1985836	75	MKDS 5N HV/ 6-ZB-6,35	1777587	445
ME MAX 17,5 G 2-2 KMGY	2713609	685	MICROFOX-EO	1212495	823	MKDS 1/ 3-3,81 SMD BK	1727243	82	MKDS 5N HV/ 7-ZB-6,35	1777590	445
ME MAX 17,5 G 3-3 KMGY	2713531	685	MICROFOX-F	1212493	823	MKDS 1/ 4-3,5	1751264	85	MKDS 5N HV/ 8-ZB-6,35	1777600	445
ME MAX 17,5 G U-U1 KMGY	2713515	685	MICROFOX-F ESD	1212484	825	MKDS 1/ 4-3,81	1727036	85	MKDS 5N HV/ 9-ZB-6,35	1777613	445
ME MAX 17,5 SF G 2-2 KMGY	2901369	685	MICROFOX-P	1212491	823	MKDS 1/ 4-3,81 SMD BK	1727256	82	MKDS 5N HV/ 10-ZB-6,35	1777626	445
ME MAX 17,5 U-U1 KMGY	2713641	685	MICROFOX-PC	1212482	825	MKDS 1/ 5-3,5	1751277	85	MKDS 5N HV/ 11-ZB-6,35	1777639	445
ME MAX 22,5 2-2 KMGY	2713625	686	MICROFOX-PC	1212492	823	MKDS 1/ 5-3,81	1727049	85	MKDS 5N HV/ 12-ZB-6,35	1777642	445
ME MAX 22,5 3-3 KMGY	2713939	686	MICROFOX-PC ESD	1212483	825	MKDS 1/ 5-3,81 SMD BK	1727269	82	MKDSF 3/ 2	1712025	107
ME MAX 22,5 F G 3-3 KMGY	2869388	686	MICROFOX-R	1212490	823	MKDS 1/ 6-3,5	1751280	85	MKDSF 3/ 2-5,08	1712724	107
ME MAX 22,5 G 2-2 KMGY	2713638	686	MICROFOX-R ESD	1212481	825	MKDS 1/ 6-3,81	1727052	85	MKDSF 3/ 3	1712038	107
ME MAX 22,5 G 2-2 KMGY	2713670	686	MICROFOX-S	1212480	824	MKDS 1/ 6-3,81 SMD BK	1727272	82	MKDSF 3/ 3-5,08	1712737	107
ME MAX 22,5 G U-U1 KMGY	2713489	686	MICROFOX-SB	1212489	822	MKDS 1/ 7-3,5	1751293	85	MKDSF 3/ 4	1712041	107
ME MAX 22,5 SF G 2-2 KMGY	2869362	686	MICROFOX-SP	1212488	822	MKDS 1/ 7-3,81	1727065	85	MKDSF 3/ 8	1712083	107
ME MAX 22,5 U-U1 KMGY	2713476	686	MICROFOX-SP-1	1212487	822	MKDS 1/ 7-3,81 SMD BK	1727285	82	MKDSF 3/ 12	1712122	107
ME MAX 35 2-2 KMGY	2713670	687	MK3DS 1,5/ 2-5,08	1724013	99	MKDS 1/ 8-3,5	1751303	85	MKDSFV 1,5/ 2	1717091	97
ME MAX 35 3-3 KMGY	2713696	687	MK3DS 1,5/ 2-5,08-A-GNYE	1868717	99	MKDS 1/ 8-3,81	1727078	85	MKDSFV 1,5/ 2-3,5	1868128	87
ME MAX 35 G 2-2 KMGY	2713683	687	MK3DS 1,5/ 2-5,08-BC	1706413	99	MKDS 1/ 8-3,81 SMD BK	1727175	82	MKDSFV 1,5/ 3	1717088	97
ME MAX 35 G 3-3 KMGY	2713544	687	MK3DS 1,5/ 3-5,08	1724026	99	MKDS 1/ 9-3,5	1751316	85	MKDSFV 1,5/ 3-3,5	1868131	87
ME MAX 35 G U-U1 KMGY	2713528	687	MK3DS 1,5/ 3-5,08-A-GNYE	1868720	99	MKDS 1/ 9-3,81	1727081	85	MKDSFV 1,5/ 4-3,5	1868144	87
ME MAX 35 LC 2-2 KMGY	2200597	687	MK3DS 1,5/ 3-5,08-BC	1706426	99	MKDS 1/ 9-3,81 SMD BK	1727298	82	MKDSFV 1,5/ 5-3,5	1868157	87
ME MAX 35 LC 3-3 KMGY	2200596	687	MK3DS 1/ 2-3,81	1727735	87	MKDS 1/ 10-3,5	1751329	85	MKDSFV 1,5/ 6-3,5	1868160	87
ME MAX 35 U-U1 KMGY	2713667	687	MK3DS 1/ 3-3,81	1727748	87	MKDS 1/ 10-3,81	1727094	85	MKDSFV 1,5/ 7-3,5	1868173	87
ME MAX 45 2-2 KMGY	2713706	688	MK3DS 1/ 4-3,81	1727751	87	MKDS 1/ 10-3,81 SMD BK	1727308	82	MKDSFV 1,5/ 8-3,5	1868186	87
ME MAX 45 3-3 KMGY	2713913	688	MK3DS 1/ 5-3,81	1727764	87	MKDS 1/ 11-3,5	1751332	85	MKDSFV 1,5/ 9-3,5	1868199	87
ME MAX 45 F G 3-3 KMGY	2869391	688	MK3DS 1/ 6-3,81	1727777	87	MKDS 1/ 11-3,81	1727104	85	MKDSFV 1,5/ 10-3,5	1868209	87
ME MAX 45 G 2-2 KMGY	2713719	688	MK3DS 1/ 7-3,81	1727780	87	MKDS 1/ 11-3,81 SMD BK	1727311	82	MKDSFV 1,5/ 11-3,5	1868212	87
ME MAX 45 G 3-3 KMGY	2713926	688	MK3DS 1/ 8-3,81	1727793	87	MKDS 1/ 12-3,5	1751345	85	MKDSFV 1,5/ 12-3,5	1868225	87
ME MAX 45 G U-U1 KMGY	2713502	688	MK3DS 1/ 9-3,81	1727803	87	MKDS 1/ 12-3,81	1727117	85	MKDSFV 3/ 2	1771529	107
ME MAX 45 LC 2-2 KMGY	2200071	688	MK3DS 1/ 10-3,81	1727816	87	MKDS 1/ 12-3,81 SMD BK	1727324	82	MKDSFV 3/ 3	1771260	107
ME MAX 45 LC 3-3 KMGY	2890179	688	MK3DS 1/ 11-3,81	1727829	87	MKDS 1/ 13-3,5	1751358	85	MKDSN 1,5/ 2	1729018	91
ME MAX 45 SF G 2-2 KMGY	2869375	688	MK3DS 1/ 12-3,81	1727832	87	MKDS 1/ 14-3,5	1751361	85	MKDSN 1,5/ 2 HT BK	1985849	75
ME MAX 45 U-U1 KMGY	2713492	688	MK3DS 3/ 2-5,08	1723014	111	MKDS 1/ 15-3,5	1751374	85	MKDSN 1,5/ 2-5,08	1729128	91
ME MAX 6,2 SC 4-4 KMGY	2713094	682	MK3DS 3/ 3-5,08	1723027	111	MKDS 1/ 16-3,5	1751387	85	MKDSN 1,5/ 2-5,08 HT BK	1985865	75
ME MAX 6,2 SC-TBUS 4-4 KMGY	2869634	683	MK3DSH 3/ 2-5,08	1723182	111	MKDS 10 HV/ 1-B-10,16	1993776	453	MKDSN 1,5/ 3	1729021	91
ME MAX 6,2 SF 4-4 KMGY	2713104	683	MK3DSH 3/ 2-5,08-EX	1869774	157	MKDS 10 HV/ 1-F-10,16	1993763	453	MKDSN 1,5/ 3 HT BK	1985852	75
ME MAX 6,2 SP-TBUS 4-4 KMGY	2869647	683	MK3DSH 3/ 3-5,08	1723195	111	MKDS 10 HV/ 2-ZB-10,16	1709681	453	MKDSN 1,5/ 3-5,08	1729131	91
ME MAX 67,5 2-2 KMGY	2200524	689	MK3DSH 3/ 3-5,08-EX	1869787	157	MKDS 10 HV/ 3-ZB-10,16	1709694	453	MKDSN 1,5/ 3-5,08 HT BK	1985878	75
ME MAX 67,5 3-3 KMGY	2200526	689	MK3DSMH 3/ 2-5,08	1723205	111	MKDS 10 HV/ 4-ZB-10,16	1709704	453	MKDSN 1,5/ 4	1729034	91
ME MAX 67,5 G 2-2 KMGY	2200525	689	MK3DSMH 3/ 2-5,08-EX	1870255	157	MKDS 10 HV/ 5-ZB-10,16	1709717	453	MKDSN 1,5/ 4-5,08	1729144	91
ME MAX 67,5 G 3-3 KMGY	2200527	689	MK3DSMH 3/ 3-5,08	1723218	111	MKDS 10 HV/ 6-ZB-10,16	1709720	453	MKDSN 1,5/ 5	1729047	91
ME MAX 67,5 G U-U1 KMGY	2200528	689	MK3DSMH 3/ 3-5,08-EX	1870268	157	MKDS 10 HV/ 7-ZB-10,16	1709733	453	MKDSN 1,5/ 5-5,08	1729157	91
ME MAX 67,5 U-U1 KMGY	2200547	689	MK3DSN 1,5/ 2-5,08	1723289	93	MKDS 10 HV/ 8-ZB-10,16	1709746	453	MKDSN 1,5/ 6	1729050	91
ME MAX 90 2-2 KMGY	2200529	690	MK3DSN 1,5/ 3-5,08	1723292	93	MKDS 10 HV/ 9-ZB-10,16	1709759	453	MKDSN 1,5/ 6-5,08	1729160	91
ME MAX 90 3-3 KMGY	2200531	690	MK4DS 1,5/ 2-5,08	1868827	101	MKDS 10 HV/ 10-ZB-10,16	1709762	453	MKDSN 1,5/ 7	1729063	91
ME MAX 90 G 2-2 KMGY	2200530	690	MK4DS 1,5/ 2-5,08-A GNYE	1707001	101	MKDS 10 HV/ 11-ZB-10,16	1709775	453	MKDSN 1,5/ 7-5,08	1729173	91
ME MAX 90 G 3-3 KMGY	2200532	690	MK4DS 1,5/ 2-5,08-BCD	1706947	101	MKDS 10 HV/ 12-ZB-10,16	1709788	453	MKDSN 1,5/ 8	1729076	91
ME MAX 90 G U-U1 KMGY	2200533	690	MK4DS 1,5/ 3-5,08	1868830	101	MKDS 3/ 2	1711026	105	MKDSN 1,5/ 8-5,08	1729186	91
ME MAX 90 U-U1 KMGY	2200546	690	MK4DS 1,5/ 3-5,08-A GNYE	1707140	101	MKDS 3/ 2 HT BK	1985962	77	MKDSN 1,5/ 9	1729089	91
ME MAX B-12,5 KMGY	2914660	684	MK4DS 1,5/ 3-5,08-BCD	1706950	101	MKDS 3/ 2-5,08	1711225	105	MKDSN 1,5/ 9-5,08	1729199	91
ME MAX B-17,5 KMGY	2706959	685	MKDS 1,5/ 2	1715022	95	MKDS 3/ 2-5,08 HT BK	1985988	77	MKDSN 1,5/ 10	1729092	91
ME MAX B-22,5 KMGY	2707929	686	MKDS 1,5/ 2-5,08 HT BK	1985881	75	MKDS 3/ 2-B-5,08	1707904	105	MKDSN 1,5/ 10-5,08	1729209	91
ME MAX LP SAMPLE MSTBO 2-2	2713777	685	MKDS 1,5/ 2-5,08	1715721	95	MKDS 3/ 2-B-5,08 BK	1706455	105	MKDSN 1,5/ 11	1729102	91
ME MAX TBUS BS KMGY	2199650	685	MKDS 1,5/ 2-5,08 HT BK	1985904	75	MKDS 3/ 2-B-5,08 BU	1706439	105	MKDSN 1,5/ 11-5,08	1729212	91
ME MF 17,5	2908281	675	MKDS 1,5/ 2-B-5,08	1868733	97	MKDS 3/ 2-B-5,08 GNYE	1706471	105	MKDSN 1,5/ 12	1729115	91
ME PLC 40 B BUS 10/10 GY7035	2201499	733	MKDS 1,5/ 2-B-5,08 BK	1868759	97	MKDS 3/ 2-EMG 10	1712342	708	MKDSN 1,5/ 12-5,08	1729225	91
ME PLC 40 B BUS 50/40 GY7035	2201500	733	MKDS 1,5/ 2-B-5,08 BU	1868775	97	MKDS 3/ 3	1711039	105	MKDSN 2,5/ 2	1890963	103
ME PLC 40 BUS 10/10 KIT BK	2201503	733	MKDS 1,5/ 2-B-5,08 GNYE	1706358	97	MKDS 3/ 3 HT BK	1985975	77	MKDSN 2,5/ 2 HT BK	1985920	77
ME PLC 40 BUS 50/40 KIT BK	2201502	733	MKDS 1,5/ 3	1715035	95	MKDS 3/ 3-5,08	1711738	105	MKDSN 2,5/ 2-5,08	1888687	103
ME PLC 40 CL GY7035	2201505	733	MKDS 1,5/ 3 HT BK	1985894	75	MKDS 3/ 3-5,08 HT BK	1985991	77	MKDSN 2,5/ 2-5,08 HT BK	1985946	77
ME PLC 40 CS GY7035	2201490	733	MKDS 1,5/ 3-5,08	1715734	95	MKDS 3/ 3-B-5,08	1707917	105	MKDSN 2,5/ 3	1890976	103
ME PLC 40 CS TRANS	2201491	733	MKDS 1,5/ 3-5,08 HT BK	1985917	75	MKDS 3/ 3-B-5,08 BK	1706468	105	MKDSN 2,5/ 3 HT BK	1985933	77

Index

Alphabetical

Type	Order No.	Page	Type	Order No.	Page	Type	Order No.	Page	Type	Order No.	Page
MKDSO 1,5/5-L-3,5 KMGY	2278393	89	MKKDS 1,5/3-5,08	1725041	97	MSTB 2,5 HC/2-GF	1923979	497	MSTB 2,5/3-GF	1776702	314
MKDSO 1,5/5-R-3,5 KMGY	2278416	89	MKKDS 1/2-3,5	1751390	85	MSTB 2,5 HC/2-GF-5,08	1924088	497	MSTB 2,5/3-GF-5,08	1776511	314
MKDSO 2,5 HV/2L-7,5 KMGY	2199676	125	MKKDS 1/2-3,81	1708026	85	MSTB 2,5 HC/2-ST	1911855	490	MSTB 2,5/3-GF-5,08 EX	1795679	374
MKDSO 2,5 HV/2R-7,5 KMGY	2199773	125	MKKDS 1/3-3,5	1751400	85	MSTB 2,5 HC/2-ST-5,08	1911965	490	MSTB 2,5/3-ST	1754465	262
MKDSO 2,5 HV/3L-7,5 KMGY	2890946	125	MKKDS 1/3-3,81	1708039	85	MSTB 2,5 HC/2-STF	1912074	491	MSTB 2,5/3-ST-5,08	1757022	262
MKDSO 2,5 HV/3R-7,5 KMGY	2890959	125	MKKDS 1/4-3,5	1751413	85	MSTB 2,5 HC/2-STF-5,08	1912184	491	MSTB 2,5/3-ST-5,08-LR	1808899	263
MKDSO 2,5/2-L	1707205	113	MKKDS 1/4-3,81	1708042	85	MSTB 2,5 HC/3-GF	1923982	497	MSTB 2,5/3-STF	1786844	263
MKDSO 2,5/2-L KMGY	2915261	113	MKKDS 1/5-3,5	1751426	85	MSTB 2,5 HC/3-GF-5,08	1924091	497	MSTB 2,5/3-STF-5,08	1777992	263
MKDSO 2,5/2-R	1707195	113	MKKDS 1/5-3,81	1708055	85	MSTB 2,5 HC/3-ST	1911868	490	MSTB 2,5/3-STF-5,08 EX	1795569	369
MKDSO 2,5/2-R KMGY	2915258	113	MKKDS 1/6-3,5	1751439	85	MSTB 2,5 HC/3-STF-5,08	1911978	490	MSTB 2,5/3-STZ-5,08	1776168	263
MKDSO 2,5/3-6 SET KMGY	2713735	685	MKKDS 1/6-3,81	1708068	85	MSTB 2,5 HC/3-STF	1912087	491	MSTB 2,5/4-G	1754478	312
MKDSO 2,5/3-L	1707221	113	MKKDS 1/7-3,5	1751442	85	MSTB 2,5 HC/3-STF-5,08	1912197	491	MSTB 2,5/4-G-5,08	1759033	312
MKDSO 2,5/3-L KMGY	2854102	113	MKKDS 1/7-3,81	1708071	85	MSTB 2,5 HC/4-GF	1923995	497	MSTB 2,5/4-GF	1776715	314
MKDSO 2,5/3-R	1707218	113	MKKDS 1/8-3,5	1751455	85	MSTB 2,5 HC/4-GF-5,08	1924101	497	MSTB 2,5/4-GF-5,08	1776524	314
MKDSO 2,5/3-R KMGY	2854092	113	MKKDS 1/8-3,81	1708084	85	MSTB 2,5 HC/4-ST	1911871	490	MSTB 2,5/4-GF-5,08 EX	1795682	374
MKDSO 2,5/4-L	1707234	113	MKKDS 1/9-3,5	1751468	85	MSTB 2,5 HC/4-ST-5,08	1911981	490	MSTB 2,5/4-ST	1754481	262
MKDSO 2,5/4-L KMGY	2908485	113	MKKDS 1/9-3,81	1708107	85	MSTB 2,5 HC/4-STF	1912090	491	MSTB 2,5/4-ST-5,08	1757035	262
MKDSO 2,5/4-R	1707247	113	MKKDS 1/10-3,5	1751471	85	MSTB 2,5 HC/4-STF-5,08	1912207	491	MSTB 2,5/4-ST-5,08-LR	1808909	263
MKDSO 2,5/4-R KMGY	2908472	113	MKKDS 1/10-3,81	1708110	85	MSTB 2,5 HC/5-GF	1924004	497	MSTB 2,5/4-STF	1786857	263
MKDSO 2,5/4-6 SET KMGY	2713751	686	MKKDS 1/11-3,5	1751484	85	MSTB 2,5 HC/5-GF-5,08	1924114	497	MSTB 2,5/4-STF-5,08	1778001	263
MKDSP 1,5/2	1730010	95	MKKDS 1/11-3,81	1708123	85	MSTB 2,5 HC/5-ST	1911884	490	MSTB 2,5/4-STF-5,08 EX	1795572	369
MKDSP 1,5/2-5,08	1730120	95	MKKDS 1/12-3,5	1751497	85	MSTB 2,5 HC/5-STF-5,08	1911994	490	MSTB 2,5/4-STZ	1739114	263
MKDSP 1,5/3	1730023	95	MKKDS 1/12-3,81	1708136	85	MSTB 2,5 HC/5-STF	1912100	491	MSTB 2,5/4-STZ-5,08	1776155	263
MKDSP 1,5/3-5,08	1730133	95	MKKDS 1/13-3,5	1751507	85	MSTB 2,5 HC/5-STF-5,08	1912210	491	MSTB 2,5/5-G	1754494	312
MKDSP 1,5/4	1730036	95	MKKDS 1/14-3,5	1751510	85	MSTB 2,5 HC/6-GF	1924017	497	MSTB 2,5/5-G-5,08	1759046	312
MKDSP 1,5/4-5,08	1730146	95	MKKDS 1/15-3,5	1751523	85	MSTB 2,5 HC/6-GF-5,08	1924127	497	MSTB 2,5/5-GF	1776728	314
MKDSP 1,5/5	1730049	95	MKKDS 1/16-3,5	1751536	85	MSTB 2,5 HC/6-ST	1911897	490	MSTB 2,5/5-GF-5,08	1776537	314
MKDSP 1,5/5-5,08	1730159	95	MKKDS 3/2	1721029	109	MSTB 2,5 HC/6-ST-5,08	1912003	490	MSTB 2,5/5-GF-5,08 EX	1795695	374
MKDSP 1,5/6	1730052	95	MKKDS 3/2-5,08	1721728	109	MSTB 2,5 HC/6-STF	1912113	491	MSTB 2,5/5-ST	1754504	262
MKDSP 1,5/6-5,08	1730162	95	MKKDS 3/3	1721032	109	MSTB 2,5 HC/6-STF-5,08	1912223	491	MSTB 2,5/5-ST-5,08	1757048	262
MKDSP 1,5/7	1730065	95	MKKDS 3/3-5,08	1721731	109	MSTB 2,5 HC/7-GF	1924020	497	MSTB 2,5/5-ST-5,08-LR	1808912	263
MKDSP 1,5/7-5,08	1730175	95	MKKDS 5/2-6,35	1719031	449	MSTB 2,5 HC/7-GF-5,08	1924130	497	MSTB 2,5/5-STF	1786860	263
MKDSP 1,5/8	1730078	95	MKKDS 5/2-9,5	1719015	449	MSTB 2,5 HC/7-ST	1911907	490	MSTB 2,5/5-STF-5,08	1778014	263
MKDSP 1,5/8-5,08	1730188	95	MKKDS 5/3-6,35	1719044	449	MSTB 2,5 HC/7-ST-5,08	1912016	490	MSTB 2,5/5-STF-5,08 EX	1795585	263
MKDSP 1,5/9	1730081	95	MKKDS 5/3-9,5	1719028	449	MSTB 2,5 HC/7-STF	1912126	491	MSTB 2,5/5-STZ-5,08	1776142	263
MKDSP 1,5/9-5,08	1730191	95	MKKDSG 3/2	1721090	109	MSTB 2,5 HC/7-STF-5,08	1912236	491	MSTB 2,5/6-G	1754517	312
MKDSP 1,5/10	1730094	95	MKKDSG 3/3	1721087	109	MSTB 2,5 HC/8-GF	1924033	497	MSTB 2,5/6-G-5,08	1759059	312
MKDSP 1,5/10-5,08	1730201	95	MKKDSH 3/2	1721045	109	MSTB 2,5 HC/8-GF-5,08	1924143	497	MSTB 2,5/6-GF	1776731	314
MKDSP 1,5/11	1730104	95	MKKDSH 3/2-EX	1869790	157	MSTB 2,5 HC/8-ST	1911910	490	MSTB 2,5/6-GF-5,08	1776540	314
MKDSP 1,5/11-5,08	1730214	95	MKKDSH 3/3	1721346	109	MSTB 2,5 HC/8-ST-5,08	1912029	490	MSTB 2,5/6-GF-5,08 EX	1795705	374
MKDSP 1,5/12	1730117	95	MKKDSH 3/3-EX	1869800	157	MSTB 2,5 HC/8-STF	1912139	491	MSTB 2,5/6-ST	1754520	262
MKDSP 1,5/12-5,08	1730227	95	MKKDSH 3/8	1703283	719	MSTB 2,5 HC/8-STF-5,08	1912249	491	MSTB 2,5/6-ST-5,08	1757051	262
MKDSP 10HV/2-10,16	1929517	451	MKKDSN 1,5/2	1726037	93	MSTB 2,5 HC/9-GF	1924046	497	MSTB 2,5/6-ST-5,08-LR	1808925	263
MKDSP 10HV/2-12,7	1929533	451	MKKDSN 1,5/2-5,08	1726040	93	MSTB 2,5 HC/9-GF-5,08	1924156	497	MSTB 2,5/6-STF	1786873	263
MKDSP 10HV/3-10,16	1929520	451	MKKDSN 1,5/3	1726053	93	MSTB 2,5 HC/9-ST	1911923	490	MSTB 2,5/6-STF-5,08	1778027	263
MKDSP 10HV/3-12,7	1929546	451	MKKDSN 1,5/3-5,08	1726066	93	MSTB 2,5 HC/9-ST-5,08	1912032	490	MSTB 2,5/6-STF-5,08 EX	1795598	263
MKDSP 10N/2-10,16	1773976	451	MKKDSN 1,5/4	1726118	93	MSTB 2,5 HC/9-STF	1912142	491	MSTB 2,5/6-STZ-5,08	1776126	263
MKDSP 10N/3-10,16	1774137	451	MKKDSN 1,5/4-5,08	1726163	93	MSTB 2,5 HC/9-STF-5,08	1912252	491	MSTB 2,5/7-G	1754533	312
MKDSP 25/1-15,00-FL	1932575	455	MKKDSN 1,5/5	1726121	93	MSTB 2,5 HC/10-GF	1924059	497	MSTB 2,5/7-G-5,08	1759062	312
MKDSP 25/2-15,00	1932588	455	MKKDSN 1,5/5-5,08	1726176	93	MSTB 2,5 HC/10-GF-5,08	1924169	497	MSTB 2,5/7-GF	1776744	314
MKDSP 25/4-15,00-F	1932494	455	MKKDSN 1,5/6	1726134	93	MSTB 2,5 HC/10-ST	1911936	490	MSTB 2,5/7-GF-5,08	1776553	314
MKDSP 25/3-15,00	1932591	455	MKKDSN 1,5/6-5,08	1726189	93	MSTB 2,5 HC/10-ST-5,08	1912045	490	MSTB 2,5/7-GF-5,08 EX	1795718	374
MKDSP 25/3-15,00-F	1932504	455	MKKDSN 1,5/7	1726147	93	MSTB 2,5 HC/10-STF	1912155	491	MSTB 2,5/7-ST	1754546	262
MKDSP 25/4-15,00	1932601	455	MKKDSN 1,5/7-5,08	1726192	93	MSTB 2,5 HC/10-STF-5,08	1912265	491	MSTB 2,5/7-ST-5,08	1757064	262
MKDSP 25/4-15,00-F	1932517	455	MKKDSN 1,5/8	1726150	93	MSTB 2,5 HC/11-GF	1924062	497	MSTB 2,5/7-ST-5,08-LR	1808938	263
MKDSP 25/5-15,00	1932614	455	MKKDSN 1,5/8-5,08	1726202	93	MSTB 2,5 HC/11-GF-5,08	1924172	497	MSTB 2,5/7-STF	1786886	263
MKDSP 25/5-15,00-F	1932520	455	MKKDSNH 1,5/2-5,08	1731828	93	MSTB 2,5 HC/11-ST	1911949	490	MSTB 2,5/7-STF-5,08	1778030	263
MKDSP 25/6-15,00	1932627	455	MKKDSNH 1,5/3-5,08	1731831	93	MSTB 2,5 HC/11-ST-5,08	1912058	490	MSTB 2,5/7-STF-5,08 EX	1795608	369
MKDSP 25/6-15,00-F	1932533	455	MKKDSNH 1,5/4-5,08	1731857	93	MSTB 2,5 HC/11-STF	1912168	491	MSTB 2,5/7-STZ-5,08	1776113	263
MKDSP 25/7-15,00	1932630	455	MPS-IH BK	0201731	831	MSTB 2,5 HC/11-STF-5,08	1912278	491	MSTB 2,5/8-G	1754559	312
MKDSP 25/7-15,00-F	1932546	455	MPS-IH BU	0201689	831	MSTB 2,5 HC/12-GF	1924075	497	MSTB 2,5/8-G-5,08	1759075	312
MKDSP 25/8-15,00	1932643	455	MPS-IH GN	0201702	831	MSTB 2,5 HC/12-GF-5,08	1924185	497	MSTB 2,5/8-GF	1776757	314
MKDSP 25/8-15,00-F	1932559	455	MPS-IH GY	0201728	831	MSTB 2,5 HC/12-ST	1911952	490	MSTB 2,5/8-GF-5,08	1776566	314
MKDSP 25/9-15,00	1932656	455	MPS-IH RD	0201676	831	MSTB 2,5 HC/12-ST-5,08	1912061	490	MSTB 2,5/8-GF-5,08 EX	1795721	374
MKDSP 25/9-15,00-F	1932562	455	MPS-IH WH	0201663	831	MSTB 2,5 HC/12-STF	1912171	491	MSTB 2,5/8-ST	1754562	262
MKDSP 3/2	1714023	105	MPS-IH YE	0201692	831	MSTB 2,5 HC/12-STF-5,08	1912281	491	MSTB 2,5/8-ST-5,08	1757077	262
MKDSP 3/2-5,08	1714722	105	MPS-MT	0201744	831	MSTB 2,5/2-G	1754436	312	MSTB 2,5/8-ST-5,08-LR	1808941	263
MKDSP 3/3	1714036	105	MPS-MT 1-S	1944372	831	MSTB 2,5/2-G-5,08	1759017	312	MSTB 2,5/8-STF	1786899	263
MKDSP 3/3-5,08	1714735	105	MPS-MT 1-S4-B RD	1982800	831	MSTB 2,5/2-GF	1776692	314	MSTB 2,5/8-STF-5,08	1778043	263
MKDSV 5 HV/2-9,52	1904147	445	MPT 0,5/2-2,54	1725656	83	MSTB 2,5/2-GF-5,08	1776508	314	MSTB 2,5/8-STF-5,08 EX	1759088	312
MKDSV 5 HV/2-9,52-Z	1907416	445	MPT 0,5/3-2,54	1725669	83	MSTB 2,5/2-GF-5,08 EX	1795666	374	MSTB 2,5/8-STZ	1758982	263
MKDSV 5/2-6,35	1710056	443	MPT 0,5/4-2,54	1725672	83	MSTB 2,5/2-ST	1754449	262	MSTB 2,5/8-STZ-5,08	1764235	263
MKDSV 5/2-7,62	1907131	443	MPT 0,5/5-2,54	1725685	83	MSTB 2,5/2-ST-5,08	1757019	262	MSTB 2,5/9-G	1754575	

Type	Order No.	Page	Type	Order No.	Page	Type	Order No.	Page	Type	Order No.	Page
MSTB 2,5/9-STF	1786909	263	MSTB 2,5/16-GF-5,08	1776647	314	MSTBA 2,5/10-G	1757543	313	MSTBC 2,5/12-STZ-5,08-R	1809145	295
MSTB 2,5/9-STF-5,08	1778056	263	MSTB 2,5/16-ST	1754724	262	MSTBA 2,5/10-G-5,08	1757323	313	MSTBC 2,5/12-STZF-5,08	1809831	295
MSTB 2,5/9-STF-5,08 EX	1795624	369	MSTB 2,5/16-ST-5,08	1757158	262	MSTBA 2,5/10-G-5,08-LR	1809157	315	MSTBC 2,5/13-ST-5,08	1808926	294
MSTB 2,5/9-STZ	1758995	263	MSTB 2,5/16-ST-5,08-LR	1809021	263	MSTBA 2,5/10-G-5,08-RN	1926099	313	MSTBC 2,5/13-STZ-5,08	1809611	295
MSTB 2,5/9-STZ-5,08	1764316	263	MSTB 2,5/16-STF	1786970	263	MSTBA 2,5/10-G-5,08-RN EX	1796513	375	MSTBC 2,5/13-STZ-5,08-R	1809158	295
MSTB 2,5/10-G	1754591	312	MSTB 2,5/16-STF-5,08	1778124	263	MSTBA 2,5/10-G-RN	1944864	313	MSTBC 2,5/13-STZF-5,08	1809844	295
MSTB 2,5/10-G-5,08	1759091	312	MSTB 2,5/16-STZ	1759392	263	MSTBA 2,5/11-G	1757556	313	MSTBC 2,5/14-ST-5,08	1808939	294
MSTB 2,5/10-GF	1776773	314	MSTB 2,5/16-STZ-5,08	1764248	263	MSTBA 2,5/11-G-5,08	1757336	313	MSTBC 2,5/14-STZ-5,08	1809624	295
MSTB 2,5/10-GF-5,08	1776582	314	MSTB-BF	1759981	836	MSTBA 2,5/11-G-5,08-LR	1809160	315	MSTBC 2,5/14-STZ-5,08-R	1809161	295
MSTB 2,5/10-GF-5,08 EX	1795747	374	MSTB-BL	1755477	837	MSTBA 2,5/11-G-5,08-RN	1926109	313	MSTBC 2,5/14-STZF-5,08	1809857	295
MSTB 2,5/10-ST	1754601	262	MSTBA 2,5 HC/ 2-G	1923759	496	MSTBA 2,5/11-G-5,08-RN EX	1796526	375	MSTBC 2,5/14-ST-5,08	1808942	294
MSTB 2,5/10-ST-5,08	1757093	262	MSTBA 2,5 HC/ 2-G-5,08	1923869	496	MSTBA 2,5/11-G-RN	1944877	313	MSTBC 2,5/15-STZ-5,08	1809637	295
MSTB 2,5/10-ST-5,08-LR	1808967	263	MSTBA 2,5 HC/ 3-G	1923762	496	MSTBA 2,5/12-G	1757569	313	MSTBC 2,5/15-STZ-5,08-R	1809174	295
MSTB 2,5/10-STF	1786912	263	MSTBA 2,5 HC/ 3-G-5,08	1923872	496	MSTBA 2,5/12-G-5,08	1757349	313	MSTBC 2,5/15-STZF-5,08	1809860	295
MSTB 2,5/10-STF-5,08	1778069	263	MSTBA 2,5 HC/ 4-G	1923775	496	MSTBA 2,5/12-G-5,08-LR	1809173	315	MSTBC 2,5/16-ST-5,08	1808955	294
MSTB 2,5/10-STF-5,08 EX	1795637	369	MSTBA 2,5 HC/ 4-G-5,08	1923885	496	MSTBA 2,5/12-G-5,08-RN	1926112	313	MSTBC 2,5/16-STZ-5,08	1809640	295
MSTB 2,5/10-STZ	1759004	263	MSTBA 2,5 HC/ 5-G	1923788	496	MSTBA 2,5/12-G-5,08-RN EX	1796539	375	MSTBC 2,5/16-STZ-5,08-R	1809187	295
MSTB 2,5/10-STZ-5,08	1764303	263	MSTBA 2,5 HC/ 5-G-5,08	1923898	496	MSTBA 2,5/12-G-RN	1944880	313	MSTBC 2,5/16-STZF-5,08	1809873	295
MSTB 2,5/11-G	1754614	312	MSTBA 2,5 HC/ 6-G	1923791	496	MSTBA 2,5/13-G	1757572	313	MSTBC-MT 0,5-1,0	3190564	827
MSTB 2,5/11-G-5,08	1759101	312	MSTBA 2,5 HC/ 6-G-5,08	1923908	496	MSTBA 2,5/13-G-5,08	1757352	313	MSTBC-MT 0,5-1,0 BA	3190645	827
MSTB 2,5/11-GF	1776786	314	MSTBA 2,5 HC/ 7-G	1923801	496	MSTBA 2,5/13-G-5,08-LR	1809186	315	MSTBC-MT 1,5-2,5	3190551	827
MSTB 2,5/11-GF-5,08	1776595	314	MSTBA 2,5 HC/ 7-G-5,08	1923911	496	MSTBA 2,5/13-G-5,08-RN	1926125	313	MSTBC-MT 1,5-2,5 BA	3190658	827
MSTB 2,5/11-GF-5,08 EX	1795750	374	MSTBA 2,5 HC/ 8-G	1923814	496	MSTBA 2,5/13-G-RN	1944893	313	MSTBHK 2,5/10-G	1765085	358
MSTB 2,5/11-ST	1754627	262	MSTBA 2,5 HC/ 8-G-5,08	1923924	496	MSTBA 2,5/14-G	1757585	313	MSTBHK 2,5/10-G-5,08	1765030	358
MSTB 2,5/11-ST-5,08	1757103	262	MSTBA 2,5 HC/ 9-G	1923827	496	MSTBA 2,5/14-G-5,08	1757365	313	MSTBO 2,5/ 2-G-1L	1861057	322
MSTB 2,5/11-ST-5,08-LR	1808970	263	MSTBA 2,5 HC/ 9-G-5,08	1923937	496	MSTBA 2,5/14-G-5,08-LR	1809199	315	MSTBO 2,5/ 2-G-1L KMGY	2854788	323
MSTB 2,5/11-STF	1786925	263	MSTBA 2,5 HC/ 10-G	1923830	496	MSTBA 2,5/14-G-5,08-RN	1926138	313	MSTBO 2,5/ 2-G-1L THRR32 BK	2200251	328
MSTB 2,5/11-STF-5,08	1778072	263	MSTBA 2,5 HC/ 10-G-5,08	1923940	496	MSTBA 2,5/14-G-RN	1944903	313	MSTBO 2,5/ 2-G-1L GY7035	2200330	305
MSTB 2,5/11-STF-5,08 EX	1795640	369	MSTBA 2,5 HC/ 11-G	1923843	496	MSTBA 2,5/15-G	1757598	313	MSTBO 2,5/ 2-G-1PR GY7035	2200331	325
MSTB 2,5/11-STZ	1759347	263	MSTBA 2,5 HC/ 11-G-5,08	1923953	496	MSTBA 2,5/15-G-5,08	1757378	313	MSTBO 2,5/ 2-G-1R	1861044	323
MSTB 2,5/11-STZ-5,08	1764293	263	MSTBA 2,5 HC/ 12-G	1923856	496	MSTBA 2,5/15-G-5,08-LR	1809209	315	MSTBO 2,5/ 2-G-1R KMGY	2854791	323
MSTB 2,5/12-G	1754630	312	MSTBA 2,5 HC/ 12-G-5,08	1923966	496	MSTBA 2,5/15-G-5,08-RN	1926141	313	MSTBO 2,5/ 2-G-1R THRR32 BK	2200252	309
MSTB 2,5/12-G-5,08	1759114	312	MSTBA 2,5/ 2-G	1757475	313	MSTBA 2,5/15-G-RN	1944916	313	MSTBO 2,5/ 3 G1L THRR44 BK	2915216	308
MSTB 2,5/12-GF	1776799	314	MSTBA 2,5/ 2-G-5,08	1757242	313	MSTBA 2,5/16-G	1757608	313	MSTBO 2,5/ 3 G1R THRR44 BK	2915229	309
MSTB 2,5/12-GF-5,08	1776605	314	MSTBA 2,5/ 2-G-5,08-LR	1809076	315	MSTBA 2,5/16-G-5,08	1757381	313	MSTBO 2,5/ 3-6 ST SET KMGY	2713748	685
MSTB 2,5/12-GF-5,08 EX	1795763	374	MSTBA 2,5/ 2-G-5,08-RN	1926015	313	MSTBA 2,5/16-G-5,08-LR	1809212	315	MSTBO 2,5/ 3-6 ST	1861028	322
MSTB 2,5/12-ST	1754643	262	MSTBA 2,5/ 2-G-5,08-RN EX	1796432	375	MSTBA 2,5/16-G-5,08-RN	1926154	313	MSTBO 2,5/ 3-G1L KMGY	2853570	323
MSTB 2,5/12-ST-5,08	1757116	262	MSTBA 2,5/ 2-G-RN	1944783	313	MSTBA 2,5/16-G-RN	1944929	313	MSTBO 2,5/ 3-G1PL GY7035	2200328	325
MSTB 2,5/12-ST-5,08-LR	1808983	263	MSTBA 2,5/ 3-G	1757488	313	MSTBC 2,5/ 2-ST-5,08	1808816	294	MSTBO 2,5/ 3-G1PR GY7035	2200329	325
MSTB 2,5/12-STF	1786938	263	MSTBA 2,5/ 3-G-5,08	1757255	313	MSTBC 2,5/ 2-STZ-5,08	1809501	295	MSTBO 2,5/ 3-G1R	1861031	323
MSTB 2,5/12-STF-5,08	1778085	263	MSTBA 2,5/ 3-G-5,08-LR	1809089	315	MSTBC 2,5/ 2-STZ-5,08-R	1809048	295	MSTBO 2,5/ 3-G1R KMGY	2853763	323
MSTB 2,5/12-STF-5,08 EX	1795653	369	MSTBA 2,5/ 3-G-5,08-RN	1926028	313	MSTBC 2,5/ 2-STZF-5,08	1809734	295	MSTBO 2,5/ 3-GL-5,08	1850440	320
MSTB 2,5/12-STZ	1759350	263	MSTBA 2,5/ 3-G-5,08-RN EX	1796445	375	MSTBC 2,5/ 3-ST-5,08	1808829	294	MSTBO 2,5/ 3-GR-5,08	1847110	321
MSTB 2,5/12-STZ-5,08	1764280	263	MSTBA 2,5/ 3-G-RN	1944796	313	MSTBC 2,5/ 3-STZ-5,08	1809514	295	MSTBO 2,5/ 4-G-1L	1861060	322
MSTB 2,5/13-G	1754656	312	MSTBA 2,5/ 4-G	1757491	313	MSTBC 2,5/ 3-STZ-5,08-R	1809051	295	MSTBO 2,5/ 4-G1L KMGY	2907774	323
MSTB 2,5/13-G-5,08	1759127	312	MSTBA 2,5/ 4-G-5,08	1757268	313	MSTBC 2,5/ 3-STZF-5,08	1809747	295	MSTBO 2,5/ 4-G1L THRR44 BK	2697194	308
MSTB 2,5/13-GF	1776809	314	MSTBA 2,5/ 4-G-5,08-LR	1809092	315	MSTBC 2,5/ 4-ST-5,08	1808832	294	MSTBO 2,5/ 4-G1PL GY7035	2200325	325
MSTB 2,5/13-GF-5,08	1776618	314	MSTBA 2,5/ 4-G-5,08-RN	1926031	313	MSTBC 2,5/ 4-STZ-5,08	1809527	295	MSTBO 2,5/ 4-G1PR GY7035	2200326	325
MSTB 2,5/13-ST	1754669	262	MSTBA 2,5/ 4-G-5,08-RN EX	1796458	375	MSTBC 2,5/ 4-STZ-5,08-R	1809064	295	MSTBO 2,5/ 4-G1R	1861073	323
MSTB 2,5/13-ST-5,08	1757129	262	MSTBA 2,5/ 4-G-RN	1944806	313	MSTBC 2,5/ 4-STZF-5,08	1809750	295	MSTBO 2,5/ 4-G1R KMGY	2907787	323
MSTB 2,5/13-ST-5,08-LR	1808996	263	MSTBA 2,5/ 5-G	1757501	313	MSTBC 2,5/ 5-ST-5,08	1808845	294	MSTBO 2,5/ 4-G1R THRR44 BK	2697204	309
MSTB 2,5/13-STF	1786941	263	MSTBA 2,5/ 5-G-5,08	1757271	313	MSTBC 2,5/ 5-STZ-5,08	1809530	295	MSTBO 2,5/ 4-GL-5,08	1850453	320
MSTB 2,5/13-STF-5,08	1778098	263	MSTBA 2,5/ 5-G-5,08-LR	1809102	315	MSTBC 2,5/ 5-STZ-5,08-R	1809077	295	MSTBO 2,5/ 4-GR-5,08	1847123	321
MSTB 2,5/13-STZ	1759363	263	MSTBA 2,5/ 5-G-5,08-RN	1926044	313	MSTBC 2,5/ 5-STZF-5,08	1809763	295	MSTBO 2,5/ 5-GL-5,08	1850466	320
MSTB 2,5/13-STZ-5,08	1764277	263	MSTBA 2,5/ 5-G-5,08-RN EX	1796471	375	MSTBC 2,5/ 6-ST-5,08	1808858	294	MSTBO 2,5/ 5-GR-5,08	1847136	321
MSTB 2,5/14-G	1754672	312	MSTBA 2,5/ 5-G-RN	1944819	313	MSTBC 2,5/ 6-STZ-5,08	1809543	295	MSTBO 2,5/ 6-GL-5,08	1850479	320
MSTB 2,5/14-G-5,08	1759130	312	MSTBA 2,5/ 6-G	1757514	313	MSTBC 2,5/ 6-STZ-5,08-R	1809080	295	MSTBO 2,5/ 6-GR-5,08	1847149	321
MSTB 2,5/14-GF	1776812	314	MSTBA 2,5/ 6-G-5,08	1757284	313	MSTBC 2,5/ 6-STZF-5,08	1809776	295	MSTBO 2,5/ 7-GL-5,08	1850482	320
MSTB 2,5/14-GF-5,08	1776621	314	MSTBA 2,5/ 6-G-5,08-LR	1809115	315	MSTBC 2,5/ 7-ST-5,08	1808861	294	MSTBO 2,5/ 7-GR-5,08	1847152	321
MSTB 2,5/14-ST	1754685	262	MSTBA 2,5/ 6-G-5,08-RN	1926057	313	MSTBC 2,5/ 7-STZ-5,08	1809556	295	MSTBO 2,5/ 8-GL-5,08	1850495	320
MSTB 2,5/14-ST-5,08	1757132	262	MSTBA 2,5/ 6-G-5,08-RN EX	1796474	375	MSTBC 2,5/ 7-STZ-5,08-R	1809093	295	MSTBO 2,5/ 8-GR-5,08	1847165	321
MSTB 2,5/14-ST-5,08-LR	1809005	263	MSTBA 2,5/ 6-G-RN	1944822	313	MSTBC 2,5/ 7-STZF-5,08	1809789	295	MSTBO 2,5/ 8-GR-5,08 ST SET KMGY	2713764	686
MSTB 2,5/14-STF	1786954	263	MSTBA 2,5/ 7-G	1755493	313	MSTBC 2,5/ 8-ST-5,08	1808874	294	MSTBP 2,5/ 2-ST	1765771	264
MSTB 2,5/14-STF-5,08	1778108	263	MSTBA 2,5/ 7-G-5,08	1757297	313	MSTBC 2,5/ 8-STZ-5,08	1809569	295	MSTBP 2,5/ 2-ST-5,08	1769010	264
MSTB 2,5/14-STZ	1759376	263	MSTBA 2,5/ 7-G-5,08-LR	1809128	315	MSTBC 2,5/ 8-STZ-5,08-R	1809103	295	MSTBP 2,5/ 3-ST	1765784	264
MSTB 2,5/14-STZ-5,08	1764264	263	MSTBA 2,5/ 7-G-5,08-RN	1926060	313	MSTBC 2,5/ 8-STZF-5,08	1809792	295	MSTBP 2,5/ 3-ST-5,08	1769023	264
MSTB 2,5/15-G	1754698	312	MSTBA 2,5/ 7-G-5,08-RN EX	1796487	375	MSTBC 2,5/ 9-ST-5,08	1808887	294	MSTBP 2,5/ 4-ST	1765797	264
MSTB 2,5/15-G-5,08	1759143	312	MSTBA 2,5/ 7-G-RN	1944835	313	MSTBC 2,5/ 9-STZ-5,08	1809572	295	MSTBP 2,5/ 4-ST-5,08	1769036	264
MSTB 2,5/15-GF	1776825	314	MSTBA 2,5/ 8-G	1757527	313	MSTBC 2,5/ 9-STZ-5,08-R	18				

Index

Alphabetical

Type	Order No.	Page	Type	Order No.	Page	Type	Order No.	Page	Type	Order No.	Page
MSTBP 2,5/11-ST	1765865	264	MSTBT 2,5/15-STF	1919844	265	MSTBV 2,5/8-G-5,08	1758076	315	MSTBVA 2,5/3-G-5,08-LR	1809270	317
MSTBP 2,5/11-ST-5,08	1769104	264	MSTBT 2,5/15-STF-5,08	1805424	265	MSTBV 2,5/8-GEH-5,08	1808528	317	MSTBVA 2,5/3-G-5,08-RN	1936021	316
MSTBP 2,5/12-ST	1765878	264	MSTBT 2,5/16-ST	1779974	265	MSTBV 2,5/8-GF	1776948	317	MSTBVA 2,5/3-G-5,08-RN EX	1796568	375
MSTBP 2,5/12-ST-5,08	1769117	264	MSTBT 2,5/16-ST-5,08	1781124	265	MSTBV 2,5/8-GF-5,08	1777138	317	MSTBVA 2,5/3-G-RN	1944602	316
MSTBP 2,5/13-ST	1765881	264	MSTBT 2,5/16-STF	1919857	265	MSTBV 2,5/8-GF-5,08 EX	1796390	375	MSTBVA 2,5/4-G	1755532	315
MSTBP 2,5/13-ST-5,08	1769120	264	MSTBT 2,5/16-STF-5,08	1805437	265	MSTBV 2,5/9-G	1753576	315	MSTBVA 2,5/4-G-5,08	1755752	315
MSTBP 2,5/14-ST	1765894	264	MSTBU 2,5/2-STD-5,08	1824120	356	MSTBU 2,5/9-G-5,08	1758089	315	MSTBVA 2,5/4-G-5,08-LR	1809283	317
MSTBP 2,5/14-ST-5,08	1769133	264	MSTBU 2,5/3-STD-5,08	1824133	356	MSTBV 2,5/9-GEH-5,08	1808531	317	MSTBVA 2,5/4-G-5,08-RN	1936034	316
MSTBP 2,5/15-ST	1765904	264	MSTBU 2,5/4-STD-5,08	1824146	356	MSTBV 2,5/9-GF	1776951	317	MSTBVA 2,5/4-G-5,08-RN EX	1796571	375
MSTBP 2,5/15-ST-5,08	1769146	264	MSTBU 2,5/5-STD-5,08	1824159	356	MSTBV 2,5/9-GF-5,08	1777141	317	MSTBVA 2,5/4-G-RN	1944615	316
MSTBP 2,5/16-ST	1765917	264	MSTBU 2,5/6-STD-5,08	1824162	356	MSTBV 2,5/9-GF-5,08 EX	1796393	375	MSTBVA 2,5/5-G	1755545	315
MSTBP 2,5/16-ST-5,08	1769159	264	MSTBU 2,5/7-STD-5,08	1824175	356	MSTBV 2,5/10-G	1753592	315	MSTBVA 2,5/5-G-5,08	1755765	315
MSTBT 2,5 HC/ 2-ST	1926358	491	MSTBU 2,5/8-STD-5,08	1824188	356	MSTBV 2,5/10-G-5,08	1758092	315	MSTBVA 2,5/5-G-5,08-LR	1809296	317
MSTBT 2,5 HC/ 2-STP GY7035	2200334	325	MSTBU 2,5/9-STD-5,08	1824191	356	MSTBV 2,5/10-GEH-5,08	1808544	317	MSTBVA 2,5/5-G-5,08-RN	1936047	316
MSTBT 2,5 HC/ 3-ST	1926248	491	MSTBU 2,5/10-STD-5,08	1824201	356	MSTBV 2,5/10-GF	1776964	317	MSTBVA 2,5/5-G-5,08-RN EX	1796584	375
MSTBT 2,5 HC/ 3-STP GY7035	2200333	325	MSTBU 2,5/11-STD-5,08	1824214	356	MSTBV 2,5/10-GF-5,08	1777154	317	MSTBVA 2,5/5-G-RN	1944628	316
MSTBT 2,5 HC/ 4-ST	1926251	491	MSTBU 2,5/12-STD-5,08	1824227	356	MSTBV 2,5/10-GF-5,08 EX	1796403	375	MSTBVA 2,5/6-G	1755558	315
MSTBT 2,5 HC/ 4-STP GY7035	2200332	325	MSTBU 2,5/13-STD-5,08	1824230	356	MSTBV 2,5/11-G	1753615	315	MSTBVA 2,5/6-G-5,08	1755778	315
MSTBT 2,5 HC/ 5-ST	1926264	491	MSTBU 2,5/14-STD-5,08	1824243	356	MSTBV 2,5/11-G-5,08	1758102	315	MSTBVA 2,5/6-G-5,08-LR	1809306	317
MSTBT 2,5 HC/ 6-ST	1926277	491	MSTBU 2,5/15-STD-5,08	1824256	356	MSTBV 2,5/11-GEH-5,08	1808557	317	MSTBVA 2,5/6-G-5,08-RN	1936050	316
MSTBT 2,5 HC/ 7-ST	1926280	491	MSTBU 2,5/16-STD-5,08	1824269	356	MSTBV 2,5/11-GF	1776977	317	MSTBVA 2,5/6-G-5,08-RN EX	1796597	375
MSTBT 2,5 HC/ 8-ST	1926293	491	MSTBV 2,5 HC/ 2-GF	1924415	497	MSTBV 2,5/11-GF-5,08	1777167	317	MSTBVA 2,5/6-G-5,08-RN	1944631	316
MSTBT 2,5 HC/ 9-ST	1926303	491	MSTBV 2,5 HC/ 2-GF-5,08	1924525	497	MSTBV 2,5/11-GF-5,08 EX	1796416	375	MSTBVA 2,5/7-G	1755561	315
MSTBT 2,5 HC/ 10-ST	1926316	491	MSTBV 2,5 HC/ 3-GF	1924428	497	MSTBV 2,5/12-G	1753631	315	MSTBVA 2,5/7-G-5,08	1755781	315
MSTBT 2,5 HC/ 11-ST	1926329	491	MSTBV 2,5 HC/ 3-GF-5,08	1924538	497	MSTBV 2,5/12-G-5,08	1758115	315	MSTBVA 2,5/7-G-5,08-LR	1809319	317
MSTBT 2,5 HC/ 12-ST	1926332	491	MSTBV 2,5 HC/ 4-GF	1924431	497	MSTBV 2,5/12-GEH-5,08	1808560	317	MSTBVA 2,5/7-G-5,08-RN	1936063	316
MSTBT 2,5/ 2-ST	1779835	265	MSTBV 2,5 HC/ 4-GF-5,08	1924541	497	MSTBV 2,5/12-GF	1776980	317	MSTBVA 2,5/7-G-5,08-RN EX	1796607	375
MSTBT 2,5/ 2-ST-5,08	1779987	265	MSTBV 2,5 HC/ 5-GF	1924444	497	MSTBV 2,5/12-GF-5,08	1777170	317	MSTBVA 2,5/7-G-RN	1944644	316
MSTBT 2,5/ 2-STF	1919718	265	MSTBV 2,5 HC/ 5-GF-5,08	1924554	497	MSTBV 2,5/12-GF-5,08 EX	1796429	375	MSTBVA 2,5/8-G	1755574	315
MSTBT 2,5/ 2-STF-5,08	1805301	265	MSTBV 2,5 HC/ 6-GF	1924457	497	MSTBV 2,5/13-G	1753657	315	MSTBVA 2,5/8-G-5,08	1755794	315
MSTBT 2,5/ 3-ST	1779848	265	MSTBV 2,5 HC/ 6-GF-5,08	1924567	497	MSTBV 2,5/13-G-5,08	1758128	315	MSTBVA 2,5/8-G-5,08-LR	1809322	317
MSTBT 2,5/ 3-ST-5,08	1779990	265	MSTBV 2,5 HC/ 7-GF	1924460	497	MSTBV 2,5/13-GEH-5,08	1808573	317	MSTBVA 2,5/8-G-5,08-RN	1936076	316
MSTBT 2,5/ 3-STF	1919721	265	MSTBV 2,5 HC/ 7-GF-5,08	1924570	497	MSTBV 2,5/13-GF	1776993	317	MSTBVA 2,5/8-G-5,08-RN EX	1796610	375
MSTBT 2,5/ 3-STF-5,08	1805314	265	MSTBV 2,5 HC/ 8-GF	1924473	497	MSTBV 2,5/13-GF-5,08	1777183	317	MSTBVA 2,5/8-G-RN	1944657	316
MSTBT 2,5/ 4-ST	1779851	265	MSTBV 2,5 HC/ 8-GF-5,08	1924583	497	MSTBV 2,5/14-G	1753673	315	MSTBVA 2,5/9-G	1755587	315
MSTBT 2,5/ 4-ST-5,08	1780002	265	MSTBV 2,5 HC/ 9-GF	1924486	497	MSTBV 2,5/14-G-5,08	1758331	315	MSTBVA 2,5/9-G-5,08	1755804	315
MSTBT 2,5/ 4-STF	1919734	265	MSTBV 2,5 HC/ 9-GF-5,08	1924596	497	MSTBV 2,5/14-GEH-5,08	1808586	317	MSTBVA 2,5/9-G-5,08-LR	1809335	317
MSTBT 2,5/ 4-STF-5,08	1805327	265	MSTBV 2,5 HC/ 10-GF	1924499	497	MSTBV 2,5/14-GF	1777002	317	MSTBVA 2,5/9-G-5,08-RN	1936089	316
MSTBT 2,5/ 5-ST	1779864	265	MSTBV 2,5 HC/ 10-GF-5,08	1924606	497	MSTBV 2,5/14-GF-5,08	1777196	317	MSTBVA 2,5/9-G-5,08-RN EX	1796623	375
MSTBT 2,5/ 5-ST-5,08	1781014	265	MSTBV 2,5 HC/ 11-GF	1924509	497	MSTBV 2,5/15-G	1753699	315	MSTBVA 2,5/9-G-RN	1944660	316
MSTBT 2,5/ 5-STF	1919747	265	MSTBV 2,5 HC/ 11-GF-5,08	1924619	497	MSTBV 2,5/15-G-5,08	1758144	315	MSTBVA 2,5/10-G	1755503	315
MSTBT 2,5/ 5-STF-5,08	1805330	265	MSTBV 2,5 HC/ 12-GF	1924512	497	MSTBV 2,5/15-GEH-5,08	1808599	317	MSTBVA 2,5/10-G-5,08	1755817	315
MSTBT 2,5/ 6-ST	1779877	265	MSTBV 2,5 HC/ 12-GF-5,08	1924622	497	MSTBV 2,5/15-GF	1777015	317	MSTBVA 2,5/10-G-5,08-LR	1809348	317
MSTBT 2,5/ 6-ST-5,08	1781027	265	MSTBV 2,5/ 2-G	1753437	315	MSTBV 2,5/15-GF-5,08	1777206	317	MSTBVA 2,5/10-G-5,08-RN	1936092	316
MSTBT 2,5/ 6-STF	1919750	265	MSTBV 2,5/ 2-G-5,08	1758018	315	MSTBV 2,5/16-G	1753712	315	MSTBVA 2,5/10-G-5,08-RN EX	1796636	375
MSTBT 2,5/ 6-STF-5,08	1805343	265	MSTBV 2,5/ 2-GEH-5,08	1808463	317	MSTBV 2,5/16-G-5,08	1758157	315	MSTBVA 2,5/10-G-RN	1944673	316
MSTBT 2,5/ 7-ST	1779880	265	MSTBV 2,5/ 2-GF	1796883	317	MSTBV 2,5/16-GEH-5,08	1808609	317	MSTBVA 2,5/11-G	1755590	315
MSTBT 2,5/ 7-ST-5,08	1781030	265	MSTBV 2,5/ 2-GF-5,08	1777073	317	MSTBV 2,5/16-GF	1777028	317	MSTBVA 2,5/11-G-5,08	1755820	315
MSTBT 2,5/ 7-STF	1919763	265	MSTBV 2,5/ 2-GF-5,08 EX	1796322	375	MSTBV 2,5/16-G-5,08 EX	1777219	317	MSTBVA 2,5/11-G-5,08-LR	1809351	317
MSTBT 2,5/ 7-STF-5,08	1805356	265	MSTBV 2,5/ 3-G	1753453	315	MSTBV 2,5/17-G	1753738	719	MSTBVA 2,5/11-G-5,08-RN	1936102	316
MSTBT 2,5/ 8-ST	1779893	265	MSTBV 2,5/ 3-G-5,08	1758021	315	MSTBVA 2,5 HC/ 2-G	1924198	497	MSTBVA 2,5/11-G-5,08-RN EX	1796649	375
MSTBT 2,5/ 8-ST-5,08	1781043	265	MSTBV 2,5/ 3-GEH-5,08	1808476	317	MSTBVA 2,5 HC/ 2-G-5,08	1924305	497	MSTBVA 2,5/11-G-RN	1944686	316
MSTBT 2,5/ 8-STF	1919776	265	MSTBV 2,5/ 3-GF	1776896	317	MSTBVA 2,5 HC/ 3-G	1924208	497	MSTBVA 2,5/12-G	1755600	315
MSTBT 2,5/ 8-STF-5,08	1804661	265	MSTBV 2,5/ 3-GF-5,08	1777086	317	MSTBVA 2,5 HC/ 3-G-5,08	1924318	497	MSTBVA 2,5/12-G-5,08	1755833	315
MSTBT 2,5/ 9-ST	1779903	265	MSTBV 2,5/ 3-GF-5,08 EX	1796335	375	MSTBVA 2,5 HC/ 4-G	1924211	497	MSTBVA 2,5/12-G-5,08-LR	1809364	317
MSTBT 2,5/ 9-ST-5,08	1734207	265	MSTBV 2,5/ 4-G	1753479	315	MSTBVA 2,5 HC/ 4-G-5,08	1924321	497	MSTBVA 2,5/12-G-5,08-RN	1936115	316
MSTBT 2,5/ 9-STF	1919789	265	MSTBV 2,5/ 4-G-5,08	1758034	315	MSTBVA 2,5 HC/ 5-G	1924224	497	MSTBVA 2,5/12-G-5,08-RN EX	1796652	375
MSTBT 2,5/ 9-STF-5,08	1805369	265	MSTBV 2,5/ 4-GEH-5,08	1808489	317	MSTBVA 2,5 HC/ 5-G-5,08	1924334	497	MSTBVA 2,5/12-G-RN	1944699	316
MSTBT 2,5/ 10-ST	1779916	265	MSTBV 2,5/ 4-GF	1776906	317	MSTBVA 2,5 HC/ 6-G	1924237	497	MSTBVA 2,5/13-G	1755613	315
MSTBT 2,5/ 10-ST-5,08	1781069	265	MSTBV 2,5/ 4-GF-5,08	1777099	317	MSTBVA 2,5 HC/ 6-G-5,08	1924347	497	MSTBVA 2,5/13-G-5,08	1755846	315
MSTBT 2,5/ 10-STF	1919792	265	MSTBV 2,5/ 4-GF-5,08 EX	1796348	375	MSTBVA 2,5 HC/ 7-G	1924240	497	MSTBVA 2,5/13-G-5,08-LR	1809377	317
MSTBT 2,5/ 10-STF-5,08	1805372	265	MSTBV 2,5/ 5-G	1753495	315	MSTBVA 2,5 HC/ 7-G-5,08	1924350	497	MSTBVA 2,5/13-G-5,08-RN	1936128	316
MSTBT 2,5/ 11-ST	1779929	265	MSTBV 2,5/ 5-G-5,08	1758047	315	MSTBVA 2,5 HC/ 8-G	1924253	497	MSTBVA 2,5/13-G-RN	1944709	316
MSTBT 2,5/ 11-ST-5,08	1781072	265	MSTBV 2,5/ 5-GEH-5,08	1808492	317	MSTBVA 2,5 HC/ 8-G-5,08	1924363	497	MSTBVA 2,5/14-G	1755626	315
MSTBT 2,5/ 11-STF	1919802	265	MSTBV 2,5/ 5-GF	1776919	317	MSTBVA 2,5 HC/ 9-G	1924266	497	MSTBVA 2,5/14-G-5,08	1755859	315
MSTBT 2,5/ 11-STF-5,08	1805385	265	MSTBV 2,5/ 5-GF-5,08	1777109	317	MSTBVA 2,5 HC/ 9-G-5,08	1924376	497	MSTBVA 2,5/14-G-5,08-LR	1809380	317
MSTBT 2,5/ 12-ST	1779932	265	MSTBV 2,5/ 5-GF-5,08 EX	1796351	375	MSTBVA 2,5 HC/ 10-G	1924279	497	MSTBVA 2,5/14-G-5,08-RN	1936131	316
MSTBT 2,5/ 12-ST-5,08	1781085	265	MSTBV 2,5/ 6-G	1753518	315	MSTBVA 2,5 HC/ 10-G-5,08	1924389	497	MSTBVA 2,5/14-G-RN	1944712	316
MSTBT 2,5/ 12-STF	1919815	265	MSTBV 2,5/ 6-G-5,08	1758050	315	MSTBVA 2,5 HC/ 11-G	1924282	497	MSTBVA 2,5/15-G	1755639	315
MSTBT 2,5/ 12-STF-5,08	1805398</										

Type	Order No.	Page	Type	Order No.	Page	Type	Order No.	Page	Type	Order No.	Page
MSTBVK 2,5/3-G-5,08	1788732	360	MVSTBR 2,5 HC/ 7-STF	1912566	493	MVSTBR 2,5/13-STF-5,08	1835203	267	MVSTBW 2,5 HC/11-ST-5,08	1912935	493
MSTBVK 2,5/3-GF-5,08	1788965	361	MVSTBR 2,5 HC/ 7-STF-5,08	1912676	493	MVSTBR 2,5/14-ST	1792139	266	MVSTBW 2,5 HC/11-STF	1913044	493
MSTBVK 2,5/4-G-5,08	1788745	360	MVSTBR 2,5 HC/ 8-ST	1912359	492	MVSTBR 2,5/14-ST-5,08	1792362	266	MVSTBW 2,5 HC/11-STF-5,08	1913154	493
MSTBVK 2,5/4-GF-5,08	1788978	361	MVSTBR 2,5 HC/ 8-ST-5,08	1912469	492	MVSTBR 2,5/14-STF	1835591	267	MVSTBW 2,5 HC/12-ST	1912838	493
MSTBVK 2,5/5-G-5,08	1788758	360	MVSTBR 2,5 HC/ 8-STF	1912579	493	MVSTBR 2,5/14-STF-5,08	1835216	267	MVSTBW 2,5 HC/12-ST-5,08	1912948	493
MSTBVK 2,5/5-GF-5,08	1788981	361	MVSTBR 2,5 HC/ 8-STF-5,08	1912689	493	MVSTBR 2,5/15-ST	1792142	266	MVSTBW 2,5 HC/12-STF	1913057	493
MSTBVK 2,5/6-G-5,08	1788745	360	MVSTBR 2,5 HC/ 9-ST	1912362	492	MVSTBR 2,5/15-ST-5,08	1792375	266	MVSTBW 2,5 HC/12-STF-5,08	1913167	493
MSTBVK 2,5/6-GF-5,08	1788994	361	MVSTBR 2,5 HC/ 9-ST-5,08	1912472	492	MVSTBR 2,5/15-STF	1835601	267	MVSTBW 2,5/ 2-ST	1792524	267
MSTBVK 2,5/7-G-5,08	1788774	360	MVSTBR 2,5 HC/ 9-STF	1912582	493	MVSTBR 2,5/15-STF-5,08	1835229	267	MVSTBW 2,5/ 2-ST-5,08	1792757	267
MSTBVK 2,5/7-GF-5,08	1789003	361	MVSTBR 2,5 HC/ 9-STF-5,08	1912692	493	MVSTBR 2,5/16-ST	1792155	266	MVSTBW 2,5/ 2-STF	1835287	267
MSTBVK 2,5/8-G-5,08	1788787	360	MVSTBR 2,5 HC/10-ST	1912375	492	MVSTBR 2,5/16-ST-5,08	1792388	266	MVSTBW 2,5/ 2-STF-5,08	1834903	267
MSTBVK 2,5/8-GF-5,08	1803015	361	MVSTBR 2,5 HC/10-ST-5,08	1912485	492	MVSTBR 2,5/16-STF	1835614	267	MVSTBW 2,5/ 2-STF-5,08 EX	1809788	369
MSTBVK 2,5/9-G-5,08	1788790	360	MVSTBR 2,5 HC/10-STF	1912595	493	MVSTBR 2,5/16-STF-5,08	1835232	267	MVSTBW 2,5/ 3-ST	1792537	267
MSTBVK 2,5/9-GF-5,08	1803028	361	MVSTBR 2,5 HC/10-STF-5,08	1912702	493	MVSTBU 2,5/ 2-GB-5,08	1788538	357	MVSTBW 2,5/ 3-ST-5,08	1792760	267
MSTBVK 2,5/10-G-5,08	1788800	360	MVSTBR 2,5 HC/11-ST	1912388	492	MVSTBU 2,5/ 2-GFB-5,08	1788347	357	MVSTBW 2,5/ 3-STF	1835290	267
MSTBVK 2,5/10-GF-5,08	1803031	361	MVSTBR 2,5 HC/11-ST-5,08	1912498	492	MVSTBU 2,5/ 3-GB-5,08	1788541	357	MVSTBW 2,5/ 3-STF-5,08	1834916	267
MSTBVK 2,5/11-G-5,08	1788813	360	MVSTBR 2,5 HC/11-STF	1912605	493	MVSTBU 2,5/ 3-GFB-5,08	1788350	357	MVSTBW 2,5/ 3-STF-5,08 EX	1809791	369
MSTBVK 2,5/11-GF-5,08	1803044	361	MVSTBR 2,5 HC/11-STF-5,08	1912715	493	MVSTBU 2,5/ 4-GB-5,08	1788554	357	MVSTBW 2,5/ 4-ST	1792540	267
MSTBVK 2,5/12-G-5,08	1788826	360	MVSTBR 2,5 HC/12-ST	1912391	492	MVSTBU 2,5/ 4-GFB-5,08	1788363	357	MVSTBW 2,5/ 4-ST-5,08	1792773	267
MSTBVK 2,5/12-GF-5,08	1803057	361	MVSTBR 2,5 HC/12-ST-5,08	1912508	492	MVSTBU 2,5/ 5-GB-5,08	1788567	357	MVSTBW 2,5/ 4-STEH	1784299	718
MSTBVK 2,5/13-G-5,08	1788839	360	MVSTBR 2,5 HC/12-STF	1912618	493	MVSTBU 2,5/ 5-GFB-5,08	1788376	357	MVSTBW 2,5/ 4-STEH-5,08	1851850	718
MSTBVK 2,5/13-GF-5,08	1803060	361	MVSTBR 2,5 HC/12-STF-5,08	1912728	493	MVSTBU 2,5/ 6-GB-5,08	1788570	357	MVSTBW 2,5/ 4-STF	1835300	267
MSTBVK 2,5/14-G-5,08	1788842	360	MVSTBR 2,5/ 2-ST	1792016	266	MVSTBU 2,5/ 6-GFB-5,08	1788389	357	MVSTBW 2,5/ 4-STF-5,08	1834929	267
MSTBVK 2,5/14-GF-5,08	1803073	361	MVSTBR 2,5/ 2-ST-5,08	1792249	266	MVSTBU 2,5/ 7-GB-5,08	1788583	357	MVSTBW 2,5/ 4-STF-5,08 EX	1809801	369
MSTBVK 2,5/15-G-5,08	1788855	360	MVSTBR 2,5/ 2-STF	1835478	267	MVSTBU 2,5/ 7-GFB-5,08	1788392	357	MVSTBW 2,5/ 5-ST	1792553	267
MSTBVK 2,5/15-GF-5,08	1803086	361	MVSTBR 2,5/ 2-STF-5,08	1835096	267	MVSTBU 2,5/ 8-GB-5,08	1788596	357	MVSTBW 2,5/ 5-ST-5,08	1792786	267
MSTBVK 2,5/16-G-5,08	1788868	360	MVSTBR 2,5/ 2-STF-5,08 EX	1809678	369	MVSTBU 2,5/ 8-GFB-5,08	1788402	357	MVSTBW 2,5/ 5-STF	1835313	267
MSTBVK 2,5/16-GF-5,08	1803099	361	MVSTBR 2,5/ 3-ST	1792029	266	MVSTBU 2,5/ 9-GB-5,08	1788606	357	MVSTBW 2,5/ 5-STF-5,08	1834932	267
MSTBW 2,5/ 2-G	1736111	313	MVSTBR 2,5/ 3-ST-5,08	1792252	266	MVSTBU 2,5/ 9-GFB-5,08	1788415	357	MVSTBW 2,5/ 5-STF-5,08 EX	1809814	369
MSTBW 2,5/ 2-G-5,08	1735882	313	MVSTBR 2,5/ 3-STF	1835481	267	MVSTBU 2,5/10-GB-5,08	1788619	357	MVSTBW 2,5/ 6-ST	1792566	267
MSTBW 2,5/ 3-G	1736108	313	MVSTBR 2,5/ 3-STF-5,08	1835106	267	MVSTBU 2,5/10-GFB-5,08	1788428	357	MVSTBW 2,5/ 6-ST-5,08	1792799	267
MSTBW 2,5/ 3-G-5,08	1735879	313	MVSTBR 2,5/ 3-STF-5,08 EX	1809681	369	MVSTBU 2,5/11-GB-5,08	1788622	357	MVSTBW 2,5/ 6-STF	1835326	267
MSTBW 2,5/ 4-G	1736098	313	MVSTBR 2,5/ 4-ST	1792032	266	MVSTBU 2,5/11-GFB-5,08	1788431	357	MVSTBW 2,5/ 6-STF-5,08	1834945	267
MSTBW 2,5/ 4-G-5,08	1735866	313	MVSTBR 2,5/ 4-ST-5,08	1792265	266	MVSTBU 2,5/12-GB-5,08	1788635	357	MVSTBW 2,5/ 6-STF-5,08 EX	1809827	369
MSTBW 2,5/ 5-G	1736085	313	MVSTBR 2,5/ 4-STF	1835494	267	MVSTBU 2,5/12-GFB-5,08	1788444	357	MVSTBW 2,5/ 7-ST	1792579	267
MSTBW 2,5/ 5-G-5,08	1735853	313	MVSTBR 2,5/ 4-STF-5,08	1835119	267	MVSTBU 2,5/13-GB-5,08	1788648	357	MVSTBW 2,5/ 7-ST-5,08	1792809	267
MSTBW 2,5/ 6-G	1736072	313	MVSTBR 2,5/ 4-STF-5,08 EX	1809694	369	MVSTBU 2,5/13-GFB-5,08	1788457	357	MVSTBW 2,5/ 7-STF	1835339	267
MSTBW 2,5/ 6-G-5,08	1735840	313	MVSTBR 2,5/ 5-ST	1792045	266	MVSTBU 2,5/14-GB-5,08	1788651	357	MVSTBW 2,5/ 7-STF-5,08	1834958	267
MSTBW 2,5/ 7-G	1736069	313	MVSTBR 2,5/ 5-ST-5,08	1792278	266	MVSTBU 2,5/14-GFB-5,08	1788460	357	MVSTBW 2,5/ 7-STF-5,08 EX	1809830	369
MSTBW 2,5/ 7-G-5,08	1735837	313	MVSTBR 2,5/ 5-STF	1835504	267	MVSTBU 2,5/15-GB-5,08	1788664	357	MVSTBW 2,5/ 8-ST	1792582	267
MSTBW 2,5/ 8-G	1736056	313	MVSTBR 2,5/ 5-STF-5,08	1835122	267	MVSTBU 2,5/15-GFB-5,08	1788473	357	MVSTBW 2,5/ 8-ST-5,08	1792812	267
MSTBW 2,5/ 8-G-5,08	1735824	313	MVSTBR 2,5/ 5-STF-5,08 EX	1809704	369	MVSTBU 2,5/16-GB-5,08	1788677	357	MVSTBW 2,5/ 8-STEH	1784309	719
MSTBW 2,5/ 9-G	1736043	313	MVSTBR 2,5/ 6-ST	1792058	266	MVSTBU 2,5/16-GFB-5,08	1788486	357	MVSTBW 2,5/ 8-STF	1835342	267
MSTBW 2,5/ 9-G-5,08	1735811	313	MVSTBR 2,5/ 6-ST-5,08	1792281	266	MVSTBW 2,5 HC/ 2-ST	1912731	493	MVSTBW 2,5/ 8-STF-5,08	1834961	267
MSTBW 2,5/10-G	1736030	313	MVSTBR 2,5/ 6-STF	1835517	267	MVSTBW 2,5 HC/ 2-ST-5,08	1912841	493	MVSTBW 2,5/ 8-STF-5,08 EX	1809843	369
MSTBW 2,5/10-G-5,08	1735808	313	MVSTBR 2,5/ 6-STF-5,08	1835135	267	MVSTBW 2,5 HC/ 2-STF	1912951	493	MVSTBW 2,5/ 9-ST	1792595	267
MSTBW 2,5/11-G	1736027	313	MVSTBR 2,5/ 6-STF-5,08 EX	1792071	369	MVSTBW 2,5 HC/ 2-STF-5,08	1913060	493	MVSTBW 2,5/ 9-ST-5,08	1792825	267
MSTBW 2,5/11-G-5,08	1735798	313	MVSTBR 2,5/ 7-ST	1792061	266	MVSTBW 2,5 HC/ 3-ST	1912744	493	MVSTBW 2,5/ 9-STEH	1763401	719
MSTBW 2,5/12-G	1736014	313	MVSTBR 2,5/ 7-ST-5,08	1792294	266	MVSTBW 2,5 HC/ 3-ST-5,08	1912854	493	MVSTBW 2,5/ 9-STF	1835355	267
MSTBW 2,5/12-G-5,08	1735785	313	MVSTBR 2,5/ 7-STF	1835520	267	MVSTBW 2,5 HC/ 3-STF	1912964	493	MVSTBW 2,5/ 9-STF-5,08	1834974	267
MSTBW 2,5/13-G	1736001	313	MVSTBR 2,5/ 7-STF-5,08	1835148	267	MVSTBW 2,5 HC/ 3-STF-5,08	1913073	493	MVSTBW 2,5/ 9-STF-5,08 EX	1809856	369
MSTBW 2,5/13-G-5,08	1735772	313	MVSTBR 2,5/ 7-STF-5,08 EX	1809720	369	MVSTBW 2,5 HC/ 4-ST	1912757	493	MVSTBW 2,5/10-ST	1792605	267
MSTBW 2,5/14-G	1735992	313	MVSTBR 2,5/ 8-ST	1792074	266	MVSTBW 2,5 HC/ 4-ST-5,08	1912867	493	MVSTBW 2,5/10-ST-5,08	1792838	267
MSTBW 2,5/14-G-5,08	1735769	313	MVSTBR 2,5/ 8-ST-5,08	1792304	266	MVSTBW 2,5 HC/ 4-STF	1912977	493	MVSTBW 2,5/10-STF	1835368	267
MSTBW 2,5/15-G	1735989	313	MVSTBR 2,5/ 8-STF	1835533	267	MVSTBW 2,5 HC/ 4-STF-5,08	1913086	493	MVSTBW 2,5/10-STF-5,08	1834987	267
MSTBW 2,5/15-G-5,08	1735756	313	MVSTBR 2,5/ 8-STF-5,08	1835151	267	MVSTBW 2,5 HC/ 5-ST	1912760	493	MVSTBW 2,5/10-STF-5,08 EX	1809869	369
MSTBW 2,5/16-G	1735976	313	MVSTBR 2,5/ 8-STF-5,08 EX	1809733	369	MVSTBW 2,5 HC/ 5-STF-5,08	1912870	493	MVSTBW 2,5/11-ST	1792618	267
MSTBW 2,5/16-G-5,08	1735743	313	MVSTBR 2,5/ 9-ST	1792087	266	MVSTBW 2,5 HC/ 5-STF	1912980	493	MVSTBW 2,5/11-ST-5,08	1792841	267
MVSTBR 2,5 HC/ 2-ST	1912294	492	MVSTBR 2,5/ 9-ST-5,08	1792317	266	MVSTBW 2,5 HC/ 5-STF-5,08	1913099	493	MVSTBW 2,5/11-STF	1835371	267
MVSTBR 2,5 HC/ 2-ST-5,08	1912401	492	MVSTBR 2,5/ 9-STF	1835546	267	MVSTBW 2,5 HC/ 6-ST	1912773	493	MVSTBW 2,5/11-STF-5,08	1834990	267
MVSTBR 2,5 HC/ 2-STF	1912511	493	MVSTBR 2,5/ 9-STF-5,08	1835164	267	MVSTBW 2,5 HC/ 6-ST-5,08	1912883	493	MVSTBW 2,5/11-STF-5,08 EX	1809872	369
MVSTBR 2,5 HC/ 2-STF-5,08	1912621	493	MVSTBR 2,5/ 9-STF-5,08 EX	1809746	369	MVSTBW 2,5 HC/ 6-STF	1912993	493	MVSTBW 2,5/12-ST	1792621	267
MVSTBR 2,5 HC/ 3-ST	1912304	492	MVSTBR 2,5/10-ST	1792090	266	MVSTBW 2,5 HC/ 6-STF-5,08	1913109	493	MVSTBW 2,5/12-ST-5,08	1792854	267
MVSTBR 2,5 HC/ 3-ST-5,08	1912414	492	MVSTBR 2,5/10-ST-5,08	1792320	266	MVSTBW 2,5 HC/ 7-ST	1912786	493	MVSTBW 2,5/12-STF	1835384	267
MVSTBR 2,5 HC/ 3-STF	1912524	493	MVSTBR 2,5/10-STF	1835559	267	MVSTBW 2,5 HC/ 7-STF-5,08	1912896	493	MVSTBW 2,5/12-STF-5,08	1835009	267
MVSTBR 2,5 HC/ 3-STF-5,08	1912634	493	MVSTBR 2,5/10-STF-5,08	1835177	267	MVSTBW 2,5 HC/ 7-STF	1913002	493	MVSTBW 2,5/12-STF-5,08 EX	1809885	369
MVSTBR 2,5 HC/ 4-ST	1912317	492	MVSTBR 2,5/10-STF-5,08 EX	1809759	369	MVSTBW 2,5 HC/ 7-STF-5,08	1913112	493	MVSTBW 2,5/13-ST	1792634	267
MVSTBR 2,5 HC/ 4-ST-5,08	1912427	492	MVSTBR 2,5/11-ST	1792100	266	MVSTBW 2,5 HC/ 8-ST	1912799	493	MVSTBW 2,5/13-ST-5,08	1792867	267
MVSTBR 2,5 HC/ 4-STF	191										

Index

Alphabetical

Type	Order No.	Page	Type	Order No.	Page	Type	Order No.	Page	Type	Order No.	Page
MVSTBW 2,5/16-STF	1835423	267	PC 4/ 7-G-7,62	1804849	516	PC 5/10-GFU-7,62	1721096	537	PCU 6/ 4-STD-10,16	1922653	552
MVSTBW 2,5/16-STF-5,08	1835041	267	PC 4/ 7-ST-7,62	1804959	512	PC 5/10-GU-7,62	1720767	537	PCU 6/ 5-STD-10,16	1922666	552
MVSTBW 2,5/17-ST	1792676	719	PC 4/ 7-STF-7,62	1828294	513	PC 5/10-ST1-7,62	1777804	524	PCU 6/ 6-STD-10,16	1922679	552
			PC 4/ 8-G-7,62	1804852	516	PC 5/10-STCL1-7,62	1778146	525	PCU 6/ 7-STD-10,16	1922682	552
			PC 4/ 8-ST-7,62	1804962	512	PC 5/10-STF1-7,62	1777914	525	PCU 6/ 8-STD-10,16	1922695	552
			PC 4/ 8-STF-7,62	1828304	513	PC 5/11-G-7,62	1720550	536	PCU 6/ 9-STD-10,16	1922705	552
			PC 4/ 9-G-7,62	1804865	516	PC 5/11-GF-7,62	1720880	537	PCV 35 HC/ 2-GF-15,00	1762796	591
			PC 4/ 9-ST-7,62	1804975	512	PC 5/11-GFU-7,62	1721106	537	PCV 35 HC/ 3-GF-15,00	1762806	591
N											
NS 105/20 UNPERF	2201508	733	PC 4/ 9-STF-7,62	1828317	513	PC 5/11-GU-7,62	1720770	537	PCV 35 HC/ 4-GF-15,00	1762819	591
			PC 4/10-G-7,62	1804878	516	PC 5/11-ST1-7,62	1777817	524	PCV 35 HC/ 5-GF-15,00	1762822	591
			PC 4/10-ST-7,62	1804988	512	PC 5/11-STCL1-7,62	1778159	525	PCV 35 HC/ 6-GF-15,00	1762835	591
			PC 4/10-STF-7,62	1828320	513	PC 5/11-STF1-7,62	1777927	525	PCV 4/ 2-G-7,62	1804687	517
			PC 4/11-G-7,62	1804881	516	PC 5/12-G-7,62	1720563	536	PCV 4/ 3-G-7,62	1804690	517
			PC 4/11-ST-7,62	1804991	512	PC 5/12-GF-7,62	1720893	537	PCV 4/ 4-G-7,62	1804700	517
			PC 4/11-STF-7,62	1828333	513	PC 5/12-GFU-7,62	1721119	537	PCV 4/ 5-G-7,62	1804713	517
			PC 4/12-G-7,62	1804894	516	PC 5/12-GU-7,62	1720783	537	PCV 4/ 6-G-7,62	1804726	517
P											
P 1-EMG 10	2947792	708	PC 4/12-ST-7,62	1805000	512	PC 5/12-ST1-7,62	1777820	524	PCV 4/ 7-G-7,62	1804739	517
P 1-EMG 12	2947187	709	PC 4/12-STF-7,62	1827583	513	PC 5/12-STCL1-7,62	1778162	525	PCV 4/ 8-G-7,62	1804742	517
P 1-EMG 15	2947857	709	PC 5/ 2-G-7,62	1720466	536	PC 5/12-STF1-7,62	1777930	525	PCV 4/ 9-G-7,62	1804755	517
P 1-EMG 17	2946120	709	PC 5/ 2-GF-7,62	1720796	537	PC 6-16/ 2-G1-10,16	1998933	566	PCV 4/10-G-7,62	1804768	517
P 1-EMG 22	2946188	710	PC 5/ 2-GFU-7,62	1721012	537	PC 6-16/ 2-G1F-10,16	1999000	567	PCV 4/11-G-7,62	1804771	517
P 1-EMG 25	2947190	711	PC 5/ 2-GU-7,62	1720686	537	PC 6-16/ 2-G1FU-10,16	1996317	567	PCV 4/12-G-7,62	1804784	517
P 1-EMG 30	2947912	711	PC 5/ 2-ST1-7,62	1777723	524	PC 6-16/ 2-G1U-10,16	1996236	567	PCV 5/ 2-G-7,62	1720576	538
P 1-EMG 37	2947077	711	PC 5/ 2-STCL1-7,62	1778065	525	PC 6-16/ 3-G1-10,16	1998946	566	PCV 5/ 2-GF-7,62	1720903	538
P 1-EMG 45	2946243	712	PC 5/ 2-STF-SH1-7,62	1778175	525	PC 6-16/ 3-G1F-10,16	1999013	567	PCV 5/ 3-G-7,62	1720589	538
P 1-EMG 50	2947255	713	PC 5/ 2-STF1-7,62	1777833	525	PC 6-16/ 3-G1FU-10,16	1996320	567	PCV 5/ 3-GF-7,62	1720916	539
P 1-EMG 75	2947394	713	PC 5/ 3-G-7,62	1720479	536	PC 6-16/ 3-G1U-10,16	1996249	567	PCV 5/ 4-G-7,62	1720592	538
P 1-EMG 90	2946272	713	PC 5/ 3-GF-7,62	1720806	537	PC 6-16/ 4-G1-10,16	1998959	566	PCV 5/ 4-GF-7,62	1720929	539
P 1-EMG100	2947103	714	PC 5/ 3-GFU-7,62	1721025	537	PC 6-16/ 4-G1F-10,16	1999026	567	PCV 5/ 5-G-7,62	1720602	538
P 1-EMG125	2946010	715	PC 5/ 3-GU-7,62	1720699	537	PC 6-16/ 4-G1FU-10,16	1996333	567	PCV 5/ 5-GF-7,62	1720932	539
P 1-EMG150	2946049	715	PC 5/ 3-ST1-7,62	1777736	524	PC 6-16/ 4-G1U-10,16	1996252	567	PCV 5/ 6-G-7,62	1720615	538
P 1-UEG	2790224	722	PC 5/ 3-STCL1-7,62	1778078	525	PC 6-16/ 5-G1-10,16	1998962	566	PCV 5/ 6-GF-7,62	1720945	539
P 1-UEG-FS/FS	2790428	723	PC 5/ 3-STF-SH1-7,62	1778188	525	PC 6-16/ 5-G1F-10,16	1999039	567	PCV 5/ 7-G-7,62	1720628	538
P 1-UEGH	2757335	726	PC 5/ 3-STF1-7,62	1777846	525	PC 6-16/ 5-G1FU-10,16	1996346	567	PCV 5/ 7-GF-7,62	1720958	539
P 1-UEGM	2792109	724	PC 5/ 4-G-7,62	1720482	536	PC 6-16/ 5-G1U-10,16	1996265	567	PCV 5/ 8-G-7,62	1720631	538
PC 16/ 2-ST-10,16	1967375	554	PC 5/ 4-GF-7,62	1720819	537	PC 6-16/ 6-G1-10,16	1998975	566	PCV 5/ 8-GF-7,62	1720961	539
PC 16/ 2-STF-10,16	1967456	555	PC 5/ 4-GFU-7,62	1721038	537	PC 6-16/ 6-G1F-10,16	1999042	567	PCV 5/ 9-G-7,62	1720644	538
PC 16/ 3-ST-10,16	1967388	554	PC 5/ 4-GU-7,62	1720709	537	PC 6-16/ 6-G1FU-10,16	1996359	567	PCV 5/ 9-GF-7,62	1720974	539
PC 16/ 3-STF-10,16	1967469	555	PC 5/ 4-ST1-7,62	1777749	524	PC 6-16/ 6-G1U-10,16	1996278	567	PCV 5/10-G-7,62	1720657	538
PC 16/ 3-STF-SH-10,16	1737530	555	PC 5/ 4-STCL1-7,62	1778081	525	PC 6-16/ 7-G1-10,16	1998988	566	PCV 5/10-GF-7,62	1720987	539
PC 16/ 4-ST-10,16	1967391	554	PC 5/ 4-STF-SH1-7,62	1778191	525	PC 6-16/ 7-G1F-10,16	1999055	567	PCV 5/11-G-7,62	1720660	538
PC 16/ 4-STF-10,16	1967472	555	PC 5/ 4-STF1-7,62	1777859	525	PC 6-16/ 7-G1FU-10,16	1996362	567	PCV 5/11-GF-7,62	1720990	539
PC 16/ 4-STF-SH-10,16	1970359	555	PC 5/ 5-G-7,62	1720495	536	PC 6-16/ 7-G1U-10,16	1996281	567	PCV 5/12-G-7,62	1720673	538
PC 16/ 5-ST-10,16	1967401	554	PC 5/ 5-GF-7,62	1720822	537	PC 6-16/ 8-G1-10,16	1998991	566	PCV 5/12-GF-7,62	1721009	539
PC 16/ 5-STF-10,16	1967485	555	PC 5/ 5-GFU-7,62	1721041	537	PC 6-16/ 8-G1F-10,16	1999068	567	PCV 6-16/ 2-G1-10,16	1998784	568
PC 16/ 6-ST-10,16	1967414	554	PC 5/ 5-GU-7,62	1720712	537	PC 6-16/ 8-G1FU-10,16	1996375	567	PCV 6-16/ 2-G1F-10,16	1998865	569
PC 16/ 6-STF-10,16	1967498	555	PC 5/ 5-ST1-7,62	1777752	524	PC 6-16/ 8-G1U-10,16	1996294	567	PCV 6-16/ 3-G1-10,16	1998797	568
PC 16/ 7-ST-10,16	1967427	554	PC 5/ 5-STCL1-7,62	1778094	525	PC 6-16/ 9-G1-10,16	1996391	566	PCV 6-16/ 3-G1F-10,16	1998878	569
PC 16/ 7-STF-10,16	1967508	555	PC 5/ 5-STF1-7,62	1777862	525	PC 6-16/ 9-G1F-10,16	1996401	567	PCV 6-16/ 4-G1-10,16	1998807	568
PC 16/ 8-ST-10,16	1967430	554	PC 5/ 6-G-7,62	1720505	536	PC 6-16/ 9-G1FU-10,16	1996388	567	PCV 6-16/ 4-G1F-10,16	1998881	569
PC 16/ 8-STF-10,16	1967511	555	PC 5/ 6-GF-7,62	1720835	537	PC 6-16/ 9-G1U-10,16	1996304	567	PCV 6-16/ 5-G1-10,16	1998810	568
PC 16/ 9-ST-10,16	1967443	554	PC 5/ 6-GFU-7,62	1721054	537	PC 6/ 2-ST-10,16	1913507	550	PCV 6-16/ 5-G1F-10,16	1998894	569
PC 16/ 9-STF-10,16	1967524	555	PC 5/ 6-GU-7,62	1720725	537	PC 6/ 2-STF-10,16	1913578	551	PCV 6-16/ 6-G1-10,16	1998823	568
PC 35 HC/ 2-GF-15,00	1762741	590	PC 5/ 6-ST1-7,62	1777765	524	PC 6/ 3-ST-10,16	1913510	550	PCV 6-16/ 6-G1F-10,16	1998904	569
PC 35 HC/ 2-STF-15,00	1762592	586	PC 5/ 6-STCL1-7,62	1778104	525	PC 6/ 3-STF-10,16	1913581	551	PCV 6-16/ 7-G1-10,16	1998836	568
PC 35 HC/ 3-GF-15,00	1762754	590	PC 5/ 6-STF1-7,62	1777875	525	PC 6/ 3-STF-SH-10,16	1973042	551	PCV 6-16/ 7-G1F-10,16	1998917	569
PC 35 HC/ 3-STF-15,00	1762602	586	PC 5/ 7-G-7,62	1720518	536	PC 6/ 4-ST-10,16	1913523	550	PCV 6-16/ 8-G1-10,16	1998849	568
PC 35 HC/ 4-GF-15,00	1762767	590	PC 5/ 7-GF-7,62	1720848	537	PC 6/ 4-STF-10,16	1913594	551	PCV 6-16/ 8-G1F-10,16	1998920	569
PC 35 HC/ 4-GF-SH-15,00	1762851	591	PC 5/ 7-GFU-7,62	1721067	537	PC 6/ 4-STF-SH-10,16	1966431	551	PCV 6-16/ 9-G1-10,16	1998852	568
PC 35 HC/ 4-STF-15,00	1762615	586	PC 5/ 7-GU-7,62	1720738	537	PC 6/ 5-ST-10,16	1913536	550	PCV 6-16/ 9-G1F-10,16	1996414	569
PC 35 HC/ 4-STF-SH-15,00	1762848	587	PC 5/ 7-ST1-7,62	1777778	524	PC 6/ 5-STF-10,16	1913604	551	PCVK 4-7,62	1849998	521
PC 35 HC/ 5-GF-15,00	1762770	590	PC 5/ 7-STCL1-7,62	1778117	525	PC 6/ 6-ST-10,16	1913549	550	PCVK 4-7,62-F	1850000	521
PC 35 HC/ 5-STF-15,00	1762628	586	PC 5/ 7-STF-SH1-7,62	1778201	525	PC 6/ 6-STF-10,16	1913617	551	PCVK 4-7,62-PE	1876246	521
PC 35 HC/ 6-GF-15,00	1762783	590	PC 5/ 7-STF1-7,62	1777888	525	PC 6/ 7-ST-10,16	1913552	550	PLA 5/ 1-7,5	1792216	471
PC 35 HC/ 6-STF-15,00	1762631	586	PC 5/ 8-G-7,62	1720521	536	PC 6/ 7-STF-10,16	1913620	551	PLA 5/ 2-7,5-ZF	1792229	471
PC 4/ 2-G-7,62	1804797	516	PC 5/ 8-GF-7,62	1720851	537	PC 6					

Type	Order No.	Page	Type	Order No.	Page	Type	Order No.	Page	Type	Order No.	Page
PLH 16/ 3-10-ZF	1770474	473	PST 1,0/13-3,5	1945203	432	PT 1,5/3-PH-5,0	1755596	425	PT 1,5/12-PH-3,5	1984413	423
PLH 16/ 3-15	1770542	473	PST 1,0/13-H-3,5	1737129	433	PT 1,5/3-PH-5,0 CLIP	1755745	425	PT 1,5/12-PH-5,0	1755860	425
PLH 16/ 4-10	1770416	473	PST 1,0/14-3,5	1945216	432	PT 1,5/3-PVH-3,5	1984028	423	PT 1,5/12-PH-5,0 CLIP	1755839	425
PLH 16/ 4-10-ZF	1770487	473	PST 1,0/14-H-3,5	1737132	433	PT 1,5/3-PVH-5,0	1934874	425	PT 1,5/12-PVH-3,5	1984112	423
PLH 16/ 4-15	1770555	473	PST 1,0/15-3,5	1945229	432	PT 1,5/4-3,5-H	1984633	419	PT 1,5/12-PVH-5,0	1934968	425
PLH 16/ 5-10	1770429	473	PST 1,0/15-H-3,5	1737145	433	PT 1,5/4-3,5-V	1984785	419	PT 1,5/13-3,5-H	1984727	419
PLH 16/ 5-10-ZF	1770490	473	PST 1,0/16-3,5	1945232	432	PT 1,5/4-5,0-H	1935187	421	PT 1,5/13-3,5-V	1984879	419
PLH 16/ 5-15	1770568	473	PST 1,0/16-H-3,5	1737158	433	PT 1,5/4-5,0-V	1935336	421	PT 1,5/13-5,0-H	1935271	421
PLH 16/ 6-10	1770432	473	PST 1,3/ 2-5,0	1933189	434	PT 1,5/4-PH-3,5	1984332	423	PT 1,5/13-5,0-V	1935240	421
PLH 16/ 6-10-ZF	1770500	473	PST 1,3/ 2-5,0 R24	1720301	435	PT 1,5/4-PH-5,0	1755606	425	PT 1,5/13-PH-3,5	1984426	423
PLH 16/ 6-15	1770571	473	PST 1,3/ 2-5,0-SF	1805627	417	PT 1,5/4-PH-5,0 CLIP	1755758	425	PT 1,5/13-PH-5,0	1755693	425
PLH 16/ 7-10	1770445	473	PST 1,3/ 2-H-5,0	1995635	435	PT 1,5/4-PVH-3,5	1984031	423	PT 1,5/13-PH-5,0 CLIP	1755842	425
PLH 16/ 7-10-ZF	1770513	473	PST 1,3/ 2-LH-5,0	1704275	431	PT 1,5/4-PVH-5,0	1934887	425	PT 1,5/13-PVH-3,5	1984125	423
PLH 16/ 7-15	1770584	473	PST 1,3/ 2-LV-5,0	1704437	431	PT 1,5/5-3,5-H	1984646	419	PT 1,5/13-PVH-5,0	1934971	425
PLH 16/ 8-10	1770458	473	PST 1,3/ 3-5,0	1933192	434	PT 1,5/5-3,5-V	1984798	419	PT 1,5/14-3,5-H	1984730	419
PLH 16/ 8-10-ZF	1770526	473	PST 1,3/ 3-5,0 R24	1713169	435	PT 1,5/5-5,0-H	1935190	421	PT 1,5/14-3,5-V	1984882	419
PLH 16/ 8-15	1770597	473	PST 1,3/ 3-5,0-SF	1805630	417	PT 1,5/5-5,0-V	1935349	421	PT 1,5/14-5,0-H	1935284	421
PLH 5/ 1-7,5	1792096	470	PST 1,3/ 3-H-5,0	1720301	435	PT 1,5/5-PH-3,5	1984345	423	PT 1,5/14-5,0-V	1984343	421
PLH 5/ 2-7,5-ZF	1792106	471	PST 1,3/ 3-LH-5,0	1704291	431	PT 1,5/5-PH-5,0	1755619	425	PT 1,5/14-PH-3,5	1984439	423
PLH 5/ 3-7,5-ZF	1792119	471	PST 1,3/ 3-LV-5,0	1704453	431	PT 1,5/5-PH-5,0 CLIP	1755761	425	PT 1,5/14-PH-5,0	1755703	425
PLH 5/ 4-7,5-ZF	1792122	471	PST 1,3/ 4-5,0	1933202	434	PT 1,5/5-PVH-3,5	1984044	423	PT 1,5/14-PH-5,0 CLIP	1755855	425
PLH 5/ 5-7,5-ZF	1792135	471	PST 1,3/ 4-5,0 R56	1720314	435	PT 1,5/5-PVH-5,0	1934890	425	PT 1,5/14-PVH-3,5	1984138	423
PLH 5/ 6-7,5-ZF	1792148	471	PST 1,3/ 4-5,0-SF	1805643	417	PT 1,5/6-3,5-H	1984659	419	PT 1,5/14-PVH-5,0	1934984	425
PLH 5/ 7-7,5-ZF	1792151	471	PST 1,3/ 4-H-5,0	1705481	435	PT 1,5/6-3,5-V	1984808	419	PT 1,5/15-3,5-H	1984743	419
PLH 5/ 8-7,5-ZF	1792164	471	PST 1,3/ 4-LH-5,0	1704327	431	PT 1,5/6-5,0-H	1935200	421	PT 1,5/15-3,5-V	1984895	419
PLH 5/ 9-7,5-ZF	1792177	471	PST 1,3/ 4-LV-5,0	1704482	431	PT 1,5/6-5,0-V	1935352	421	PT 1,5/15-5,0-H	1935297	421
PLH 5/10-7,5-ZF	1792180	471	PST 1,3/ 5-5,0	1933215	434	PT 1,5/6-PH-3,5	1984358	423	PT 1,5/15-5,0-V	1935446	421
PLH 5/11-7,5-ZF	1792193	471	PST 1,3/ 5-5,0 R56	1720327	435	PT 1,5/6-PH-5,0	1755622	425	PT 1,5/15-PH-3,5	1984442	423
PLH 5/12-7,5-ZF	1792203	471	PST 1,3/ 5-5,0-SF	1805656	417	PT 1,5/6-PH-5,0 CLIP	1755774	425	PT 1,5/15-PH-5,0	1755716	425
PLW 16-6/ 3-10	1821067	605	PST 1,3/ 5-H-5,0	1705494	435	PT 1,5/6-PVH-3,5	1984057	423	PT 1,5/15-PH-5,0 CLIP	1755868	425
PLW 16-6/ 4-10	1821070	605	PST 1,3/ 5-LH-5,0	1704356	431	PT 1,5/6-PVH-5,0	1934900	425	PT 1,5/15-PVH-3,5	1984141	423
PLW 16-6/ 5-10	1821083	605	PST 1,3/ 5-LV-5,0	1704518	431	PT 1,5/7-3,5-H	1984662	419	PT 1,5/15-PVH-5,0	1934997	425
PMB	1004364	758	PST 1,3/ 6-5,0	1933228	434	PT 1,5/7-3,5-V	1984811	419	PT 1,5/16-3,5-H	1984756	419
PS-IH BK	0311634	831	PST 1,3/ 6-5,0 R56	1720330	435	PT 1,5/7-5,0-H	1935213	421	PT 1,5/16-3,5-V	1984905	419
PS-IH BU	0311582	831	PST 1,3/ 6-5,0-SF	1805669	417	PT 1,5/7-5,0-V	1935365	421	PT 1,5/16-5,0-H	1935307	421
PS-IH GN	0311605	831	PST 1,3/ 6-H-5,0	1705504	435	PT 1,5/7-PH-3,5	1984361	423	PT 1,5/16-5,0-V	1935459	421
PS-IH GY	0311621	831	PST 1,3/ 6-LH-5,0	1704369	431	PT 1,5/7-PH-5,0	1755635	425	PT 1,5/16-PH-3,5	1984455	423
PS-IH RD	0311579	831	PST 1,3/ 6-LV-5,0	1704521	431	PT 1,5/7-PH-5,0 CLIP	1755787	425	PT 1,5/16-PH-5,0	1755729	425
PS-IH VT	0311618	831	PST 1,3/ 7-5,0	1933231	434	PT 1,5/7-PVH-3,5	1984060	423	PT 1,5/16-PH-5,0 CLIP	1755871	425
PS-IH WH	0311566	831	PST 1,3/ 7-5,0 R56	1720343	435	PT 1,5/7-PVH-5,0	1934913	425	PT 1,5/16-PVH-3,5	1984154	423
PS-IH YE	0311595	831	PST 1,3/ 7-5,0-SF	1805672	417	PT 1,5/8-3,5-H	1984675	419	PT 1,5/16-PVH-5,0	1935006	425
PS-MT	0311647	831	PST 1,3/ 7-H-5,0	1717301	435	PT 1,5/8-3,5-V	1984824	419	PT 2,5/ 2-5,0-H	1935776	427
PSC 1,5/ 3-F	1841909	251	PST 1,3/ 7-LH-5,0	1704372	431	PT 1,5/8-5,0-H	1935226	421	PT 2,5/ 2-5,0-V	1987724	427
PSC 1,5/ 3-M	1841857	251	PST 1,3/ 7-LV-5,0	1704534	431	PT 1,5/8-5,0-V	1935378	421	PT 2,5/ 2-7,5-H	1988105	429
PSC 1,5/ 3-M-PE	1848122	253	PST 1,3/ 8-5,0	1933244	434	PT 1,5/8-PH-3,5	1984374	423	PT 2,5/ 2-7,5-V	1987957	429
PSC 1,5/ 5-F	1841912	251	PST 1,3/ 8-5,0 R56	1720356	435	PT 1,5/8-PH-5,0	1755648	425	PT 2,5/ 2-PVH-5,0	1704165	431
PSC 1,5/ 5-M	1841899	253	PST 1,3/ 8-5,0-SF	1805685	417	PT 1,5/8-PH-5,0 CLIP	1755790	425	PT 2,5/ 3-5,0-H	1935789	427
PSC 1,5/ 5-M-PE	1848135	253	PST 1,3/ 8-H-5,0	1717314	435	PT 1,5/8-PVH-3,5	1984073	423	PT 2,5/ 3-5,0-V	1987737	427
PST 1,0/ 2-3,5	1945096	432	PST 1,3/ 8-LH-5,0	1704385	431	PT 1,5/8-PVH-5,0	1934926	425	PT 2,5/ 3-7,5-H	1988118	429
PST 1,0/ 2-3,5 R24	1720233	433	PST 1,3/ 8-LV-5,0	1704547	431	PT 1,5/9-3,5-H	1984688	419	PT 2,5/ 3-7,5-V	1987960	429
PST 1,0/ 2-H-3,5	1737019	433	PST 1,3/ 9-5,0	1933257	434	PT 1,5/9-3,5-V	1984837	419	PT 2,5/ 3-PVH-5,0	1704178	431
PST 1,0/ 3-3,5	1945106	432	PST 1,3/ 9-H-5,0	1717327	435	PT 1,5/9-5,0-H	1935239	421	PT 2,5/ 4-5,0-H	1935792	427
PST 1,0/ 3-3,5 R24	1720246	433	PST 1,3/10-5,0	1933260	434	PT 1,5/9-5,0-V	1935381	421	PT 2,5/ 4-5,0-V	1987740	427
PST 1,0/ 3-H-3,5	1737022	433	PST 1,3/10-H-5,0	1717330	435	PT 1,5/9-PH-3,5	1984387	423	PT 2,5/ 4-7,5-H	1988121	429
PST 1,0/ 4-3,5	1945119	432	PST 1,3/11-5,0	1933273	434	PT 1,5/9-PH-5,0	1755651	425	PT 2,5/ 4-7,5-V	1987973	429
PST 1,0/ 4-3,5 R24	1995525	433	PST 1,3/11-H-5,0	1717343	435	PT 1,5/9-PH-5,0 CLIP	1755800	425	PT 2,5/ 4-PVH-5,0	1704181	431
PST 1,0/ 4-H-3,5	1737035	433	PST 1,3/12-5,0	1933286	434	PT 1,5/9-PVH-3,5	1984086	423	PT 2,5/ 5-5,0-H	1935802	427
PST 1,0/ 5-3,5	1945122	432	PST 1,3/12-H-5,0	1717356	435	PT 1,5/9-PVH-5,0	1934939	425	PT 2,5/ 5-5,0-V	1987753	427
PST 1,0/ 5-3,5 R56	1720259	433	PST 1,3/13-5,0	1933299	434	PT 1,5/10-3,5-H	1984691	419	PT 2,5/ 5-7,5-H	1988134	429
PST 1,0/ 5-H-3,5	1737048	433	PST 1,3/13-H-5,0	1717369	435	PT 1,5/10-3,5-V	1984840	419	PT 2,5/ 5-7,5-V	1987986	429
PST 1,0/ 6-3,5	1945135	432	PST 1,3/14-5,0	1933309	434	PT 1,5/10-5,0-H	1935242	421	PT 2,5/ 5-PVH-5,0	1704194	431
PST 1,0/ 6-3,5 R56	1720262	433	PST 1,3/14-H-5,0	1717372	435	PT 1,5/10-5,0-V	1935394	421	PT 2,5/ 6-5,0-H	1935815	427
PST 1,0/ 6-H-3,5	1737051	433	PST 1,3/15-5,0	1933312	434	PT 1,5/10-PH-3,5	1984390	423	PT 2,5/ 6-5,0-V	1987766	427
PST 1,0/ 7-3,5	1945148	432	PST 1,3/15-H-5,0	1717385	435	PT 1,5/10-PH-5,0	1755664	425	PT 2,5/ 6-7,5-H	1988147	429
PST 1,0/ 7-3,5 R56	1995538	433	PST 1,3/16-5,0	1933325	434	PT 1,5/10-PH-5,0 CLIP	1755813	425	PT 2,5/ 6-7,5-V	1987999	429
PST 1,0/ 7-H-3,5	1737064	433	PST 1,3/16-H-5,0	1717398	435	PT 1,5/10-PVH-3,5	1984099	423	PT 2,5/ 6-PVH-5,0	1704204	431
PST 1,0/ 8-3,5	1945151	432	PT 1,5/ 2-3,5-H	1984617	419	PT 1,5/10-PVH-5,0	1934942	425	PT 2,5/ 7-5,0-H	1935828	427
PST 1,0/ 8-3,5 R56	1720275	433	PT 1,5/ 2-3,5-V	1984769	419	PT 1,5/11-3,5-H	1984701	419	PT 2,5/ 7-5,0-V	1987779	427
PST 1,0/ 8-H-3,5	1737077	433	PT 1,5/ 2-5,0-H	1935161	421	PT 1,5/11-3,5-V	1984853	419	PT 2,5/ 7-7,5-H	1988150	429
PST 1,0/ 9-3,5	1945164	432	PT 1,5/ 2-5,0-V	1935310	421	PT 1,5/11-5,0-H	1935255	421	PT 2,5/ 7-7,5-V	1988008	429
PST 1,0/ 9-3,5 R56	1995541	433	PT 1,5/ 2-PH-3,5	1984316	423	PT 1,5/11-5,0-V	1935404	421	PT 2,5/ 7-PVH-5,0	1704217	431
PST 1,0/ 9-H-3,5	1737080	433	PT 1,5/ 2-PH-5,0	175558							

Index

Alphabetical

Type	Order No.	Page	Type	Order No.	Page	Type	Order No.	Page	Type	Order No.	Page
PT 2,5/10-5,0-H	1935857	427	PTDA 1,5/16-3,5	1725094	407	PTS 1,5/12-PH-5,0	1805614	417	PTSM 0,5/2-P-2,5	1778832	55
PT 2,5/10-5,0-V	1987805	427	PTDA 1,5/16-PH-3,5	1725289	407	PTS-5,08	1876521	164	PTSM 0,5/2-P-2,5 WH	1704853	395
PT 2,5/10-7,5-H	1988189	429	PTDA 2,5/2-5,0	1725302	409	PTSA 0,5/2-2,5-F	1989748	411	PTSM 0,5/3-2,5-H SMD R44	1771033	53
PT 2,5/10-7,5-V	1988037	429	PTDA 2,5/2-PH-5,0	1725497	409	PTSA 0,5/2-2,5-Z	1990009	411	PTSM 0,5/3-2,5-H SMD WH R44	1814647	393
PT 2,5/11-5,0-H	1935860	427	PTDA 2,5/3-5,0	1725315	409	PTSA 0,5/3-2,5-F	1989751	411	PTSM 0,5/3-2,5-H THR R32	1770898	51
PT 2,5/11-5,0-V	1987818	427	PTDA 2,5/3-PH-5,0	1725510	409	PTSA 0,5/3-2,5-Z	1990012	411	PTSM 0,5/3-2,5-H THR WH R32	1814508	391
PT 2,5/11-7,5-H	1988192	429	PTDA 2,5/4-5,0	1725328	409	PTSA 0,5/4-2,5-F	1989764	411	PTSM 0,5/3-2,5-V SMD R44	1771101	53
PT 2,5/11-7,5-V	1988040	429	PTDA 2,5/4-PH-5,0	1725523	409	PTSA 0,5/4-2,5-Z	1990025	411	PTSM 0,5/3-2,5-V SMD WH R44	1814715	393
PT 2,5/12-5,0-H	1935873	427	PTDA 2,5/5-5,0	1725341	409	PTSA 0,5/5-2,5-F	1989777	411	PTSM 0,5/3-2,5-V THR R44	1770966	51
PT 2,5/12-5,0-V	1987821	427	PTDA 2,5/5-PH-5,0	1725536	409	PTSA 0,5/5-2,5-Z	1990038	411	PTSM 0,5/3-2,5-V THR WH R44	1814579	391
PT 2,5/12-7,5-H	1988202	429	PTDA 2,5/6-5,0	1725354	409	PTSA 0,5/6-2,5-F	1989780	411	PTSM 0,5/3-HH-2,5-THR R32	1778638	59
PT 2,5/12-7,5-V	1988053	429	PTDA 2,5/6-PH-5,0	1725549	409	PTSA 0,5/6-2,5-Z	1990041	411	PTSM 0,5/3-HH-2,5-THR WH R32	1814854	397
PT 2,5/13-5,0-H	1935886	427	PTDA 2,5/7-5,0	1725367	409	PTSA 0,5/7-2,5-F	1989793	411	PTSM 0,5/3-HH0-2,5-SMD R32	1808200	59
PT 2,5/13-5,0-V	1987834	427	PTDA 2,5/7-PH-5,0	1725623	409	PTSA 0,5/7-2,5-Z	1990054	411	PTSM 0,5/3-HH0-2,5-SMD WH R32	1814922	397
PT 2,5/14-5,0-H	1935899	427	PTDA 2,5/8-5,0	1725380	409	PTSA 0,5/8-2,5-F	1989803	411	PTSM 0,5/3-HH1-2,5-THR R32	1815060	61
PT 2,5/14-5,0-V	1987847	427	PTDA 2,5/8-PH-5,0	1725636	409	PTSA 0,5/8-2,5-Z	1990067	411	PTSM 0,5/3-HH1-2,5-THR WH R32	1814993	399
PT 2,5/15-5,0-H	1935909	427	PTDA 2,5/9-5,0	1725393	409	PTSA 0,5/9-2,5-F	1989816	411	PTSM 0,5/3-HH0-2,5-SMD R44	1815138	61
PT 2,5/15-5,0-V	1987850	427	PTDA 2,5/9-PH-5,0	1725649	409	PTSA 0,5/9-2,5-Z	1990070	411	PTSM 0,5/3-HH0-2,5-SMD WHR44	1815206	399
PT 2,5/16-5,0-H	1935912	427	PTDA 2,5/10-5,0	1725406	409	PTSA 0,5/10-2,5-F	1989829	411	PTSM 0,5/3-HV-2,5-THR R32	1778560	59
PT 2,5/16-5,0-V	1987863	427	PTDA 2,5/10-PH-5,0	1725652	409	PTSA 0,5/10-2,5-Z	1990083	411	PTSM 0,5/3-HV-2,5-THR WH R32	1815277	397
PT/FS 2,8	1406700	723	PTDA 2,5/11-5,0	1725419	409	PTSA 0,5/11-2,5-F	1989832	411	PTSM 0,5/3-P-2,5	1778845	55
PT/FS 6,3	0604707	723	PTDA 2,5/11-PH-5,0	1725665	409	PTSA 0,5/11-2,5-Z	1990096	411	PTSM 0,5/3-P-2,5 WH	1704854	395
PTA 1,5/2-3,5	1988956	419	PTDA 2,5/12-5,0	1725432	409	PTSA 0,5/12-2,5-F	1989845	411	PTSM 0,5/4-2,5-H SMD R24	1702474	53
PTA 1,5/2-5,0	1988804	421	PTDA 2,5/12-PH-5,0	1725678	409	PTSA 0,5/12-2,5-Z	1990106	411	PTSM 0,5/4-2,5-H SMD WH R24	1814650	393
PTA 1,5/3-3,5	1988969	419	PTDA 2,5/13-5,0	1725445	409	PTSA 0,5/13-2,5-F	1989858	411	PTSM 0,5/4-2,5-H THR R32	1770908	51
PTA 1,5/3-5,0	1988817	421	PTDA 2,5/13-PH-5,0	1725640	409	PTSA 0,5/13-2,5-Z	1990119	411	PTSM 0,5/4-2,5-H THR WH R32	1814511	391
PTA 1,5/4-3,5	1988972	419	PTDA 2,5/14-5,0	1725458	409	PTSA 0,5/14-2,5-F	1989861	411	PTSM 0,5/4-2,5-V SMD R44	1771114	53
PTA 1,5/4-5,0	1988820	421	PTDA 2,5/14-PH-5,0	1725653	409	PTSA 0,5/14-2,5-Z	1990122	411	PTSM 0,5/4-2,5-V SMD WH R44	1814728	393
PTA 1,5/5-3,5	1988985	419	PTDA 2,5/15-5,0	1725471	409	PTSA 0,5/15-2,5-F	1989874	411	PTSM 0,5/4-2,5-V THR R44	1770979	51
PTA 1,5/5-5,0	1988833	421	PTDA 2,5/15-PH-5,0	1725666	409	PTSA 0,5/15-2,5-Z	1990135	411	PTSM 0,5/4-2,5-V THR WH R44	1814582	391
PTA 1,5/6-3,5	1988998	419	PTDA 2,5/16-5,0	1725484	409	PTSA 0,5/16-2,5-F	1989887	411	PTSM 0,5/4-HH-2,5-THR R32	1778641	59
PTA 1,5/6-5,0	1988846	421	PTDA 2,5/16-PH-5,0	1725679	409	PTSA 0,5/16-2,5-Z	1990148	411	PTSM 0,5/4-HH-2,5-THR WH R32	1814867	397
PTA 1,5/7-3,5	1989007	419	PTF 0,3/2-WB-1,8-H	1826091	401	PTSA 1,5/2-3,5-F	1984963	413	PTSM 0,5/4-HH0-2,5-SMD R32	1808213	59
PTA 1,5/7-5,0	1988859	421	PTF 0,3/4-BB-1,8-H	1826101	401	PTSA 1,5/2-3,5-Z	1985195	413	PTSM 0,5/4-HH0-2,5-SMD WH R32	1814935	397
PTA 1,5/8-3,5	1989010	419	PTF 0,3/4-WB-1,8-H	1826114	401	PTSA 1,5/3-3,5-F	1984976	413	PTSM 0,5/4-HH1-2,5-THR R32	1815073	61
PTA 1,5/8-5,0	1988862	421	PTPM 0,2/2-P-2,5	1780477	55	PTSA 1,5/3-3,5-Z	1985205	413	PTSM 0,5/4-HH1-2,5-THR WH R32	1815002	399
PTA 1,5/9-3,5	1989023	419	PTPM 0,2/4-P-2,5	1780480	55	PTSA 1,5/4-3,5-F	1984989	413	PTSM 0,5/4-HH0-2,5-SMD R44	1815141	61
PTA 1,5/9-5,0	1988875	421	PTPM 0,2/5-P-2,5 PA CAT5	1811161	57	PTSA 1,5/4-3,5-Z	1985218	413	PTSM 0,5/4-HH0-2,5-SMD WHR44	1815219	399
PTA 1,5/10-3,5	1989036	419	PTPM 0,2/6-P-2,5	1780493	55	PTSA 1,5/5-3,5-F	1984992	413	PTSM 0,5/4-HV-2,5-THR R32	1778573	59
PTA 1,5/10-5,0	1988888	421	PTPM 0,2/8-P-2,5	1780503	55	PTSA 1,5/5-3,5-Z	1985221	413	PTSM 0,5/4-HV-2,5-THR WH R32	1815280	397
PTA 1,5/11-3,5	1989049	419	PTPM 0,2/10-P-2,5	1780516	55	PTSA 1,5/6-3,5-F	1985001	413	PTSM 0,5/4-P-2,5	1778858	55
PTA 1,5/11-5,0	1988891	421	PTPM 0,4/2-P-2,5	1780529	55	PTSA 1,5/6-3,5-Z	1985234	413	PTSM 0,5/4-P-2,5 WH	1704857	395
PTA 1,5/12-3,5	1989052	419	PTPM 0,4/4-P-2,5	1780532	55	PTSA 1,5/7-3,5-F	1985014	413	PTSM 0,5/5-2,5-H SMD R44	1771059	53
PTA 1,5/12-5,0	1988901	421	PTPM 0,4/5-P-2,5 PA CAT5	1811145	57	PTSA 1,5/7-3,5-Z	1985247	413	PTSM 0,5/5-2,5-H SMD WH R44	1814663	393
PTA 1,5/13-3,5	1989065	419	PTPM 0,4/6-P-2,5	1780545	55	PTSA 1,5/8-3,5-F	1985027	413	PTSM 0,5/5-2,5-H THR R32	1770911	51
PTA 1,5/13-5,0	1988914	421	PTPM 0,4/8-P-2,5	1780558	55	PTSA 1,5/8-3,5-Z	1985250	413	PTSM 0,5/5-2,5-H THR WH R32	1814524	391
PTA 1,5/14-3,5	1989078	419	PTPM 0,4/10-P-2,5	1780561	55	PTSA 1,5/9-3,5-F	1985030	413	PTSM 0,5/5-2,5-V SMD R44	1771127	53
PTA 1,5/14-5,0	1988927	421	PTQ 0,3/2-2,5 THR R32	1702610	63	PTSA 1,5/9-3,5-Z	1985263	413	PTSM 0,5/5-2,5-V SMD WH R44	1814731	393
PTA 1,5/15-3,5	1989081	419	PTS 1,5/2-5,0-H	1792863	415	PTSA 1,5/10-3,5-F	1985043	413	PTSM 0,5/5-2,5-V THR R44	1770982	51
PTA 1,5/15-5,0	1988930	421	PTS 1,5/2-7,5-H	1703083	415	PTSA 1,5/10-3,5-Z	1985276	413	PTSM 0,5/5-2,5-V THR WH R44	1814595	391
PTA 1,5/16-3,5	1989094	419	PTS 1,5/2-PH-5,0	1805517	417	PTSA 1,5/11-3,5-F	1985056	413	PTSM 0,5/5-HH-2,5-THR R32	1778654	59
PTA 1,5/16-5,0	1988943	421	PTS 1,5/3-5,0-H	1792876	415	PTSA 1,5/11-3,5-Z	1985289	413	PTSM 0,5/5-HH-2,5-THR WH R32	1814870	397
PTDA 1,5/2-3,5	1724912	407	PTS 1,5/3-7,5-H	1703084	415	PTSA 1,5/12-3,5-F	1985069	413	PTSM 0,5/5-HH0-2,5-SMD R32	1808226	59
PTDA 1,5/2-PH-3,5	1725107	407	PTS 1,5/3-PH-5,0	1805520	417	PTSA 1,5/12-3,5-Z	1985292	413	PTSM 0,5/5-HH0-2,5-SMD WH R32	1814948	397
PTDA 1,5/3-3,5	1724925	407	PTS 1,5/4-5,0-H	1792889	415	PTSA 1,5/13-3,5-F	1985072	413	PTSM 0,5/5-HH1-2,5-THR R32	1815086	61
PTDA 1,5/3-PH-3,5	1725120	407	PTS 1,5/4-7,5-H	1703086	415	PTSA 1,5/13-3,5-Z	1985302	413	PTSM 0,5/5-HH1-2,5-THR WH R32	1815015	399
PTDA 1,5/4-3,5	1724938	407	PTS 1,5/4-PH-5,0	1805533	417	PTSA 1,5/14-3,5-F	1985085	413	PTSM 0,5/5-HH0-2,5-SMD R44	1815154	61
PTDA 1,5/4-PH-3,5	1725133	407	PTS 1,5/5-5,0-H	1792892	415	PTSA 1,5/14-3,5-Z	1985315	413	PTSM 0,5/5-HH0-2,5-SMD WHR44	1815222	399
PTDA 1,5/5-3,5	1724951	407	PTS 1,5/5-7,5-H	1703087	415	PTSA 1,5/15-3,5-F	1985098	413	PTSM 0,5/5-HV-2,5-THR R32	1778586	59
PTDA 1,5/5-PH-3,5	1725146	407	PTS 1,5/5-PH-5,0	1805546	417	PTSA 1,5/15-3,5-Z	1985328	413	PTSM 0,5/5-HV-2,5-THR WH R32	1815293	397
PTDA 1,5/6-3,5	1724964	407	PTS 1,5/6-5,0-H	1792902	415	PTSA 1,5/16-3,5-F	1985108	413	PTSM 0,5/5-P-2,5	1778861	55
PTDA 1,5/6-PH-3,5	1725159	407	PTS 1,5/6-7,5-H	1703088	415	PTSA 1,5/16-3,5-Z	1985331	413	PTSM 0,5/5-P-2,5 WH	1704858	395
PTDA 1,5/7-3,5	1724977	407	PTS 1,5/6-PH-5,0	1805559	417	PTSM 0,5/2-2,5-H SMD R24	1702473	53	PTSM 0,5/6-2,5-H SMD R44	1771062	53
PTDA 1,5/7-PH-3,5	1725172	407	PTS 1,5/7-5,0-H	1792915	415	PTSM 0,5/2-2,5-H SMD WH R24	1814634	393	PTSM 0,5/6-2,5-H SMD WH R44	1814676	393
PTDA 1,5/8-3,5	1724996	407	PTS 1,5/7-7,5-H	1703090	415	PTSM 0,5/2-2,5-H THR R24	1770885	51	PTSM 0,5/6-2,5-H THR R32	1770924	51
PTDA 1,5/8-PH-3,5	1725185	407	PTS 1,5/7-PH-5,0	1805562	417	PTSM 0,5/2-2,5-H THR WH R24	1814498	391	PTSM 0,5/6-2,5-H THR WH R32	1814537	391
PTDA 1,5/9-3,5	1725003	407	PTS 1,5/8-5,0-H	1792928	415	PTSM 0,5/2-2,5-V SMD R44	1771091	53	PTSM 0,5/6-2,5-V SMD R44	1771130	53
PTDA 1,5/9-PH-3,5	1725198	407	PTS 1,5/8-7,5-H	1703091	415	PTSM 0,5/2-2,5-V SMD WH R44	1814702	393	PTSM 0,5/6-2,5-V SMD WH R44	1814744	393
PTDA 1,5/10-3,5	1725016	407	PTS 1,5/8-PH-5,0	1805575	417	PTSM 0,5/2-2,5-V THR R44	1770953	51	PTSM 0,5/6-2,5-V THR R44	1770995	51
PTDA 1,5/10-PH-3,5	1725211	407	PTS 1,5/9-5,0-H	1792931	415	PTSM 0,5/2-HH0-2,5-SMD WH R44	1814566	391	PTSM 0,5/6-2,5-V THR WH R44	1814605	391
PTDA 1,5/11-3,5	1725029	407	PTS 1,5/9-7,5-H	1703093	415	PTSM 0,5/2-HH-2,5-THR R16	1778625	59	PTSM 0,5/6-HH-2,5-THR R32	1778667	59
PTDA 1,5/11-PH-3,5	1725224	407	PTS 1,5/9-PH-5,0	1805588	417	PTSM 0,5/2-HH-2,5-THR WH R16	1814841	397	PTSM 0,5/6-HH-2,5-THR WH R32	1814883	397
PTDA 1,5/12-3,5	1725042	407	PTS 1,5/10-5,0-H	1792944	415	PTSM 0,5/2-HH0-2,5-SMD R32	1808190	59	PTSM 0,5/6-HH0-2,5-SMD R44	1808239	59
PTDA 1,5/12-PH-3,5	1725237	407	PTS 1,5/10-7,5-H	1703094	415	PTSM 0,5/2-HH0-2,5-SMD WH R32	1814919	397	PTSM 0,5/6-HH0-2,5-SMD WH R44	1814951	397
PTDA 1,5/13-3,5	1725055	407	PTS 1,5/10-PH-5,0	1805591	417	PTSM 0,5/2-HH1-2,5-THR R24	1815057	61	PTSM 0,5/6-HH1-2,5-THR R32	1815099	61
PTDA 1,5/13-PH-3,5	1725250	407	PTS 1,								

Type	Order No.	Page	Type	Order No.	Page	Type	Order No.	Page	Type	Order No.	Page
PTSM 0,5/6-P-2,5	1778874	55	QC 0,5/10-ST-3,81	1897474	204	SIH-FKS 30		1727528	165		
PTSM 0,5/6-P-2,5 WH	1704859	395	QC 0,5/10-STF-3,81	1897623	205	SISM 45		2942865	765		
PTSM 0,5/7-2,5-H SMD R44	1771075	53	QC 0,5/11-ST-3,81	1897487	204	SISM 45 H		2940139	765		
PTSM 0,5/7-2,5-H SMD WH R44	1814689	393	QC 0,5/11-STF-3,81	1897636	205	SK 2,54/2,8:FORTL.ZAHLEN		0804853	796		
PTSM 0,5/7-2,5-H THR R32	1770937	51	QC 0,5/12-ST-3,81	1897490	204	SK 2,8 WH:REEL		0805205	796		
PTSM 0,5/7-2,5-H THR WH R32	1814540	391	QC 0,5/12-STF-3,81	1897649	205	SK 3,5/2,8:FORTL.ZAHLEN		0804073	797		
PTSM 0,5/7-2,5-V SMD R44	1771143	53	QC 0,5/13-ST-3,81	1897500	204	SK 3,8 WH:REEL		0805218	798		
PTSM 0,5/7-2,5-V SMD WH R44	1814757	393	QC 0,5/13-STF-3,81	1897652	205	SK 3,81/2,8:FORTL.ZAHLEN		0804109	797		
PTSM 0,5/7-2,5-V THR R44	1771004	51	QC 0,5/14-ST-3,81	1897513	204	SK 5,0 WH:REEL		0805221	800		
PTSM 0,5/7-2,5-V THR WH R44	1814618	391	QC 0,5/14-STF-3,81	1897665	205	SK 5,08/2,8:FORTL.ZAHLEN		0804280	797		
PTSM 0,5/7-HH-2,5-THR R44	1778670	59	QC 0,5/15-ST-3,81	1897526	204	SK 5,08/3,8:FORTL.ZAHLEN		0804293	798		
PTSM 0,5/7-HH-2,5-THR WH R44	1814896	397	QC 0,5/15-STF-3,81	1897678	205	SK 5/3,8:FORTL.ZAHLEN		0804183	798		
PTSM 0,5/7-HH0-2,5-SMD R44	1808242	59	QC 0,5/16-ST-3,81	1897539	204	SK 6,2/3,8:FORTL.ZAHLEN		0804374	799		
PTSM 0,5/7-HH0-2,5-SMD WH R44	1814964	397	QC 0,5/16-STF-3,81	1897681	205	SK 7,5/3,8:FORTL.ZAHLEN		0804455	799		
PTSM 0,5/7-HH1-2,5-THR R32	1815109	61	QC 1,5/2-ST	1717961	292	SK 7,5/5:FORTL.ZAHLEN		0804468	800		
PTSM 0,5/7-HH1-2,5-THR WH R32	1815031	399	QC 1,5/2-STF	1718119	293	SK 7,62/3,8:FORTL.ZAHLEN		0804549	799		
PTSM 0,5/7-HH10-2,5-SMD R44	1815170	61	QC 1,5/3-ST	1717974	292	SK 7,62/5:FORTL.ZAHLEN		0804552	800		
PTSM 0,5/7-HH10-2,5-SMD WH R44	1815248	399	QC 1,5/3-STF	1718122	293	SK 10,0 WH:REEL		0812188	801		
PTSM 0,5/7-HV-2,5-THR R44	1778609	59	QC 1,5/4-ST	1717987	292	SK 2,8 REEL P2,54 WH CUS		0825120	796		
PTSM 0,5/7-HV-2,5-THR WH R44	1815316	397	QC 1,5/4-STF	1718135	293	SK 2,8 REEL P3,5 WH CUS		0825121	797		
PTSM 0,5/7-P-2,5	1778887	55	QC 1,5/5-ST	1717990	292	SK 2,8 REEL P3,81 WH CUS		0825122	797		
PTSM 0,5/7-P-2,5 WH	1704860	395	QC 1,5/5-STF	1718148	293	SK 2,8 REEL P5,08 WH CUS		0825123	797		
PTSM 0,5/8-2,5-H SMD R44	1771088	53	QC 1,5/6-ST	1718009	292	SK 3,8 REEL P5 WH CUS		0825124	798		
PTSM 0,5/8-2,5-H SMD WH R44	1814692	393	QC 1,5/6-STF	1718151	293	SK 3,8 REEL P5,08 WH CUS		0825125	798		
PTSM 0,5/8-2,5-H THR R32	1770940	51	QC 1,5/7-ST	1718012	292	SK 3,8 REEL P6,2 WH CUS		0825126	799		
PTSM 0,5/8-2,5-H THR WH R32	1814553	391	QC 1,5/7-STF	1718164	293	SK 3,8 REEL P7,5 WH CUS		0825127	799		
PTSM 0,5/8-2,5-V SMD R44	1771156	53	QC 1,5/8-ST	1718025	292	SK 3,8 REEL P7,62 WH CUS		0825128	799		
PTSM 0,5/8-2,5-V SMD WH R44	1814760	393	QC 1,5/8-STF	1718177	293	SK 5,0 REEL P7,5 WH CUS		0825131	800		
PTSM 0,5/8-2,5-V THR R44	1771017	51	QC 1,5/9-ST	1718038	292	SK 5,0 REEL P7,62 WH CUS		0825132	800		
PTSM 0,5/8-2,5-V THR WH R44	1814621	391	QC 1,5/9-STF	1718180	293	SK U/2,8 WH:UNBEDRUCKT		0803883	796		
PTSM 0,5/8-HH-2,5-THR R44	1778683	59	QC 1,5/10-ST	1718041	292	SK U/3,8 WH:UNBEDRUCKT		0803906	798		
PTSM 0,5/8-HH-2,5-THR WH R44	1814906	397	QC 1,5/10-STF	1718193	293	SK U/5,0 WH:UNBEDRUCKT		0803922	800		
PTSM 0,5/8-HH0-2,5-SMD R44	1808255	59	QC 1,5/11-ST	1718054	292	SKBI 31		2201519	776		
PTSM 0,5/8-HH0-2,5-SMD WH R44	1814977	397	QC 1,5/11-STF	1718203	293	SKBI 32/C		2261038	778		
PTSM 0,5/8-HH1-2,5-THR R32	1815112	61	QC 1,5/12-ST	1718067	292	SKBI 32/D		2261054	779		
PTSM 0,5/8-HH1-2,5-THR WH R32	1815044	399	QC 1,5/12-STF	1718216	293	SKBI 32/F/ZB		2261096	779		
PTSM 0,5/8-HH10-2,5-SMD R44	1815183	61	QC 1,5/13-ST	1718070	292	SKBI 32/F/ZD		2261106	779		
PTSM 0,5/8-HH10-2,5-SMD WH R44	1815251	399	QC 1,5/13-STF	1718229	293	SKBI 64/B64		2263023	780		
PTSM 0,5/8-HV-2,5-THR R44	1778612	59	QC 1,5/14-ST	1718083	292	SKBI 64/C32		2265034	781		
PTSM 0,5/8-HV-2,5-THR WH R44	1815329	397	QC 1,5/14-STF	1718232	293	SKBI 64/C64		2263036	781		
PTSM 0,5/8-P-2,5	1778890	55	QC 1,5/15-ST	1718096	292	SKBI 64/D32		2265050	782		
PTSM 0,5/8-P-2,5 WH	1704861	395	QC 1,5/15-STF	1718245	293	SKBI 64/E48		2264080	783		
PTSM 0,5/10-HH-2,5-THR R44	1701569	59	QC 1,5/16-ST	1718106	292	SKBI 64/F48		2264093	783		
PTSM 0,5/10-HV-2,5-THR R44	1701567	59	QC 1,5/16-STF	1718258	293	SKBI 64/G64		2263117	783		
PTSPL-6/1-2X2,2,1 R32	1704836	475	QC 1/2-ST-5,08	1883255	290	SKBI 64/H15-MKDS3		2269140	784		
PTSPL-6/1-2X2,2,9 R32	1704837	475	QC 1/2-ST-BUS	1921670	291	SKBI 64/H15-MKDS5		2269153	785		
PTSPL0-6/1-2X2,2,1 R32	1705081	475	QC 1/2-STF-5,08	1883352	291	SKBI 128-B64/B64		2268028	786		
PTSPL0-6/1-2X2,2,9 R32	1705085	475	QC 1/3-ST-5,08	1883268	290	SKBI 128-C32/C32		2270032	786		
PW 4-POT-SCM	3056938	601	QC 1/3-ST-BUS	1921683	291	SKBI 128-C64/C64		2268031	786		
PW 4-POT-SCM/S	3056941	601	QC 1/3-STF-5,08	1883365	291	SKBI 128-D32/D32		2270058	786		
PW 4-POT-SL	3059731	601	QC 1/4-ST-5,08	1883271	290	SKBI 128-E48/E48		2269085	786		
PW 4-POT-SL/S	3059744	601	QC 1/4-ST-BUS	1921696	291	SKBI 128-F48/F48		2269098	786		
PWO 16-POT	1705653	604	QC 1/4-STF-5,08	1883378	291	SKBI 128-G64/G64		2268112	786		
PWO 16-POT/S	1705654	604	QC 1/5-ST-5,08	1883284	290	SL2-2,54/16-ST		2896348	698		
PWO 4-POT-SCM	3056912	603	QC 1/5-ST-BUS	1921706	291	SMC 1,5/2-G-3,81		1827279	228		
PWO 4-POT-SCM/S	3056925	603	QC 1/5-STF-5,08	1883381	291	SMC 1,5/2-GF-3,81		1827428	229		
PWO 4-POT-SL	3059715	603	QC 1/6-ST-5,08	1883297	290	SMC 1,5/3-G-3,81		1827282	228		
PWO 4-POT-SL/S	3059728	603	QC 1/6-ST-BUS	1921719	291	SMC 1,5/3-GF-3,81		1827431	229		
			QC 1/6-STF-5,08	1883394	291	SMC 1,5/4-G-3,81		1827295	228		
			QC 1/7-ST-5,08	1883307	290	SMC 1,5/4-GF-3,81		1827444	229		
			QC 1/7-STF-5,08	1883404	291	SMC 1,5/5-G-3,81		1827305	228		
			QC 1/8-ST-5,08	1883310	290	SMC 1,5/5-GF-3,81		1827457	229		
			QC 1/8-STF-5,08	1883417	291	SMC 1,5/6-G-3,81		1827318	228		
			QC 1/9-ST-5,08	1883323	290	SMC 1,5/6-GF-3,81		1827460	229		
			QC 1/9-STF-5,08	1883420	291	SMC 1,5/7-G-3,81		1827321	228		
QC 0,5/2-ST-3,81	1897393	204	QC 1/10-ST-5,08	1883336	290	SMC 1,5/7-GF-3,81		1827473	229		
QC 0,5/2-STF-3,81	1897542	205	QC 1/10-STF-5,08	1883433	291	SMC 1,5/8-G-3,81		1827334	228		
QC 0,5/3-ST-3,81	1897403	204	QC 1/11-ST-5,08	1883349	290	SMC 1,5/8-GF-3,81		1827486	229		
QC 0,5/3-STF-3,81	1897555	205									
QC 0,5/4-ST-3,81	1897416	204	QC 1/11-STF-5,08	1883446	291	SFLY 2,5/D32	2285467	788	SMC 1,5/9-G-3,81	1827347	228
QC 0,5/4-STF-3,81	1897568	205	QC 1/12-ST-5,08	1883705	290	SFLY 2,5/F32/ZB	2285506	788	SMC 1,5/9-GF-3,81	1827499	229
QC 0,5/5-ST-3,81	1897429	204	QC 1/12-STF-5,08	1883459	291	SI FORM C 2 A	0913689	165	SMC 1,5/10-G-3,81	1827350	228
QC 0,5/5-STF-3,81	1897571	205	QC 1/13-ST-5,08	1883815	290	SI FORM C 4 A DIN 72581	0913731	165	SMC 1,5/10-GF-3,81	1827509	229
QC 0,5/6-ST-3,81	1897432	204	QC 1/13-STF-5,08	1883857	291	SI FORM C 5 A DIN 72581	0913692	165	SMC 1,5/11-G-3,81	1827363	228
QC 0,5/6-STF-3,81	1897584	205	QC 1/14-ST-5,08	1883828	290	SI FORM C 10 A DIN 72581	0913715	165	SMC 1,5/11-GF-3,81	1827512	229
QC 0,5/7-ST-3,81	1897445	204	QC 1/14-STF-5,08	1883860	291	SI FORM C 15 A DIN 72581	0913676	165	SMC 1,5/12-G-3,81	1827376	228
QC 0,5/7-STF-3,81	1897597	205	QC 1/15-ST-5,08	1883831	290	SI FORM C 20 A DIN 72581	0913744	165	SMC 1,5/12-GF-3,81	1827525	229
QC 0,5/8-ST-3,81	1897458	204	QC 1/15-STF-5,08	1883886	291	SI FORM C 25 A DIN 72581	0913757	165	SMC 1,5/13-G-3,81	1827389	228
QC 0,5/8-STF-3,81	1897607	205	QC 1/16-ST-5,08	1883844	290	SI FORM C 30 A DIN 72581	0913760	165	SMC 1,5/13-GF-3,81	1827538	229
QC 0,5/9-ST-3,81	1897461	204	QC 1/16-STF-5,08	1883899	291	SI FORM C 7,5 A DIN 72581	0913702	165	SMC 1,5/14-G-3,81	1827392	228
QC 0,5/9-STF-3,81	1897610	205				SI-H-FKS 15	1728996	165	SMC 1,5/14-GF-3,81	1827541	229

Q

R

S

Index

Alphabetical

Type	Order No.	Page	Type	Order No.	Page	Type	Order No.	Page	Type	Order No.	Page
SMC 1,5/15-G-3,81	1827402	228	SMKDSN 1,5/14-5,08	1869334	91	SMSTB 2,5/10-STF-5,08	1971141	269	SPC 16/6-STF-10,16	1711417	563
SMC 1,5/15-GF-3,81	1827554	229	SMKDSN 1,5/15	1869198	91	SMSTB 2,5/11-G	1769324	318	SPC 16/7-ST-10,16	1711310	562
SMC 1,5/16-G-3,81	1827415	228	SMKDSN 1,5/15-5,08	1869347	91	SMSTB 2,5/11-G-5,08	1769557	318	SPC 16/7-STF-10,16	1711446	563
SMC 1,5/16-GF-3,81	1827567	229	SMKDSN 1,5/16	1869208	91	SMSTB 2,5/11-ST	1768846	268	SPC 16/8-ST-10,16	1711323	562
SMKDS 1,5/2-3,5	1931770	87	SMKDSN 1,5/16-5,08	1869350	91	SMSTB 2,5/11-ST-5,08	1826377	268	SPC 16/8-STF-10,16	1711433	563
SMKDS 1,5/3-3,5	1931783	87	SMKDSN 1,5/2	1733415	95	SMSTB 2,5/11-STF	1970964	269	SPC 16/9-ST-10,16	1711336	562
SMKDS 1/2-3,5	1751099	85	SMKDSN 1,5/2-5,08	1733570	95	SMSTB 2,5/11-STF-5,08	1971154	269	SPC 16/9-STF-10,16	1711446	563
SMKDS 1/2-3,81	1728284	85	SMKDSN 1,5/3	1733428	95	SMSTB 2,5/12-G	1769337	318	SPC 5/2-ST-7,62	1996016	530
SMKDS 1/3-3,5	1751109	85	SMKDSN 1,5/3-5,08	1733583	95	SMSTB 2,5/12-G-5,08	1769560	318	SPC 5/2-STCL-7,62	1718481	531
SMKDS 1/3-3,81	1728297	85	SMKDSN 1,5/4	1733431	95	SMSTB 2,5/12-STF	1768859	268	SPC 5/2-STF-7,62	1996126	531
SMKDS 1/4-3,5	1751112	85	SMKDSN 1,5/4-5,08	1733596	95	SMSTB 2,5/12-ST-5,08	1826380	268	SPC 5/3-ST-7,62	1996029	530
SMKDS 1/4-3,81	1728307	85	SMKDSN 1,5/5	1733444	95	SMSTB 2,5/12-STF	1970977	269	SPC 5/3-STCL-7,62	1718494	531
SMKDS 1/5-3,5	1751125	85	SMKDSN 1,5/5-5,08	1733606	95	SMSTB 2,5/12-STF-5,08	1971167	269	SPC 5/3-STF-7,62	1996139	531
SMKDS 1/5-3,81	1728310	85	SMKDSN 1,5/6	1733457	95	SMSTB 2,5/13-G	1769340	318	SPC 5/4-ST-7,62	1996032	530
SMKDS 1/6-3,5	1751138	85	SMKDSN 1,5/6-5,08	1733619	95	SMSTB 2,5/13-G-5,08	1769573	318	SPC 5/4-STCL-7,62	1718504	531
SMKDS 1/6-3,81	1728323	85	SMKDSN 1,5/7	1733460	95	SMSTB 2,5/13-ST	1768862	268	SPC 5/4-STF-7,62	1996142	531
SMKDS 1/7-3,5	1751141	85	SMKDSN 1,5/7-5,08	1733622	95	SMSTB 2,5/13-ST-5,08	1826393	268	SPC 5/4-STF-SH-7,62	1704071	531
SMKDS 1/7-3,81	1728336	85	SMKDSN 1,5/8	1733473	95	SMSTB 2,5/13-STF	1970980	269	SPC 5/5-ST-7,62	1996045	530
SMKDS 1/8-3,5	1751154	85	SMKDSN 1,5/8-5,08	1733635	95	SMSTB 2,5/13-STF-5,08	1971170	269	SPC 5/5-STCL-7,62	1718517	531
SMKDS 1/8-3,81	1728349	85	SMKDSN 1,5/9	1733486	95	SMSTB 2,5/14-G	1769353	318	SPC 5/5-STF-7,62	1996155	531
SMKDS 1/9-3,5	1751167	85	SMKDSN 1,5/9-5,08	1733648	95	SMSTB 2,5/14-G-5,08	1769586	318	SPC 5/6-ST-7,62	1996058	530
SMKDS 1/9-3,81	1728352	85	SMKDSN 1,5/10	1733499	95	SMSTB 2,5/14-ST	1768875	268	SPC 5/6-STCL-7,62	1718520	531
SMKDS 1/10-3,5	1751170	85	SMKDSN 1,5/10-5,08	1733651	95	SMSTB 2,5/14-ST-5,08	1826403	268	SPC 5/6-STF-7,62	1996168	531
SMKDS 1/10-3,81	1728365	85	SMKDSN 1,5/11	1733509	95	SMSTB 2,5/14-STF	1970993	269	SPC 5/7-ST-7,62	1996061	530
SMKDS 1/11-3,5	1751183	85	SMKDSN 1,5/11-5,08	1733664	95	SMSTB 2,5/14-STF-5,08	1971183	269	SPC 5/7-STCL-7,62	1718533	531
SMKDS 1/11-3,81	1728378	85	SMKDSN 1,5/12	1733512	95	SMSTB 2,5/15-G	1769366	318	SPC 5/7-STF-7,62	1996171	531
SMKDS 1/12-3,5	1751196	85	SMKDSN 1,5/12-5,08	1733677	95	SMSTB 2,5/15-G-5,08	1769599	318	SPC 5/8-ST-7,62	1996074	530
SMKDS 1/12-3,81	1728381	85	SMSTB 2,5/2-G	1769230	318	SMSTB 2,5/15-ST	1768888	268	SPC 5/8-STCL-7,62	1718546	531
SMKDS 1/13-3,5	1751206	85	SMSTB 2,5/2-G-5,08	1769463	318	SMSTB 2,5/15-ST-5,08	1826416	268	SPC 5/8-STF-7,62	1996184	531
SMKDS 1/14-3,5	1751219	85	SMSTB 2,5/2-ST	1768765	268	SMSTB 2,5/15-STF	1971002	269	SPC 5/9-ST-7,62	1996087	530
SMKDS 1/15-3,5	1751222	85	SMSTB 2,5/2-ST-5,08	1826283	268	SMSTB 2,5/15-STF-5,08	1971196	269	SPC 5/9-STCL-7,62	1718559	531
SMKDS 1/16-3,5	1751235	85	SMSTB 2,5/2-STF	1970870	269	SMSTB 2,5/16-G	1769379	318	SPC 5/9-STF-7,62	1996197	531
SMKDS 2,5/2-5,08	1705469	103	SMSTB 2,5/2-STF-5,08	1971060	269	SMSTB 2,5/16-G-5,08	1769609	318	SPC 5/10-ST-7,62	1996090	530
SMKDS 2,5/3-5,08	1705472	103	SMSTB 2,5/3-G	1769243	318	SMSTB 2,5/16-ST	1768891	268	SPC 5/10-STCL-7,62	1718562	531
SMKDS 2,5/4-5,08	1995664	103	SMSTB 2,5/3-G-5,08	1769476	318	SMSTB 2,5/16-ST-5,08	1826429	268	SPC 5/10-STF-7,62	1996207	531
SMKDS 2,5/5-5,08	1702558	103	SMSTB 2,5/3-ST	1768778	268	SMSTB 2,5/16-STF	1971015	269	SPC 5/11-ST-7,62	1996100	530
SMKDS 2,5/6-5,08	1736777	103	SMSTB 2,5/3-ST-5,08	1826296	268	SMSTB 2,5/16-STF-5,08	1971206	269	SPC 5/11-STCL-7,62	1718575	531
SMKDS 2,5/7-5,08	1766174	103	SMSTB 2,5/3-STF	1970883	269	SMSTBA 2,5/2-G	1769803	319	SPC 5/11-STF-7,62	1996210	531
SMKDS 2,5/8-5,08	1736845	103	SMSTB 2,5/3-STF-5,08	1971073	269	SMSTBA 2,5/2-G-5,08	1767371	319	SPC 5/12-ST-7,62	1996113	530
SMKDS 2,5/9-5,08	1701826	103	SMSTB 2,5/4-G	1769256	318	SMSTBA 2,5/3-G	1769816	319	SPC 5/12-STCL-7,62	1718588	531
SMKDS 2,5/10-5,08	1736780	103	SMSTB 2,5/4-G-5,08	1769489	318	SMSTBA 2,5/3-G-5,08	1767384	319	SPC 5/12-STF-7,62	1996223	531
SMKDS 3/2	1713024	107	SMSTB 2,5/4-ST	1768781	268	SMSTBA 2,5/4-G	1769829	319	SPT 1,5/2-H-3,5	1990737	141
SMKDS 3/2-5,08	1713723	107	SMSTB 2,5/4-ST-5,08	1826306	268	SMSTBA 2,5/4-G-5,08	1767397	319	SPT 1,5/2-V-3,5	1990850	141
SMKDS 3/3	1713037	107	SMSTB 2,5/4-STF	1970896	269	SMSTBA 2,5/5-G	1769832	319	SPT 1,5/3-H-3,5	1990740	141
SMKDS 3/3-5,08	1713736	107	SMSTB 2,5/4-STF-5,08	1971086	269	SMSTBA 2,5/5-G-5,08	1767407	319	SPT 1,5/3-V-3,5	1990863	141
SMKDS 3/4	1713082	107	SMSTB 2,5/5-G	1769269	318	SMSTBA 2,5/6-G	1769845	319	SPT 1,5/4-H-3,5	1990753	141
SMKDS 3/4-5,08	1713040	107	SMSTB 2,5/5-G-5,08	1769492	318	SMSTBA 2,5/6-G-5,08	1767410	319	SPT 1,5/4-V-3,5	1990876	141
SMKDS 3/6	1713121	107	SMSTB 2,5/5-ST	1768794	268	SMSTBA 2,5/7-G	1769858	319	SPT 1,5/5-H-3,5	1990766	141
SMKDS 3/6-5,08	1713286	107	SMSTB 2,5/5-ST-5,08	1826319	268	SMSTBA 2,5/7-G-5,08	1767423	319	SPT 1,5/5-V-3,5	1990889	141
SMKDS 3/8	1713066	107	SMSTB 2,5/5-STF	1970906	269	SMSTBA 2,5/8-G	1769861	319	SPT 1,5/6-H-3,5	1990779	141
SMKDS 3/12	1713105	107	SMSTB 2,5/5-STF-5,08	1971099	269	SMSTBA 2,5/8-G-5,08	1767436	319	SPT 1,5/6-V-3,5	1990892	141
SMKDS 5/2-6,35	1720033	447	SMSTB 2,5/6-G	1769272	318	SMSTBA 2,5/9-G	1769874	319	SPT 1,5/7-H-3,5	1990782	141
SMKDS 5/2-9,5	1720017	447	SMSTB 2,5/6-G-5,08	1769502	318	SMSTBA 2,5/9-G-5,08	1767449	319	SPT 1,5/7-V-3,5	1990902	141
SMKDS 5/3-6,35	1720046	447	SMSTB 2,5/6-ST	1768804	268	SMSTBA 2,5/10-G	1769887	319	SPT 1,5/8-H-3,5	1990795	141
SMKDS 5/3-9,5	1720020	447	SMSTB 2,5/6-ST-5,08	1826322	268	SMSTBA 2,5/10-G-5,08	1767452	319	SPT 1,5/8-V-3,5	1990915	141
SMKDSN 1,5/2	1869062	91	SMSTB 2,5/6-STF	1970919	269	SMSTBA 2,5/11-G	1769890	319	SPT 1,5/9-H-3,5	1990805	141
SMKDSN 1,5/2-5,08	1869211	91	SMSTB 2,5/6-STF-5,08	1971109	269	SMSTBA 2,5/11-G-5,08	1767465	319	SPT 1,5/9-V-3,5	1990928	141
SMKDSN 1,5/3	1869075	91	SMSTB 2,5/7-G	1769285	318	SMSTBA 2,5/12-G	1769900	319	SPT 1,5/10-H-3,5	1990818	141
SMKDSN 1,5/3-5,08	1869224	91	SMSTB 2,5/7-G-5,08	1769515	318	SMSTBA 2,5/12-G-5,08	1767478	319	SPT 1,5/10-V-3,5	1990931	141
SMKDSN 1,5/4	1869088	91	SMSTB 2,5/7-ST	1768817	268	SMSTBA 2,5/13-G	1769913	319	SPT 1,5/11-H-3,5	1990821	141
SMKDSN 1,5/4-5,08	1869237	91	SMSTB 2,5/7-ST-5,08	1826335	268	SMSTBA 2,5/13-G-5,08	1767481	319	SPT 1,5/11-V-3,5	1990944	141
SMKDSN 1,5/5	1869091	91	SMSTB 2,5/7-STF	1970922	269	SMSTBA 2,5/14-G	1769926	319	SPT 1,5/12-H-3,5	1990834	141
SMKDSN 1,5/5-5,08	1869240	91	SMSTB 2,5/7-STF-5,08	1971112	269	SMSTBA 2,5/14-G-5,08	1767494	319	SPT 1,5/12-V-3,5	1990957	141
SMKDSN 1,5/6	1869101	91	SMSTB 2,5/8-G	1769298	318	SMSTBA 2,5/15-G	1769939	319	SPT 1,5/13-H-10,0	1735778	467
SMKDSN 1,5/6-5,08	1869253	91	SMSTB 2,5/8-G-5,08	1769528	318	SMSTBA 2,5/15-G-5,08	1767504	319	SPT 1,5/14-V-10,0	1735862	469
SMKDSN 1,5/7	1869114	91	SMSTB 2,5/8-ST	1768448	268	SMSTBA 2,5/16-G	1769942	319	SPT 1,5/14-H-10,0-ZB	1735781	467
SMKDSN 1,5/7-5,08	1869266	91	SMSTB 2,5/8-ST-5,08	1826348	268	SMSTBA 2,5/16-G-5,08	1767517	319	SPT 1,5/14-V-10,0-ZB	1735875	469
SMKDSN 1,5/8	1869127	91	SMSTB 2,5/8-STF	1970935	269	SPB 5-GMKDS 3	1301203	833	SPT 1,5/16-V-10,0-ZBV GN	1775356	469
SMKDSN 1,5/8-5,08	1869279	91	SMSTB 2,5/8-STF-5,08	1971125	269	SPB 5-MKDS 3	1301216	833	SPT 1,5/16-H-10,0-ZB	1735794	467
SMKDSN 1,5/9	1869130	91	SMSTB 2,5/9-G	1769308	318	SPB 10-MKDS 3	1301355	833	SPT 1,5/16-V-10,0-ZB	1735888	469
SMKDSN 1,5/9-5,08	1869282	91	SMSTB 2,5/9-G-5,08	1769531	318	SPC 16/2-ST-10,16	1711268	562	SPT 1,5/16-H-10,0-ZB	1735804	467
SMKDSN 1,5/10	1869143	91	SMSTB 2,5/9-ST	1768820	268	SPC 16/2-STF-10,16	1711378	563	SPT 1,5/1		

Type	Order No.	Page	Type	Order No.	Page	Type	Order No.	Page	Type	Order No.	Page
SPT 16/ 9-H-10.0-ZB	1735859	467	SPT-THR 1,5/2-V-3,81 P20 R24	1823308	79	SPT-THR 1,5/ 7-V-3,81 P20 R44	1823353	79	SPT-THR 1,5/12-V-3,81 P20 R72	1823405	79
SPT 16/ 9-V-10.0-ZB	1735943	469	SPT-THR 1,5/ 2-V-3,81 P26	1822422	79	SPT-THR 1,5/ 7-V-3,81 P26	1822477	79	SPT-THR 1,5/12-V-3,81 P26	1822529	79
SPT 2,5/ 2-H-5,0-EX	1990973	143	SPT-THR 1,5/ 2-V-5,0 P20 R24	1823418	81	SPT-THR 1,5/ 7-V-5,0 P20 R56	1823463	81	SPT-THR 1,5/12-V-5,0 P20 R88	1823515	81
SPT 2,5/ 2-H-5,0-EX	1732386	163	SPT-THR 1,5/ 2-V-5,0 P26	1822532	81	SPT-THR 1,5/ 7-V-5,0 P26	1822587	81	SPT-THR 1,5/12-V-5,0 P26	1822639	81
SPT 2,5/ 2-V-5,0	1991095	143	SPT-THR 1,5/ 2-V-5,08 P20 R24	1823528	81	SPT-THR 1,5/ 7-V-5,08 P20 R56	1823573	81	SPT-THR 1,5/12-V-5,08 P20 R88	1823625	81
SPT 2,5/ 2-V-5,0-EX	1732496	163	SPT-THR 1,5/ 2-V-5,08 P26	1822642	81	SPT-THR 1,5/ 7-V-5,08 P26	1822697	81	SPT-THR 1,5/12-V-5,08 P26	1822749	81
SPT 2,5/ 3-H-5,0	1990986	143	SPT-THR 1,5/ 3-H-3,5 P20 R32	1823641	79	SPT-THR 1,5/ 8-H-3,5 P20 R44	1823696	79	SPTA 1,5/ 2-3,81	1751477	139
SPT 2,5/ 3-H-5,0-EX	1732399	163	SPT-THR 1,5/ 3-H-3,5 P26	1822765	78	SPT-THR 1,5/ 8-H-3,5 P26	1822817	78	SPTA 1,5/ 2-5,08	1751163	139
SPT 2,5/ 3-V-5,0	1991105	143	SPT-THR 1,5/ 3-H-3,81 P20 R32	1823751	79	SPT-THR 1,5/ 8-H-3,81 P20 R44	1823803	79	SPTA 1,5/ 3-3,81	1751480	139
SPT 2,5/ 3-V-5,0-EX	1732506	163	SPT-THR 1,5/ 3-H-3,81 P26	1822875	78	SPT-THR 1,5/ 8-H-3,81 P26	1822927	78	SPTA 1,5/ 3-5,08	1744442	139
SPT 2,5/ 4-H-5,0	1990999	143	SPT-THR 1,5/ 3-H-5,0 P20 R32	1823861	81	SPT-THR 1,5/ 8-H-5,0 P20 R56	1823913	81	SPTA 1,5/ 4-3,81	1751493	139
SPT 2,5/ 4-H-5,0-EX	1732409	163	SPT-THR 1,5/ 3-H-5,0 P26	1822985	80	SPT-THR 1,5/ 8-H-5,0 P26	1823036	80	SPTA 1,5/ 4-5,08	1751189	139
SPT 2,5/ 4-V-5,0	1991118	143	SPT-THR 1,5/ 3-H-5,08 P20 R32	1823971	81	SPT-THR 1,5/ 8-H-5,08 P20 R56	1824022	81	SPTA 1,5/ 5-3,81	1751503	139
SPT 2,5/ 4-V-5,0-EX	1732519	163	SPT-THR 1,5/ 3-H-5,08 P26	1823094	80	SPT-THR 1,5/ 8-H-5,08 P26	1823146	80	SPTA 1,5/ 5-5,08	1751192	139
SPT 2,5/ 5-H-5,0	1991008	143	SPT-THR 1,5/ 3-V-3,5 P20 R24	1823201	79	SPT-THR 1,5/ 8-V-3,5 P20 R72	1823256	79	SPTA 1,5/ 6-3,81	1751516	139
SPT 2,5/ 5-H-5,0-EX	1732412	163	SPT-THR 1,5/ 3-V-3,5 P26	1822325	79	SPT-THR 1,5/ 8-V-3,5 P26	1822370	79	SPTA 1,5/ 6-5,08	1751202	139
SPT 2,5/ 5-V-5,0	1991121	143	SPT-THR 1,5/ 3-V-3,81 P20 R24	1823311	79	SPT-THR 1,5/ 8-V-3,81 P20 R72	1823366	79	SPTA 1,5/ 7-3,81	1743184	139
SPT 2,5/ 5-V-5,0-EX	1732522	163	SPT-THR 1,5/ 3-V-3,81 P26	1822435	79	SPT-THR 1,5/ 8-V-3,81 P26	1822480	79	SPTA 1,5/ 7-5,08	1751215	139
SPT 2,5/ 6-H-5,0	1991011	143	SPT-THR 1,5/ 3-V-5,0 P20 R32	1823421	81	SPT-THR 1,5/ 8-V-5,0 P20 R88	1823476	81	SPTA 1,5/ 8-3,81	1751529	139
SPT 2,5/ 6-H-5,0-EX	1732425	163	SPT-THR 1,5/ 3-V-5,0 P26	1822545	81	SPT-THR 1,5/ 8-V-5,0 P26	1822590	81	SPTA 1,5/ 8-5,08	1751228	139
SPT 2,5/ 6-V-5,0	1991134	143	SPT-THR 1,5/ 3-V-5,08 P20 R32	1823531	81	SPT-THR 1,5/ 8-V-5,08 P20 R88	1823586	81	SPTA 1,5/ 9-3,81	1751532	139
SPT 2,5/ 6-V-5,0-EX	1732535	163	SPT-THR 1,5/ 3-V-5,08 P26	1822655	81	SPT-THR 1,5/ 8-V-5,08 P26	1822707	81	SPTA 1,5/ 9-5,08	1751231	139
SPT 2,5/ 7-H-5,0	1991024	143	SPT-THR 1,5/ 4-H-3,5 P20 R32	1823654	79	SPT-THR 1,5/ 9-H-3,5 P20 R72	1823706	79	SPTA 1,5/ 10-3,81	1751545	139
SPT 2,5/ 7-H-5,0-EX	1732438	163	SPT-THR 1,5/ 4-H-3,5 P26	1822778	78	SPT-THR 1,5/ 9-H-3,5 P26	1822820	78	SPTA 1,5/ 10-5,08	1751244	139
SPT 2,5/ 7-V-5,0	1991147	143	SPT-THR 1,5/ 4-H-3,81 P20 R32	1823764	79	SPT-THR 1,5/ 9-H-3,81 P20 R72	1823816	79	SPTA 1,5/ 11-3,81	1743197	139
SPT 2,5/ 7-V-5,0-EX	1732548	163	SPT-THR 1,5/ 4-H-3,81 P26	1822898	78	SPT-THR 1,5/ 9-H-3,81 P26	1822930	78	SPTA 1,5/ 11-5,08	1751257	139
SPT 2,5/ 8-H-5,0	1991037	143	SPT-THR 1,5/ 4-H-5,0 P20 R32	1823874	81	SPT-THR 1,5/ 9-H-5,0 P20 R88	1823926	81	SPTA 1,5/ 12-3,81	1751558	139
SPT 2,5/ 8-H-5,0-EX	1732441	163	SPT-THR 1,5/ 4-H-5,0 P26	1822998	80	SPT-THR 1,5/ 9-H-5,0 P26	1823049	80	SPTA 1,5/ 12-5,08	1751464	139
SPT 2,5/ 8-V-5,0	1991150	143	SPT-THR 1,5/ 4-H-5,08 P20 R32	1823984	81	SPT-THR 1,5/ 9-H-5,08 P20 R88	1824035	81	SPTA 1/ 2-3,5	1752104	137
SPT 2,5/ 8-V-5,0-EX	1732551	163	SPT-THR 1,5/ 4-H-5,08 P26	1823104	80	SPT-THR 1,5/ 9-H-5,08 P26	1823159	80	SPTA 1/ 2-5,0	1752214	137
SPT 2,5/ 9-H-5,0	1991040	143	SPT-THR 1,5/ 4-V-3,5 P20 R44	1823214	79	SPT-THR 1,5/ 9-V-3,5 P20 R72	1823269	79	SPTA 1/ 3-3,5	1752117	137
SPT 2,5/ 9-H-5,0-EX	1732454	163	SPT-THR 1,5/ 4-V-3,5 P26	1822338	79	SPT-THR 1,5/ 9-V-3,5 P26	1822383	79	SPTA 1/ 3-5,0	1752227	137
SPT 2,5/ 9-V-5,0	1991163	143	SPT-THR 1,5/ 4-V-3,81 P20 R44	1823324	79	SPT-THR 1,5/ 9-V-3,81 P20 R72	1823379	79	SPTA 1/ 4-3,5	1752120	137
SPT 2,5/ 9-V-5,0-EX	1732564	163	SPT-THR 1,5/ 4-V-3,81 P26	1822448	79	SPT-THR 1,5/ 9-V-3,81 P26	1822493	79	SPTA 1/ 4-5,0	1752230	137
SPT 2,5/ 10-H-5,0	1991053	143	SPT-THR 1,5/ 4-V-5,0 P20 R56	1823434	81	SPT-THR 1,5/ 9-V-5,0 P20 R88	1823489	81	SPTA 1/ 5-3,5	1752133	137
SPT 2,5/ 10-H-5,0-EX	1732467	163	SPT-THR 1,5/ 4-V-5,0 P26	1822558	81	SPT-THR 1,5/ 9-V-5,0 P26	1822600	81	SPTA 1/ 5-5,0	1752243	137
SPT 2,5/ 10-V-5,0	1991176	143	SPT-THR 1,5/ 4-V-5,08 P20 R56	1823544	81	SPT-THR 1,5/ 9-V-5,08 P20 R88	1823599	81	SPTA 1/ 6-3,5	1752146	137
SPT 2,5/ 10-V-5,0-EX	1732577	163	SPT-THR 1,5/ 4-V-5,08 P26	1822668	81	SPT-THR 1,5/ 9-V-5,08 P26	1822710	81	SPTA 1/ 6-5,0	1752256	137
SPT 2,5/ 11-H-5,0	1991066	143	SPT-THR 1,5/ 5-H-3,5 P20 R32	1823667	79	SPT-THR 1,5/ 10-H-3,5 P20 R72	1823719	79	SPTA 1/ 7-3,5	1752159	137
SPT 2,5/ 11-H-5,0-EX	1732470	163	SPT-THR 1,5/ 5-H-3,5 P26	1822781	78	SPT-THR 1,5/ 10-H-3,5 P26	1822833	78	SPTA 1/ 7-5,0	1752269	137
SPT 2,5/ 11-V-5,0	1991189	143	SPT-THR 1,5/ 5-H-3,81 P20 R32	1823777	79	SPT-THR 1,5/ 10-H-3,81 P20 R72	1823829	79	SPTA 1/ 8-3,5	1752162	137
SPT 2,5/ 11-V-5,0-EX	1732580	163	SPT-THR 1,5/ 5-H-3,81 P26	1822891	78	SPT-THR 1,5/ 10-H-3,81 P26	1822943	78	SPTA 1/ 8-5,0	1752272	137
SPT 2,5/ 12-H-5,0	1991079	143	SPT-THR 1,5/ 5-H-5,0 P20 R56	1823887	81	SPT-THR 1,5/ 10-H-5,0 P20 R88	1823939	81	SPTA 1/ 9-3,5	1752175	137
SPT 2,5/ 12-H-5,0-EX	1732483	163	SPT-THR 1,5/ 5-H-5,0 P26	1823007	80	SPT-THR 1,5/ 10-H-5,0 P26	1823052	80	SPTA 1/ 9-5,0	1752285	137
SPT 2,5/ 12-V-5,0	1991192	143	SPT-THR 1,5/ 5-H-5,08 P20 R56	1823997	81	SPT-THR 1,5/ 10-H-5,08 P20 R88	1824048	81	SPTA 1/ 10-3,5	1752188	137
SPT 2,5/ 12-V-5,0-EX	1732593	163	SPT-THR 1,5/ 5-H-5,08 P26	1823117	80	SPT-THR 1,5/ 10-H-5,08 P26	1823162	80	SPTA 1/ 10-5,0	1752298	137
SPT 5/ 1-H-7,5	1719189	463	SPT-THR 1,5/ 5-V-3,5 P20 R44	1823227	79	SPT-THR 1,5/ 10-V-3,5 P20 R72	1823272	79	SPTA 1/ 11-3,5	1752191	137
SPT 5/ 1-V-7,5	1719309	465	SPT-THR 1,5/ 5-V-3,5 P26	1822341	79	SPT-THR 1,5/ 10-V-3,5 P26	1822396	79	SPTA 1/ 11-5,0	1752308	137
SPT 5/ 2-H-7,5-ZB	1719192	463	SPT-THR 1,5/ 5-V-3,81 P20 R44	1823337	79	SPT-THR 1,5/ 10-V-3,81 P20 R72	1823382	79	SPTA 1/ 12-3,5	1752201	137
SPT 5/ 2-V-7,5-ZB	1719312	465	SPT-THR 1,5/ 5-V-3,81 P26	1822451	79	SPT-THR 1,5/ 10-V-3,81 P26	1822503	79	SPTA 1/ 12-5,0	1752311	137
SPT 5/ 3-H-7,5-ZB	1719202	463	SPT-THR 1,5/ 5-V-5,0 P20 R56	1823447	81	SPT-THR 1,5/ 10-V-5,0 P20 R88	1823492	81	SS-ZB WH	3190438	827
SPT 5/ 3-V-7,5-ZB	1719325	465	SPT-THR 1,5/ 5-V-5,0 P26	1822561	81	SPT-THR 1,5/ 10-V-5,0 P26	1822613	81	SS-ZB YE	5031650	754
SPT 5/ 4-H-7,5-ZB	1719215	463	SPT-THR 1,5/ 5-V-5,08 P20 R56	1823557	81	SPT-THR 1,5/ 10-V-5,08 P20 R88	1823609	81	ST-MKDSP 3/5	1718207	832
SPT 5/ 4-V-7,5-ZB	1719338	465	SPT-THR 1,5/ 5-V-5,08 P26	1822671	81	SPT-THR 1,5/ 10-V-5,08 P26	1822723	81	STG-MTN 0,5-1,0	3190438	827
SPT 5/ 5-H-7,5-ZB	1719228	463	SPT-THR 1,5/ 6-H-3,5 P20 R44	1823670	79	SPT-THR 1,5/ 11-H-3,5 P20 R72	1823722	79	STG-MTN 0,5-1,0 BA	3190629	827
SPT 5/ 5-V-7,5-ZB	1719341	465	SPT-THR 1,5/ 6-H-3,5 P26	1822794	78	SPT-THR 1,5/ 11-H-3,5 P26	1822846	78	STG-MTN 1,5-2,5	3190506	827
SPT 5/ 6-H-7,5-ZB	1719231	463	SPT-THR 1,5/ 6-H-3,81 P20 R44	1823780	79	SPT-THR 1,5/ 11-H-3,81 P20 R72	1823832	79	STG-MTN 1,5-2,5 BAND	3190632	827
SPT 5/ 6-V-7,5-ZB	1719354	465	SPT-THR 1,5/ 6-H-3,81 P26	1822901	78	SPT-THR 1,5/ 11-H-3,81 P26	1822956	78	STZ 2-MSTBC-5,08	1810529	828
SPT 5/ 7-H-7,5-ZB	1719244	463	SPT-THR 1,5/ 6-H-5,0 P20 R56	1823890	81	SPT-THR 1,5/ 11-H-5,0 P20 R88	1823942	81	STZ 2-PCC 4-7,62	1840214	828
SPT 5/ 7-V-7,5-ZB	1719367	465	SPT-THR 1,5/ 6-H-5,0 P26	1823010	80	SPT-THR 1,5/ 11-H-5,0 P26	1823065	80	STZ 3-PCC 4-7,62	1840227	828
SPT 5/ 8-H-7,5-ZB	1719257	463	SPT-THR 1,5/ 6-H-5,08 P20 R56	1824006	81	SPT-THR 1,5/ 11-H-5,08 P20 R88	1824051	81	STZ 4-MSTBC-5,08	1810532	828
SPT 5/ 8-V-7,5-ZB	1719370	465	SPT-THR 1,5/ 6-H-5,08 P26	1823120	80	SPT-THR 1,5/ 11-V-3,81 P26	1823175	80	STZ 5-PCC 4-7,62 GN	1842005	828
SPT 5/ 9-H-7,5-ZB	1719260	463	SPT-THR 1,5/ 6-V-3,5 P20 R44	1823230	79	SPT-THR 1,5/ 11-V-3,5 P20 R72	1823285	79	STZ 8-FKC-5,08	1876880	837
SPT 5/ 9-V-7,5-ZB	1719383	465	SPT-THR 1,5/ 6-V-3,5 P26	1822354	79	SPT-THR 1,5/ 11-V-3,5 P26	1822406	79	STZ 8-MSTBC-5,08	1810516	828
SPT 5/ 10-H-7,5-ZB	1719273	463	SPT-THR 1,5/ 6-V-3,81 P20 R44	1823340	79	SPT-THR 1,5/ 11-V-3,81 P20 R72	1823395	79	STZ 8-PCC 4-7,62	1840230	828
SPT 5/ 10-V-7,5-ZB	1719396	465	SPT-THR 1,5/ 6-V-3,81 P26	1822464	79	SPT-THR 1,5/ 11-V-3,81 P26	1822516	79	STZ 12-MSTBC-5,08	1810503	828
S											

Index

Alphabetical

Type	Order No.	Page	Type	Order No.	Page	Type	Order No.	Page	Type	Order No.	Page
TFKC 2,5/ 4-ST-5,08	1962626	284	TMSTBP 2,5/ 9-STF-5,08	1853175	271	TVMSTB 2,5/ 7-ST-5,08	1719053	271	UM-ALU 4 FOOT	2200974	744
TFKC 2,5/ 4-STF-5,08	1962710	285	TMSTBP 2,5/10-ST-5,08	1853094	270	TVMSTB 2,5/ 7-STF-5,08	1719147	271	UM-ALU 4 LID45 PA BK	2200971	745
TFKC 2,5/ 5-ST-5,08	1962639	284	TMSTBP 2,5/10-STF-5,08	1853188	271	TVMSTB 2,5/ 8-ST-5,08	1719066	271	UM-ALU 4 LID75 PA BK	2200972	744
TFKC 2,5/ 5-ST-5,08 AU	1965461	284	TPC 16/ 2-ST-10,16	1715170	556	TVMSTB 2,5/ 8-STF-5,08	1719150	271	UM-ALU 4 PE CONTACT	2200973	744
TFKC 2,5/ 5-STF-5,08	1962723	285	TPC 16/ 2-STF-10,16	1715251	557	TVMSTB 2,5/ 9-ST-5,08	1719079	271	UM-ALU 4-100,5 COVER AL	2200951	744
TFKC 2,5/ 5-STF-5,08 AU	1962590	285	TPC 16/ 3-ST-10,16	1715183	556	TVMSTB 2,5/ 9-STF-5,08	1719163	271	UM-ALU 4-100,5 COVER PA BK	2200952	744
TFKC 2,5/ 6-ST-5,08	1962642	284	TPC 16/ 3-STF-10,16	1715264	557	TVMSTB 2,5/10-ST-5,08	1719082	271	UM-ALU 4-100,5 FRONT 130	2200946	744
TFKC 2,5/ 6-STF-5,08	1962736	285	TPC 16/ 4-ST-10,16	1715196	556	TVMSTB 2,5/10-STF-5,08	1719176	271	UM-ALU 4-100,5 FRONT 165	2200947	744
TFKC 2,5/ 7-ST-5,08	1962655	284	TPC 16/ 4-STF-10,16	1715277	557				UM-ALU 4-100,5 FRONT 200	2200948	744
TFKC 2,5/ 7-STF-5,08	1962749	285	TPC 16/ 5-ST-10,16	1715206	556				UM-ALU 4-100,5 FRONT 235	2200949	744
TFKC 2,5/ 7-STF-5,08 AU	1765748	285	TPC 16/ 5-STF-10,16	1715280	557				UM-ALU 4-100,5 FRONT 42,5	2200943	744
TFKC 2,5/ 8-ST-5,08	1962668	284	TPC 16/ 6-ST-10,16	1715219	556				UM-ALU 4-100,5 FRONT 60	2200944	744
TFKC 2,5/ 8-STF-5,08	1962752	285	TPC 16/ 6-STF-10,16	1715293	557				UM-ALU 4-100,5 FRONT 95	2200945	744
TFKC 2,5/ 8-STF-5,08 AU	1710272	285	TPC 16/ 7-ST-10,16	1715222	556	UEG 20	2790211	722	UM-ALU 4-100,5 FRONT 990	2200950	744
TFKC 2,5/ 9-ST-5,08	1962671	284	TPC 16/ 7-STF-10,16	1715303	557	UEG 20-FS/FS	2790266	723	UM-ALU 4-100,5 PROFILE 130	2200938	744
TFKC 2,5/ 9-STF-5,08	1962765	285	TPC 16/ 8-ST-10,16	1715235	556	UEG 30/1	2790871	723	UM-ALU 4-100,5 PROFILE 165	2200939	744
						UEG 30/1-FS/FS	2790884	723			
TFKC 2,5/10-ST-5,08	1962684	284	TPC 16/ 8-STF-10,16	1715316	557	UEG 30/2	2790240	723	UM-ALU 4-100,5 PROFILE 200	2200940	744
TFKC 2,5/10-STF-5,08	1962778	285	TPC 16/ 9-ST-10,16	1715222	556	UEG 30/2-FS/FS	2790279	723	UM-ALU 4-100,5 PROFILE 235	2200941	744
TFMC 1,5/ 2-ST-3,5	1772618	202	TPC 16/ 9-STF-10,16	1715329	557	UEG-EU-BE	2956819	739	UM-ALU 4-100,5 PROFILE 42,5	2200935	744
TFMC 1,5/ 2-STF-3,5	1772702	203	TSPC 5/ 2-ST-7,62	1728455	532	UEG-EU-SE	2956822	739	UM-ALU 4-100,5 PROFILE 60	2200936	744
TFMC 1,5/ 3-ST-3,5	1772621	202	TSPC 5/ 2-STCL-7,62	1765418	533	UEG-EU-VS	5028883	739	UM-ALU 4-100,5 PROFILE 95	2200937	744
TFMC 1,5/ 3-STF-3,5	1772715	203	TSPC 5/ 2-ST06-5,33	1728206	533	UEG-MT-FS	2790389	724	UM-ALU 4-100,5 PROFILE 990	2200942	744
TFMC 1,5/ 4-ST-3,5	1772634	202	TSPC 5/ 3-ST-7,62	1728468	532	UEGH 22,5	2757102	726	UM-ALU 4-72 COVER AL	2200933	744
TFMC 1,5/ 4-STF-3,5	1772728	203	TSPC 5/ 3-STCL-7,62	1765421	533	UEGH 25	2757115	726	UM-ALU 4-72 COVER PA BK	2200934	744
TFMC 1,5/ 5-ST-3,5	1772647	202	TSPC 5/ 3-STF-7,62	1728219	533	UEGH 27,5-SMD	2757128	726	UM-ALU 4-72 FRONT 130	2200928	744
TFMC 1,5/ 5-STF-3,5	1772731	203	TSPC 5/ 4-ST-7,62	1728471	532	UEGH 40/1	2757144	727	UM-ALU 4-72 FRONT 165	2200929	744
TFMC 1,5/ 6-ST-3,5	1772650	202	TSPC 5/ 4-STCL-7,62	1765434	533	UEGH 40/2	2757131	727	UM-ALU 4-72 FRONT 200	2200930	744
TFMC 1,5/ 6-STF-3,5	1772744	203	TSPC 5/ 4-STF-7,62	1728222	533	UEGH 42,5/1-SMD	2757157	727	UM-ALU 4-72 FRONT 235	2200931	744
TFMC 1,5/ 7-ST-3,5	1772663	202	TSPC 5/ 5-ST-7,62	1728484	532	UEGH 42,5/2-SMD	2757160	727	UM-ALU 4-72 FRONT 42,5	2200925	744
TFMC 1,5/ 7-STF-3,5	1772757	203	TSPC 5/ 5-STCL-7,62	1765447	533	UEGH 45/2-SMD	2757173	727	UM-ALU 4-72 FRONT 60	2200926	744
TFMC 1,5/ 8-ST-3,5	1772676	202	TSPC 5/ 5-STF-7,62	1728235	533	UEGM 22,5	2792002	724	UM-ALU 4-72 FRONT 95	2200927	744
TFMC 1,5/ 8-STF-3,5	1772760	203	TSPC 5/ 6-ST-7,62	1728497	532	UEGM 22,5-FS/FS	2792073	725	UM-ALU 4-72 FRONT 990	2200932	744
TFMC 1,5/ 9-ST-3,5	1772689	202	TSPC 5/ 6-STCL-7,62	1765450	533	UEGM 25	2792015	724	UM-ALU 4-72 PROFILE 130	2200920	744
TFMC 1,5/ 9-STF-3,5	1772773	203	TSPC 5/ 6-STF-7,62	1728248	533	UEGM 25-FS/FS	2792086	725	UM-ALU 4-72 PROFILE 165	2200921	744
TFMC 1,5/10-ST-3,5	1772692	202	TSPC 5/ 7-ST-7,62	1728507	532	UEGM 27,5-SMD	2757063	724	UM-ALU 4-72 PROFILE 200	2200922	744
TFMC 1,5/10-STF-3,5	1772786	203	TSPC 5/ 7-STCL-7,62	1765463	533	UEGM 40/1	2792112	725	UM-ALU 4-72 PROFILE 235	2200923	744
THERMOMARK ROLL	5146477	820	TSPC 5/ 7-STF-7,62	1728251	533	UEGM 40/1-FS/FS	2792125	725	UM-ALU 4-72 PROFILE 42,5	2200917	744
THERMOMARK ROLL X1	5146723	821	TSPC 5/ 8-ST-7,62	1728510	532	UEGM 40/2	2792028	725	UM-ALU 4-72 PROFILE 60	2200918	744
THERMOMARK ROLL X1 CUTTER	5146765	821	TSPC 5/ 8-STCL-7,62	1765476	533	UEGM 40/2-FS/FS	2792099	725	UM-ALU 4-72 PROFILE 95	2200919	744
THERMOMARK ROLL X1 CUTTER/P	5146766	821	TSPC 5/ 8-STF-7,62	1728264	533	UEGM-MSTB	2781453	728	UM-ALU 4-72 PROFILE 990	2200924	744
THERMOMARK ROLL X1-CASE	5146724	821	TSPC 5/ 9-ST-7,62	1728523	532	UEGM-MSTB-BS	2781466	728	UM-ALU 6-161 MOUNT 150 GY	2201332	769
THERMOMARK ROLL-CUTTER	5146422	820	TSPC 5/ 9-STCL-7,62	1765489	533	UM -PROFIL	2952020	754	UM-ALU 6-161 MOUNT 200 GY	2201334	769
THERMOMARK ROLL-CUTTER/P	5146435	820	TSPC 5/ 9-STF-7,62	1728277	533	UM 25-PROFIL 100CM	2915795	754	UM-BASIC PROFILE	2200149	748
THERMOMARK ROLL-ERH	5146448	820	TSPC 5/10-ST-7,62	1728536	532	UM 25-SEK	2959298	754	UM-BE 16,5	2956903	762
THERMOMARK-ERH 500	5146309	820	TSPC 5/10-STCL-7,62	1765492	533	UM 25-SES	2959285	754	UM-BE 16,5-1	2958053	763
THERMOMARK-RIBBON 110	5145384	814	TSPC 5/10-STF-7,62	1728280	533	UM 25/45-FEO 200	2959434	754	UM-BE 35	2955577	762
THERMOMARK-RIBBON 110 BU	0829544	820	TSPC 5/11-ST-7,62	1728549	532	UM 45-PROFIL 100CM	2914550	755	UM-BE 35-1	2956657	763
THERMOMARK-RIBBON 110 GN	0829542	820	TSPC 5/11-STCL-7,62	1765502	533	UM 45-SE	2906131	755	UM-BEFE 35	2955564	762
THERMOMARK-RIBBON 110 RD	0829543	820	TSPC 5/11-STF-7,62	1728293	533	UM 45-SEAS	2907554	755	UM-BEFE 35-1	2956660	763
THERMOMARK-RIBBON 110-EML-HT0800342	810		TSPC 5/12-ST-7,62	1728552	532	UM 45-SEFE	2907826	755	UM-H	2955441	762
THERMOMARK-RIBBON 110-WMSU 0801358	820		TSPC 5/12-STCL-7,62	1765515	533	UM 45-SEFE O.N.	2959793	755	UM-PRO 108 COVER-L BK	2200155	749
THERMOMARK-RIBBON 110-WMSU WH0801359	820		TSPC 5/12-STF-7,62	1728303	533	UM 45-SEK	2959311	755	UM-PRO 108 COVER-R BK	2200156	749
THERMOMARK-RIBBON 110-WMTB HF5148007	821		TVFKC 1,5/ 2-ST	1713839	282	UM 45-SES	2959308	755	UM-PRO 108 FOOT BK	2200157	749
THERMOMARK-RIBBON 64-WMSU 0801360	820		TVFKC 1,5/ 3-ST	1713842	282	UM 72-FE	2959382	756	UM-PRO 122 COVER-L BK	2200158	749
THERMOMARK-RIBBON 64-WMSU WH0801361	820		TVFKC 1,5/ 4-ST	1713855	282	UM 72-LG 10	2959366	756	UM-PRO 122 COVER-R BK	2200159	749
TL CASE	0800613	820	TVFKC 1,5/ 5-ST	1713868	282	UM 72-PROFIL 100CM	2907583	756	UM-PRO 122 FOOT BK	2200160	749
TML (104X10)R	0801835	802	TVFKC 1,5/ 6-ST	1713871	282	UM 72-SE	2959337	756	UM-PRO 72 COVER-L BK	2200151	748
TML (104X2,8)R	0801832	802	TVFKC 1,5/ 7-ST	1713884	282	UM 72-SEFE/L	2959340	756	UM-PRO 72 COVER-R BK	2200152	748
TML (104X3,8)R	0801833	802	TVFKC 1,5/ 8-ST	1713897	282	UM 72-SEFE/R	2959353	756	UM-PRO 72 FOOT BK	2200153	748
TML (104X5)R	0801834	802	TVFKC 1,5/ 9-ST	1713907	282	UM 72-SEPEF/L	2906487	756	UM-PRO A/U 73 CM	2200311	748
TML (EX10)R	0801839	803	TVFKC 1,5/10-ST	1713910	282	UM-A/U 73-HT CM	2853310	762	UM-PRO A/U 92 CM	2200312	748
TML (EX2,8)R	0801836	803	TVFKCL 1,5/ 2-ST	1715921	283	UM-A/U CM	2854885	762	UM-PRO A/U N 73 CM	2200310	748
TML (EX3,8)R	0801837	803	TVFKCL 1,5/ 3-ST	1715934	283	UM-A/U N 73 CM	2706852	757	UM-PRO LID-73 BK	2200173	748
TML (EX5)R	0801838	803	TVFKCL 1,5/ 4-ST	1715947	283	UM-ALU 4 AU45 L130	2200957	745	UM-PRO LID-73N BK	2200174	748
TML (EX7)R	0803837	803	TVFKCL 1,5/ 5-ST	1715950	283	UM-ALU 4 AU45 L165	2200958	745	UM-PRO LID-92 BK	2200172	748
TMSTBP 2,5/ 4-ST-5,08	1853010	270	TVFKCL 1,5/ 6-ST	1715963	283	UM-ALU 4 AU45 L60	2200959	745	UM-PRO MOUNT BK	2200171	748
TMSTBP 2,5/ 2-STF-5,08	1853104	271	TVFKCL 1,5/ 7-ST	1715976	283	UM-ALU 4 AU45 L235	2200960	745	UM-PRO PCB C-LOCK L1 BK	2200164	748
TMSTBP 2,5/ 3-ST-5,08	1853023	270	TVFKCL 1,5/ 8-ST	1715989	283	UM-ALU 4 AU45 L25	2200953	745	UM-PRO PCB C-LOCK L2 BK	2200165	748
TMSTBP 2,5/ 3-STF-5,08	1853117	271	TVFKCL 1,5/ 9-ST	1715992	283	UM-ALU 4 AU45 L42,5	2200954	745	UM-PRO PCB C-LOCK L3 BK	2200166	748
TMSTBP 2,5/ 4-ST-5,08	1853036	270	TVFKCL 1,5/10-ST	1716001	283	UM-ALU 4 AU45 L60	2200955	745	UM-PRO PCB S-LOCK BK	2200168	748
TMSTBP 2,5/ 4-STF-5,08	1853120	271	TVMSTB 2,5/ 2-ST-5,08	1719008	271	UM-ALU 4 AU45 L95	2200956	745	UM-PRO PE CONTACT L1	2200161	748
TMSTBP 2,5/ 5-ST-5,08	1853049	270	TVMSTB 2,5/ 2-STF-5,08	1719095	271	UM-ALU 4 AU75 L130	2200966	745	UM-PRO PE CONTACT L2	2200162	748
TMSTBP 2,5/ 5-STF-5,08	1853133	271	TVMSTB 2,5/ 3-ST-5,08	1719011	271	UM-ALU 4 AU75 L165	2200967	745	UM-PRO PE CONTACT L3	2200163	748
TMSTBP 2,5/ 6-ST-5,08	1853052	270	TVMSTB 2,5/ 3-STF-5,08	1719105	271	UM-ALU 4 AU75 L200	2200968	745	UM-PRO PROFILE	2200148	748
TMSTBP 2,5/ 6-STF-5,08	1853146	271	TVMSTB 2,5/ 4-ST-5,08	1719024	271	UM-ALU 4 AU75 L235	2200969	745	UM-SE	2955593	762
TMSTBP 2,5/ 7-ST-5,08	1853065	270	TVMSTB 2,5/ 4-STF-5,08	1719118	271	UM-ALU 4 AU75 L25	2200962	745	UM-SE 1	2958147	763
TMSTBP 2,5/ 7-STF-5,08	1853159	271	TVMSTB 2,5/ 5-ST-5,08	1719037	271	UM-ALU 4 AU75 L42,5	2200963	745	UM-SE-A60	2955616	762
TMSTBP 2,5/ 8-ST-5,08	1853078	270	TVMSTB 2,5/ 5-STF-5,08	1719121	271	UM-ALU 4 AU75 L60	2200964	745	UM-SE-A60-R	2956893	762
TMSTBP 2,5/ 8-STF-5,08	1853162	271	TVMSTB 2,5/ 6-ST-5,08	1719040	271	UM-ALU 4 AU75 L95	2200965	745	UM-SE-A73	2955603	762
TMSTBP 2,5/ 9-ST-5,08	1853081	270	TVMSTB 2,5/ 6-STF-5,08	1719134	271	UM-ALU 4 AU75 L90	2200970	745	UM-SE-A73-R	2956741	762

Table with 10 columns: Type, Order No., Page, Type, Order No., Page, Type, Order No., Page, Type, Order No., Page. It lists various product codes and their corresponding order numbers and page references, organized alphabetically by product type.

Index

Alphabetical

Type	Order No.	Page	Type	Order No.	Page	Type	Order No.	Page	Type	Order No.	Page
ZFKDSA 2,5-6,08 R-EX	1732153	161									
ZFKDSA 4-9	1907542	477									
ZFKKDS 1,5C-5,0	1889301	131									
ZFKKDS 2,5-5,08	1905023	135									
ZFKKDS 2,5-5,08 L	1905227	135									
ZFKKDSA 1,5C-5,0 L	1889275	131									
ZFKKDSA 1,5C-6,0 R	1889288	131									
ZFKKDSA 2,5-6,08 R	1905036	135									

