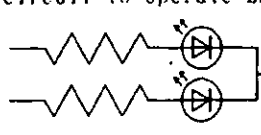
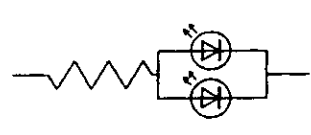

Approved	Checked	Designed	DEVELOPMENT SPECIFICATION							
<i>T. Shoda</i>	<i>M. W. J.</i>	<i>T. Takata</i>	P/N: LNJ411K84RU				TEMPORARY			
T	Y	P	E	Amber Light Emitting Diode						
APPLICATION			Indications							
MATERIAL			InGaAlP							
OUTLINE			Attached							
ABSOLUTE			P	*I _{FP}	I _{FDC}	V _R	Topr	Tsig		
MAXIMUM			55	60	20	4	-30~+85	-40~+100		
RATINGS			mW	mA	mA	V	°C	°C		
CONDITION			Ta=25±3°C							
Test Specification										
I	l	e	m	Symbol	Condition	Typ	Limit		Unit	
							Min	Max		
Forward Voltage				V _F	I _F =10mA	2.0		2.5	V	
Reverse Leakage Current				I _R	V _R =4V			100	μA	
Luminous Intensity				I _L	I _F =10mA DC	17	9.0		mcd	
Peak Emission Wavelength				λ _p	I _F =10mA DC	595			nm	
Spectral Line Half Width				Δλ	I _F =10mA DC	15			nm	
<p>*1. The Condition of I_{FP} is duty 10%. Pulse width 1ms</p> <p>*2. Tolerance of luminous intensity: ±20%.</p> <p>NOTE</p> <p>★1. Please contact the Panasonic local office if you design at low current (below 1mA DC) or pulse current operation and have any questions.</p> <p>★2. Soldering conditions----Refer to Handling note.</p> <p>★3. Compositions of the lead ----- Cu/Ni/Au plating</p> <p>★4. Beware of destruction by static electricity in handling the LED.</p> <p>★5. Circuit to operate LED.</p>										
									<p>(A) Recommended circuit.</p> <p>(B) The difference of brightness between the LED could be found due to the V_F characteristics of each LED.</p>	
Jul. 25. 2001										

Approved	Checked	Designed
<i>T. Ito</i>	<i>M. H.</i>	<i>T. Tabata</i>

DEVELOPMENT SPECIFICATION

P/N: LNJ411K84RU

TEMPORARY

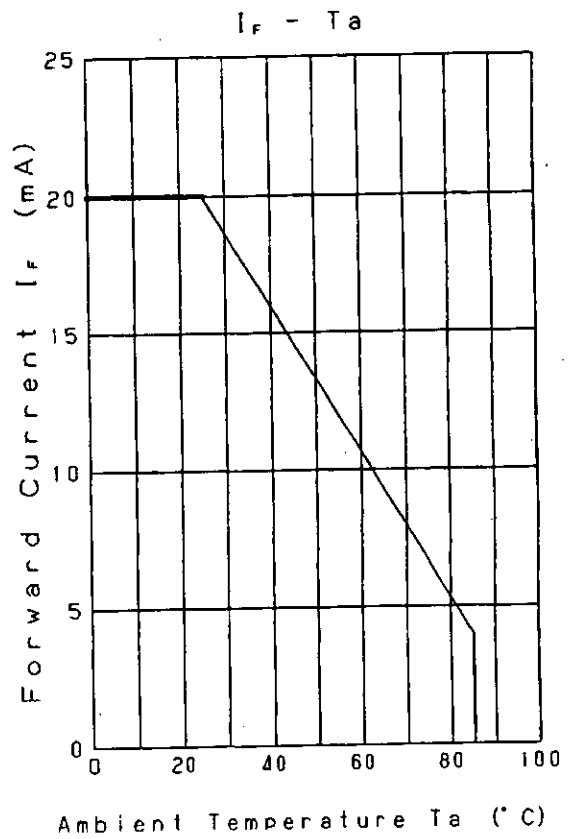
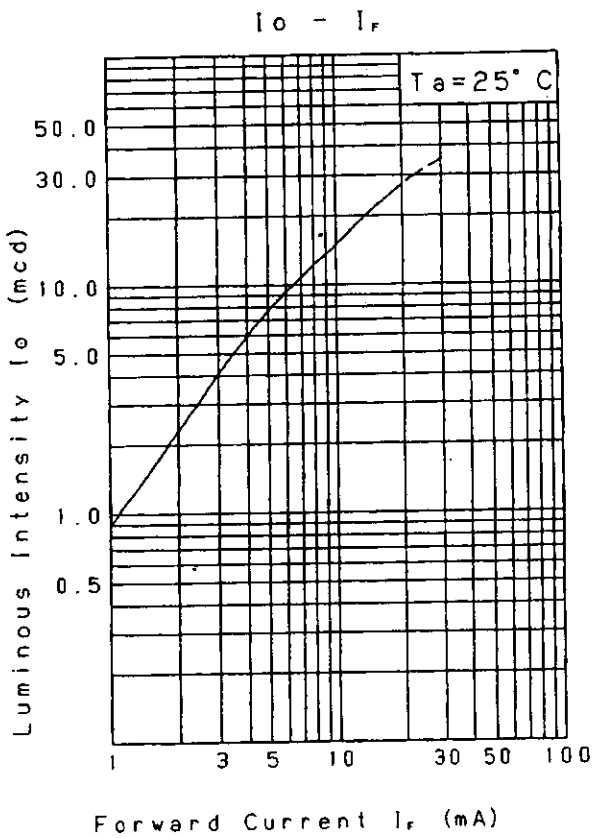
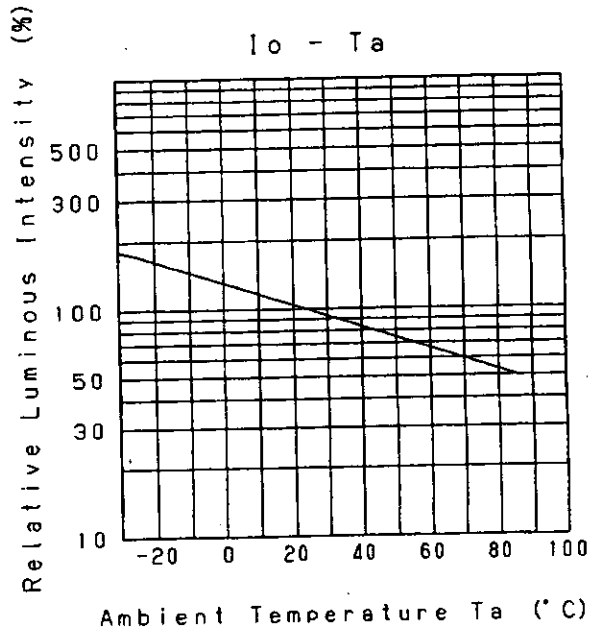
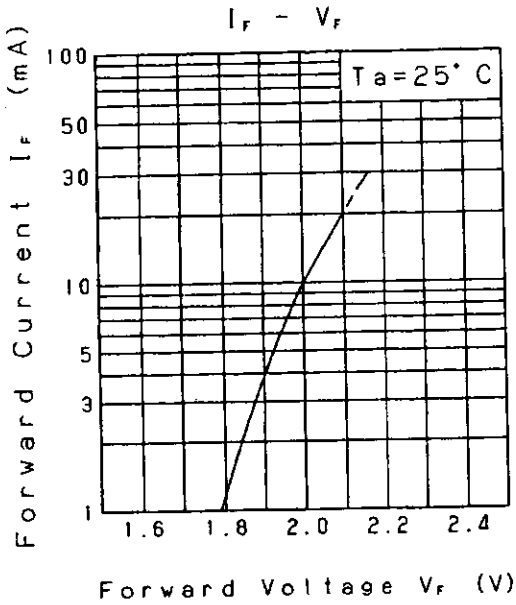

Jul. 25. 2001

Approved	Checked	Designed	DEVELOPMENT SPECIFICATION	TEMPORARY
<i>T. Shikata</i>	<i>M. Ichi</i>	<i>T. Takata</i>		

Relative Luminous Intensity
Wavelength Characteristics

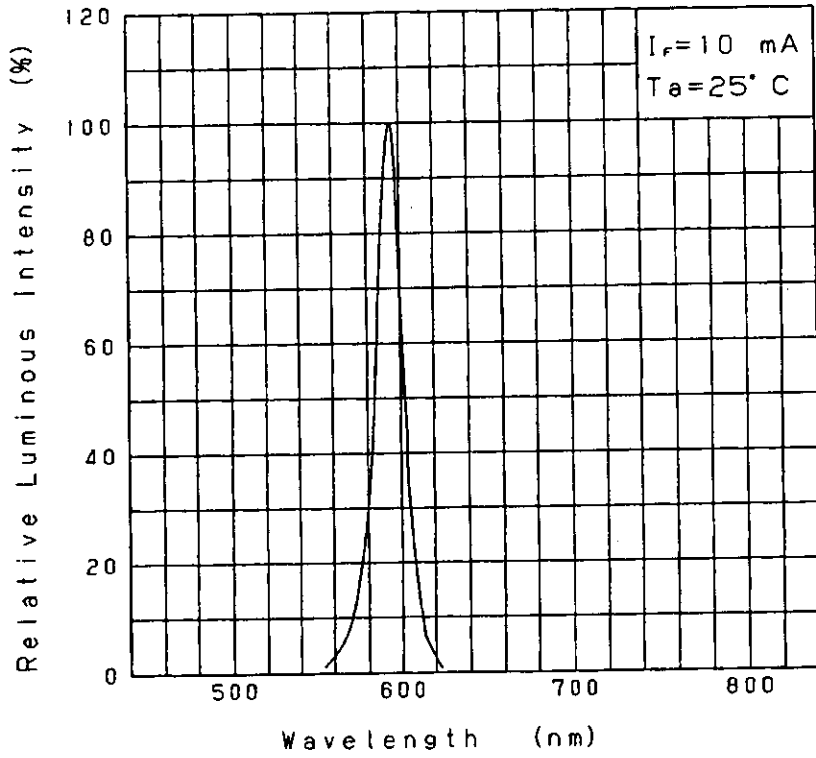

Directive Characteristics

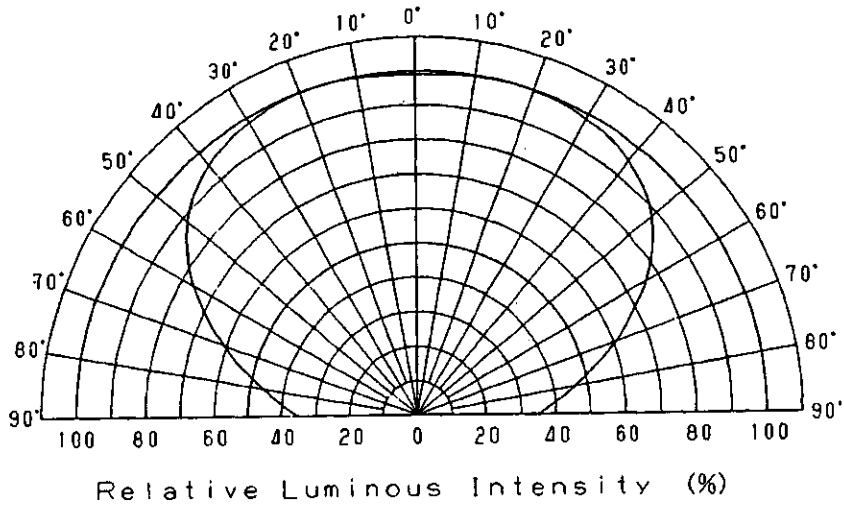

Apr. 20. 2001			
---------------	--	--	--

Approved	Checked	Designed	DEVELOPMENT SPECIFICATION (OUTLINE) P/N: LNJ411K84RU		
<i>T. Shuda</i>	<i>M. Ichi</i>	<i>T. Takata</i>			

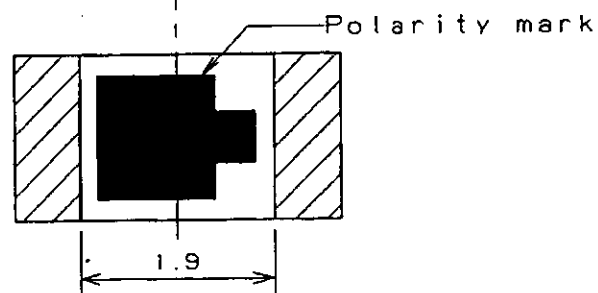
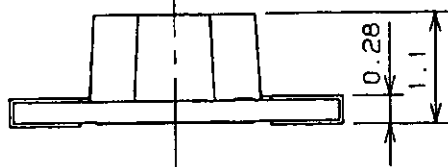
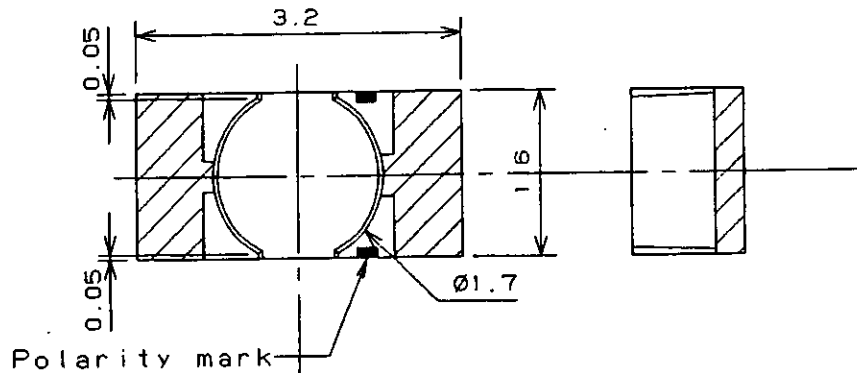

Recommended Land Layout

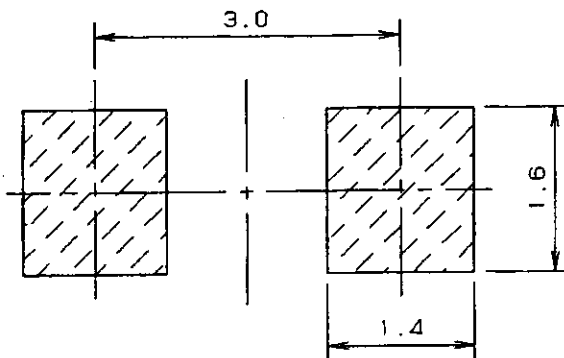

Polarity

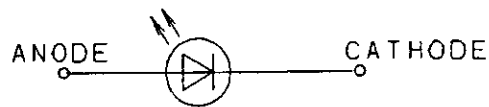

(NOTE)

1. Unit: mm
2. Tolerance unless specified is ± 0.15 .
3. indicate Au terminal.

Jul. 25, 2001			
---------------	--	--	--