

Preliminary

Messrs. _____

Shock Sensor Specification

Part No. : PSLE382E-R44

RoHS Compliant

Halogen-Free Compliant

16.Dec. 2010

Approved by _____ Kazuki Shimizu _____

Checked by _____ Yasuhiro Nakai _____

Issued by _____ Akira Oikawa _____

KYOCERA CORPORATION

1.Scope

This specification shall cover the characteristics of the shock sensor.

2.Kyocera's Type Name

PSLE382E-R44

3.Customer's Type Name**4.Electrical Characteristics**

Items	Specifications
4-1 Primary Axis Inclined Angle	25± 3degree
4-2 Capacitance	340 ± 160pF, at 1Vrms, 1kHz
4-3 Charge Sensitivity	0.09 ± 0.035 pC/G , under vibration at 200Hz, 2G
4-4 Insulation Resistance	0.5Gohm minimum, at 10VDC after 1min.
4-5 Resonant Frequency	44 ± 9kHz
4-6 Non-linearity	5% maximum, under vibration at 25G
(Referense only) Voltage Sensitivity	0.265mV/G ,under vibration at 200Hz, 2G

<Measurement Condition>

The reference temperature shall be 25 °C ±5°C.

5.Dimensions and Marking

Fig.1

6.Environmental Characteristics**Preliminary**

Items	Conditions
6-1.High Temperature Storage Test	Keep in a chamber at $85 \pm 2^{\circ}\text{C}$ for 1000 +12/-0 hours, and then keep at room temperature for 1 hour. The characteristics of shock sensor shall meet the specifications.
6-2.Low Temperature Storage Test	Keep in a chamber at $-40 \pm 2^{\circ}\text{C}$ for 1000 +12/-0 hours, and then keep at room temperature for 1 hour. The characteristics of shock sensor shall meet the specifications.
6-3.Moisture Resistance Test	Keep in a chamber at 90 to 95 % R.H. and $60 \pm 2^{\circ}\text{C}$ for 500 +12/-0 hours, and then keep at room temperature for 1 hour. The characteristics of shock sensor shall meet the specifications.
6-4.Temperature Cycling Test	Apply 100 thermal cycles with the following temperatures: <ul style="list-style-type: none"> - upper temperature 85°C for 20 minutes and transfer time 10 minutes - lower temperature -40°C for 20 minutes and transfer time 10 minutes - total cycle time is 1hour and then left at room temperature for 1 hour. The characteristics of shock sensor shall meet the specifications.
6-5.Mechanical Shock Test	After applying the acceleration at 29430m/sec^2 {3000G} in each of X, Y and Z axis (each 3 times). The characteristics of shock sensor shall meet the specifications.
6-6.Solderability Test	At first, being soaked in the Methanol solution containing Rosin for 5 seconds and then being dipped in a bath of Pb/Sn solder at $250 \pm 5^{\circ}\text{C}$ for 4 ± 0.5 seconds. The surface of the electrode terminal shall be soldered more than 95%.
6-7.Resistance to Soldering Heat Test	Pre-heat temperature is 150 to 180°C for 1 minute. High temperature is $250 \pm 5^{\circ}\text{C}$, over 200°C for 20 seconds max.(2times). Then keep at room temperature for 1 hour. The characteristics of shock sensor shall meet the specifications.
6-8.Board Flex Test	After soldered on the circuit board specified as below, then the load which cause 3 mm bend to the board is applied. The characteristics of shock sensor shall meet the specifications. The shock sensor cause no defect in the appearance. (Circuit Board: FR4, 100 x 40 x 1.6) <div style="text-align: center;"> </div>

<Measurement Condition>The reference temperature shall be $25^{\circ}\text{C} \pm 5^{\circ}\text{C}$.

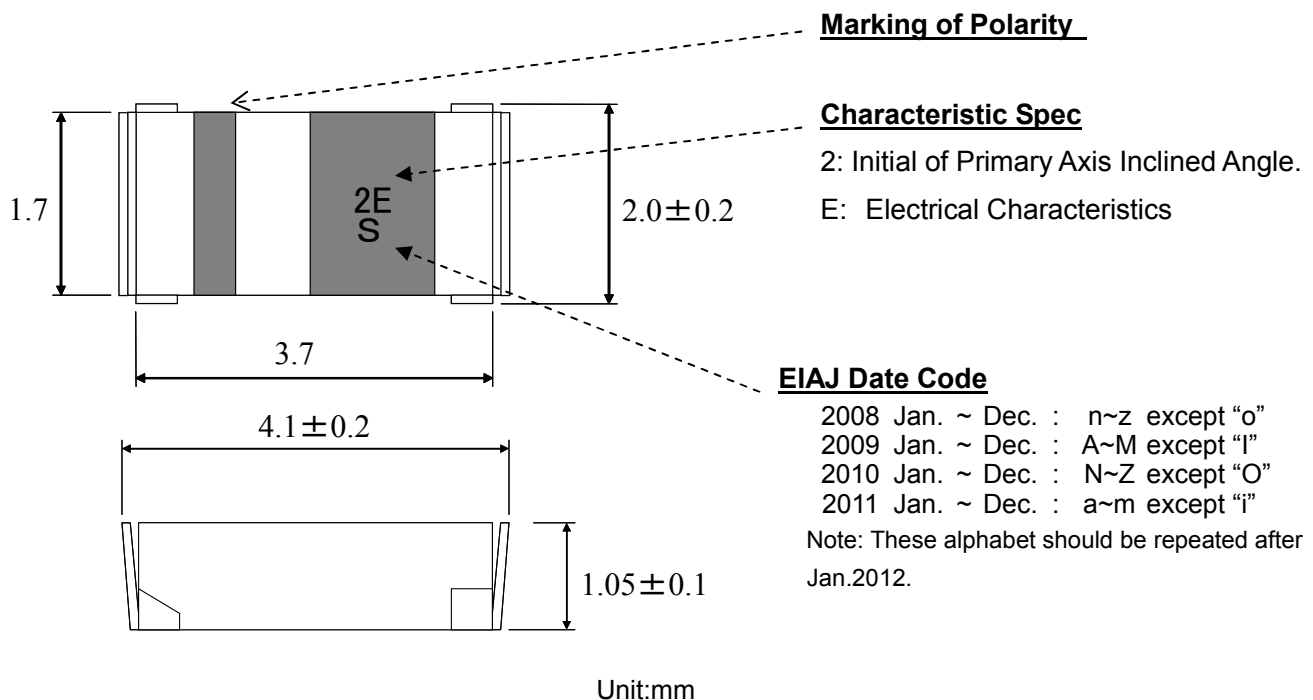
7. Recommended Land pattern

Preliminary

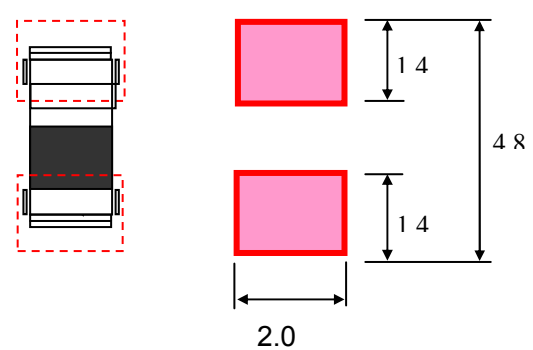

Unit: (mm)

Fig.2 Recommended Land pattern

8. Recommended Convection Reflow profile

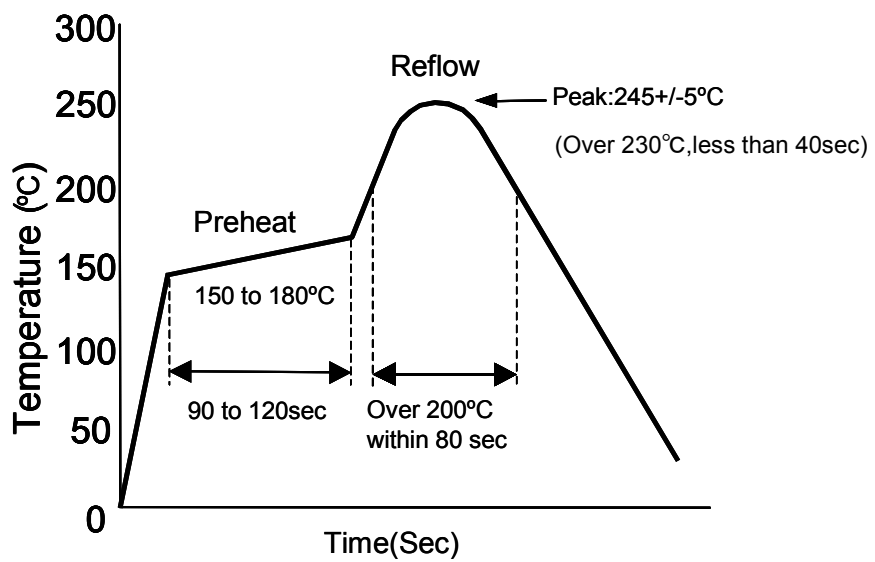
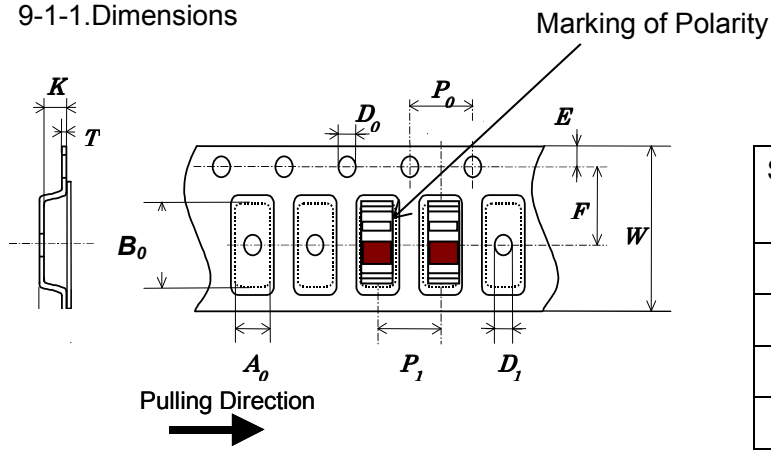

Fig.3 Recommended Convection Reflow profile

9. Taping Specifications

9-1. Carrier Tape

9-1-1. Dimensions



Unit: (mm)

Sym bol	Dimensions	Sym bol	Dimensions
A_0	2.25 ± 0.1	P_0	4.0 ± 0.1
B_0	4.4 ± 0.1	P_1	4.0 ± 0.1
W	$12.0 +0.3/-0.1$	D_0	$1.5 +0.1/-0$
E	1.75 ± 0.1	K	1.25 ± 0.1
F	5.5 ± 0.05	T	0.3 ± 0.05

Fig.4 Emboss Carrier Tape Dimensions

9-2. Taping

9-2-1. Taping Quantity

One reel of the carrier tape shall pack 3000 pcs. Shock sensor shall be contained in pocket continuously.

9-2-2. Dimensions

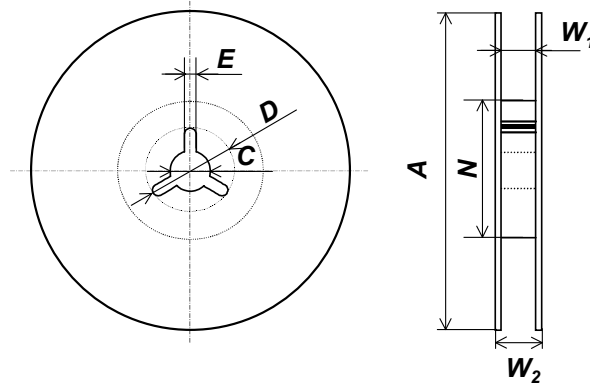

Fig.5 Reel

Unit: (mm)

Symbol	A	N	W₁	W₂
Dimensions	180±5.0	60min.	12.5 +2.0/-0.0	20.5 max.
Symbol	C	D	E	
Dimensions	13.0±0.2	21.0±0.8	2.0±0.5	

9-2-3. Leader and Blank Pocket

Package shall consist of leader, blank pocket and loaded pocket as follows. (fig.6)

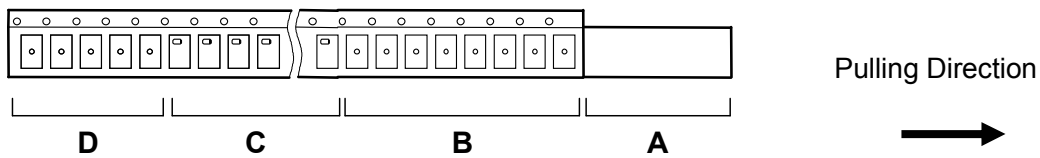

- A) Leader
- B) Blank Pocket (160mm Min.)
A+B: 400mm to 560mm
- C) Load Pocket
- D) Blank Pocket (40 to 190mm)

Fig.6 Packing Method

Peeling load of top tape shall be 0.1N {10gf} to 0.7N {70gf} from Carrier Tape.

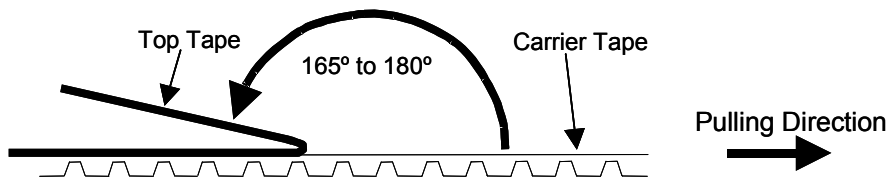

Fig.7 Peeling Strength

9-2-4. Reel label

A reel label shall be contained as below: (Based on EIAJ C-3 format)

- A) Customer P/N
- B) Lot No.
- C) Quantity
- D) Shipping date
- E) Vender Name

9-2-5. Exterior Package label

Shock sensor shall be packed properly to avoid defect in transportation and the marking of exterior package shall be contained as below:

- A) Name of Customer
- B) P/O No.
- C) Customer P/N
- D) Lot No.
- E) Quantity
- F) Shipping Date
- G) Vender Name

10. The agreement of this specifications

Should any part of the content of this specification become questionable, it shall be settled by mutual deliberations.

11. Remarks on Usage

- A) This part can use only reflow soldering.
- B) Not washable
- C) Maximum temperature is 280 degree.

12. RoHS Compliant

- A) Sensor Case: LCP(liquid crystal polymer)
- B) Terminal: Bronze with phosphate (thickness 100 um)
Plating: Cu(1-2um), Ag(1-3 um)
- C) Element: Piezo Ceramic, contains lead-oxide, however, piezo-electronic devices are exempted from RoHS compliant requirement of article 4(1).
(Refer to Annex, Section 7)

All materials meet to RoHS Compliant.

13. Halogen-Free Compliant

- A) Bromine (Br) <900ppm (0.09%)
- B) Chlorine (Cl) <900ppm (0.09%)
- C) Total concentration of Chlorine (Cl) + Bromine (Br) <1500ppm (0.15%)
- D) Antimony Trioxide (Sb₂O₃) <1000ppm (0.1%)
- E) Red Phosphorus <1000ppm (0.1%)

All materials meet to Halogen-Free Compliant.