



# ATPS19 Series Anti-Vandal Short-Body Sealed Pushbutton Switch

**NEW**

Pushbutton A

## Features/Benefits

- **Momentary**
- **IP67 sealed & IK10 (Stainless steel bushing)**
- **Rated at 2A / 36 Vdc**
- **1,000,000 mechanical lifecycles**
- **Various colors of LED illuminate indicator**
- **Choices of actuator with ring or power logo**
- **RoHS compliant**

## Typical Applications

- **Alarm, safety & security systems**
- **Intercom "push-to-talk" devices**
- **Automatic food & drink vending machines**
- **Parking lot ticket machines & ticket paying stations**
- **Industrial instruments**



## Specifications

FUNCTION: SPST  
CONTACT ARRANGEMENT: N.O.  
MOUNTING TYPE: Threaded front panel mount  
TORQUE FOR THREADED BODY: 11.5 kgf/cm

## Mechanical

MECHANICAL LIFE: 1,000,000 cycles  
TOTAL TRAVEL: 1.8 ± 0.2 mm  
OPERATING FORCE: 4.5 ± 1.5N

## Electrical

CONTACT RATING: 2A / 36Vdc  
ELECTRICAL LIFE: Make-and-break cycles at full load  
200,000  
DIELECTRIC STRENGTH: 2,000 V RMS @ sea level  
INSULATION RESISTANCE: 1,000 MΩ min. @ 500 VDC  
INITIAL CONTACT RESISTANCE : 50 mΩ max @1A 12VDC

## Materials

BUSHING: Stainless steel  
BASE: PA66, white (UL 94-V0)  
ACTUATOR: PC, translucent (UL 94-V2), std steel  
INTERNAL ASSEMBLY: PC, transparent (UL 94V2)  
SPRING: Steel  
SEALING / O-ring: Silicone (Translucent) / Silicone  
TERMINALS / CONTACT: Brass, gold flash plated / Brass, silver alloy  
HEX NUT: Brass (Nickel plated)

## Operating Environment

OPERATING TEMPERATURE: -20°C to +70°C  
SEALING / PROTECTION: IP67

**NOTE:** Specifications and materials listed above are for switches with standard options. For information on specific and custom switches, please contact Customer Service.

## Build-A-Switch

To order, simply select desired option from each category and place in the appropriate box.

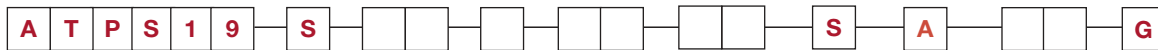

**Designation**  
ATPS19 Series

**Actuator Style**  
S Standard

**Actuator Indicator**  
L0 Without LED  
L1 Ring  
L5 Ring & Power logo

### LED Illumination

Color	Dual Color
0 Without LED	A Red & Green
2 White	B Red & Blue
3 Red	
5 Yellow	
6 Green	
7 Blue	

**LED Voltage DC**  
00 Without LED  
03 3V (47Ω with red/yellow LED)  
06 6V (180Ω)  
12 12V (470Ω)  
24 24V (1000Ω)

**Terminal Plating**  
G Gold flash

**Termination**  
04 Solder lug  
W1 Wire lead 500mm

**Mechanical Function**  
A Momentary

**Contact Arrangement**  
S SPST

### Bushing type

M0	Stainless (Natural), Round
M2	Stainless (Natural), D shape
M4	Stainless (Natural), Double D

**NEW**

# ATPS19 Series Anti-Vandal Short-Body Sealed Pushbutton Switch



**A**  
Pushbutton

## STANDARD VIEW

### STANDARD

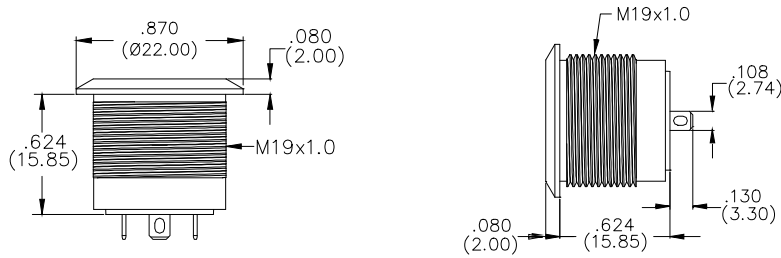

## ACTUATOR INDICATOR

### L0 WITHOUT LED

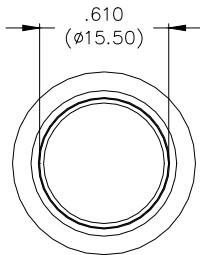

### L1 RING

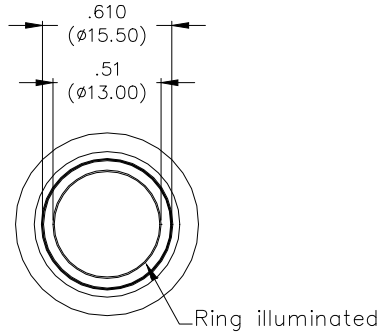

### L5 RING & POWER

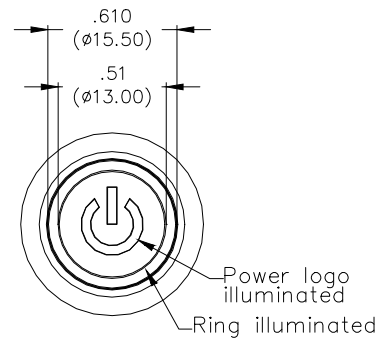

## CIRCUIT

### MOMENTARY

#### SINGLE COLOR LED

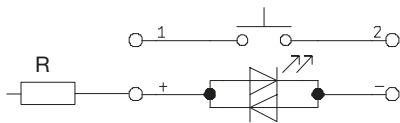

#### DUAL COLOR LED

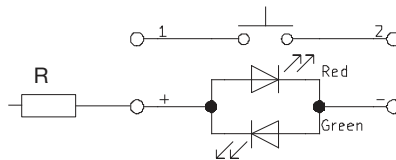

R: Resistor value is according to the LED voltage applied.

Resistor value (Apply LED Voltage)
LED input 3 VDC, 47 ohms (Red/Yellow LED type only)
LED input 6 VDC, 180 ohms
LED input 12 VDC, 470 ohms
LED input 24 VDC, 1000 ohms

Ohms value of resistance tolerance: ±5%



# ATPS19 Series

# Anti-Vandal Short-Body Sealed Pushbutton Switch

**NEW**

A  
Pushbutton

## TERMINATION

### 04 SOLDER LUG

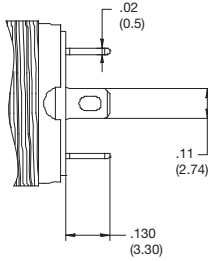

### W1 WIRE LEAD 500MM\* (Multi-wire lead AWG20, Section 0.6 mm<sup>2</sup>, UL approved)

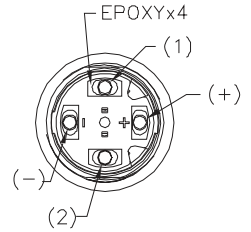
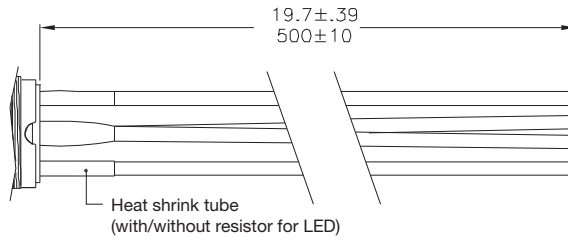

#### Non-LED

Description	Wire color
Terminal 1	Black
Terminal 2	Black

#### With LED

Description	Wire color
Terminal 1	Black
Terminal 2	Black
LED+	Red
LED-	Green

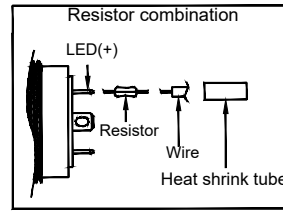

\* Special length, please consult your sales representative for details.

## PANEL CUTOUT

### M0

ROUND

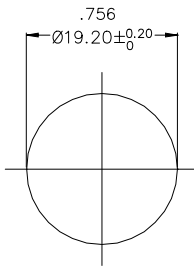

### M2

D SHAPE

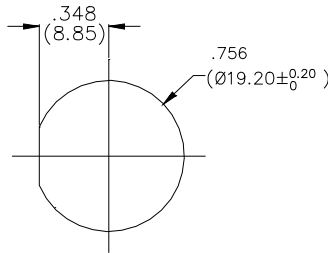

### M4

DOUBLE D

Thickness: 6.0mm (Max.)

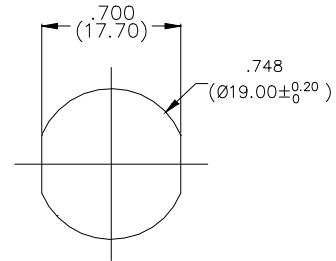

## HARDWARE

### HEX NUT

Order PN: ATP19-HN

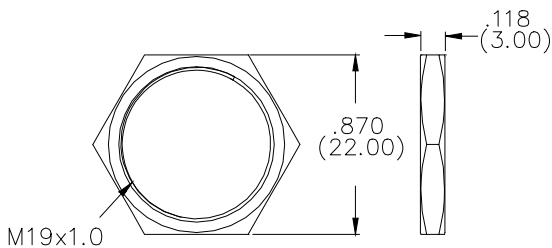

### O RING

Order PN: ATP19-OR

