



WSE27-3P1710

W27-3

COMPACT PHOTOELECTRIC SENSORS

SICK
Sensor Intelligence.



Illustration may differ



Ordering information

Type	Part no.
WSE27-3P1710	1028059

Other models and accessories → www.sick.com/W27-3

Detailed technical data

Features

Functional principle	Through-beam photoelectric sensor
Dimensions (W x H x D)	24.6 mm x 80.6 mm x 54 mm
Housing design (light emission)	Rectangular
Sensing range max.	0 m ... 35 m
Sensing range	0 m ... 25 m
Focus	Approx. 6°
Type of light	Infrared light
Light source	LED ¹⁾
Light spot size (distance)	Ø 3.7 m (25 m)
Angle of dispersion	Approx. 6°
Wave length	880 nm
Adjustment	None

¹⁾ Average service life: 100,000 h at T_J = +25 °C.

Mechanics/electronics

Supply voltage	10 V DC ... 30 V DC ¹⁾
-----------------------	-----------------------------------

- ¹⁾ Limit values when operated in short-circuit protected network: max. 8 A.
- ²⁾ May not exceed or fall below U_v tolerances.
- ³⁾ Without load.
- ⁴⁾ Signal transit time with resistive load.
- ⁵⁾ With light/dark ratio 1:1.
- ⁶⁾ Do not bend below 0 °C.
- ⁷⁾ A = V_S connections reverse-polarity protected.
- ⁸⁾ B = inputs and output reverse-polarity protected.
- ⁹⁾ C = interference suppression.
- ¹⁰⁾ Reference voltage: 50 V DC.

Ripple	< 5 V _{pp} ²⁾
Power consumption, sender	45 mA ³⁾
Power consumption, receiver	20 mA ³⁾
Switching output	PNP
Output function	Complementary
Switching mode	Light/dark switching
Signal voltage PNP HIGH/LOW	Approx. V _S – 2.5 V / 0 V
Output current I_{max.}	≤ 100 mA
Response time	≤ 500 μs ⁴⁾
Switching frequency	1,000 Hz ⁵⁾
Angle of reception	Approx. 3°
Connection type	Cable, 4-wire, 3 m ⁶⁾
Cable material	PVC
Circuit protection	A ⁷⁾ B ⁸⁾ C ⁹⁾
Protection class	II ¹⁰⁾
Weight	200 g
Housing material	Plastic, ABS
Optics material	Plastic, PMMA
Enclosure rating	IP66 IP67
Test input sender off	TE to 0 V
Ambient operating temperature	–40 °C ... +60 °C
Ambient temperature, storage	–40 °C ... +75 °C
UL File No.	NRKH.E181493 & NRKH7.E181493
Part number of individual components	2033699 WE27-3P1710 2033700 WS27-3D1710

1) Limit values when operated in short-circuit protected network: max. 8 A.

2) May not exceed or fall below U_v tolerances.

3) Without load.

4) Signal transit time with resistive load.

5) With light/dark ratio 1:1.

6) Do not bend below 0 °C.

7) A = V_S connections reverse-polarity protected.

8) B = inputs and output reverse-polarity protected.

9) C = interference suppression.

10) Reference voltage: 50 V DC.

Safety-related parameters

MTTF_D	996 years
DC_{avg}	0 %

Classifications

eCl@ss 5.0	27270901
eCl@ss 5.1.4	27270901

eCl@ss 6.0	27270901
eCl@ss 6.2	27270901
eCl@ss 7.0	27270901
eCl@ss 8.0	27270901
eCl@ss 8.1	27270901
eCl@ss 9.0	27270901
eCl@ss 10.0	27270901
eCl@ss 11.0	27270901
eCl@ss 12.0	27270901
ETIM 5.0	EC002716
ETIM 6.0	EC002716
ETIM 7.0	EC002716
ETIM 8.0	EC002716
UNSPSC 16.0901	39121528

Connection type

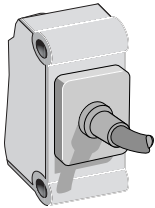

Connection diagram

Cd-088

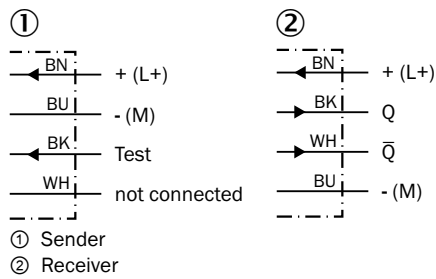

Characteristic curve

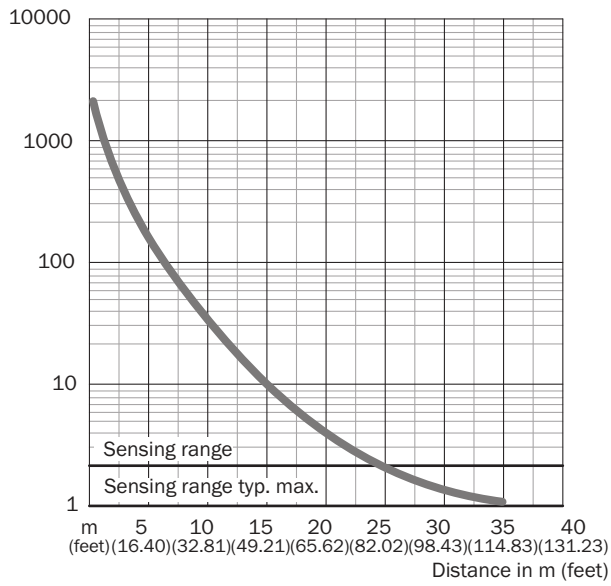

Sensing range diagram

WSE27-3

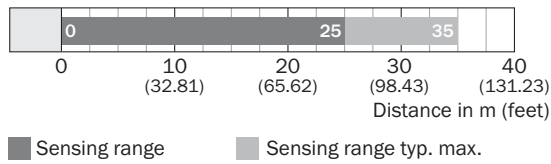

Dimensional drawing (Dimensions in mm (inch))

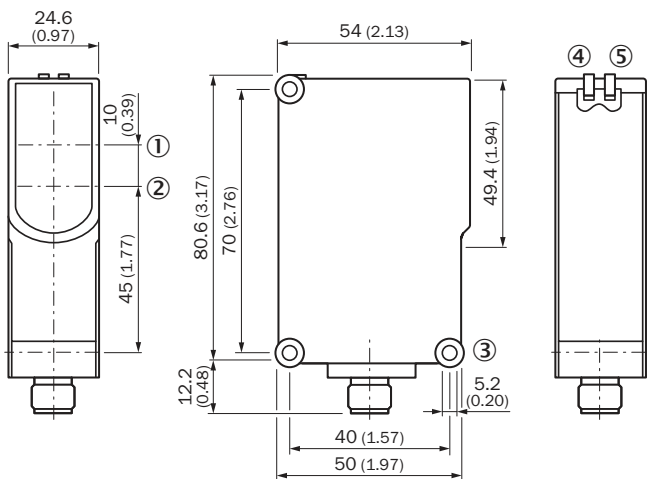

WL27-3, WSE27-3



- ① Optical axis, sender
- ② Optical axis, receiver
- ③ Mounting hole \varnothing 5.2 mm
- ④ LED indicator green: Supply voltage active
- ⑤ LED indicator yellow: Status of received light beam

Recommended accessories

Other models and accessories → www.sick.com/W27-3

	Brief description	Type	Part no.
Device protection (mechanical)			
	Protective housing for W26, W27-3 and mounting rods with diameter 12 mm ... 20 mm, Zinc plated steel (protective housing), Zinc die cast (clamping bracket), Universal clamp BEF-KHS-KH1 (2022726), mounting hardware	BEF-SG-W27	2039601
Plug connectors and cables			
	Head A: male connector, M12, 4-pin, straight Cable: unshielded	STE-1204-G	6009932

SICK AT A GLANCE

SICK is one of the leading manufacturers of intelligent sensors and sensor solutions for industrial applications. A unique range of products and services creates the perfect basis for controlling processes securely and efficiently, protecting individuals from accidents and preventing damage to the environment.

We have extensive experience in a wide range of industries and understand their processes and requirements. With intelligent sensors, we can deliver exactly what our customers need. In application centers in Europe, Asia and North America, system solutions are tested and optimized in accordance with customer specifications. All this makes us a reliable supplier and development partner.

Comprehensive services complete our offering: SICK LifeTime Services provide support throughout the machine life cycle and ensure safety and productivity.

For us, that is “Sensor Intelligence.”

WORLDWIDE PRESENCE:

Contacts and other locations www.sick.com