



# SC70, Low-Power, General-Purpose, Dual-Supply, Rail-to-Rail Op Amps

## General Description

The MAX4493/MAX4494/MAX4495 single/dual/quad general-purpose operational amplifiers are designed for use in systems powered with dual supplies from  $\pm 2.25\text{V}$  to  $\pm 5.5\text{V}$  or with a single supply of  $+4.5\text{V}$  to  $+11\text{V}$ . These op amps provide a unity-gain bandwidth of  $5\text{MHz}$  with only  $770\mu\text{A}$  of quiescent current per amplifier. The wide input common-mode range extends from  $200\text{mV}$  beyond the negative rail to within  $1.5\text{V}$  of the positive supply rail while the output swings within  $10\text{mV}$  ( $R_L = 100\text{k}\Omega$ ) of either rail.

These amplifiers have excellent ( $110\text{dB}$ ) open-loop gain with very low THD+N of  $0.002\%$  ( $f = 1\text{kHz}$ ). The single MAX4493 is available in a tiny 5-pin SC70 package and the dual MAX4494 is available in the space-saving 8-pin SOT23. The quad MAX4495 is available in both 14-pin TSSOP and 14-pin SO packages. All products are rated at the automotive temperature range of  $-40^\circ\text{C}$  to  $+125^\circ\text{C}$ .

## Applications

Battery-Powered Systems  
DAC Output Amplifiers  
Industrial Control Systems  
Voltage Reference Generators  
Signal Conditioning

## Typical Operating Characteristic

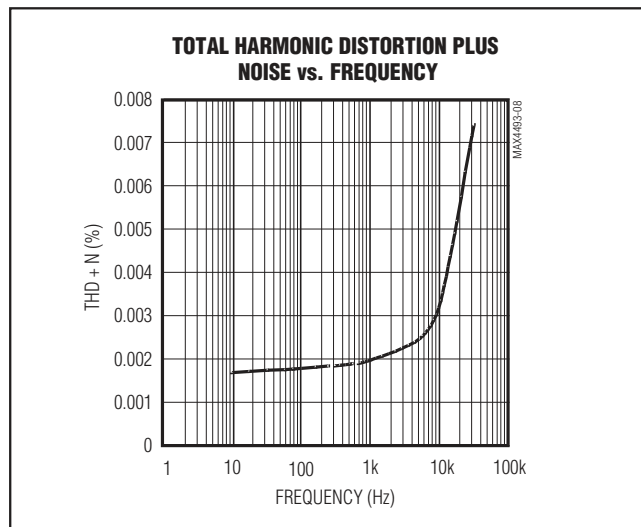

Typical Operating Circuit appears at end of data sheet.

## Features

- ◆  $770\mu\text{A}$  Supply Current per Amplifier
- ◆ Operates from Dual  $\pm 2.25\text{V}$  to  $\pm 5.5\text{V}$  Supplies
- ◆  $5\text{MHz}$  Gain-Bandwidth Product
- ◆ Rail-to-Rail Output Swing
- ◆ Input Voltage Range Extends  $200\text{mV}$  Below the Negative Rail
- ◆  $110\text{dB}$  Open-Loop Gain ( $R_L = 100\text{k}\Omega$ )
- ◆ Low THD+N of  $0.002\%$  ( $f = 1\text{kHz}$ )
- ◆ No Phase Reversal for Overdriven Inputs
- ◆ Unity-Gain Stable
- ◆ Available in Space-Saving Packages
  - 5-Pin SC70 (MAX4493)
  - 8-Pin SOT23 (MAX4494)
  - 14-Pin TSSOP (MAX4495)

## Ordering Information

PART	TEMP RANGE	PIN-PACKAGE	TOP MARK
MAX4493AXK-T	$-40^\circ\text{C}$ to $+125^\circ\text{C}$	5 SC70	ABR
MAX4493AUK-T	$-40^\circ\text{C}$ to $+125^\circ\text{C}$	5 SOT23	ADPG
MAX4494AKA-T	$-40^\circ\text{C}$ to $+125^\circ\text{C}$	8 SOT23	AAEM
MAX4494AUA	$-40^\circ\text{C}$ to $+125^\circ\text{C}$	8 $\mu\text{MAX}$	—
MAX4494ASA	$-40^\circ\text{C}$ to $+125^\circ\text{C}$	8 SO	—
MAX4495AUD	$-40^\circ\text{C}$ to $+125^\circ\text{C}$	14 TSSOP	—
MAX4495ASD	$-40^\circ\text{C}$ to $+125^\circ\text{C}$	14 SO	—

## Pin Configurations

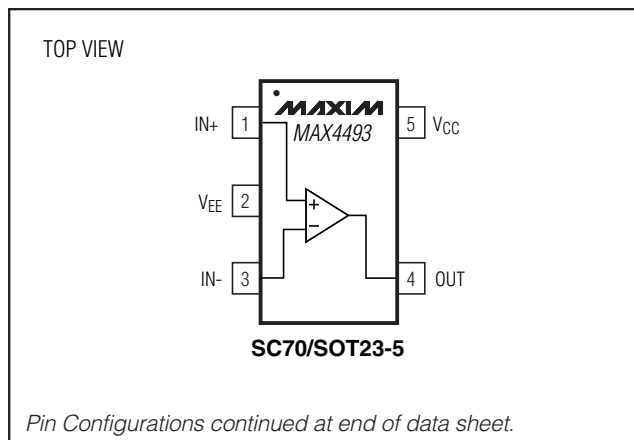

# SC70, Low-Power, General-Purpose, Dual-Supply, Rail-to-Rail Op Amps

## ABSOLUTE MAXIMUM RATINGS

Supply Voltage ( $V_{CC}$ to $V_{EE}$ ).....	+12V	8-Pin SOT23 (derate 9.1mW/°C above +70°C).....	727mW
Voltage from Any Pin to Ground or Any Other Pin .....	( $V_{EE} - 0.3V$ ) to ( $V_{CC} + 0.3V$ )	8-Pin $\mu$ MAX (derate 4.5mW/°C above +70°C) .....	362mW
Output Short-Circuit Duration to $V_{CC}$ , $V_{EE}$ , or Ground .....	Continuous	8-Pin SO (derate 5.9mW/°C above +70°C).....	471mW
Continuous Power Dissipation ( $T_A = +70^\circ\text{C}$ )		14-Pin TSSOP (derate 9.1mW/°C above +70°C) .....	727mW
5-Pin SC70 (derate 3.1mW/°C above +70°C).....	247mW	14-Pin SO (derate 8.3mW/°C above +70°C).....	667mW
5-Pin SOT23 (derate 7.1mW/°C above +70°C).....	571mW	Operating Temperature Range .....	-40°C to +125°C
		Storage Temperature Range .....	-65°C to +150°C
		Lead Temperature (soldering, 10s) .....	+300°C

Stresses beyond those listed under "Absolute Maximum Ratings" may cause permanent damage to the device. These are stress ratings only, and functional operation of the device at these or any other conditions beyond those indicated in the operational sections of the specifications is not implied. Exposure to absolute maximum rating conditions for extended periods may affect device reliability.

## DC ELECTRICAL CHARACTERISTICS

( $V_{CC} = +5V$ ,  $V_{EE} = -5V$ ,  $R_L = 100k\Omega$  to ground,  $T_A = -40^\circ\text{C}$  to  $+125^\circ\text{C}$ . Typical values are at  $T_A = +25^\circ\text{C}$ , unless otherwise noted.)  
(Note 1)

PARAMETER	SYMBOL	CONDITIONS	MIN	TYP	MAX	UNITS
Operating Supply Voltage Range	$V_S$	Guaranteed by PSRR test	$\pm 2.25$		$\pm 5.5$	V
Quiescent Supply Current per Amplifier	$I_S$			770	1100	$\mu\text{A}$
Input Offset Voltage	$V_{OS}$	$T_A = +25^\circ\text{C}$		0.3	5	mV
		$T_A = T_{MIN}$ to $T_{MAX}$			10	
Input Offset Voltage Drift	$TCV_{OS}$			3		$\mu\text{V}/^\circ\text{C}$
Input Offset Voltage Channel Matching		MAX4494 and MAX4495		1		mV
Input Bias Current	$I_B$			0.2	1	$\mu\text{A}$
Input Offset Current	$I_{OS}$			5	300	nA
Input Resistance	$R_{IN}$	Differential mode ( $-1V \leq V_{IN} \leq +1V$ )		250		$k\Omega$
		Common mode ( $V_{EE} - 0.2V \leq V_{CM} \leq V_{CC} - 1.5V$ )		110		$M\Omega$
Common-Mode Input Voltage Range	$V_{CM}$	Guaranteed by CMRR test	$V_{EE} - 0.2V$		$V_{CC} - 1.5V$	V
Common-Mode Rejection Ratio	CMRR	$V_{EE} - 0.2V \leq V_{CM} \leq V_{CC} - 1.5V$	65	90		dB
Power-Supply Rejection Ratio	PSRR	$V_S = \pm 2.25V$ to $\pm 5.5V$	65	80		dB
Large-Signal Voltage Gain	$A_{VOL}$	$R_L = 100k\Omega$ , $V_{EE} + 0.25V \leq V_{OUT} \leq V_{CC} - 0.25V$	85	110		dB
		$R_L = 1k\Omega$ , $V_{EE} + 0.5V \leq V_{OUT} \leq V_{CC} - 0.5V$	65	90		
Output Voltage Swing	$V_{OUT}$	$R_L = 100k\Omega$ , $V_{CC} - V_{OH}$ and $V_{OL} - V_{EE}$		10	150	mV
		$R_L = 1k\Omega$ , $V_{CC} - V_{OH}$ and $V_{OL} - V_{EE}$		200	450	
Output Short-Circuit Current	$I_{SC}$	Sourcing or sinking		15		mA

**Note 1:** All devices are 100% production tested at  $T_A = +25^\circ\text{C}$ . Limits over the operating temperature range are guaranteed by design and not production tested.

# SC70, Low-Power, General-Purpose, Dual-Supply, Rail-to-Rail Op Amps

MAX4493/MAX4494/MAX4495

## AC ELECTRICAL CHARACTERISTICS

( $V_{CC} = +5V$ ,  $V_{EE} = -5V$ ,  $R_L = 100k\Omega$  to ground,  $C_L = 15pF$ ,  $T_A = +25^\circ C$ , unless otherwise noted.)

PARAMETER	SYMBOL	CONDITIONS	MIN	TYP	MAX	UNITS
Gain-Bandwidth Product	GBWP			5		MHz
Full-Power Bandwidth	FPBW	$V_{OUT} = 5Vp-p$		190		kHz
Slew Rate	SR	$V_{OUT} = 5Vp-p$		3		V/ $\mu s$
Phase Margin				75		degrees
Gain Margin				15		dB
Total Harmonic Distortion Plus Noise	THD+N	$f = 1kHz$ , $V_{OUT} = 5Vp-p$ , $A_V = +1V/V$		0.002		%
Settling Time to 0.01%	$t_s$	$A_V = +1V/V$ , $V_{OUT} = 5V$ step		4		$\mu s$
Input Capacitance	$C_{IN}$			2		pF
Input Noise Voltage Density	$e_{IN}$	$f = 1kHz$		8		nV/ $\sqrt{Hz}$
Input Noise Current Density	$i_{IN}$	$f = 1kHz$		0.2		pA/ $\sqrt{Hz}$
All-Hostile Crosstalk		$f = 1kHz$ , MAX4494 and MAX4495		-100		dB
Capacitive-Load Stability		$A_V = +1V/V$ , no sustained oscillations		300		pF
Power-Up Time	$t_{ON}$	$V_{OUT} = 1V$ , $1\mu s$ power supply rise-time		3		$\mu s$

## Typical Operating Characteristics

( $V_{CC} = +5V$ ,  $V_{EE} = -5V$ ,  $V_{CM} = 0$ ,  $R_L = 100k\Omega$  to ground,  $C_L = 15pF$ ,  $T_A = +25^\circ C$ , unless otherwise noted.)

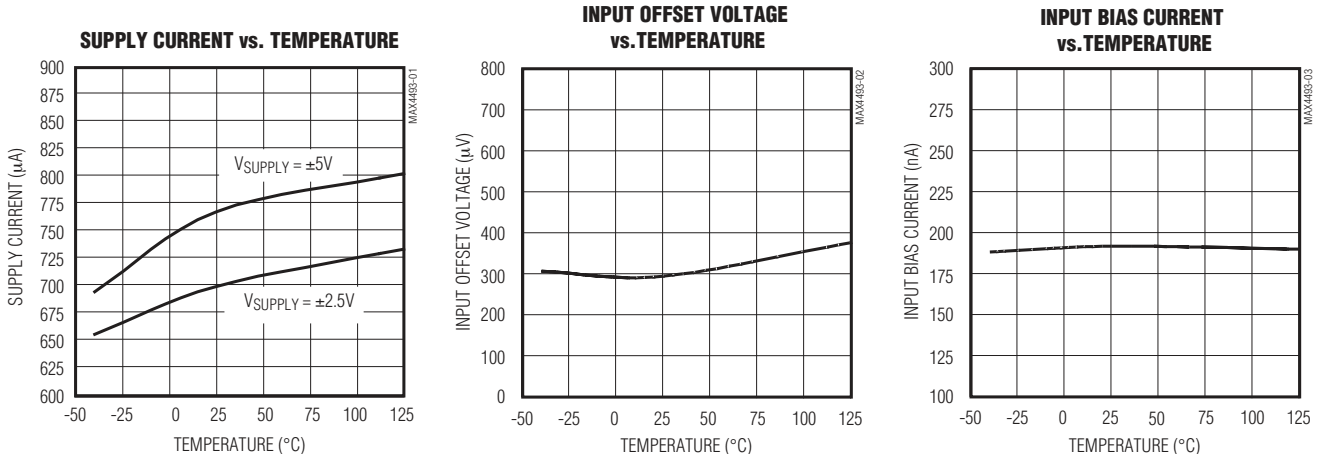

# SC70, Low-Power, General-Purpose, Dual-Supply, Rail-to-Rail Op Amps

## Typical Operating Characteristics (continued)

( $V_{CC} = +5V$ ,  $V_{EE} = -5V$ ,  $V_{CM} = 0$ ,  $R_L = 100k\Omega$  to ground,  $C_L = 15pF$ ,  $T_A = +25^\circ C$ , unless otherwise noted.)

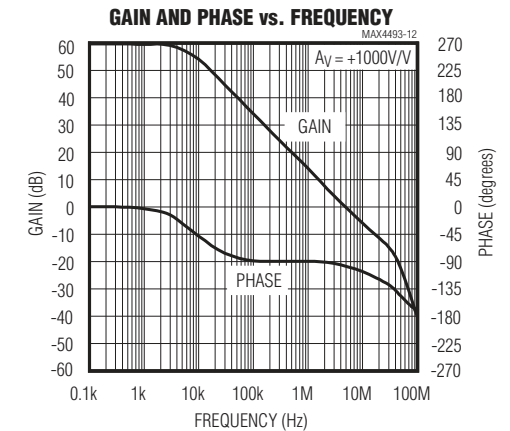
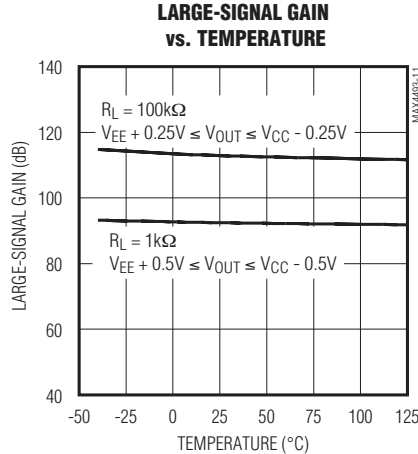
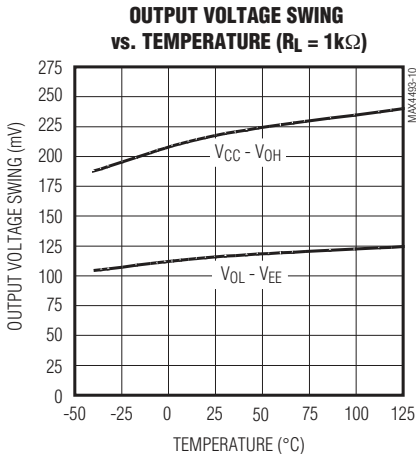
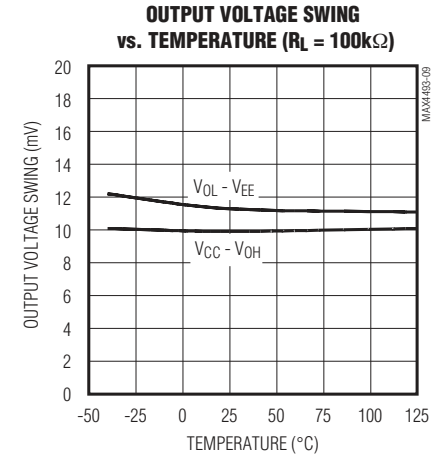
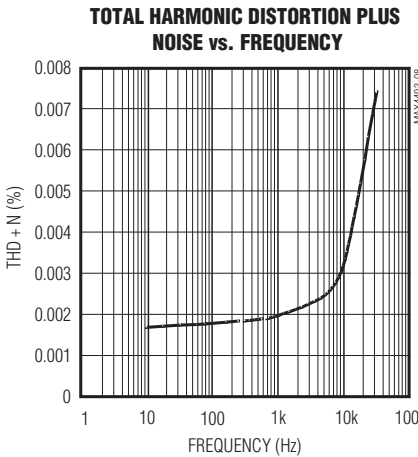
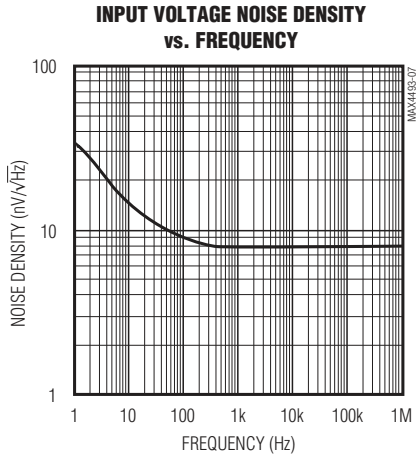
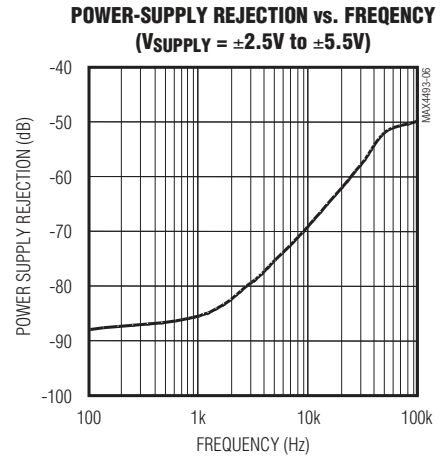
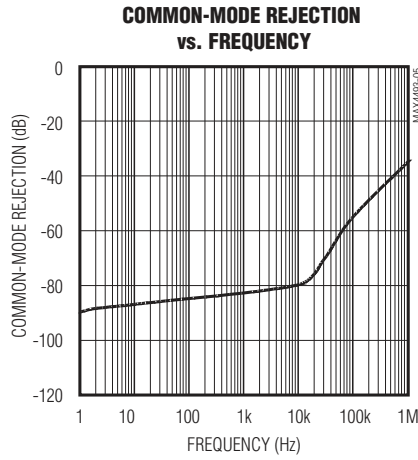
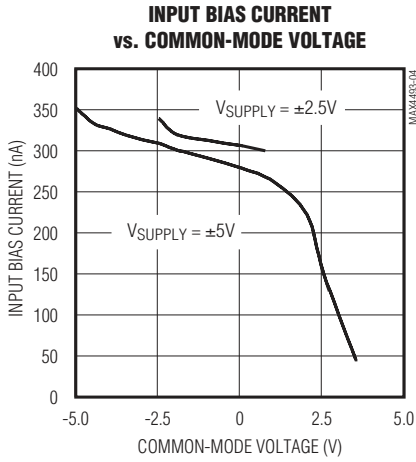

# SC70, Low-Power, General-Purpose, Dual-Supply, Rail-to-Rail Op Amps

MAX4493/MAX4494/MAX4495

## Typical Operating Characteristics (continued)

( $V_{CC} = +5V$ ,  $V_{EE} = -5V$ ,  $V_{CM} = 0$ ,  $R_L = 100k\Omega$  to ground,  $C_L = 15pF$ ,  $T_A = +25^\circ C$ , unless otherwise noted.)

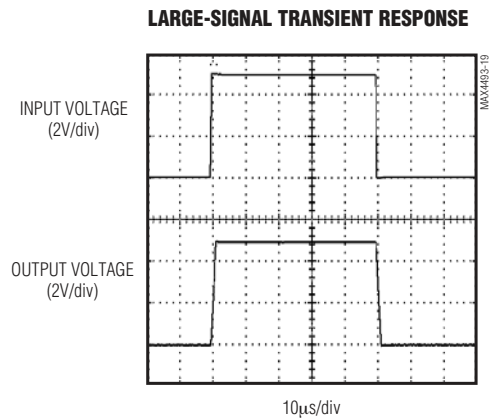
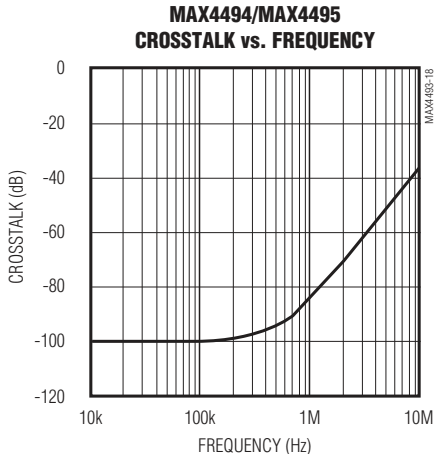
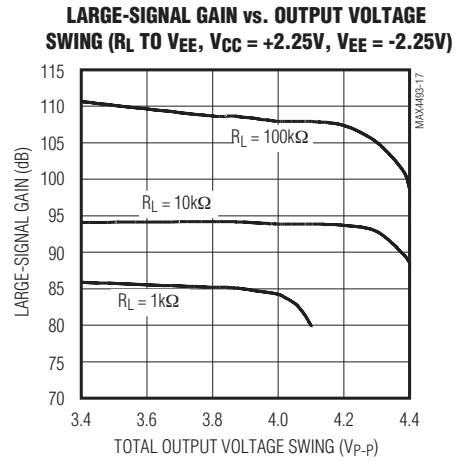
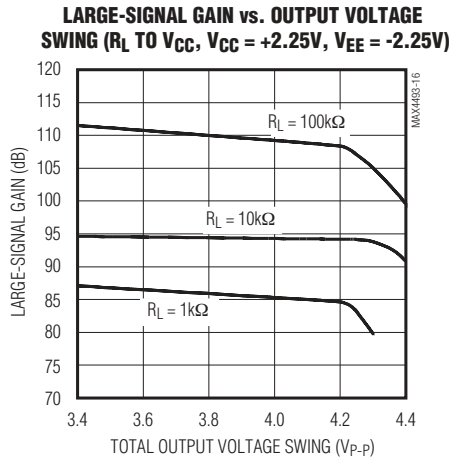
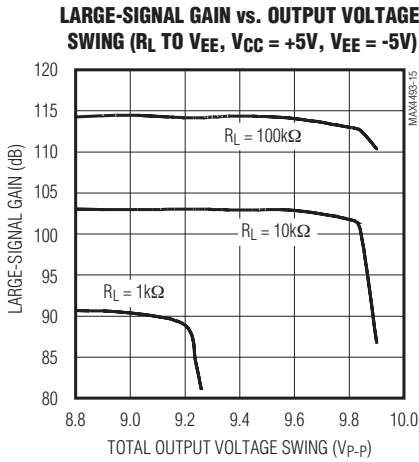
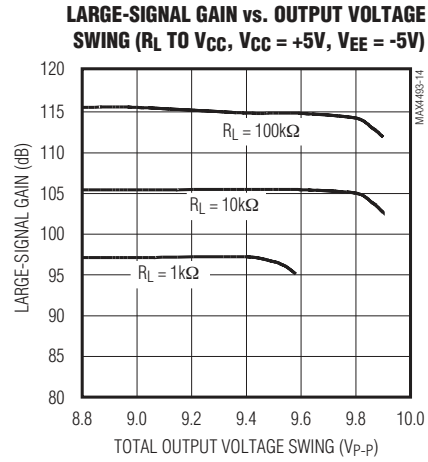
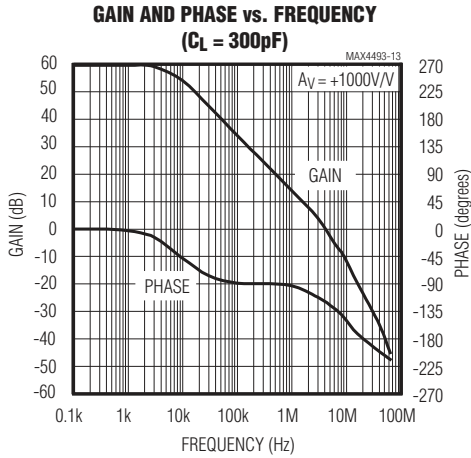

# SC70, Low-Power, General-Purpose, Dual-Supply, Rail-to-Rail Op Amps

## Typical Operating Characteristics (continued)

( $V_{CC} = +5V$ ,  $V_{EE} = -5V$ ,  $V_{CM} = 0$ ,  $R_L = 100k\Omega$  to ground,  $C_L = 15pF$ ,  $T_A = +25^\circ C$ , unless otherwise noted.)

**SMALL-SIGNAL TRANSIENT RESPONSE**

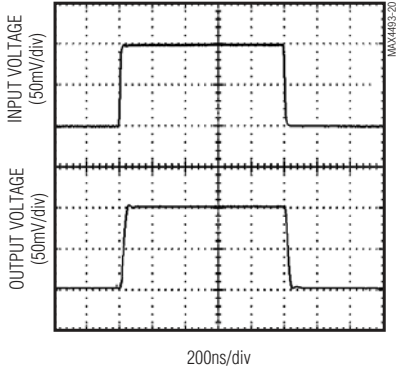

**LARGE-SIGNAL CAPACITIVE-LOAD STABILITY ( $C_L = 1200pF$ )**

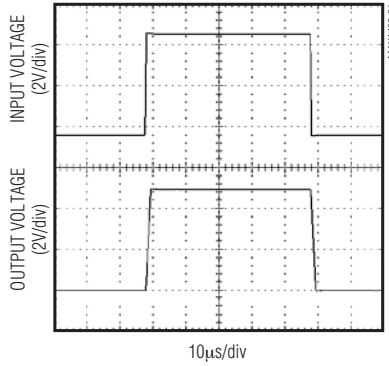

**SMALL-SIGNAL CAPACITIVE-LOAD STABILITY ( $C_L = 300pF$ )**

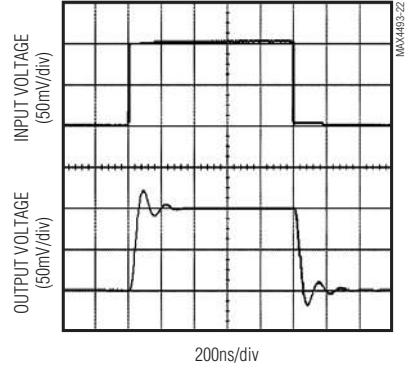

**SMALL-SIGNAL TRANSIENT RESPONSE ( $R_{ISO} = 15\Omega$ ,  $C_L = 1000pF$ )**

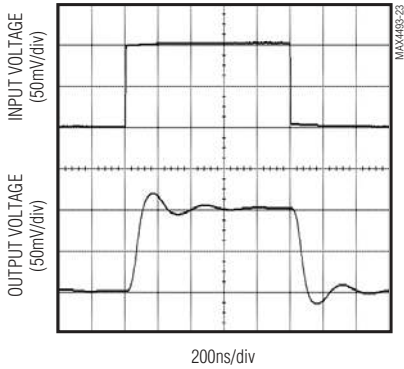

**LARGE-SIGNAL TRANSIENT RESPONSE ( $R_{ISO} = 15\Omega$ ,  $C_L = 0.01\mu F$ )**

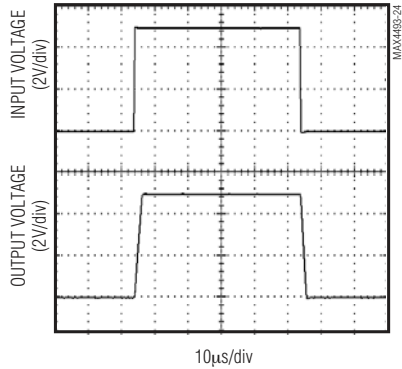

**POWER-UP TIME ( $V_{IN} = +1V$ )**

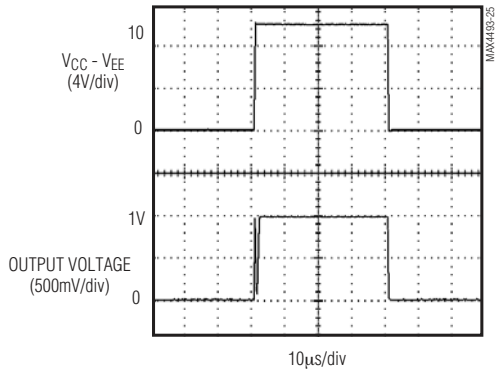

**STABILITY vs. CAPACITIVE AND RESISTIVE LOADS**

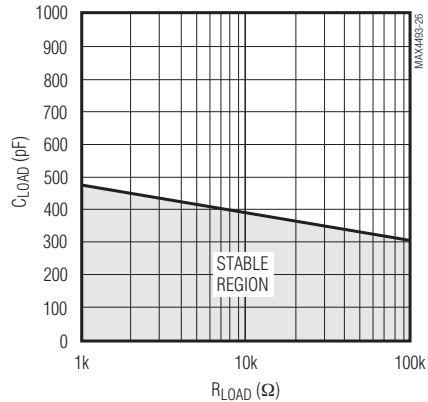

# SC70, Low-Power, General-Purpose, Dual-Supply, Rail-to-Rail Op Amps

## Pin Description

MAX4493/MAX4494/MAX4495

PIN			NAME	FUNCTION
MAX4493	MAX4494	MAX4495		
—	1	1	OUTA	Channel A Output
—	2	2	INA-	Channel A Inverting Input
—	3	3	INA+	Channel A Noninverting Input
—	7	7	OUTB	Channel B Output
—	6	6	INB-	Channel B Inverting Input
—	5	5	INB+	Channel B Noninverting Input
—	—	8	OUTC	Channel C Output
—	—	9	INC-	Channel C Inverting Input
—	—	10	INC+	Channel C Noninverting Input
—	—	14	OUTD	Channel D Output
—	—	13	IND-	Channel D Inverting Input
—	—	12	IND+	Channel D Noninverting Input
4	—	—	OUT	Output
1	—	—	IN+	Noninverting Input
3	—	—	IN-	Inverting Input
5	8	4	VCC	Positive Supply
2	4	11	VEE	Negative Supply

## Applications Information

### Rail-to-Rail Output Stage

The MAX4493/MAX4494/MAX4495 output stage can drive up to 1kΩ and still swing within 200mV of the rails.

### Capacitive-Load Stability

Driving large capacitive loads can cause instability in many op amps. The MAX4493/MAX4494/MAX4495 are

stable with capacitive loads up to 300pF. The Capacitive-Load Stability graph in the *Typical Operating Characteristics* gives the stable operation region for capacitive versus resistive load. Stability with higher capacitive loads can be improved by adding an isolation resistor in series with the op-amp output, as shown in Figure 1. This resistor improves the circuit's phase margin by isolating the load capacitor from the amplifier's output. As seen in the *Typical Operating Characteristics*, driving capacitive loads with an isolation resistor exhibits some overshoot, but no oscillation.

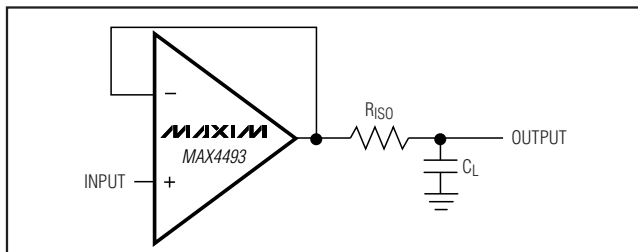

Figure 1. Capacitive Load Driving Circuit

### Full-Power Bandwidth

The FPBW is given by:

$$FPBW(\text{Hz}) = \frac{SR}{\pi [V_{OUTp-p}(\text{max})]}$$

# SC70, Low-Power, General-Purpose, Dual-Supply, Rail-to-Rail Op Amps

where the slew rate (SR) is  $3V/\mu s$ . Figure 2 shows the full-power bandwidth as a function of the peak-to-peak AC output voltage.

### Power-Up Conditions

The MAX4493/MAX4494/MAX4495 typically settle within  $3\mu s$  after power-up. See Power-Up Time in *Typical Operating Characteristics*.

### Power Supplies and Layout

The MAX4493/MAX4494/MAX4495 operate with dual supplies from  $\pm 2.25V$  to  $\pm 5.5V$ . Bypass both  $V_{CC}$  and  $V_{EE}$  with their own  $0.1\mu F$  capacitor to ground.

Good layout technique helps optimize performance by decreasing the amount of stray capacitance at the op amp's inputs and outputs. To decrease stray capacitance, minimize trace lengths by placing external components close to the op amp's pins.

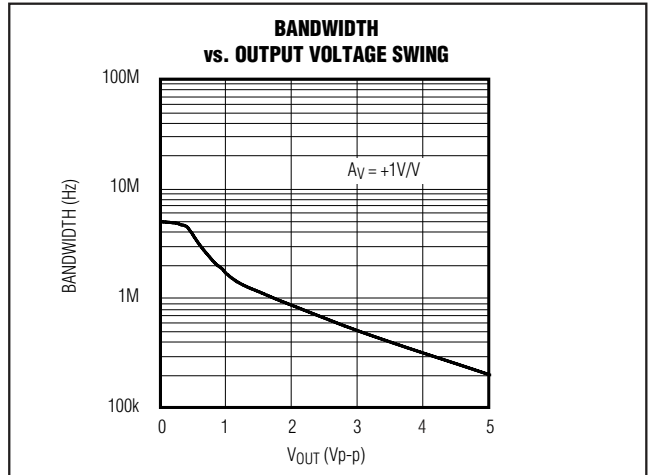
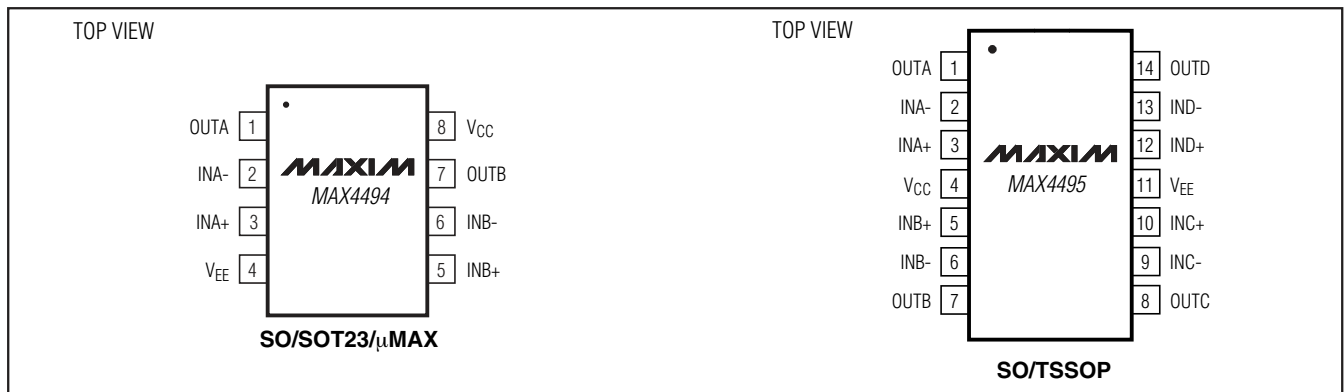
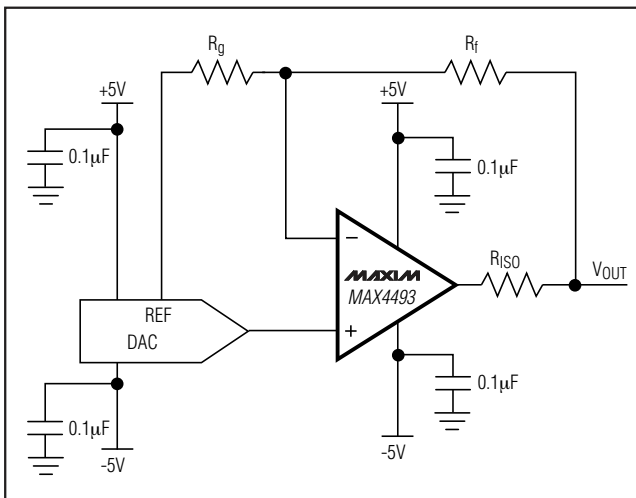

Figure 2. Bandwidth vs. Peak-to-Peak AC Voltage Plot

## Pin Configurations (continued)



## Typical Operating Circuit



## Chip Information

MAX4493 TRANSISTOR COUNT: 81  
 MAX4494 TRANSISTOR COUNT: 159  
 MAX4495 TRANSISTOR COUNT: 318  
 PROCESS: Bipolar



# SC70, Low-Power, General-Purpose, Dual-Supply, Rail-to-Rail Op Amps

## Package Information

For the latest package outline information and land patterns, go to [www.maxim-ic.com/packages](http://www.maxim-ic.com/packages).

PACKAGE TYPE	PACKAGE CODE	DOCUMENT NO.
14 TSSOP	U14-1	<a href="#">21-0066</a>
5 SOT23	U5-1	<a href="#">21-0057</a>
5 SC70	X5-1	<a href="#">21-0076</a>
8 SO	S8-2	<a href="#">21-0041</a>
8 SOT23	K8-5	<a href="#">21-0078</a>
8 $\mu$ MAX	U8-1	<a href="#">21-0036</a>
14 SO	S14-1	<a href="#">21-0041</a>

MAX4493/MAX4494/MAX4495

**TOP VIEW**: Shows the package with marking 'AAAA' and a crosshair. Dimensions include N (lead pitch), H (height), and 1 (lead width).

**BOTTOM VIEW**: Shows the package from the reverse side with dimension 1.

**BENT LEAD DETAIL**: Shows the lead profile with dimensions b, b1, and b2.

**SIDE VIEW**: Shows the package profile with dimensions D (width), A1 (lead height), and SEATING PLANE.

**END VIEW**: Shows the package from the side with dimensions A, A2, E, and C.

**DETAIL A**: Shows the lead tip with dimensions 0.25 BSC, PARTING LINE, and CC.

**LEAD TIP DETAIL**: Shows the lead tip with dimensions b, b1, c1, and c.

SYMBOL	COMMON DIMENSIONS			
	MILLIMETERS		INCHES	
	MIN.	MAX.	MIN.	MAX.
A	—	1.10	—	.043
A <sub>1</sub>	0.05	0.15	.002	.006
A <sub>2</sub>	0.85	0.95	.033	.037
b	0.19	0.30	.007	.012
b <sub>1</sub>	0.19	0.25	.007	.010
c	0.09	0.20	.004	.008
c <sub>1</sub>	0.09	0.14	.004	.006
D	SEE VARIATIONS	SEE VARIATIONS		
E	4.30	4.50	.169	.177
e	0.65 BSC		.026 BSC	
H	6.25	6.55	.246	.258
L	0.50	0.70	.020	.028
N	SEE VARIATIONS	SEE VARIATIONS		
$\alpha$	0°	8°	0°	8°
b2/b1	0.10 MAX			

JEDEC MD-153	N	PKG. CODES	VARIATIONS			
			MILLIMETERS		INCHES	
			MIN.	MAX.	MIN.	MAX.
AB-1	14	U14-1; U14-2	4.90	5.10	.193	.201
AB	16	U16-1; U16-2	4.90	5.10	.193	.201
AC	20	U20-2; U20M-2 U20-3	6.40	6.60	.252	.260
AD	24	U24-1	7.70	7.90	.303	.311
AE	28	U28-1; U28-2; U28-3	9.60	9.80	.378	.386

**NOTES**

- DIMENSIONS D AND E DO NOT INCLUDE FLASH
- MOLD FLASH OR PROTRUSIONS NOT TO EXCEED 0.15mm PER SIDE
- CONTROLLING DIMENSION: MILLIMETER
- MEETS JEDEC OUTLINE MD-153. SEE JEDEC VARIATIONS TABLE
- "N" REFERS TO NUMBER OF LEADS
- LEAD COPLANARITY 0.10 MM MAX.
- NUMBER OF LEADS SHOWN ARE FOR REFERENCE ONLY
- MARKING IS FOR PACKAGE ORIENTATION REFERENCE ONLY
- BENT LEAD 0.10 MM MAX.
- ALL DIMENSIONS APPLY TO BOTH LEADED (-) AND PBFREE (+) PKG. CODES.

-DRAWING NOT TO SCALE-

MAXIM

TITLE: PACKAGE OUTLINE, TSSOP 4.40mm BODY

APPROVAL	DOCUMENT CONTROL NO. 21-0066	REV. J 1/1
----------	---------------------------------	------------

TSSOP4.40mm.EPS

# SC70, Low-Power, General-Purpose, Dual-Supply, Rail-to-Rail Op Amps

## Package Information (continued)

For the latest package outline information and land patterns, go to [www.maxim-ic.com/packages](http://www.maxim-ic.com/packages).

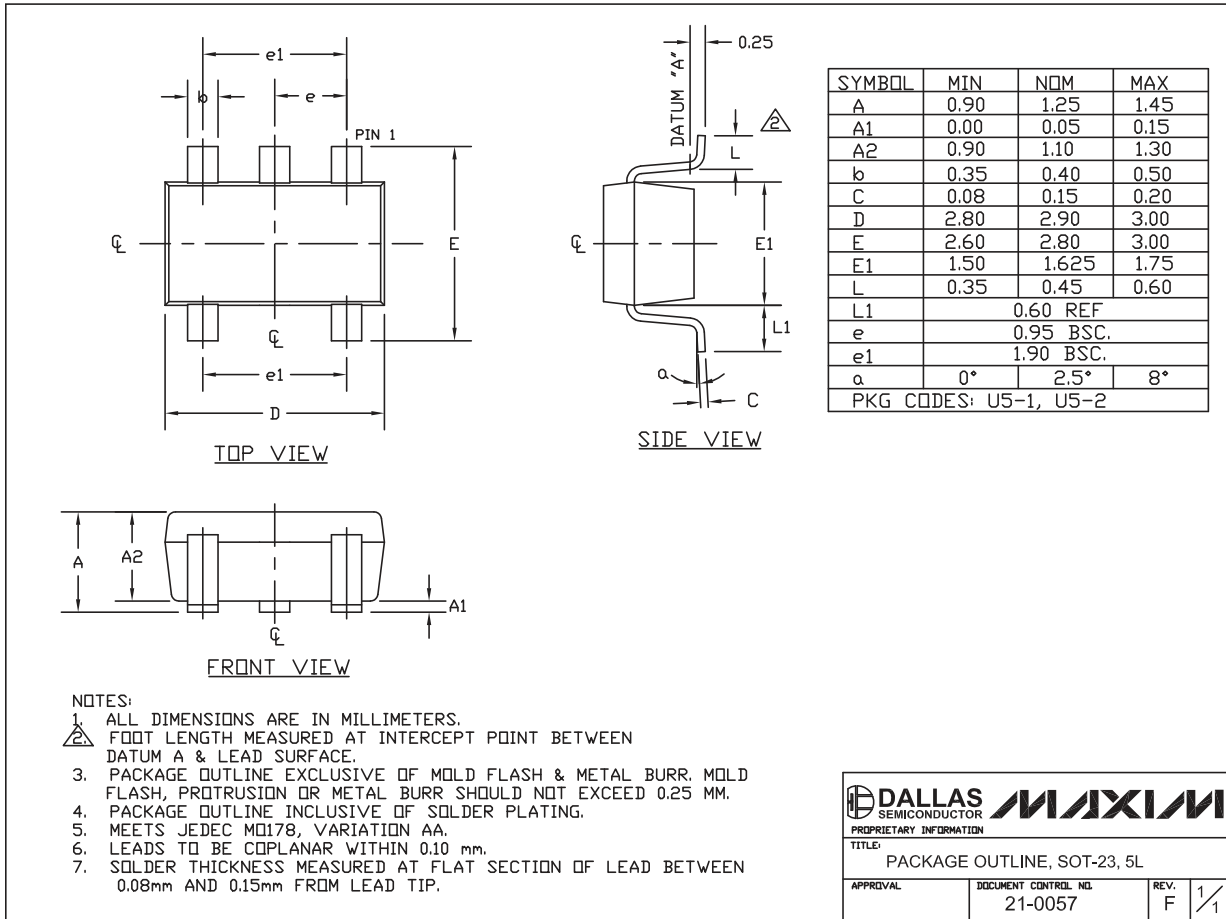

SOT-23 5L EFS

**DALLAS SEMICONDUCTOR** **MAXIM**  
 PROPRIETARY INFORMATION  
 TITLE: PACKAGE OUTLINE, SOT-23, 5L  
 APPROVAL: \_\_\_\_\_ DOCUMENT CONTROL NO: 21-0057 REV: F 1/1

# SC70, Low-Power, General-Purpose, Dual-Supply, Rail-to-Rail Op Amps

## Package Information (continued)

For the latest package outline information and land patterns, go to [www.maxim-ic.com/packages](http://www.maxim-ic.com/packages).

MAX4493/MAX4494/MAX4495

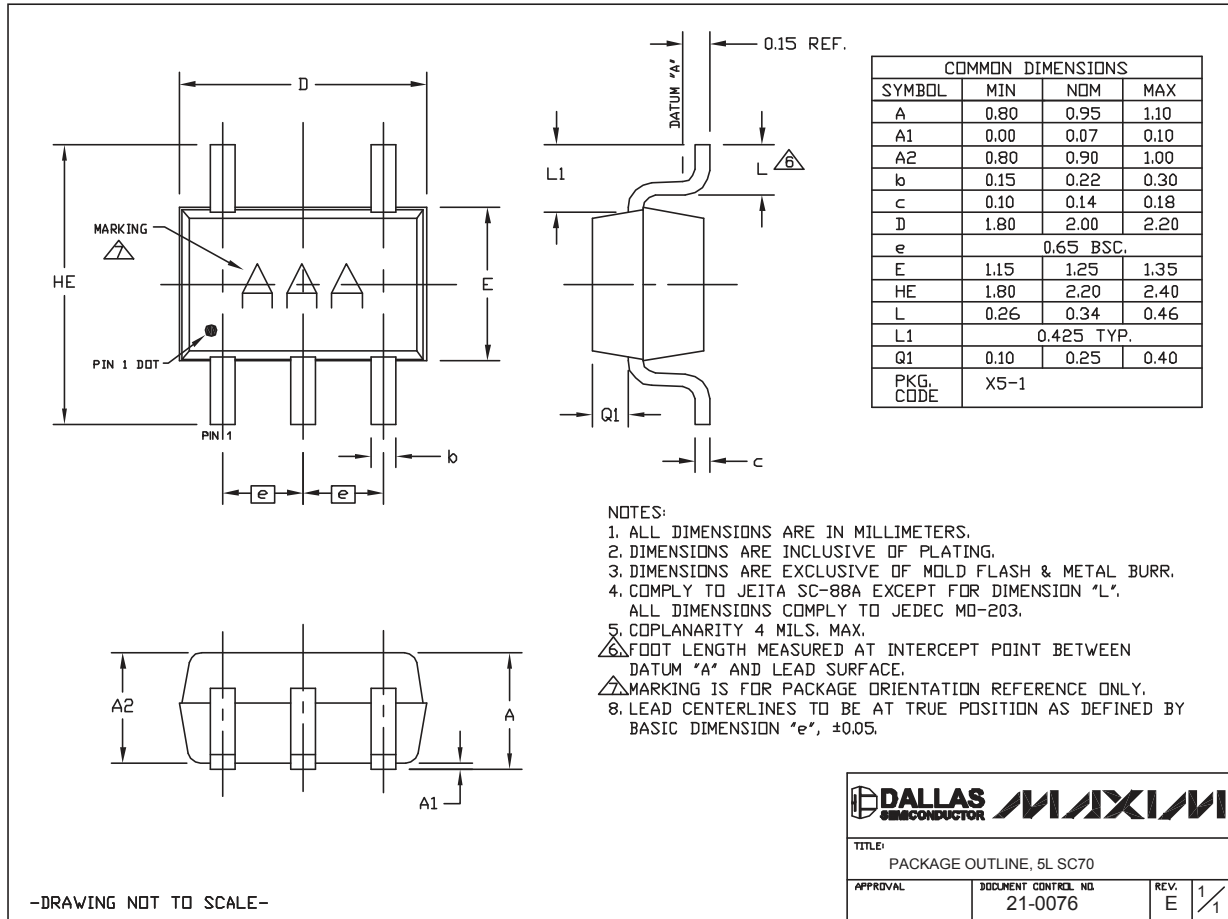

SC70, 5L EPS

**DALLAS SEMICONDUCTOR** **MAXIM**

TITLE:  
PACKAGE OUTLINE, 5L SC70

APPROVAL	DOCUMENT CONTROL NO. 21-0076	REV. E	1/1
----------	---------------------------------	-----------	-----

# SC70, Low-Power, General-Purpose, Dual-Supply, Rail-to-Rail Op Amps

## Package Information (continued)

For the latest package outline information and land patterns, go to [www.maxim-ic.com/packages](http://www.maxim-ic.com/packages).

SOICN EFS

DIM	INCHES		MILLIMETERS	
	MIN	MAX	MIN	MAX
A	0.053	0.069	1.35	1.75
A1	0.004	0.010	0.10	0.25
B	0.014	0.019	0.35	0.49
C	0.007	0.010	0.19	0.25
e	0.050 BSC		1.27 BSC	
E	0.150	0.157	3.80	4.00
H	0.228	0.244	5.80	6.20
L	0.016	0.050	0.40	1.27

VARIATIONS:

DIM	INCHES		MILLIMETERS		N	MS012
	MIN	MAX	MIN	MAX		
D	0.189	0.197	4.80	5.00	8	AA
D	0.337	0.344	8.55	8.75	14	AB
D	0.386	0.394	9.80	10.00	16	AC

NOTES:

1. D&E DO NOT INCLUDE MOLD FLASH.
2. MOLD FLASH OR PROTRUSIONS NOT TO EXCEED 0.15mm (.006").
3. LEADS TO BE COPLANAR WITHIN 0.10mm (.004").
4. CONTROLLING DIMENSION: MILLIMETERS.
5. MEETS JEDEC MS012.
6. N = NUMBER OF PINS.

<small>PROPRIETARY INFORMATION</small>			
<small>TITLE:</small> PACKAGE OUTLINE, .150" SOIC			
<small>APPROVAL</small>	<small>DOCUMENT CONTROL NO.</small> 21-0041	<small>REV.</small> B	<small>1/1</small>

# SC70, Low-Power, General-Purpose, Dual-Supply, Rail-to-Rail Op Amps

## Package Information (continued)

For the latest package outline information and land patterns, go to [www.maxim-ic.com/packages](http://www.maxim-ic.com/packages).

MAX4493/MAX4494/MAX4495

SYMBOL	MIN	NOM	MAX
A	0.90	1.25	1.45
A1	0.00	0.06	0.15
A2	0.90	1.10	1.30
b	0.22	0.30	0.38
C	0.08	0.15	0.22
D	2.80	2.90	3.00
E	2.60	2.80	3.00
E1	1.50	1.625	1.75
L	0.30	0.45	0.60
L2	0.25 BSC.		
e	0.65 BSC.		
e1	1.95 REF.		
φ	0°	3°	8°

PKG CODES:  
K8-1, K8-2, K8F-4, K8FH-4, K8-5,  
K8C-6; K8SN-1

NOTE:

- ALL DIMENSIONS ARE IN MILLIMETERS.
- FOOT LENGTH MEASURED FROM LEAD TIP TO UPPER RADIUS OF HEEL OF THE LEAD PARALLEL TO SEATING PLANE C.
- PACKAGE OUTLINE EXCLUSIVE OF MOLD FLASH & METAL BURR.
- PACKAGE OUTLINE INCLUSIVE OF SOLDER PLATING.
- COPLANARITY 4 MILS. MAX.
- MARKING IS FOR PACKAGE ORIENTATION REFERENCE ONLY.
- SOLDER THICKNESS MEASURED AT FLAT SECTION OF LEAD BETWEEN 0.08mm AND 0.15mm FROM LEAD TIP.
- MEETS JEDEC MO178 VARIATION BA.
- ALL DIMENSIONS APPLY TO BOTH LEADED (-) AND LEAD FREE (+) PACKAGE CODES.

DETAIL "A"

MAXIM

TITLE:  
PACKAGE OUTLINE, SOT-23, 8L BODY

APPROVAL	DOCUMENT CONTROL NO. 21-0078	REV. H	1/1
----------	---------------------------------	-----------	-----

-DRAWING NOT TO SCALE-

# SC70, Low-Power, General-Purpose, Dual-Supply, Rail-to-Rail Op Amps

## Package Information (continued)

For the latest package outline information and land patterns, go to [www.maxim-ic.com/packages](http://www.maxim-ic.com/packages).

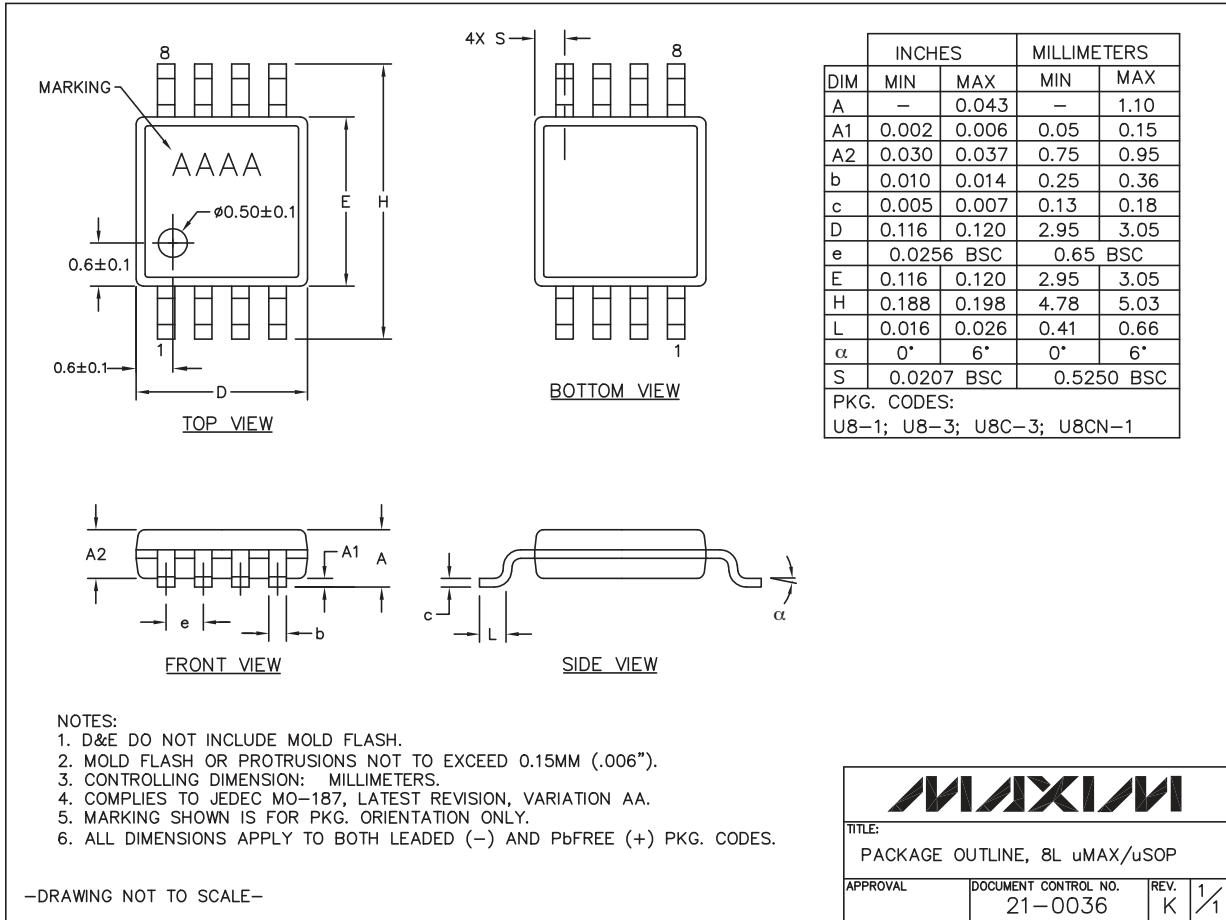

8LUMAXD.EPS

# SC70, Low-Power, General-Purpose, Dual-Supply, Rail-to-Rail Op Amps

## Revision History

REVISION NUMBER	REVISION DATE	DESCRIPTION	PAGES CHANGED
2	10/08	Updated first paragraph of the <i>General Description</i> section	1

Maxim cannot assume responsibility for use of any circuitry other than circuitry entirely embodied in a Maxim product. No circuit patent licenses are implied. Maxim reserves the right to change the circuitry and specifications without notice at any time.

Maxim Integrated Products, 120 San Gabriel Drive, Sunnyvale, CA 94086 408-737-7600 \_\_\_\_\_ 15