

Part Number: D3I9211

Electrical Specifications

Frequency Range (GHz):	9.2 - 10.5
Isolation (dB):	23 MIN
Insertion Loss (dB):	0.3 MAX
VSWR:	1.2:1 MIN
Forward Power (W):	15 AVG 50 PK
Reflective Power (W):	2 AVG

Mechanical/Environmental Specifications

Connector Type:	SMA
Connector Body:	Passivated stainless steel
Connector Pin:	Gold plated copper
Load Body:	Brass
Magnetic Shunt:	Nickel plated CRS
Operational Temp:	-30°C to +65°C
Weight (oz)	0.9 MAX

D3I9211 Dimensions

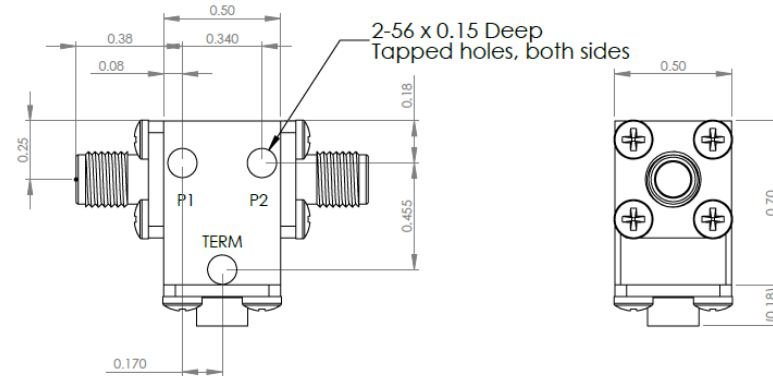

D3I9211-3 Dimensions

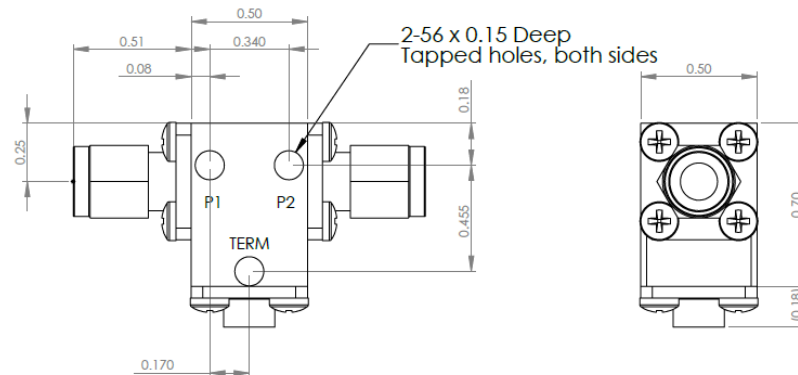

Dimensions are in inches
Tolerance

XX	±0.03
XXX	±0.010

Type of Device	PN Suffix	Connector Configuration Input / Output	PN Example
Single and Dual Junction Isolator, 2-Port Device	N/A	Female / Female	D3I9211
	-1	Male / Female	D3I9211-1
	-2	Female / Male	D3I9211-2
	-3	Male / Male	D3I9211-3



MEASURED DATA

Part Number: D3I9211, +25°C

