

1.0 SCOPE

This specification covers the detail requirements for a high-speed, precision JFET-input operational amplifier.

It is highly recommended that this data sheet be used as a baseline for new military or aerospace spec control drawings.

1.2 Part Number. The complete part numbers per Table I of this specification follow:

<u>Device</u>	<u>Part Number</u>	<u>Package</u>
A	OP-44AJ/883	J
A	OP-44AZ/883	Z
A	OP-44ARC/883	RC

1.2.3 Case Outline.

<u>Letter</u>	<u>Case Outline (Lead finish per MIL-M-38510)</u>
J	8-lead metal can (TO-99)
Z	8-lead ceramic dual-in-line package (CERDIP)
RC	20-contact hermetic leadless chip carrier (LCC)

1.3 Absolute Maximum Ratings. ($T_A = 25^\circ\text{C}$, unless otherwise noted)

Supply Voltage.....	±20V
Power Dissipation.....	500mW
Input Voltage (Note 1).....	±20V
Differential Input Voltage (Note 1).....	±40V
Output Short-Circuit Duration	Indefinite
Storage Temperature Range.....	-65°C to +150°C
Lead Temperature (Soldering, 60 sec).....	+300°C
Operating Temperature Range	-55°C to +125°C

NOTES:

1. For supply voltages less than ±20V, the absolute maximum input voltage is equal to the supply voltages.

1.5 Thermal Characteristics:

Thermal Resistance, TO-99 (J) package:

Junction-to-Case (θ_{JC}) = 45°C/W MAX

Junction-to-Ambient (θ_{JA}) = 150°C/W MAX

Thermal Resistance, CERDIP (Z) package:

Junction-to-Case (θ_{JC}) = 26°C/W MAX

Junction-to-Ambient (θ_{JA}) = 119°C/W MAX

Thermal Resistance, LCC (RC) package:

Junction-to-Case (θ_{JC}) = 30°C/W MAX

Junction-to-Ambient (θ_{JA}) = 120°C/W MAX

TABLE 1

$V_S = \pm 15V$; $R_S = 50\Omega$; $V_{CM} = 0V$; $T_A = T_J = +25^\circ C$ unless otherwise specified.

Characteristics	Symbol	Special Conditions	OP-44/883		Units
			LIMITS A		
			Min	Max	
Input Offset Voltage	V_{OS}	$-55^\circ C \leq T_A \leq +125^\circ C$	-	1.0	mV
			-	2.0	mV
Input Offset Voltage Temperature Coefficient	TCV_{OS}	$-55^\circ C \leq T_A \leq +125^\circ C$	-	10	$\mu V/^\circ C$
Input Offset Current	I_{OS}	$T_A = T_J = +125^\circ C$	-	40	pA
			-	1	nA
Input Bias Current	I_B	$T_A = T_J = +125^\circ C$	-	± 200	pA
			-	± 20	nA
Common-Mode Rejection (Note 1)	CMR	$V_{CM} = IVR = \pm 11V$	86	-	dB
		$V_{CM} = IVR = \pm 11V$ $-55^\circ C \leq T_A \leq +125^\circ C$	84	-	dB
Power Supply Rejection Ratio	PSRR	$V_S = \pm 10V$ to $\pm 20V$	-	40	$\mu V/V$
		$V_S = \pm 10V$ to $\pm 20V$ $-55^\circ C \leq T_A \leq +125^\circ C$	-	50	$\mu V/V$
Output Voltage Swing	V_O	$R_L = 1k\Omega$	± 11.5	-	V
		$R_L = 2k\Omega$ $-55^\circ C \leq T_A \leq +125^\circ C$	± 11.0	-	V
Supply Current	I_{SY}	$V_O = 0V$, No Load	-	7.5	mA
		$V_O = 0V$, No Load $-55^\circ C \leq T_A \leq +125^\circ C$	-	7.5	mA
Short-Circuit Current Limit	I_{SC}	Output Shorted to Ground	± 20	± 60	mA
		Output Shorted to Ground $-55^\circ C \leq T_A \leq +125^\circ C$	± 8	± 60	mA

TABLE 1 (Continued)

$V_S = \pm 15V$; $R_S = 50\Omega$; $V_{CM} = 0V$; $T_A = T_J = +25^\circ C$ unless otherwise specified.

Characteristics	Symbol	Special Conditions	OP-44/883		Units
			LIMITS A		
			Min	Max	
Slew Rate	SR	$A_{VCL} = +3, R_L = 2k\Omega$	100	—	V/ μ s
		$A_{VCL} = +3, R_L = 2k\Omega$ $-55^\circ C \leq T_A \leq +125^\circ C$	80	—	V/ μ s
External V_{OS} Trim Range	V_{OSadj}	$R_{POT} = 10k\Omega$	± 2.5	± 10	mV
Large-Signal Voltage Gain	A_{VO}	$V_O = \pm 10V, T_A = +25^\circ C$ $R_L = 10k\Omega$	500	—	V/mV
		$R_L = 2k\Omega$	200	—	V/mV
		$R_L = 1k\Omega$	100	—	V/mV
		$V_O = \pm 10V$ $-55^\circ C \leq T_A \leq +125^\circ C$ $R_L = 10k\Omega$	160	—	V/mV
		$R_L = 2k\Omega$	80	—	V/mV
Rise Time (Note 2)	t_r		—	50	ns
Overshoot (Note 2)	OS		—	40	%

NOTES:

1. IVR is defined as the V_{CM} range used for the CMR test.
2. See test conditions and test circuit, Figure 1A and 1B.

TABLE 2

OP-44/883

Electrical Test Requirements For Class B Devices

MIL-STD-883 Test Requirements	Subgroups (see Table 3)
Interim Electrical Parameters (pre Burn-In)	1
Final Electrical Test Parameters	1*, 2, 3, 4, 5, 6, 7, 8
Group A Test Requirements	1, 2, 3, 4, 5, 6, 7, 8, 9

* PDA applies to Subgroup 1 only.
No other Subgroups are included in PDA.

TABLE 3

Group A Inspection

$V_S = \pm 15V$; $R_S = 50\Omega$; $V_{CM} = 0V$; $T_A = T_J$ unless otherwise specified.

Subgroup	Symbol	Special Conditions	OP-44/883		Units
			LIMITS A		
			Min	Max	
Subgroup 1 $T_A = +25^\circ C$	V_{OS}		-	1.0	mV
	I_B		-	± 200	pA
	I_{OS}		-	40	pA
	CMR	$V_{CM} = \pm 11V$	86	-	dB
	PSRR	$V_S = \pm 10V, \pm 20V$	-	40	$\mu V/V$
	I_{SC}	Output Shorted to Ground	± 20	± 60	mA
	I_{SY}	$V_O = 0V$, No Load	-	7.5	mA
	V_{OSadj}	$R_{POT} = 10k\Omega$	± 2.5	± 10	mV
Subgroup 2 $T_A = +125^\circ C$	V_{OS}		-	2.0	mV
	TCV_{OS}		-	10	$\mu V/^\circ C$
	I_B		-	± 20	nA
	I_{OS}		-	1	nA
	CMR	$V_{CM} = \pm 11V$	84	-	dB
	PSRR	$V_S = \pm 10V, \pm 20V$	-	50	$\mu V/V$
	I_{SC}	Output Shorted to Ground	± 8	± 60	mA
	I_{SY}	$V_O = 0V$, No Load	-	7.5	mA
Subgroup 3 $qT_A = -55^\circ C$	All Tests, Limits and Conditions are the same as for Subgroup 2 with the exclusion of I_B and I_{OS} which are not tested at this temperature.				

TABLE 3

Group A Inspection (Continued)

$V_S = \pm 15V$; $R_S = 50\Omega$; $V_{CM} = 0V$; $T_A = T_J$ unless otherwise specified.

Subgroup	Symbol	Special Conditions	OP-44/883 LIMITS A		Units
			Min	Max	
Subgroup 4	V_O	$R_L = 1k\Omega$	± 11.5	—	V
$T_A = +25^\circ C$	A_{VO}	$V_O = \pm 10V, R_L = 10k\Omega$	500	—	V/mV
		$V_O = \pm 10V, R_L = 2k\Omega$	200	—	V/mV
		$V_O = \pm 10V, R_L = 1k\Omega$	100	—	V/mV
Subgroup 5	V_O	$R_L = 2k\Omega$	± 11.0	—	V
$T_A = +125^\circ C$	A_{VO}	$V_O = \pm 10V, R_L = 10k\Omega$	160	—	V/mV
		$V_O = \pm 10V, R_L = 2k\Omega$	80	—	V/mV
Subgroup 6 $T_A = -55^\circ C$	All Tests, Limits and Conditions are the same as for Subgroup 5.				
Subgroup 7 $T_A = +25^\circ C$	SR	$A_{VCL} = +3, R_L = 2k\Omega$	100	—	V/ μs
Subgroup 8 $T_A = -55, +125^\circ C$	SR	$A_{VCL} = +3, R_L = 2k\Omega$	80	—	V/ μs
Subgroup 9 $T_A = +25^\circ C$	t_r	See t_r , OS test circuit, Figure 1A, 1B.	—	50	μs
	OS	See t_r , OS test circuit, Figure 1A, 1B.	—	40	%

Rise Time and Overshoot Test Circuit

Figure 1A

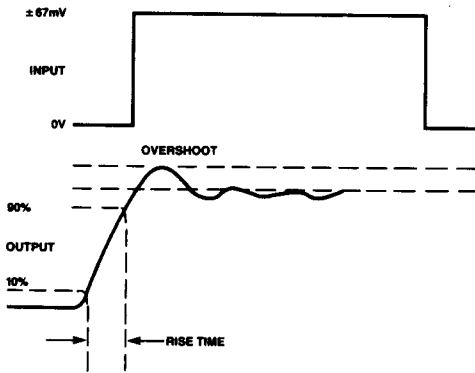
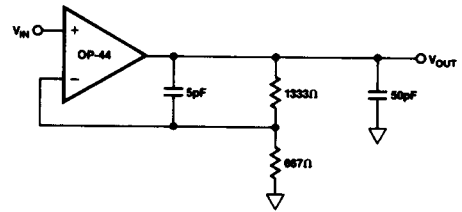
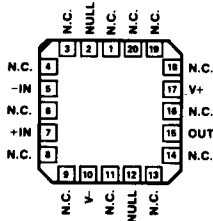
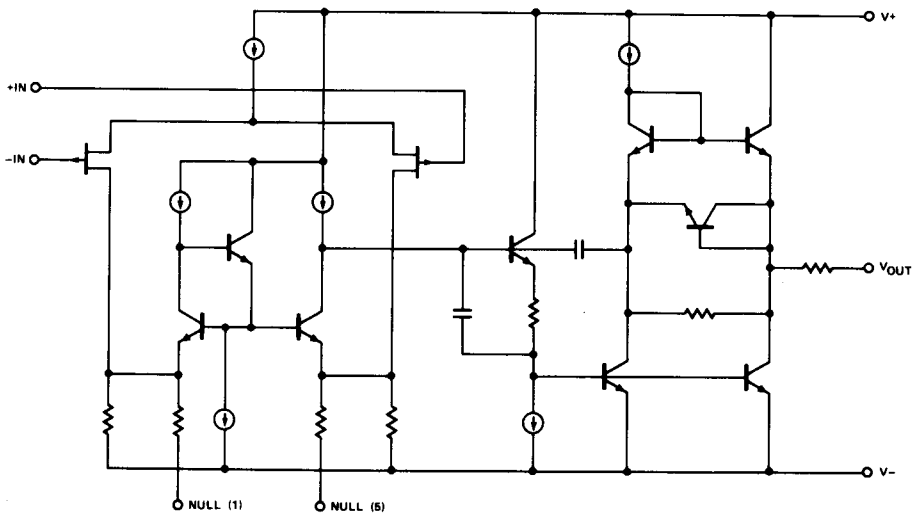

Figure 1B



3.2.1 Simplified Schematic and Pin Connections.



20-CONTACT HERMETIC LCC (RC-Suffix)

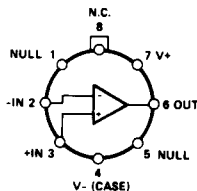

TO-99 (J-Suffix)

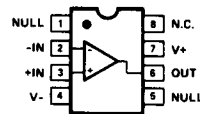

8-PIN HERMETIC DIP (Z-Suffix)

OP-44

3.2.4 **Microcircuit Group Assignment.** This microcircuit is covered by microcircuit group 61.

4.2 **Life Test/Burn-In Circuit.**

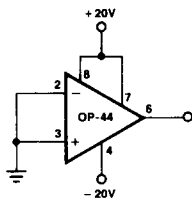

J AND Z PACKAGES