

AIMB-210 (Intel® Atom™ processor N270 1.6 GHz FSB 533 MHz Mini ITX Motherboard with VGA, LVDS, TV-Out, 6 COM, Dual GbE, 8 USB, 2 SATA II)

Startup Manual

Packing List

Before you begin installing your card, please make sure that the following items have been shipped:

1. AIMB-210 Intel® Atom™ processor N270 Mini-ITX Motherboard
2. IDE HDD cable (40 pin) x 1
3. SATA HDD cable x 2
4. SATA Power cable x 2
5. Serial port cable x 3
6. I/O port bracket x 1
7. Startup manual x 1
8. Driver CD x 1
9. Warranty card x1

Optional Cable

1. Parallel cable with bracket (P/N: 1700008809)
2. Dual port USB cable (P/N: 1700002204) (27 cm) with bracket

If any of these items are missing or damaged, please contact your distributor or sales representative immediately.

Note: Acrobat Reader is required to view any PDF file.

Acrobat Reader can be downloaded at:

www.adobe.com/Prodindex/acrobat/readstep.html
(Acrobat is a trademark of Adobe).

For more information on this and other Advantech products, please visit our website at:

<http://www.advantech.com>

<http://www.advantech.com/eplatform>

For technical support and service, please visit our support website at:

<http://www.advantech.com/support>

This manual is for the AIMB-210 series Rev.A1.

Part No. 2006021010

1st Edition,

Print in Taiwan

Feb. 2009

Specifications

Standard SBC functions

- **CPU:** Intel® Atom™ processor N270 1.6 GHz FSB 533 MHz
- **BIOS:** Award 16 Mbit SPI
- **Chipset:** Intel 945GSE with ICH7M
- **System Memory:** Up to 2 GB; 200-pin SODIMM x 1, Single-channel 400/533 MHz DDR2
- **SATA2 Interface:** Two onboard Serial ATA connectors and data transfers up to 150 MB/s
- **IDE Interface:** One onboard IDE connector supporting up to two enhanced IDE devices. Supports PIO mode 4 (16.67 MB/s data transfer rate) and ATA 33/66/100 (33/66/100 MB/s data transfer rate) BIOS enabled/disabled
- **CF interface:** Supports compact flash Type II
- **Serial ports:** Six serial ports, COM1, COM3, COM4, COM5 and COM6 are RS-232; COM2 is RS-232/422/485
- **Parallel port:** One parallel port, supports SPP/EPP/ECP mode (with pin header)
- **Keyboard/mouse connector:** Supports one standard PS/2 keyboard, one standard PS/2 mouse
- **Watchdog timer:** 1~255 level timer intervals
- **USB 2.0:** Supports up to eight USB 2.0 ports, four external ports and four onboard pin headers
- **GPIO:** 16-bit general purpose Input/Output

Graphic Interface

- **Controller:** Chipset integrated VGA controller
- **Display memory:** Dynamically shared system memory up to 224 MB
- **CRT:** Up to 2048x1536 at 75 Hz maximum resolution, 400MHz RAMDAC
- **LVDS interface:** Supports up to UXGA (1600X1200)
- **LVDS port:** Supports dual LVDS connectors.
 - LVDS1: single channel 18-bit/dual channel 36-bit
 - LVDS2 (Option) : single channel 24-bit/dual channel 48-bit

Ethernet Interface

- **Dual 10/100/1000Base-T GbE LAN** Realtek RTL8111C

Mechanical and Environmental

- **Dimensions (L x W):** 170 x 170 mm
- **Power supply voltage:** 3.3 V, +5 V, 12 V, +5 Vsb, -12 V
- **Power requirements:** +5 V @ 1.96 A, +3.3 V @ 1.21 A, +12 V @ 0.19 A, 5 VSB @ 0.28, -12 V @ 0.06 A. Measure of the maximum current values with system under maximum load

Specifications

- **Operating temperature:** 0 ~ 60° C
- **Weight:** 0.365 kg (weight of board)

Jumpers and Connectors

The board has a number of connectors and jumpers that help to configure the system to suit your application requirements. The tables below list the function of each of the connectors and jumpers.

Label	Function
JFP1	Power Switch / Reset connector
JFP2	External speaker / Sata HDD LED connector / SM Bus connector
JFP3 (Keyboard Lock and Power LED)	Power LED Suspend: Fast flash (ATX/ AT) System On: ON (ATX/ AT) System Off: OFF (AT) System Off: Slow flash (ATX)
CMOS1	CMOS clear (Default 1-2)
JSETCOM2	COM2 RS232/422/485 Jumper Setting
JLV1	LVDS1 LCD power 3.3 V/5 V selection Default (1-2 , 3.3 V)
JLV2	LVDS2 LCD power 3.3 V/5 V selection Default (1-2 , 3.3 V)
JPSON1	AT(1-2) / ATX(2-3) (Default 2-3)
LPT1	Parallel connector
USB56	USB port 5, 6 (on board)
USB78	USB port 7, 8 (on board)
VGA1	VGA connector
TVOUT1	TV-Out connector
COM12	Serial port: COM1 (RS232) and COM2 (RS232, RS422 and RS485)
COM3	Serial port: COM3 (RS232)
COM4	Serial port connector
COM5	Serial port connector
COM6	Serial port connector
KBMS1	PS/2 Keyboard and Mouse connector
CPUFAN1	CPU FAN connector(3-pin)
SYSFAN1	System FAN connector(3-pin)
LAN1_USB12	LAN1 / USB port 1, 2
LAN2_USB34	LAN2 / USB port 3, 4

Jumpers and Connectors

CF1	CF Socket
AUDIO1	Audio connector
FPAUD1	Audio Front Panel Pin Header
DIO1	GPIO Header
IDE1	IDE connector
EATXPWR1	ATX 20Pin Main power connector
INV1	LVDS1 Inverter Power
INV2	LVDS2 Inverter Power
LVDS1	LVDS1 connector (Internal)
LVDS2	LVDS2 connector (External)
PCI1	PCI Slot
SATA1	Serial ATA1
SATA2	Serial ATA2
DIMMA1	Memory connector channel
BAT1	Battery Connector
SPI_CN1	SPI flash update connector
JWDT1	Watchdog Reset
SPI_CN1	SPI BIOS socket

CMOS1: Clear CMOS

Pins	Result
1-2*	Keep CMOS data*
2-3	Clear CMOS data

* Default

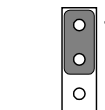

Keep CMOS data

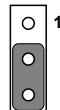

Clear CMOS

Jumpers and Connectors

JSETCOM2: COM2 RS232/422/485 Mode Selector

Users can use JSETCOM2 to select among RS 232/422/485 modes for COM2. The default setting is RS 232.

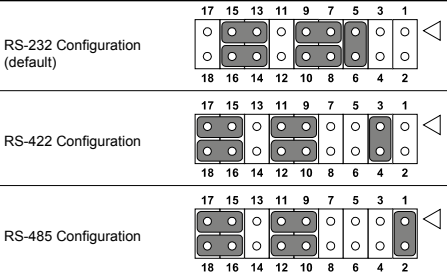

JLV1/JLV2: LCD Power 3.3 V/5.5 V Selector

Closed Pins Result

1-2*	3.3 V*
2-3	5 V

* Default

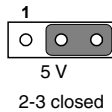
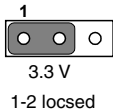

JPSON1: ATX, AT Mode Selector

Closed Pins Result

1-2	AT Mode
2-3*	ATX Mode*

* Default

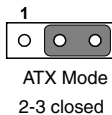
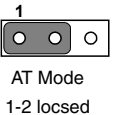

JWDT1: Watchdog Timer Output Option

Closed Pins Result

1-2	NC
2-3*	System reset*

* Default

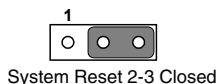
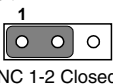

Jumpers and Connectors

LVDS Connector: LVDS1/LVDS2 (Option)

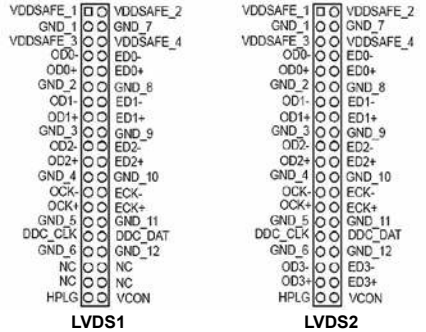

Installation Note

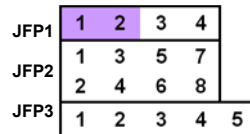

JFP1	
pin.1	#PWR_SW
pin.2	GND
pin.3	#RST_SW
pin.4	GND

*Power button pin is located in Pin 1 & 2 of front panel connector.

Declaration of Conformity

The device complies with the requirements in Part 15 of the FCC rules. Operation is subject to the following two conditions:

1. This device may not cause harmful interference;
2. This device must accept any interference received, including interference that may cause undesired operation.

Software Installation

The CD disc contains a driver installer program that will lead you through the installation of various device drivers needed to take full advantage of your motherboard.

CAUTION

The computer is supplied with a battery-powered Real-time Clock circuit. There is a danger of explosion if the battery is incorrectly replaced. Replace only with same or equivalent type recommended by the manufacturer. Discard used batteries according to manufacturer's instructions.

Board Diagram

