



User's Guide

C-28-0605

VFD

(Vacuum Fluorescent Character Display Module)

For product support, contact

New haven Display International
2511 Technology Drive #101
Elgin , IL 601 24
Tel: (847) 8 44-8795 Fax: (847) 8 44-8796

October 31, 2006

Vacuum Fluorescent Display Specification

PART NUMBER: C-28-0605

FEATURES: 7 Digits, Seven Segmented, with Icons – DVD

APPLICATION: Character Display (7-Seg)

RATINGS: Below

Outer Dimensions	Panel Length	P.L.	100.0	mm	
	Panel Height	P.H.	28.0	mm	
	Panel Thickness	P.T.	8.5	mm	
Leads	Lead Pitch	L.P.	2.54	Mm	
	Lead Out	-	SIL		
Character Size	Character Height	C.H.	Multi	mm	
	Character Width	C.W.	Multi	mm	
Item	Symbol	Min.	Recommended	Max.	Unit
Filament Voltage	Ef	3.2	3.5	3.9	Vac
Peak Grid Voltage	Ec	-	25.0	28.0	Vp-p
Peak Anode Voltage	Eb	-	25.0	28.0	Vp-p
Cut-off Bias	Ek	-	-	-	-
Duty Cycle	Du	-	1/9	-	-
Pulse Width	Tp	-	100	-	uS
Operating Temperature	Topr	-20	-	+ 70	C
Storage Temperature	Tstg	-55	-	+ 80	C
Color of Illumination	Green / Red / Yellow				

Electrical Characteristics



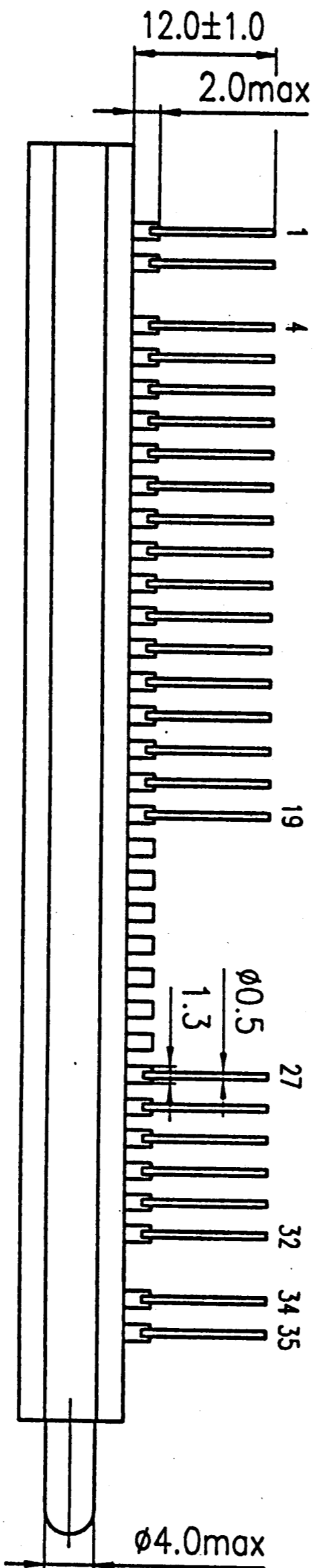
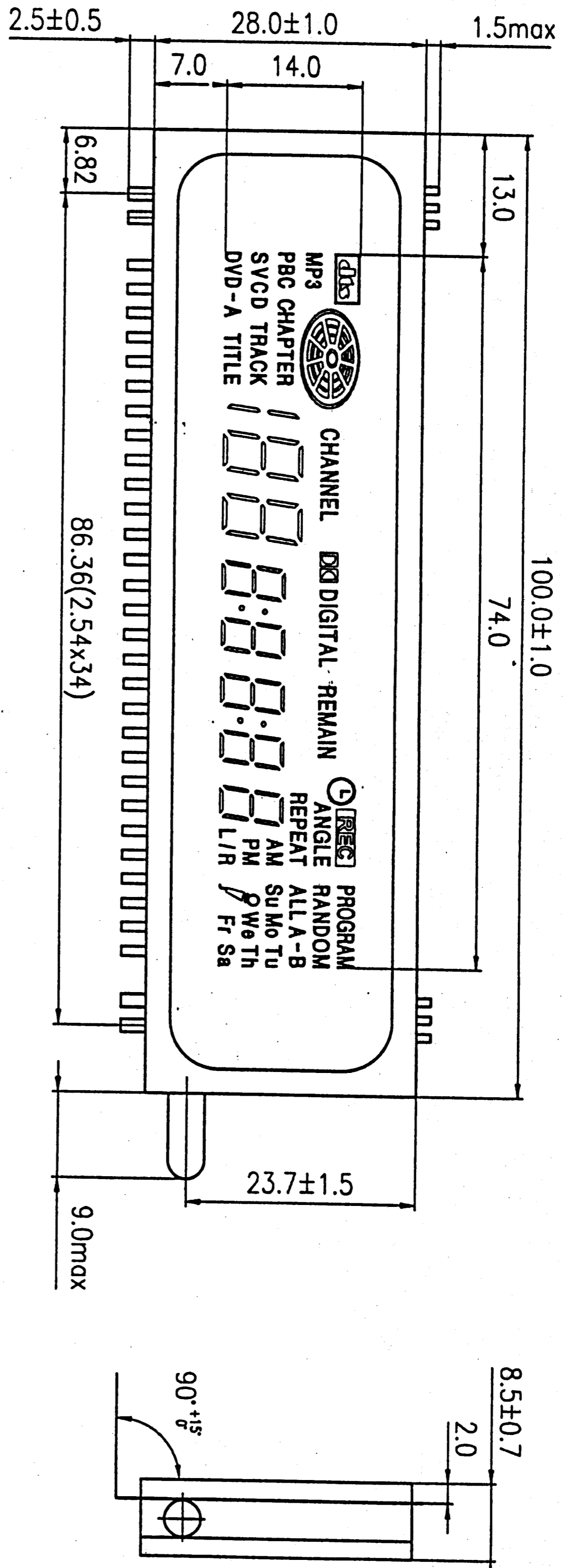

Item	Symbol	Test Condition	Min.	Typical	Max.	Unit
Filament Current	If -	Ef = 3.5 Vac eb = ec = 0	112.5 -	125.0 -	137.5 -	mAac -
Anode Current	ib/1,2,3,4G	Ef = 3.5 Vac eb = 25.0 Vp-p ec = 25.0 Vp-p Du = 1/9 tp = 100 uS	-	8.0	16.0	mA _{p-p}
	ib/5,6G		-	10.0	20.0	mA _{p-p}
	-		-	-	-	mA _{p-p}
	-		-	-	-	mA _{p-p}
	-		-	-	-	mA _{p-p}
Grid Current	ic/1,2,3,4G		-	8.5	17.0	mA _{p-p}
	ic/5,6G		-	11.0	22.0	mA _{p-p}
	-		-	-	-	mA _{p-p}
	-		-	-	-	mA _{p-p}
	-		-	-	-	mA _{p-p}
Luminance	L(G)		350 (102)	700 (204)	-	cd/m ² (fL)
	L(R)		35 (10)	70 (20)		cd/m ² (fL)
	L(Y)		60 (17)	120 (34)		cd/m ² (fL)
Luminance Ratio	Lmin/Lmax		50	-	-	%
Grid Cut-off Voltage	Ecco	Ef = 3.5 Vac Eb = 25.0 Vdc	-4.5	-	-	Vdc
Anode Cut-off Voltage	Ebco	Ef = 3.5 Vac ec = 25.0 Vp-p Du = 1/9 tp = 100 uS	-4.5	-	-	Vdc

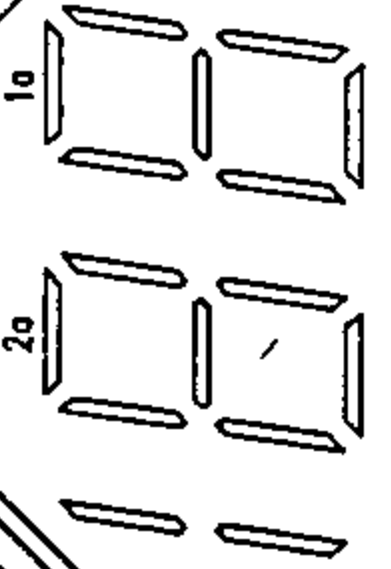
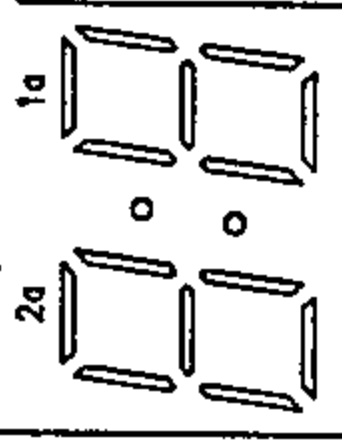
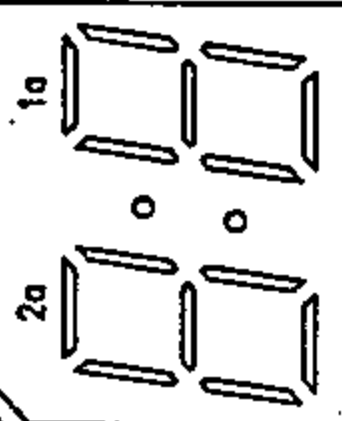

PINOUT CONNECTIONS

Pin No.	1	2	3	4	5	6	7	8	9	10	11	12	13	14	15	16	17	18
Connection	F	F	NP	P1	P2	P3	P4	P5	P6	P7	P8	P9	P10	P11	P12	P13	P14	P15
Pin No.	19	20	21	22	23	24	25	26	27	28	29	30	31	32	33	34	35	
Connection	P16	NC	NC	NC	NC	NC	NC	NC	6G	5G	4G	3G	2G	1G	NP	F	F	

F: Filament G: Grid P: Anode NP: No Pin NC: No Connection

 MP3 PBC CHAPTER SVCD TRACK DVD-A TITLE	CHANNEL 	DIGITAL 	REMAIN 	 ANGLE REPEAT  AM  PM L/R	PROGRAM RANDOM ALL A - B Su Mo Tu  We Th Fr Sa
--	---	--	--	--	--

6G 5G 4G 3G 2G 1G

CHAPTER, TRACK, TITLE, 5G

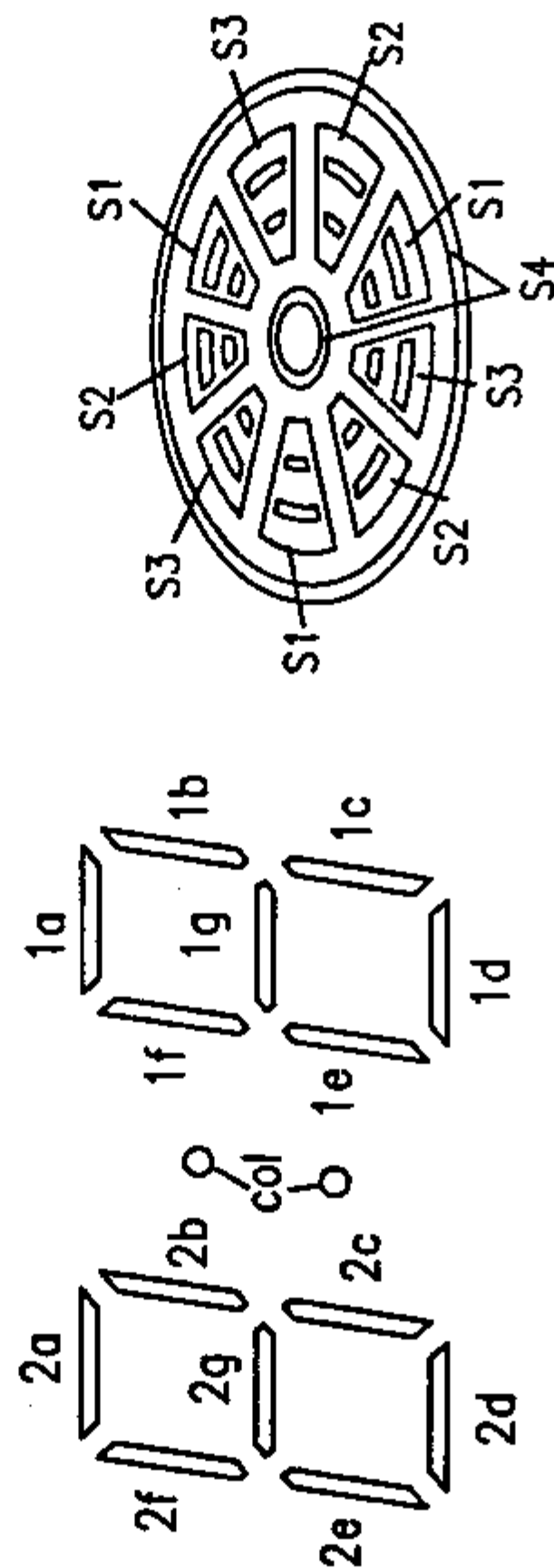

	6G	5G	4G	3G	2G	1G
P1	CHAPTER	CHANNEL	col	col	L	
P2	TRACK	/	<input type="checkbox"/> DIGITAL	REMAIN	/	PROGRAM
P3	<input type="checkbox"/> MS	1a	1a	1a	R	RANDOM
P4	MP3	1b	1b	1b	<input type="radio"/> G	A-
P5	S1	1c	1c	1c	REPEAT	ALL
P6	S3	1d	1d	1d	PM	
P7	S2	1e	1e	1e	AM	Su
P8		1f	1f	1f	<input type="checkbox"/> REC	B
P9	S4	1g	1g	1g	ANGLE	
P10	PBC	2a	2a	2a	d	Mo
P11	CD	2b	2b	2b	b	Tu
P12	DVD	2c	2c	2c	c	Th
P13	TITLE	2d	2d	2d	d	Sa
P14	-A	2e	2e	2e	e	Fr
P15	V	2f	2f	2f	f	P
P16	S	2g	2g	2g	g	Wa