

## N-Channel Enhancement Mode Power MOSFET

### Description

The RM12N100LD uses advanced trench technology and design to provide excellent  $R_{DS(ON)}$  with low gate charge. It can be used in a wide variety of applications.

### General Features

- $V_{DS} = 100V, I_D = 12A$   
 $R_{DS(ON)} < 112m\Omega @ V_{GS}=10V$   
 $R_{DS(ON)} < 120m\Omega @ V_{GS}=4.5V$
- Special process technology for high ESD capability
- High density cell design for ultra low  $R_{Dson}$
- Fully characterized avalanche voltage and current
- Good stability and uniformity with high  $E_{AS}$
- Excellent package for good heat dissipation
- Halogen-free
- P/N suffix V means AEC-Q101 qualified, e.g:RM12N100LDV

### Application

- Power switching application
- Hard switched and high frequency circuits
- Uninterruptible power supply

**100% UIS TESTED!**

**100%  $\Delta V_{ds}$  TESTED!**

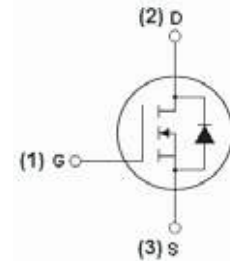

Schematic diagram

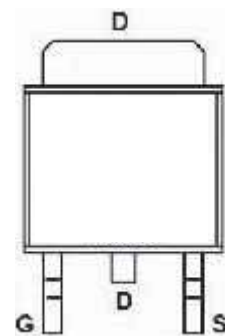

Marking and pin assignment

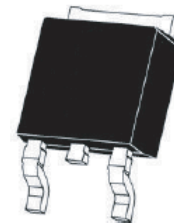

TO-252-2Ltop view

### Package Marking and Ordering Information

Device Marking	Device	Device Package	Reel Size	Tape width	Quantity
12N100	RM12N100LD	TO-252-2L	-	-	-

### Absolute Maximum Ratings ( $T_C=25^\circ C$ unless otherwise noted)

Symbol	Parameter	Limit	Unit
$V_{DS}$	Drain-Source Voltage	100	V
$V_{GS}$	Gate-Source Voltage	$\pm 20$	V
$I_D$	Drain Current-Continuous	12	A
$I_D (100^\circ C)$	Drain Current-Continuous( $T_C=100^\circ C$ )	7.7	A
$I_{DM}$	Pulsed Drain Current	24	A
$P_D$	Maximum Power Dissipation	34.7	W
$E_{AS}$	Single pulse avalanche energy <sup>(Note 5)</sup>	256	mJ
$T_J, T_{STG}$	Operating Junction and Storage Temperature Range	-55 To 150	$^\circ C$

## Thermal Characteristic

$R_{\theta JC}$	Thermal Resistance, Junction-to-Case <sup>(Note 2)</sup>	3.6	$^{\circ}C/W$
-----------------	--	-----	---------------

## Electrical Characteristics ( $T_C=25^{\circ}C$ unless otherwise noted)

Symbol	Parameter	Condition	Min	Typ	Max	Unit
<b>Off Characteristics</b>						
$BV_{DSS}$	Drain-Source Breakdown Voltage	$V_{GS}=0V, I_D=250\mu A$	100	-	-	V
$I_{DSS}$	Zero Gate Voltage Drain Current	$V_{DS}=80V, V_{GS}=0V$	-	-	1	$\mu A$
$I_{GSS}$	Gate-Body Leakage Current	$V_{GS}=\pm 20V, V_{DS}=0V$	-	-	$\pm 100$	nA
<b>On Characteristics</b> <sup>(Note 3)</sup>						
$V_{GS(th)}$	Gate Threshold Voltage	$V_{DS}=V_{GS}, I_D=250\mu A$	1.0	-	2.5	V
$R_{DS(ON)}$	Drain-Source On-State Resistance	$V_{GS}=10V, I_D=10A$	-	-	112	m $\Omega$
		$V_{GS}=4.5V, I_D=10A$	-	-	120	m $\Omega$
$g_{FS}$	Forward Transconductance	$V_{DS}=5V, I_D=10A$	-	13	-	S
<b>Dynamic Characteristics</b> <sup>(Note 4)</sup>						
$C_{iss}$	Input Capacitance	$V_{DS}=15V, V_{GS}=0V,$ $F=1.0MHz$	-	1535	-	PF
$C_{oss}$	Output Capacitance		-	60	-	PF
$C_{rSS}$	Reverse Transfer Capacitance		-	37	-	PF
<b>Switching Characteristics</b> <sup>(Note 4)</sup>						
$t_{d(on)}$	Turn-on Delay Time	$V_{DD}=50V, R_L=5\Omega$ $V_{GS}=10V, R_{GEN}=3.3\Omega$	-	4.2	-	nS
$t_r$	Turn-on Rise Time		-	8.2	-	nS
$t_{d(off)}$	Turn-Off Delay Time		-	35.6	-	nS
$t_f$	Turn-Off Fall Time		-	9.6	-	nS
$Q_g$	Total Gate Charge	$V_{DS}=80V, I_D=10A,$ $V_{GS}=10V$	-	26.2	-	nC
$Q_{gs}$	Gate-Source Charge		-	4.6	-	nC
$Q_{gd}$	Gate-Drain Charge		-	5.1	-	nC
<b>Drain-Source Diode Characteristics</b>						
$V_{SD}$	Diode Forward Voltage <sup>(Note 3)</sup>	$V_{GS}=0V, I_S=10A$	-	-	1.2	V
$I_S$	Diode Forward Current <sup>(Note 2)</sup>	-	-	-	12	A
$t_{rr}$	Reverse Recovery Time	$T_J=25^{\circ}C, I_F=10A$	-	37	-	nS
$Q_{rr}$	Reverse Recovery Charge	$di/dt=100A/\mu s$ <sup>(Note 3)</sup>	-	27.3	-	nC
$t_{on}$	Forward Turn-On Time	Intrinsic turn-on time is negligible (turn-on is dominated by LS+LD)				

### Notes:

1. Repetitive Rating: Pulse width limited by maximum junction temperature.
2. Surface Mounted on FR4 Board,  $t \leq 10$  sec.
3. Pulse Test: Pulse Width  $\leq 300\mu s$ , Duty Cycle  $\leq 2\%$ .
4. Guaranteed by design, not subject to production
5. EAS Condition :  $T_J=25^{\circ}C, V_{DD}=50V, V_G=10V, L=0.5mH, R_g=25\Omega, I_{AS}=32A$

## RATING AND CHARACTERISTICS CURVES (RM12N100LD)

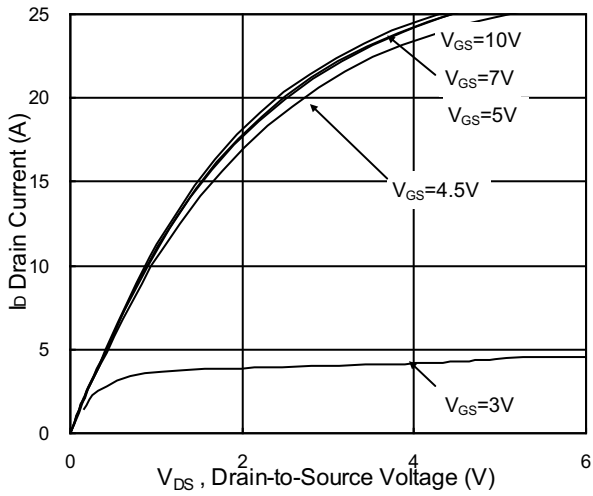

Fig.1 Typical Output Characteristics

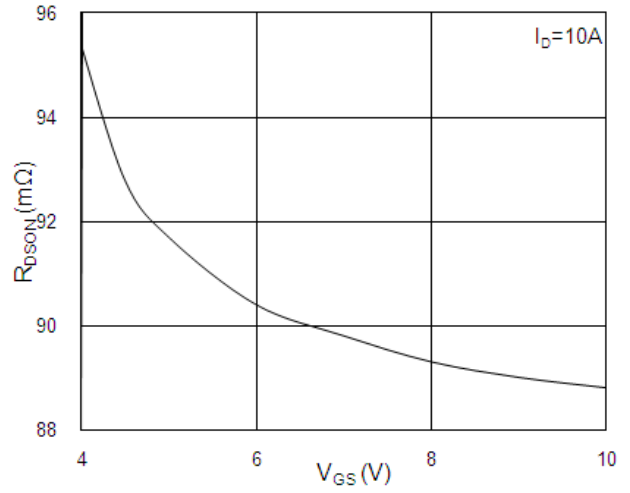

Fig.2 On-Resistance vs. Gate-Source

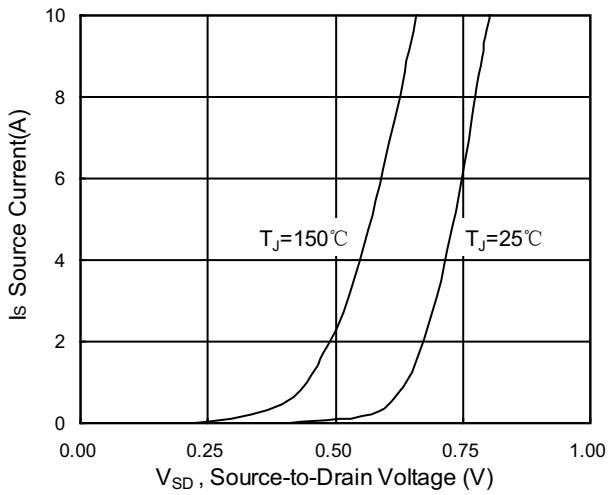

Fig.3 Forward Characteristics Of Reverse

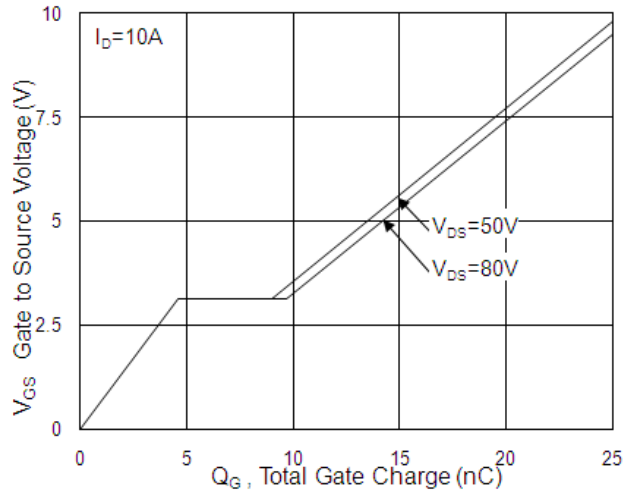

Fig.4 Gate-Charge Characteristics

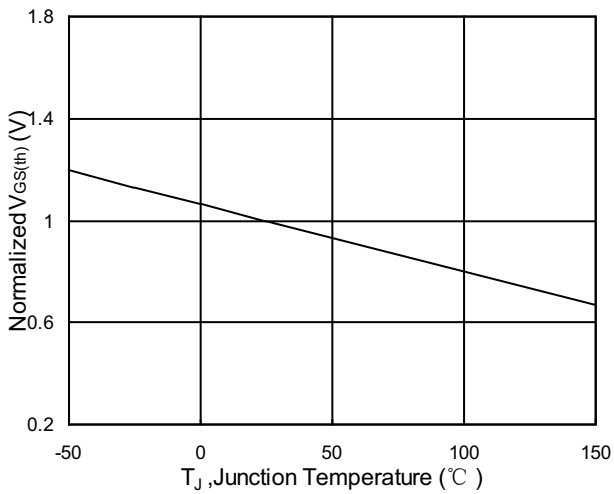

Fig.5 Normalized  $V_{GS(th)}$  vs.  $T_J$

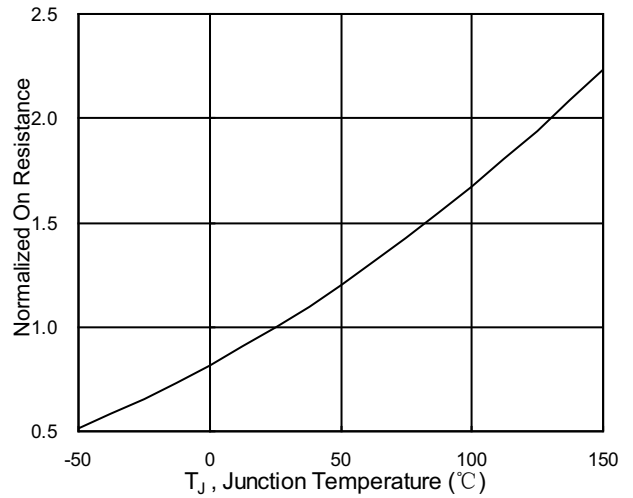

Fig.6 Normalized  $R_{DS(on)}$  vs.  $T_J$

# RATING AND CHARACTERISTICS CURVES (RM12N100LD)

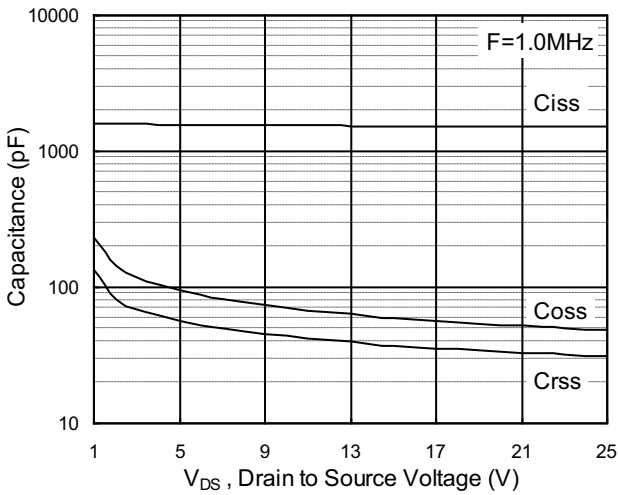

Fig.7 Capacitance

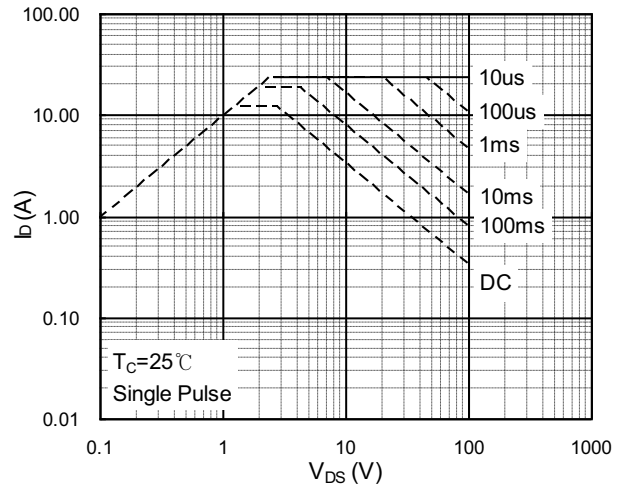

Fig.8 Safe Operating Area

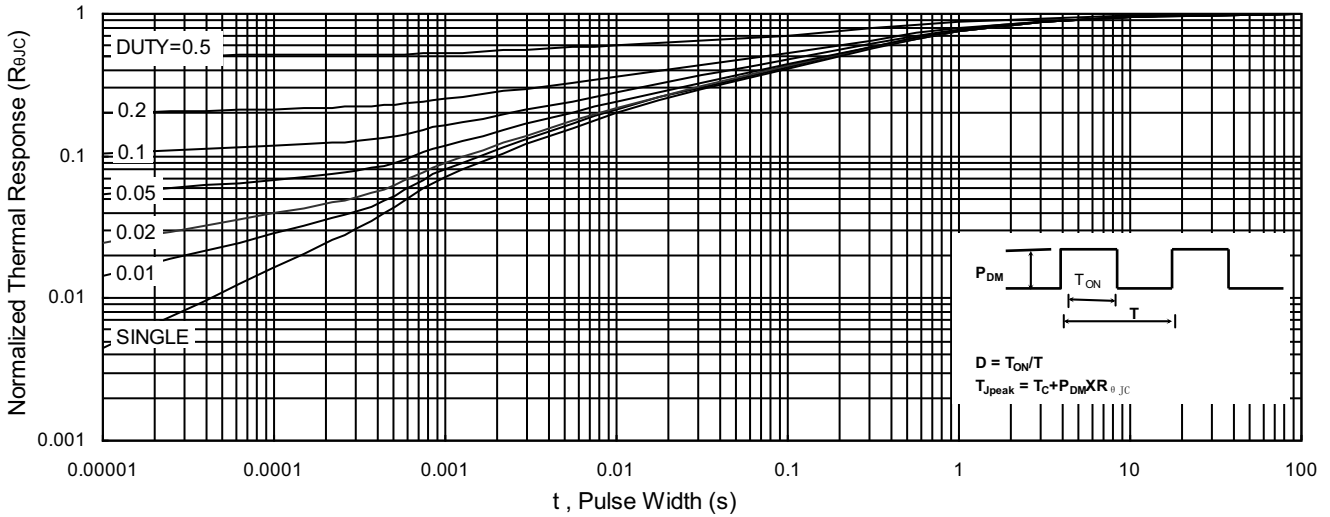

Fig.9 Normalized Maximum Transient Thermal Impedance

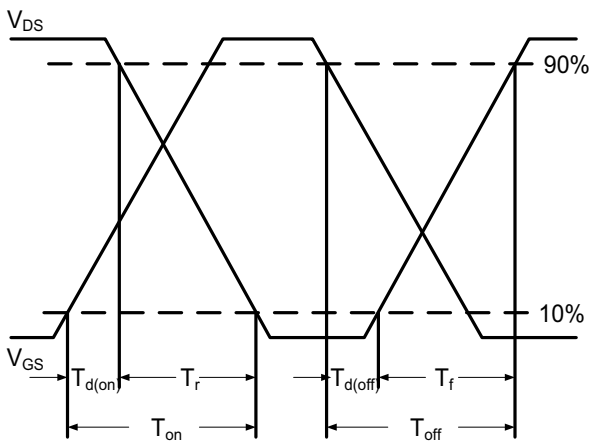

Fig.10 Switching Time Waveform

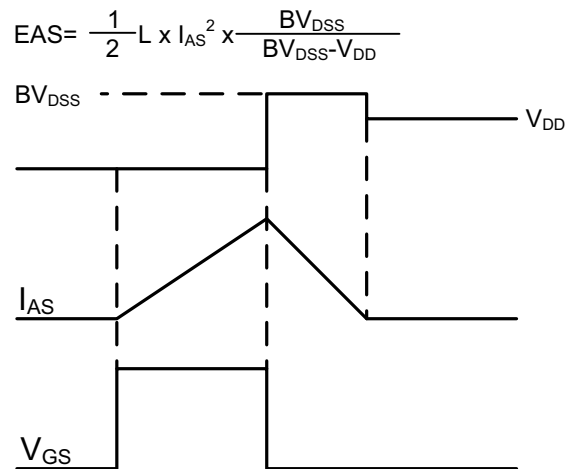
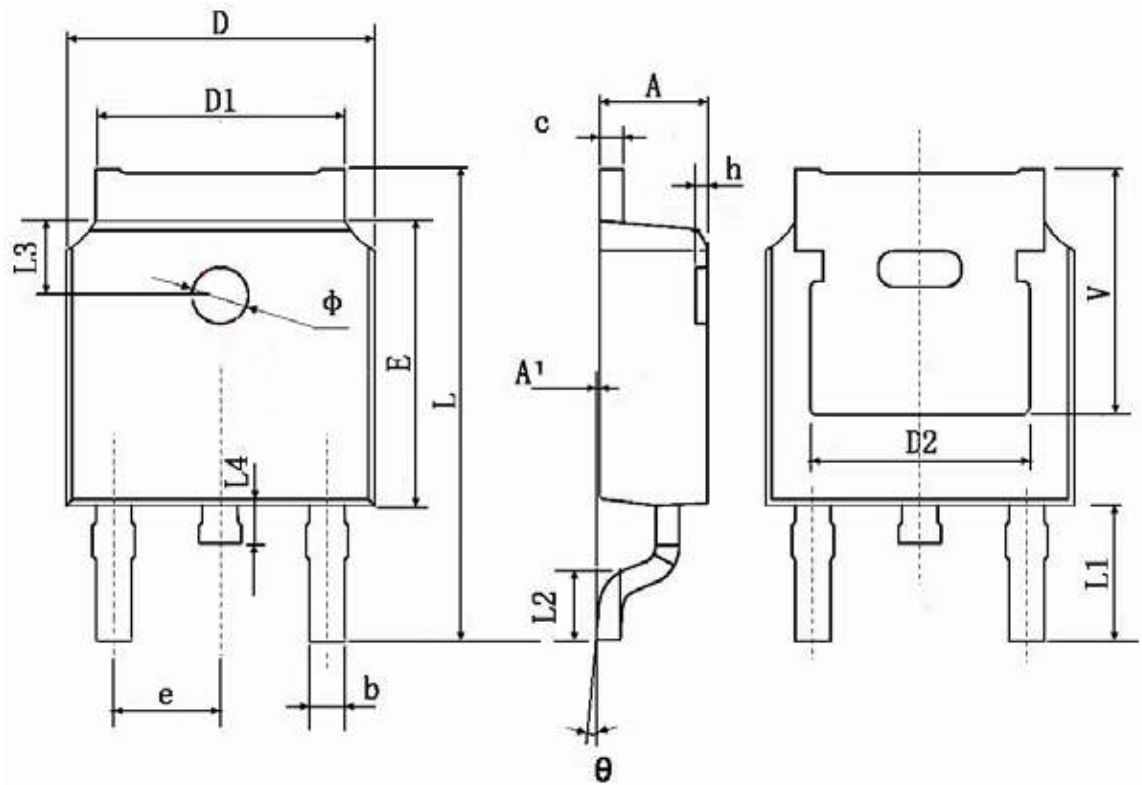

Fig.11 Unclamped Inductive Switching Waveform

## TO-252 Package Information



Symbol	Dimensions In Millimeters		Dimensions In Inches	
	Min.	Max.	Min.	Max.
A	2.200	2.400	0.087	0.094
A1	0.000	0.127	0.000	0.005
b	0.660	0.860	0.026	0.034
c	0.460	0.580	0.018	0.023
D	6.500	6.700	0.256	0.264
D1	5.100	5.460	0.201	0.215
D2	4.830 TYP.		0.190 TYP.	
E	6.000	6.200	0.236	0.244
e	2.186	2.386	0.086	0.094
L	9.800	10.400	0.386	0.409
L1	2.900 TYP.		0.114 TYP.	
L2	1.400	1.700	0.055	0.067
L3	1.600 TYP.		0.063 TYP.	
L4	0.600	1.000	0.024	0.039
$\Phi$	1.100	1.300	0.043	0.051
$\theta$	0°	8°	0°	8°
h	0.000	0.300	0.000	0.012
V	5.350 TYP.		0.211 TYP.	

## DISCLAIMER NOTICE

Rectron Inc reserves the right to make changes without notice to any product specification herein, to make corrections, modifications, enhancements or other changes. Rectron Inc or anyone on its behalf assumes no responsibility or liability for any errors or inaccuracies. Data sheet specifications and its information contained are intended to provide a product description only. "Typical" parameters which may be included on RECTRON data sheets and/ or specifications can and do vary in different applications and actual performance may vary over time. Rectron Inc does not assume any liability arising out of the application or use of any product or circuit.

Rectron products are not designed, intended or authorized for use in medical, life-saving implant or other applications intended for life-sustaining or other related applications where a failure or malfunction of component or circuitry may directly or indirectly cause injury or threaten a life without expressed written approval of Rectron Inc. Customers using or selling Rectron components for use in such applications do so at their own risk and shall agree to fully indemnify Rectron Inc and its subsidiaries harmless against all claims, damages and expenditures.