

TLC2654, TLC2654A, TLC2654Y Advanced LinCMOS™ LOW-NOISE CHOPPER-STABILIZED OPERATIONAL AMPLIFIERS

SLOS020E – NOVEMBER 1988 – REVISED FEBRUARY 1999

- **Input Noise Voltage**
0.5 μV (Peak-to-Peak) Typ, $f = 0$ to 1 Hz
1.5 μV (Peak-to-Peak) Typ, $f = 0$ to 10 Hz
47 nV/ $\sqrt{\text{Hz}}$ Typ, $f = 10$ Hz
13 nV/ $\sqrt{\text{Hz}}$ Typ, $f = 1$ kHz
- **High Chopping Frequency . . . 10 kHz Typ**
- **No Clock Noise Below 10 kHz**
- **No Intermodulation Error Below 5 kHz**
- **Low Input Offset Voltage**
10 μV Max (TLC2654A)
- **Excellent Offset Voltage Stability With Temperature . . . 0.05 $\mu\text{V}/^\circ\text{C}$ Max**
- **A_{VD} . . . 135 dB Min (TLC2654A)**
- **CMRR . . . 110 dB Min (TLC2654A)**
- **k_{SVR} . . . 120 dB Min (TLC2654A)**
- **Single-Supply Operation**
- **Common-Mode Input Voltage Range Includes the Negative Rail**
- **No Noise Degradation With External Capacitors Connected to $V_{\text{DD-}}$**

description

The TLC2654 and TLC2654A are low-noise chopper-stabilized operational amplifiers using the Advanced LinCMOS™ process. Combining this process with chopper-stabilization circuitry makes excellent dc precision possible. In addition, circuit techniques are added that give the TLC2654 and TLC2654A noise performance unsurpassed by similar devices.

Chopper-stabilization techniques provide for extremely high dc precision by continuously nulling input offset voltage even during variations in temperature, time, common-mode voltage, and power-supply voltage. The high chopping frequency of the TLC2654 and TLC2654A (see Figure 1) provides excellent noise performance in a frequency spectrum from near dc to 10 kHz. In addition, intermodulation or aliasing error is eliminated from frequencies up to 5 kHz.

This high dc precision and low noise, coupled with the extremely high input impedance of the CMOS input stage, makes the TLC2654 and TLC2654A ideal choices for a broad range of applications such as low-level, low-frequency thermocouple amplifiers and strain gauges and wide-bandwidth and subsonic circuits. For applications requiring even greater dc precision, use the TLC2652 or TLC2652A devices, which have a chopping frequency of 450 Hz.

D, JG, OR P PACKAGE
(TOP VIEW)

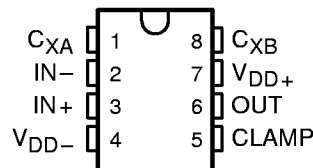

D, J, OR N PACKAGE
(TOP VIEW)

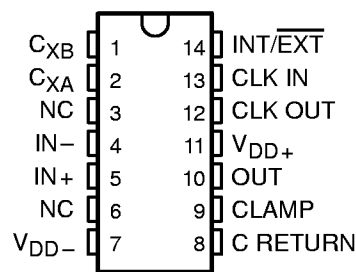

FK PACKAGE
(TOP VIEW)

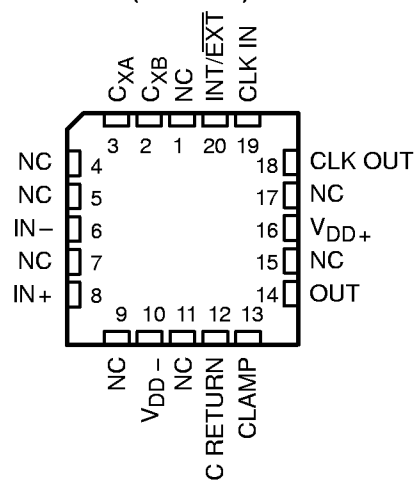

NC – No internal connection



Please be aware that an important notice concerning availability, standard warranty, and use in critical applications of Texas Instruments semiconductor products and disclaimers thereto appears at the end of this data sheet.

Advanced LinCMOS is a trademark of Texas Instruments Incorporated.

PRODUCTION DATA information is current as of publication date. Products conform to specifications per the terms of Texas Instruments standard warranty. Production processing does not necessarily include testing of all parameters.



POST OFFICE BOX 655303 • DALLAS, TEXAS 75265

Copyright © 1999, Texas Instruments Incorporated
On products compliant to MIL-PRF-38535, all parameters are tested unless otherwise noted. On all other products, production processing does not necessarily include testing of all parameters.

TLC2654, TLC2654A, TLC2654Y

Advanced LinCMOS™ LOW-NOISE CHOPPER-STABILIZED OPERATIONAL AMPLIFIERS

SLOS020E – NOVEMBER 1988 – REVISED FEBRUARY 1999

description (continued)

The TLC2654 and TLC2654A common-mode input voltage range includes the negative rail, thereby providing superior performance in either single-supply or split-supply applications, even at power supply voltage levels as low as ± 2.3 V.

Two external capacitors are required to operate the device; however, the on-chip chopper-control circuitry is transparent to the user. On devices in the 14-pin and 20-pin packages, the control circuitry is accessible, allowing the user the option of controlling the clock frequency with an external frequency source. In addition, the clock threshold of the TLC2554 and TLC2654A requires no level shifting when used in the single-supply configuration with a normal CMOS or TTL clock input.

Innovative circuit techniques used on the TLC2654 and TLC2654A allow exceptionally fast overload recovery time. An output clamp pin is available to reduce the recovery time even further.

The device inputs and outputs are designed to withstand -100 -mA surge currents without sustaining latch-up. In addition, the TLC2654 and TLC2654A incorporate internal ESD-protection circuits that prevent functional failures at voltages up to 2000 V as tested under MIL-STD-883C, Method 3015; however, exercise care in handling these devices, as exposure to ESD may result in degradation of the device parametric performance.

The C-suffix devices are characterized for operation from 0°C to 70°C . The I-suffix devices are characterized for operation from -40°C to 85°C . The Q-suffix devices are characterized for operation from -40°C to 125°C . The M-suffix devices are characterized for operation over the full military temperature range of -55°C to 125°C .

EQUIVALENT INPUT NOISE VOLTAGE
vs
FREQUENCY

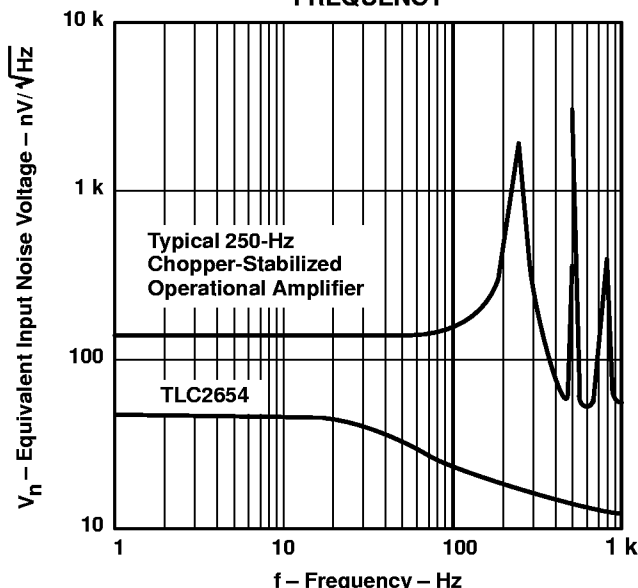

Figure 1

AVAILABLE OPTIONS

| T _A | V _{IO} max AT 25°C | PACKAGED DEVICES | | | | | | | CHIP FORM (Y) |
|----------------------|--------------------------------------|-----------------------------|---------------------------|-------------------------|-------------------------------|-------------------------|-------------------------|---------------------------|---------------------|
| | | 8 PIN | | | 14 PIN | | | 20 PIN | |
| | | SMALL OUTLINE (D) | CERAMIC DIP (JG) | PLASTIC DIP (P) | SMALL OUTLINE (D) | CERAMIC DIP (J) | PLASTIC DIP (N) | CERAMIC DIP (FK) | |
| 0°C to 70°C | 10 μV 20 mV | TLC2654AC-8D TLC2654C-8D | — — | TLC2654ACP TLC2654CP | TLC2654AC-14D TLC2654C-14D | — — | TLC2654ACN TLC2654CN | — — | TLC2654Y |
| -40°C to 85°C | 10 μV 20 μV | TLC2654AI-8D TLC2654I-8D | — — | TLC2654AIP TLC2654IP | TLC2654AI-14D TLC2654I-14D | — — | TLC2654AIN TLC2654IN | — — | — |
| -40°C to 125°C | 10 μV 20 μV | TLC2654AQ-8D TLC2654Q-8D | — — | — — | — — | — — | — — | — — | — |
| -55°C to 125°C | 10 μV 20 μV | TLC2654AM-8D TLC2654M-8D | TLC2654AMJG TLC2654MJG | TLC2654AMP TLC2654MP | TLC2654AM-14D TLC2654M-14D | TLC2654AMJ TLC2654MJ | TLC2654AMN TLC2654MN | TLC2654AMFK TLC2654MFK | — |

The 8-pin and 14-pin D packages are available taped and reeled. Add R suffix to device type (e.g., TLC2654AC-8DR).



TLC2654, TLC2654A, TLC2654Y Advanced LinCMOS™ LOW-NOISE CHOPPER-STABILIZED OPERATIONAL AMPLIFIERS

SLOS020E – NOVEMBER 1988 – REVISED FEBRUARY 1999

functional block diagram

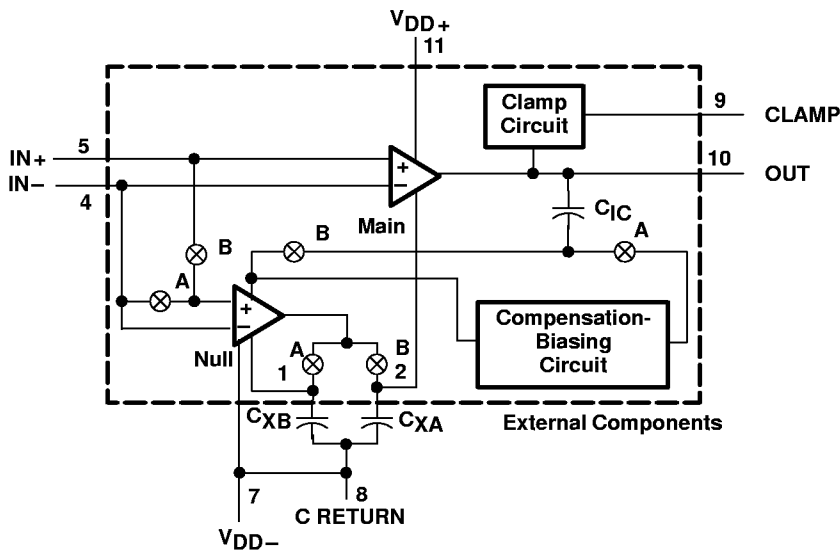

Pin numbers shown are for the D (14 pin), J, and N packages.

TLC2654Y chip information

This chip, when properly assembled, displays characteristics similar to the TLC2654C. Thermal compression or ultrasonic bonding may be used on the doped-aluminum bonding pads. Chips may be mounted with conductive epoxy or a gold-silicon preform.

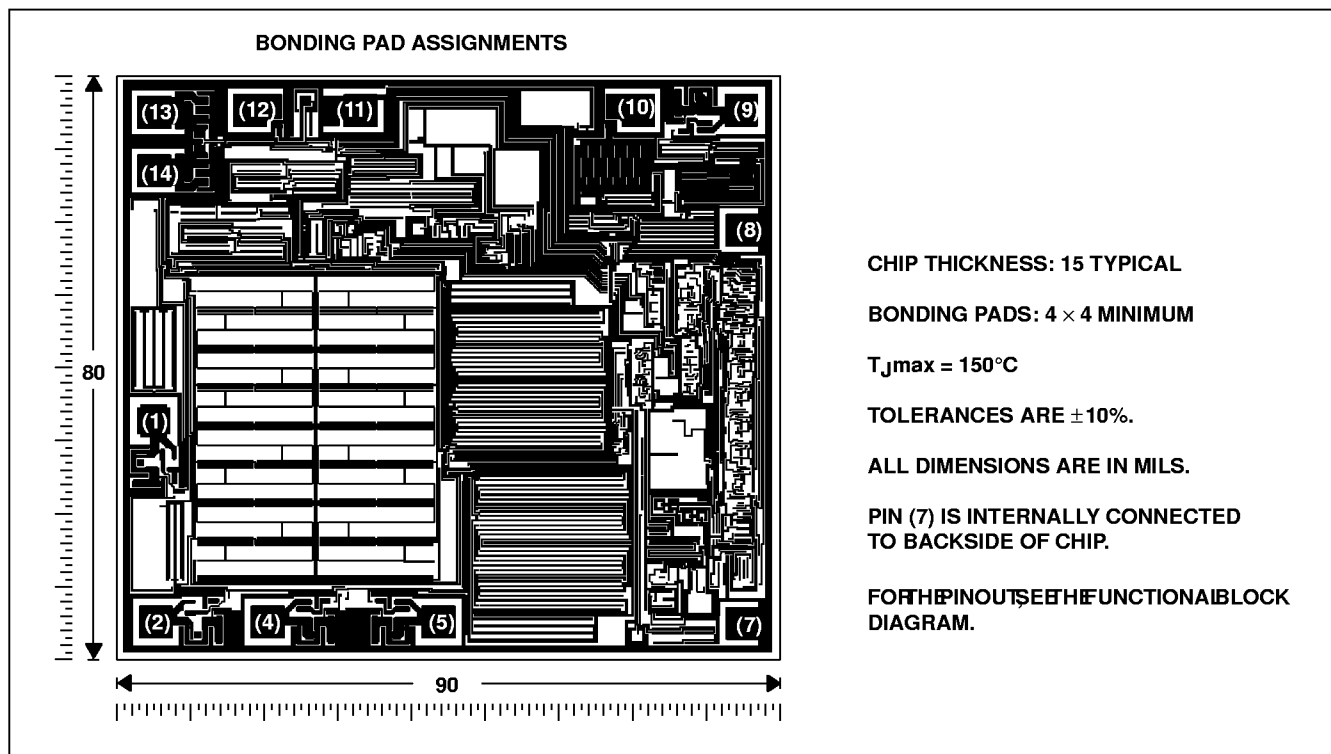

TLC2654, TLC2654A, TLC2654Y

Advanced LinCMOS™ LOW-NOISE CHOPPER-STABILIZED OPERATIONAL AMPLIFIERS

SLOS020E – NOVEMBER 1988 – REVISED FEBRUARY 1999

absolute maximum ratings over operating free-air temperature range (unless otherwise noted)†

| | |
|--|--------------------------------|
| Supply voltage, V_{DD+} (see Note 1) | 8 V |
| Supply voltage, V_{DD-} (see Note 1) | -8 V |
| Differential input voltage, V_{ID} (see Note 2) | ± 16 V |
| Input voltage, V_I (any input, see Note 1) | ± 8 V |
| Voltage range on CLK IN and INT/EXT | V_{DD-} to $V_{DD+} + 5.2$ V |
| Input current, I_I (each input) | ± 5 mA |
| Output current, I_O | ± 50 mA |
| Duration of short-circuit current at (or below) 25°C (see Note 3) | unlimited |
| Current into CLK IN and INT/EXT | ± 5 mA |
| Continuous total dissipation | See Dissipation Rating Table |
| Operating free-air temperature range, T_A : C suffix | 0°C to 70°C |
| I suffix | -40°C to 85°C |
| Q suffix | -40°C to 125°C |
| M suffix | -55°C to 125°C |
| Storage temperature range | -65°C to 150°C |
| Case temperature for 60 seconds: FK package | 260°C |
| Lead temperature 1,6 mm (1/16 inch) from case for 10 seconds: D, N, or P package | 260°C |
| Lead temperature 1,6 mm (1/16 inch) from case for 60 seconds: J or JG package | 300°C |

† Stresses beyond those listed under “absolute maximum ratings” may cause permanent damage to the device. These are stress ratings only, and functional operation of the device at these or any other conditions beyond those indicated under “recommended operating conditions” is not implied. Exposure to absolute-maximum-rated conditions for extended periods may affect device reliability.

- NOTES:
- All voltage values, except differential voltages, are with respect to the midpoint between V_{DD+} and V_{DD-} .
 - Differential voltages are at IN+ with respect to IN-.
 - The output may be shorted to either supply. Temperature and/or supply voltages must be limited to ensure that the maximum dissipation rating is not exceeded.

DISSIPATION RATING TABLE

| PACKAGE | $T_A \leq 25^\circ\text{C}$ POWER RATING | DERATING FACTOR ABOVE $T_A = 25^\circ\text{C}$ | $T_A = 70^\circ\text{C}$ POWER RATING | $T_A = 85^\circ\text{C}$ POWER RATING | $T_A = 125^\circ\text{C}$ POWER RATING |
|------------|---|---|--|--|---|
| D (8 pin) | 725 mW | 5.8 mW/°C | 464 mW | 377 mW | 145 mW |
| D (14 pin) | 950 mW | 7.6 mW/°C | 608 mW | 494 mW | 190 mW |
| FK | 1375 mW | 11.0 mW/°C | 880 mW | 715 mW | 275 mW |
| J | 1375 mW | 11.0 mW/°C | 880 mW | 715 mW | 275 mW |
| JG | 1050 mW | 8.4 mW/°C | 672 mW | 546 mW | 210 mW |
| N | 1150 mW | 9.2 mW/°C | 736 mW | 598 mW | 230 mW |
| P | 1000 mW | 8.0 mW/°C | 640 mW | 520 mW | 200 mW |

recommended operating conditions

| | C SUFFIX | | I SUFFIX | | Q SUFFIX | | M SUFFIX | | UNIT |
|---------------------------------------|-----------|-----------------|-----------|-----------------|-----------|-----------------|-----------|-----------------|------|
| | MIN | MAX | MIN | MAX | MIN | MAX | MIN | MAX | |
| Supply voltage, $V_{DD\pm}$ | ± 2.3 | ± 8 | ± 2.3 | ± 8 | ± 2.3 | ± 8 | ± 2.3 | ± 8 | V |
| Common-mode input voltage, V_{IC} | V_{DD-} | $V_{DD+} - 2.3$ | V_{DD-} | $V_{DD+} - 2.3$ | V_{DD-} | $V_{DD+} - 2.3$ | V_{DD-} | $V_{DD+} - 2.3$ | V |
| Clock input voltage | V_{DD-} | $V_{DD-} + 5$ | V_{DD-} | $V_{DD-} + 5$ | V_{DD-} | $V_{DD-} + 5$ | V_{DD-} | $V_{DD-} + 5$ | V |
| Operating free-air temperature, T_A | 0 | 70 | -40 | 85 | -40 | 125 | -55 | 125 | °C |



TLC2654, TLC2654A, TLC2654Y
Advanced LinCMOS™ LOW-NOISE CHOPPER-STABILIZED
OPERATIONAL AMPLIFIERS

SLOS020E – NOVEMBER 1988 – REVISED FEBRUARY 1999

electrical characteristics at specified free-air temperature, $V_{DD\pm} = \pm 5$ V (unless otherwise noted)

| PARAMETER | TEST CONDITIONS | T_A † | TLC2654C | | | TLC2654AC | | | UNIT |
|---|--|------------|-----------|------|-----|-----------|------|------------------|------|
| | | | MIN | TYP | MAX | MIN | TYP | MAX | |
| V_{IO} Input offset voltage (see Note 4) | $V_{IC} = 0, R_S = 50 \Omega$ | 25°C | 5 | 20 | | 4 | 10 | μV | |
| | | Full range | | | 34 | | 24 | | |
| α_{VIO} Temperature coefficient of input offset voltage | | Full range | 0.01 | 0.05 | | 0.01 | 0.05 | $\mu V/^\circ C$ | |
| Input offset voltage long-term drift (see Note 5) | | 25°C | 0.003 | 0.06 | | 0.003 | 0.02 | $\mu V/mo$ | |
| I_{IO} Input offset current | | 25°C | 30 | | | 30 | | pA | |
| | | Full range | | | 150 | | 150 | | |
| I_{IB} Input bias current | | 25°C | 50 | | | 50 | | pA | |
| | | Full range | | | 150 | | 150 | | |
| V_{ICR} Common-mode input voltage range | $R_S = 50 \Omega$ | Full range | -5 to 2.7 | | | -5 to 2.7 | V | | |
| V_{OM+} Maximum positive peak output voltage swing | $R_L = 10 k\Omega$, See Note 6 | 25°C | 4.7 | 4.8 | | 4.7 | 4.8 | V | |
| | | Full range | 4.7 | | | 4.7 | | | |
| V_{OM-} Maximum negative peak output voltage swing | $R_L = 10 k\Omega$, See Note 6 | 25°C | -4.7 | -4.9 | | -4.7 | -4.9 | V | |
| | | Full range | -4.7 | | | -4.7 | | | |
| A_{VD} Large-signal differential voltage amplification | $V_O = \pm 4$ V, $R_L = 10 k\Omega$ | 25°C | 120 | 155 | | 135 | 155 | dB | |
| | | Full range | 120 | | | 130 | | | |
| Internal chopping frequency | | 25°C | 10 | | | 10 | kHz | | |
| Clamp on-state current | $R_L = 100 k\Omega$ | 25°C | 25 | | | 25 | | μA | |
| | | Full range | 25 | | | 25 | | | |
| Clamp off-state current | $V_O = -4$ V to 4 V | 25°C | | | 100 | | 100 | pA | |
| | | Full range | | | 100 | | 100 | | |
| CMRR Common-mode rejection ratio | $V_O = 0, V_{IC} = V_{ICRmin}, R_S = 50 \Omega$ | 25°C | 105 | 125 | | 110 | 125 | dB | |
| | | Full range | 105 | | | 110 | | | |
| k_{SVR} Supply voltage rejection ratio ($\Delta V_{DD\pm}/\Delta V_{IO}$) | $V_{DD\pm} = \pm 2.3$ V to ± 8 V, $V_O = 0, R_S = 50 \Omega$ | 25°C | 110 | 125 | | 120 | 125 | dB | |
| | | Full range | 110 | | | 120 | | | |
| I_{DD} Supply current | $V_O = 0, \text{ No load}$ | 25°C | | 1.5 | 2.4 | | 1.5 | 2.4 | mA |
| | | Full range | | | 2.5 | | | 2.5 | |

† Full range is 0°C to 70°C.

- NOTES: 4. This parameter is not production tested full range. Thermocouple effects preclude measurement of the actual V_{IO} of these devices in high-speed automated testing. V_{IO} is measured to a limit determined by the test equipment capability at the temperature extremes. The test ensures that the stabilization circuitry is performing properly.
5. Typical values are based on the input offset voltage shift observed through 168 hours of operating life test at $T_A = 150^\circ C$ extrapolated to $T_A = 25^\circ$ using the Arrhenius equation and assuming an activation energy of 0.96 eV.
6. Output clamp is not connected.



TLC2654, TLC2654A, TLC2654Y
Advanced LinCMOS™ LOW-NOISE CHOPPER-STABILIZED
OPERATIONAL AMPLIFIERS

SLOS020E – NOVEMBER 1988 – REVISED FEBRUARY 1999

operating characteristics at specified free-air temperature, $V_{DD\pm} = \pm 5\text{ V}$

| PARAMETER | TEST CONDITIONS | T _A † | TLC2654C | | | TLC2654AC | | | UNIT |
|--|--|------------------|----------|-------|-----|-----------|-----|--------|------|
| | | | MIN | TYP | MAX | MIN | TYP | MAX | |
| SR+ Positive slew rate at unity gain | V _O = ±2.3 V, R _L = 10 kΩ, C _L = 100 pF | 25°C | 1.5 | 2 | | 1.5 | 2 | | V/μs |
| | | Full range | 1.3 | | | 1.3 | | | |
| SR- Negative slew rate at unity gain | | 25°C | 2.3 | 3.7 | | 2.3 | 3.7 | | V/μs |
| | | Full range | 1.7 | | | 1.7 | | | |
| V _n Equivalent input noise voltage (see Note 7) | f = 10 Hz | 25°C | | 47 | | 47 | 75 | nV/√Hz | |
| | f = 1 kHz | | | 13 | | 13 | 20 | | |
| V _{N(PP)} Peak-to-peak equivalent input noise voltage | f = 0 to 1 Hz | 25°C | | 0.5 | | 0.5 | | μV | |
| | f = 0 to 10 Hz | | | 1.5 | | 1.5 | | | |
| I _n Equivalent input noise current | f = 10 kHz | 25°C | | 0.004 | | 0.004 | | pA/√Hz | |
| Gain-bandwidth product | f = 10 kHz, R _L = 10 kΩ, C _L = 100 pF | 25°C | | 1.9 | | 1.9 | | MHz | |
| φ _m Phase margin at unity gain | R _L = 10 kΩ, C _L = 100 pF | 25°C | | 48° | | 48° | | | |

† Full range is 0°C to 70°C.

NOTE 7: This parameter is tested on a sample basis for the TLC2654A. For other test requirements, please contact the factory. This statement has no bearing on testing or nontesting of other parameters.



TLC2654, TLC2654A, TLC2654Y
Advanced LinCMOS™ LOW-NOISE CHOPPER-STABILIZED
OPERATIONAL AMPLIFIERS

SLOS020E – NOVEMBER 1988 – REVISED FEBRUARY 1999

electrical characteristics at specified free-air temperature, $V_{DD} = \pm 5$ V (unless otherwise noted)

| PARAMETER | TEST CONDITIONS | T_A † | TLC2654I | | | TLC2654AI | | | UNIT |
|--|---|------------|-----------|-------|------|-----------|-------|---------|------------------|
| | | | MIN | TYP | MAX | MIN | TYP | MAX | |
| V_{IO} Input offset voltage (see Note 4) | $V_{IC} = 0, R_S = 50 \Omega$ | 25°C | | 5 | 20 | | 4 | 10 | μV |
| | | Full range | | | 40 | | | 30 | |
| α_{VIO} Temperature coefficient of input offset voltage | | Full range | | 0.01 | 0.05 | | 0.01 | 0.05 | $\mu V/^\circ C$ |
| Input offset voltage long-term drift (see Note 5) | | 25°C | | 0.003 | 0.06 | | 0.003 | 0.02 | $\mu V/mo$ |
| I_{IO} Input offset current | | 25°C | | | 30 | | | 30 | pA |
| | | Full range | | | 200 | | | 200 | |
| I_{IB} Input bias current | 25°C | | | 50 | | | 50 | pA | |
| | Full range | | | 200 | | | 200 | | |
| V_{ICR} Common-mode input voltage range | $R_S = 50 \Omega$ | Full range | -5 to 2.7 | | | -5 to 2.7 | | V | |
| V_{OM+} Maximum positive peak output voltage swing | $R_L = 10 k\Omega$, See Note 6 | 25°C | 4.7 | 4.8 | | 4.7 | 4.8 | V | |
| | | Full range | 4.7 | | | 4.7 | | | |
| V_{OM-} Maximum negative peak output voltage swing | $R_L = 10 k\Omega$, See Note 6 | 25°C | -4.7 | -4.9 | | -4.7 | -4.9 | V | |
| | | Full range | -4.7 | | | -4.7 | | | |
| A_{VD} Large-signal differential voltage amplification | $V_O = \pm 4$ V, $R_L = 10 k\Omega$ | 25°C | 120 | 155 | | 135 | 155 | dB | |
| | | Full range | 120 | | | 125 | | | |
| Internal chopping frequency | | 25°C | | 10 | | | 10 | kHz | |
| Clamp on-state current | $R_L = 100 k\Omega$ | 25°C | | 25 | | | 25 | μA | |
| | | Full range | | 25 | | | 25 | | |
| Clamp off-state current | $V_O = -4$ V to 4 V | 25°C | | | 100 | | | 100 | pA |
| | | Full range | | | 100 | | | 100 | |
| CMRR Common-mode rejection ratio | $V_O = 0, V_{IC} = V_{ICRmin}, R_S = 50 \Omega$ | 25°C | 105 | 125 | | 110 | 125 | dB | |
| | | Full range | 105 | | | 110 | | | |
| k_{SVR} Supply voltage rejection ratio ($\Delta V_{DD} / \Delta V_{IO}$) | $V_{DD} = \pm 2.3$ V to ± 8 V, $V_O = 0, R_S = 50 \Omega$ | 25°C | 110 | 125 | | 120 | 125 | dB | |
| | | Full range | 110 | | | 120 | | | |
| I_{DD} Supply current | $V_O = 0, \text{ No load}$ | 25°C | | 1.5 | 2.4 | | 1.5 | 2.4 | mA |
| | | Full range | | | 2.5 | | | 2.5 | |

† Full range is $-40^\circ C$ to $85^\circ C$

- NOTES: 4. This parameter is not production tested full range. Thermocouple effects preclude measurement of the actual V_{IO} of these devices in high-speed automated testing. V_{IO} is measured to a limit determined by the test equipment capability at the temperature extremes. The test ensures that the stabilization circuitry is performing properly.
5. Typical values are based on the input offset voltage shift observed through 168 hours of operating life test at $T_A = 150^\circ C$ extrapolated to $T_A = 25^\circ C$ using the Arrhenius equation and assuming an activation energy of 0.96 eV.
6. Output clamp is not connected.



TLC2654, TLC2654A, TLC2654Y
Advanced LinCMOS™ LOW-NOISE CHOPPER-STABILIZED
OPERATIONAL AMPLIFIERS

SLOS020E – NOVEMBER 1988 – REVISED FEBRUARY 1999

operating characteristics at specified free-air temperature, $V_{DD\pm} = \pm 5\text{ V}$

| PARAMETER | TEST CONDITIONS | T _A † | TLC2654I | | | TLC2654AI | | | UNIT |
|--|--|------------------|----------|-------|-----|-----------|-----|--------|------|
| | | | MIN | TYP | MAX | MIN | TYP | MAX | |
| SR+ Positive slew rate at unity gain | V _O = ±2.3 V, R _L = 10 kΩ, C _L = 100 pF | 25°C | 1.5 | 2 | | 1.5 | 2 | | V/μs |
| | | Full range | 1.2 | | | 1.2 | | | |
| SR– Negative slew rate at unity gain | | 25°C | 2.3 | 3.7 | | 2.3 | 3.7 | | V/μs |
| | | Full range | 1.5 | | | 1.5 | | | |
| V _n Equivalent input noise voltage (see Note 7) | f = 10 Hz | 25°C | | 47 | | 47 | 75 | nV/√Hz | |
| | f = 1 kHz | | | 13 | | 13 | 20 | | |
| V _{N(PP)} Peak-to-peak equivalent input noise voltage | f = 0 to 1 Hz | 25°C | | 0.5 | | 0.5 | | μV | |
| | f = 0 to 10 Hz | | | 1.5 | | 1.5 | | | |
| I _n Equivalent input noise current | f = 10 kHz | 25°C | | 0.004 | | 0.004 | | pA/√Hz | |
| Gain-bandwidth product | f = 10 kHz, R _L = 10 kΩ, C _L = 100 pF | 25°C | | 1.9 | | 1.9 | | MHz | |
| φ _m Phase margin at unity gain | R _L = 10 kΩ, C _L = 100 pF | 25°C | | 48° | | 48° | | | |

† Full range is –40°C to 85°C.

NOTE 7: This parameter is tested on a sample basis for the TLC2654A. For other test requirements, please contact the factory. This statement has no bearing on testing or nontesting of other parameters.



TLC2654, TLC2654A, TLC2654Y Advanced LinCMOS™ LOW-NOISE CHOPPER-STABILIZED OPERATIONAL AMPLIFIERS

SLOS020E – NOVEMBER 1988 – REVISED FEBRUARY 1999

electrical characteristics at specified free-air temperature, $V_{DD\pm} = \pm 5$ V (unless otherwise noted)

| PARAMETER | TEST CONDITIONS | T_A † | TLC2654Q TLC2654M | | | TLC2654AQ TLC2654AM | | | UNIT |
|---|--|------------|----------------------|-------|-----------|------------------------|------------------|-----|------|
| | | | MIN | TYP | MAX | MIN | TYP | MAX | |
| V_{IO} Input offset voltage (see Note 4) | $V_{IC} = 0, R_S = 50 \Omega$ | 25°C | 5 20 | | 4 10 | | μV | | |
| | | Full range | 50 | | 40 | | | | |
| α_{VIO} Temperature coefficient of input offset voltage | | Full range | 0.01 | 0.05* | 0.01 | 0.05* | $\mu V/^\circ C$ | | |
| Input offset voltage long-term drift (see Note 5) | | 25°C | 0.003 | 0.06* | 0.003 | 0.02* | $\mu V/mo$ | | |
| I_{IO} Input offset current | | 25°C | 30 | | 30 | | pA | | |
| | | Full range | 500 | | 500 | | | | |
| I_{IB} Input bias current | 25°C | 50 | | 50 | | pA | | | |
| | Full range | 500 | | 500 | | | | | |
| V_{ICR} Common-mode input voltage range | $R_S = 50 \Omega$ | Full range | -5 to 2.7 | | -5 to 2.7 | | V | | |
| V_{OM+} Maximum positive peak output voltage swing | $R_L = 10 k\Omega$, See Note 6 | 25°C | 4.7 | 4.8 | 4.7 | 4.8 | V | | |
| | | Full range | 4.7 | | 4.7 | | | | |
| V_{OM-} Maximum negative peak output voltage swing | $R_L = 10 k\Omega$, See Note 6 | 25°C | -4.7 | -4.9 | -4.7 | -4.9 | V | | |
| | | Full range | -4.7 | | -4.7 | | | | |
| A_{VD} Large-signal differential voltage amplification | $V_O = \pm 4$ V, $R_L = 10 k\Omega$ | 25°C | 120 | 155 | 135 | 155 | dB | | |
| | | Full range | 120 | | 120 | | | | |
| Internal chopping frequency | | 25°C | 10 | | 10 | | kHz | | |
| Clamp on-state current | $R_L = 100 k\Omega$ | 25°C | 25 | | 25 | | μA | | |
| | | Full range | 25 | | 25 | | | | |
| Clamp off-state current | $V_O = -4$ V to 4 V | 25°C | 100 | | 100 | | pA | | |
| | | Full range | 500 | | 500 | | | | |
| CMRR Common-mode rejection ratio | $V_O = 0, V_{IC} = V_{ICRmin}, R_S = 50 \Omega$ | 25°C | 105 | 125 | 110 | 125 | dB | | |
| | | Full range | 105 | | 110 | | | | |
| k_{SVR} Supply voltage rejection ratio ($\Delta V_{DD\pm}/\Delta V_{IO}$) | $V_{DD\pm} = \pm 2.3$ V to ± 8 V, $V_O = 0, R_S = 50 \Omega$ | 25°C | 110 | 125 | 120 | 125 | dB | | |
| | | Full range | 105 | | 115 | | | | |
| I_{DD} Supply current | $V_O = 0$, No load | 25°C | 1.5 | 2.4 | 1.5 | 2.4 | mA | | |
| | | Full range | 2.5 | | 2.5 | | | | |

* On products complaint to MIL-STD-883, Class B, this parameter is not production tested.

† Full range is -40° to $125^\circ C$ for Q suffix, -55° to $125^\circ C$ for M suffix.

- NOTES:
- This parameter is not production tested full range. Thermocouple effects preclude measurement of the actual V_{IO} of these devices in high-speed automated testing. V_{IO} is measured to a limit determined by the test equipment capability at the temperature extremes. The test ensures that the stabilization circuitry is performing properly.
 - Typical values are based on the input offset voltage shift observed through 168 hours of operating life test at $T_A = 150^\circ C$ extrapolated to $T_A = 25^\circ C$ using the Arrhenius equation and assuming an activation energy of 0.96 eV.
 - Output clamp is not connected.



TLC2654, TLC2654A, TLC2654Y
Advanced LinCMOS™ LOW-NOISE CHOPPER-STABILIZED
OPERATIONAL AMPLIFIERS

SLOS020E – NOVEMBER 1988 – REVISED FEBRUARY 1999

operating characteristics at specified free-air temperature, $V_{DD\pm} = \pm 5\text{ V}$

| PARAMETER | TEST CONDITIONS | T_A † | TLC2654Q TLC2654M TLC2654AQ TLC2654AM | | | UNIT |
|---|--|------------|--|-----|------------------------|------------|
| | | | MIN | TYP | MAX | |
| SR+ Positive slew rate at unity gain | $V_O = \pm 2.3\text{ V}$, $R_L = 10\text{ k}\Omega$, $C_L = 100\text{ pF}$ | 25°C | 1.5 | 2 | | V/ μ s |
| | | Full range | 1.1 | | | |
| SR- Negative slew rate at unity gain | | 25°C | 2.3 | 3.7 | | V/ μ s |
| | | Full range | 1.3 | | | |
| V_n Equivalent input noise voltage | f = 10 Hz | 25°C | 47 | | nV/ $\sqrt{\text{Hz}}$ | |
| | f = 1 kHz | 25°C | 13 | | | |
| $V_{N(PP)}$ Peak-to-peak equivalent input noise voltage | f = 0 to 1 Hz | 25°C | 0.5 | | μ V | |
| | f = 0 to 10 Hz | 25°C | 1.5 | | | |
| I_n Equivalent input noise current | f = 1 kHz | 25°C | 0.004 | | pA/ $\sqrt{\text{Hz}}$ | |
| Gain-bandwidth product | f = 10 kHz, $R_L = 10\text{ k}\Omega$, $C_L = 100\text{ pF}$ | 25°C | 1.9 | | MHz | |
| ϕ_m Phase margin at unity gain | $R_L = 10\text{ k}\Omega$, $C_L = 100\text{ pF}$ | 25°C | 48° | | | |

† Full range is -40° to 125°C for Q suffix, -55° to 125°C for M suffix.



TLC2654, TLC2654A, TLC2654Y
Advanced LinCMOS™ LOW-NOISE CHOPPER-STABILIZED
OPERATIONAL AMPLIFIERS

SLOS020E – NOVEMBER 1988 – REVISED FEBRUARY 1999

electrical characteristics, $V_{DD\pm} = \pm 5\text{ V}$, $T_A = 25^\circ\text{C}$ (unless otherwise noted)

| PARAMETER | | TEST CONDITIONS | TLC2654Y | | | UNIT |
|-----------|---|--|-----------------|-------|------|-------------------------|
| | | | MIN | TYP | MAX | |
| V_{IO} | Input offset voltage (see Note 4) | $V_{IC} = 0$, $R_S = 50\ \Omega$ | | 5 | 20 | μV |
| | Input offset voltage long-term drift (see Note 5) | | | 0.003 | 0.06 | $\mu\text{V}/\text{mo}$ |
| I_{IO} | Input offset current | | | 30 | | pA |
| I_{IB} | Input bias current | | | 50 | | pA |
| V_{ICR} | Common-mode input voltage range | $R_S = 50\ \Omega$ | -5 to 2.7 | | | V |
| V_{OM+} | Maximum positive peak output voltage swing | $R_L = 10\ \text{k}\Omega$, See Note 5 | 4.7 | 4.8 | | V |
| V_{OM-} | Maximum negative peak output voltage swing | $R_L = 10\ \text{k}\Omega$, See Note 5 | -4.7 | -4.9 | | V |
| A_{VD} | Large-signal differential voltage amplification | $V_O = \pm 4\ \text{V}$, $R_L = 10\ \text{k}\Omega$ | 120 | 155 | | dB |
| f_{ch} | Internal chopping frequency | | | 10 | | Hz |
| | Clamp on-state current | $R_L = 100\ \text{k}\Omega$ | 25 | | | μA |
| | Clamp off-state current | $V_O = -4\ \text{V}$ to $4\ \text{V}$ | | | 100 | pA |
| CMRR | Common-mode rejection ratio | $V_{IC} = V_{ICRmin}$, $V_O = 0$, $R_S = 50\ \Omega$ | 105 | 125 | | dB |
| k_{SVR} | Supply voltage rejection ratio ($\Delta V_{DD\pm} / \Delta V_{IO}$) | $V_{DD\pm} = \pm 2.3\ \text{V}$ to $\pm 8\ \text{V}$, $V_O = 0$, $R_S = 50\ \Omega$ | 110 | 125 | | dB |
| I_{DD} | Supply current | $V_O = 0$, No load | | 1.5 | 2.4 | mA |

- NOTES: 4. This parameter is not production tested full range. Thermocouple effects preclude measurement of the actual V_{IO} of these devices in high-speed automated testing. V_{IO} is measured to a limit determined by the test equipment capability at the temperature extremes. The test ensures that the stabilization circuitry is performing properly.
5. Typical values are based on the input offset voltage shift observed through 168 hours of operating life test at $T_A = 150^\circ\text{C}$ extrapolated to $T_A = 25^\circ\text{C}$ using the Arrhenius equation and assuming an activation energy of 0.96 eV.

operating characteristics, $V_{DD\pm} = \pm 5\text{ V}$, $T_A = 25^\circ\text{C}$

| PARAMETER | | TEST CONDITIONS | TLC2654Y | | | UNIT |
|-------------|---|--|----------|-------|-----|------------------------------|
| | | | MIN | TYP | MAX | |
| SR+ | Positive slew rate at unity gain | $V_O = \pm 2.3\ \text{V}$, $C_L = 100\ \text{pF}$, $R_L = 10\ \text{k}\Omega$ | 1.5 | 2 | | $\text{V}/\mu\text{s}$ |
| SR- | Negative slew rate at unity gain | | 2.3 | 3.7 | | $\text{V}/\mu\text{s}$ |
| V_n | Equivalent input noise voltage | $f = 10\ \text{Hz}$ | | 47 | | $\text{nV}/\sqrt{\text{Hz}}$ |
| | | $f = 1\ \text{kHz}$ | | 13 | | |
| $V_{N(PP)}$ | Peak-to-peak equivalent input noise voltage | $f = 0$ to $1\ \text{Hz}$ | | 0.5 | | μV |
| | | $f = 0$ to $10\ \text{Hz}$ | | 1.5 | | |
| I_n | Equivalent input noise current | $f = 1\ \text{kHz}$ | | 0.004 | | $\text{pA}/\sqrt{\text{Hz}}$ |
| | Gain-bandwidth product | $f = 10\ \text{kHz}$, $C_L = 100\ \text{pF}$, $R_L = 10\ \text{k}\Omega$ | | 1.9 | | MHz |
| ϕ_m | Phase margin at unity gain | $R_L = 10\ \text{k}\Omega$, $C_L = 100\ \text{pF}$ | | 48° | | |



TLC2654, TLC2654A, TLC2654Y
Advanced LinCMOS™ LOW-NOISE CHOPPER-STABILIZED
OPERATIONAL AMPLIFIERS

SLOS020E – NOVEMBER 1988 – REVISED FEBRUARY 1999

TYPICAL CHARACTERISTICS

Table of Graphs

| | | | FIGURE |
|-------------|---|------------------------------|-------------------|
| V_{IO} | Input offset voltage | Distribution | 1 |
| | Normalized input offset voltage | vs Chopping frequency | 2 |
| I_{IO} | Input offset current | vs Chopping frequency | 3 |
| | | vs Free-air temperature | 4 |
| I_{IB} | Input bias current | vs Common-mode input voltage | 5 |
| | | vs Chopping frequency | 6 |
| | | vs Free-air temperature | 7 |
| | Clamp current | vs Output voltage | 8 |
| V_{OM} | Maximum peak output voltage swing | vs Output current | 9 |
| | | vs Free-air temperature | 10 |
| $V_{O(PP)}$ | Maximum peak-to-peak output voltage swing | vs Frequency | 11 |
| CMRR | Common-mode rejection ratio | vs Frequency | 12 |
| A_{VD} | Large-signal differential voltage amplification | vs Frequency | 13 |
| | | vs Free-air temperature | 14 |
| | Chopping frequency | vs Supply voltage | 15 |
| | | vs Free-air temperature | 16 |
| I_{DD} | Supply current | vs Supply voltage | 17 |
| | | vs Free-air temperature | 18 |
| I_{OS} | Short-circuit output current | vs Supply voltage | 19 |
| | | vs Free-air temperature | 20 |
| SR | Slew rate | vs Supply voltage | 21 |
| | | vs Free-air temperature | 22 |
| | Pulse response | Small signal | 23 |
| | | Large signal | 24 |
| $V_{N(PP)}$ | Peak-to-peak input noise voltage | vs Chopping frequency | 25, 26 |
| V_n | Equivalent input noise voltage | vs Frequency | 27 |
| kSVR | Supply voltage rejection ratio | vs Frequency | 28 |
| | | Gain-bandwidth product | vs Supply voltage |
| | | vs Free-air temperature | 30 |
| ϕ_m | Phase margin | vs Supply voltage | 31 |
| | | vs Load capacitance | 32 |
| | Phase shift | vs Frequency | 13 |



TYPICAL CHARACTERISTICS†

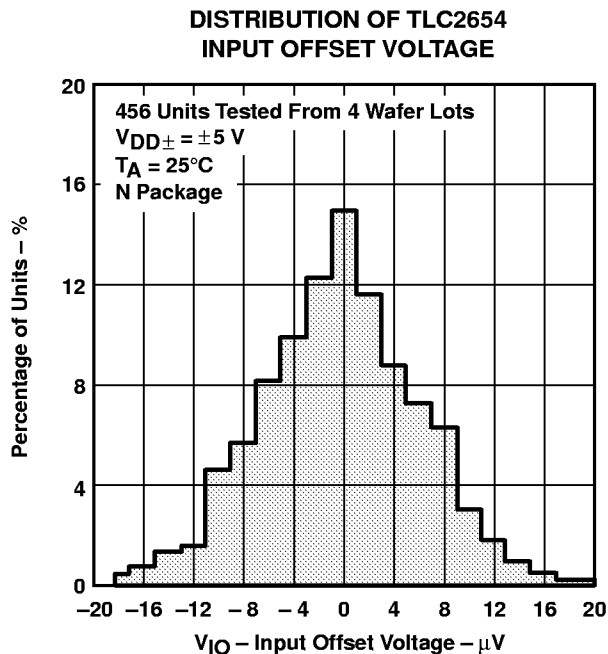

Figure 2

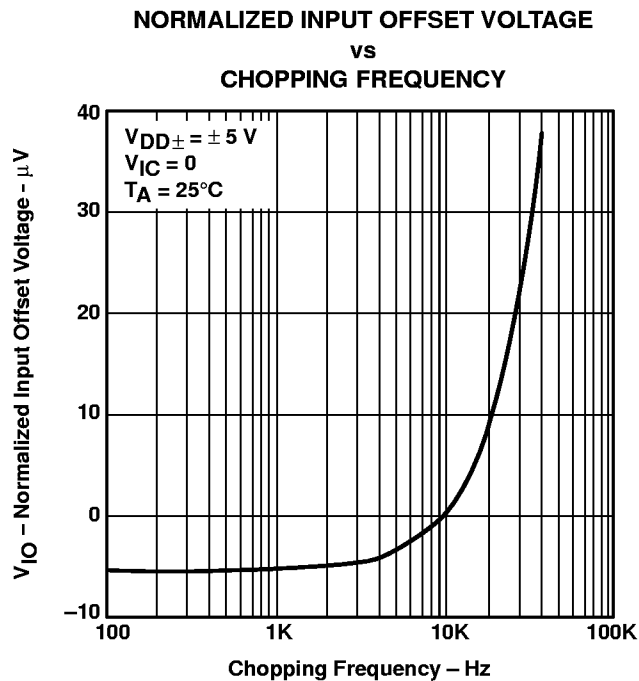

Figure 3

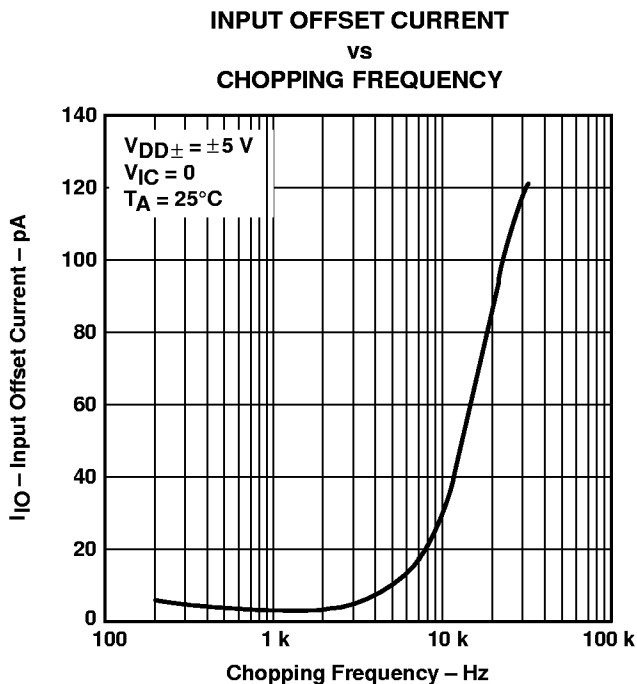

Figure 4

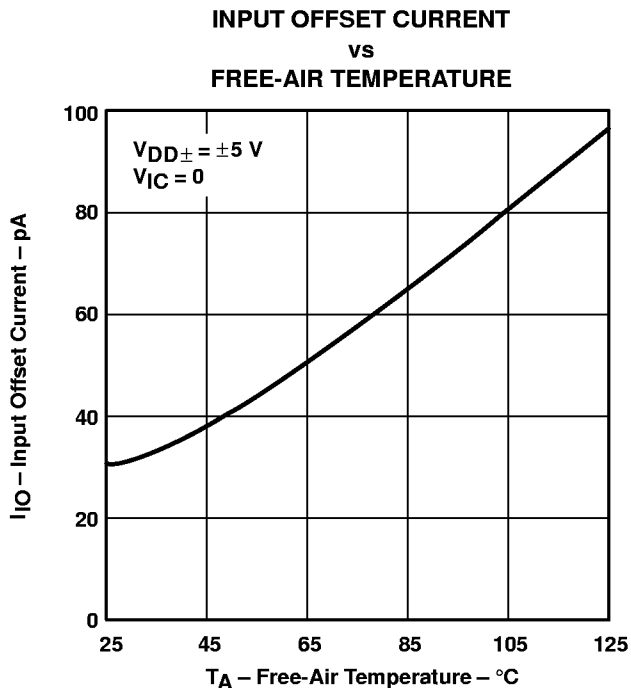

Figure 5

† Data at high and low temperatures are applicable only within the rated operating free-air temperature ranges of the various devices.

TLC2654, TLC2654A, TLC2654Y
Advanced LinCMOS™ LOW-NOISE CHOPPER-STABILIZED
OPERATIONAL AMPLIFIERS

SLOS020E – NOVEMBER 1988 – REVISED FEBRUARY 1999

TYPICAL CHARACTERISTICS†

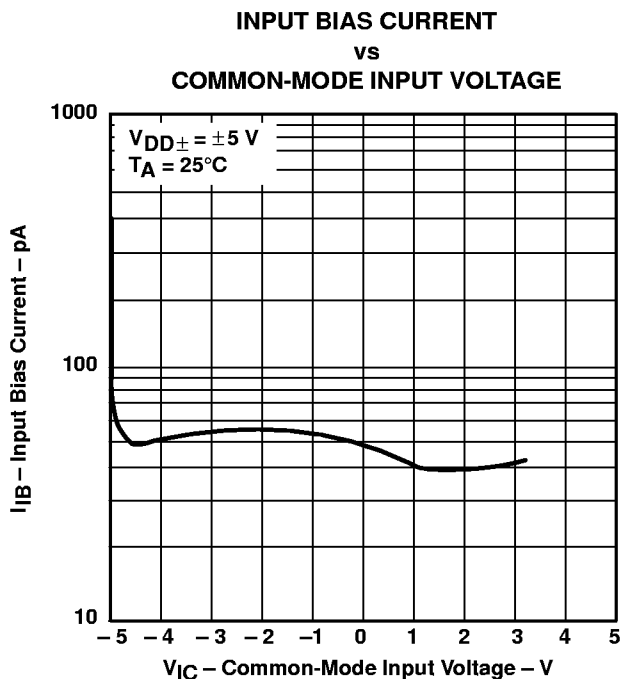

Figure 6

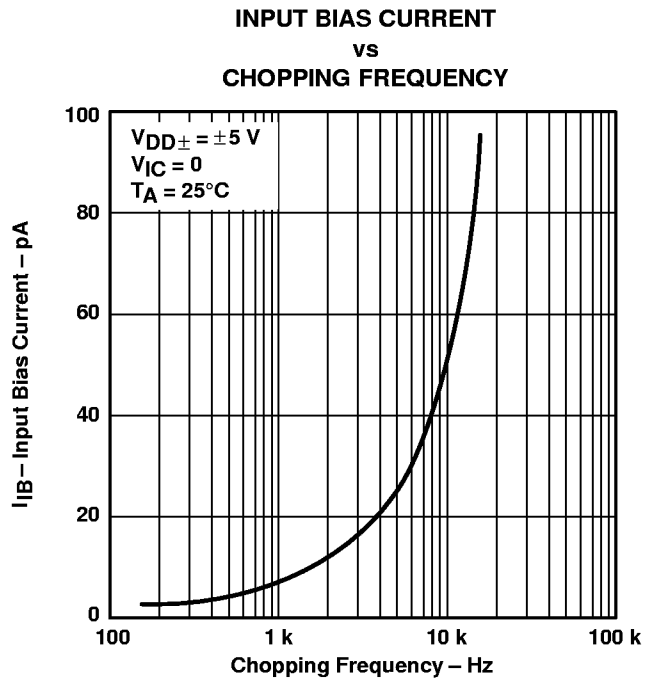

Figure 7

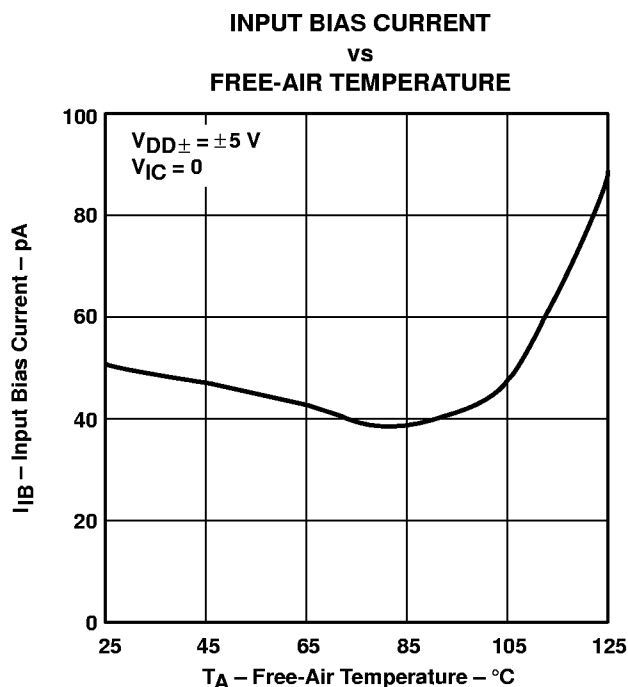

Figure 8

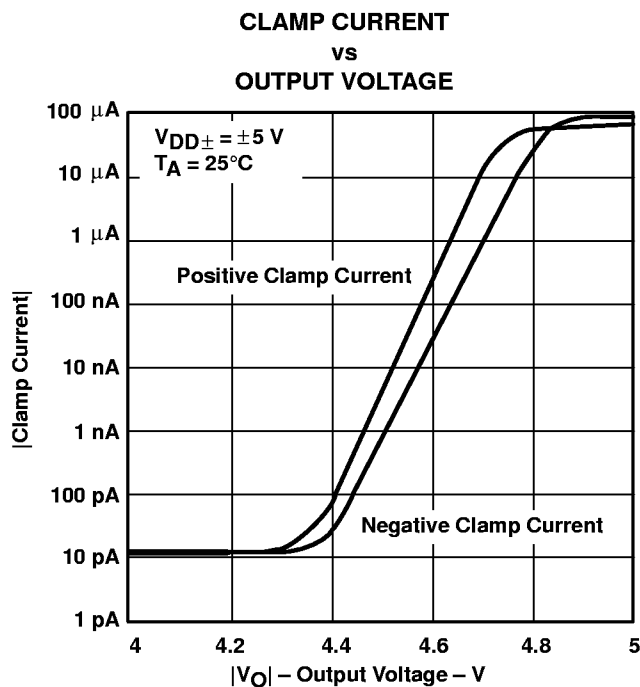

Figure 9

† Data at high and low temperatures are applicable only within the rated operating free-air temperature ranges of the various devices.



TYPICAL CHARACTERISTICS†

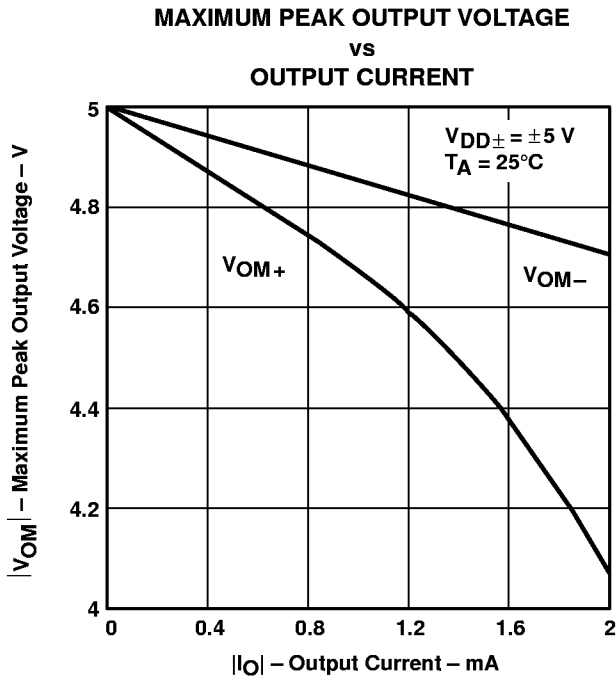

Figure 10

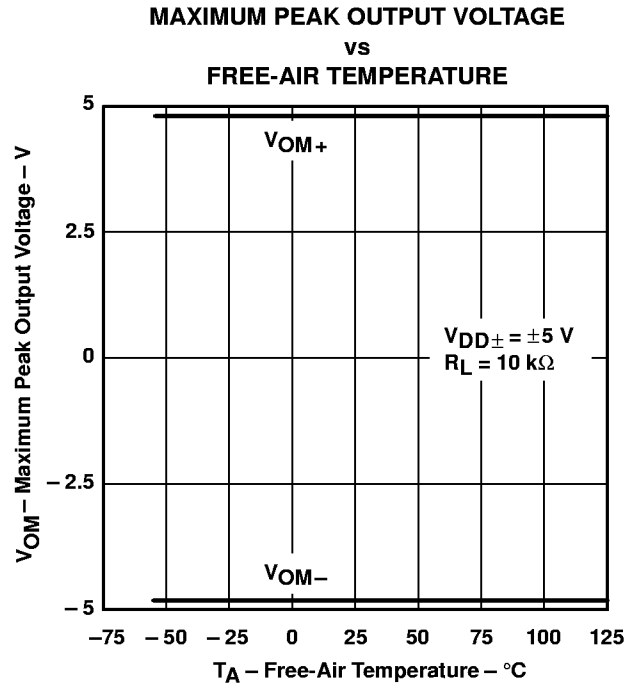

Figure 11

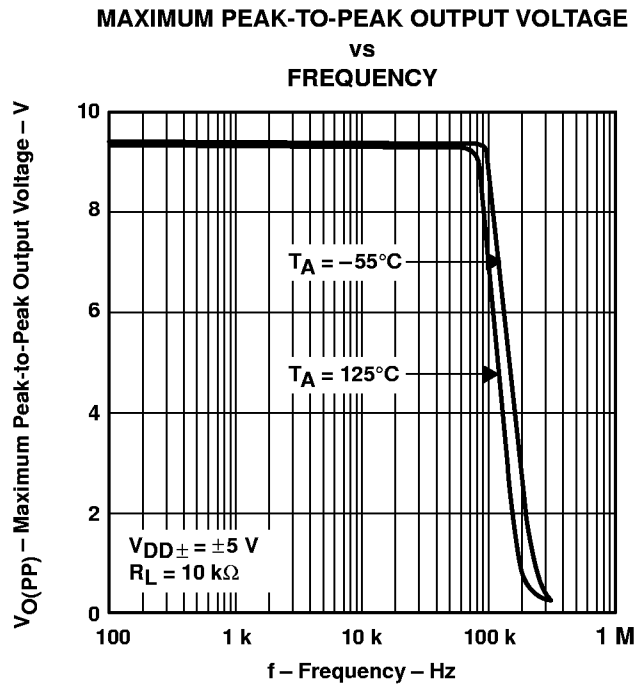

Figure 12

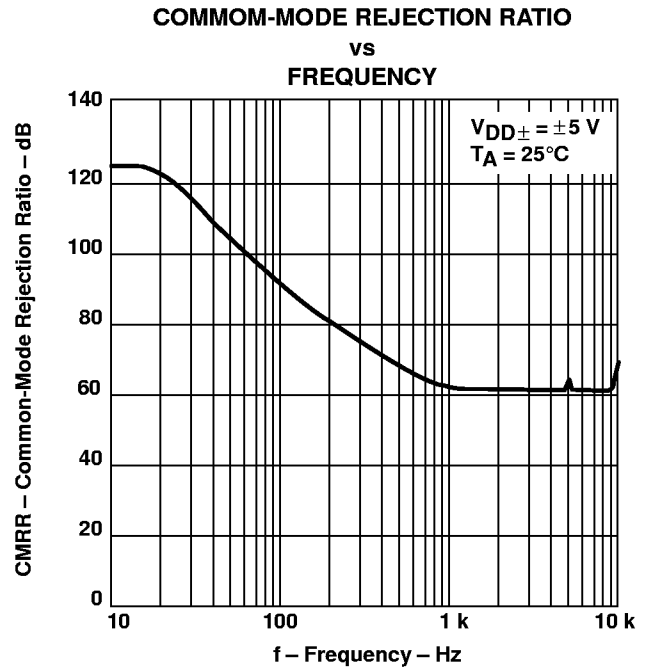

Figure 13

† Data at high and low temperatures are applicable only within the rated operating free-air temperature ranges of the various devices.

TLC2654, TLC2654A, TLC2654Y
Advanced LinCMOS™ LOW-NOISE CHOPPER-STABILIZED
OPERATIONAL AMPLIFIERS

SLOS020E – NOVEMBER 1988 – REVISED FEBRUARY 1999

TYPICAL CHARACTERISTICS†

LARGE-SIGNAL DIFFERENTIAL VOLTAGE AMPLIFICATION AND PHASE SHIFT vs FREQUENCY

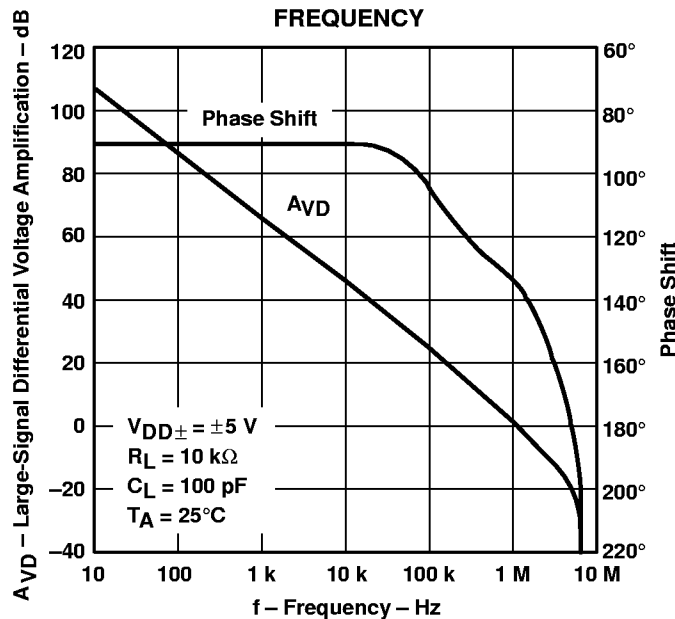

Figure 14

LARGE-SIGNAL DIFFERENTIAL VOLTAGE AMPLIFICATION vs FREE-AIR TEMPERATURE

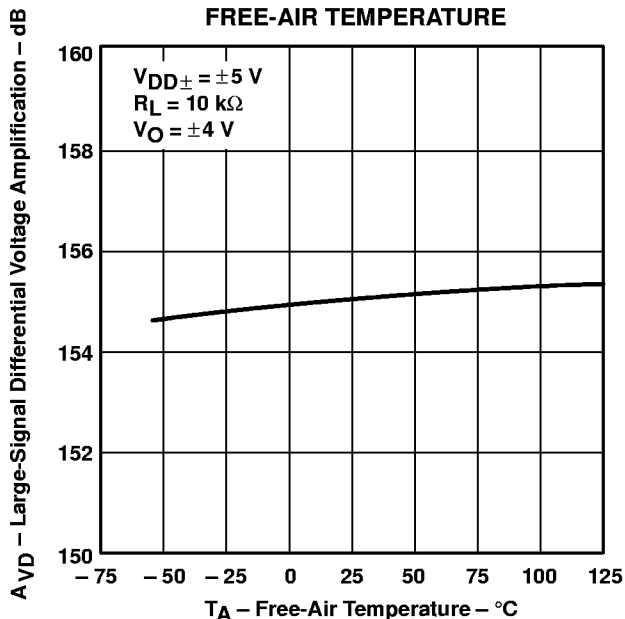

Figure 15

CHOPPING FREQUENCY vs SUPPLY VOLTAGE

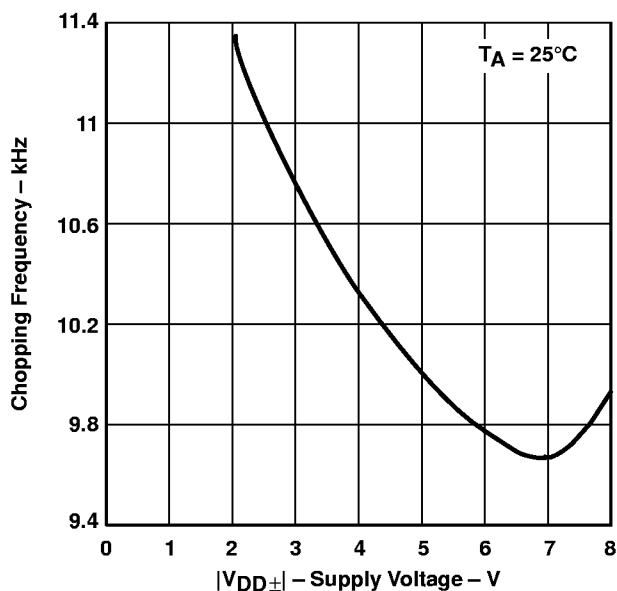

Figure 16

CHOPPING FREQUENCY vs FREE-AIR TEMPERATURE

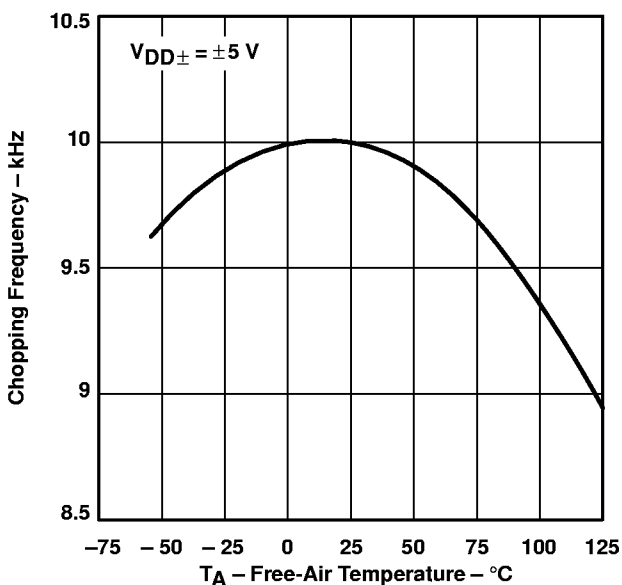

Figure 17

† Data at high and low temperatures are applicable only within the rated operating free-air temperature ranges of the various devices.



TYPICAL CHARACTERISTICS†

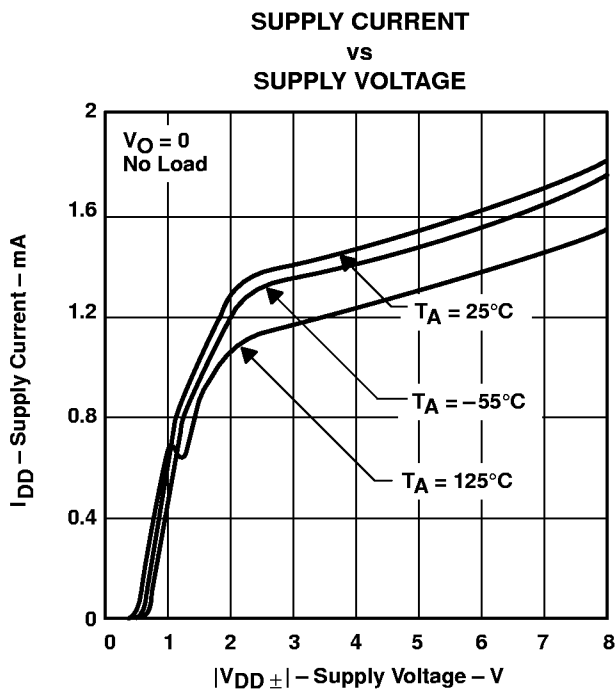

Figure 18

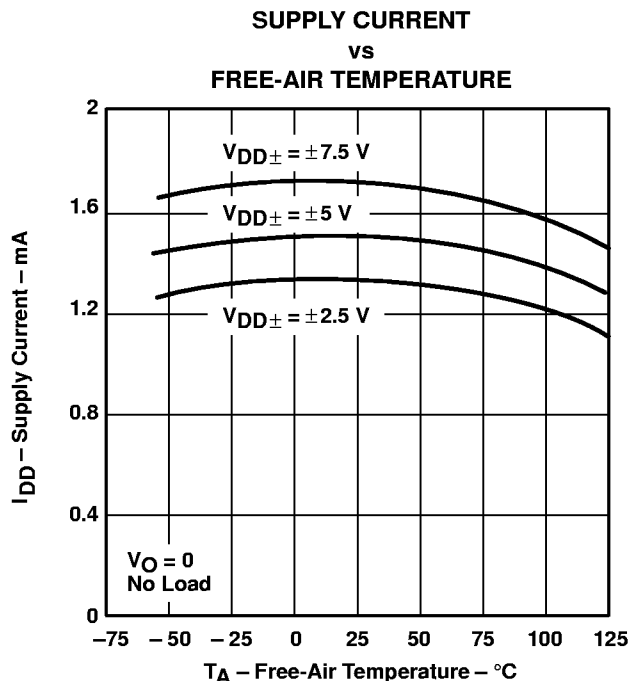

Figure 19

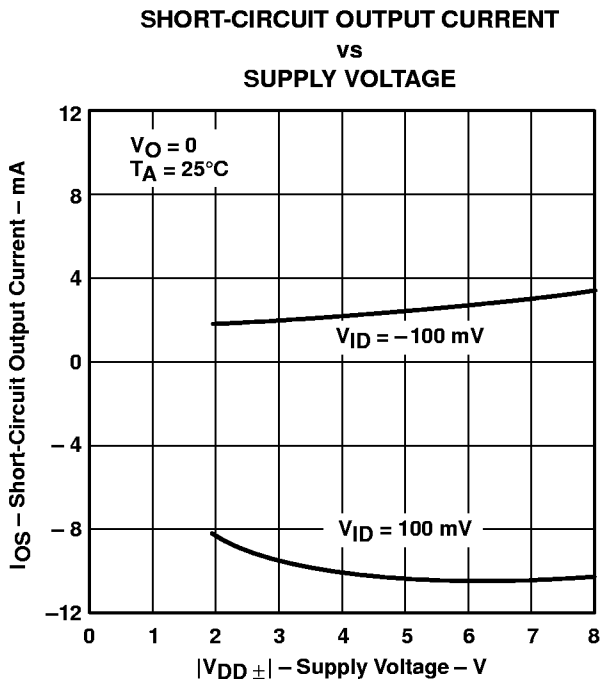

Figure 20

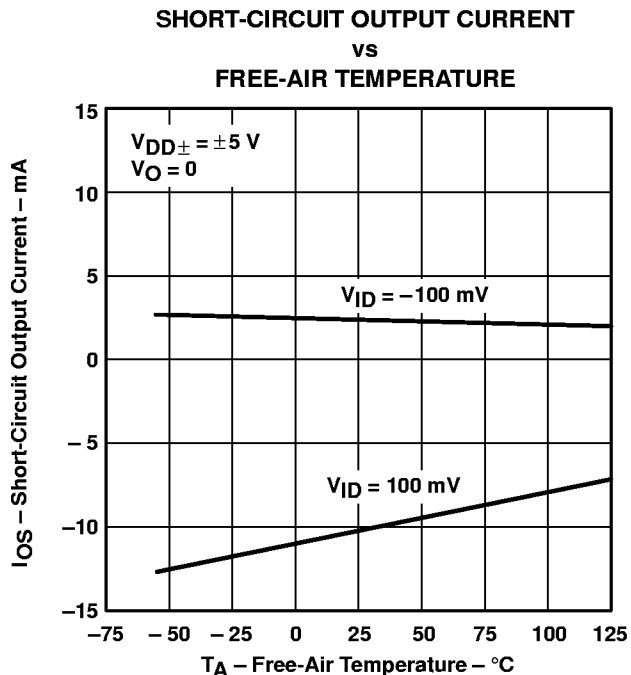

Figure 21

† Data at high and low temperatures are applicable only within the rated operating free-air temperature ranges of the various devices.

TLC2654, TLC2654A, TLC2654Y
Advanced LinCMOS™ LOW-NOISE CHOPPER-STABILIZED
OPERATIONAL AMPLIFIERS

SLOS020E – NOVEMBER 1988 – REVISED FEBRUARY 1999

TYPICAL CHARACTERISTICS†

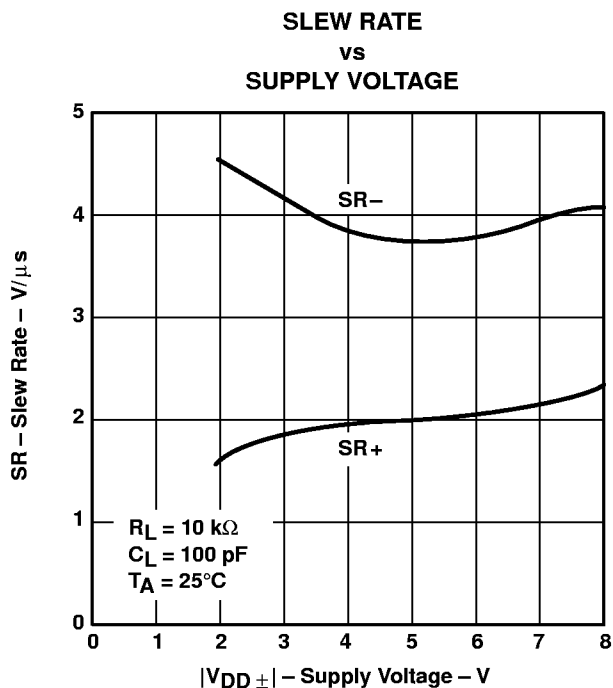

Figure 22

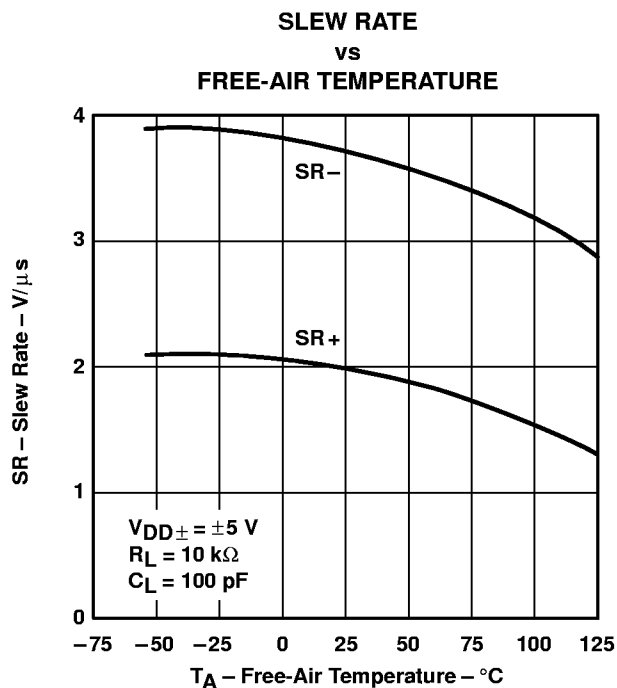

Figure 23

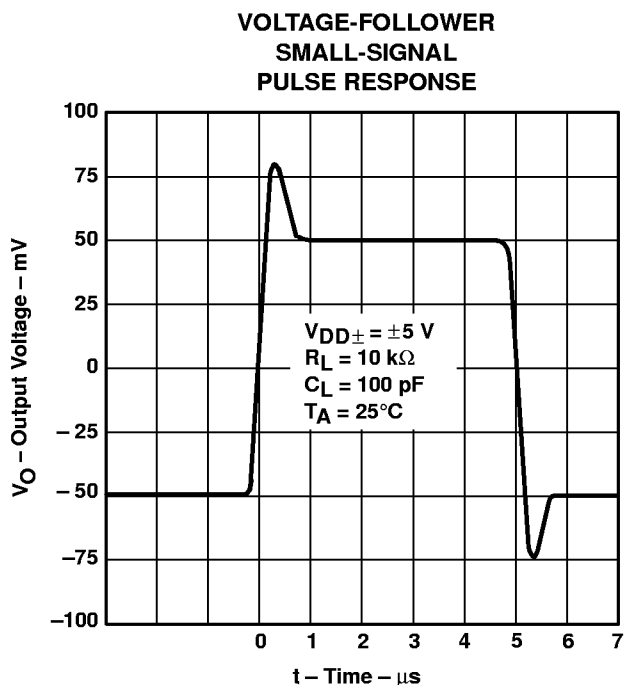

Figure 24

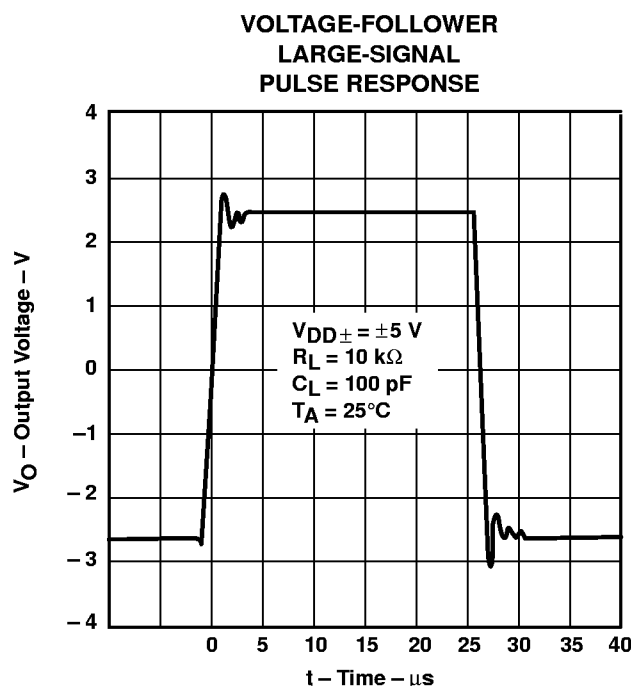

Figure 25

† Data at high and low temperatures are applicable only within the rated operating free-air temperature ranges of the various devices.



TYPICAL CHARACTERISTICS

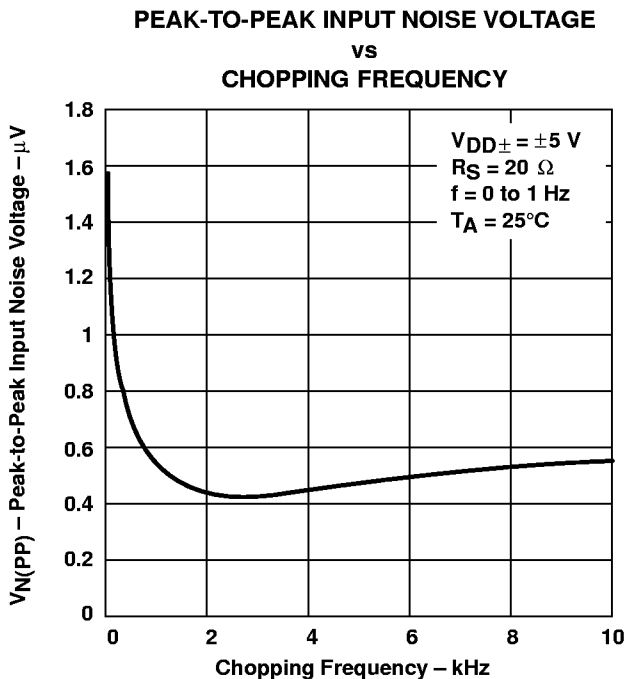

Figure 26

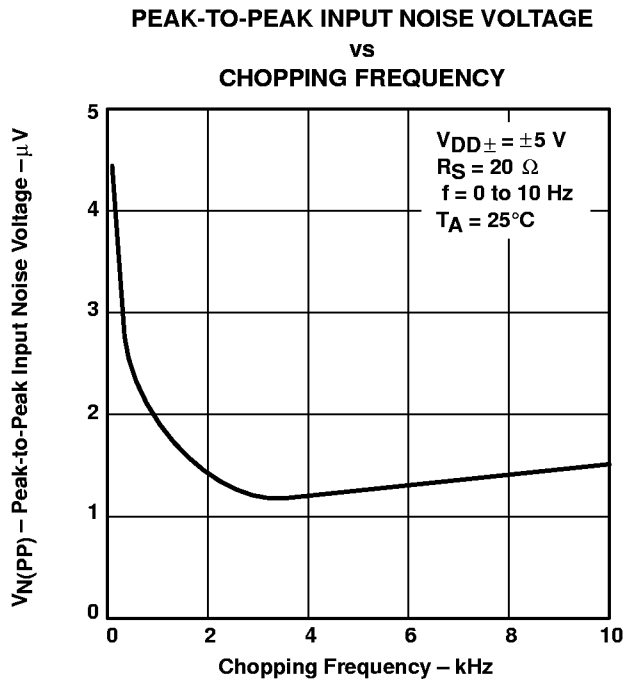

Figure 27

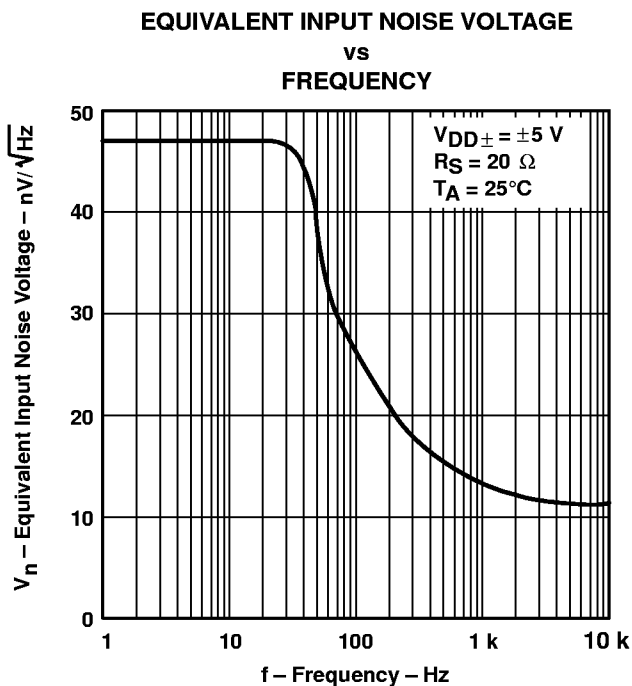

Figure 28

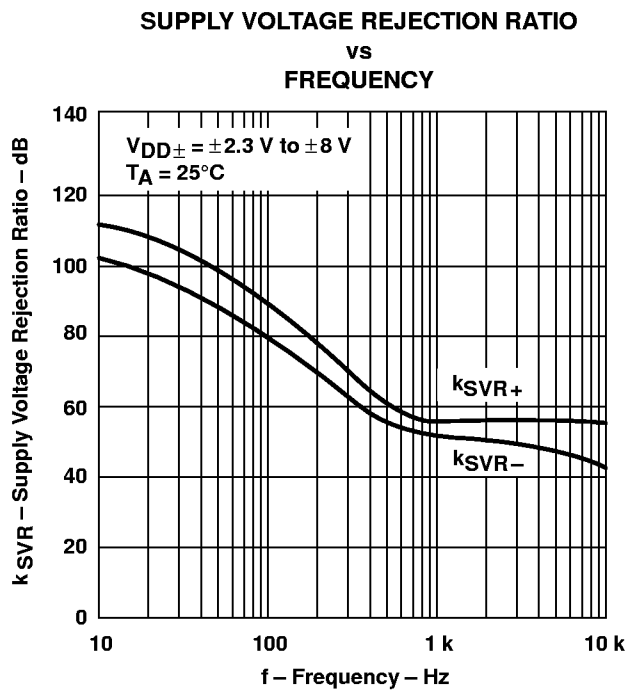

Figure 29

TLC2654, TLC2654A, TLC2654Y
Advanced LinCMOS™ LOW-NOISE CHOPPER-STABILIZED
OPERATIONAL AMPLIFIERS

SLOS020E – NOVEMBER 1988 – REVISED FEBRUARY 1999

TYPICAL CHARACTERISTICS†

GAIN-BANDWIDTH PRODUCT
vs
SUPPLY VOLTAGE

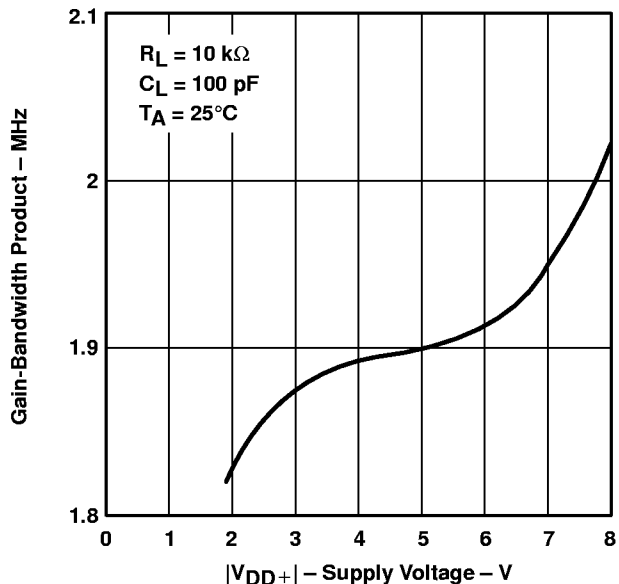

Figure 30

GAIN-BANDWIDTH PRODUCT
vs
FREE-AIR TEMPERATURE

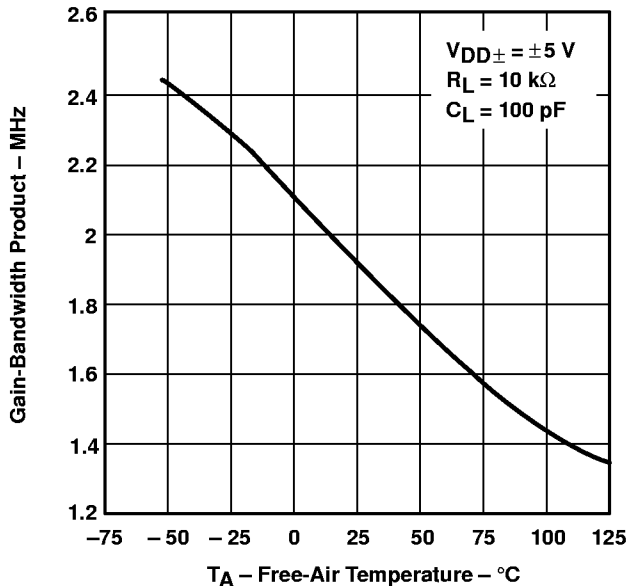

Figure 31

PHASE MARGIN
vs
SUPPLY VOLTAGE

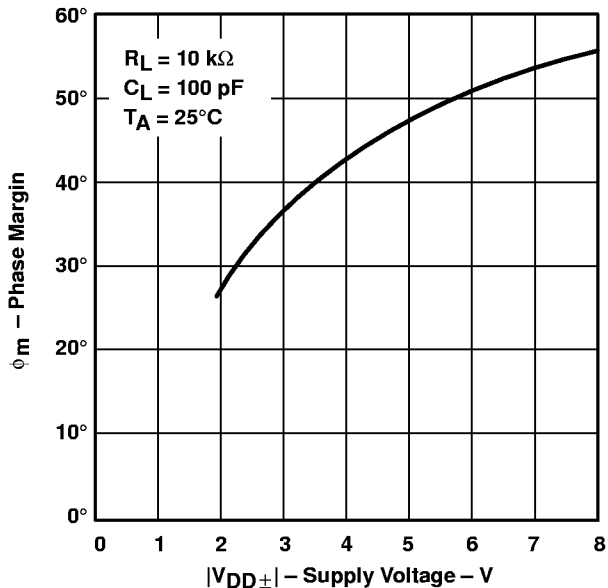

Figure 32

PHASE MARGIN
vs
LOAD CAPACITANCE

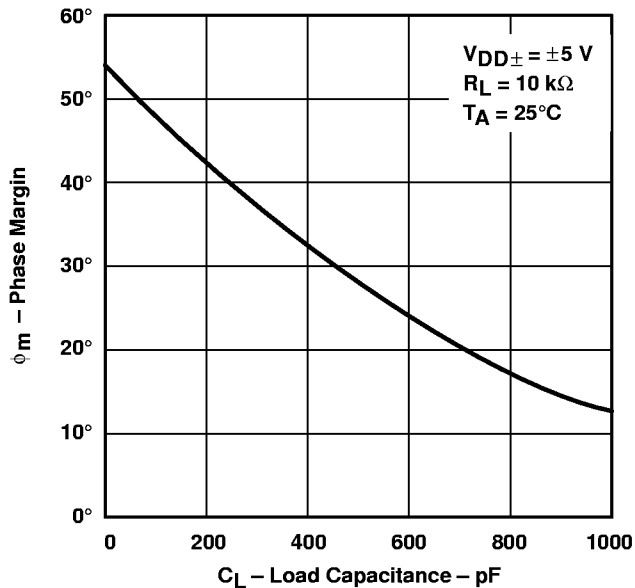

Figure 33

†Data at high and low temperatures are applicable only within the rated operating free-air temperature ranges of the various devices.



APPLICATION INFORMATION

capacitor selection and placement

Leakage and dielectric absorption are the two important factors to consider when selecting external capacitors C_{XA} and C_{XB} . Both factors can cause system degradation, negating the performance advantages realized by using the TLC2654.

Degradation from capacitor leakage becomes more apparent with increasing temperatures. Low-leakage capacitors and standoffs are recommended for operation at $T_A = 125^\circ\text{C}$. In addition, guard bands are recommended around the capacitor connections on both sides of the printed-circuit board to alleviate problems caused by surface leakage on circuit boards.

Capacitors with high dielectric absorption tend to take several seconds to settle upon application of power, which directly affects input offset voltage. In applications needing fast settling of input voltage, high-quality film capacitors such as mylar, polystyrene, or polypropylene should be used. In other applications, a ceramic or other low-grade capacitor can suffice.

Unlike many choppers available today, the TLC2654 is designed to function with values of C_{XA} and C_{XB} in the range of $0.1\ \mu\text{F}$ to $1\ \mu\text{F}$ without degradation to input offset voltage or input noise voltage. These capacitors should be located as close as possible to C_{XA} and C_{XB} and return to either V_{DD-} or C RETURN. On many choppers, connecting these capacitors to V_{DD-} causes degradation in noise performance; this problem is eliminated on the TLC2654.

internal/external clock

The TLC2654 has an internal clock that sets the chopping frequency to a nominal value of 10 kHz. On 8-pin packages, the chopping frequency can only be controlled by the internal clock; however, on all 14-pin packages and the 20-pin FK package the device chopping frequency can be set by the internal clock or controlled externally by use of the INT/ $\overline{\text{EXT}}$ and CLK IN. To use the internal 10-kHz clock, no connection is necessary. If external clocking is desired, connect INT/ $\overline{\text{EXT}}$ to V_{DD-} and the external clock to CLK IN. The external clock trip point is 2.5 V above the negative rail; however, CLK IN can be driven from the negative rail to 5 V above the negative rail. This allows the TLC2654 to be driven directly by 5-V TTL and CMOS logic when operating in the single-supply configuration. If this 5-V level is exceeded, damage could occur to the device unless the current into CLK IN is limited to $\pm 5\ \text{mA}$. A divide-by-two frequency divider interfaces with CLK IN and sets the chopping frequency. The chopping frequency appears on CLK OUT.

overload recovery/output clamp

When large differential-input-voltage conditions are applied to the TLC2654, the nulling loop attempts to prevent the output from saturating by driving C_{XA} and C_{XB} to internally-clamped voltage levels. Once the overdrive condition is removed, a period of time is required to allow the built-up charge to dissipate. This time period is defined as overload recovery time (see Figure 34). Typical overload recovery time for the TLC2654 is significantly faster than competitive products; however, this time can be reduced further by use of internal clamp circuitry accessible through CLAMP if required.

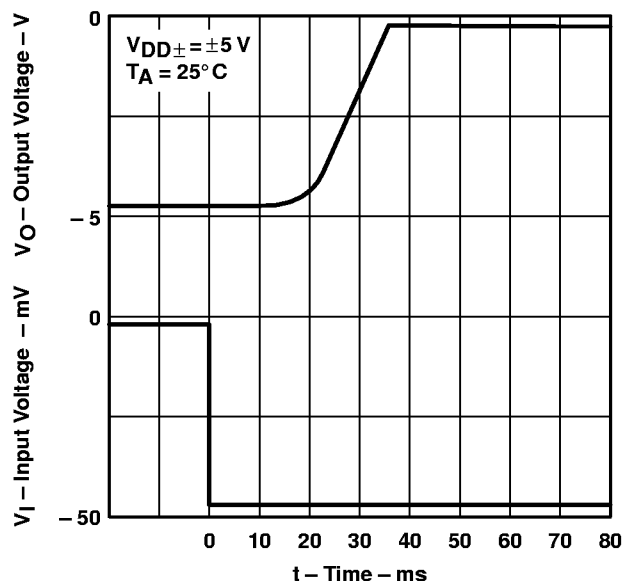

Figure 34. Overload Recovery

TLC2654, TLC2654A, TLC2654Y

Advanced LinCMOS™ LOW-NOISE CHOPPER-STABILIZED OPERATIONAL AMPLIFIERS

SLOS020E – NOVEMBER 1988 – REVISED FEBRUARY 1999

APPLICATION INFORMATION

overload recovery/output clamp (continued)

The clamp is a switch that is automatically activated when the output is approximately 1 V from either supply rail. When connected to the inverting input (in parallel with the closed-loop feedback resistor), the closed-loop gain is reduced and the TLC2654 output is prevented from going into saturation. Since the output must source or sink current through the switch (see Figure 9), the maximum output voltage swing is slightly reduced.

thermoelectric effects

To take advantage of the extremely low offset voltage temperature coefficient of the TLC2654, care must be taken to compensate for the thermoelectric effects present when two dissimilar metals are brought into contact with each other (such as device leads being soldered to a printed-circuit board). It is not uncommon for dissimilar metal junctions to produce thermoelectric voltages in the range of several microvolts per degree Celsius (orders of magnitude greater than the 0.01 $\mu\text{V}/^\circ\text{C}$ typical of the TLC2654).

To help minimize thermoelectric effects, pay careful attention to component selection and circuit-board layout. Avoid the use of nonsoldered connections (such as sockets, relays, switches, etc.) in the input signal path. Cancel thermoelectric effects by duplicating the number of components and junctions in each device input. The use of low-thermoelectric-coefficient components, such as wire-wound resistors, is also beneficial.

latch-up avoidance

Because CMOS devices are susceptible to latch-up due to their inherent parasitic thyristors, the TLC2654 inputs and outputs are designed to withstand -100-mA surge currents without sustaining latch-up; however, techniques to reduce the chance of latch-up should be used whenever possible. Internal protection diodes should not, by design, be forward biased. Applied input and output voltages should not exceed the supply voltage by more than 300 mV. Care should be exercised when using capacitive coupling on pulse generators. Supply transients should be stunted by the use of decoupling capacitors (0.1 μF typical) located across the supply rails as close to the device as possible.

The current path established if latch-up occurs is usually between the supply rails and is limited only by the impedance of the power supply and the forward resistance of the parasitic thyristor. The chance of latch-up occurring increases with increasing temperature and supply voltage.

electrostatic-discharge protection

The TLC2654 incorporates internal ESD-protection circuits that prevent functional failures at voltages at or below 2000 V. Care should be exercised in handling these devices, as exposure to ESD may result in degradation of the device parametric performance.

theory of operation

Chopper-stabilized operational amplifiers offer the best dc performance of any monolithic operational amplifier. This superior performance is the result of using two operational amplifiers — a main amplifier and a nulling amplifier — plus oscillator-controlled logic and two external capacitors to create a system that behaves as a single amplifier. With this approach, the TLC2654 achieves submicrovolt input offset voltage, submicrovolt noise voltage, and offset voltage variations with temperature in the $\text{nV}/^\circ\text{C}$ range.

The TLC2654 on-chip control logic produces two dominant clock phases: a nulling phase and an amplifying phase. The term chopper-stabilized derives from the process of switching between these two clock phases. Figure 35 shows a simplified block diagram of the TLC2654. Switches A and B are make-before-break types.



APPLICATION INFORMATION

theory of operation (continued)

During the nulling phase, switch A is closed, shorting the nulling amplifier inputs together and allowing the nulling amplifier to reduce its own input offset voltage by feeding its output signal back to an inverting input node. Simultaneously, external capacitor C_{XA} stores the nulling potential to allow the offset voltage of the amplifier to remain nulled during the amplifying phase.

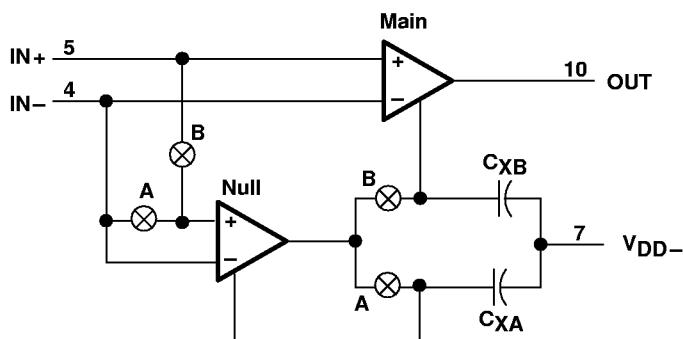

Pin numbers shown are for the D (14 pin), J, and N packages.

Figure 35. TLC2654 Simplified Block Diagram

During the amplifying phase, switch B is closed, connecting the output of the nulling amplifier to a noninverting input of the main amplifier. In this configuration, the input offset voltage of the main amplifier is nulled. Also, external capacitor C_{XB} stores the nulling potential to allow the offset voltage of the main amplifier to remain nulled during the next nulling phase.

This continuous chopping process allows offset voltage nulling during variations in time and temperature and over the common-mode input voltage range and power supply range. In addition, because the low-frequency signal path is through both the null and main amplifiers, extremely high gain is achieved.

The low-frequency noise of a chopper amplifier depends on the magnitude of the component noise prior to chopping and the capability of the circuit to reduce this noise while chopping. The use of the Advanced LinCMOS process, with its low-noise analog MOS transistors and patent-pending input stage design, significantly reduces the input noise voltage.

The primary source of nonideal operation in chopper-stabilized amplifiers is error charge from the switches. As charge imbalance accumulates on critical nodes, input offset voltage can increase especially with increasing chopping frequency. This problem has been significantly reduced in the TLC2654 by use of a patent-pending compensation circuit and the Advanced LinCMOS process.

The TLC2654 incorporates a feed-forward design that ensures continuous frequency response. Essentially, the gain magnitude of the nulling amplifier and compensation network crosses unity at the break frequency of the main amplifier. As a result, the high-frequency response of the system is the same as the frequency response of the main amplifier. This approach also ensures that the slewing characteristics remain the same during both the nulling and amplifying phases.

The primary limitation on ac performance is the chopping frequency. As the input signal frequency approaches the chopper's clock frequency, intermodulation (or aliasing) errors result from the mixing of these frequencies. To avoid these error signals, the input frequency must be less than half the clock frequency. Most choppers available today limit the internal chopping frequency to less than 500 Hz in order to eliminate errors due to the charge imbalancing phenomenon mentioned previously. However, to avoid intermodulation errors on a 500-Hz chopper, the input signal frequency must be limited to less than 250 Hz.

TLC2654, TLC2654A, TLC2654Y
Advanced LinCMOS™ LOW-NOISE CHOPPER-STABILIZED
OPERATIONAL AMPLIFIERS

SLOS020E – NOVEMBER 1988 – REVISED FEBRUARY 1999

APPLICATION INFORMATION

theory of operation (continued)

The TLC2654 removes this restriction on ac performance by using a 10-kHz internal clock frequency. This high chopping frequency allows amplification of input signals up to 5 kHz without errors due to intermodulation and greatly reduces low-frequency noise.

THERMAL INFORMATION

temperature coefficient of input offset voltage

Figure 36 shows the effects of package-included thermal EMF. The TLC2654 can null only the offset voltage within its nulling loop. There are metal-to-metal junctions outside the nulling loop (bonding wires, solder joints, etc.) that produce EMF. In Figure 36, a TLC2654 packaged in a 14-pin plastic package (N package) was placed in an oven at 25°C at t = 0, biased up, and allowed to stabilize. At t = 3 min, the oven was turned on and allowed to rise in temperature to 125°C. As evidenced by the curve, the overall change in input offset voltage with temperature is less than the specified maximum limit of 0.05 μV/°C.

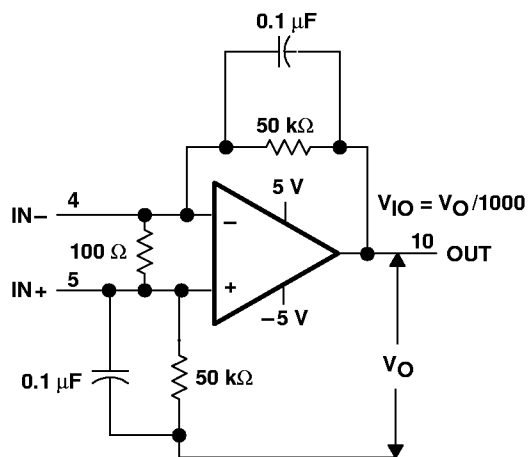
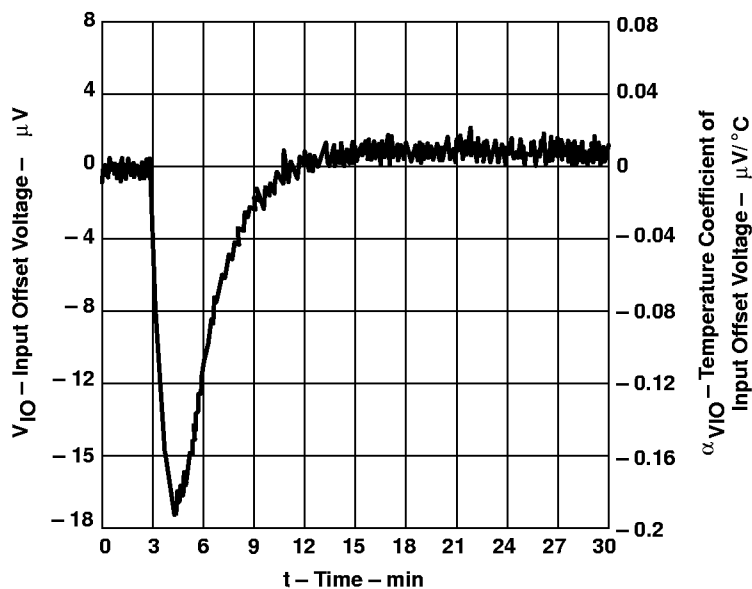

Pin numbers shown are for the D (14-pin), J, and N packages.

Figure 36. Effects of Package-Induced Thermal EMF

TLC2654, TLC2654A, TLC2654Y
**Advanced LinCMOS™ LOW-NOISE CHOPPER-STABILIZED
 OPERATIONAL AMPLIFIERS**

SLOS020E – NOVEMBER 1988 – REVISED FEBRUARY 1999

MECHANICAL DATA

D (R-PDSO-G)**

PLASTIC SMALL-OUTLINE PACKAGE

14 PIN SHOWN

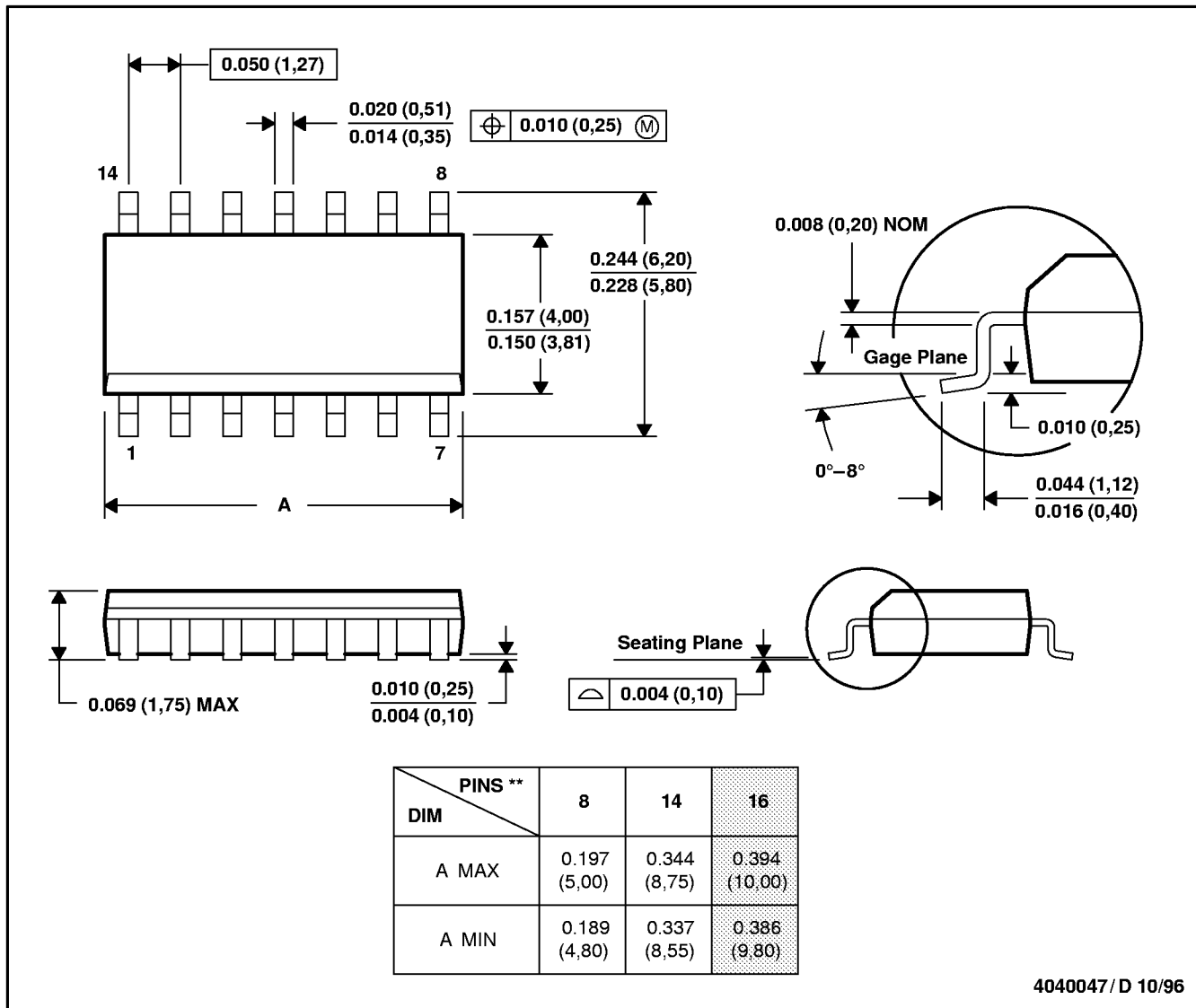

- NOTES: A. All linear dimensions are in inches (millimeters).
 B. This drawing is subject to change without notice.
 C. Body dimensions do not include mold flash or protrusion, not to exceed 0.006 (0,15).
 D. Falls within JEDEC MS-012

TLC2654, TLC2654A, TLC2654Y
Advanced LinCMOS™ LOW-NOISE CHOPPER-STABILIZED
OPERATIONAL AMPLIFIERS

SLOS020E – NOVEMBER 1988 – REVISED FEBRUARY 1999

MECHANICAL DATA

FK (S-CQCC-N)**

LEADLESS CERAMIC CHIP CARRIER

28 TERMINAL SHOWN

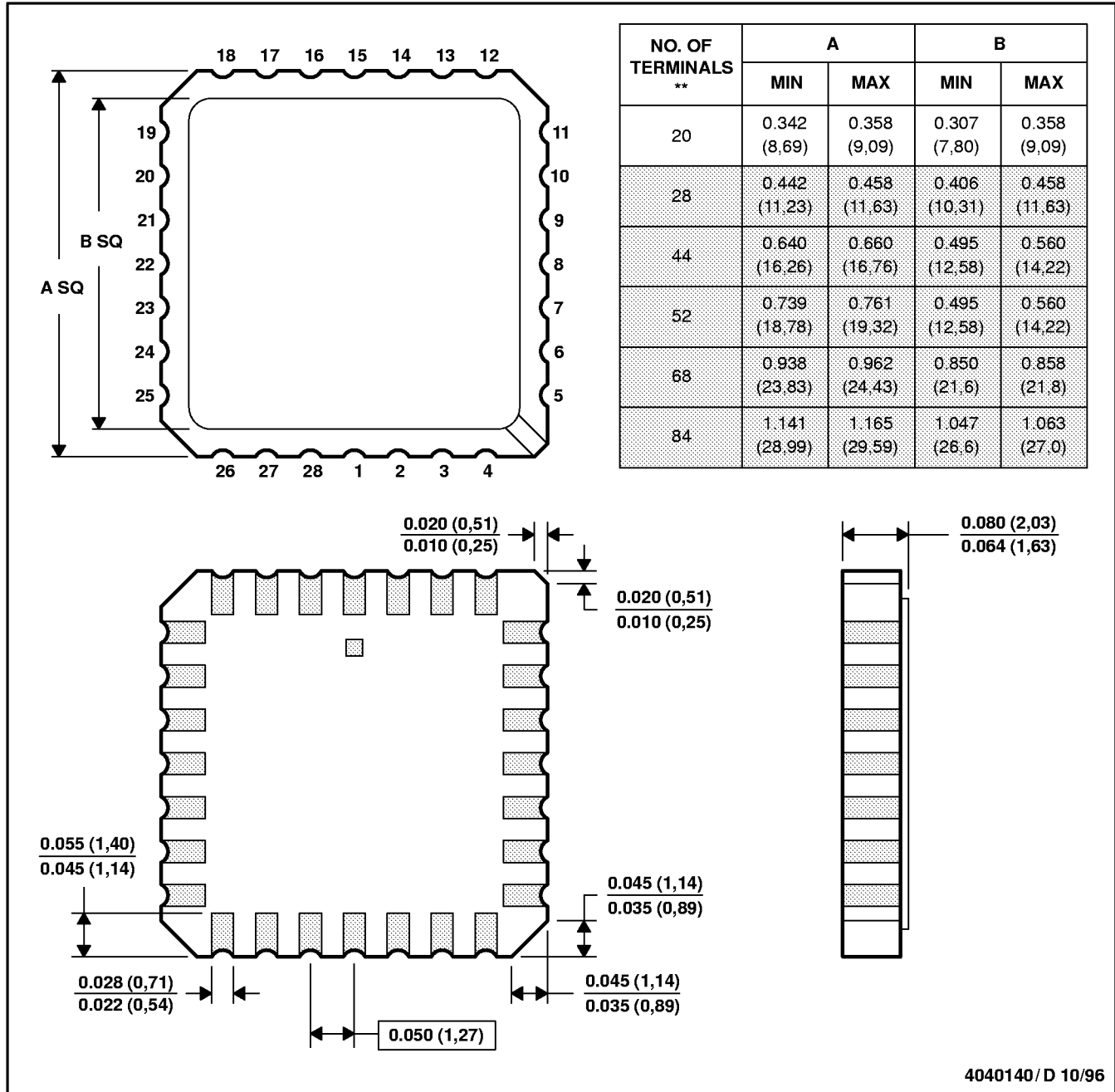

- NOTES: A. All linear dimensions are in inches (millimeters).
 B. This drawing is subject to change without notice.
 C. This package can be hermetically sealed with a metal lid.
 D. The terminals are gold plated.
 E. Falls within JEDEC MS-004

TLC2654, TLC2654A, TLC2654Y
Advanced LinCMOS™ LOW-NOISE CHOPPER-STABILIZED
OPERATIONAL AMPLIFIERS

SLOS020E – NOVEMBER 1988 – REVISED FEBRUARY 1999

MECHANICAL DATA

J (R-GDIP-T)**

CERAMIC DUAL-IN-LINE PACKAGE

14 PIN SHOWN

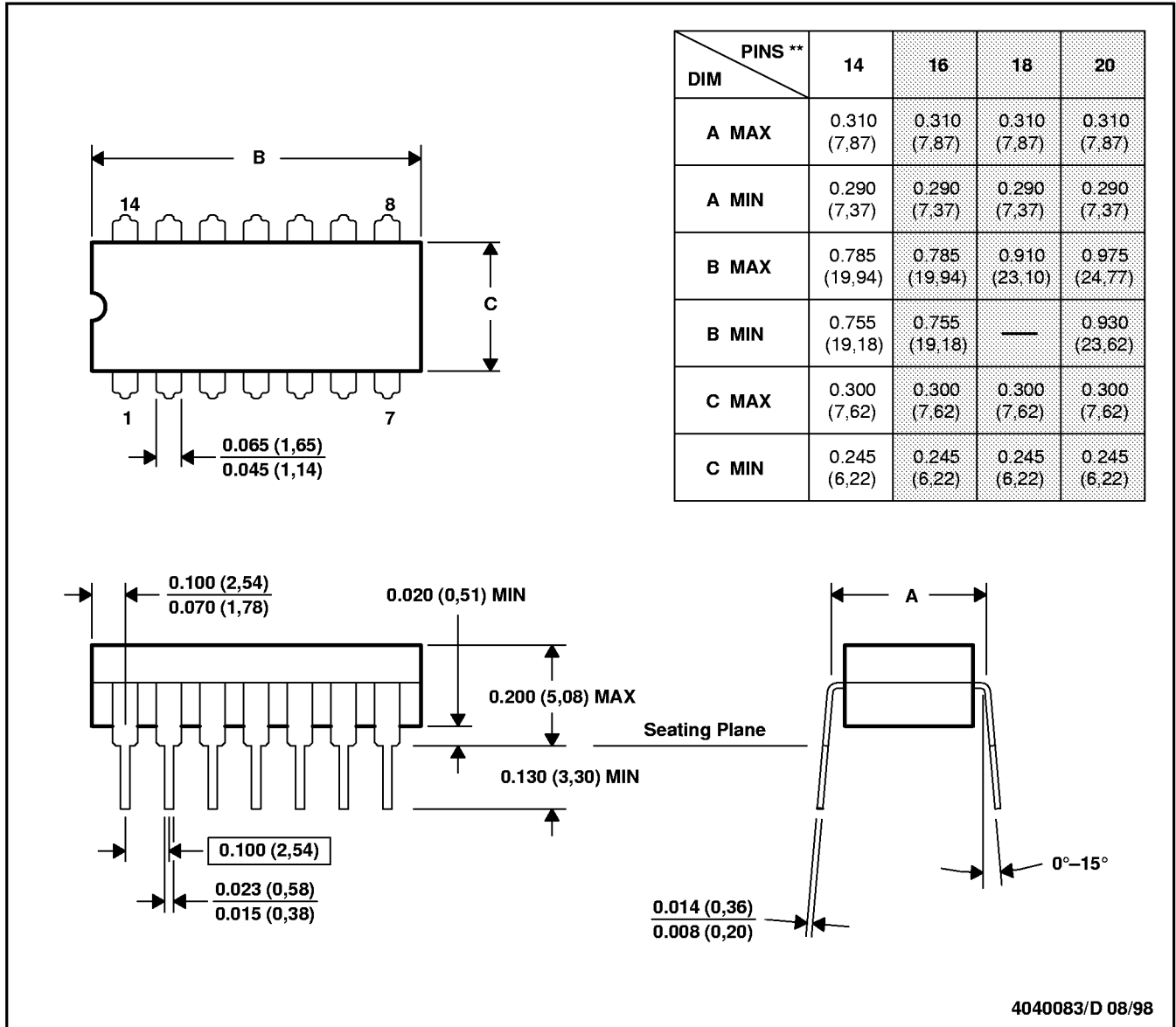

- NOTES: A. All linear dimensions are in inches (millimeters).
 B. This drawing is subject to change without notice.
 C. This package can be hermetically sealed with a ceramic lid using glass frit.
 D. Index point is provided on cap for terminal identification only on press ceramic glass frit seal only.
 E. Falls within MIL STD 1835 GDIP1-T14, GDIP1-T16, GDIP1-T18, GDIP1-T20, and GDIP1-T22.

TLC2654, TLC2654A, TLC2654Y
Advanced LinCMOS™ LOW-NOISE CHOPPER-STABILIZED
OPERATIONAL AMPLIFIERS

SLOS020E – NOVEMBER 1988 – REVISED FEBRUARY 1999

MECHANICAL DATA

JG (R-GDIP-T8)

CERAMIC DUAL-IN-LINE PACKAGE

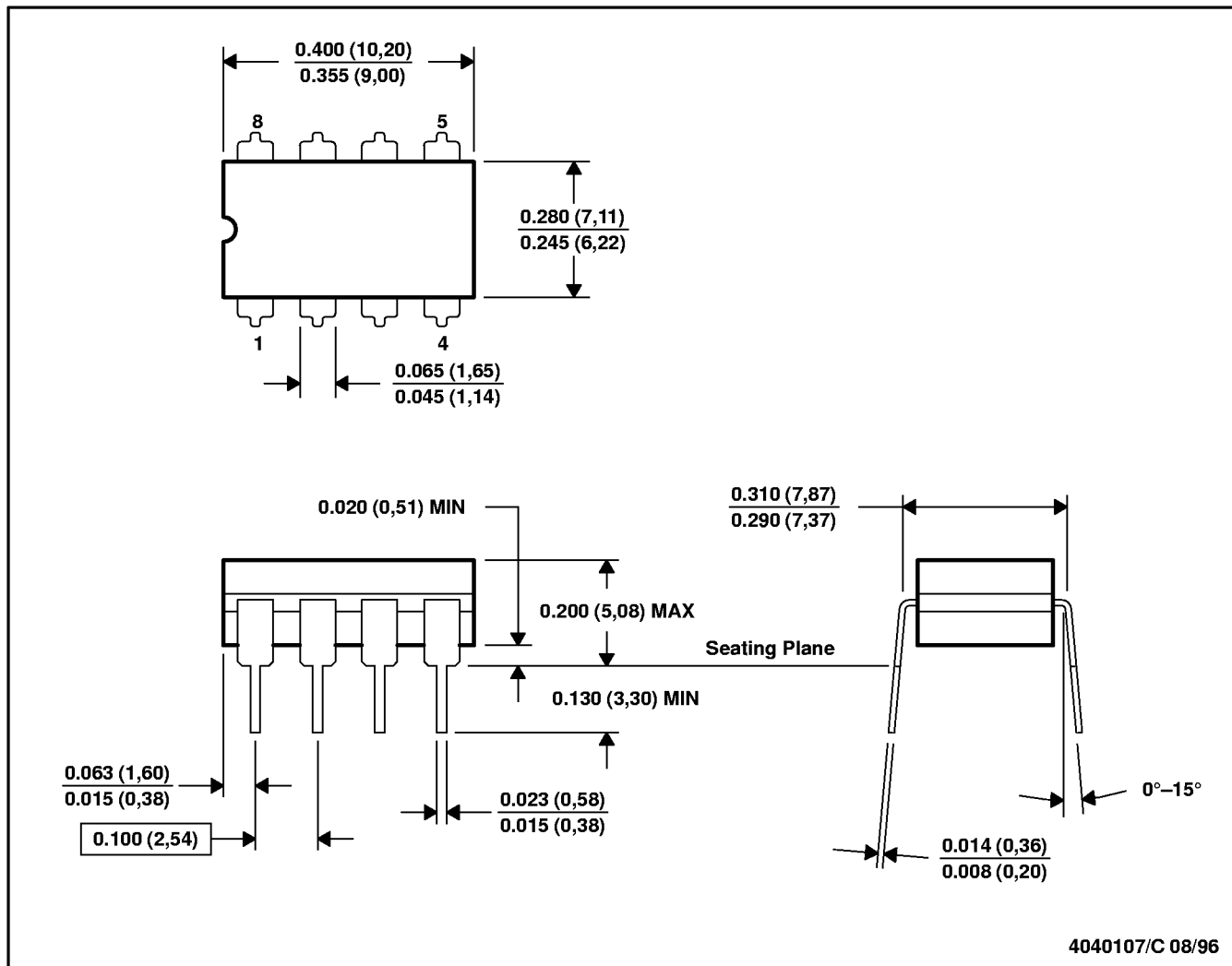

- NOTES: A. All linear dimensions are in inches (millimeters).
 B. This drawing is subject to change without notice.
 C. This package can be hermetically sealed with a ceramic lid using glass frit.
 D. Index point is provided on cap for terminal identification only on press ceramic glass frit seal only.
 E. Falls within MIL-STD-1835 GDIP1-T8

TLC2654, TLC2654A, TLC2654Y
Advanced LinCMOS™ LOW-NOISE CHOPPER-STABILIZED
OPERATIONAL AMPLIFIERS

SLOS020E – NOVEMBER 1988 – REVISED FEBRUARY 1999

MECHANICAL DATA

N (R-PDIP-T)**

PLASTIC DUAL-IN-LINE PACKAGE

16 PIN SHOWN

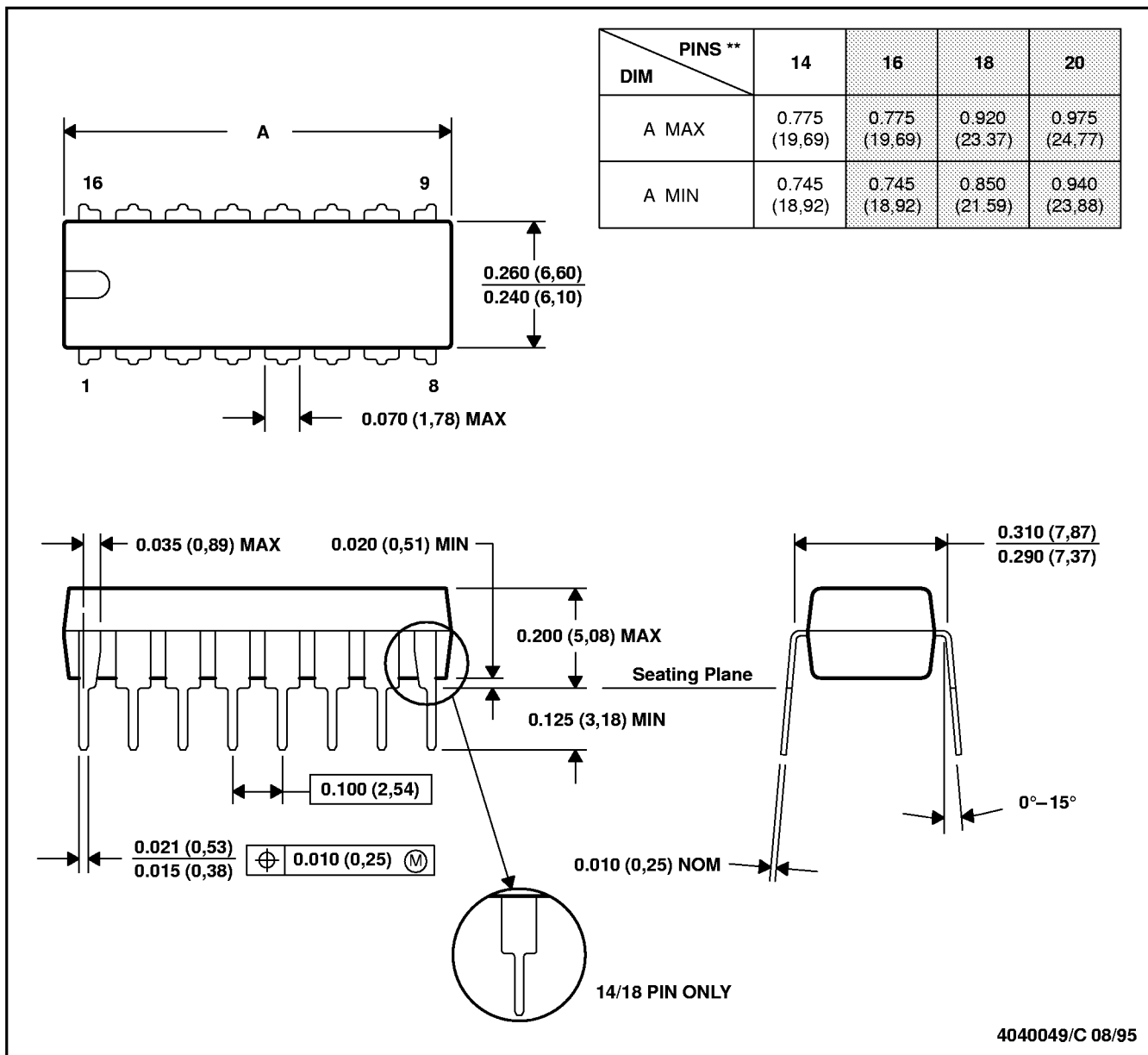

- NOTES: A. All linear dimensions are in inches (millimeters).
 B. This drawing is subject to change without notice.
 C. Falls within JEDEC MS-001 (20 pin package is shorter than MS-001.)

TLC2654, TLC2654A, TLC2654Y
Advanced LinCMOS™ LOW-NOISE CHOPPER-STABILIZED
OPERATIONAL AMPLIFIERS

SLOS020E – NOVEMBER 1988 – REVISED FEBRUARY 1999

MECHANICAL DATA

P (R-PDIP-T8)

PLASTIC DUAL-IN-LINE PACKAGE

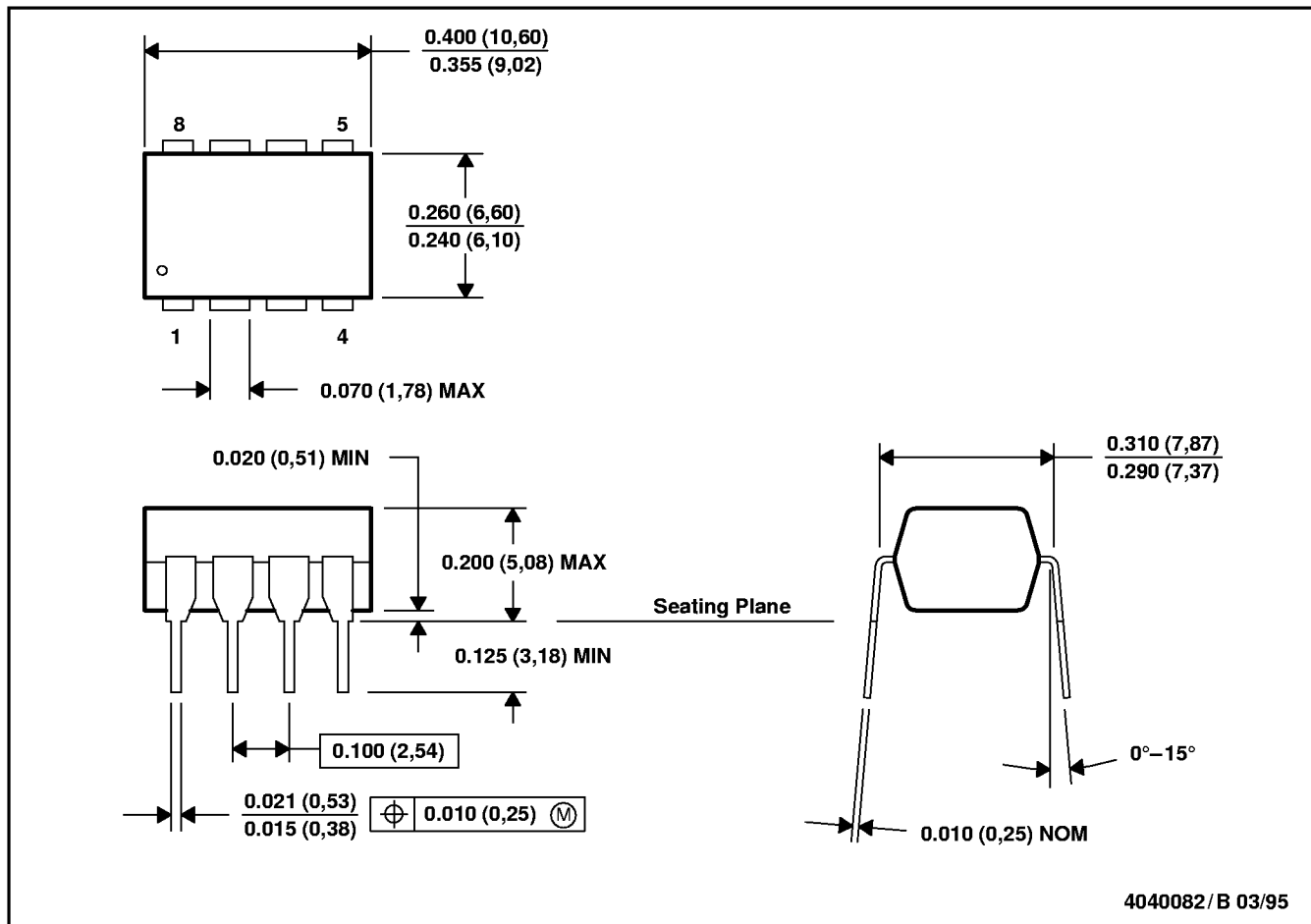

- NOTES: A. All linear dimensions are in inches (millimeters).
 B. This drawing is subject to change without notice.
 C. Falls within JEDEC MS-001