

Hybrid Couplers 3dB, 90°

Type PC2025A2100AT00

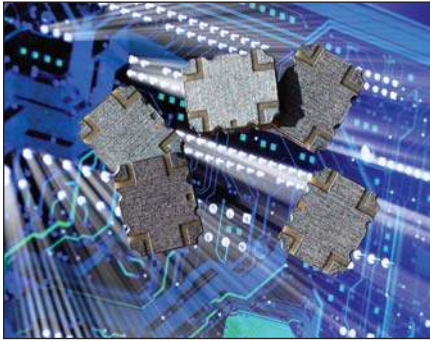

GENERAL DESCRIPTION

The PC2025A2100AT00 is a RoHS compliant low profile wideband 3dB hybrid coupler which can support mobile applications, including PCS and DCS applications. The power coupler series of components is based on AVX's patented MLO™ technology (US patents 6,987,309, 7,068,124) which incorporates lumped elements and micro vias. The resultant designs and finished structures allow for the integration of high Q passives in a low cost high density interconnect component. The PC2025A2100AT00 is a multifunctional component designed for attenuators, phase shifters, LNAs, balance amplifiers and signal distribution. All components are electrically tested prior to tape and reel. Reliability testing is performed to JEDEC and Mil standards. Finishes are available in RoHS compliant NiSn and immersion Au.

FEATURES

- 1.5 – 2.1 GHz
- Excellent Isolation
- DCS and PCS
- Expansion Matched to PCB
- 90° Quadrature
- Surface Mountable
- RoHS Compliant
- Available in Tape and Reel

APPLICATIONS

- Mobile communications
- GPS
- Vehicle location systems
- Wireless LAN's

LAND GRID ARRAY ADVANTAGES

- Inherent Low Profile
- Excellent Solderability
- Low Parasitics
- Better Heat Dissipation

TOP VIEW



	mm (inches)
L	6.35 (0.25)
W	5.08 (0.20)
T	1.0 (0.04)

HOW TO ORDER

PC	2025	A	2100	A	T	00	1
Series	Size	Type	Frequency (MHz)	Standard Testing	Termination 7 = Au T = NiSn	Product Code 00 = Standard Product	Packaging Code 1 = Bulk 2 = 500 pcs, 7" reel 4 = 2000 pcs, 13" reel

ELECTRICAL SPECIFICATIONS*

Frequency (GHz)	Isolation (dB min)	I. L. (dB max)	VSWR	Amplitude Balance (dB max)	Phase Balance (Degrees)	Max Power (Watts)	Operating Temperature (°C)
1.5 – 2.1	18	0.25	1.25	±0.45	±3°	30	-55 to +85

* Specification based on performance of component assembled properly on printed circuit board with 50Ω nominal impedance.

QUALITY INSPECTION

Finished parts are 100% tested for electrical parameters and visual characteristics.

TERMINATION

Finishes include NiSn, and immersion Au. All finishes compatible with automatic soldering technologies: Pb free reflow, wave soldering, vapor phase and manual.

OPERATING TEMPERATURE

- 55°C to +85°C

Hybrid Couplers 3dB, 90°

Type PC2025A2100AT00

MECHANICAL OUTLINE

TOP VIEW
(Near-side)

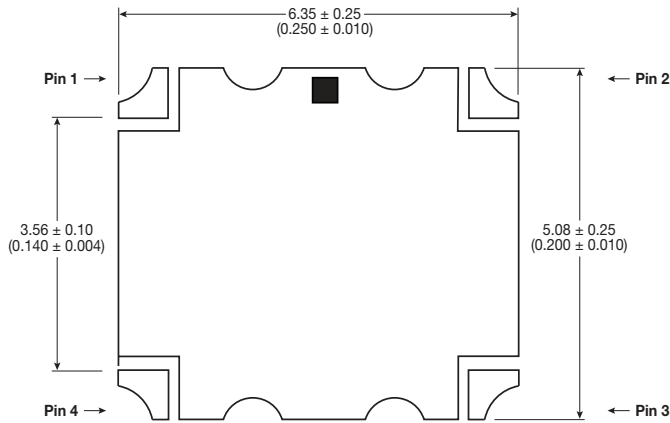

BOTTOM VIEW
(Far-side)

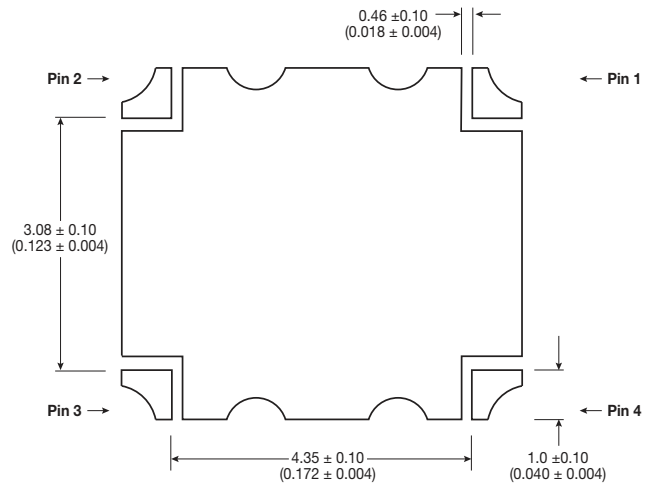

SIDE VIEW

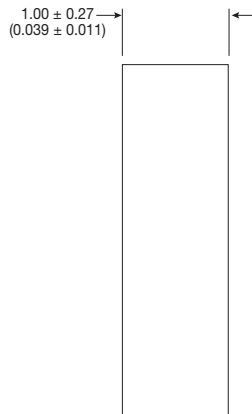

Dimensions mm (inches)
Tolerances are Non-Cumulative

Hybrid Couplers 3dB, 90°

Type PC2025A2100AT00



TYPICAL PERFORMANCE: 1.5 TO 2.1 GHz

Insertion Loss

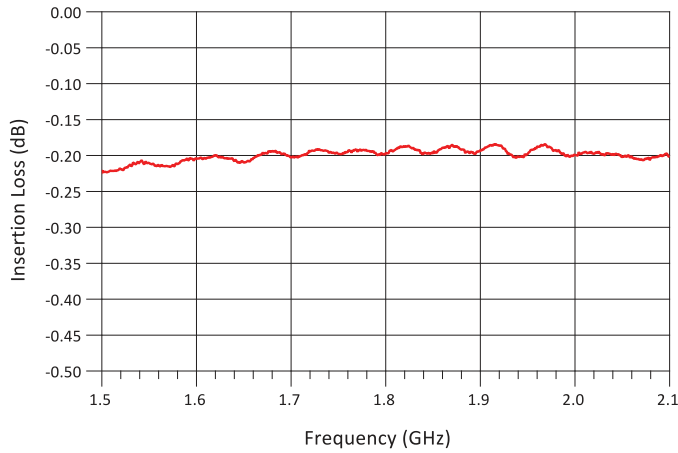

Coupling

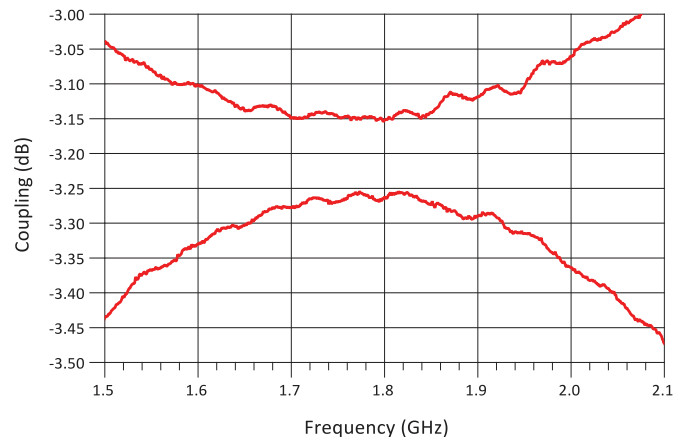

Amplitude Balance

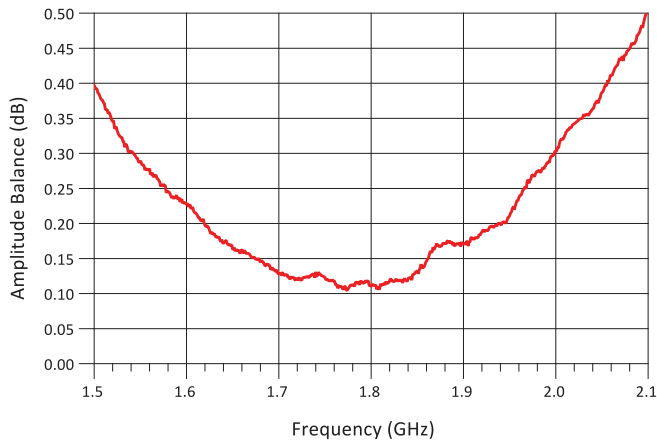

Phase Balance

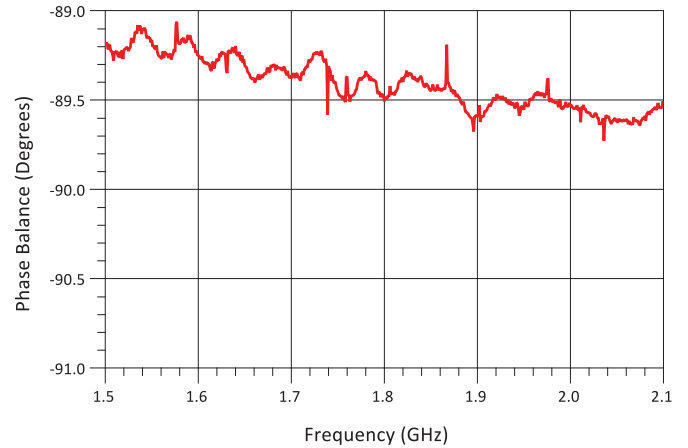

Return Loss

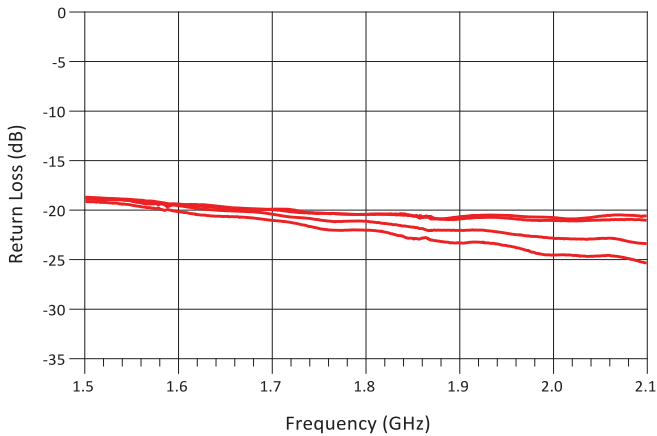

Isolation

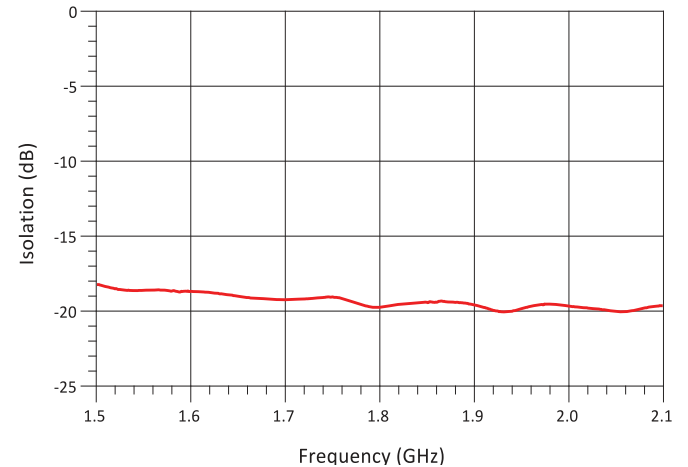

Hybrid Couplers 3dB, 90°

Type PC2025A2100AT00

HYBRID COUPLER TEST JIGS

GENERAL DESCRIPTION

These jigs are designed for testing the 3dB Hybrid Couplers using a Vector Network Analyzer. They consist of a dielectric substrate, having Cu microstrips as conducting lines and a bottom ground plane located at a distance of 0.254mm from the microstrips.

The substrate used is Taconic RF 35 0100. The connectors are SMA type (female), 'Johnson Components Inc.' Product

MOUNTING AND MEASUREMENT PROCEDURE

MLO™ hybrid couplers require a 50Ω transmission lines leading to and from all of the RF ports. Proper grounding is required in order to ensure optimal device performance.

All of the MLO™ components utilize castellated interconnects which allow for high yield assembly, expansion matched and halogen free dielectrics.

The MLO™ hybrid coupler is a symmetrical device. When a port is designated as the input, automatically the two output and isolated ports are defined. For example, if the input port for a device was selected to be Pin 1, Pin 2 is automatically the isolated port, Pin 4 is the 0 degree reference output port, and Pin 3 is the output port which "lags" behind the reference output port by 90 degrees. Similarly, if Pin 3 was to be selected as the input port, the adjacent port on the long side (Pin 4) is the isolated port, the adjacent port on the short side (Pin 2) is the 0 degree output port, and the opposite port (Pin 1) is the 90 degree output port.

PIN: I42-070I-84I. Both a measurement jig and a calibration jig are provided. The calibration jig is designed for a full 2-port calibration, and consists of an open line, short line and through line. LOAD calibration can be done by a 502 SMA termination.

PIN CONFIGURATION

The PC2025A2100 part has an orientation marker to denote Pin 1. Once port one is determined the other ports are As defined; See the chart below for clarification:

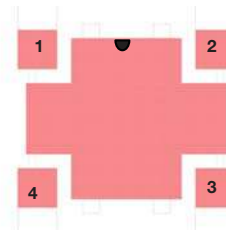

Configuration	Pin 1	Pin 2	Pin 3	Pin 4
Splitter	Input	Isolated	-3dB ∠θ-90	-3dB ∠θ
Splitter	Isolated	Input	-3dB ∠θ	-3dB ∠θ-90
Splitter	-3dB ∠θ-90	-3dB ∠θ	Input	Isolated
Splitter	-3dB ∠θ	-3dB ∠θ-90	Isolated	Input
*Combiner	A ∠θ-90	A ∠θ	Isolated	Output
*Combiner	A ∠θ	A ∠θ-90	Output	Isolated
*Combiner	Isolated	Output	A ∠θ-90	A ∠θ
*Combiner	Output	Isolated	A ∠θ	A ∠θ-90

*Note: "A" is the amplitude of the applied signals. When two quadrature signals with equal amplitudes are applied to the coupler as described they will combine at the output port.

MEASUREMENT PROCEDURE

Measurement Jig

Connector 1

Connector 2

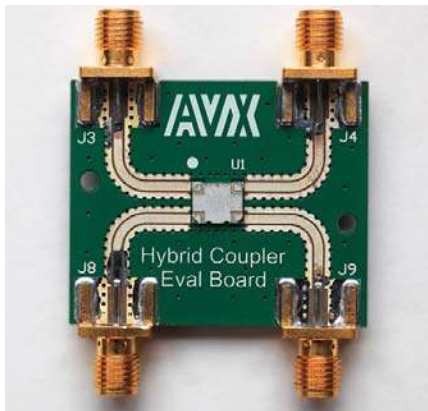

Connector 4

Connector 3

Calibration Jig

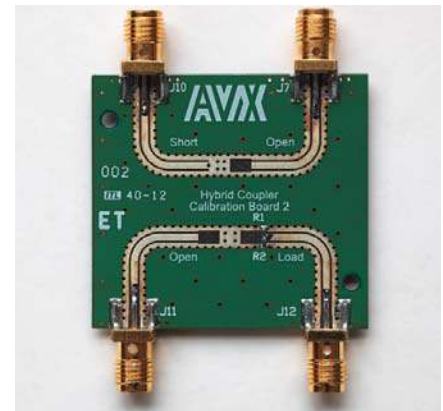
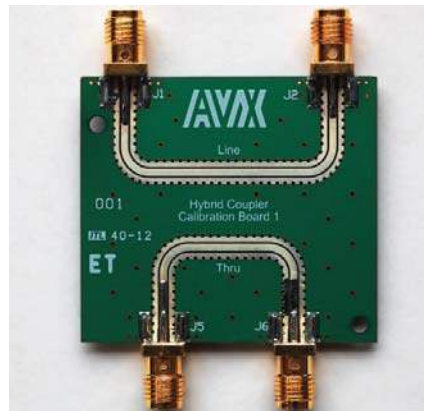

Hybrid Couplers 3dB, 90°

Type PC2025A2100AT00

AUTOMATED SMT ASSEMBLY

The following section describes the guidelines for automated SMT assembly of MLO™ RF devices which are typically Land Grid Array (LGA) packages or side termination SMT packages.

Control of solder and solder paste volume is critical for

surface mount assembly of MLO™ RF devices onto the PCB. Stencil thickness and aperture openings should be adjusted according to the optimal solder volume. The following are general recommendations for SMT mounting of MLO™ devices onto the PCB.

SMT REFLOW PROFILE

Common IR or convection reflow SMT processes shall be used for the assembly. Standard SMT reflow profiles, for eutectic and Pb free solders, can be used to surface mount the MLO™ devices onto the PCB. In all cases, a temperature gradient of 3°C/sec, or less, should be maintained to prevent warpage of the package and to ensure that all joints reflow properly. Additional soak time

and slower preheating time may be required to improve the out-gassing of solder paste. In addition, the reflow profile depends on the PCB density and the type of solder paste used. Standard no-clean solder paste is generally recommended. If another type of flux is used, complete removal of flux residual may be necessary. Example of a typical lead free reflow profile is shown below:

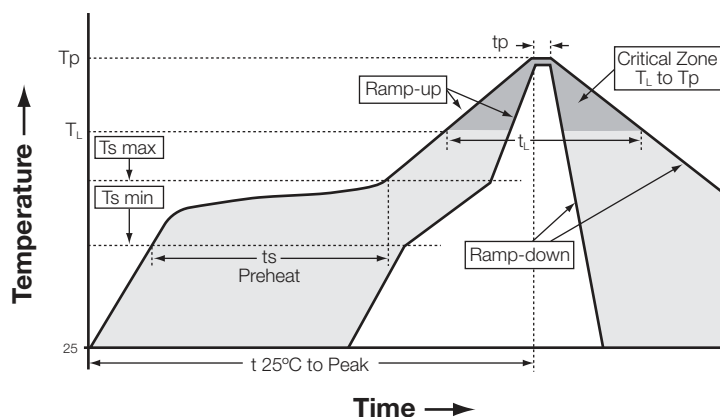

Profile Parameter	Pb free, Convection, IR/Convection
Ramp-up rate (T _{smax} to T _p)	3°C/second max.
Preheat temperature (T _{s min} to T _{s max})	150°C to 200°C
Preheat time (t _s)	60 – 180 seconds
Time above T _L , 217°C (t _L)	60 – 120 seconds
Peak temperature (T _p)	260°C
Time within 5°C of peak temperature (t _p)	10 – 20 seconds
Ramp-down rate	4°C/second max.
Time 25°C to peak temperature	6 minutes max.

Hybrid Couplers 3dB, 90°

Type PC2025A2100AT00

RECOMMENDED PAD LAYOUT

To ensure proper electrical and thermal performance there must be ground plane with 100% solder connection underneath the part

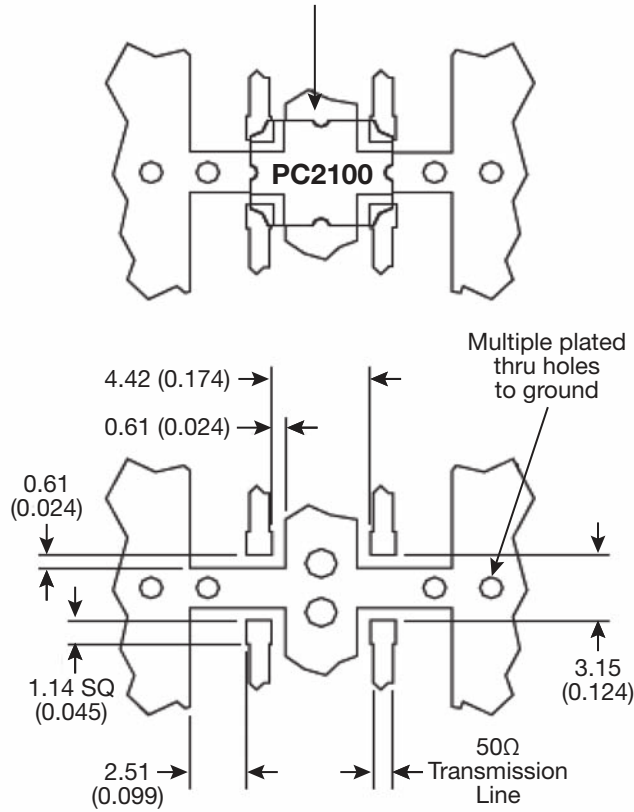

Dimensions are in mm (inches)