

LED Driver

USC4 LITE



USC4 LITE

Highlights & Features

- Constant current design
- Programmable output current through programming tool
- 6KV Combi-wave surge rating meet ANSI C82.77-5
- UL LISTED, Class P & Type HL , UL Dry & Damp
- 1-10V dimming available
- 50,000hours lifetime

Safety Standards



Class P
LED Class 2 Output
For Dry and Damp Location

Class2 of UL1310 for 55W

Model Number: USC4-□□□□□GB

Dimensions (L x W x H):

USC4-055180GB	6.59" x 2.36" x 1.5" (167.5 x 60.0 x 37.5mm)
USC4-100140GB	6.59" x 2.36" x 1.5" (167.5 x 60.0 x 37.5mm)
USC4-200140GB	9.45" x 2.36" x 1.5" (240.0 x 60.0 x 37.5mm)

General Description

Delta LED drivers come in different series to suit different application needs. The USC4 LITE series features programmable output current level. USC4 LITE series offers the capability to achieve different level of LED brightness via built-in 1-10V dimming function to meet various application and energy optimization needs. The products are designed and rigorously tested to work with various outdoor LED lighting conditions. Featuring high surge immunity (CM: 6kV, DM: 6kV) and complying to Dry and Damp location.

Model Information

USC4 LITE LED Driver

Model Number	Input Voltage Range	Rated Output Voltage	Programmable Output Current	Constant Power Current
USC4-055180GB	277-480Vac Typical	18-52.4Vdc	520-1800mA	1050-1800mA
USC4-100140GB	249 -528Vac Range	50-143Vdc	600-1400mA	700-1400mA
USC4-200140GB		75-190Vdc	600-1400mA	1050-1400mA

Model Numbering

US	C	4	-	□□□	□□□	GB
Safety Approval - UL,	Constant current	Outdoor and High voltage input		Output Power 055:55W 100:100W/ 200:200W	Max Output Current 140 – 1400mA 180 – 1800mA	Programmable output current 1-10V dimming

LED Driver

USC4 LITE

Specifications

Model Number	USC4-055180GB	USC4-100140GB	USC4-200140GB
--------------	---------------	---------------	---------------

Input Ratings / Characteristics

Normal Input Voltage	277-480Vac			
Input Voltage Range	254-528Vac			
Normal Input Frequency	50-60Hz			
Input Frequency Range	47-63Hz			
Max. Input Current	277Vac	0.27A	0.42A	0.8A
	480Vac	0.17A	0.25A	0.5A
Efficiency ¹⁾	277Vac	88.5%@1.05A	91.5%@0.7A	92.5%@1.05A
	480Vac	88.0%@1.05A	92.5%@0.7A	93.5%@1.05A
Inrush Current @ Cold Start	277Vac	100A/200uS	100A/200uS	100A/200uS
	480Vac	200A/200uS	200A/200uS	200A/200uS
Power Factor	> 0.9 @Full Load			
Total Harmonic Distortion	THD < 20% @Full Load			
Leakage Current	< 0.75mArms per UL8750			

1) 100% Load (typical) and tested after 30 minutes warm up.

Output Ratings / Characteristics

Output Voltage Range	18-52.4Vdc	50-143Vdc	75-190Vdc
Max. No Load Output Voltage	60Vrms	150Vrms	230Vrms
Output Power Range	55W	100W	200W
Adjustable Output Current (AOC)	520-1800mA	600-1400mA	600-1400mA
	With steps of 1mA, configurable via software		
Minimum Output Current	10% of AOC		
Current Accuracy	± 5% (@ Typical output current range)		
Output Current LF Ripple	15% (ripple = peak-average/average) and 5% (Low frequency (≤120 Hz)) @Full Load		
Start-up Time	1000ms max. @ 277-480Vac @Full Load		

LED Driver

USC4 LITE

Model Number	USC4-055180GB	USC4-100140GB	USC4-200140GB
---------------------	---------------	---------------	---------------

Mechanical

Casing	Steel case, color : Black		
Dimensions (L x W x H) [inch] [mm]	6.59" x 2.36" x 1.5" (167.5 x 60.0 x 37.5mm)	9.45" x 2.36" x 1.5" (240.0 x 60.0 x 37.5mm)	
Unit Weight [lb] / [kg]	1.83 / 0.83	2.53 / 1.15	
Cooling System	Convection		
Input Cable	L: Black, N: White; UL1316 18AWG solid copper wires Length 300mm		
Output Cable	Positive: Red, Negative: Blue; NTC/PRG: Orange ; UL1316 18AWG solid copper wires Length 300mm		
Dimming Cable	Dim(+): Purple, Dim(-): Pink ; UL1316 18AWG solid copper wires Length 300mm		
Noise	Sound Pressure Level (SPL) < 24dBA (30cm distance)		

Environment

Ambient Temperature	Operating	-40°C to +55°C		
	Storage	-40°C to +85°C		
Maximum Case Temperature	+80°C	+85°C	+90°C	
Relative Humidity	Operating	10 to 85% RH (Non-Condensing)		
	Storage	5 to 95% RH (Non-Condensing)		
Environmental Locations	Dry & Damp, Type HL			

Protections

Over Voltage	60Vrms	150Vrms	230Vrms
	Auto-Recovery when the fault is removed		
Overload / Overcurrent	Reduce output current. Auto-Recovery when the fault is removed		
Short Circuit	Auto-Recovery when the fault is removed		
Over Temperature	Reduce output current. Auto-Recovery when the fault is removed		
Case connection	Case must be grounding		

Reliability Data

Lifetime	50,000 hours at case temp. tc & full load. Refer to "Lifetime VS Case Temperature"		
Lifetime @ tc	+80°C	+75°C	+80°C

LED Driver

USC4 LITE

Model Number	USC4-055180GB	USC4-100140GB	USC4-200140GB
---------------------	---------------	---------------	---------------

Safety Standards / Directives

Electrical Safety	UL 8750, UL List, Class P, Class2 of UL1310 for 55W			
Material and Parts	RoHS Directive 2011/65/EU Compliant			
Isolation	Main	Output	0-10V dim	Case
Main	N/A	2U + 1000V	2U + 1000V	2U + 1000V
Output	2U + 1000V	N/A	2U + 1000V	2U + 1000V
0-10V dim	2U + 1000V	2U + 1000V	N/A	2U + 1000V
Case	2U + 1000V	2U + 1000V	2U + 1000V	N/A

EMC Compliance

Emissions (CE & RE)	Compliance to 47 CFR FCC Part 15, Subpart B, Class A Compliance to CAN ICES-005(A) / NMB-005(A)
Surge	Compliance to ANSI C82.77-5 CAT C low 6KV Meet Criteria A or B

1) Criteria A: Normal performance within the specification limits

2) Criteria B: Temporary degradation or loss of function, which is self-recoverable

0-10V Dimming Specification

Absolute Maximum Voltage	± 20V
Source Current	100µA (typ)
Dimming Input Range	(1) 1-10V for 10-100% dimming and 1V for 10% of I _{o_set} and ≥ 8.5V is 100% of I _{o_set} (2) Short is 10% of I _{o_set} (or 100mA minimum) & Open is 100% (3) See 1-10V Dimming Curve

Default Settings of the Driver (can be configured with programming tool)

Adjustable Output Current (AOC)	1050mA	700mA	1050mA
Smart Timer DIM	Disabled Smart Time Dim		
Module Temperature Protection (MTP)	Disabled. Configurable though programming tool		
Constant Lumen Output (CLO)	Disabled. Configurable though programming tool.		
End of Life indication (EOL)	Disabled. Configurable though programming tool		

LED Driver

USC4 LITE

Model Number	USC4-055180GB	USC4-100140GB	USC4-200140GB
---------------------	---------------	---------------	---------------

Smart Timer Dim

Provides three operation modes: Fixed Timer, Midnight Centric Timer, Ratio Rescale Timer.

Fixed Timer

It is a memoryless-based dimming mode that tracks the output level based on the programmed timing curve. The output level is organized by scheduled profile in five steps.

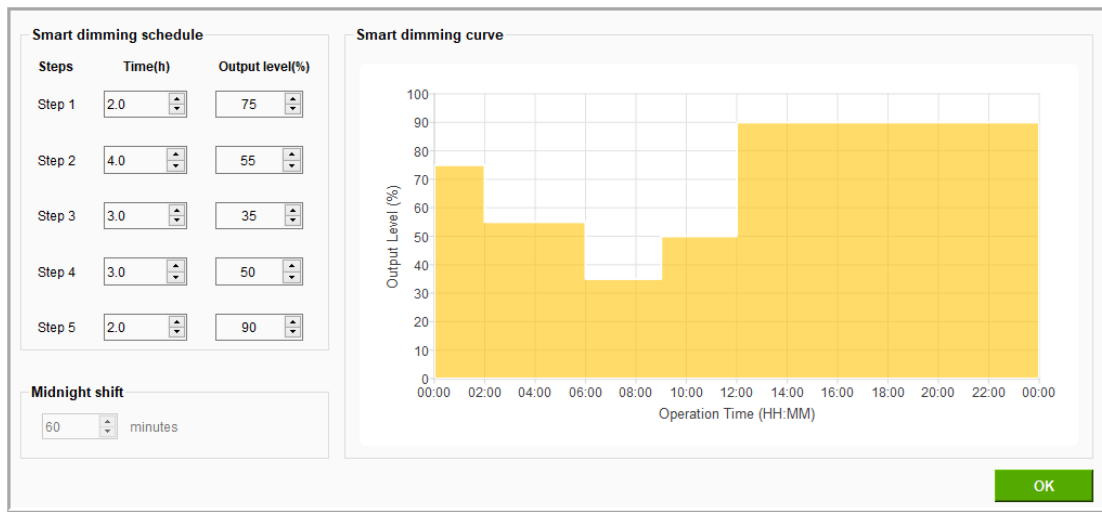

Midnight Centric Timer

This mode is an memory-based that automatically measures over the past two days the power-on time of the lighting installation at which is the naturally corresponded to night time. The Midnight Centric Timer software calculates the length of power on time and centralized from the given virtual midnight point and change the output level accordingly. More specifically, when the LED driver is power-on during the very first two days or the power-on time difference of past two days is more than 15 minutes, the output current will fixed to the maximum level since there is no valid (reasonable) data for reference. Start from the third day and so on, when the power-on time difference of past two days is less than 15 minutes, the output level is controlled based on the correlation between the midnight point of programmed profile and yesterday power-on duration.

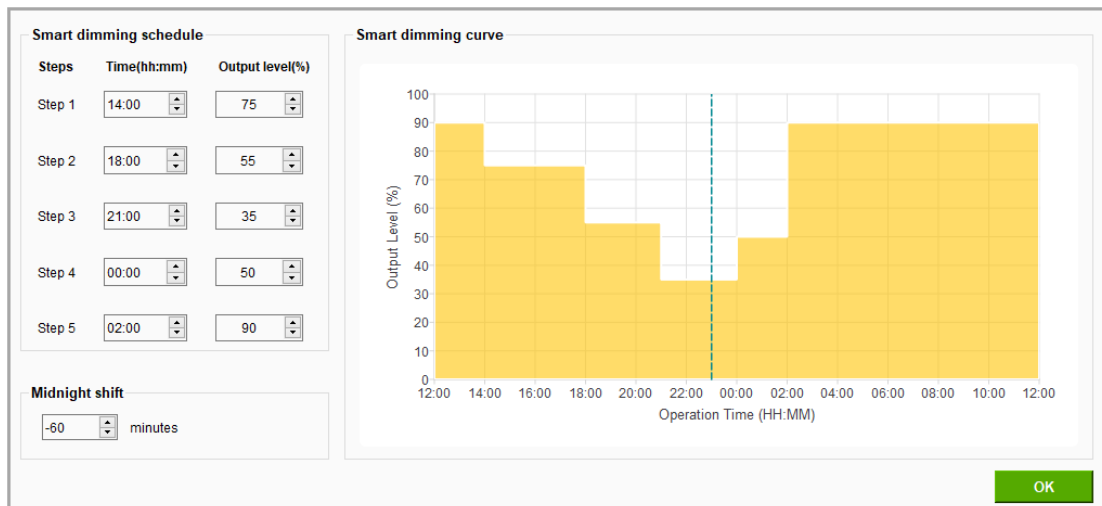

LED Driver

USC4 LITE

Ratio Rescale Timer

This mode is similar to Midnight Centric Timer that records the power-on time based on the local night time. The Ratio Rescale Timer software rescale programmed output power profile of each step by a calculated percentage of the recorded power-on time (when valid) out of given 5 steps duration.

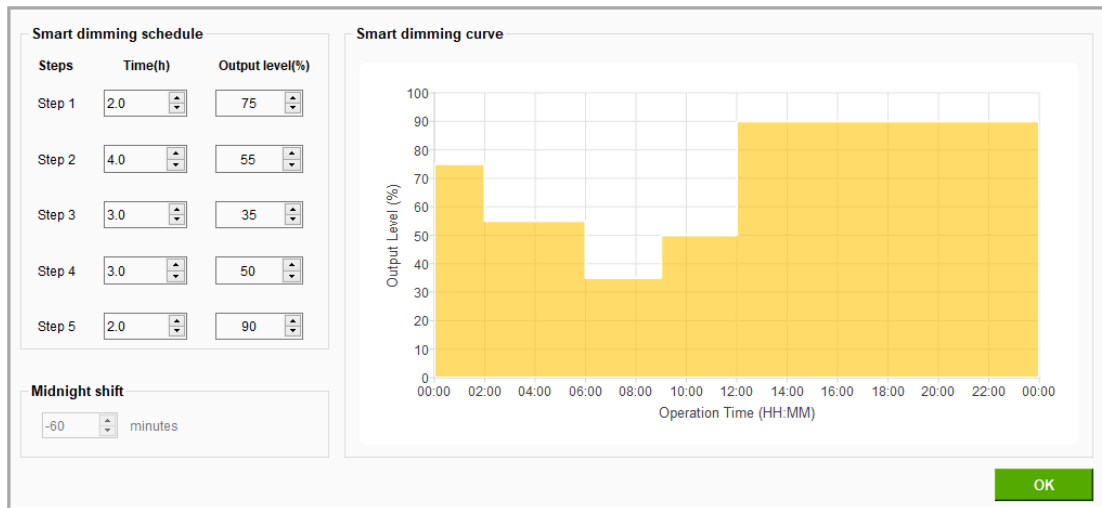

Note: When all steps are finished, the light level will remain in last level (level in step 5) for all three modes.

Module Temperature Protection (for LED module)

In the LED luminaire system application, user can enable the MTP function by GUI and be taken to place the NTC thermistor close to the hottest spot on the LED module to avoid the abnormal high temperature on LED module. If LED thermal protection is not required the NTC wire of the LED driver can be left open. The de-rating limits can be programmed using the programming tool

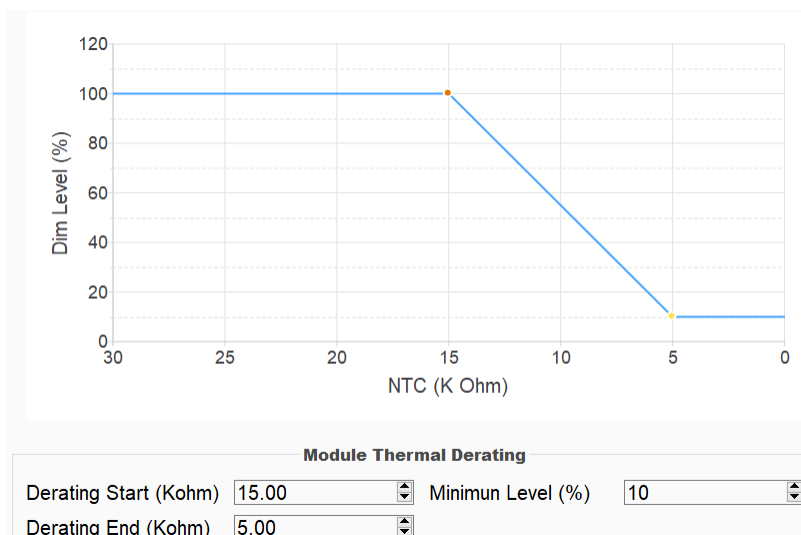

LED Driver

USC4 LITE

Operation Window for programming

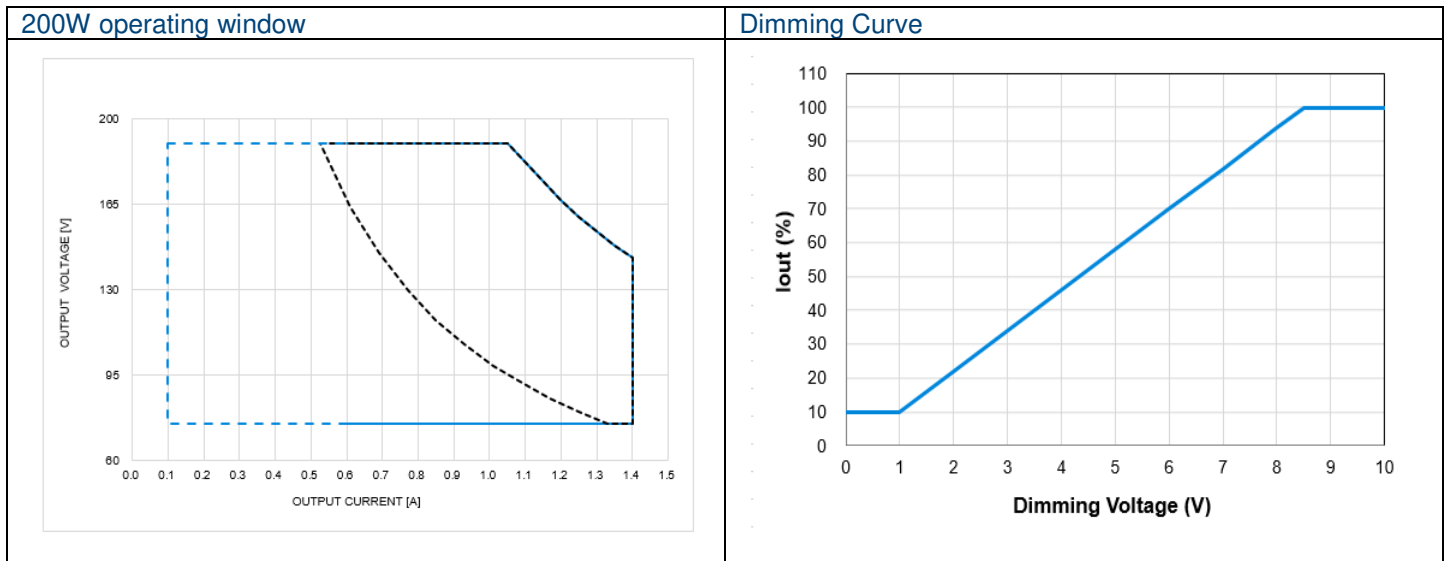
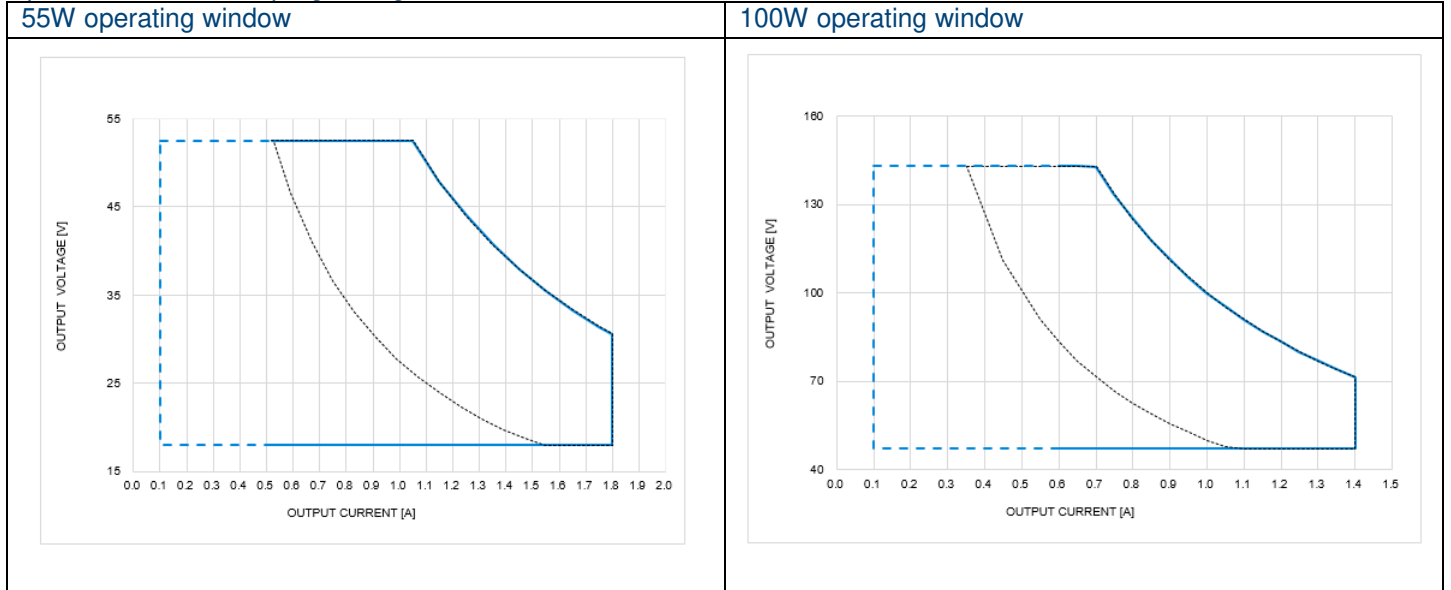

Note
 Blue dot line for 0-10V range
 Blue solid line for programming range
 Black dot line for performance (PF>0.9V and THD<20%)

LED Driver

USC4 LITE

Efficiency VS Output Power

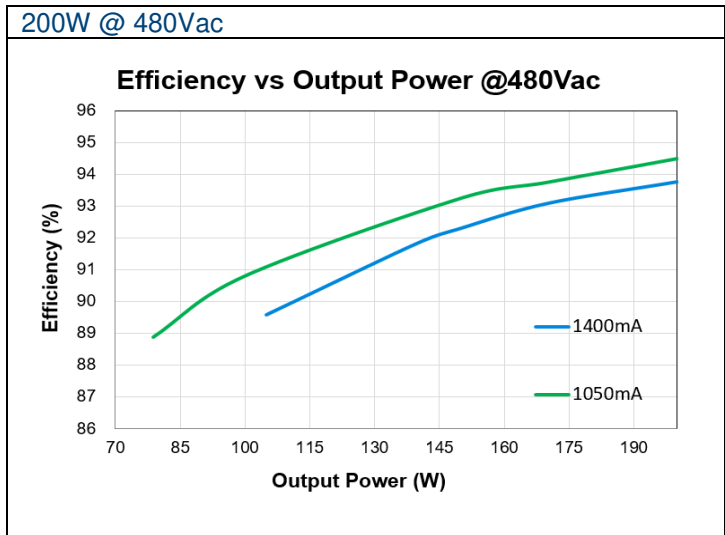
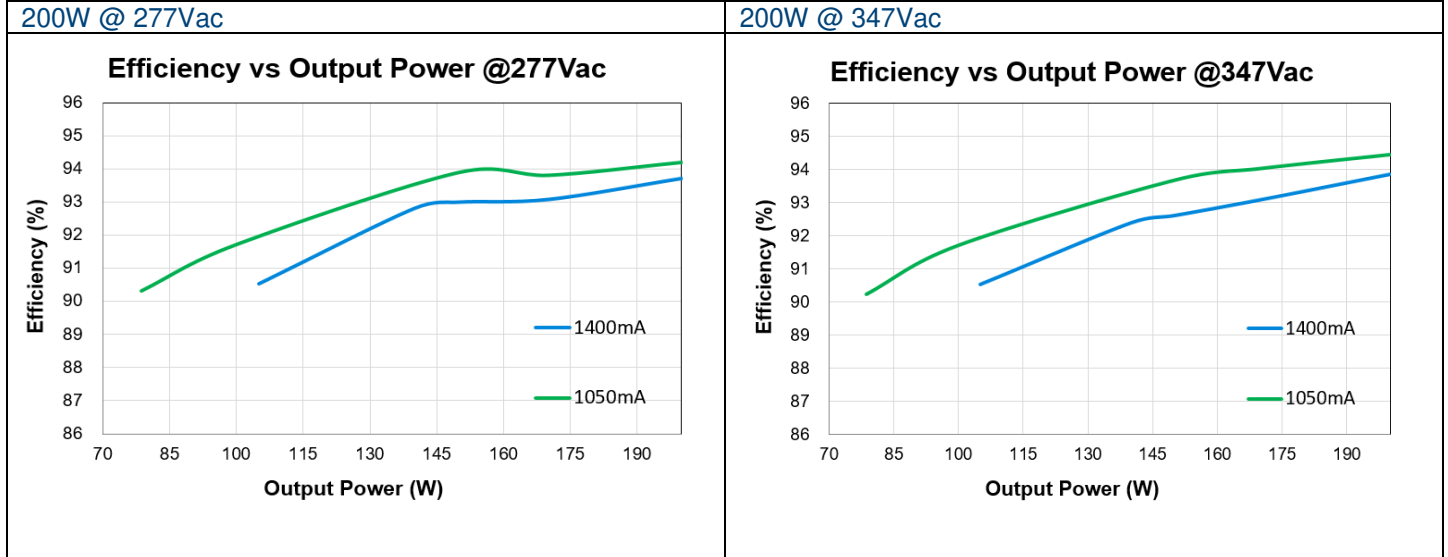

LED Driver

USC4 LITE

Power Factor VS Output Power

200W @ 277Vac

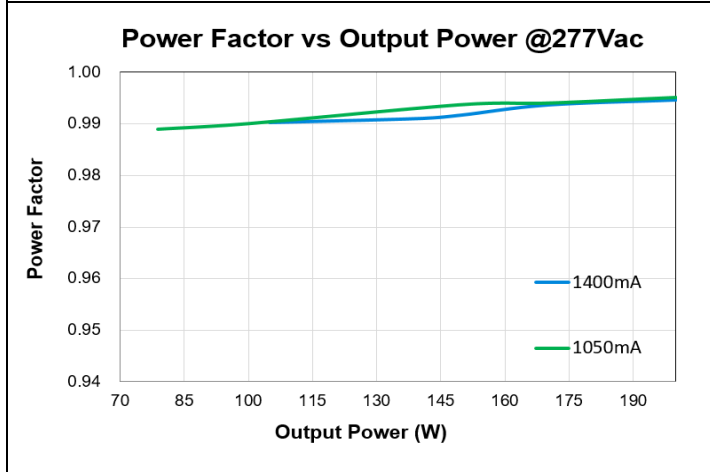

200W @ 347Vac

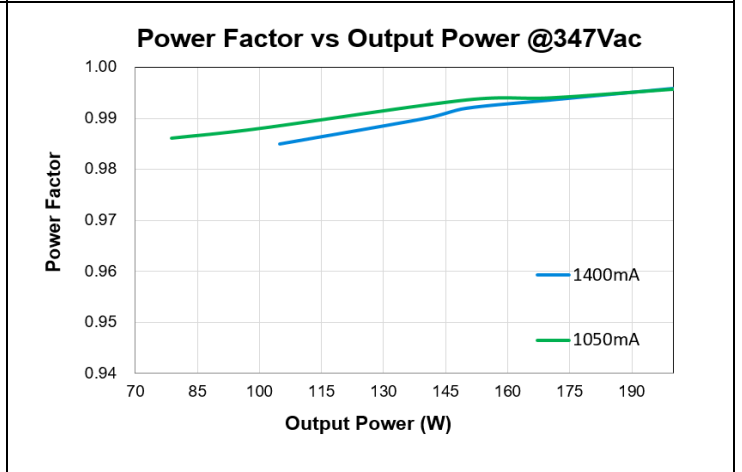

200W @ 480Vac

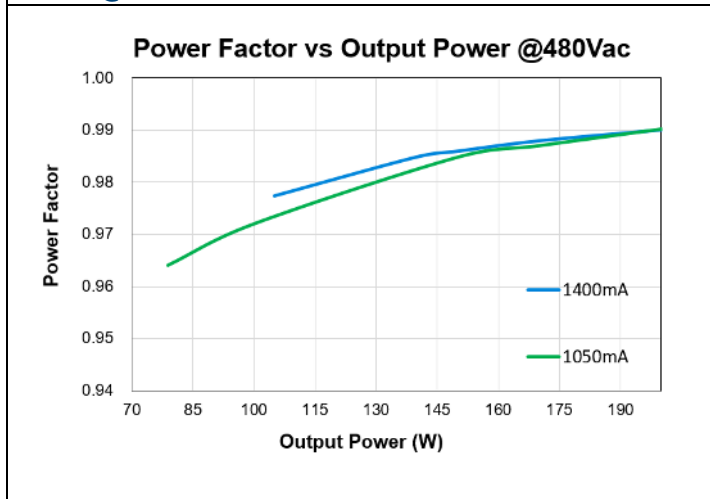

LED Driver

USC4 LITE

Total Harmonic Distortion VS Output Power

200W @ 277Vac

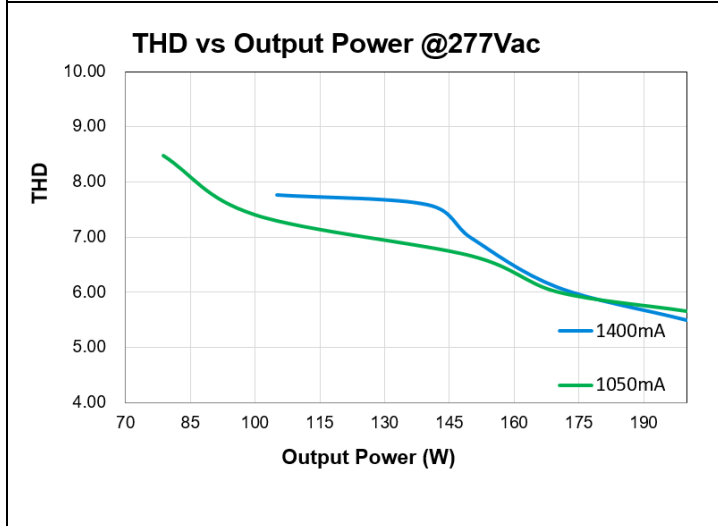

200W @ 347Vac

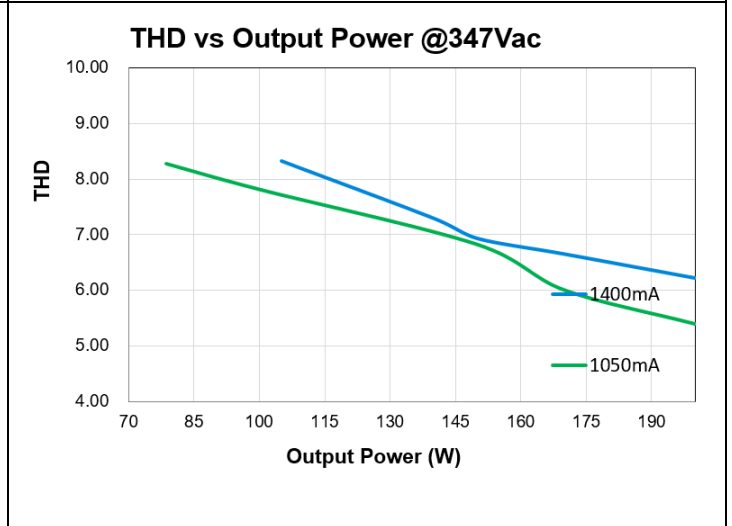

200W @ 480Vac

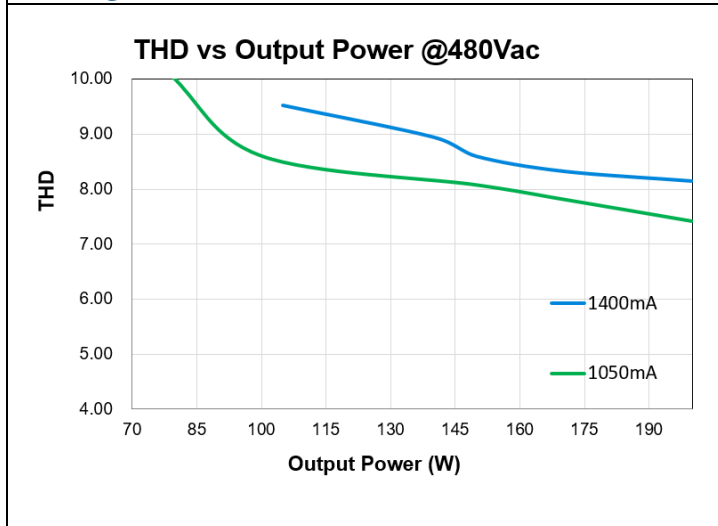

LED Driver

USC4 LITE

Efficiency VS Output Power

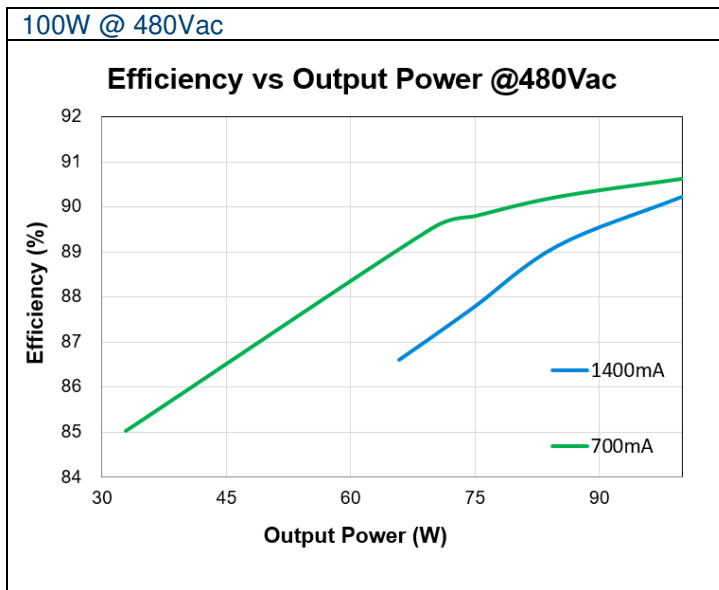
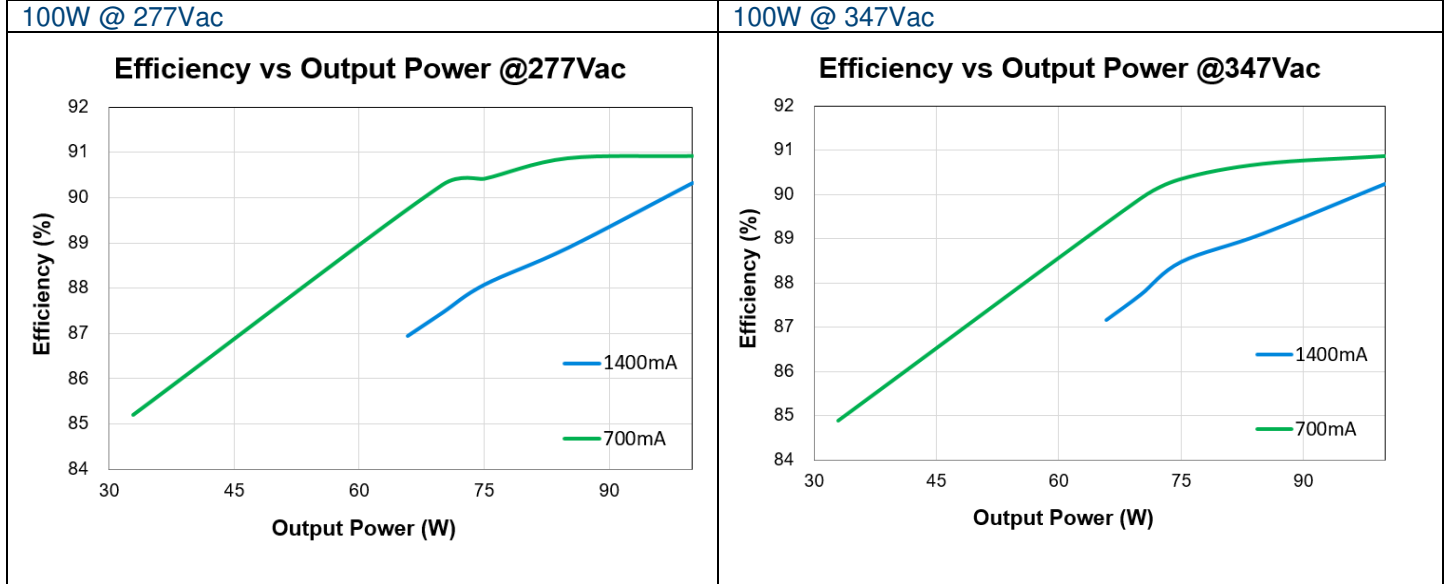

LED Driver

USC4 LITE

Power Factor VS Output Power

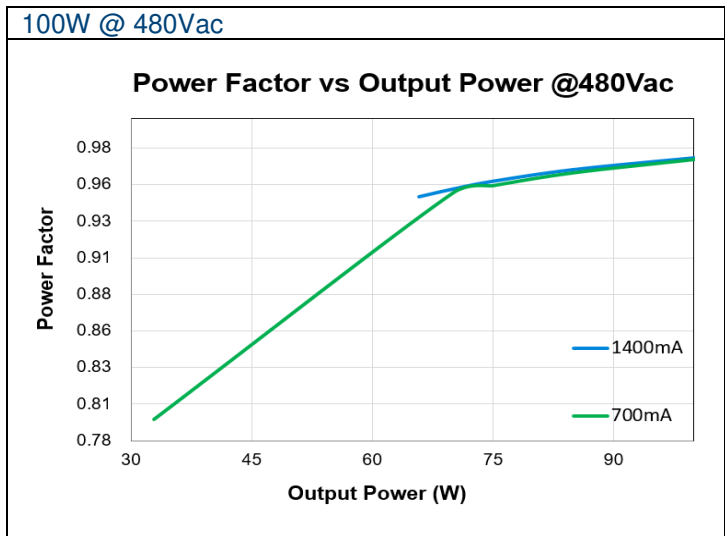
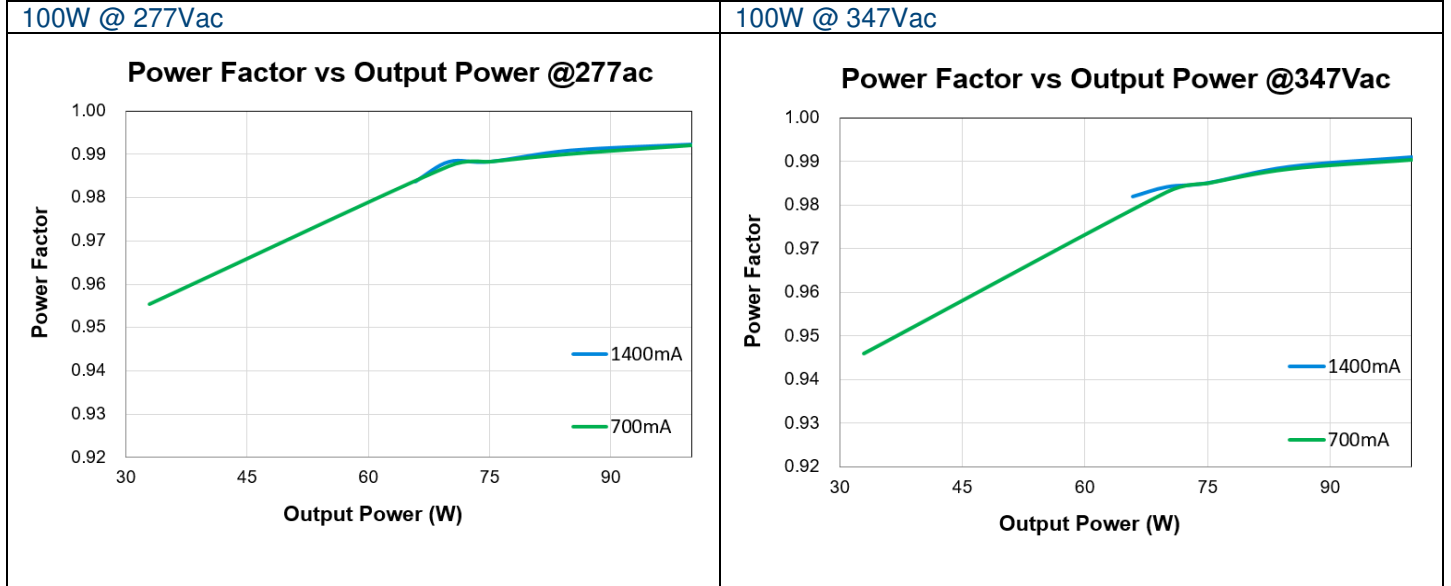

LED Driver

USC4 LITE

Total Harmonic Distortion VS Output Power

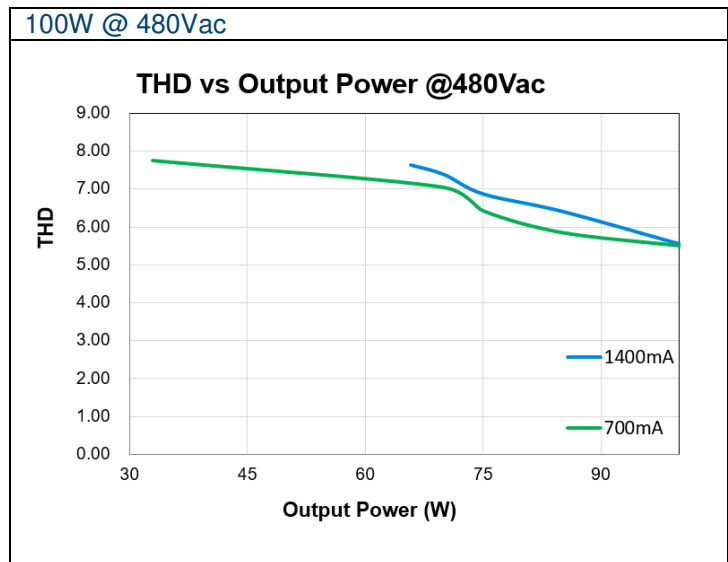
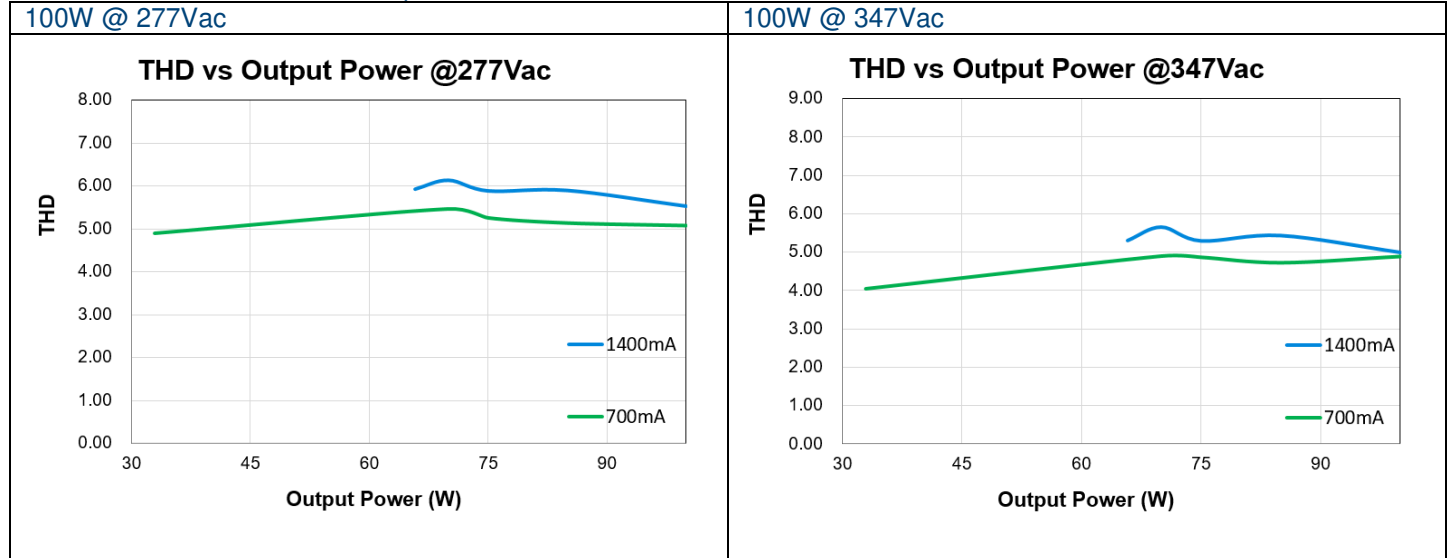

LED Driver

USC4 LITE

Efficiency VS Output Power

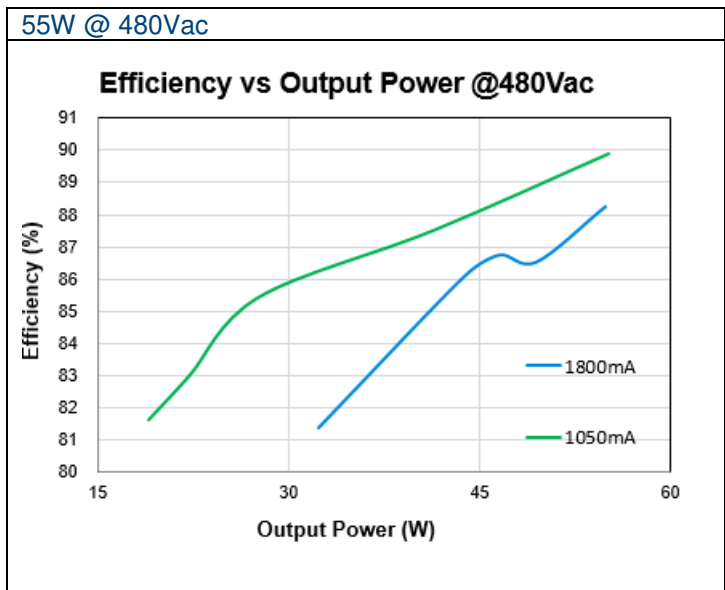
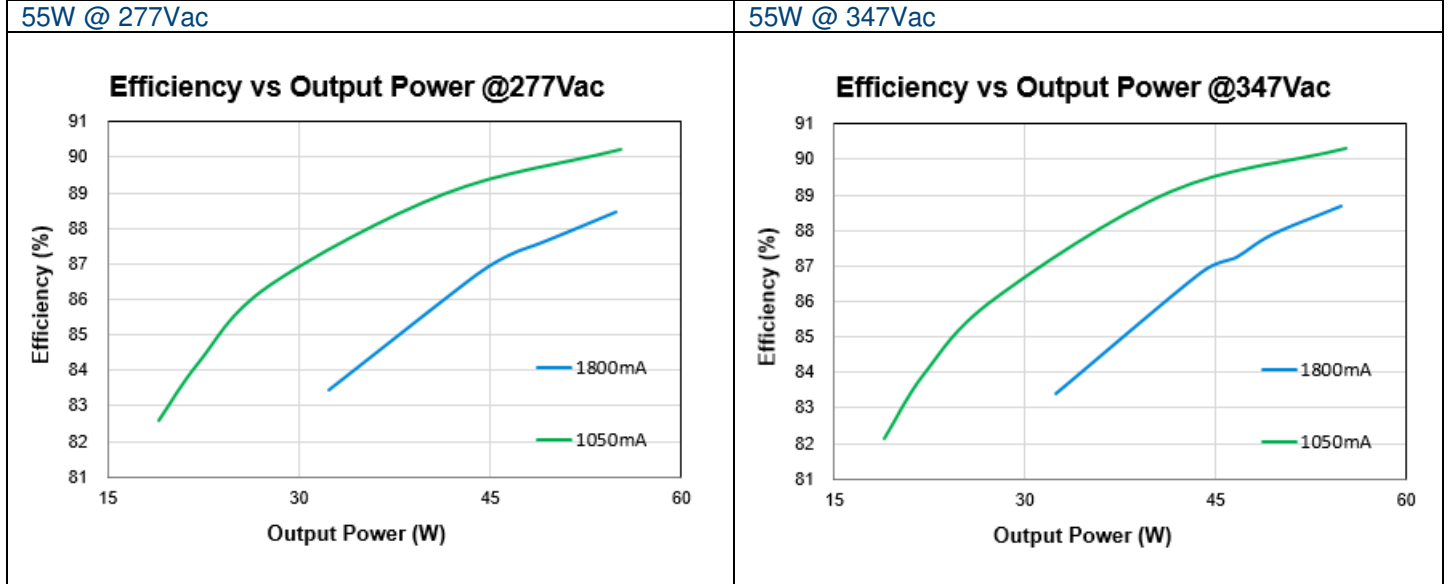

LED Driver

USC4 LITE

Power Factor VS Output Power

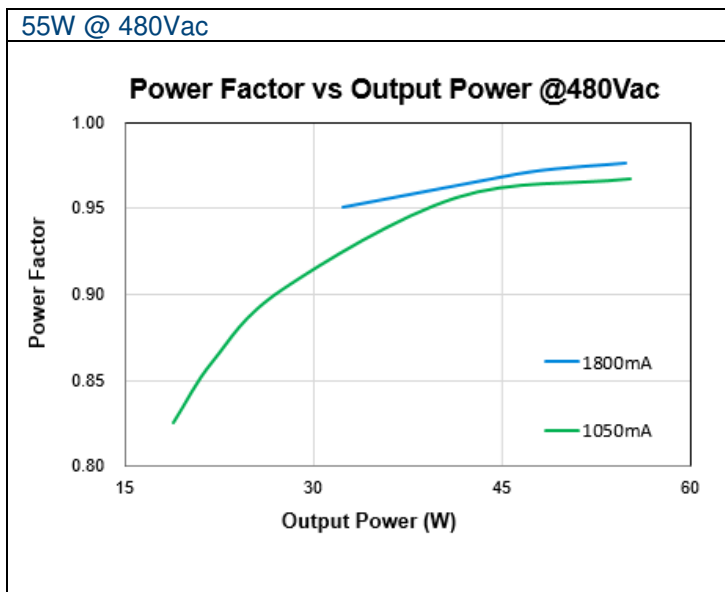
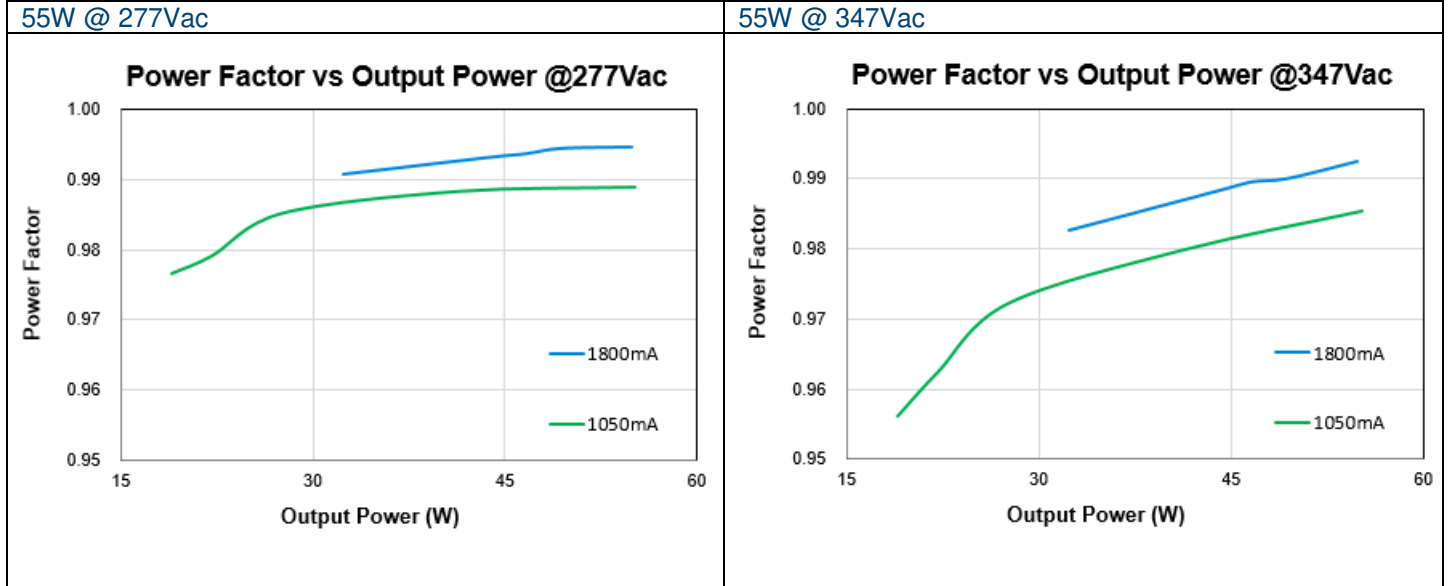

LED Driver

USC4 LITE

Total Harmonic Distortion VS Output Power

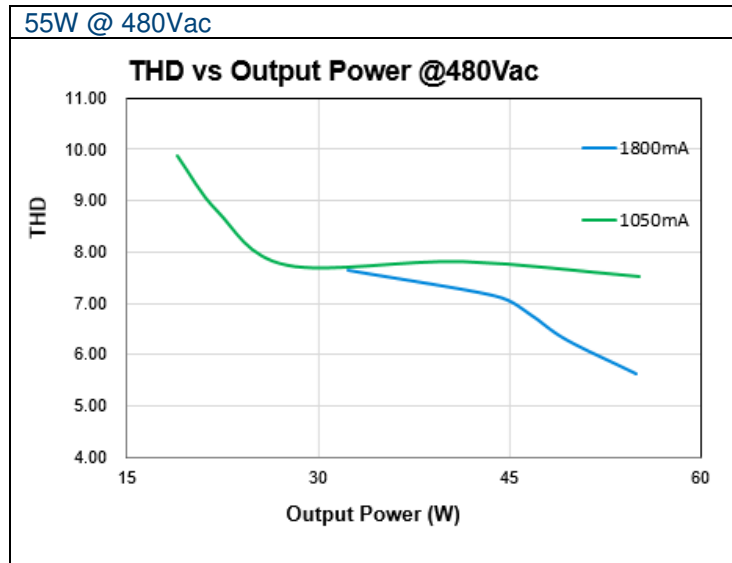
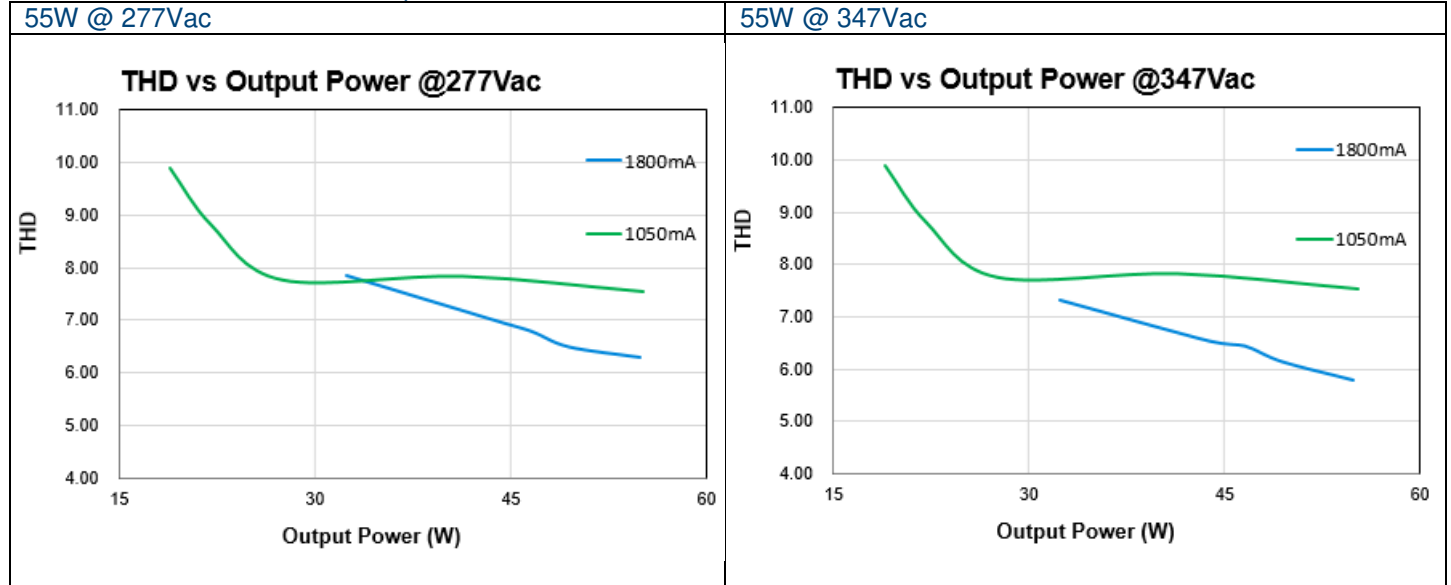

LED Driver

USC4 LITE

Lifetime VS Case Temperature

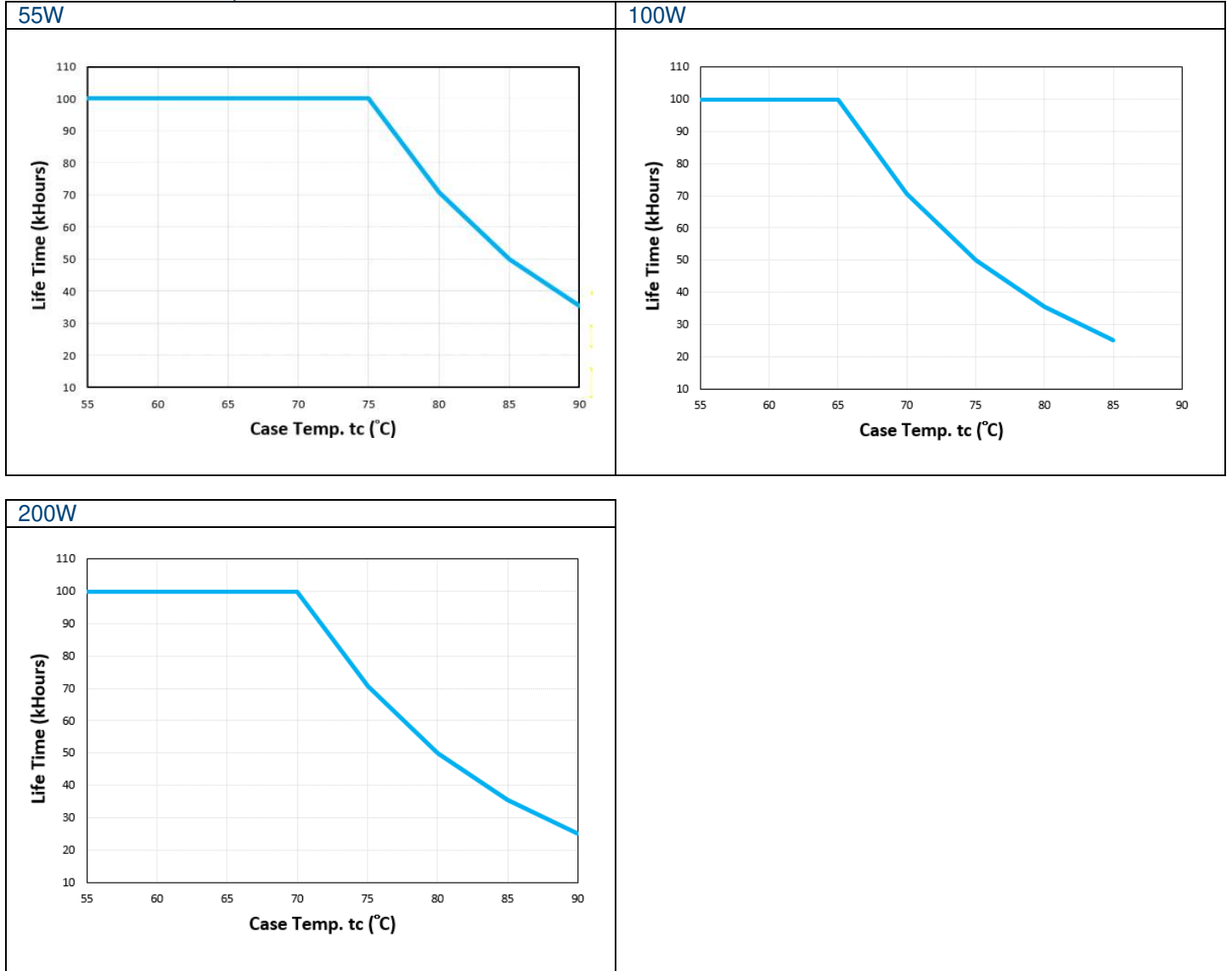

LED Driver

USC4 LITE

Enclosure Dimensions

	USC4-055180GB / USC4-100140GB	USC4-200140GB
	inch [mm]	inch [mm]
Total length (L1)	6.59 [167.5]	9.45 [240]
Case length (L2)	5.48 [139.2]	8.39 [213.2]
Case width (W)	2.36 [60.0]	2.36 [60.0]
Case height (H)	1.5 [37.5]	1.5 [37.5]
Mounting length (M1)	6.03 [153.2]	8.9 [226]
Mounting hole diameter (M2)	0.32 [8.0]	0.32 [8.0]

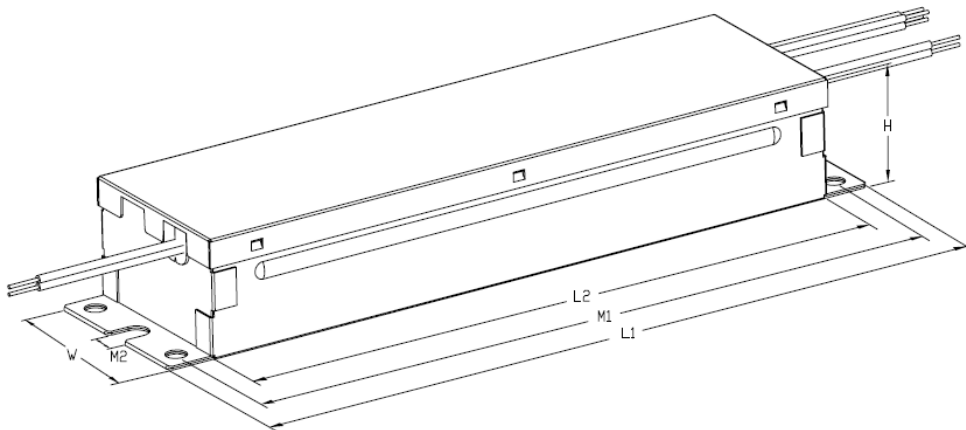

Wiring Diagram

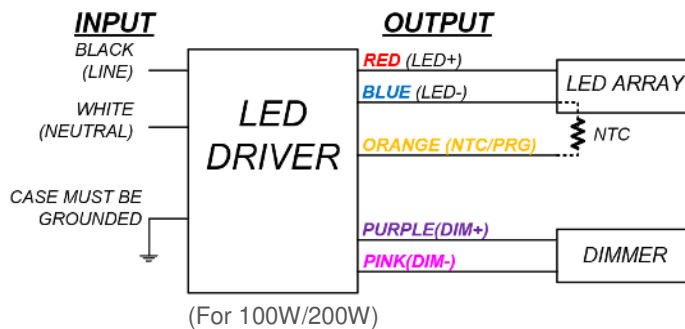
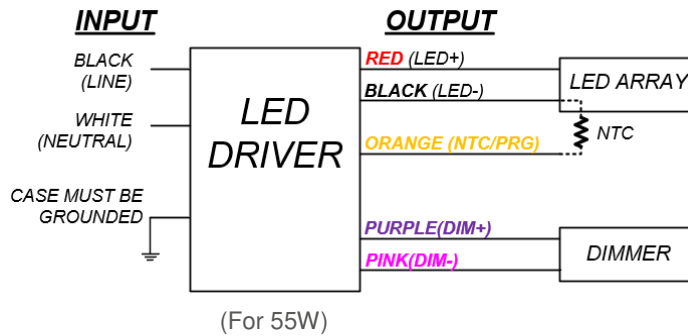

LED Driver

USC4 LITE

Assembly & Installation

The device is not recommended to be placed on low thermal conductive surfaces. For example, plastics.

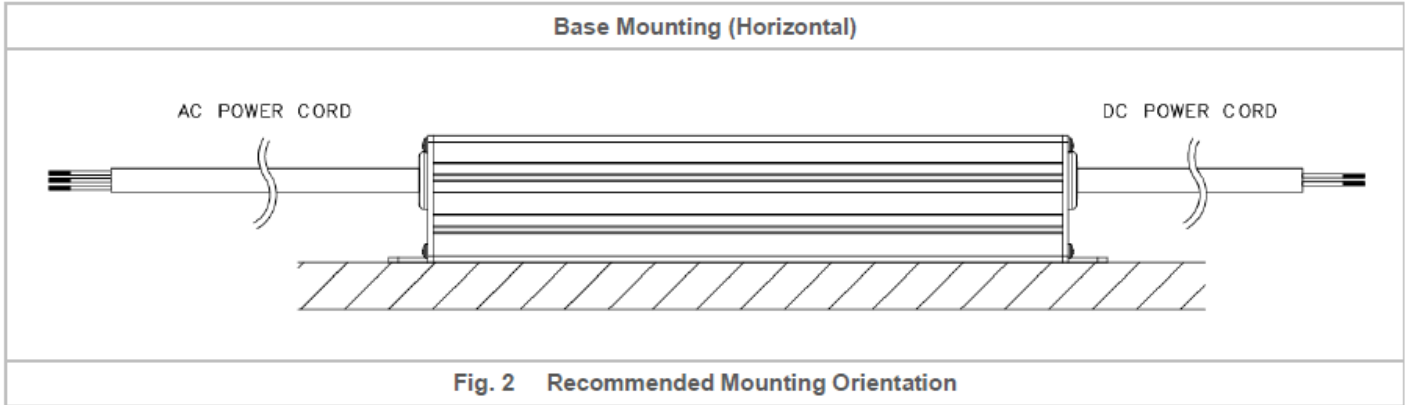

Safety Instructions

- ALWAYS switch mains of input power OFF before connecting and disconnecting the input voltage to the device. If mains are not turned OFF, there is risk of explosion / severe damage.
- To guarantee sufficient convection cooling, keep a distance of 50mm above and lateral distance to other units.
- DO NOT insert any objects into the device.
- The case of LED driver must be connected with grounding (PE).
- The current rating for the output cable must be rated higher than or equal to the output current of the power supply. Please refer to the product specifications..

Others

Warranty Policy

Please reach out our [Warranty Policy](#) should you require any further clarification.