

Evaluating the **ADM3055E** 5 kV rms, Signal and Power Isolated, CAN Transceiver for CAN FD

FEATURES

- ADM3055E** with *isoPower* integrated, isolated, dc-to-dc converter
- 2-layer PCB with low radiated emissions, passes EN55022 Class B
- On-board LDO for 6 V to 9 V supply, providing 5 V to the **ADM3055E** V_{CC} pin
- Screw terminal connectors include
 - 6 V to 9 V LDO, 5 V power supply to the V_{CC} pin and the V_{IO} pin
 - 5 V direct power supply to V_{CC} pin
 - 1.7 V to 5.5 V direct power supply to the V_{IO} pin
 - TXD pin, RXD pin, STBY pin, SILENT pin, AUX_{IN} pin, AUX_{OUT} pin, and RS pin signals
- Divided PCB return planes for GND₁ and GND₂
- SMA connectors for TXD pin and RXD pin signals

EVALUATION KIT CONTENTS

- EVAL-ADM3055EEBZ evaluation board
- ADM3055EBRIZ**
- ADP7104**
- LTC6900**

DOCUMENTS NEEDED

- ADM3055E** and **ADM3057E** data sheets

GENERAL DESCRIPTION

The EVAL-ADM3055EEBZ allows the user to evaluate the **ADM3055E** and the **ADM3057E** isolated signal and power transceivers for controller area network (CAN) or CAN with flexible data rate (CAN FD) networks. The EVAL-ADM3055EEBZ allows all of the input and output functions to work without the need for external components.

Based on the Analog Devices, Inc., *iCoupler*® technology, the **ADM3055E** and the **ADM3057E** integrate logic side on-off keying (OOK) signal isolation channels and an Analog Devices *isoPower*® dc-to-dc converter to provide regulated, isolated power that is well below EN55022 Class B limits when transmitting on a 2-layer printed circuit board (PCB) with ferrites.

The EVAL-ADM3055EEBZ comes populated with an **ADM3055E**.

Full specifications of the **ADM3055E** and the **ADM3057E** can be found in the **ADM3055E** and the **ADM3057E** data sheets, available from Analog Devices and must be consulted in conjunction with this user guide when using the EVAL-ADM3055EEBZ.

The EVAL-ADM3055EEBZ is compatible and can be used to evaluate the **ADM3057E**. The **ADM3055E** and the **ADM3057E** differ by package and isolation capabilities, but both devices are functionally equivalent for evaluation.

PHOTOGRAPH OF EVAL-ADM3055EEBZ

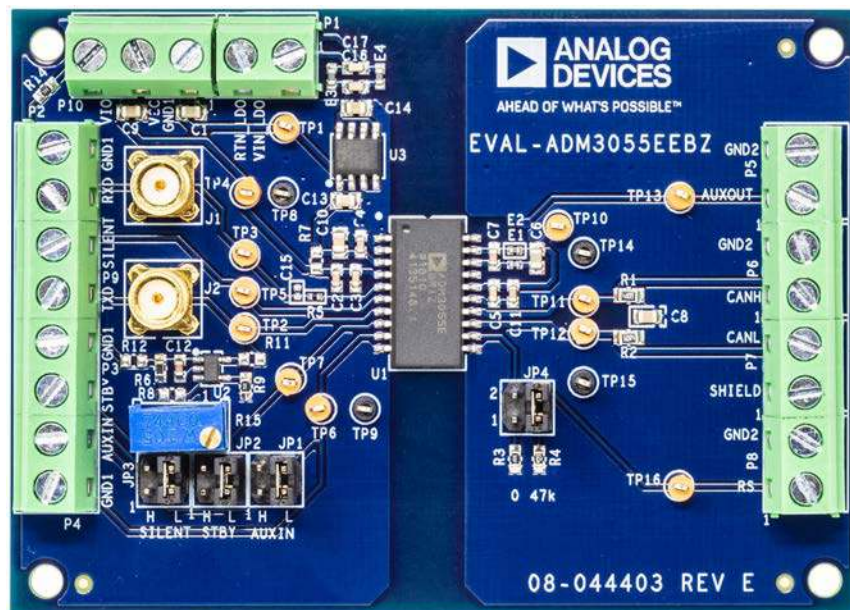

Figure 1.

TABLE OF CONTENTS

Features	1	PCB Layout Recommendations	3
Evaluation Kit Contents.....	1	EN55022 Radiated Emissions Test Results	4
Documents Needed.....	1	Evaluation Board Schematic and Artwork.....	5
General Description	1	Ordering Information	8
Photograph of EVAL-ADM3055EEBZ.....	1	Bill of Materials.....	8
Revision History	2	Related Links.....	8
Evaluation Board Hardware.....	3		
Using the Evaluation Board	3		

REVISION HISTORY

11/2018—Rev. 0 to Rev. A

Changes to Features Section and General Description Section .	1
Changes to PCB Layout Recommendations Section	3
Changes to Figure 5.....	5
Changes to Table 3.....	8

8/2018—Revision 0: Initial Version

EVALUATION BOARD HARDWARE USING THE EVALUATION BOARD

Figure 1 shows the EVAL-ADM3055EEBZ. The V_{CC} and V_{IO} supply pins of the [ADM3055E](#) device must be supplied with input power. The V_{CC} and V_{IO} pins can be powered directly with separate supplies or through the fixed output 5 V on-board low dropout regulator (LDO). The LDO input supply requires a power supply voltage of 6 V to 9 V and connects to Pin 1 of Screw Terminal P1 (marked VIN_LDO on the silkscreen) and Pin 2 of Screw Terminal P1 (marked RTN_LDO on the silkscreen). As shipped in the default configuration, the 5 V LDO output is routed to the V_{CC} pin only. To route the 5 V LDO output to the V_{IO} pin, populate R7 with a 0 Ω resistor.

Using the LDO, the complete board can be powered by a 9 V battery (when testing for electromagnetic compatibility (EMC), for example). The [ADP7104](#) LDO features reverse current protection and can be left unpowered and connected to the evaluation board VCC trace when supplying power directly to the V_{CC} pin of the [ADM3055E](#).

Start with 100 mil jumpers on JP2 and JP1, pulling the SILENT pin and STBY pin signals low for normal operation. Select either the 0 Ω R3 resistor for full speed mode or the 47 k Ω R4 resistor for slope control mode with the 100 mil jumper on JP4. Do not leave the RS signal floating because this disables the transceiver and is not a valid mode of operation.

PCB LAYOUT RECOMENDATIONS

The [ADM3055E](#) and the [ADM3057E](#) use a 180 MHz oscillator frequency to pass power through their chip scale transformers. Bypass capacitors are required for several operating frequencies. Noise suppression requires low inductance and a high frequency capacitor. Ripple suppression and proper regulation require a large value capacitor. These capacitors are most effective and required to be connected directly adjacent to the V_{ISOOUT} pin and the GND_{ISO} pin and directly adjacent to the V_{CC} pin and the GND_1 pin. To suppress noise and reduce ripple, a parallel combination of at least two capacitors is required. The recommended capacitor values for V_{ISOOUT} are 0.22 μ F and 10 μ F. The recommended capacitor values for the V_{CC} pin are 0.1 μ F and 10 μ F. The smaller capacitors must have low equivalent series resistance (ESR) and have a total lead length between the capacitor and the respective input power supply pin of less than 2 mm to be effective.

To reduce the level of electromagnetic radiation, increase the impedance to high frequency currents between the V_{ISOOUT} pin and the V_{ISOIN} pin and between the GND_{ISO} pins and the GND_2 pins and PCB connections. Using this method of emissions suppression controls the radiating signal at its source by placing surface-mount ferrite beads in series with the V_{ISOOUT} pin and the GND_{ISO} pins (see E1 and E2 ferrites in Figure 5). The impedance of the ferrite bead is approximately 1.8 k Ω between the 100 MHz and 1 GHz frequency range. This impedance value reduces the emissions at the 180 MHz primary switching frequency and the 360 MHz secondary side, rectifying frequency and harmonics. See Table 1 for examples of appropriate surface-mount ferrite beads.

Table 1. Surface-Mount Ferrite Beads

Manufacturer	Part No.
Taiyo Yuden	BKH1005LM182-T
Murata Electronics	BLM15HD182SN1

Note that the [ADM3055E](#) and the [ADM3057E](#) are self contained solutions. The devices are not rated for supplying external power to additional bus side circuitry beyond the [ADM3055E](#) or the [ADM3057E](#) power requirements. Supplying power to additional external loads beyond the [ADM3055E](#) or the [ADM3057E](#) devices themselves causes higher operating temperatures, increased emissions, and is not supported.

To pass EN55022 Class B on a 2-layer PCB, the following layout guidelines are recommended (refer to Figure 2 and Figure 5):

- Place ferrite beads between the PCB trace or plane connections and V_{ISOOUT} (Pin 19) and GND_{ISO} (Pin 18 and Pin 20).
- Do not connect V_{ISOOUT} (shown in Figure 5) to a power plane. Connect V_{ISOOUT} to V_{ISOIN} using a PCB trace.
- Ensure that V_{ISOOUT} (Pin 19) is connected first through a ferrite before connecting the pin to the V_{ISOIN} (Pin 16), as shown in Figure 2.
- Ensure that GND_{ISO} (Pin 18) is connected by a trace to the other GND_{ISO} pin (Pin 20) on the inside (device side) of the C4 0.22 μ F capacitor, as shown in Figure 2.
- Ensure that the 0.22 μ F capacitor is connected between V_{ISOOUT} (Pin 19) and GND_{ISO} (Pin 18 and Pin 20) on the device side of the ferrite beads.
- Ensure that there is a keep out area in the PCB layout around the ferrites, as shown in Figure 2 (no PCB planes under or alongside E1 and E2).
- Place the power delivery circuit in close proximity to the [ADM3055E](#) device to ensure that the VCC trace is as short as possible. The EVAL-ADM3055EEBZ PCB has a power delivery circuit located on the PCB with a short trace from the [ADP7104](#) regulator output (Pin 1, U3) to V_{CC} (Pin 3, U1). This layout example minimizes the loop area in which high frequency current can flow. An increase in the loop area results in an increase in the emissions levels.

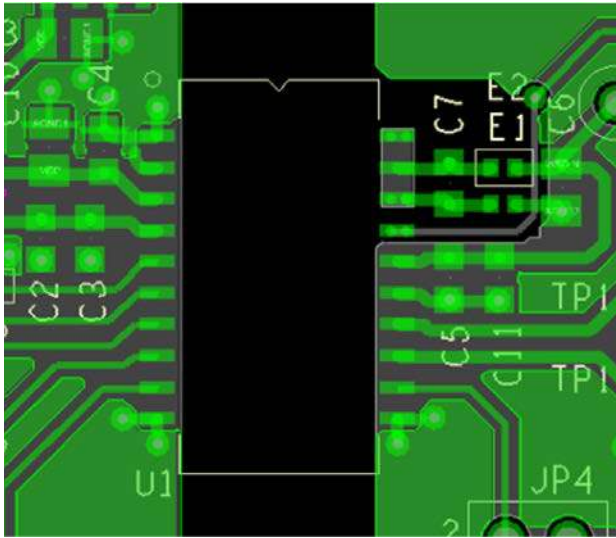

Figure 2. Layout Example for EVAL-ADM3055EEBZ

EN55022 RADIATED EMISSIONS TEST RESULTS

The EVAL-ADM3055EEBZ passes the EN55022 Class B standard. Table 2 provides the EN55022 emissions test results summary of the EVAL-ADM3055EEBZ.

The EVAL-ADM3055EEBZ was configured and tested with 5.0 V power supplied to the V_{CC} pin and the V_{IO} pin from the ADP7104 regulator output. The on-board LTC6900 generates the clock signal input to the TXD pin and can be set to a given frequency with the on-board potentiometer at R15. The ADP7104 regulator input is supplied from a standard 9 V battery.

Figure 3 shows the measurements carried out according to the EN55032 Class B standard in a semianechoic chamber at 10 m from 30 MHz to 1 GHz. Figure 3 shows the results of the peak horizontal scan (the worst case), and Figure 4 shows the results of the peak vertical scan. Table 2 shows the tabulated quasi peak (QP) results. These results demonstrate that the ADM3055E has a greater than 6.0 dB margin below EN55032 Class B limits on a 2-layer PCB with the use of ferrite beads.

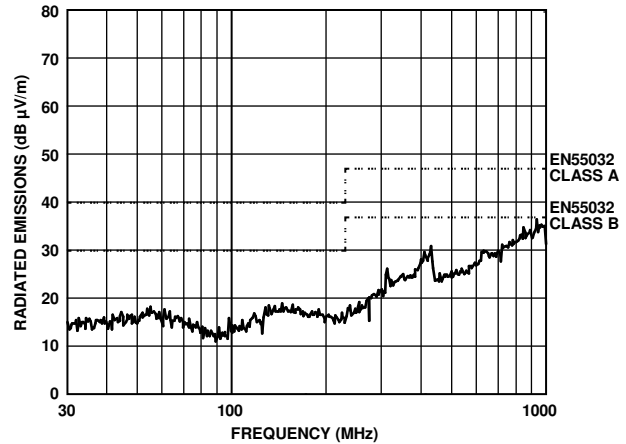

Figure 3. Peak Horizontal Scan from 30 MHz to 1 GHz with 5 Mbps Signal to TXD with 60 Ω Termination

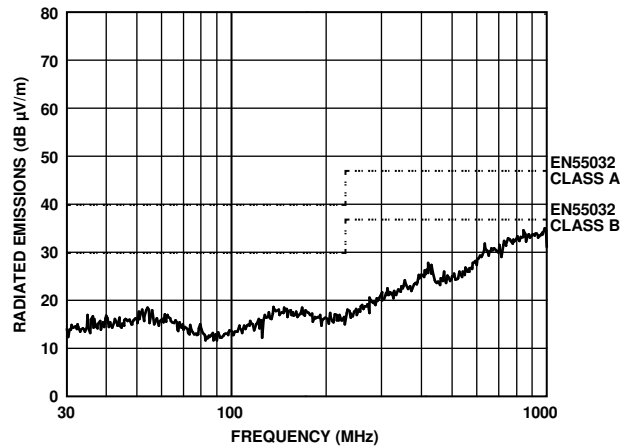

Figure 4. Peak Vertical Scan from 30 MHz to 1 GHz with 5 Mbps Signal to TXD with 60 Ω Termination

Table 2. EVAL-ADM3055EEBZ Test Results (QP Measurements)

TXD Data Rate (Mbps)	Frequency (MHz)	QP Level (dB μ V/m)	Limit EN55032 Class B (dB μ V/m)	QP Margin from Limit EN55032 Class B (dB μ V/m)	Antenna Position	Antenna Height (m)	Pass/Fail
5	313.375	23.5	37	-13.5	Horizontal	3	Pass
5	410.541	28.5	37	-8.5	Horizontal	1.8	Pass
5	428.412	26.7	37	-10.3	Horizontal	2.2	Pass
5	431.666	27.7	37	-9.3	Horizontal	2	Pass
5	849.536	28.8	37	-8.2	Horizontal	1	Pass
5	934.5	29.5	37	-7.5	Horizontal	1	Pass

EVALUATION BOARD SCHEMATIC AND ARTWORK

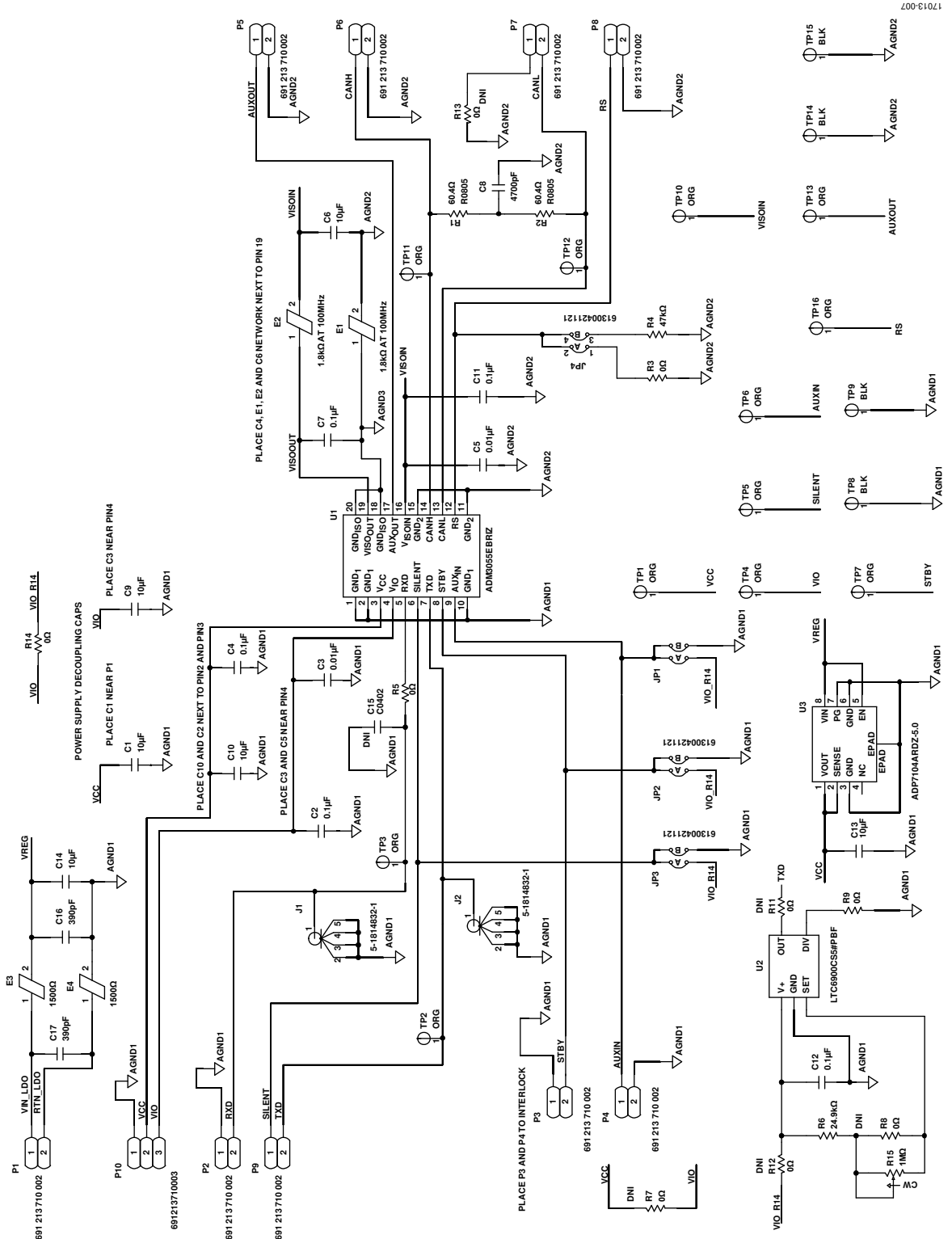

Figure 5. EVAL-ADM3055EBZ Schematic

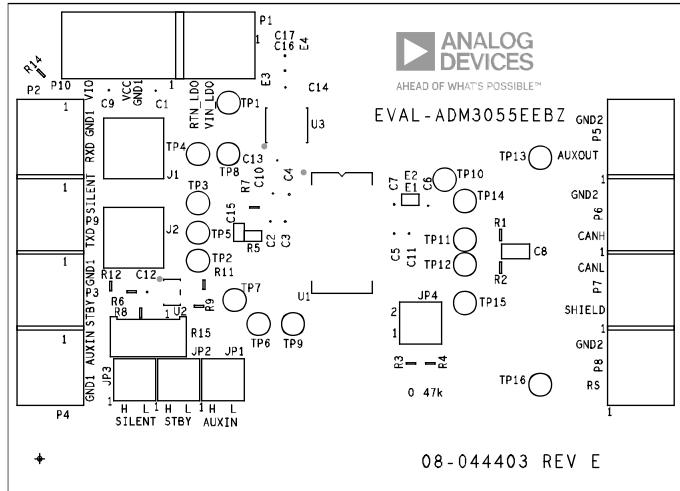

Figure 6. EVAL-ADM3055EBZ Primary Silkscreen

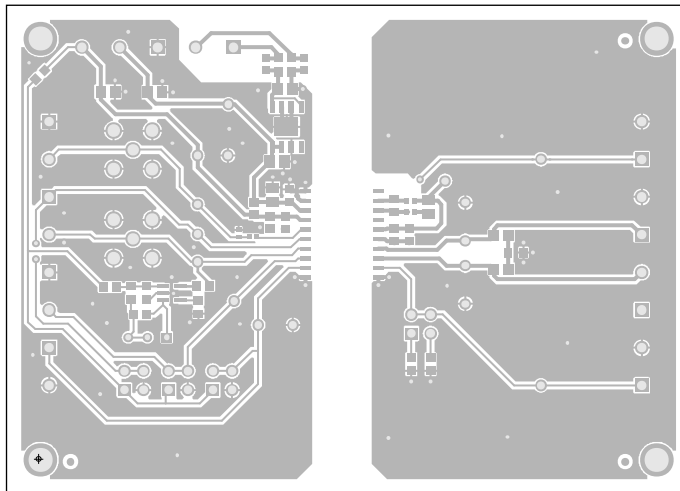

Figure 7. EVAL-ADM3055EBZ Top Layer

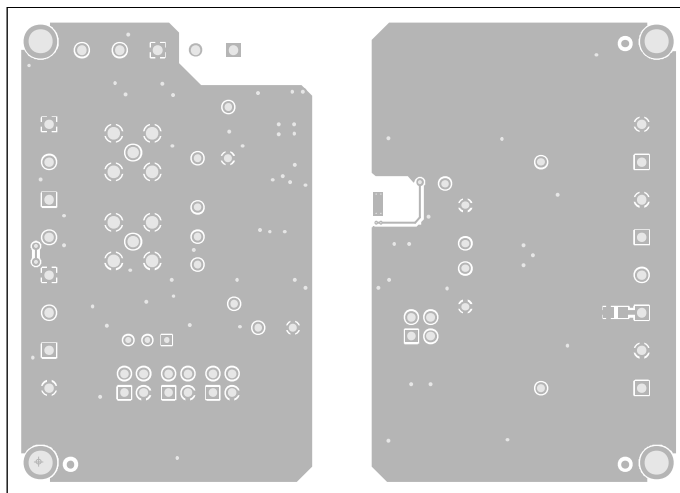

Figure 8. EVAL-ADM3055EBZ Bottom Layer

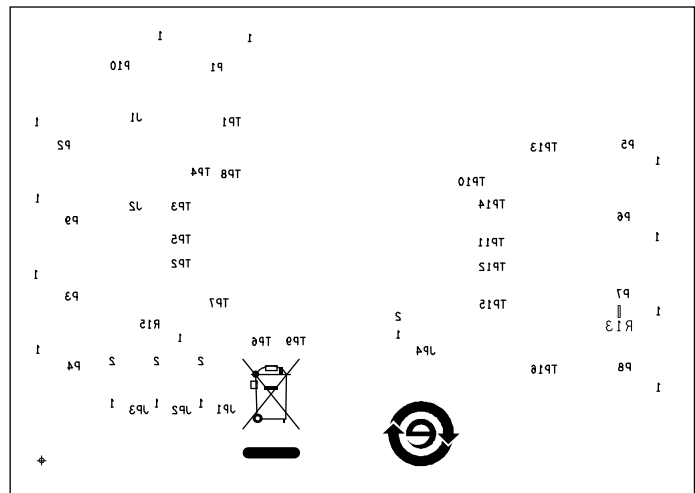

Figure 9. EVAL-ADM3055EEBZ Bottom Silkscreen

17019-011

ORDERING INFORMATION

BILL OF MATERIALS

Table 3.

Name	Description	Supplier	Part No.
U1	5 kV rms signal and power isolated CAN FD transceiver	Analog Devices	ADM3055EBRIZ
U2	Low power, 1 kHz to 20 MHz resistor set SOT-23 oscillator	Analog Devices	LTC6900CS5#PBF
U3	20 V, 500 mA, low noise, complimentary metal-oxide semiconductor (CMOS) LDO	Analog Devices	ADP7104ARDZ-5.0
C1, C6, C9, C10, C13, C14	Capacitors, 10 μ F, X7R, 0805	Würth Elektronik	885012207026
C2, C4, C7, C11, C12	Capacitors, 0.1 μ F, X7R, 0603	Würth Elektronik	885012206046
C16, C17	Capacitors, 390 pF, X7R, 0603	AVX	0603YC391KAT2A
C3, C5	Capacitors, 0.01 μ F, X7R, 0603	Würth Elektronik	885012206014
C8	Capacitor, 4.7 nF, X7R, 0805	Würth Elektronik	885012207090
E1, E2	Ferrite beads, 1.8 k Ω at 100 MHz, 0402	Taiyo Yuden	BKH1005LM182-T
E3, E4	Ferrite beads, 1500 Ω , 0603	Murata	BLM18HE152SN1D
J1, J2	Connectors, Subminiature, Version A (SMA)	TE Connectivity	5-1814832-1
JP1, JP2, JP3, JP4	100 mil (2.54 mm) connectors, PCB, HDR	Würth Elektronik	61300421121
Not applicable	100 mil (2.54 mm) jumper	FCI	65474-001LF
P1, P2, P3, P4, P5, P6, P7, P8, P9	Connectors, 2-position screw terminal block	Würth Elektronik	691 213 710 002
P10	Connector, 3-position screw terminal block	Würth Elektronik	691213710003
R1, R2	Resistors, 60.4 Ω , 1/8 W, 0805	Panasonic	ERJ-6ENF60R4V
R3, R9, R14	Resistors, 0 Ω , 1/10 W, 0603	Panasonic	ERJ-3GEY0R00V
R15	Potentiometer, 1 M Ω	Bourns	3296W-1-105LF
R4	Resistor, 47 k Ω , 1/4 W, 0603	Panasonic	ERJ-PA3F4702V
R5	Resistor, 0 Ω , 1/10 W, 0402	Panasonic	ERJ-2GE0R00X
R6	Resistor, 24.9 k Ω , 1/10 W, 0603	Panasonic	ERA-3AEB2492V
TP1, TP2, TP3, TP4, TP5, TP6, TP7, TP10, TP11, TP12, TP13, TP16	Orange test points	Keystone	5003
TP8, TP9, TP14, TP15	Black test points	Vero	20-2137
C15	Capacitor, 1 pF, 0402 (not installed)	AVX	04023A1R0BAT2A
R7, R8, R11, R12	Resistors, 0 Ω , 1/10 W, 0603 (not installed)	Panasonic	ERJ-3GEY0R00V
R13	Resistor, 0 Ω , 1/8 W, 0805 (not installed)	Panasonic	ERJ-6GEY0R00V

RELATED LINKS

Resource	Description
ADM3055E	5 kV rms, signal and power isolated, CAN transceiver for CAN FD
AN-1123	Controller area network (CAN) implementation guide
AN-1349	PCB implementation guidelines to minimize radiated emissions on the ADM2582E/ADM2587E RS-485/RS-422 transceivers
AN-0971	Recommendations for control of radiated emissions with <i>isoPower</i> devices

NOTES



ESD Caution

ESD (electrostatic discharge) sensitive device. Charged devices and circuit boards can discharge without detection. Although this product features patented or proprietary protection circuitry, damage may occur on devices subjected to high energy ESD. Therefore, proper ESD precautions should be taken to avoid performance degradation or loss of functionality.

Legal Terms and Conditions

By using the evaluation board discussed herein (together with any tools, components documentation or support materials, the "Evaluation Board"), you are agreeing to be bound by the terms and conditions set forth below ("Agreement") unless you have purchased the Evaluation Board, in which case the Analog Devices Standard Terms and Conditions of Sale shall govern. Do not use the Evaluation Board until you have read and agreed to the Agreement. Your use of the Evaluation Board shall signify your acceptance of the Agreement. This Agreement is made by and between you ("Customer") and Analog Devices, Inc. ("ADI"), with its principal place of business at One Technology Way, Norwood, MA 02062, USA. Subject to the terms and conditions of the Agreement, ADI hereby grants to Customer a free, limited, personal, temporary, non-exclusive, non-sublicensable, non-transferable license to use the Evaluation Board FOR EVALUATION PURPOSES ONLY. Customer understands and agrees that the Evaluation Board is provided for the sole and exclusive purpose referenced above, and agrees not to use the Evaluation Board for any other purpose. Furthermore, the license granted is expressly made subject to the following additional limitations: Customer shall not (i) rent, lease, display, sell, transfer, assign, sublicense, or distribute the Evaluation Board; and (ii) permit any Third Party to access the Evaluation Board. As used herein, the term "Third Party" includes any entity other than ADI, Customer, their employees, affiliates and in-house consultants. The Evaluation Board is NOT sold to Customer; all rights not expressly granted herein, including ownership of the Evaluation Board, are reserved by ADI. CONFIDENTIALITY. This Agreement and the Evaluation Board shall all be considered the confidential and proprietary information of ADI. Customer may not disclose or transfer any portion of the Evaluation Board to any other party for any reason. Upon discontinuation of use of the Evaluation Board or termination of this Agreement, Customer agrees to promptly return the Evaluation Board to ADI. ADDITIONAL RESTRICTIONS. Customer may not disassemble, decompile or reverse engineer chips on the Evaluation Board. Customer shall inform ADI of any occurred damages or any modifications or alterations it makes to the Evaluation Board, including but not limited to soldering or any other activity that affects the material content of the Evaluation Board. Modifications to the Evaluation Board must comply with applicable law, including but not limited to the RoHS Directive. TERMINATION. ADI may terminate this Agreement at any time upon giving written notice to Customer. Customer agrees to return to ADI the Evaluation Board at that time. LIMITATION OF LIABILITY. THE EVALUATION BOARD PROVIDED HEREUNDER IS PROVIDED "AS IS" AND ADI MAKES NO WARRANTIES OR REPRESENTATIONS OF ANY KIND WITH RESPECT TO IT. ADI SPECIFICALLY DISCLAIMS ANY REPRESENTATIONS, ENDORSEMENTS, GUARANTEES, OR WARRANTIES, EXPRESS OR IMPLIED, RELATED TO THE EVALUATION BOARD INCLUDING, BUT NOT LIMITED TO, THE IMPLIED WARRANTY OF MERCHANTABILITY, TITLE, FITNESS FOR A PARTICULAR PURPOSE OR NON-INFRINGEMENT OF INTELLECTUAL PROPERTY RIGHTS. IN NO EVENT WILL ADI AND ITS LICENSORS BE LIABLE FOR ANY INCIDENTAL, SPECIAL, INDIRECT, OR CONSEQUENTIAL DAMAGES RESULTING FROM CUSTOMER'S POSSESSION OR USE OF THE EVALUATION BOARD, INCLUDING BUT NOT LIMITED TO LOST PROFITS, DELAY COSTS, LABOR COSTS OR LOSS OF GOODWILL. ADI'S TOTAL LIABILITY FROM ANY AND ALL CAUSES SHALL BE LIMITED TO THE AMOUNT OF ONE HUNDRED US DOLLARS (\$100.00). EXPORT. Customer agrees that it will not directly or indirectly export the Evaluation Board to another country, and that it will comply with all applicable United States federal laws and regulations relating to exports. GOVERNING LAW. This Agreement shall be governed by and construed in accordance with the substantive laws of the Commonwealth of Massachusetts (excluding conflict of law rules). Any legal action regarding this Agreement will be heard in the state or federal courts having jurisdiction in Suffolk County, Massachusetts, and Customer hereby submits to the personal jurisdiction and venue of such courts. The United Nations Convention on Contracts for the International Sale of Goods shall not apply to this Agreement and is expressly disclaimed.

©2018 Analog Devices, Inc. All rights reserved. Trademarks and registered trademarks are the property of their respective owners.
UG17013-0-11/18(A)



www.analog.com