

Tous droits strictement reserves. Reproduction ou communication a des tiers interdite sous quelque forme que ce soit sans autorisation écrite du Propriete de c FCI. Droits de reproduction FCI.

All rights strictly reserved. Reproduction or issue to third parties in any form whatever is not permitted without written authority from the proprietor. Property of FCI. Copyright FCI.

PRODUCT NO.
68794

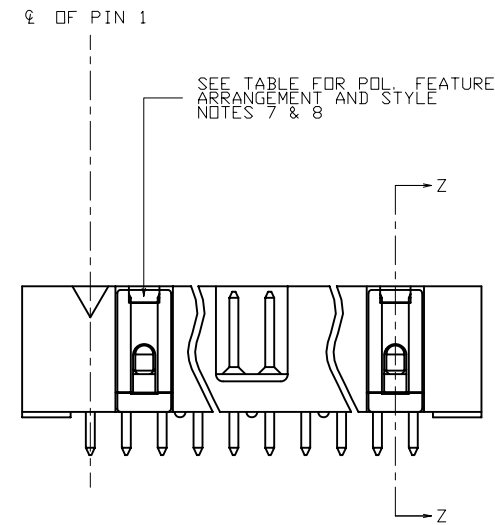
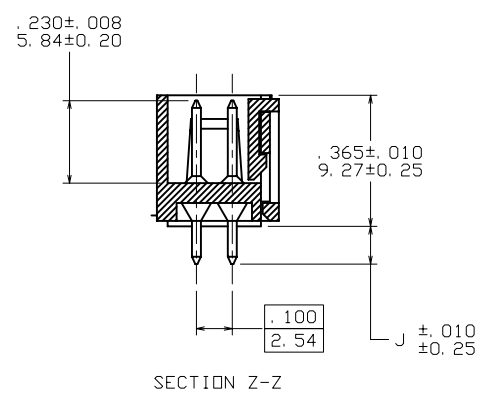
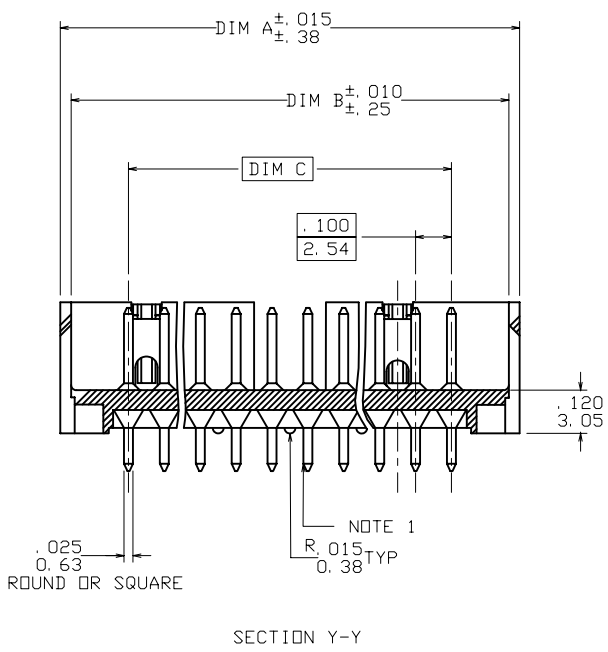
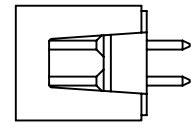
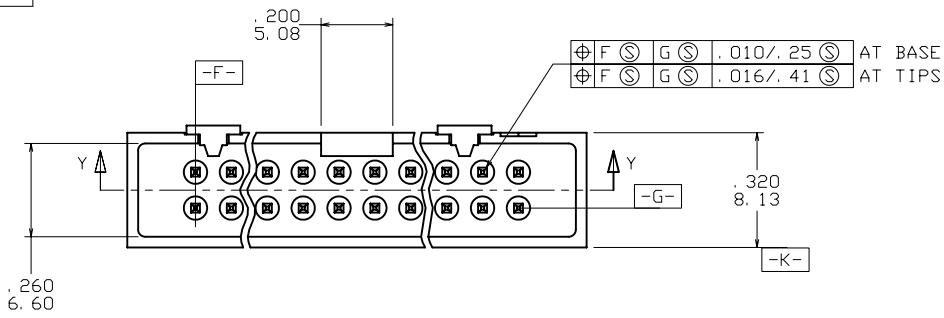

mat'l. code		tolerances unless otherwise specified		CUSTOMER COPY		 www.fciconnect.com		
ltr	ecn no	dr	date	linear	.X ± 0.3	projection	 title HEADER QUICKIE SLIM LINE VERTICAL 4 WALLED	
E	N05-015	ZC	6/10/05		.XX ± 0.13			
					.XXX ± 0.05			
				angles	±	INCH/MM scale 1:1 A3	product family	
				dr	J.W. BAIR		8/1/90	QUICKIE
				enr	M.SMYK		8/1/90	code
				chr	M.SMYK		8/1/90	size
				appd	M.SMYK		8/1/90	dwg no
sheet index	revision sheet						68794	sheet 1 of 8

Tous droits strictement reserves. Reproduction ou communication a des tiers interdite sous quelque forme que ce soit sans autorisation écrite du Propriete de c FCI. Droits de reproduction FCI.



All rights strictly reserved. Reproduction or issue to third parties in any form whatever is not permitted without written authority from the proprietor. Property of FCI. Copyright FCI.

PRODUCT NO.

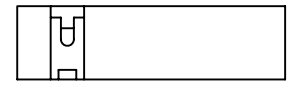

2 X 5
STYLE B

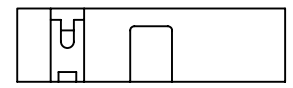

2 X 7
STYLE C

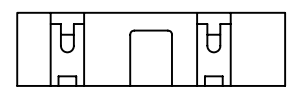

2 X 8 THUR 2 X 30
STYLE D

NOTES:



- ① SAME PIN POSITION TOLERANCE APPLIES TO BOTH ENDS OF EACH TERMINAL.
- ② MOLDING MATERIAL: 30% GLASS-FILLED POLYESTER, FLAME RETARDANT PER UL-94-V0 COLOR: BLUE.
- 3. 1° MAX DRAFT PERMISSIBLE ON ALL SURFACES.
- 4. 4 POUNDS / 1.8 KILOGRAMS MIN. TERMINAL PULL-OUT FORCE.
- 5. TERMINAL MATERIAL: 3/4 HARD PHOSPHORUS BRONZE.
- 6. POLARIZING KEYS INSTALLED IN HEADERS.
- ⑦ THIS PRODUCT IS MADE FROM HEADER NO. 66506 AND POLARIZING KEY NO. 66423.
- ⑧ MOLDED-IN KEYS ARE MANUFACTURER'S OPTION.
- 9. 68794-***LF IS JUST A LEAD FREE PRODUCT.
- 10. THE HOUSING OF XXXXX-XYLF WILL WITHSTAND EXPOSURE TO 260°C PEAK TEMPERATURE FOR 10 SECONDS IN A WAVE SOLDER PROCESS.

mat'l. code				tolerances unless otherwise specified			CUSTOMER COPY		 www.fciconnect.com			
ltr	ecn no	dr	date	linear	.x ± 0.3		projection	title				
E					.xx ± 0.13					HEADER QUICKIE SLIM LINE		
				angles	.xxx ± 0.05			product family QUICKIE		code		
					±					size		sheet
				dr	J.W. BAIR	8/1/90	scale 1:1	A3	68794		2 of 8	
				enr	M.SMYK	8/1/90			sheet			
				chr	M.SMYK	8/1/90			dwg no			
				appd	M.SMYK	8/1/90						
sheet	revision											
index	sheet											

Tous droits strictement reserves. Reproduction ou communication a des tiers interdite sous quelque forme que ce soit sans autorisation écrite du Propriete de c FCI. Droits de reproduction FCI.

All rights strictly reserved. Reproduction or issue to third parties in any form whatever is not permitted without written authority from the proprietor. Property of FCI. Copyright FCI.

	SIZE	STYLE	DIM A	DIM B	DIM C	DIM J	TERMINAL PLATING	TERM TYPE	CUSTOMER RESTRICTED
68794-001(LF)							UNASSIGNED		
-002(LF)							UNASSIGNED		
-003(LF)							UNASSIGNED		
-004(LF)							UNASSIGNED		
-005(LF)							UNASSIGNED		
-006(LF)							UNASSIGNED		
-007(LF)	2 x 10	D	1.28/32.5	1.22/31.0	.900/22.86	.105/2.67	30u"/.76u Au OVER 50u"/1.27u Ni	ROUND	NO
-008(LF)	2 x 10		1.28/32.5	1.22/31.0	.900/22.86	.150/3.81	30u"/.76u Au OVER 50u"/1.27u Ni	ROUND	
-009(LF)	2 x 10		1.28/32.5	1.22/31.0	.900/22.86	.675/17.15	30u"/.76u Au OVER 50u"/1.27u Ni	SQ	
-010(LF)	2 x 10		1.28/32.5	1.22/31.0	.900/22.86	.105/2.67	150u"/3.81u Sn	SQ	
-011(LF)	2 x 10		1.28/32.5	1.22/31.0	.900/22.86	.150/3.81	150u"/3.81u Sn	SQ	
-012(LF)	2 x 10		1.28/32.5	1.22/31.0	.900/22.86	.675/17.15	150u"/3.81u Sn	SQ	
-013(LF)	2 x 13		1.58/40.1	1.52/38.6	1.200/30.48	.105/2.67	30u"/.76u Au OVER 50u"/1.27u Ni	ROUND	
-014(LF)	2 x 13		1.58/40.1	1.52/38.6	1.200/30.48	.150/3.81	30u"/.76u Au OVER 50u"/1.27u Ni	ROUND	
-015(LF)	2 x 13		1.58/40.1	1.52/38.6	1.200/30.48	.675/17.15	30u"/.76u Au OVER 50u"/1.27u Ni	SQ	
-016(LF)	2 x 13		1.58/40.1	1.52/38.6	1.200/30.48	.105/2.67	150u"/3.81u Sn	SQ	
-017(LF)	2 x 13		1.58/40.1	1.52/38.6	1.200/30.48	.150/3.81	150u"/3.81u Sn	SQ	
-018(LF)	2 x 13		1.58/40.1	1.52/38.6	1.200/30.48	.675/17.15	150u"/3.81u Sn		
-019(LF)	2 x 17		1.98/50.3	1.92/48.8	1.600/40.64	.105/2.67	30u"/.76u Au OVER 50u"/1.27u Ni	ROUND	
-020(LF)	2 x 17		1.98/50.3	1.92/48.8	1.600/40.64	.150/3.81	30u"/.76u Au OVER 50u"/1.27u Ni	ROUND	
-021(LF)	2 x 17		1.98/50.3	1.92/48.8	1.600/40.64	.675/17.15	30u"/.76u Au OVER 50u"/1.27u Ni	SQ	
-022(LF)	2 x 17		1.98/50.3	1.92/48.8	1.600/40.64	.105/2.67	150u"/3.81u Sn	SQ	
-023(LF)	2 x 17		1.98/50.3	1.92/48.8	1.600/40.64	.150/3.81	150u"/3.81u Sn	SQ	
-024(LF)	2 x 17		1.98/50.3	1.92/48.8	1.600/40.64	.675/17.15	150u"/3.81u Sn	SQ	
-025(LF)	2 x 20		2.28/57.9	2.22/56.4	1.900/48.26	.105/2.67	30u"/.76u Au OVER 50u"/1.27u Ni	ROUND	
-026(LF)	2 x 20		2.28/57.9	2.22/56.4	1.900/48.26	.150/3.81	30u"/.76u Au OVER 50u"/1.27u Ni	ROUND	
-027(LF)	2 x 20		2.28/57.9	2.22/56.4	1.900/48.26	.675/17.15	30u"/.76u Au OVER 50u"/1.27u Ni	SQ	
-028(LF)	2 x 20		2.28/57.9	2.22/56.4	1.900/48.26	.105/2.67	150u"/3.81u Sn	SQ	
-029(LF)	2 x 20		2.28/57.9	2.22/56.4	1.900/48.26	.150/3.81	150u"/3.81u Sn	SQ	
-030(LF)	2 x 20		2.28/57.9	2.22/56.4	1.900/48.26	.675/17.15	150u"/3.81u Sn	SQ	
-031(LF)	2 x 25		2.78/70.6	2.72/69.1	2.400/60.96	.105/2.67	30u"/.76u Au OVER 50u"/1.27u Ni	ROUND	
-032(LF)	2 x 25		2.78/70.6	2.72/69.1	2.400/60.96	.150/3.81	30u"/.76u Au OVER 50u"/1.27u Ni	ROUND	
-033(LF)	2 x 25		2.78/70.6	2.72/69.1	2.400/60.96	.675/17.15	30u"/.76u Au OVER 50u"/1.27u Ni	SQ	
-034(LF)	2 x 25		2.78/70.6	2.72/69.1	2.400/60.96	.105/2.67	150u"/3.81u Sn	SQ	
66506-035(LF)	2 x 25	D	2.78/70.6	2.72/69.1	2.400/60.96	.150/3.81	150u"/3.81u Sn	SQ	NO



mat'l. code		tolerances unless otherwise specified		CUSTOMER COPY		 www.fciconnect.com	
ltr	ecr no	dr	date	linear	.X ± 0.3	projection	 title HEADER QUICKIE SLIM LINE VERTICAL 4 WALLED
E				angles	.XX ± 0.13	 product family QUICKIE code	
					.XXX ± 0.05		
				dr	J.W. BAIR 8/1/90	INCH/MM	dwg no
				enr	M.SMYK 8/1/90	← →	68794
				chr	M.SMYK 8/1/90	scale 1:1	sheet 3 of 8
				appd	M.SMYK 8/1/90	A3	
sheet index	revision						
	sheet						

Tous droits strictement reserves. Reproduction ou communication a des tiers interdite sous quelque forme que ce soit sans autorisation écrite du Propriete de c FCI. Droits de reproduction FCI.

FCI

All rights strictly reserved. Reproduction or issue to third parties in any form whatever is not permitted without written authority from the proprietor. Property of FCI. Copyright FCI.

	SIZE	STYLE	DIM A	DIM B	DIM C	DIM J	TERMINAL PLATING	TERM TYPE	CUSTOMER RESTRICTED
68794-036(LF)	2 X 25	D	2. 78/70. 6	2. 72/69. 1	2. 400/60. 96	. 675/17. 15	150u"/3. 81u TIN	SQUARE	NO
-037(LF)	2 X 7	C	. 98/24. 9	. 92/23. 4	. 600/15. 24	. 105/2. 67	30u' /0. 76U Au OVER 50u"/1. 27u Ni	ROUND	
-038(LF)	2 X 7					. 150/3. 81	30u' /0. 76U Au OVER 50u"/1. 27u Ni	ROUND	
-039(LF)	2 X 7					. 675/17. 15	30u' /0. 76U Au OVER 50u"/1. 27u Ni	SQUARE	
-040(LF)	2 X 7					. 105/2. 67	150u"/3. 81u TIN	SQUARE	
-041(LF)	2 X 7					. 150/3. 81	150u"/3. 81u TIN	SQUARE	
-042(LF)	2 X 7	C	. 98/24. 9	. 92/23. 4	. 600/15. 24	. 675/17. 15	150u"/3. 81u TIN	SQUARE	
-043(LF)	2 X 8	D	1. 08/27. 4	1. 02/25. 9	. 700/17. 78	. 105/2. 67	30u' /0. 76U Au OVER 50u"/1. 27u Ni	ROUND	
-044(LF)	2 X 8					. 150/3. 81	30u' /0. 76U Au OVER 50u"/1. 27u Ni	ROUND	
-045(LF)	2 X 8					. 675/17. 15	30u' /0. 76U Au OVER 50u"/1. 27u Ni	SQUARE	
-046(LF)	2 X 8					. 105/2. 67	150u"/3. 81u TIN	SQUARE	
-047(LF)	2 X 8					. 150/3. 81	150u"/3. 81u TIN	SQUARE	
-048(LF)	2 X 8	D	1. 08/27. 4	1. 02/25. 9	. 700/17. 78	. 675/17. 15	150u"/3. 81u TIN	SQUARE	NO
-049(LF)	U N A S S I G N E D								
-050(LF)	2 X 10	D	1. 28/32. 5	1. 22/31. 0	. 900/22. 86	. 150/3. 81	30u' / . 76u GXT WITH GOLD FLASH	ROUND	NO
-051(LF)	2 X 13	D	1. 58/40. 1	1. 52/38. 6	1. 200/30. 48				
-052(LF)	2 X 17	D	1. 98/50. 3	1. 92/48. 8	1. 600/40. 64				
-053(LF)	2 X 23	D	2. 28/57. 9	2. 22/56. 4	1. 900/48. 26				
-054(LF)	2 X 25	D	2. 78/70. 6	2. 72/69. 1	2. 400/60. 96				
-055(LF)	2 X 7	C	. 98/24. 9	. 92/23. 4	. 600/15. 24				
-056(LF)	2 X 8	D	1. 08/27. 4	1. 02/25. 9	. 700/17. 78	. 150/3. 81	30u' / . 76u GXT WITH GOLD FLASH		
-057(LF)	2 X 30		3. 28/83. 3	3. 22/81. 8	2. 900/73. 66	. 105/2. 67	30u' /0. 76U Au OVER 50u"/1. 27u Ni		
-058(LF)	2 X 30					. 150/3. 81	30u' /0. 76U Au OVER 50u"/1. 27u Ni	ROUND	
-059(LF)	2 X 30					. 675/17. 15	30u' /0. 76U Au OVER 50u"/1. 27u Ni	SQUARE	
-060(LF)	2 X 30					. 105/2. 67	150u"/3. 81u TIN	SQUARE	
-061(LF)	2 X 30					. 150/3. 81	150u"/3. 81u TIN	SQUARE	
-062(LF)	2 X 30					. 675/17. 15	150u"/3. 81u TIN	SQUARE	
-063(LF)	2 X 30					. 105/2. 67	30u' / . 76u GXT WITH GOLD FLASH	ROUND	
-064(LF)	2 X 30					. 150/3. 81	30u' / . 76u GXT WITH GOLD FLASH	ROUND	
-065(LF)	2 X 30	D	3. 28/83. 3	3. 22/81. 8	2. 900/73. 66	. 675/17. 15	30u' / . 76u GXT WITH GOLD FLASH	SQUARE	
-066(LF)	U N A S S I G N E D								
-067(LF)	U N A S S I G N E D								
-068(LF)	2 X 7	C	. 98/24. 9	. 92/23. 4	. 600/15. 24	. 105/2. 67	30u' / . 76u GXT WITH GOLD FLASH	ROUND	
-069(LF)	2 X 7	C	. 98/24. 9	. 92/23. 4	. 600/15. 24	. 675/17. 15	30u' / . 76u GXT WITH GOLD FLASH	SQUARE	
68794-070(LF)	2 X 8	D	1. 08/27. 4	1. 02/25. 9	. 700/17. 78	. 105/2. 67	30u' / . 76u GXT WITH GOLD FLASH	ROUND	NO



mat'l. code		tolerances unless otherwise specified		CUSTOMER COPY		 www.fciconnect.com	
ltr	ecn no	dr	date	linear	.X ± 0.3	projection	title
E					.XX ± 0.13		HEADER QUICKIE SLIM LINE VERTICAL 4 WALLED
				angles	.XXX ± 0.05		product family QUICKIE
				dr	J.W. BAIR 8/1/90	INCH/MM	code
				enr	M.SMYK 8/1/90	← →	size
				chr	M.SMYK 8/1/90	scale 1:1	dwg no
				appd	M.SMYK 8/1/90	A3	68794
sheet index	revision sheet						sheet 4 of 8

Tous droits strictement reserves. Reproduction ou communication a des tiers interdite sous quelque forme que ce soit sans autorisation ecrite du Propriete de c FCI. Droits de reproduction FCI.

FCI

All rights strictly reserved. Reproduction or issue to third parties in any form whatever is not permitted without written authority from the proprietor. Property of FCI. Copyright FCI.

	SIZE	STYLE	DIM A	DIM B	DIM C	DIM J	TERMINAL PLATING	TERM TYPE	CUSTOMER RESTRICTED
68794-071(LF)	2 X 8	D	1.08/27.4	1.02/25.9	.700/17.78	.675/17.15	30u"/O.76u GXT WITH GOLD FLASH	SQ	NO
-072(LF)	2 X 10		1.28/32.5	1.22/31.0	.900/22.86	.105/2.67		RD	
-073(LF)	2 X 10		1.28/32.5	1.22/31.0	.900/22.86	.675/17.15		SQ	
-074(LF)	2 X 13		1.58/40.1	1.52/38.6	1.200/30.48	.105/2.67		RD	
-075(LF)	2 X 13		1.58/40.1	1.52/38.6	1.200/30.48	.675/17.15		SQ	
-076(LF)	2 X 17		1.98/50.3	1.92/48.8	1.600/40.64	.105/2.67		RD	
-077(LF)	2 X 17		1.98/50.3	1.92/48.8	1.600/40.64	.675/17.15		SQ	
-078(LF)	2 X 20		2.28/57.9	2.22/56.4	1.900/48.26	.105/2.67		RD	
-079(LF)	2 X 20		2.28/57.9	2.22/56.4	1.900/48.26	.675/17.15		SQ	
-080(LF)	2 X 25		2.78/70.6	2.72/69.1	2.400/60.96	.105/2.67		RD	
-081(LF)	2 X 25	D	2.78/70.6	2.72/69.1	2.400/60.96	.675/17.15	30u"/O.76u GXT WITH GOLD FLASH	SQ	
-082(LF)	UNASSIGNED								
-083(LF)	UNASSIGNED								
-084(LF)	UNASSIGNED								
-085(LF)	2 X 7	C	.98/24.9	.92/23.4	.600/15.24	.105/2.67	15u"/.38u Au OVER 50u"/1.27u Ni	RD	
-086(LF)	2 X 7	C	.98/24.9	.92/23.4	.600/15.24	.150/3.81		RD	
-087(LF)	2 X 7	C	.98/24.9	.92/23.4	.600/15.24	.675/17.15		SQ	
-088(LF)	2 X 8	D	1.08/27.4	1.02/25.9	.700/17.78	.105/2.67		RD	
-089(LF)	2 X 8		1.08/27.4	1.02/25.9	.700/17.78	.150/3.81		RD	
-090(LF)	2 X 8		1.08/27.4	1.02/25.9	.700/17.78	.675/17.15		SQ	
-091(LF)	2 X 10		1.28/32.5	1.22/31.0	.900/22.86	.105/2.67		RD	
-092(LF)	2 X 10		1.28/32.5	1.22/31.0	.900/22.86	.150/3.81		RD	
-093(LF)	2 X 10		1.28/32.5	1.22/31.0	.900/22.86	.675/17.15		SQ	
-094(LF)	2 X 13		1.58/40.1	1.52/38.6	1.200/30.48	.105/2.67		RD	
-095(LF)	2 X 13		1.58/40.1	1.52/38.6	1.200/30.48	.150/3.81		RD	
-096(LF)	2 X 13		1.58/40.1	1.52/38.6	1.200/30.48	.675/17.15		SQ	
-097(LF)	2 X 17		1.98/50.3	1.92/48.8	1.600/40.64	.105/2.67		RD	
-098(LF)	2 X 17		1.98/50.3	1.92/48.8	1.600/40.64	.150/3.81		RD	
-099(LF)	2 X 17		1.98/50.3	1.92/48.8	1.600/40.64	.675/17.15		SQ	
-100(LF)	2 X 20		2.28/57.9	2.22/56.4	1.900/48.26	.105/2.67		RD	
-101(LF)	2 X 20		2.28/57.9	2.22/56.4	1.900/48.26	.150/3.81		RD	
-102(LF)	2 X 20		2.28/57.9	2.22/56.4	1.900/48.26	.675/17.15		SQ	
-103(LF)	2 X 25		2.78/70.6	2.72/69.1	2.400/60.96	.105/2.67		RD	
-104(LF)	2 X 25		2.78/70.6	2.72/69.1	2.400/60.96	.150/3.81		RD	
68794-105(LF)	2 X 25	D	2.78/70.6	2.72/69.1	2.400/60.96	.675/17.15	15u"/.38u Au OVER 50u"/1.27u Ni	SQ	NO



mat'l. code		tolerances unless otherwise specified		CUSTOMER COPY		 www.fciconnect.com	
ltr	ecn no	dr	date	linear	.X ± 0.3	projection	
E					.xx ± 0.13		
					.xxx ± 0.05		
				angles	±		
				dr	J.W. BAIR	8/1/90	INCH/MM
				engr	M.SMYK	8/1/90	
				chr	M.SMYK	8/1/90	
				appd	M.SMYK	8/1/90	
sheet	revision						scale 1:1
index	sheet						
				product family QUICKIE		code	
				size dwg no		sheet	
				A3		5 of 8	
				68794			

Tous droits strictement reserves. Reproduction ou communication a des tiers interdite sous quelque forme que ce soit sans autorisation écrite du Propriete de c FCI. Droits de reproduction FCI.

FCI

All rights strictly reserved. Reproduction or issue to third parties in any form whatever is not permitted without written authority from the proprietor. Property of FCI. Copyright FCI.

PRODUCT NO.	SIZE	STYLE	DIM A	DIM B	DIM C	DIM J	TERMINAL PLATING	TERM TYPE	CUSTOMER RESTRICTED
68794-106(LF)	2 X 30	D	3.28/83.3	3.22/81.8	2.900/73.66	.105/2.67	15u/.38u Au OVER 50u*/1.27u Ni	ROUND	NO
-107(LF)	2 X 30	D	3.28/83.3	3.22/81.8	2.900/73.66	.150/3.81	15u/.38u Au OVER 50u*/1.27u Ni	ROUND	
-108(LF)	2 X 30	D	3.28/83.3	3.22/81.8	2.900/73.66	.675/17.15	15u/.38u Au OVER 50u*/1.27u Ni	SQ	
-109(LF)	2 X 5	B	.780/19.81	.72/18.3	.400/10.16	.105/2.67	30u*/.76u Au OVER 50u*/1.27u Ni	ROUND	
-110(LF)						.150/3.81	30u*/.76u Au OVER 50u*/1.27u Ni	ROUND	
-111(LF)						.675/17.15	30u*/.76u Au OVER 50u*/1.27u Ni	SQ	
-112(LF)						.105/2.67	150u*/3.81u Sn	SQ	
-113(LF)						.150/3.81	150u*/3.81u Sn	SQ	
-114(LF)						.675/17.15	150u*/3.81u Sn	SQ	
-115(LF)						.105/2.67	15u*/.38u Au OVER 50u*/1.27u Ni	ROUND	
-116(LF)						.150/3.81	15u*/.38u Au OVER 50u*/1.27u Ni	ROUND	
-117(LF)						.675/17.15	15u*/.38u Au OVER 50u*/1.27u Ni	SQ	
-118(LF)						.105/2.67	30u*/.76u GXT WITH GOLD FLASH	ROUND	
-119(LF)						.150/3.81	30u*/.76u GXT WITH GOLD FLASH	ROUND	
68794-120(LF)	2 x 5	B	.780/19.81	.72/18.3	.400/10.16	.675/17.15	30u*/.76u GXT WITH GOLD FLASH	SQ	NO
68794-121(LF)	D I S C O N T I N U E D								
THRU (LF)									
68794-216(LF)									
68794-217(LF)	2 x 12	D	1.48/38.0	1.42/36.1	1.100/27.94	.105/2.67	15u/.38u Au OVER 50u*/1.27u Ni	ROUND	NO
-218(LF)						.105/2.67	30u*/.76u Au OVER 50u*/1.27u Ni	ROUND	
-219(LF)						.105/2.67	30u*/.76u GXT WITH GOLD FLASH	ROUND	
-220(LF)						.105/2.67	150u*/3.81u Sn	SQ	
-221(LF)						.150/3.81	15u/.38u Au OVER 50u*/1.27u Ni	ROUND	
-222(LF)						.150/3.81	30u*/.76u Au OVER 50u*/1.27u Ni	ROUND	
-223(LF)						.150/3.81	30u*/.76u GXT WITH GOLD FLASH	ROUND	
-224(LF)						.150/3.81	150u*/3.81u Sn	SQ	
-225(LF)						.675/17.15	15u/.38u Au OVER 50u*/1.27u Ni	SQ	
-226(LF)						.675/17.15	30u*/.76u Au OVER 50u*/1.27u Ni	SQ	
-227(LF)						.675/17.15	30u*/.76u GXT WITH GOLD FLASH	SQ	
-228(LF)	2 x 12		1.48/38.0	1.42/36.1	1.100/27.94	.675/17.15	150u*/3.81u Sn	SQ	
-229(LF)	2 x 15		1.78/45.2	1.72/43.7	1.400/35.56	.105/2.67	15u/.38u Au OVER 50u*/1.27u Ni	ROUND	
-230(LF)						.105/2.67	30u*/.76u Au OVER 50u*/1.27u Ni	ROUND	
-231(LF)						.105/2.67	30u*/.76u GXT WITH GOLD FLASH	ROUND	
-232(LF)						.105/2.67	150u*/3.81u Sn	SQ	
68794-233(LF)	2 x 15	D	1.78/45.2	1.72/43.7	1.400/35.56	.150/3.81	15u/.38u Au OVER 50u*/1.27u Ni	ROUND	NO

mat'l. code		tolerances unless otherwise specified		CUSTOMER COPY		 www.fciconnect.com	
ltr	ecn no	dr	date	linear	.X ± 0.3	projection	 title HEADER QUICKIE SLIM LINE VERTICAL 4 WALLED
E					.XX ± 0.13	 INCH/MM ← →	
				angles	.XXX ± 0.05		
				dr	J.W. BAIR 8/1/90	scale 1:1	code
				enr	M.SMYK 8/1/90	A3	size
				chr	M.SMYK 8/1/90		dwg no
				appd	M.SMYK 8/1/90		68794
sheet index	revision sheet						sheet 6 of 8

Tous droits strictement reserves. Reproduction ou communication a des tiers interdite sous quelque forme que ce soit sans autorisation ecrite du proprietaire. Propriete de c FCI. Droits de reproduction FCI.

All rights strictly reserved. Reproduction or issue to third parties in any form whatever is not permitted without written authority from the proprietor. Property of FCI. Copyright FCI.

	POSITION	STYLE	DIM A	DIM B	DIM C	DIM J	TERMINAL PLATING	TERM TYPE	CUSTOMER RESTRICTED
68794-234(LF)	2 X 15	D	1.78/45.2	1.72/43.7	1.400/35.56	.150/3.81	30u"/.76u Au OVER 50u"/1/.27u Ni	ROUND	NO
-235(LF)						.150/3.81	30u"/.76u GXT WITH GOLD FLASH	ROUND	
-236(LF)						.150/3.81	150u"/3.81u Sn	SQ	
-237(LF)						.675/17.15	15u"/.38u Au OVER 50u"/1.27u Ni	SQ	
-238(LF)						.675/17.15	30u"/.76u Au OVER 50u"/1/.27u Ni	SQ	
-239(LF)						.675/17.15	30u"/.76u GXT WITH GOLD FLASH	SQ	
-240(LF)	2 X 15		1.78/45.2	1.72/43.7	1.400/35.56	.675/17.15	150u"/3.81u Sn	SQ	
-241(LF)	2 X 22		2.48/63.0	2.42/61.5	2.100/53.34	.105/2.67	15u"/.38u Au OVER 50u"/1.27u Ni	ROUND	
-242(LF)						.105/2.67	30u"/.76u Au OVER 50u"/1/.27u Ni	ROUND	
-243(LF)						.105/2.67	30u"/.76u GXT WITH GOLD FLASH	ROUND	
-244(LF)						.105/2.67	150u"/3.81u Sn	SQ	
-245(LF)						.150/3.81	15u"/.38u Au OVER 50u"/1.27u Ni	ROUND	
-246(LF)						.150/3.81	30u"/.76u Au OVER 50u"/1/.27u Ni	ROUND	
-247(LF)						.150/3.81	30u"/.76u GXT WITH GOLD FLASH	ROUND	
-248(LF)						.150/3.81	150u"/3.81u Sn	SQ	
-249(LF)						.675/17.15	15u"/.38u Au OVER 50u"/1.27u Ni	SQ	
-250(LF)						.675/17.15	30u"/.76u Au OVER 50u"/1/.27u Ni	SQ	
-251(LF)						.675/17.15	30u"/.76u GXT WITH GOLD FLASH	SQ	
-252(LF)	2 X 22	D	2.48/63.0	2.42/61.5	2.100/53.34	.675/17.15	150u"/3.81u Sn	SQ	
-253(LF)	2 X 17	A	1.98/50.3	1.92/48.8	1.600/40.64	.105/2.67	15u"/.38u Au OVER 50u"/1.27u Ni	SQ	NO
-254(LF)	U N A S S I G N E D								
-255(LF)	2 X 5	B	.78/19.8	.72/18.3	.400/10.16	.105/2.67	30u"/.76u Au OVER 50u"/1/.27u Ni	ROUND	YES
-256(LF)	2 X 7	C	.98/24.9	.92/23.4	.600/15.24				
-257(LF)	2 X 8	D	1.08/27.4	1.02/25.9	.700/17.78				
-258(LF)	2 X 10		1.28/32.5	1.22/31.0	.900/22.86				
-259(LF)	2 X 12		1.48/38.0	1.42/36.1	1.100/27.94				
-260(LF)	2 X 13		1.58/40.1	1.52/38.6	1.200/30.48				
-261(LF)	2 X 15		1.78/45.2	1.72/43.7	1.400/35.56				
-262(LF)	2 X 17		1.98/50.3	1.92/48.8	1.600/40.64				
-263(LF)	2 X 20		2.28/57.9	2.22/56.4	1.900/48.26				
-264(LF)	2 X 22		2.48/63.0	2.42/61.5	2.100/53.34				
-265(LF)	2 X 25		2.78/70.6	2.72/69.1	2.400/60.96				
-266(LF)	2 X 30	D	3.28/83.3	3.22/81.8	2.900/73.66	.105/2.67	30u"/.76u Au OVER 50u"/1/.27u Ni	ROUND	YES
-267(LF)	U N A S S I G N E D								
68794-268(LF)	2 X 5	B	.78/19.8	.72/18.3	.400/10.16	.105/2.67	30u"/.76u GXT WITH GOLD FLASH	ROUND	YES

mat'l. code		tolerances unless otherwise specified		CUSTOMER COPY		FCI <small>www.fciconnect.com</small>			
ltr	ecn no	dr	date	linear	.X ± 0.3	projection	title HEADER QUICKIE SLIM LINE VERTICAL 4 WALLED		
E					.XX ± 0.13				
					.XXX ± 0.05				
				angles	±		product family QUICKIE code		
				dr	J.W. BAIR 8/1/90			INCH/MM ← → scale 1:1 A3	size dwg no 68794
				enrg	M.SMYK 8/1/90				
				chr	M.SMYK 8/1/90				
				pppd	M.SMYK 8/1/90				
sheet index	revision sheet						sheet 7 of 8		

Tous droits strictement reserves. Reproduction ou communication a des tiers interdite sous quelque forme que ce soit sans autorisation ecrite du proprietaire. Propriete de c FCI. Droits de reproduction FCI.

All rights strictly reserved. Reproduction or issue to third parties in any form whatever is not permitted without written authority from the proprietor. Property of FCI. Copyright FCI.

1 | 2

3 |

4

	POSITION	STYLE	DIM A	DIM B	DIM C	DIM J	TERMINAL PLATING	TERM TYPE	CUSTOMER RESTRICTED
68794-269(LF)	2 X 7	C	. 98/24. 9	. 92/23. 4	. 600/15. 24	. 105/2. 67	30u" / . 76u GXT WITH GOLD FLASH	ROUND	YES
-270(LF)	2 X 8	D	1. 08/27. 4	1. 02/25. 9	. 700/17. 78				
-271(LF)	2 X 10		1. 28/32. 5	1. 22/31. 0	. 900/22. 86				
-272(LF)	2 X 12		1. 48/38. 0	1. 42/36. 1	1. 100/27. 94				
-273(LF)	2 X 13		1. 58/40. 1	1. 52/38. 6	1. 200/30. 48				
-274(LF)	2 X 15		1. 78/45. 2	1. 72/43. 7	1. 400/35. 56				
-275(LF)	2 X 17		1. 98/50. 3	1. 92/48. 8	1. 600/40. 64				
-276(LF)	2 X 20		2. 28/57. 9	2. 22/56. 4	1. 900/48. 26				
-277(LF)	2 X 22		2. 48/63. 0	2. 42/61. 5	2. 100/53. 34				
-278(LF)	2 X 25		2. 78/70. 6	2. 72/69. 1	2. 400/60. 96				
-279(LF)	2 X 30		3. 28/83. 3	3. 22/81. 8	2. 900/73. 66		30u" / . 76u GXT WITH GOLD FLASH	ROUND	YES
68794-280(LF)	2 X 10	D	1. 28/32. 5	1. 22/31. 0	. 900/22. 86	. 105/2. 67	150u" / 3. 81u Sn	SQUARE	NO

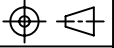
mat'l. code				tolerances unless otherwise specified				CUSTOMER COPY		 www.fciconnect.com	
ltr	ecn no	dr	date	linear	.XX±.01/.X±.3			projection	title		
E					.XXX±.005/.XX±.13				HEADER QUICKIE SLIM LINE		
					.XXX±.0020/.XXX±.051				VERTICAL 4 WALLED		
				angles	0°±2°			 INCH/MM	product family		code
				dr	J.W.BAIR	8/1/90	Quickie		-		
				enr	M.SMYK	8/1/90	size		-		
				chr	M.SMYK	8/1/90	dwg no		-		
				appd	M.SMYK	8/1/90	A		-		
sheet index		revision sheet		scale		5:1		A		8 of 8	

1 |

2 |

3 |

4

PDM: Rev:E

STATUS Released

Printed: Apr 12, 2011