

# TEWA TEMPERATURE SENSORS

HIGH PRECISION NTC THERMISTORS AND TEMPERATURE SENSORS

## Specification of Temperature Probe

PART NUMBER: **TT4-G10KC3-T180-OM52-500**

No. of pages: 1

Date: **19.09.2019**

Revision: **00**

FEATURES:

Sensing Element	Glass Thermistor NTC
No-load resistance at 25°C	10 000 Ω
Tolerances at 25°C	± 1%
Beta(25/85) Constant	3 977K ±1%
Operating temperature range	-40°C ÷ 180°C
<b>Test Voltage</b>	<b>500V DC</b>
<b>RoHS Compatible</b>	<b>YES</b>

DRAWING:

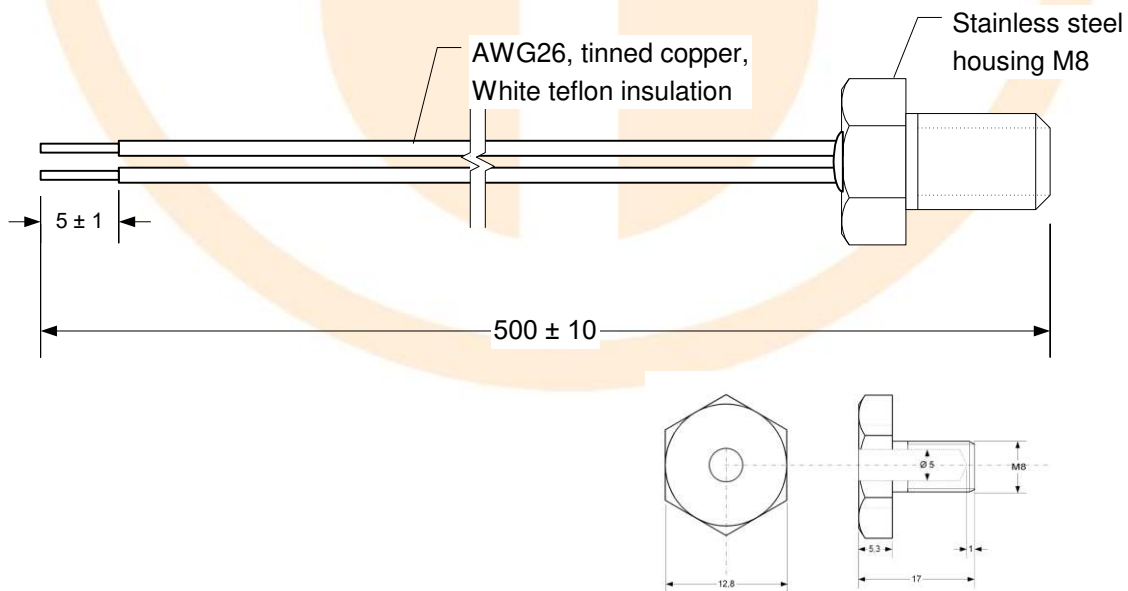

UNITS: [mm]