

SLI Liquid Flow Meter Series

Media Isolated Microfluidic Flow Meter

- Liquid flow rates up to 10 ml/min
- Non-invasive measurement
- Different interface options
- 40 ms flow detection response time



Product Summary

The SLI Liquid Flow Meter enables fast, non-invasive measurements of very low liquid flow in the $\mu\text{l}/\text{min}$ - to ml/min -range. Excellent chemical resistance is ensured: The flow path of the SLI Liquid Flow Meter is formed by a simple, straight glass capillary. The fourth generation MEMS sensors combine a thermal high precision sensor element with amplification circuits and digital intelligence for linearization and temperature compensation on one single microchip – the product's core element.

Interface Options

Digital

- I²C-Bus
- RS485-Bus
- USB Cable

Analog

- Voltage Output 0-10 V
- Current Output 4-20 mA (0-20 mA)
- Additional operation modes

For more information on communication, please refer to page 8 of this document.

Benefits of Sensirion's CMOSens® Technology

- High reliability and long-term stability
- Industry-proven technology with a track record of more than 15 years
- Designed for mass production
- Low signal noise

Content

SLI Liquid Flow Meter Series	1
1 Sensor Performance	3
2 Specifications	6
3 Sensor Output Signal Description	7
4 Communication Interface Description	8
5 Fluidic Specification and Connection	9
6 Mechanical Specifications	10
7 Ordering Information	11
8 CE, REACH, RoHS, and WEEE	12
9 Important Notices	13
10 Headquarters and Subsidiaries	14

1 Sensor Performance

Parameter	SLI-0430x	SLI-1000	SLI-2000	Unit
H ₂ O Full scale flow rate	80	1000	5000	µl/min
H ₂ O Sensor output limit ^a	120	1100	5500 ^b	µl/min
Accuracy below full scale (whichever error is larger)	5.0	5.0	5.0	% of m.v. ^c
	0.15	0.2	0.2	% of full scale
Repeatability below full scale (whichever error is larger)	0.5	0.5	0.5	% of m.v.
	0.01	0.02	0.02	% of full scale
Temperature coefficient (additional error / °C; whichever is larger)	0.13	0.1	0.1	% m.v. / °C
	0.003	0.004	0.004	% full scale / °C
Mounting orientation sensitivity ^d	<0.4	1.0	1.5	% of full scale
Response time on power-up	120			ms

Table 1: Model specific performance of SLI (all data for medium H₂O, 23°C)

Parameter	SLI-0430x	SLI-1000	SLI-2000	Unit
IPA full scale flow rate	500	10'000		µl/min
			80	ml/min
Sensor output limit ^a	600	11'000		µl/min
			90	ml/min
Accuracy below full scale (whichever error is larger)	20	20	10	% of m.v. ^c
	1	1	0.5	% of full scale
Repeatability below full scale (whichever error is larger)	1	1	1.5	% of m.v.
	0.05	0.05	0.03	% of full scale
Temperature coefficient (additional error / °C; whichever is larger)	0.5	0.4	0.35	% m.v. / °C
	0.025	0.02	0.02	% full scale / °C

Table 2: Model specific performance of SLI (all data for medium IPA, 23°C)

^a Flow rate at which the sensor output saturates. See section 1.1 for performance between full scale and saturation point

^b Extended range up to 10500 µl/min, see section 1.1 for performance specifications

^c Measured value

^d Maximum additional offset when mounted vertically

1.1 Specification Charts

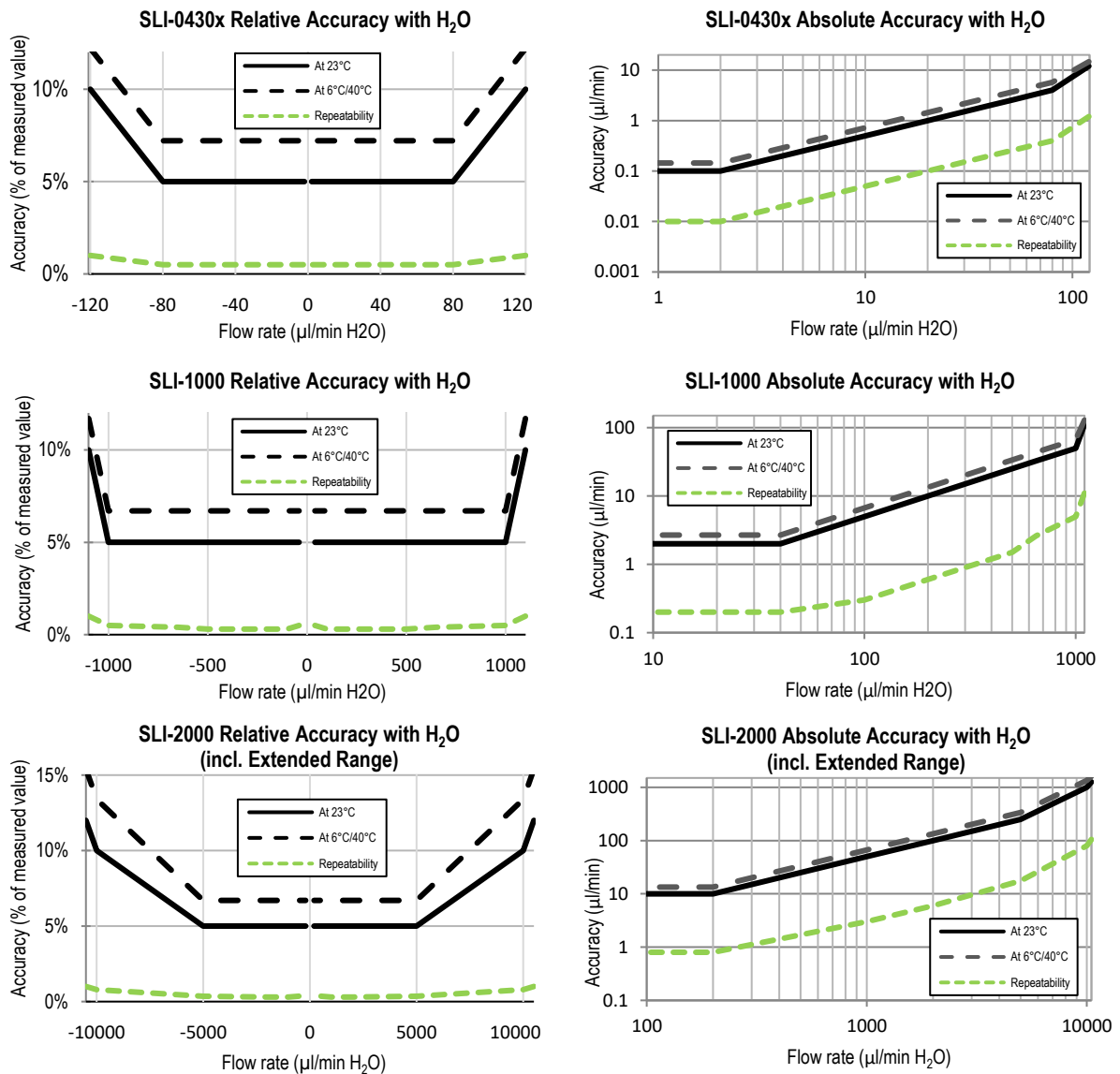

Figure 1: Flow meter accuracy and repeatability across the flow range. Relative error in % of measured value (left column) and absolute error in µl/min (right column) for H₂O

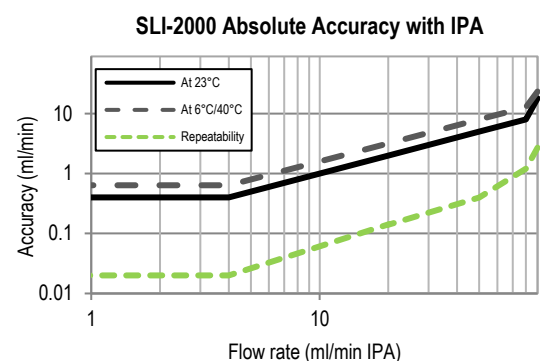
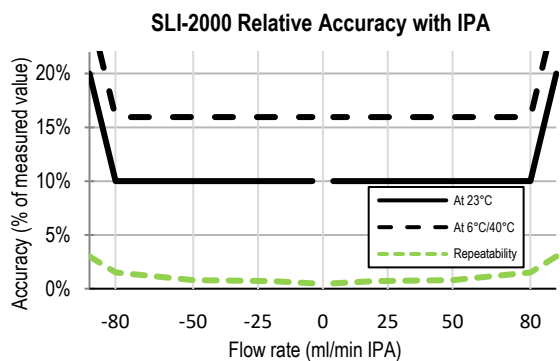
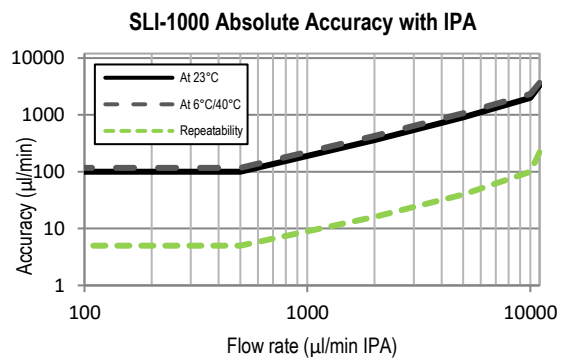
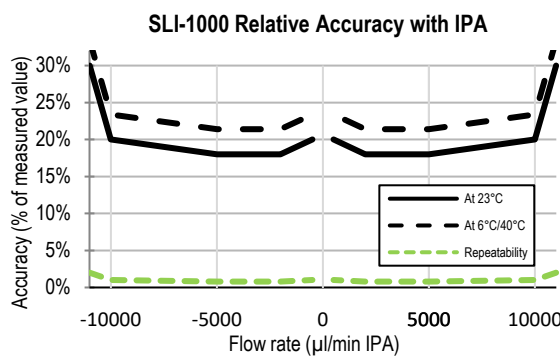
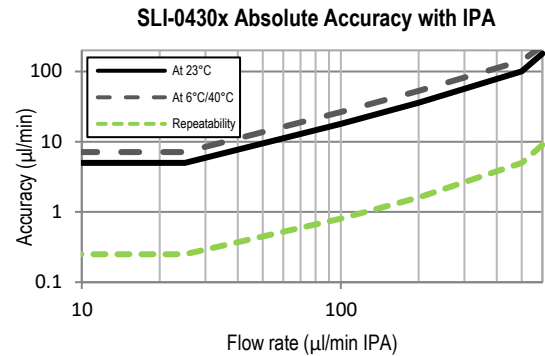
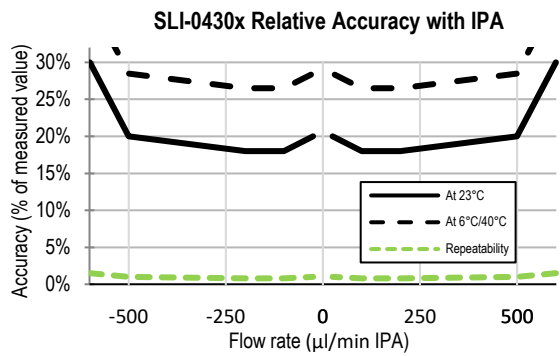

Figure 2: Flow meter accuracy and repeatability across the flow range. Relative error in % of measured value (left column) and absolute error in µl/min or ml/min in case of the SLI-2000 (right column) for IPA

2 Specifications

2.1 Electrical Specifications

This section describes the electrical specification when connecting directly to the sensor's M8 connector for I²C communication. The preferred mode of communication is via the SCC1 interface cables. See the respective SCC1 cable datasheets for further details.

Parameter	Symbol	Conditions	Min.	Typical	Max.	Units	Comments
Supply voltage DC	VDD		4	5	6	V	
Supply current	IDD	Measurement		6.8		mA	VDD = 5 V

Table 3: DC Characteristics

2.2 Timing Specifications

The SLI flow meter shows bidirectional, linear transfer characteristics. The product comes fully calibrated for water and IPA.

Parameter	Symbol	Min.	Typical	Max.	Units	Comments
Power-up time	t _{PU}			25	ms	Time to sensor ready
Flow detection response time			<50		ms	Response time to flow changes (τ_{63})
I ² C SCL frequency	f _{I2C}		100	400	kHz	
Readout frequency		12.5	200	1000	Hz	Depending on Resolution setting. Sampling time for 9 bit resolution: 1 ms, for 16 bit resolution: < 80 ms.

Table 4: Timing specifications

2.3 Absolute Minimum and Maximum Ratings

Parameter	Rating	Unit
Operating temperature	+10 ... +50	°C
Short term storage temperature ^e	-10 ... +60	°C
Operating humidity	0...95 %, non-condensing	% RH
Short term storage humidity ^e	0...95 %, non-condensing	% RH
Maximum supply voltage	12	V

Table 5: Absolute minimum and maximum ratings

2.4 Electrical Connector and Pinout

The flow meter is equipped with a male connector type M8, 4-pin, threaded lock according to IEC 61076-2-101 (Ed. 1)/ IEC 60947-5-2, and is compatible with Sensirion's SCC1 interface cables.

Pin	
1	SDA (data)
2	GND
3	VDD
4	SCL (clock)

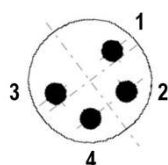

Table 6: Electrical pinout

^e Flow path empty. Short term storage refers to temporary conditions during e.g. transport.

3 Sensor Output Signal Description

3.1 Calibration Field Information

The SLI Liquid Flow Meters hold calibrations for two liquids, one for water (H₂O) and one for isopropyl alcohol (IPA). Each calibration is stored on a separate calibration field (CF):

- Calibration field 0: H₂O (factory default)
- Calibration field 1: IPA
- Calibration field 2 (SLI-2000 only, starting from SN 1627-00000): H₂O extended range

The default calibration field (i.e. the active calibration field at power up) can be permanently changed via I²C or RS485 commands. Alternatively, the default calibration field can be changed using the USB-RS485 Sensor Viewer which is part of the Liquid Flow Meter Kit and also available in the download center on the Sensirion liquid flow webpage.

www.sensirion.com/liquidflow-download

4 Communication Interface Description

The preferred mode of operation for the SLI flow meters is via the digital RS485, analog 0-10 V, or analog 4-20 mA SCC1 interface cables.

4.1 Digital Communication via RS485-Bus

The SCC1-RS485 Sensor Cable for flow sensors allows the communication via RS485 interface for use in a demanding industrial automation environment. In addition to the standard commands available in the I²C interface of the sensor, the incorporated microcontroller of the cable provides more complex logic such as a dispense volume totalizer, automatic dispense detection, automatic heater control and data buffer for asynchronous read-out.

For further information please see the SCC1-RS485 Sensor Cable datasheet, available on www.sensirion.com/liquidflow-download.

4.2 Analog 0-10 V Communication

The SCC1-ANALOG Sensor Cable allows simple and quick readout of Sensirion's liquid flow meters by converting the digital flow meter reading to an 0...10 V voltage output. The output scaling of the cable can be configured by the user and the cable additionally features a configurable digital (high/low) output with two different modes of operation (Flow Switch / Volume Counter).

For further information please see the SCC1-ANALOG Sensor Cable datasheet, available on www.sensirion.com/liquidflow-download.

4.3 Analog 4-20 mA (0-20 mA) Communication

The SCC1-CURRENT Sensor Cable converts the sensor's digital signal to a 4...20 mA (0...20 mA) current output. The output scaling and the additional digital (high/low) output of the cable can be configured in the same way as for the SCC1-ANALOG voltage output cable.

For further information please see the SCC1-CURRENT Sensor Cable datasheet, available on www.sensirion.com/liquidflow-download.

4.4 Communication via USB cable

The Sensirion USB Sensor Cable provides an easy to use USB Interface for laboratory and desktop use.

For further information please see the SCC1-USB Sensor Cable datasheet, available on www.sensirion.com/liquidflow-download.

4.5 Digital Communication via I²C Bus

The SLI liquid flow meters have been designed for use with the SCC1 interface cables. For special applications, direct communication with the flow meter via the standard I²C-interface is possible. The physical interface consists of two bus lines, a data line (SDA) and a clock line (SCL) which need to be connected via pull-up resistors to the bus voltage of the system.

These lines can be used on 3.3 V or 5 V levels with a recommended clock frequency of 100 kHz. For the detailed specifications of this I²C communication, please refer to specific I²C Application Notes from Sensirion.

5 Fluidic Specification and Connection

Parameter	SLI-0430C	SLI-0430	SLI-1000	SLI-2000
Fluid connection	UNF 6-40 for 1/32" OD tubing VICI® Nanovolume™ compatible	UNF ¼-28 flat-bottom for 1/16" or 1/8" OD plastic tubing		UNF ¼-28 flat-bottom for 1/8" OD plastic tubing ^f
Pressure drop (at full scale flow rate, H ₂ O, 23°C)	1 mbar		<1 mbar	<1 mbar
Pressure drop (at full scale flow rate, IPA, 23°C)	7 mbar		5 mbar	2 mbar
Total internal volume	5 µl		25 µl	80 µl

Table 7: Fluidic Specifications

For more information on the fluidic connection please find: "Application Note Sensor Ports and Tubing Connections" in the Download Center on our webpage (www.sensirion.com/liquidflow-download).

^f1/8" OD tubing with 2 mm minimum ID is recommended for the SLI-2000.

6 Mechanical Specifications

Parameter	SLI-0430x	SLI-1000	SLI-2000
Largest dimensions	58 x 42.5 x 20 mm		
Total mass	53 g		
Inner diameter d	430 µm	1.0 mm	1.8 mm
Protection class	IP 65		
Maximum recommended operating pressure	50 bar	15 bar	15 bar
Burst pressure	150 bar	30 bar	30 bar

Table 8: Mechanical specifications and pressure rating

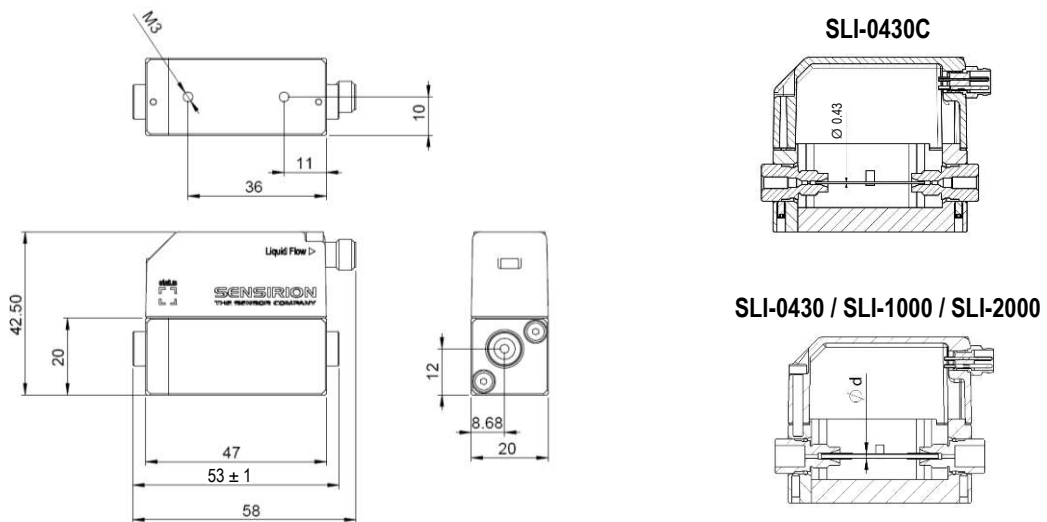

All dimensions in mm

6.1 Materials

Parameter	SLI-0430x	SLI-1000	SLI-2000
Wetted Materials:			
<ul style="list-style-type: none"> Internal sensor tube material 	Quartz Glass (Fused Silica)	Borosilicate Glass 3.3	
<ul style="list-style-type: none"> Fitting material 	PEEK		
<ul style="list-style-type: none"> Sealing material 	None	FEP	
Non-Wetted Materials:			
<ul style="list-style-type: none"> Housing 	ABS, Anodized Aluminum		
<ul style="list-style-type: none"> Screws and electrical connector 	Stainless Steel		

Table 8: Wetted and non-wetted materials

7 Ordering Information

For OEM applications, the liquid flow meter can be purchased in larger quantities without any additional parts. For optimum performance, Sensirion recommends using the SLI liquid flow meters in combination with the SCC1 interface cables.

For laboratory use and technology evaluation, the Liquid Flow Meter Kit SLI-XXXX can be ordered.

This laboratory-package contains:

- Liquid Flow Meter SLI-XXXX
- Basic set of fluidic connectors
- PC Software (Viewer & Data Export Tool)
- SCC1-USB 2m Sensor Cable with USB connector for plug-and-play connection to a PC
- SCC1-Analog 2m Sensor Cable with 0-10 V voltage output.

Product	Article Number
SLI-0430 Liquid Flow Meter	1-100836-02
SLI-0430C Liquid Flow Meter	3.000.332
SLI-1000 Liquid Flow Meter	1-100835-01
SLI-2000 Liquid Flow Meter	1-100895-01
Flow Meter Kit SLI-0430 ready to use	1-100893-01
Flow Meter Kit SLI-1000 ready to use	1-100879-01
Flow Meter Kit SLI-2000 ready to use	1-100894-01

Interface Cables:

SCC1-RS485 Sensor Cable 2m	1-100804-01
SCC1-RS485 Sensor Cable 5m	1-101122-01
SCC1-ANALOG 0-10V Sensor Cable 2m	1-101072-01
SCC1-ANALOG 0-10V Sensor Cable 10m	1-101219-01
SCC1-CURRENT 0-20mA Sensor Cable 5m	1-101667-01
SCC1-USB Sensor Cable 2m	1-101007-01

Table 9: Ordering information

8 CE, REACH, RoHS, and WEEE

The flow meters of the SLI series comply with requirements of the following directives and regulations:



- The device complies with norm EN 50081-2 (Emission Test Series), EN 50082-2 (Immunity Test Series) and ESD protection when used in combination with the SCC1-RS485, SCC1-ANALOG, or SCC1-CURRENT Sensor Cables.
- EU Directive 1907/2006/EC concerning Registration, Evaluation, Authorization and Restriction of Chemicals (**REACH**)
- EU Directive 2002/65/EC on the restriction of certain hazardous substances in electric and electronic equipment (**RoHS**), OJ01.01.2011
- EU Directive 2002/96/EC on waste electrical and electronic equipment (**WEEE**), OJ13.02.2003; esp. its Article 6 (1) with Annex II.

9 Important Notices

9.1 Warning, Personal Injury

Do not use this product as safety or emergency stop devices or in any other application where failure of the product could result in personal injury. Do not use this product for applications other than its intended and authorized use. Before installing, handling, using or servicing this product, please consult the data sheet and application notes. Failure to comply with these instructions could result in death or serious injury.

If the Buyer shall purchase or use SENSIRION products for any unintended or unauthorized application, Buyer shall defend, indemnify and hold harmless SENSIRION and its officers, employees, subsidiaries, affiliates and distributors against all claims, costs, damages and expenses, and reasonable attorney fees arising out of, directly or indirectly, any claim of personal injury or death associated with such unintended or unauthorized use, even if SENSIRION shall be alleged negligent with respect to the design or the manufacture of the product.

9.2 ESD Precautions

The inherent design of this component causes it to be sensitive to electrostatic discharge (ESD). To prevent ESD-induced damage and/or degradation, take customary and statutory ESD precautions when handling this product.

9.3 Warranty

SENSIRION warrants solely to the original purchaser of this product for a period of 12 months (one year) from the date of delivery that this product shall be of the quality, material and workmanship defined in SENSIRION's published specifications of the product. Within such period, if proven to be defective, SENSIRION shall repair and/or replace this product, in SENSIRION's discretion, free of charge to the Buyer, provided that:

- notice in writing describing the defects shall be given to SENSIRION within fourteen (14) days after their appearance;
- such defects shall be found, to SENSIRION's reasonable satisfaction, to have arisen from SENSIRION's faulty design, material, or workmanship;
- the defective product shall be returned to SENSIRION's factory at the Buyer's expense; and
- the warranty period for any repaired or replaced product shall be limited to the unexpired portion of the original period.

This warranty does not apply to any equipment which has not been installed and used within the specifications recommended by SENSIRION for the intended and proper use of the equipment. EXCEPT FOR THE WARRANTIES EXPRESSLY SET FORTH HEREIN, SENSIRION MAKES NO WARRANTIES, EITHER EXPRESS OR IMPLIED, WITH RESPECT TO THE PRODUCT. ANY AND ALL WARRANTIES, INCLUDING WITHOUT LIMITATION, WARRANTIES OF MERCHANTABILITY OR FITNESS FOR A PARTICULAR PURPOSE, ARE EXPRESSLY EXCLUDED AND DECLINED.

SENSIRION is only liable for defects of this product arising under the conditions of operation provided for in the data sheet and proper use of the goods. SENSIRION explicitly disclaims all warranties, express or implied, for any period during which the goods are operated or stored not in accordance with the technical specifications.

SENSIRION does not assume any liability arising out of any application or use of any product or circuit and specifically disclaims any and all liability, including without limitation consequential or incidental damages. All operating parameters, including without limitation recommended parameters, must be validated for each customer's applications by customer's technical experts. Recommended parameters can and do vary in different applications.

SENSIRION reserves the right, without further notice, (i) to change the product specifications and/or the information in this document and (ii) to improve reliability, functions and design of this product.

Copyright© 2020, by SENSIRION.

CMOSens® is a trademark of Sensirion

All rights reserved

10 Headquarters and Subsidiaries

Sensirion AG

Laubisruestr. 50
CH-8712 Staefa ZH
Switzerland

phone: +41 44 306 40 00
fax: +41 44 306 40 30
info@sensirion.com
www.sensirion.com

Sensirion Taiwan Co. Ltd

phone: +886 3 5506701
info@sensirion.com
www.sensirion.com

Sensirion Inc., USA

phone: +1 312 690 5858
info-us@sensirion.com
www.sensirion.com

Sensirion Japan Co. Ltd.

phone: +81 3 3444 4940
info-jp@sensirion.com
www.sensirion.co.jp

Sensirion Korea Co. Ltd.

phone: +82 31 337 7700~3
info-kr@sensirion.com
www.sensirion.co.kr

Sensirion China Co. Ltd.

phone: +86 755 8252 1501
info-cn@sensirion.com
www.sensirion.com.cn

To find your local representative, please visit www.sensirion.com/distributors

Revision History of the SLI Datasheet

Revision	Date	Changes Chapter	Description
13	January 2020	7	Product names updated
12	December 2019	all	Editorial changes to match new datasheet layout, SLI-0430C added