



CERAMIC

# Low Pass Filter

## LFCN-3800+

50Ω DC<sup>1</sup> to 3900 MHz

### FEATURES

- Excellent power handling, 8W
- Small size
- 7 sections
- Temperature stable
- LTCC construction
- Protected by U.S Patent 6,943,646



Generic photo used for illustration purposes only

CASE STYLE: FV1206

### APPLICATIONS

- Harmonic rejection
- VHF/UHF transmitters/receivers
- Lab use

#### +RoHS Compliant

The +Suffix identifies RoHS Compliance. See our web site for RoHS Compliance methodologies and qualifications

### ELECTRICAL SPECIFICATIONS<sup>1,2</sup> AT 25°C

| Parameter | F#             | Frequency (MHz) | Min.       | Typ. | Max. | Units |    |
|-----------|----------------|-----------------|------------|------|------|-------|----|
| Passband  | Insertion Loss | DC-F1           | DC-3900    | —    | —    | 1.5   | dB |
|           | Freq. Cut-Off  | F2              | 4850       | —    | 3.0  | —     | dB |
|           | VSWR           | DC-F1           | DC-3900    | —    | 1.3  | —     | :1 |
| Stop Band | Rejection Loss | F3              | 6000       | 20   | —    | —     | dB |
|           |                | F4-F5           | 5700-8300  | —    | 30   | —     |    |
|           | VSWR           | F5-F6           | 8300-13000 | —    | 20   | —     | :1 |
|           |                | F3-F6           | 6000-13000 | —    | 17   | —     |    |

1. In Applications where DC isolation to ground is required, coupling capacitors are recommended to avoid DC leakage. Alternatively, if DC pass IN-OUT is required, Mini-Circuits' "D" suffix version of this model will support DC IN-OUT, and provide >100 MOhm isolation to ground.
2. Measured on Mini-Circuits Characterization Test Board TB-270.

### MAXIMUM RATINGS

| Parameter                   | Ratings          |
|-----------------------------|------------------|
| Operating temperature       | -55°C to 100°C   |
| Storage temperature         | -55°C to 100°C   |
| RF Power Input <sup>3</sup> | 8 W max. at 25°C |

3. Passband rating, derate linearly to 3W at 100°C ambient. Permanent damage may occur if any of these limits are exceeded.

### TYPICAL FREQUENCY RESPONSE

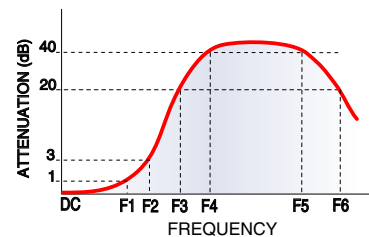

### FUNCTIONAL SCHEMATIC

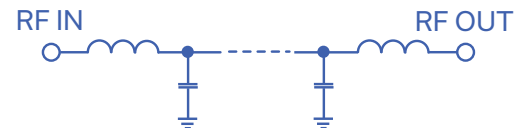

REV. G  
ECO-011331  
LFCN-3800+  
RVN  
220103





CERAMIC

# Low Pass Filter

## LFCN-3800+

### PIN CONNECTIONS

|        |     |
|--------|-----|
| RF IN  | 1   |
| RF OUT | 3   |
| GROUND | 2,4 |

PRODUCT MARKING: N/A

DEMO BOARD MCL P/N: TB-270  
SUGGESTED PCB LAYOUT (PL-137)

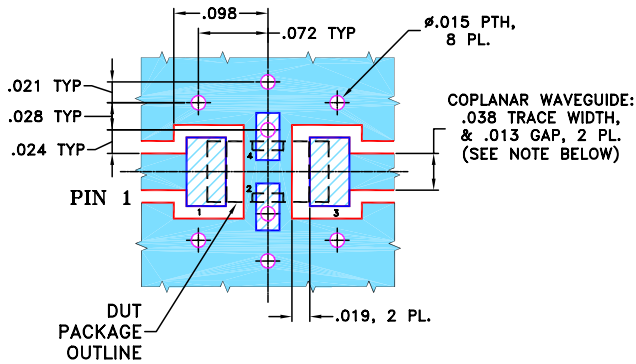

- NOTES:**
1. COPLANAR WAVEGUIDE PARAMETERS ARE SHOWN FOR ROGERS RO4350B WITH THICKNESS .020" ± .0015".  
COPPER: 1/2 OZ. EACH SIDE.  
FOR OTHER MATERIALS TRACE WIDTH & GAP MAY NEED TO BE MODIFIED.
  2. BOTTOM SIDE OF THE PCB IS CONTINUOUS GROUND PLANE.

- DENOTES PCB COPPER LAYOUT WITH SMOBC (SOLDER MASK OVER BARE COPPER)
- DENOTES COPPER LAND PATTERN FREE OF SOLDER MASK

### OUTLINE DRAWING

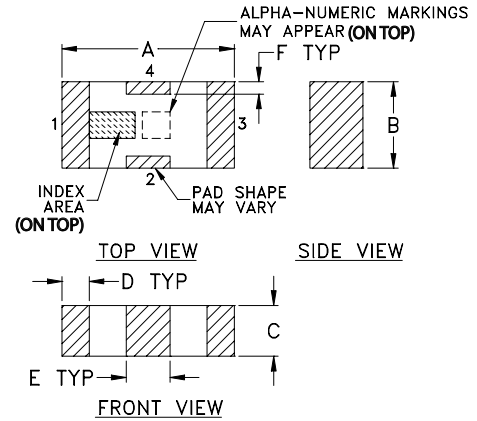

### PCB Land Pattern

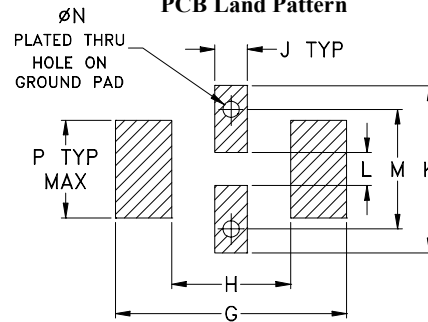

Suggested Layout,  
Tolerance to be within ±.002

### OUTLINE DIMENSIONS (Inches mm)

| A    | B    | C    | D    | E    | F    | G    |
|------|------|------|------|------|------|------|
| .126 | .063 | .037 | .020 | .032 | .009 | .169 |
| 3.20 | 1.60 | 0.94 | 0.51 | 0.81 | 0.23 | 4.29 |

| H    | J    | K    | L    | M    | N    | P    | wt    |
|------|------|------|------|------|------|------|-------|
| .087 | .024 | .122 | .024 | .087 | .012 | .071 | grams |
| 2.21 | 0.61 | 3.10 | 0.61 | 2.21 | 0.30 | 1.80 | .020  |

TAPE & REEL INFORMATION: F71



CERAMIC

# Low Pass Filter

## LFCN-3800+

Mini-Circuits

### TYPICAL PERFORMANCE DATA AT 25°C

| Frequency (MHz) | Insertion Loss (dB) | VSWR (:1) |
|-----------------|---------------------|-----------|
| 40              | 0.06                | 1.03      |
| 1550            | 0.27                | 1.07      |
| 3060            | 0.48                | 1.25      |
| 3900            | 0.66                | 1.34      |
| 4510            | 0.95                | 1.11      |
| 4760            | 1.93                | 1.95      |
| 4850            | 2.76                | 2.60      |
| 4930            | 3.84                | 3.48      |
| 5120            | 7.65                | 7.05      |
| 5380            | 15.30               | 14.15     |
| 5700            | 30.21               | 20.22     |
| 6000            | 33.71               | 23.49     |
| 8300            | 29.24               | 19.76     |
| 13000           | 18.04               | 12.09     |
| 20000           | 14.19               | 6.35      |

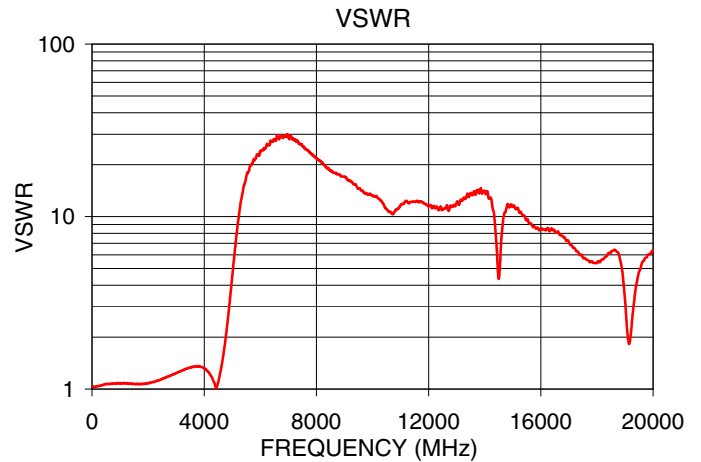
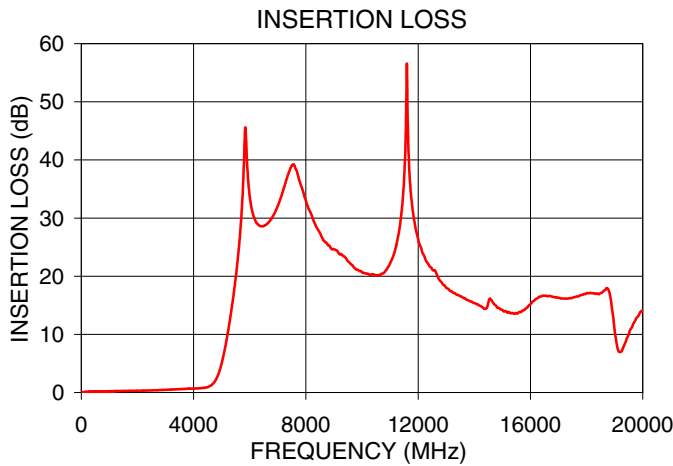

#### NOTES

- A. Performance and quality attributes and conditions not expressly stated in this specification document are intended to be excluded and do not form a part of this specification document.
- B. Electrical specifications and performance data contained in this specification document are based on Mini-Circuit's applicable established test performance criteria and measurement instructions.
- C. The parts covered by this specification document are subject to Mini-Circuits standard limited warranty and terms and conditions (collectively, "Standard Terms"); Purchasers of this part are entitled to the rights and benefits contained therein. For a full statement of the standard. Terms and the exclusive rights and remedies thereunder, please visit Mini-Circuits' website at [www.minicircuits.com/MCLStore/terms.jsp](http://www.minicircuits.com/MCLStore/terms.jsp)

