



Film Capacitors - Power Electronic Capacitors

PEC MKP DC

Series/Type:	MKP DC (Resin top)
Ordering code:	B25690
Date:	June 2022
Version:	2

1. Construction and general data

Characteristics	
Standard capacitance tolerance	K: $\pm 10\%$
Dielectric dissipation factor ($\tan \delta_o$)	$2 \cdot 10^{-4}$
Service life expectancy $t_{LD (co)}$ (refer to section 3)	100 000 h at $T_{hs} + 75\text{ °C}$ and V_{RDC} for $\varnothing D \leq 116$ mm 100 000 h at $T_{hs} + 70\text{ °C}$ and V_{RDC} for $\varnothing D = 136$ mm up to 200 000 h (Considering de-ratings in voltage and/or temperature upon request)
Expected failure rate $\alpha_{FQ (co)}$	50 fit at V_{RDC} and $+70\text{ °C}$ (refer to section 4)
Minimum temperature $T_{op,min.}$	-40 °C
Maximum temperature $T_{op,max.}$	$+85\text{ °C}$ for diameter $75 \leq \varnothing D \leq 100$ mm $+75\text{ °C}$ for diameter $116 \leq \varnothing D \leq 136$ mm
Storage temperature T_{stg}	$-40 \dots +85\text{ °C}$
Maximum hotspot temperature T_{hs} (refer to section 1)	$+85\text{ °C}$ for diameter $75 \leq \varnothing D \leq 100$ mm $+75\text{ °C}$ for diameter $116 \leq \varnothing D \leq 136$ mm
Climatic category	40/85/56 for $75 \leq \varnothing D \leq 100$ mm diameter 40/75/56 for 116 and 136 mm diameter
Maximum altitude	2000 m above sea level (Derating curves for altitudes higher than 2000 m available upon request)
Frequency range	100 Hz \sim 10 kHz for $C_R \leq 1500\text{ }\mu\text{F}$ 100 Hz \sim 5 kHz for $1500\text{ }\mu\text{F} < C_R \leq 3000\text{ }\mu\text{F}$ 100 Hz \sim 3 kHz for $3000\text{ }\mu\text{F} < C_R \leq 5500\text{ }\mu\text{F}$ High frequency designs available upon request Permit I_{max} of specified frequency need be evaluated by customer
Safety device	No internal protection
Partial discharge extinction voltage (typical)	$> 1.6\text{ kV}_{ac}$ (10 pC) (higher value upon request)
*Short-time PD measurements can be used as non-destructive testing methods for controlling the quality of insulation systems in electronic and electrical components.	
Test data	
Voltage test between terminals V_{TT}	$1.5 V_{RDC}$, 10 s
Voltage test between terminals and case V_{TC}	$V_{RDC} \leq 2000 V_{DC}$: 4000 V_{AC} / 10 s $2200 V_{DC} \leq V_{RDC} \leq 2800 V_{DC}$: 5000 V_{AC} / 10 s $V_{RDC} = 3000 V_{DC}$: 5250 V_{AC} / 10 s
Design data	
Resin filling	Non PCB, hard polyurethane (dry type)
Mounting and grounding	M12 threaded bolt on bottom of the aluminum case
Max. torque (case) M12 stud	10 Nm
Max. torque terminal	Female M6: 5 Nm /Female M8: 6 Nm
Cooling	Naturally air-cooled (or forced air cooling)
Degree of protection	IP00 (Indoor mounting)
Reference standards	
IEC 61071-2017, GB/T 17702-2021	
RoHS and CE compliance	
UL 810 5 th edition - certification file No. E502394	

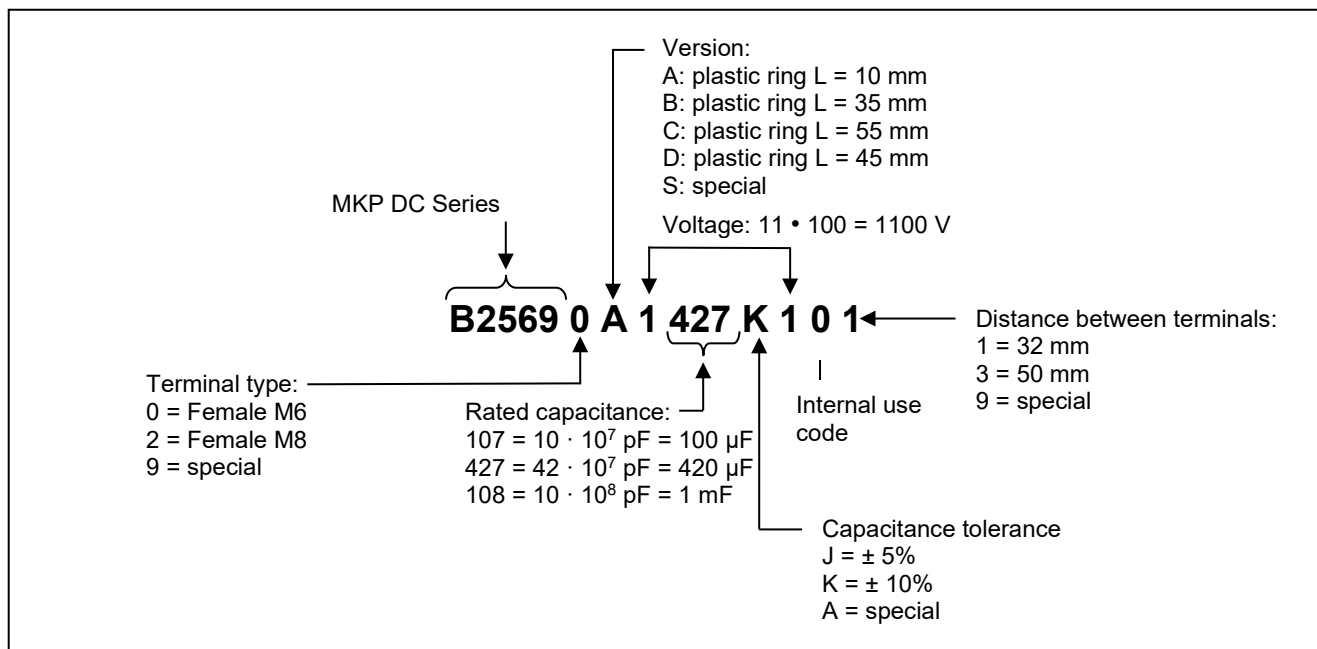
1.1 Structure of ordering code

1.2 Label information

B25690A1487K101

480µF ±10%

$V_{RDC} = 1100V$

$V_{TC} = 4kV$

-40...+85°C IEC 61071

SH-No PCB Dry Type

Max. torque of terminals:5Nm

Discharge before handling

Made by EPCOS 20 Z 2022

The label explanation are following:
20 Z 2022: Production by TDK Electronics Zhuhai factory **2022** year, calendar week **20**;

Bar code consists of lot number and serial number:

 Lot number: 9 digits (ex.: **905937552**)

 Serial number: 3 digits (ex.: **066**)

1.3 Standard types

Distance between terminals (mm) OC ending		32 ± 0.5	50 ± 0.5
		-**1	-**3
Diameter (Ø)	Terminal type		
75/85/100 mm	Female M6	standard	
116/136 mm	Female M6		standard

Other terminal configurations available upon request.

1.4 Electrical characteristics: Clearance and Creepage distances

Diameter (Ø)	Plastic ring (L)	Terminal to Terminal		Terminal to Case	
		Typical clearance mm	Typical creepage mm	Typical clearance mm	Typical creepage mm
75	10	20.0	27.5	25.5	27.0
85	10	20.0	27.5	30.5	32.0
100	10	19.5	27.0	37.5	39.0
116	10	36.0	43.5	36.0	37.5
136	55	36.0	47.5	91.0	92.5

1.5 Packing information

Diameter (Ø)	Packing design
75/85/100 mm	4 capacitors per box or 12 capacitors per box
116/136 mm	4 capacitors per box

Each carton box may contain carton plates to fill the empty space, the number of carton plates will be defined by actual demand.



B25690A-series B25690C-series

1.6 Dimensional drawings

Figure 1: - B25690A – $\varnothing = 75/85$ mm
 - Female terminals (M6)
 - Between terminals 32 ± 0.5 mm

Figure 2: - B25690A – $\varnothing = 100$ mm
 - Female terminals (M6)
 - Between terminals 32 ± 0.5 mm

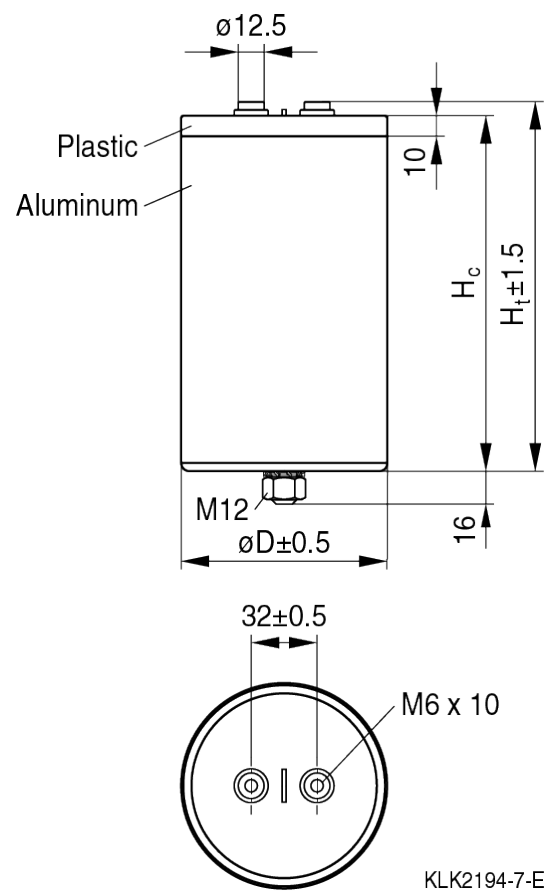
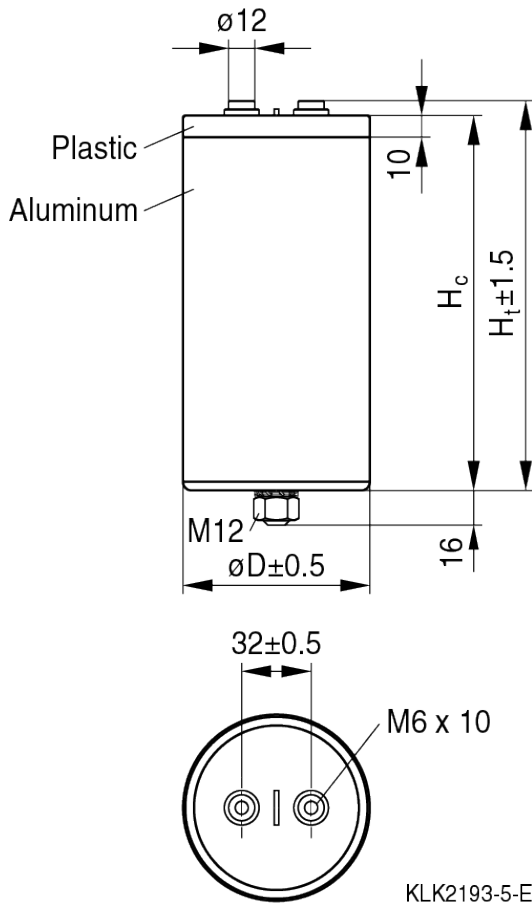

M12 stud on bottom of the aluminum case, nut (DIN 934) and toothed lock washer (DIN 6797) for fixing are standard for all types.

\varnothing is the diameter which close to the bottom side about 10 mm.

Figure 3: - B25690A – $\varnothing = 116$ mm
 - Female terminals (M6)
 - Between terminals 50 ± 0.5 mm

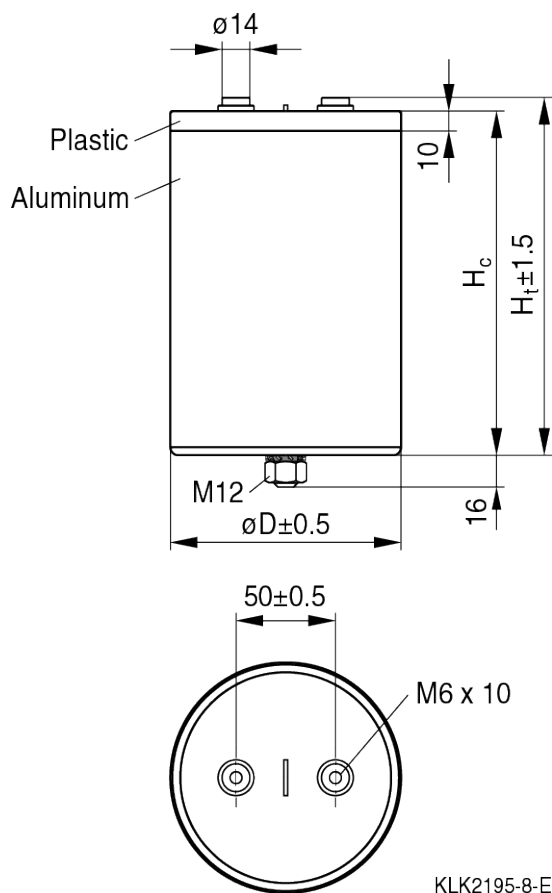
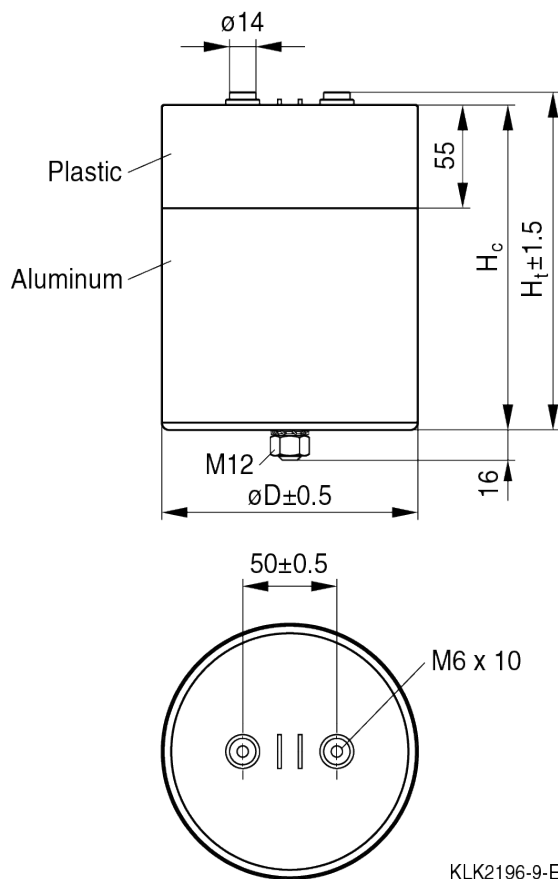

Figure 4: - B25690C – $\varnothing = 136$ mm
 - Female terminals (M6)
 - Between terminals 50 ± 0.5 mm



M12 stud on bottom of the aluminum case, nut (DIN 934) and toothed lock washer (DIN 6797) for fixing are standard for all types.

\varnothing is the diameter which close to the bottom side about 10 mm.

Terms and characteristics

The following definitions apply to power capacitors according to IEC 61071.

Rated capacitance C_R

Nominal value of the capacitance at 20 °C and measuring frequency of 100 Hz.

Rated DC voltage V_{RDC}

Maximum operating peak voltage of either polarity but of a non-reversing type wave form, for which the capacitor has been designed, for continuous operation.

Ripple voltage V_{ripple}

Peak-to-peak alternating component of the unidirectional voltage.

This value must not exceed $0.28 \cdot V_{RDC}$

Maximum surge voltage V_s

Peak voltage induced by a switching or any other disturbance of the system which is allowed for a limited number of times and short period.

Insulation voltage V_i

Rms rated value of the insulation voltage of capacitive elements and terminals to case or earth. When it is not specified in the product data sheet, the insulation voltage is at least:

$$V_i = \frac{V_{RDC}}{\sqrt{2}}$$

AC voltage test between terminals and case V_{TC}

Units having all terminals insulated from the container shall be subjected for 10 s to a voltage applied between the terminals (joined together) and the container.

Maximum rate of voltage rise $(dv/dt)_{max}$

Maximum permissible repetitive rate of voltage rise of the operational voltage.

Maximum current I_{max}

Maximum rms current for continuous operation for the given frequency range and for the maximum ripple voltage. Please provide Frequency Spectrum of rms current to your sales contact.

Maximum peak current \hat{I}

Maximum permissible repetitive current amplitude during continuous operation.

Maximum peak current (\hat{I}) and maximum rate of voltage rise $(dv/dt)_{max}$ on a capacitor are related as follows:

$$\hat{I} = C \cdot (dv/dt)_{max}$$

Maximum surge current \hat{I}_s

Admissible peak current induced by a switching or any other disturbance of the system which is allowed for a limited number of times and short period.

$$\hat{I}_s = C \cdot (dv/dt)_s$$

Ambient temperature T_A

Temperature of the surrounding air, measured at 10 cm distance and 2/3 of the case height of the capacitor.

Lowest operating temperature $T_{op,min}$

Lowest permitted ambient temperature at which a capacitor may be energized.

Maximum operating temperature $T_{op,max}$

Highest permitted capacitor temperature during operation, i.e. temperature at the hottest point of the case.

Hot-spot temperature T_{hs}

Temperature zone inside of the capacitor at hottest spot.

$$T_{hs} = T_A + I_{RMS}^2 \cdot ESR \cdot R_{th}$$

Tangent of the loss angle of a capacitor $\tan \delta$

Ratio between the equivalent series resistance and the capacitive reactance of a capacitor at a specified sinusoidal alternating voltage, frequency and temperature.

Series resistance R_s

The sum of all Ohmic resistances occurring inside the capacitor.

ESR

Effective resistance which, if connected in series with an ideal capacitor of capacitance value equal to that of the capacitor in question, would have a power loss equal to active power dissipated in that capacitor under specified operating conditions.

$$ESR = \frac{\tan \delta}{\omega \cdot C} = R_s + \frac{\tan \delta_0}{\omega \cdot C}$$

Thermal resistance R_{th}

The thermal resistance indicates by how many degrees the capacitor temperature at the hot spot rises in relation to the dissipation losses.

Maximum power loss P_{max}

Maximum permissible power dissipation for the capacitor's operation.

$$P_{max} = \frac{T_{hs} - T_A}{R_{th}}$$

Self inductance L_{self}

The sum of all inductive elements which are contained in a capacitor.

Resonance frequency f_r

The lowest frequency at which the impedance of the capacitor becomes minimum.

$$f_r = \frac{1}{2\pi \cdot \sqrt{L_{self} \cdot C_R}}$$

$V_{RDC} = 700 \text{ V DC} / V_{TT} = 1050 \text{ V DC}, 10 \text{ s} / V_{TC} = 4000 \text{ V AC}, 10 \text{ s}$

C_R μF	I_{MAX}^1 A	I_s kA	\hat{I} kA	ESR ² m Ω	L_{self} nH	R_{TH} K/W	\varnothing mm	H_C^3 mm	H_T mm	Weight ⁴ kg	Fig.	Ordering code
360	70	6.6	2.2	1.6	≤ 40	5.5	75	95	101	0.5	1	B25690A0367K701
480	65	6.5	2.2	2.1	≤ 40	4.6	75	120	126	0.6	1	B25690A0487K701
500	70	8.9	3.0	1.6	≤ 40	5.0	85	95	101	0.6	1	B25690A0507K701
560	70	13.0	4.3	1.5	≤ 40	4.2	75	155	161	0.8	1	B25690A0567K701
650	70	8.9	3.0	2.0	≤ 40	4.7	85	120	126	0.8	1	B25690A0657K701
660	70	12.2	4.1	1.4	≤ 40	4.6	100	95	101	0.9	2	B25690A0667K701
680	70	13.1	4.4	1.7	≤ 60	4.2	75	176	182	0.9	1	B25690A0687K701
750	70	8.9	3.0	2.2	≤ 40	4.6	85	135	141	0.9	1	B25690A0757K701
780	70	8.9	3.0	2.0	≤ 40	4.5	85	140	146	1.0	1	B25690A0787K701
780	70	17.8	5.9	1.5	≤ 40	4.3	85	155	161	1.1	1	B25690A0787K721
900	70	12.4	4.1	1.5	≤ 40	4.2	100	120	126	1.2	2	B25690A0907K701
920	80	17.3	5.8	0.7	≤ 40	5.3	116	96	102	1.0	3	B25690A0927K703
950	70	17.8	5.9	1.5	≤ 60	4.2	85	176	182	1.2	1	B25690A0957K701
1000	70	12.2	4.1	1.9	≤ 40	3.9	100	135	141	1.4	2	B25690A0108K701
1100	70	12.5	4.2	1.9	≤ 40	3.8	100	140	146	1.5	2	B25690A0118K701
1100	70	25.2	8.4	1.0	≤ 40	3.4	100	155	161	1.6	2	B25690A0118K721
1200	80	16.6	5.5	1.0	≤ 40	4.9	116	121	127	1.4	3	B25690A0128K703
1300	70	24.4	8.1	1.1	≤ 60	3.1	100	176	182	2.0	2	B25690A0138K701
1400	70	18.0	6.0	1.4	≤ 90	3.2	85	252	258	1.6	1	B25690A0148K701
1500	80	17.1	5.7	1.1	≤ 40	4.8	116	141	147	1.6	3	B25690A0158K703
1500	100	34.3	11.4	1.0	≤ 60	3.5	116	155	161	1.8	3	B25690A0158K723
1800	100	33.8	11.3	1.0	≤ 60	3.3	116	176	182	2.0	3	B25690A0188K703
2500	100	34.5	11.5	0.9	≤ 90	2.6	116	230	236	2.5	3	B25690A0258K703
4400	100	56.8	18.9	0.8	≤ 90	2.0	136	304	310	4.5	4	B25690C0448K703
5000	100	55.7	18.6	0.7	≤ 90	1.8	136	345	351	5.0	4	B25690C0508K703
5500	100	58.6	19.5	0.7	≤ 90	1.6	136	370	376	5.5	4	B25690C0558K703

¹ Please refer to current derating section for more details

² ESR at 1 kHz (typical value)

³ H_C is typical value

⁴ Weight is typical value

Other configurations and capacitance tolerances available upon request

$V_{RDC} = 900 \text{ V DC} / V_{TT} = 1350 \text{ V DC}, 10 \text{ s} / V_{TC} = 4000 \text{ V AC}, 10 \text{ s}$

C_R μF	I_{MAX}^1 A	I_s kA	\hat{I} kA	ESR^2 m Ω	L_{self} nH	R_{TH} K/W	\varnothing mm	H_c^3 mm	H_T mm	Weight ⁴ kg	Fig.	Ordering code
280	65	5.8	1.9	2.1	≤40	5.5	75	95	101	0.5	1	B25690A0287K901
370	60	5.8	1.9	2.7	≤40	4.6	75	120	126	0.6	1	B25690A0377K901
380	70	7.9	2.6	1.7	≤40	5.0	85	95	101	0.6	1	B25690A0387K901
420	70	11.5	3.8	1.8	≤40	4.2	75	155	161	0.8	1	B25690A0427K901
500	70	10.7	3.6	1.5	≤40	4.6	100	95	101	0.9	2	B25690A0507K901
510	70	7.8	2.6	2.2	≤40	4.7	85	120	126	0.8	1	B25690A0517K901
520	70	11.6	3.9	1.9	≤60	4.2	75	176	182	0.9	1	B25690A0527K901
570	65	7.9	2.7	2.3	≤40	4.6	85	135	141	0.9	1	B25690A0577K901
580	70	15.7	5.2	1.5	≤40	4.3	85	155	161	1.1	1	B25690A0587K901
600	65	7.8	2.6	2.5	≤40	4.5	85	140	146	1.0	1	B25690A0607K901
700	70	11.0	3.7	1.7	≤40	4.2	100	120	126	1.2	2	B25690A0707K901
720	80	15.4	5.1	1.0	≤40	5.3	116	96	102	1.0	3	B25690A0727K903
730	70	15.7	5.2	1.6	≤60	4.2	85	176	182	1.2	1	B25690A0737K901
780	70	11.1	3.7	1.9	≤40	3.9	100	135	141	1.4	2	B25690A0787K901
850	70	11.1	3.7	2.1	≤40	3.8	100	140	146	1.5	2	B25690A0857K901
850	70	22.2	7.4	1.2	≤40	3.4	100	155	161	1.6	2	B25690A0857K921
980	80	15.3	5.1	1.3	≤40	4.9	116	121	127	1.4	3	B25690A0987K903
1000	70	21.4	7.1	1.2	≤60	3.1	100	176	182	2.0	2	B25690A0108K901
1100	70	15.3	5.1	1.4	≤90	3.2	85	252	258	1.6	1	B25690A0118K901
1150	100	30.8	10.3	1.0	≤60	3.5	116	155	161	1.8	3	B25690A0118K903
1200	80	15.4	5.1	1.5	≤40	4.8	116	141	147	1.6	3	B25690A0128K903
1400	100	31.1	10.4	1.3	≤60	3.3	116	176	182	2.0	3	B25690A0148K903
1900	100	30.8	10.3	1.2	≤90	2.6	116	230	236	2.5	3	B25690A0198K903
3400	100	49.5	16.5	1.2	≤90	2.0	136	304	310	4.5	4	B25690C0348K903
3800	100	50.6	16.9	1.1	≤90	1.8	136	345	351	5.0	4	B25690C0388K903
4300	100	52.3	17.4	1.0	≤90	1.6	136	370	376	5.5	4	B25690C0438K903

¹ Please refer to current derating section for more details

² ESR at 1 kHz (typical value)

³ H_c is typical value

⁴ Weight is typical value

Other configurations and capacitance tolerances available upon request

$V_{RDC} = 1000 \text{ V DC} / V_{TT} = 1500 \text{ V DC}, 10 \text{ s} / V_{TC} = 4000 \text{ V AC}, 10 \text{ s}$

C_R μF	I_{MAX}^1 A	I_s kA	\hat{I} kA	ESR ² m Ω	L_{self} nH	R_{TH} K/W	\varnothing mm	H_C^3 mm	H_T mm	Weight ⁴ kg	Fig.	Ordering code
220	60	5.1	1.7	2.2	≤40	5.5	75	95	101	0.5	1	B25690A1227K001
290	70	7.0	2.3	1.8	≤40	5.0	85	95	101	0.6	1	B25690A1297K001
300	55	5.0	1.7	2.9	≤40	4.6	75	120	126	0.6	1	B25690A1307K001
330	70	10.0	3.3	1.9	≤40	4.2	75	155	161	0.8	1	B25690A1337K001
400	65	7.1	2.4	2.3	≤40	4.7	85	120	126	0.8	1	B25690A1407K001
400	70	9.6	3.2	1.5	≤40	4.6	100	95	101	0.9	2	B25690A1407K011
410	70	10.1	3.4	2.0	≤60	4.2	75	176	182	0.9	1	B25690A1417K001
450	65	7.0	2.4	2.2	≤40	4.6	85	135	141	0.9	1	B25690A1457K001
460	70	13.8	4.6	1.6	≤40	4.3	85	155	161	1.1	1	B25690A1467K001
470	60	6.9	2.3	2.6	≤40	4.5	85	140	146	1.0	1	B25690A1477K001
530	70	9.8	3.3	1.8	≤40	4.2	100	120	126	1.2	2	B25690A1537K001
550	80	13.5	4.5	1.0	≤40	5.3	116	96	102	1.0	3	B25690A1557K003
570	70	13.7	4.6	1.7	≤60	4.2	85	176	182	1.2	1	B25690A1577K001
600	70	9.5	3.2	1.9	≤40	3.9	100	135	141	1.4	2	B25690A1607K001
650	70	9.7	3.2	1.9	≤40	3.8	100	140	146	1.5	2	B25690A1657K001
650	70	19.1	6.4	1.1	≤40	3.4	100	155	161	1.6	2	B25690A1657K021
750	80	13.6	4.5	1.4	≤40	4.9	116	121	127	1.4	3	B25690A1757K003
780	70	19.3	6.4	1.1	≤60	3.1	100	176	182	2.0	2	B25690A1787K001
860	70	13.8	4.6	1.3	≤90	3.2	85	252	258	1.6	1	B25690A1867K001
920	80	13.5	4.5	1.5	≤40	4.8	116	141	147	1.6	3	B25690A1927K003
920	100	27.0	9.0	1.0	≤60	3.5	116	155	161	1.8	3	B25690A1927K023
1100	100	26.5	8.8	1.2	≤60	3.3	116	176	182	2.0	3	B25690A1108K003
1500	100	26.6	8.9	0.9	≤90	2.6	116	230	236	2.5	3	B25690A1158K003
2700	100	44.7	14.9	0.9	≤90	2.0	136	304	310	4.5	4	B25690C1278K003
3100	100	45.1	15.0	0.8	≤90	1.8	136	345	351	5.0	4	B25690C1318K003
3500	100	46.5	15.5	0.8	≤90	1.6	136	370	376	5.5	4	B25690C1358K003

¹ Please refer to current derating section for more details

² ESR at 1 kHz (typical value)

³ H_C is typical value

⁴ Weight is typical value

Other configurations and capacitance tolerances available upon request

$V_{RDC} = 1100 \text{ V DC} / V_{TT} = 1650 \text{ V DC}, 10 \text{ s} / V_{TC} = 4000 \text{ V AC}, 10 \text{ s}$

C_R μF	I_{MAX}^1 A	I_s kA	\hat{I} kA	ESR ² m Ω	L_{self} nH	R_{TH} K/W	\varnothing mm	H_C^3 mm	H_T mm	Weight ⁴ kg	Fig.	Ordering code
180	60	6.1	2.0	2.3	≤40	5.5	75	95	101	0.5	1	B25690A1187K101
240	70	8.5	2.8	1.9	≤40	5.0	85	95	101	0.6	1	B25690A1247K101
250	55	6.0	2.0	3.0	≤40	4.6	75	120	126	0.6	1	B25690A1257K101
280	70	12.2	4.1	2.0	≤40	4.2	75	155	161	0.8	1	B25690A1287K101
300	55	6.1	2.0	3.4	≤40	4.5	75	140	146	0.7	1	B25690A1307K101
320	65	8.4	2.8	2.4	≤40	4.7	85	120	126	0.8	1	B25690A1327K101
330	70	11.8	3.9	1.7	≤40	4.6	100	95	101	0.9	1	B25690A1337K101
340	70	12.2	4.1	2.1	≤60	4.2	75	176	182	0.9	1	B25690A1347K101
420	70	17.5	5.8	1.8	≤40	4.3	85	155	161	1.1	1	B25690A1427K121
450	70	11.8	3.9	2.1	≤40	4.2	100	120	126	1.2	2	B25690A1457K101
470	80	16.1	5.4	1.1	≤40	5.3	116	96	102	1.0	2	B25690A1477K103
480	70	16.8	5.6	1.9	≤60	4.2	85	176	182	1.2	1	B25690A1487K101
500	70	11.6	3.9	2.0	≤40	3.9	100	135	141	1.4	2	B25690A1507K101
540	70	11.7	3.9	2.0	≤40	3.8	100	140	146	1.5	2	B25690A1547K101
550	70	24.0	8.0	1.2	≤40	3.4	100	155	161	1.6	2	B25690A1557K101
620	80	16.3	5.4	1.5	≤40	4.9	116	121	127	1.4	3	B25690A1627K103
660	70	23.6	7.9	1.2	≤60	3.1	100	176	182	2.0	2	B25690A1667K101
720	70	16.7	5.6	1.4	≤90	3.2	85	252	258	1.6	1	B25690A1727K101
760	75	16.3	5.4	1.6	≤40	4.8	116	141	147	1.6	3	B25690A1767K103
770	100	32.7	10.9	1.1	≤60	3.5	116	155	161	1.8	3	B25690A1777K103
900	100	32.2	10.7	1.3	≤60	3.3	116	176	182	2.0	3	B25690A1907K103
1200	100	31.6	10.5	1.2	≤90	2.6	116	230	236	2.5	3	B25690A1128K103
2200	100	54.0	18.0	1.2	≤90	2.0	136	304	310	4.5	4	B25690C1228K103
2600	100	54.3	18.1	1.1	≤90	1.8	136	345	351	5.0	4	B25690C1268K103
3000	100	58.1	19.4	1.0	≤90	1.6	136	370	376	5.5	4	B25690C1308K103

¹ Please refer to current derating section for more details

² ESR at 1 kHz (typical value)

³ H_C is typical value

⁴ Weight is typical value

Other configurations and capacitance tolerances available upon request

$V_{RDC} = 1200 \text{ V DC} / V_{TT} = 1800 \text{ V DC}, 10 \text{ s} / V_{TC} = 4000 \text{ V AC}, 10 \text{ s}$

C_R μF	I_{MAX}^1 A	I_s kA	\hat{I} kA	ESR ² m Ω	L_{self} nH	R_{TH} K/W	\varnothing mm	H_c^3 mm	H_T mm	Weight ⁴ kg	Fig.	Ordering code
140	55	5.5	1.8	2.8	≤40	5.5	75	95	101	0.5	1	B25690A1147K201
190	55	5.5	1.8	3.5	≤40	4.6	75	120	126	0.6	1	B25690A1197K201
200	65	7.6	2.5	2.2	≤40	5.0	85	95	101	0.6	1	B25690A1207K201
220	70	11.0	3.7	2.1	≤40	4.2	75	155	161	0.8	1	B25690A1227K221
260	60	7.5	2.5	2.7	≤40	4.7	85	120	126	0.8	1	B25690A1267K201
270	70	11.0	3.7	2.2	≤60	4.2	75	176	182	0.9	1	B25690A1277K201
270	70	10.6	3.5	2.0	≤40	4.6	100	95	101	0.9	2	B25690A1277K211
300	65	7.7	2.6	2.6	≤40	4.6	85	135	141	0.9	1	B25690A1307K201
310	70	15.3	5.1	1.9	≤40	4.3	85	155	161	1.1	1	B25690A1317K201
320	60	7.6	2.5	3.1	≤40	4.5	85	140	146	1.0	1	B25690A1327K201
360	70	10.4	3.5	2.1	≤40	4.2	100	120	126	1.2	2	B25690A1367K201
370	80	14.5	4.8	1.2	≤40	5.3	116	96	102	1.0	3	B25690A1377K203
380	70	14.9	5.0	2.0	≤60	4.2	85	176	182	1.2	1	B25690A1387K201
400	70	10.7	3.6	2.3	≤40	3.9	100	135	141	1.4	2	B25690A1407K201
430	70	10.7	3.6	2.3	≤40	3.8	100	140	146	1.5	2	B25690A1437K201
450	70	21.6	7.2	1.3	≤40	3.4	100	155	161	1.6	2	B25690A1457K201
500	70	21.2	7.1	1.3	≤60	3.1	100	176	182	2.0	2	B25690A1507K201
500	75	14.5	4.8	1.7	≤40	4.9	116	121	127	1.4	3	B25690A1507K203
580	70	14.8	4.9	1.6	≤90	3.2	85	252	258	1.6	1	B25690A1587K201
600	70	14.3	4.8	1.9	≤40	4.8	116	141	147	1.6	3	B25690A1607K203
620	100	29.7	9.9	1.0	≤60	3.5	116	155	161	1.8	3	B25690A1627K203
720	100	29.5	9.8	1.3	≤60	3.3	116	176	182	2.0	3	B25690A1727K203
1000	100	28.9	9.6	1.2	≤90	2.6	116	230	236	2.5	3	B25690A1108K203
1800	100	19.4	6.5	1.2	≤90	2.0	136	304	310	4.5	4	B25690C1188K203
2100	100	48.1	16.0	1.1	≤90	1.8	136	345	351	5.0	4	B25690C1218K203
2400	100	51.1	17.0	1.0	≤90	1.6	136	370	376	5.5	4	B25690C1248K203

¹ Please refer to current derating section for more details

² ESR at 1 kHz (typical value)

³ H_c is typical value

⁴ Weight is typical value

Other configurations and capacitance tolerances available upon request

$V_{RDC} = 1300 \text{ V DC} / V_{TT} = 1950 \text{ V DC}, 10 \text{ s} / V_{TC} = 4000 \text{ V AC}, 10 \text{ s}$

C_R μF	I_{MAX}^1 A	I_s kA	\hat{I} kA	ESR ² m Ω	L_{self} nH	R_{TH} K/W	\varnothing mm	H_c^3 mm	H_T mm	Weight ⁴ kg	Fig.	Ordering code
120	55	5.0	1.7	3.0	≤ 40	5.5	75	95	101	0.5	1	B25690A1127K301
160	50	4.9	1.6	3.8	≤ 40	4.6	75	120	126	0.6	1	B25690A1167K301
160	65	7.1	2.4	2.3	≤ 40	5.0	85	95	101	0.6	1	B25690A1167K321
180	70	9.9	3.3	2.2	≤ 40	4.2	75	155	161	0.8	1	B25690A1187K301
210	70	9.4	3.1	1.9	≤ 40	4.6	100	95	101	0.9	2	B25690A1217K301
220	70	9.9	3.3	2.4	≤ 60	4.2	75	176	182	0.9	1	B25690A1227K301
230	60	6.9	2.3	2.9	≤ 40	4.7	85	120	126	0.8	1	B25690A1237K301
240	70	13.8	4.6	1.9	≤ 40	4.3	85	155	161	1.1	1	B25690A1247K301
250	60	7.0	2.3	2.9	≤ 40	4.6	85	135	141	0.9	1	B25690A1257K301
260	55	6.9	2.3	3.4	≤ 40	4.5	85	140	146	1.0	1	B25690A1267K301
280	65	9.8	3.3	2.2	≤ 40	4.2	100	120	126	1.2	2	B25690A1287K301
300	70	13.4	4.5	2.0	≤ 60	4.2	85	176	182	1.2	1	B25690A1307K301
300	80	13.4	4.5	1.3	≤ 40	5.3	116	96	102	1.0	3	B25690A1307K303
330	65	9.7	3.2	2.4	≤ 40	3.9	100	135	141	1.4	2	B25690A1337K301
350	70	19.9	6.6	1.3	≤ 40	3.4	100	155	161	1.6	2	B25690A1357K301
360	65	9.6	3.2	2.4	≤ 40	3.8	100	140	146	1.5	2	B25690A1367K301
420	70	19.7	6.6	1.4	≤ 60	3.1	100	176	182	2.0	2	B25690A1427K301
420	75	13.7	4.6	1.7	≤ 40	4.9	116	121	127	1.4	3	B25690A1427K303
480	70	13.8	4.6	1.6	≤ 90	3.2	85	252	258	1.6	1	B25690A1487K301
500	100	27.6	9.2	1.1	≤ 60	3.5	116	155	161	1.8	3	B25690A1507K303
520	70	13.9	4.6	1.9	≤ 40	4.8	116	141	147	1.6	3	B25690A1527K303
600	100	27.8	9.3	1.3	≤ 60	3.3	116	176	182	2.0	3	B25690A1607K303
830	100	27.7	9.2	1.2	≤ 90	2.6	116	230	236	2.5	3	B25690A1837K303
1500	100	45.7	15.2	1.2	≤ 90	2.0	136	304	310	4.5	4	B25690C1158K303
1700	100	46.3	15.4	1.1	≤ 90	1.8	136	345	351	5.0	4	B25690C1178K303
1900	100	47.8	15.9	1.0	≤ 90	1.6	136	370	376	5.5	4	B25690C1198K303

¹ Please refer to current derating section for more details

² ESR at 1 kHz (typical value)

³ H_c is typical value

⁴ Weight is typical value

Other configurations and capacitance tolerances available upon request

$V_{RDC} = 1500 \text{ V DC} / V_{TT} = 2550 \text{ V DC}, 10 \text{ s} / V_{TC} = 4000 \text{ V AC}, 10 \text{ s}$

C_R μF	I_{MAX}^1 A	I_s kA	\hat{I} kA	ESR ² m Ω	L_{self} nH	R_{TH} K/W	\varnothing mm	H_C^3 mm	H_T mm	Weight ⁴ kg	Fig.	Ordering code
100	50	4.4	1.5	3.4	≤40	5.5	75	95	101	0.5	1	B25690A1107K501*
120	50	4.2	1.4	4.5	≤40	4.6	75	120	126	0.6	1	B25690A1127K501*
130	60	6.5	2.2	2.7	≤40	5.0	85	95	101	0.6	1	B25690A1137K501*
150	65	9.0	3.0	2.5	≤40	4.2	75	155	161	0.8	1	B25690A1157K521*
170	70	8.3	2.8	2.0	≤40	4.6	100	95	101	0.9	2	B25690A1177K501*
180	55	6.5	2.2	3.4	≤40	4.7	85	120	126	0.8	1	B25690A1187K501*
210	60	6.6	2.2	2.7	≤40	4.6	85	135	141	0.9	1	B25690A1217K501*
210	70	13.0	4.3	2.1	≤40	4.3	85	155	161	1.1	1	B25690A1217K521*
230	60	6.5	2.2	3.1	≤40	4.5	85	140	146	1.0	1	B25690A1237K501*
240	65	8.5	2.8	2.4	≤40	4.2	100	120	126	1.2	2	B25690A1247K501*
250	70	12.5	4.2	2.2	≤60	4.2	85	176	182	1.2	1	B25690A1257K501*
250	80	12.1	4.0	1.5	≤40	5.3	116	96	102	1.0	3	B25690A1257K503*
270	65	8.4	2.8	2.6	≤40	3.9	100	135	141	1.4	2	B25690A1277K501*
280	70	16.1	5.4	1.4	≤40	3.4	100	155	161	1.6	2	B25690A1287K501*
330	70	11.6	3.9	2.0	≤40	4.9	116	121	127	1.4	3	B25690A1337K503*
340	70	16.0	5.3	1.4	≤60	3.1	100	176	182	2.0	2	B25690A1347K501
380	70	12.1	4.0	1.6	≤90	3.2	85	252	258	1.6	1	B25690A1387K501
400	100	25.1	8.4	1.2	≤60	3.5	116	155	161	1.8	3	B25690A1407K503
420	70	12.4	4.1	2.2	≤40	4.8	116	141	147	1.6	3	B25690A1427K503*
500	90	24.3	8.1	1.4	≤60	3.3	116	176	182	2.0	3	B25690A1507K503
680	100	24.0	8.0	1.1	≤90	2.6	116	230	236	2.5	3	B25690A1687K503
1200	100	39.6	13.2	1.2	≤90	2.0	136	304	310	4.5	4	B25690C1128K503
1400	100	41.8	13.9	1.2	≤90	1.8	136	345	351	5.0	4	B25690C1148K503
1600	100	45.0	15.0	1.0	≤90	1.6	136	370	376	5.5	4	B25690C1168K503

¹ Please refer to current derating section for more details

² ESR at 1 kHz (typical value).

³ H_C is typical value.

⁴ Weight is typical value

Other configurations and capacitance tolerances available upon request

*** This ordering code is affected by "Dual Use" regulations according to Export Control law. Deliveries of such products are subject to prior approval by Export Control authorities based on customer declarations. The delivery to certain countries might be restricted.**

$V_{RDC} = 1700 \text{ V DC} / V_{TT} = 2550 \text{ V DC}, 10 \text{ s} / V_{TC} = 4000 \text{ V AC}, 10 \text{ s}$

C_R μF	I_{MAX}^1 A	I_s kA	\hat{I} kA	ESR ² m Ω	L_{self} nH	R_{TH} K/W	\varnothing mm	H_C^3 mm	H_T mm	Weight ⁴ kg	Fig.	Ordering code
170	50	5.7	1.9	3.3	≤40	4.5	85	140	146	1.0	1	B25690A1177K701*
260	80	10.6	3.5	1.8	≤60	3.8	85	230	236	1.4	1	B25690A1267K701
270	70	10.6	3.5	2.1	≤40	4.9	116	121	127	1.4	3	B25690A1277K703*
320	70	10.7	3.6	2.2	≤40	4.8	116	141	147	1.6	3	B25690A1327K703*
360	80	14.3	4.8	1.8	≤40	3.0	136	121	127	1.9	4	B25690C1367K703*
380	100	21.3	7.1	1.2	≤60	3.3	116	176	182	2.0	3	B25690A1387K703
440	80	14.0	4.7	2.0	≤40	2.8	136	141	147	2.2	4	B25690C1447K703*
500	100	28.0	9.3	1.1	≤60	2.5	136	176	182	2.8	4	B25690C1507K703
520	100	21.2	7.1	1.3	≤90	2.6	116	230	236	2.5	3	B25690A1527K703
700	100	28.5	9.5	1.2	≤90	2.2	136	230	236	3.5	4	B25690C1707K703
850	100	28.4	9.5	1.3	≤90	2.0	136	268	274	3.9	4	B25690C1857K703
1100	100	35.4	11.8	1.1	≤90	1.8	136	345	351	5.0	4	B25690C1118K703
1200	100	38.8	12.9	1.0	≤90	1.6	136	370	376	5.5	4	B25690C1128K703

¹ Please refer to current derating section for more details

² ESR at 1 kHz (typical value)

³ H_C is typical value

⁴ Weight is typical value

Other configurations and capacitance tolerances available upon request

*** This ordering code is affected by "Dual Use" regulations according to Export Control law. Deliveries of such products are subject to prior approval by Export Control authorities based on customer declarations. The delivery to certain countries might be restricted.**

$V_{RDC} = 2000 \text{ V DC} / V_{TT} = 3000 \text{ V DC}, 10 \text{ s} / V_{TC} = 4000 \text{ V AC}, 10 \text{ s}$

C_R μF	I_{MAX}^1 A	I_s kA	\hat{I} kA	ESR ² m Ω	L_{self} nH	R_{TH} K/W	\varnothing mm	H_C^3 mm	H_T mm	Weight ⁴ kg	Fig.	Ordering code
110	50	4.4	1.5	3.6	≤ 40	4.5	85	140	146	1.0	1	B25690A2117K001*
170	80	8.8	2.9	1.9	≤ 60	3.8	85	230	236	1.4	1	B25690A2177K001
180	70	8.8	2.9	2.2	≤ 40	4.9	116	121	127	1.4	3	B25690A2187K003*
220	70	8.8	2.9	2.4	≤ 40	4.8	116	141	147	1.6	3	B25690A2227K003*
250	80	12.2	4.1	1.9	≤ 40	3.0	136	121	127	1.9	4	B25690C2257K003*
260	100	18.1	6.0	1.2	≤ 60	3.3	116	176	182	2.0	3	B25690A2267K003
300	80	12.0	4.0	2.1	≤ 40	2.8	136	141	147	2.2	4	B25690C2307K003*
360	100	17.6	5.9	1.4	≤ 90	2.6	116	230	236	2.8	3	B25690A2367K003
360	100	24.2	8.1	1.1	≤ 60	2.5	136	176	182	2.5	4	B25690C2367K003
480	100	24.4	8.1	1.3	≤ 90	2.2	136	230	236	3.5	4	B25690C2487K003
600	100	24.1	8.0	1.4	≤ 90	2.0	136	268	274	3.9	4	B25690C2607K003
750	100	30.9	10.3	1.1	≤ 90	1.8	136	345	351	5.0	4	B25690C2757K003
800	100	32.3	10.8	1.0	≤ 90	1.6	136	370	376	5.5	4	B25690C2807K003

¹ Please refer to current derating section for more details

² ESR at 1 kHz (typical value)

³ H_C is typical value

⁴ Weight is typical value

Other configurations and capacitance tolerances available upon request

*** This ordering code is affected by "Dual Use" regulations according to Export Control law. Deliveries of such products are subject to prior approval by Export Control authorities based on customer declarations. The delivery to certain countries might be restricted.**

$V_{RDC} = 2200 \text{ V DC} / V_{TT} = 3300 \text{ V DC}, 10 \text{ s} / V_{TC} = 5000 \text{ V AC}, 10 \text{ s}$

C_R μF	I_{MAX}^1 A	I_s kA	\hat{I} kA	ESR ² m Ω	L_{self} nH	R_{TH} K/W	\varnothing mm	H_C^3 mm	H_T mm	Weight ⁴ kg	Fig.	Ordering code
90	45	4.0	1.3	3.8	≤40	4.5	85	140	146	1.0	1	B25690A2906K201*
140	80	8.1	2.7	2.0	≤60	3.8	85	230	236	1.4	1	B25690A2147K201
150	70	8.1	2.7	2.3	≤40	4.9	116	121	127	1.4	3	B25690A2157K203*
180	65	8.0	2.7	2.6	≤40	4.8	116	141	147	1.6	3	B25690A2187K203*
200	75	10.9	3.6	2.0	≤40	3.0	136	121	127	1.9	4	B25690C2207K203*
210	100	15.7	5.2	1.2	≤60	3.3	116	176	182	2.0	3	B25690A2217K203
250	75	11.1	3.7	2.2	≤40	2.8	136	141	147	2.2	4	B25690C2257K203*
280	100	16.3	5.4	1.5	≤90	2.6	116	230	236	2.8	3	B25690A2287K203
280	100	22.4	7.5	1.1	≤60	2.5	136	176	182	2.5	4	B25690C2287K203
400	100	21.7	7.2	1.3	≤90	2.2	136	230	236	3.5	4	B25690C2407K203
480	100	22.3	7.4	1.5	≤90	2.0	136	268	274	3.9	4	B25690C2487K203
620	100	27.0	9.0	1.2	≤90	1.8	136	345	351	5.0	4	B25690C2627K203
670	100	28.7	9.6	1.1	≤90	1.6	136	370	376	5.5	4	B25690C2677K203

¹ Please refer to current derating section for more details

² ESR at 1 kHz (typical value)

³ H_C is typical value

⁴ Weight is typical value

Other configurations and capacitance tolerances available upon request

*** This ordering code is affected by "Dual Use" regulations according to Export Control law. Deliveries of such products are subject to prior approval by Export Control authorities based on customer declarations. The delivery to certain countries might be restricted.**

$V_{RDC} = 2400 \text{ V DC} / V_{TT} = 3600 \text{ V DC, 10 s} / V_{TC} = 5000 \text{ V AC, 10 s}$

C_R μF	I_{MAX}^1 A	I_s kA	\hat{I} kA	ESR ² m Ω	L_{self} nH	R_{TH} K/W	\varnothing mm	H_C^3 mm	H_T mm	Weight ⁴ kg	Fig.	Ordering code
75	45	7.8	2.6	4.0	≤40	4.5	85	140	146	1.0	1	B25690A2756K401*
120	75	7.9	2.6	2.1	≤60	3.8	85	230	236	1.4	1	B25690A2127K401
120	65	15.2	5.1	2.4	≤40	4.9	116	121	127	1.4	3	B25690A2127K403*
140	65	15.4	5.1	2.7	≤40	4.8	116	141	147	1.6	3	B25690A2147K403*
160	75	20.8	6.9	2.1	≤40	3.0	136	121	127	1.9	4	B25690C2167K403*
170	100	14.9	5.0	1.3	≤60	3.3	116	176	182	2.0	3	B25690A2177K403
200	75	20.5	6.8	2.3	≤40	2.8	136	141	147	2.2	4	B25690C2207K403*
230	100	20.6	6.9	1.2	≤60	2.5	136	176	182	2.5	4	B25690C2237K403
240	100	14.9	5.0	1.5	≤90	2.6	116	230	236	2.8	3	B25690A2247K403
320	100	20.5	6.8	1.4	≤90	2.2	136	230	236	3.5	4	B25690C2327K403
400	100	50.5	16.8	1.5	≤90	2.0	136	268	274	3.9	4	B25690C2407K403
500	100	49.9	16.6	1.3	≤90	1.8	136	345	351	5.0	4	B25690C2507K403
550	100	52.3	17.4	1.1	≤90	1.6	136	370	376	5.5	4	B25690C2557K403

¹ Please refer to current derating section for more details

² ESR at 1 kHz (typical value)

³ H_C is typical value

⁴ Weight is typical value

Other configurations and capacitance tolerances available upon request

*** This ordering code is affected by "Dual Use" regulations according to Export Control law. Deliveries of such products are subject to prior approval by Export Control authorities based on customer declarations. The delivery to certain countries might be restricted.**

$V_{RDC} = 2600 \text{ V DC} / V_{TT} = 3900 \text{ V DC}, 10 \text{ s} / V_{TC} = 5000 \text{ V AC}, 10 \text{ s}$

C_R μF	I_{MAX}^1 A	I_s kA	\hat{I} kA	ESR ² m Ω	L_{self} nH	R_{TH} K/W	\varnothing mm	H_c^3 mm	H_T mm	Weight ⁴ kg	Fig.	Ordering code
60	40	7.5	2.5	4.2	≤40	4.5	85	140	146	1.0	1	B25690A2606K601*
100	70	7.3	2.4	2.2	≤60	3.8	85	230	236	1.4	1	B25690A2107K601
100	65	13.8	4.6	2.5	≤40	4.9	116	121	127	1.4	3	B25690A2107K603*
120	65	14.3	4.8	2.8	≤40	4.8	116	141	147	1.6	3	B25690A2127K603*
140	100	13.6	4.5	1.3	≤60	3.3	116	176	182	1.9	3	B25690A2147K603
140	75	19.3	6.4	2.1	≤40	3.0	136	121	127	2.0	4	B25690C2147K603*
170	70	18.6	6.2	2.4	≤40	2.8	136	141	147	2.2	4	B25690C2177K603*
200	100	13.8	4.6	1.6	≤90	2.6	116	230	236	2.8	3	B25690A2207K603
200	100	19.1	6.4	1.2	≤60	2.5	136	176	182	2.5	4	B25690C2207K603
270	100	19.0	6.3	1.4	≤90	2.2	136	230	236	3.5	4	B25690C2277K603
330	100	46.9	15.6	1.6	≤90	2.0	136	268	274	3.9	4	B25690C2337K603
420	100	47.9	16.0	1.3	≤90	1.8	136	345	351	5.0	4	B25690C2427K603
460	100	48.0	16.0	1.1	≤90	1.6	136	370	376	5.5	4	B25690C2467K603

¹ Please refer to current derating section for more details

² ESR at 1 kHz (typical value)

³ H_c is typical value

⁴ Weight is typical value

Other configurations and capacitance tolerances available upon request

*** This ordering code is affected by "Dual Use" regulations according to Export Control law. Deliveries of such products are subject to prior approval by Export Control authorities based on customer declarations. The delivery to certain countries might be restricted.**

$V_{RDC} = 2800 \text{ V DC} / V_{TT} = 4200 \text{ V DC}, 10 \text{ s} / V_{TC} = 5000 \text{ V AC}, 10 \text{ s}$

C_R μF	I_{MAX}^1 A	I_s kA	\hat{I} kA	ESR^2 m Ω	L_{self} nH	R_{TH} K/W	\varnothing mm	H_C^3 mm	H_T mm	Weight ⁴ kg	Fig.	Ordering code
55	40	6.7	2.2	4.4	≤40	4.5	85	140	146	1.0	1	B25690A2556K801*
80	70	6.7	2.2	2.3	≤60	3.8	85	230	236	1.4	1	B25690A2806K801
85	65	12.7	4.2	2.6	≤40	4.9	116	121	127	1.4	3	B25690A2856K803*
100	60	12.8	4.3	3.0	≤40	4.8	116	141	147	1.6	3	B25690A2107K803*
120	100	12.4	4.1	1.4	≤60	3.3	116	176	182	1.9	3	B25690A2127K803
120	70	17.2	5.7	2.2	≤40	3.0	136	121	127	2.0	4	B25690C2127K803*
150	70	17.5	5.8	2.5	≤40	2.8	136	141	147	2.2	4	B25690C2157K803*
170	100	12.7	4.2	1.6	≤90	2.6	116	230	236	2.8	3	B25690A2177K803
170	100	17.6	5.9	1.2	≤60	2.5	136	176	182	2.5	4	B25690C2177K803
230	100	17.6	5.9	1.4	≤90	2.2	136	230	236	3.5	4	B25690C2237K803
280	100	43.3	14.4	1.6	≤90	2.0	136	268	274	3.9	4	B25690C2287K803
360	100	44.8	14.9	1.3	≤90	1.8	136	345	351	5.0	4	B25690C2367K803
400	100	43.4	14.5	1.1	≤90	1.6	136	370	376	5.5	4	B25690C2407K803

¹ Please refer to current derating section for more details

² ESR at 1 kHz (typical value)

³ H_C is typical value

⁴ Weight is typical value

Other configurations and capacitance tolerances available upon request

*** This ordering code is affected by "Dual Use" regulations according to Export Control law. Deliveries of such products are subject to prior approval by Export Control authorities based on customer declarations. The delivery to certain countries might be restricted.**

$V_{RDC} = 3000 \text{ V DC} / V_{TT} = 4500 \text{ V DC}, 10 \text{ s} / V_{TC} = 5250 \text{ V AC}, 10 \text{ s}$

C_R	I_{MAX}^1	I_s	\hat{I}	ESR ²	L_{self}	R_{TH}	\varnothing	H_C^3	H_T	Weight ⁴	Fig.	Ordering code
μF	A	kA	kA	m Ω	nH	K/W	mm	mm	mm	kg		
45	40	6.2	2.1	4.7	≤ 40	4.5	85	140	146	1.0	1	B25690A3456K001*
70	70	6.3	2.1	2.4	≤ 60	3.8	85	230	236	1.4	1	B25690A3706K001
75	60	11.9	4.0	2.7	≤ 40	4.9	116	121	127	1.4	3	B25690A3756K003*
90	60	11.6	3.9	3.0	≤ 40	4.8	116	141	147	1.6	3	B25690A3906K003*
100	95	11.7	3.9	1.4	≤ 60	3.3	116	176	182	1.9	3	B25690A3107K003
100	70	16.1	5.4	2.3	≤ 40	3.0	136	121	127	2.0	4	B25690C3107K003*
120	70	15.9	5.3	2.6	≤ 40	2.8	136	141	147	2.2	4	B25690C3127K003*
140	95	11.7	3.9	1.7	≤ 90	2.6	116	230	236	2.8	3	B25690A3147K003
140	100	16.2	5.4	1.3	≤ 60	2.5	136	176	182	2.5	4	B25690C3147K003
200	100	16.1	5.4	1.5	≤ 90	2.2	136	230	236	3.5	4	B25690C3207K003
240	100	40.2	13.4	1.7	≤ 90	2.0	136	268	274	3.9	4	B25690C3247K003
320	100	40.7	13.6	1.3	≤ 90	1.8	136	345	351	5.0	4	B25690C3327K003
330	100	41.2	13.7	1.1	≤ 90	1.6	136	370	376	5.5	4	B25690C3337K003

¹ Please refer to current derating section for more details

² ESR at 1 kHz (typical value)

³ H_C is typical value

⁴ Weight is typical value

Other configurations and capacitance tolerances available upon request

*** This ordering code is affected by "Dual Use" regulations according to Export Control law. Deliveries of such products are subject to prior approval by Export Control authorities based on customer declarations. The delivery to certain countries might be restricted.**

Display of ordering codes for TDK Electronics products

The ordering code for one and the same product can be represented differently in data sheets, data books, other publications, on the company website, or in order-related documents such as shipping notes, order confirmations and product labels. **The varying representations of the ordering codes are due to different processes employed and do not affect the specifications of the respective products.** Detailed information can be found on the Internet under www.tdk-electronics.tdk.com/orderingcodes.

2. Current derating

2.1 Current derating graphs for capacitors $V_{RDC}=700 V_{DC}$

B25690A0487K701

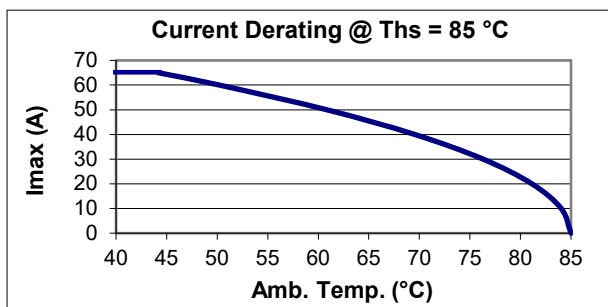

B25690A0687K701

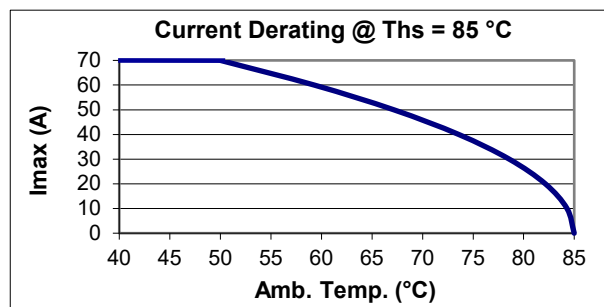

B25690A0787K701

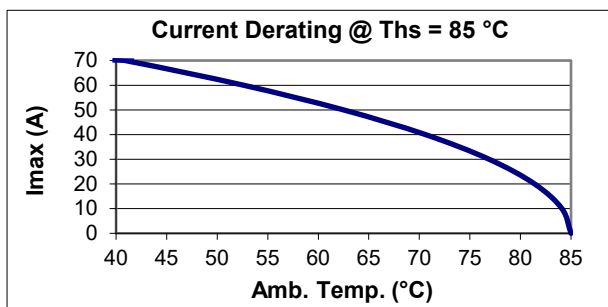

B25690A0108K701

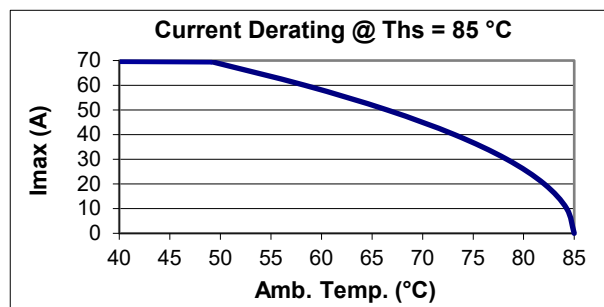

B25690A0148K701

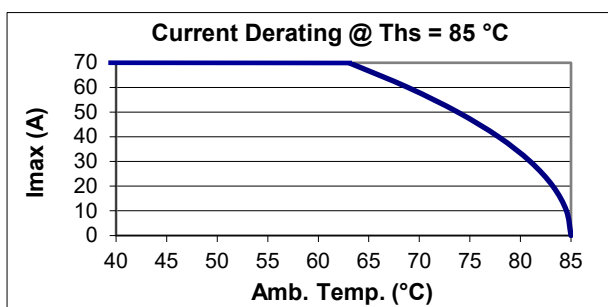

B25690A0158K703

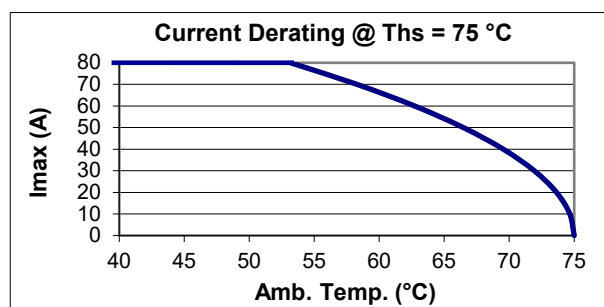

B25690A0258K703

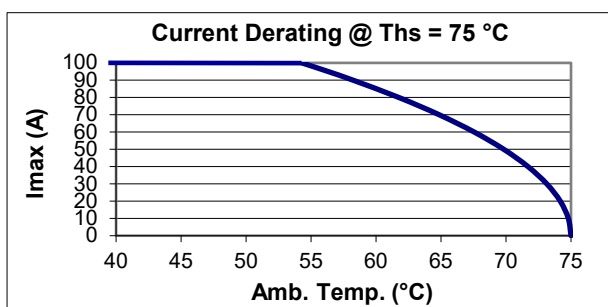

B25690C0448K703

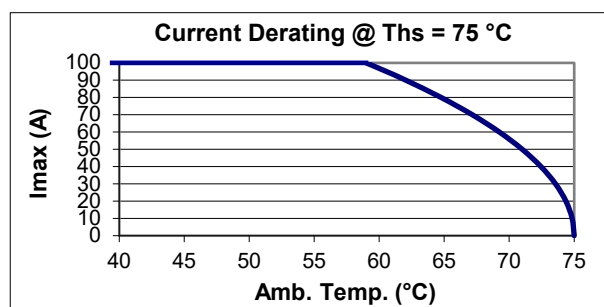

2.2 Current derating graphs for capacitors $V_{RDC}=900 V_{DC}$

B25690A0387K901

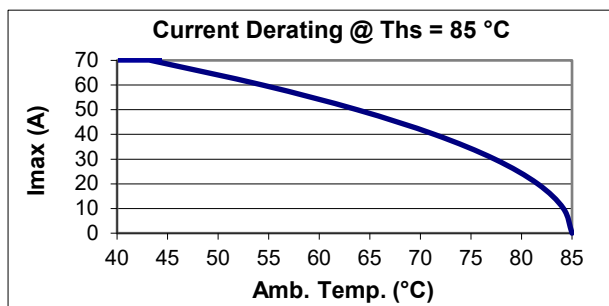

B25690A0577K901

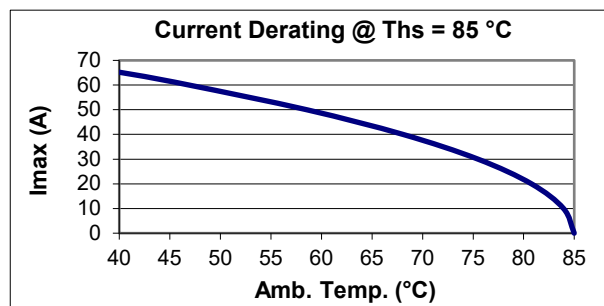

B25690A0607K901

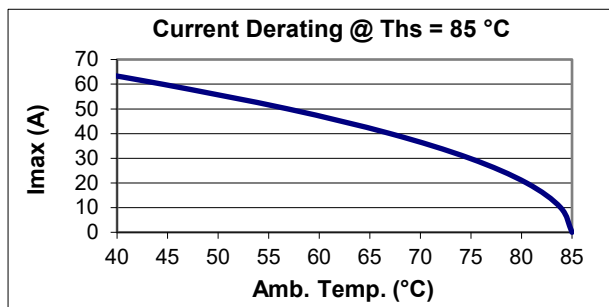

B25690A0727K903

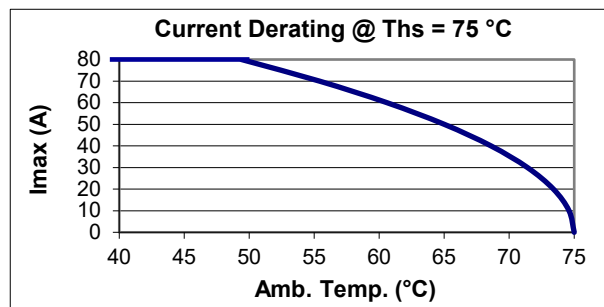

B25690A0737K901

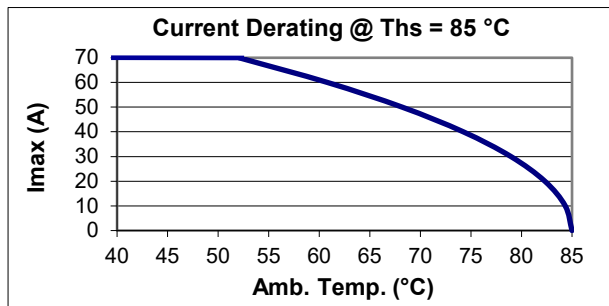

B25690A0857K901

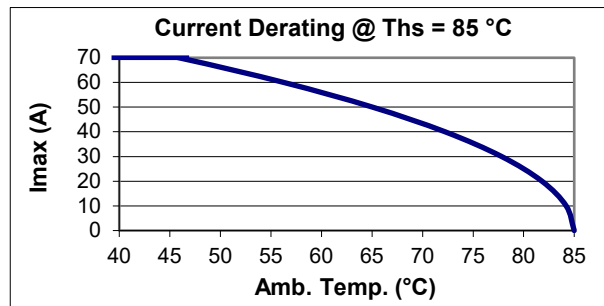

B25690A0128K903

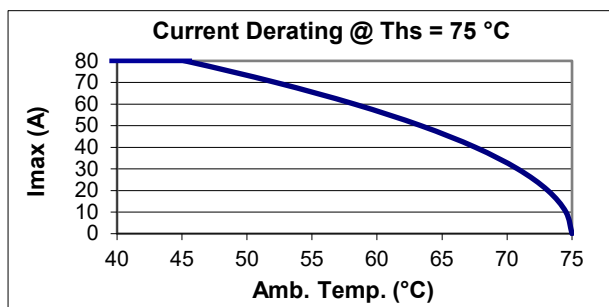

B25690A0148K903

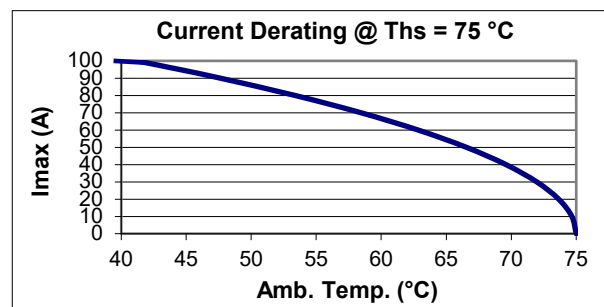

2.3 Current derating graphs for capacitors $V_{RDC}=1100 V_{DC}$

B25690A1257K101

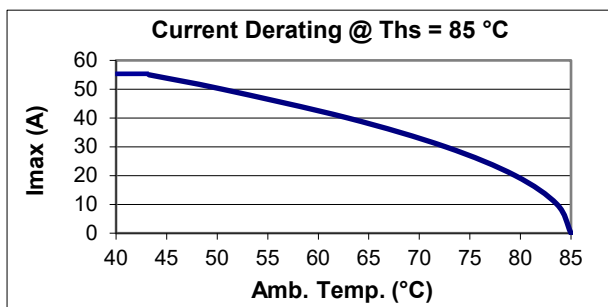

B25690A1307K101

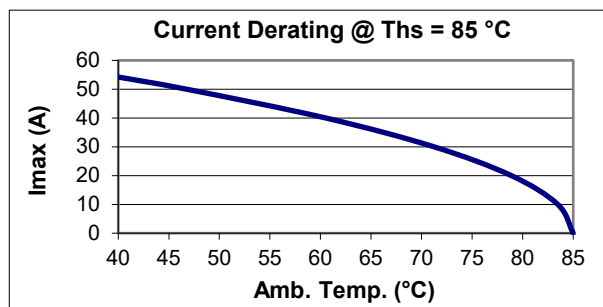

B25690A1457K101

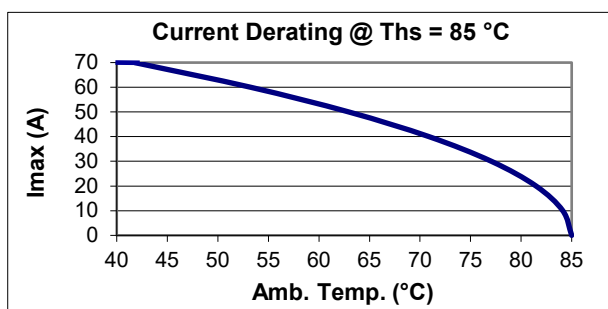

B25690A1477K103

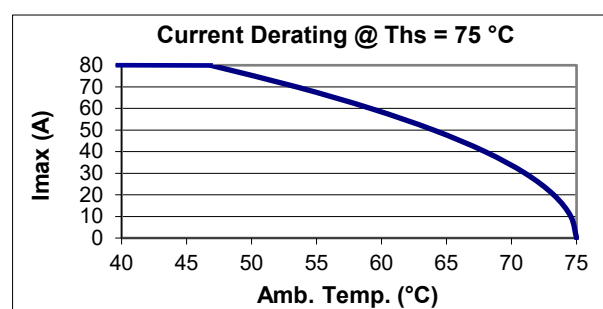

B25690A1487K101

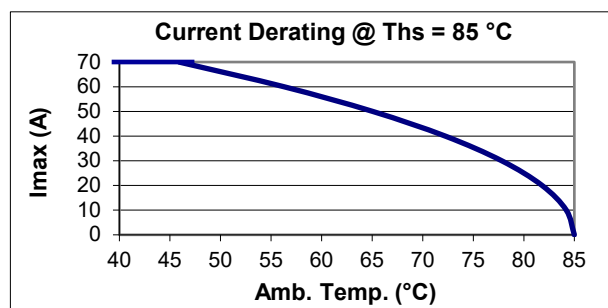

B25690A1907K103

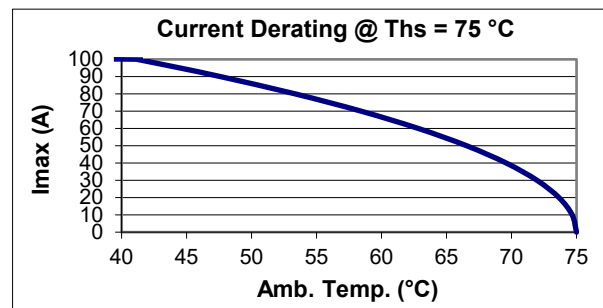

B25690A1128K103

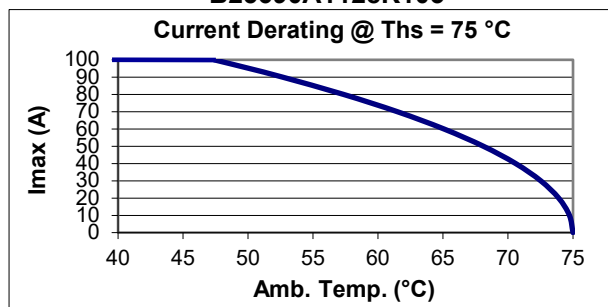

2.4 Current derating graphs for capacitors $V_{RDC}=1200 V_{DC}$

B25690A1197K201

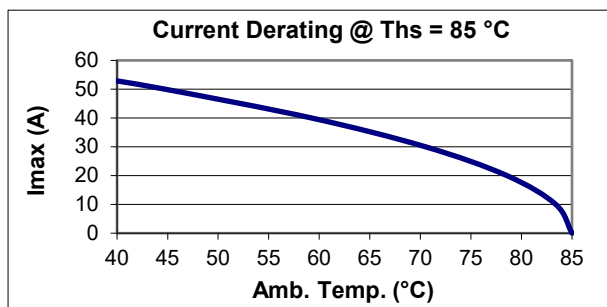

B25690A1267K201

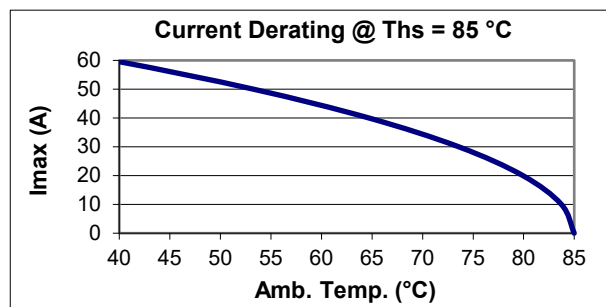

B25690A1277K211

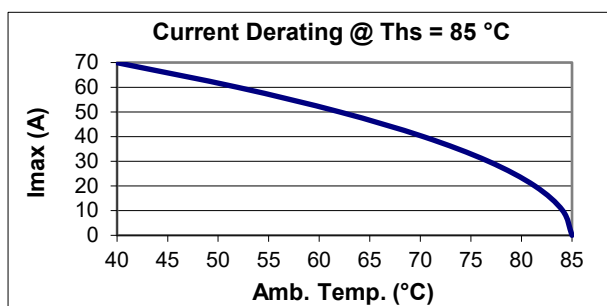

B25690A1507K203

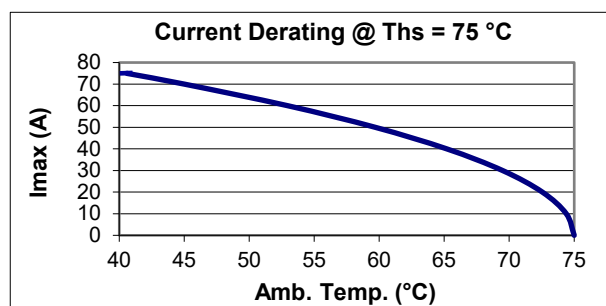

B25690A1627K203

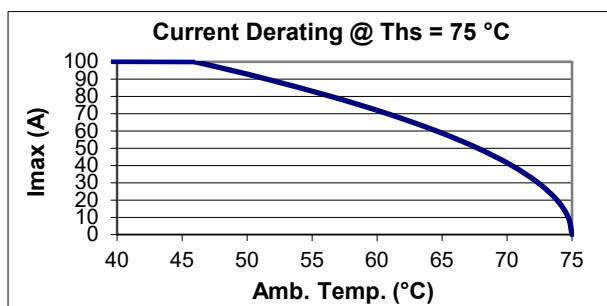

B25690A1108K203

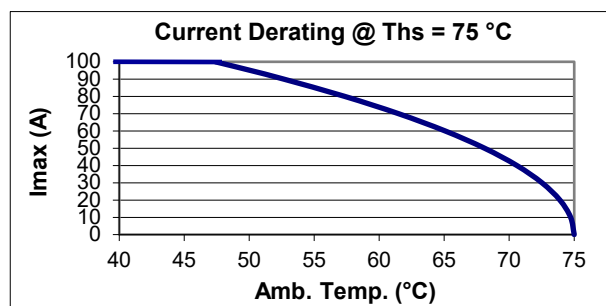

3. Service life expectancy

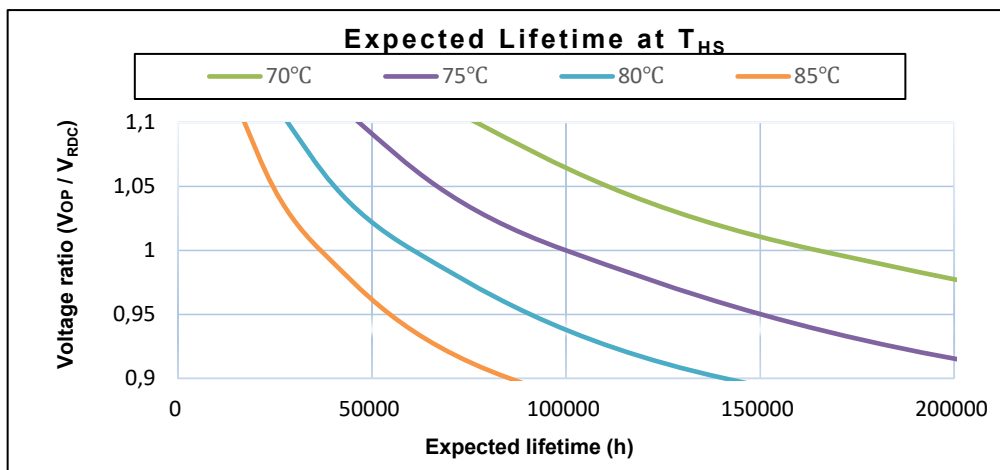

Service life t_{LD} in hours at different hotspot temperature (T_{hs}) and voltage V_{RDC} for $\varnothing \leq 116$ mm

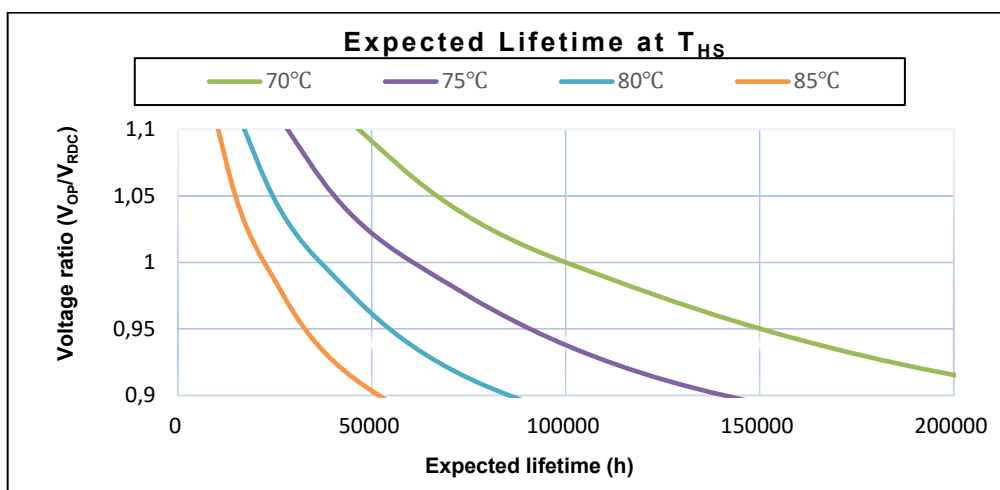

Service life t_{LD} in hours at different hotspot temperature (T_{hs}) and voltage V_{RDC} for $\varnothing = 136$ mm

For capacitors with diameter 116mm a maximum hot spot temperature of 85°C or capacitor with diameter 136 mm a maximum hot spot temperature of 80°C is allowed during short term operation (maximum 10% of the total load duration) without further reduction of the service life.

Failure criteria is capacitance drop higher than 3%.

Lifetime estimations are typical theoretical values derived from lifetime tests based on TDK internal standards or mutually agreed test methods and are intended for guidance purposes only. The useful life does not constitute a warranty of any kind or a prolongation of the agreed warranty period.

4. Expected failure rate

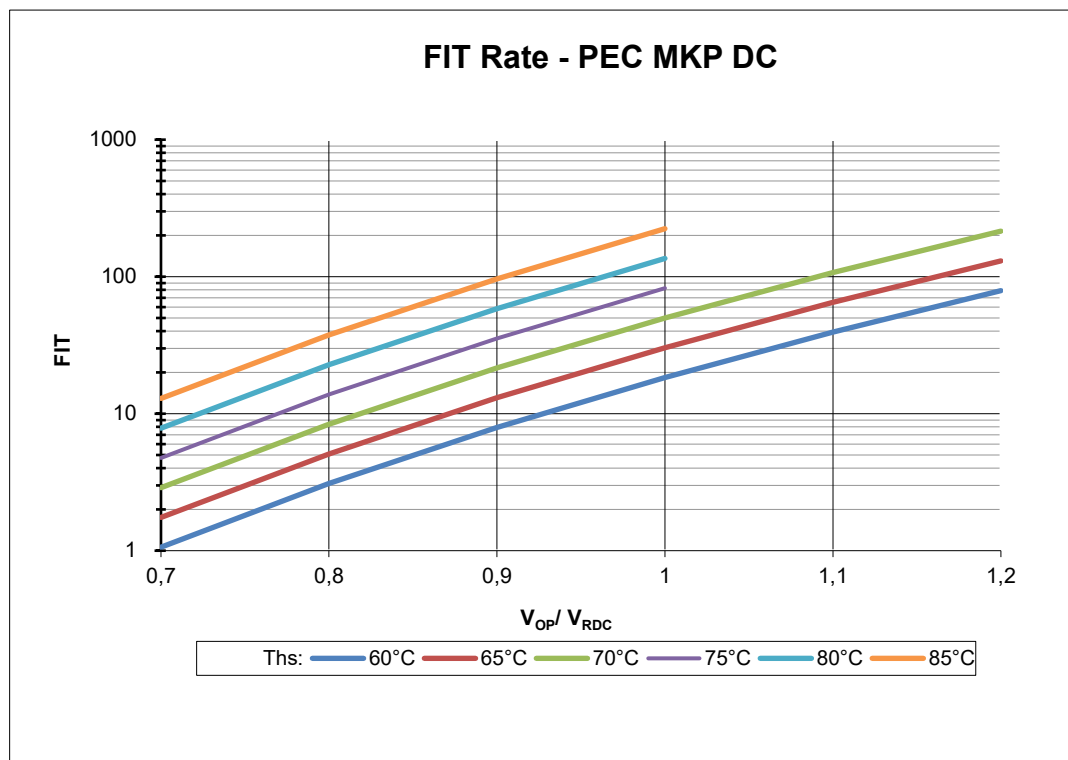

Expected fit rate at different hot spot temperatures (T_{hs}) and voltage V_{RDC}

The FIT (Failure In Time) of a component is defined as the number of expected failures in 10⁹ hours of operation. The FIT rate is calculated on the basis of the number of components operating in the field and the estimated hours of operation. All the reports of failures are taken into consideration for this calculation, which is updated every year.

The other values in the graph are given as indication and calculated based on acceleration factors.

Cautions and warnings

- In case of dents of more than 1 mm depth or any other mechanical damage, capacitors must not be used at all.
- The energy stored in capacitors may be lethal. To prevent any chance of shock, discharge and short-circuit the capacitor before handling.
- Failure to follow cautions may result, worst case, in premature failures, bursting and fire.
- Protect the capacitor properly against over current and short circuit.
- TDK Electronics is not responsible for any kind of possible damages to persons or things due to improper installation and application of capacitors for power electronics.

General safety notes for installation and operation

Electrical or mechanical misapplication of capacitors may be hazardous. Personal injury or property damage may result from bursting of the capacitor or from expulsion melted material due to mechanical disruption of the capacitor.

- Ensure good, effective grounding for capacitor enclosures.
- Observe appropriate safety precautions during operation (self-recharging phenomena and the high energy contained in capacitors).
- Handle capacitors carefully, because they may still be charged even after disconnection.
- The terminals of capacitors, connected bus bars and cables as well as other devices may also be energized.
- Follow good engineering practice.

Thermal load

After installation of the capacitor it is necessary to verify that maximum hot-spot temperature is not exceeded at extreme service conditions.

Installation

Capacitors must be installed in a cool and well ventilated place, and not close to objects that radiate heat, or in the direct sunlight. Within high-power inverter systems the capacitors usually produce the smallest portion of the total losses, and the permissible operating temperatures are low compared to power semiconductors, reactors and resistors. So, the distance between capacitor and heating sources must be large enough to avoid the capacitor overheating. In case of space constraint to make the best possible use of capacitors, technically and economically, it is advisable to supply forced cooling air.

Mechanical protection

The capacitor has to be installed in a way that mechanical damages and dents in the aluminum can are avoided.

Connecting

Ensure firm fixing of terminals, fixing torque to be applied as per individual specification. In any case, the maximum specified terminal current may not be exceeded. Please refer to the technical data of the specific series.

Grounding

The threaded bottom stud of the capacitor has to be used for grounding. In case grounding is done via metal chassis that the capacitor is mounted to, the layer of varnish beneath the washer and nut should be removed. The maximum tightening torque is 10 Nm.

Maintenance

Disregarding the following measures may result in severe operation failures, bursting and fire:

- Check tightness of the connections/terminals periodically, two weeks after installation at the latest, and then once every 6 months.
- Clean the terminals/bushings periodically to avoid short circuits due dust or other contamination.
- Take current reading twice a year and compare with nominal current. Use a harmonic analyser or true effective RMS-meter.
- In case of a current above the nominal current check your application for modification.
- Check the temperature of energized capacitors. In case of excessive temperature of individual capacitors, it is recommended to replace this capacitor, as this could be an indication for loss factor increase, which is a sign for reaching end of life.
- When power capacitors are used, suitable measures must always be taken to eliminate possible danger to humans, animals and property both during operation and when a failure occurs. This applies to capacitors both with and without protective devices. Regular inspection and maintenance by a competent person is therefore essential.

Storage and operating conditions

Do not use or store capacitors in corrosive atmosphere, especially where chloride gas, sulfide gas, acid, alkali, salt or the like are present. In dusty environments regular maintenance and cleaning especially of the terminals is required to avoid conductive path between phases and/or phases and ground.

Service life expectancy

Electrical components do not have an unlimited service life expectancy; this applies to self-healing capacitors, too. The maximum service life expectancy may vary depending on the application the capacitor is used in.

Handling

Discharge and short circuit the capacitor before handling! When handling the capacitor, do not take the capacitor from the terminal. This can cause accident in case the capacitor is charged, terminal break and capacitance loss due to capacitor is heavy.

Important notes

The following applies to all products named in this publication:

1. Some parts of this publication contain **statements about the suitability of our products for certain areas of application**. These statements are based on our knowledge of typical requirements that are often placed on our products in the areas of application concerned. We nevertheless expressly point out **that such statements cannot be regarded as binding statements about the suitability of our products for a particular customer application**. As a rule we are either unfamiliar with individual customer applications or less familiar with them than the customers themselves. For these reasons, it is always ultimately incumbent on the customer to check and decide whether a product with the properties described in the product specification is suitable for use in a particular customer application.
2. We also point out that **in individual cases, a malfunction of electronic components or failure before the end of their usual service life cannot be completely ruled out in the current state of the art, even if they are operated as specified**. In customer applications requiring a very high level of operational safety and especially in customer applications in which the malfunction or failure of an electronic component could endanger human life or health (e.g. in accident prevention or life-saving systems), it must therefore be ensured by means of suitable design of the customer application or other action taken by the customer (e.g. installation of protective circuitry or redundancy) that no injury or damage is sustained by third parties in the event of malfunction or failure of an electronic component.
3. **The warnings, cautions and product-specific notes must be observed.**
4. In order to satisfy certain technical requirements, **some of the products described in this publication may contain substances subject to restrictions in certain jurisdictions (e.g. because they are classed as hazardous)**. Useful information on this will be found in our Material Data Sheets on the Internet (www.tdk-electronics.tdk.com/material). Should you have any more detailed questions, please contact our sales offices.
5. We constantly strive to improve our products. Consequently, **the products described in this publication may change from time to time**. The same is true of the corresponding product specifications. Please check therefore to what extent product descriptions and specifications contained in this publication are still applicable before or when you place an order.

We also **reserve the right to discontinue production and delivery of products**. Consequently, we cannot guarantee that all products named in this publication will always be available. The aforementioned does not apply in the case of individual agreements deviating from the foregoing for customer-specific products.

6. Unless otherwise agreed in individual contracts, **all orders are subject to our General Terms and Conditions of Supply**.
7. **Our manufacturing sites serving the automotive business apply the IATF 16949 standard**. The IATF certifications confirm our compliance with requirements regarding the quality management system in the automotive industry. Referring to customer requirements and customer specific requirements ("CSR") TDK always has and will continue to have the policy of respecting individual agreements. Even if IATF 16949 may appear to support the acceptance of unilateral requirements, we hereby like to emphasize that **only requirements mutually agreed upon can and will be implemented in our Quality Management System**. For clarification purposes we like to point out that obligations from IATF 16949 shall only become legally binding if individually agreed upon.

Important notes

8. The trade names EPCOS, CarXield, CeraCharge, CeraDiode, CeraLink, CeraPad, CeraPlas, CSMP, CTVS, DeltaCap, DigiSiMic, ExoCore, FilterCap, FormFit, LeaXield, MiniBlue, MiniCell, MKD, MKK, ModCap, MotorCap, PCC, PhaseCap, PhaseCube, PhaseMod, PhiCap, PowerHap, PQSine, PQvar, SIFERRIT, SIFI, SIKOREL, SilverCap, SIMDAD, SiMic, SIMID, SineFormer, SIOV, ThermoFuse, WindCap, XieldCap are **trademarks registered or pending** in Europe and in other countries. Further information will be found on the Internet at www.tdk-electronics.tdk.com/trademarks.

Release 2020-06