

THIS DOCUMENT IS SUBJECT TO CHANGE WITHOUT NOTICE. IT IS CONFIDENTIAL AND A PROPERTY OF AMPHENOL LTW. DISCLOSURE TO THIRD PARTY HAS TO BE AUTHORIZED BY AMPHENOL LTW.

REV.	ECN NO.	DATE	SIGN	DESCRIPTION
A		2020/12/31	Wen	Rev.03 to Rev.A

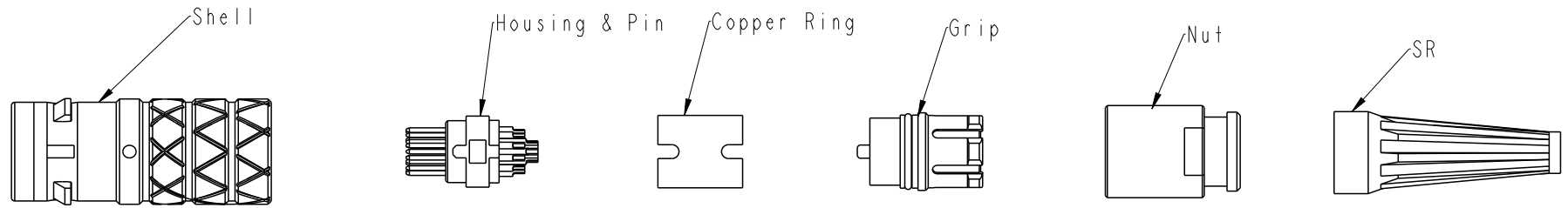
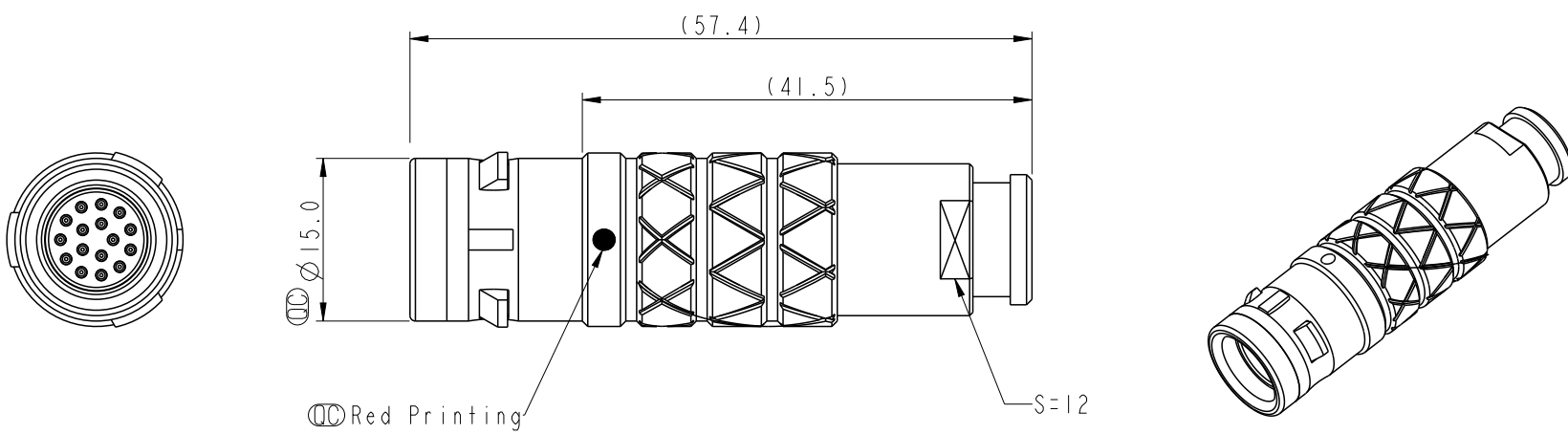

- Notes:
- * $\text{\textcircled{C}}$ Important Dimensions To Check
 - * Waterproof Rate: IP68. (Mated)
 - * Shell: Metal
 - * Housing: Thermoplastic, Black
 - * Pin: Copper Alloy, Gold Plated.
 - * Copper Ring: Metal
 - * Grip: Metal
 - * Seal & O-Ring: Rubber, Gray
 - * Nut: Metal
 - * SR: Thermoplastic, Black
 - * One Set Assembled In One PE Bag(small)
 - * 20 Sets In One PE Bag(BIG)

UNIT:mm			TITLE FLO D SIZE, G CODE, FI CONNECTOR
TOLERANCE $\pm 0.5\text{mm}$	SCALE 1:1	SIZE A4	SHEET 1 OF 2
REV. A	WC-REV. .0	$\text{\textcircled{C}}$: Inspection item	

Amphenol LTW
安費諾亮泰企業股份有限公司

ITEM NO	DRAWN BY Wen	DATE 2020/12/31
DWG NO SLKD-XXFGMS-GCP-XXX	CHECKED BY Neo	DATE 2020/12/31
CUSTOMER ALTW	APPROVED BY Max	DATE 2020/12/31

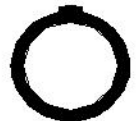

THIS DOCUMENT IS SUBJECT TO CHANGE WITHOUT NOTICE. IT IS CONFIDENTIAL AND A PROPERTY OF AMPHENOL LTW. DISCLOSURE TO THIRD PARTY HAS TO BE AUTHORIZED BY AMPHENOL LTW.

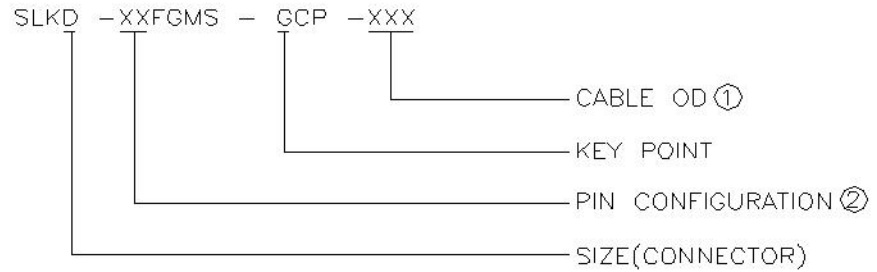
KEY POINT	
CODE	G
GRAPHIC	

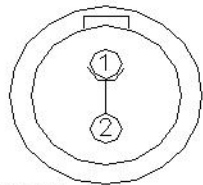
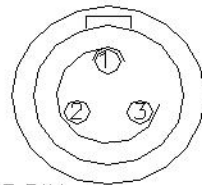
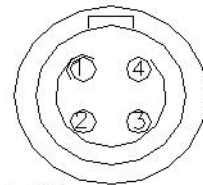
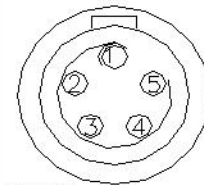
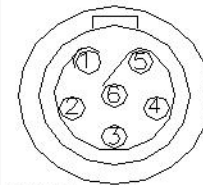
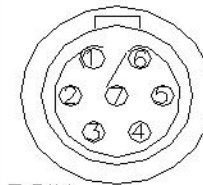
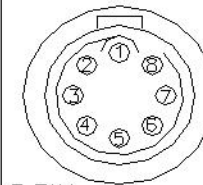
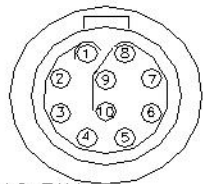
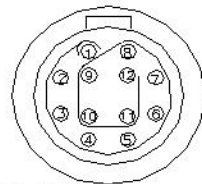
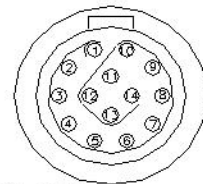
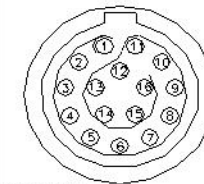
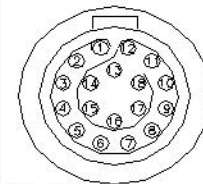
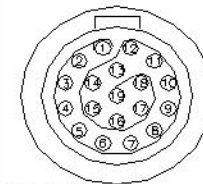
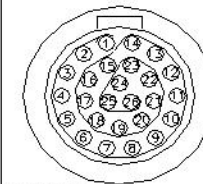

2K-SERIES CABLE COLLET(CABLE OD)			
CABLE CLAMP SET		CABLE DIA RANGE	
TYPE	CODE ①	MAX	MIN
SLKD-XXFGMS-GCP-XXX	226	7.6	6.5
	227	8.7	7.7
	--	--	--
	--	--	--

PIN CONFIGURATION (Solder Definition) ②							
GRAPHIC							
	2 PIN	3 PIN	4 PIN	5 PIN	6 PIN	7 PIN	8 PIN
GRAPHIC							
	10 PIN	12 PIN	14 PIN	16 PIN	18 PIN	19 PIN	26 PIN

UNIT:mm			TITLE FLO D SIZE, G CODE, FI CONNECTOR
TOLERANCE ±0.5mm	SCALE 1:1	SIZE A4	SHEET 2 OF 2
	REV. A	WC-REV. .0	QC: Inspection item

Amphenol LTW
安費諾亮泰企業股份有限公司

ITEM NO	DRAWN BY Wen	DATE 2020/12/31
DWG NO SLKD-XXFGMS-GCP-XXX	CHECKED BY Neo	DATE 2020/12/31
CUSTOMER ALTW	APPROVED BY Max	DATE 2020/12/31