

### Features

- \* Ultra bright AllnGaP Chip LED.
- \* Package in 8mm tape on 7" diameter reels.
- \* Compatible with automatic placement equipment.
- \* Compatible with infrared and vapor phase reflow solder process.
- \* EIA STD package.
- \* I.C. compatible.

### Package Dimensions

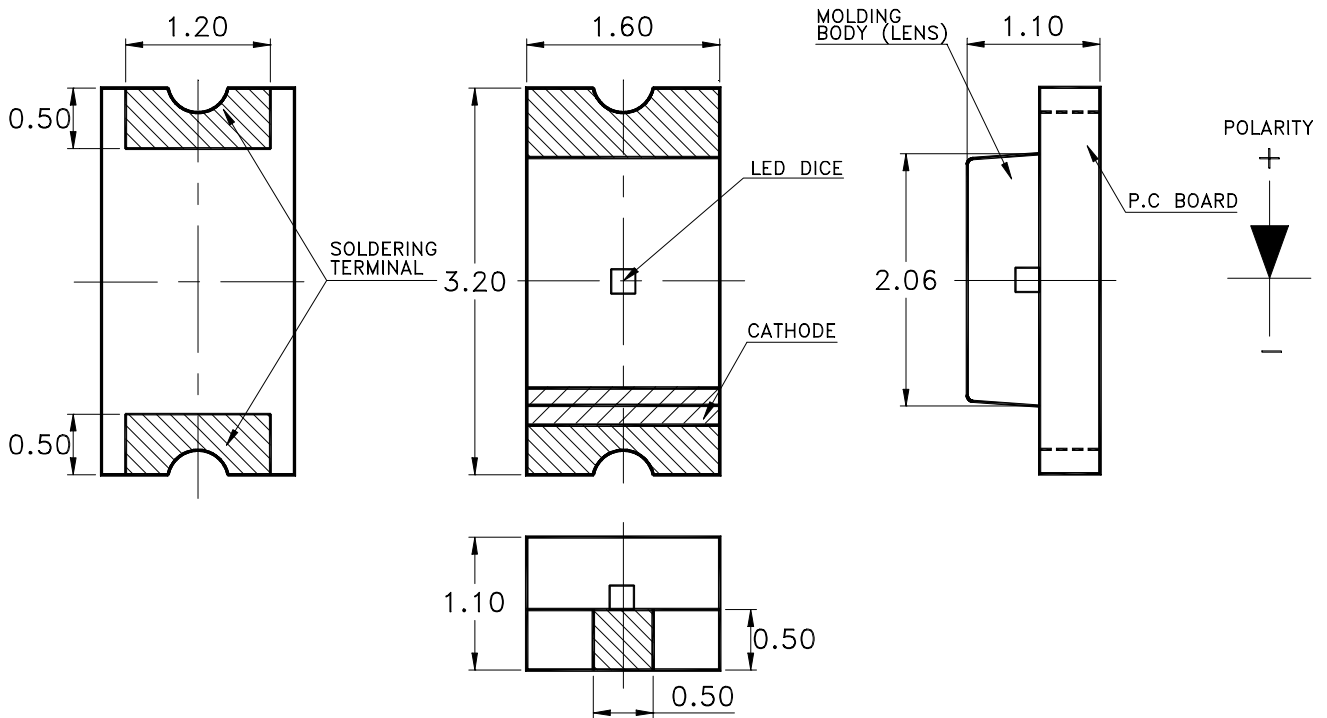

Part No.	Lens	Source Color
LTST-C150KYKT	Water Clear	AllnGaP Amber Yellow

### Notes:

1. All dimensions are in millimeters (inches).
2. Tolerance is  $\pm 0.1\text{mm}$  (.004") unless otherwise noted.



# LITE-ON ELECTRONICS, INC.

Property of Lite-On Only

## Absolute Maximum Ratings At Ta= 25°C

Parameter	LTST-C150KYKT	Unit
Power Dissipation	75	mW
Peak Forward Current (1/10 Duty Cycle, 0.1ms Pulse Width)	80	mA
Continuous Forward Current	30	mA
Derating Linear From 25°C	0.4	mA/°C
Reverse Voltage	5	V
Operating Temperature Range	-55°C to + 85°C	
Storage Temperature Range	-55°C to + 85°C	
Wave Soldering Condition	260°C For 5 Seconds	
Infrared Soldering Condition	260°C For 5 Seconds	
Vapor Phase Soldering Condition	215°C For 3 Minutes	

Suggest IR Reflow Condition :

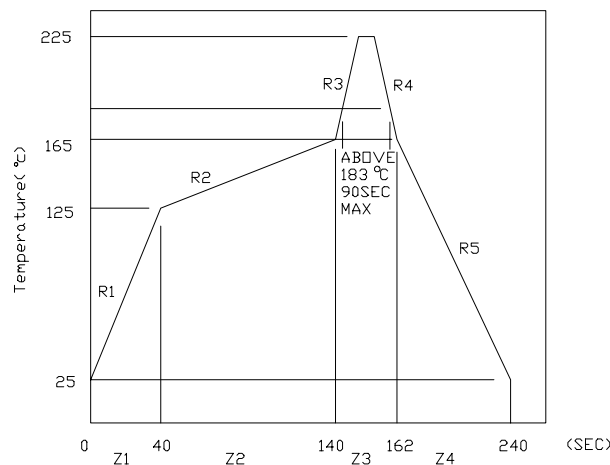



# LITE-ON ELECTRONICS, INC.

Property of Lite-On Only

## Electrical Optical Characteristics At Ta= 25°C

Parameter	Symbol	Part No. LTST-	Min.	Typ.	Max.	Unit	Test Condition
Luminous Intensity	IV	C150KYKT	30.0	50.0		mcd	IF = 20mA Note 1
Viewing Angle	$2\theta_{1/2}$	C150KYKT		130		deg	Note 2 (Fig.6)
Peak Emission Wavelength	$\lambda_P$	C150KYKT		595		nm	Measurement @Peak (Fig.1)
Dominant Wavelength	$\lambda_d$	C150KYKT		592		nm	Note 3
Spectral Line Half-Width	$\Delta\lambda$	C150KYKT		16		nm	
Forward Voltage	VF	C150KYKT		2.0	2.4	V	IF = 20mA
Reverse Current	IR	C150KYKT			100	$\mu A$	VR = 5V
Capacitance	C	C150KYKT		40		PF	VF = 0 f = 1MHZ

Notes: 1. Luminous intensity is measured with a light sensor and filter combination that approximates the CIE eye-response curve.

2.  $\theta_{1/2}$  is the off-axis angle at which the luminous intensity is half the axial luminous intensity.

3. The dominant wavelength,  $\lambda_d$  is derived from the CIE chromaticity diagram and represents the single wavelength which defines the color of the device.

Property of Lite-On Only

## Typical Electrical / Optical Characteristics Curves

(25 °C Ambient Temperature Unless Otherwise Noted)

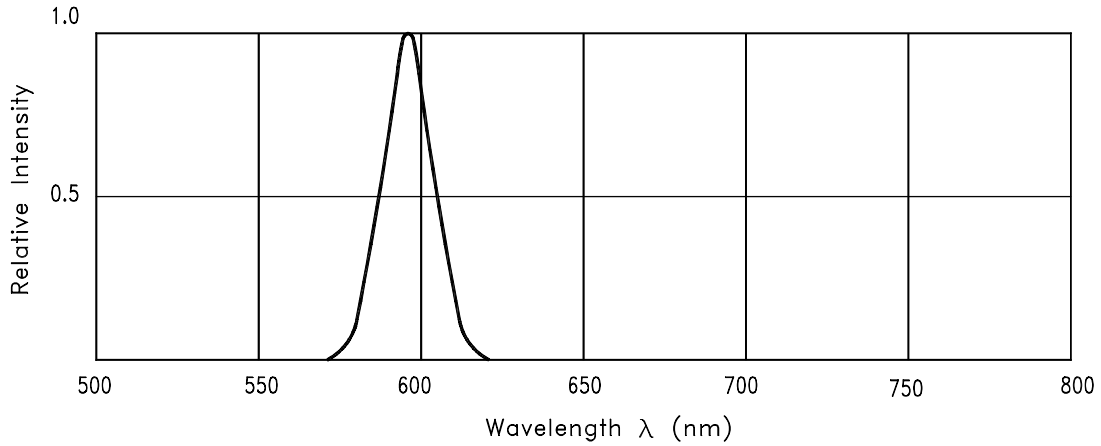

Fig.1 RELATIVE INTENSITY VS. WAVELENGTH

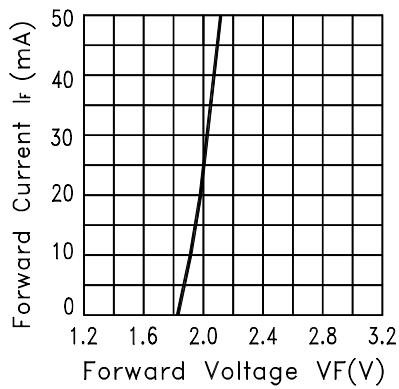

Fig.2 FORWARD CURRENT VS. FORWARD VOLTAGE

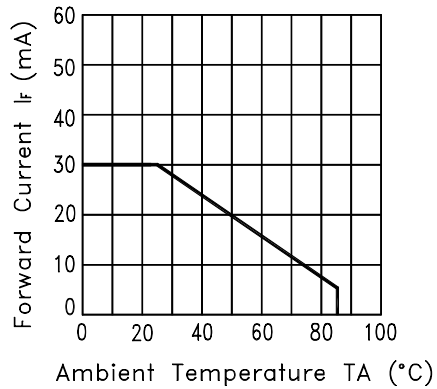

Fig.3 FORWARD CURRENT DERATING CURVE

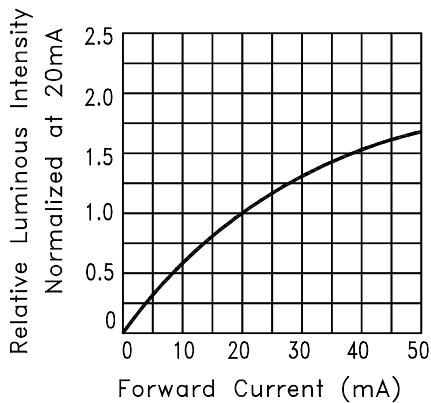

Fig.4 RELATIVE LUMINOUS INTENSITY VS. FORWARD CURRENT

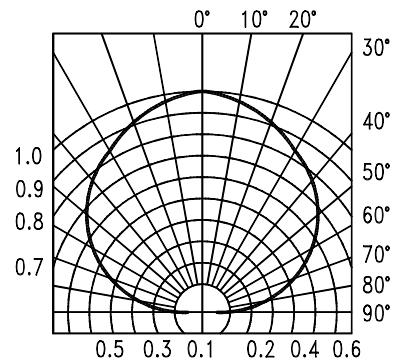

Fig.6 SPATIAL DISTRIBUTION

Property of Lite-On Only

### Cleaning

Do not use unspecified chemical liquid to clean LED they could harm the package.  
 If clean is necessary, immerse the LED in ethyl alcohol or in isopropyl alcohol at normal temperature for less one minute.

### Suggest Soldering Pad Dimensions

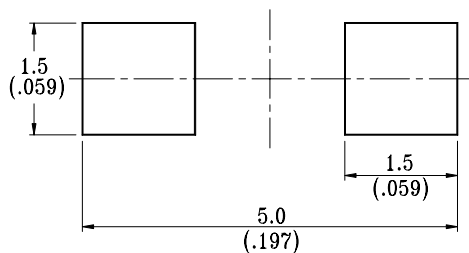

### Package Dimensions Of Tape And Reel

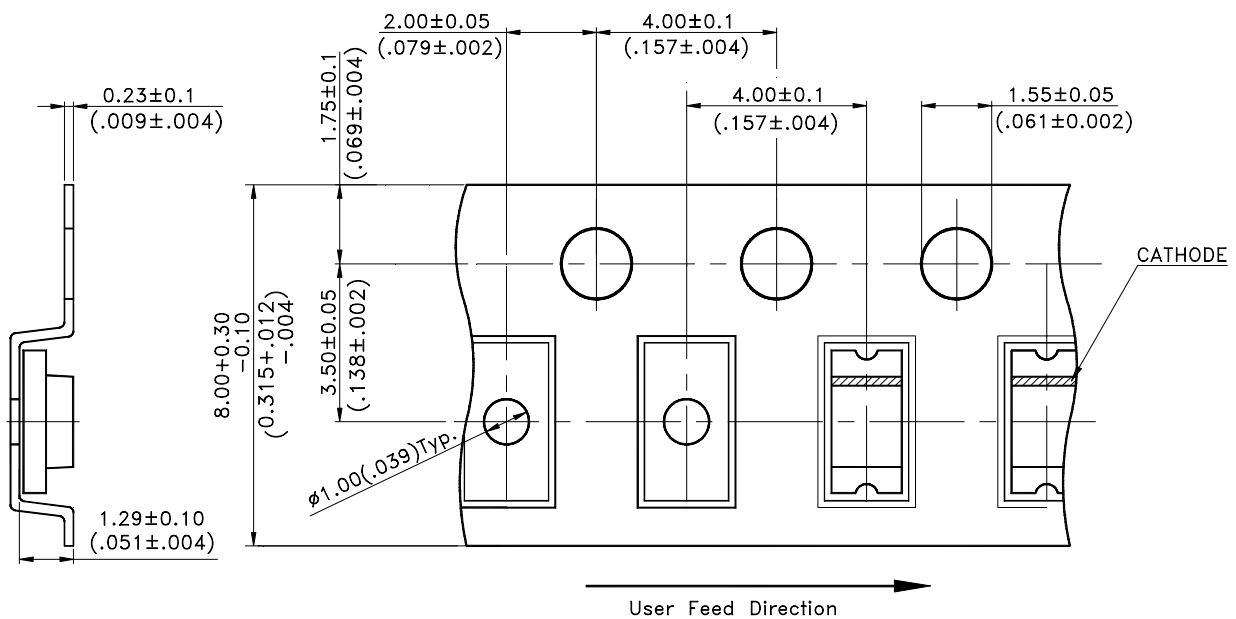

### Notes:

1. All dimensions are in millimeters (inches).

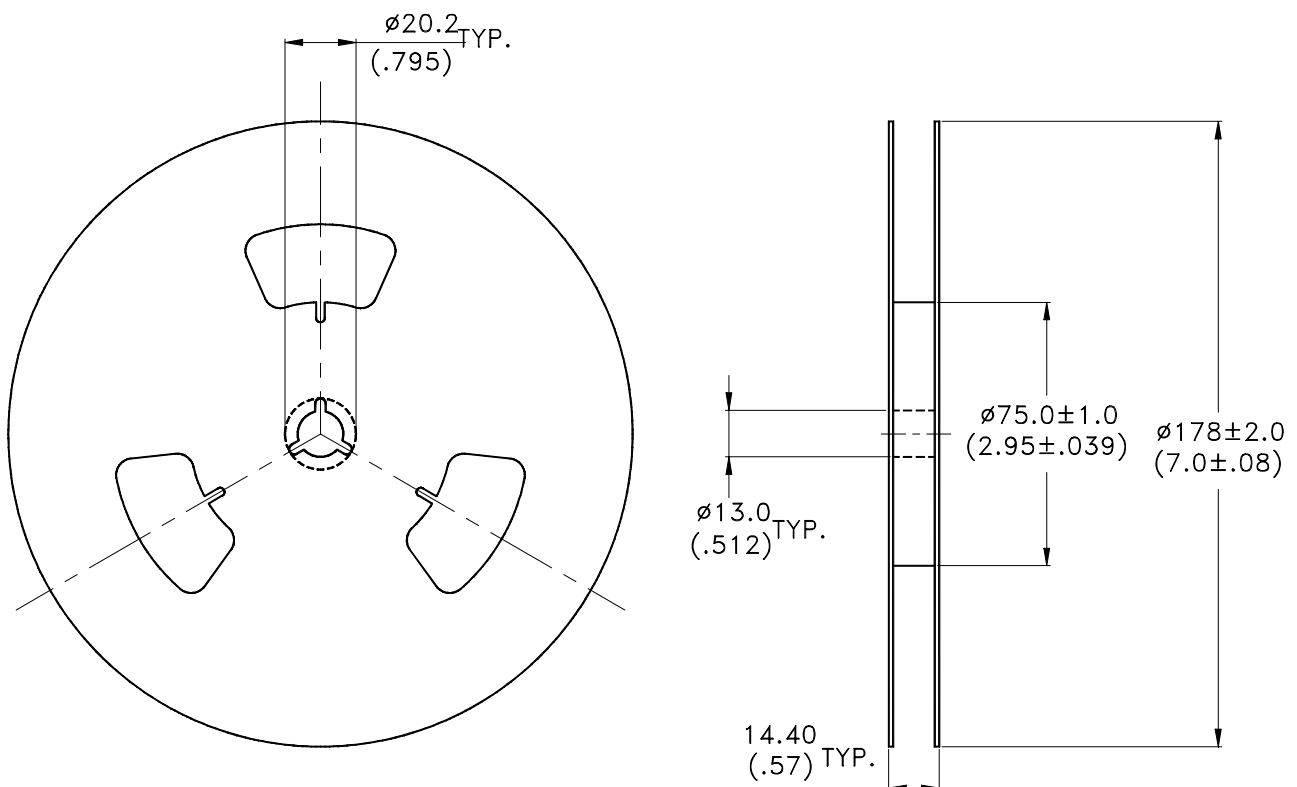

## Notes:

1. Empty component pockets sealed with top cover tape.
2. 7 inch reel-3000 pieces per reel.
3. The maximum number of consecutive missing lamps is two.
4. In accordance with ANSI/EIA 481-1-A-1994 specifications.