

HiTemp ET Series Thermoelectric Cooler

Note: This product is not recommended for new designs.
 This product series has been replaced with the HiTemp ETX Series.
 The recommended replacement is:
 Description: OTX19-35-F1N-0612-GG-W2.25

Features

- High-temperature operation
- Reliable solid-state
- No sound or vibration
- Environmentally-friendly
- RoHS-compliant

Applications

- Peltier Cooling for Refrigerated Centrifuges
- Peltier Cooling for Machine Vision
- Thermoelectric Cooling for CMOS Sensors
- Cooling Solutions for Autonomous Systems
- Peltier Cooling for Digital
- Light Processors

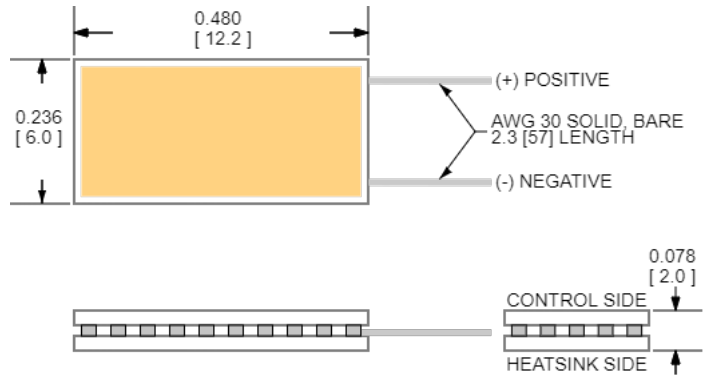
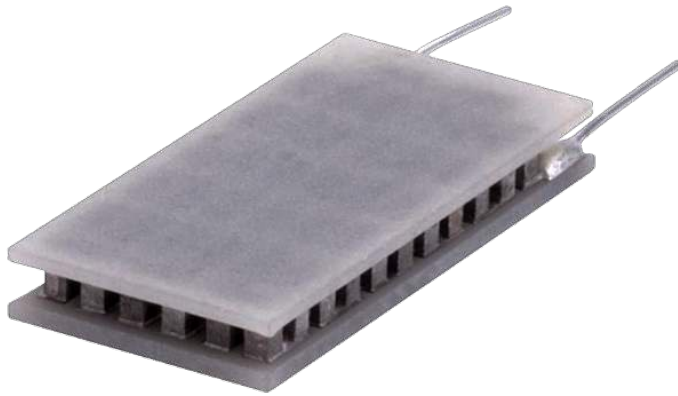

CERAMIC MATERIAL: AlN
 SOLDER CONSTRUCTION: 232°C, SbSn

INCHES [MM]

ELECTRICAL AND THERMAL PERFORMANCE

For maximum performance, be sure to orient the CONTROL side of the TEC against the application to be managed and the HEATSINK side against the heat sink or other heat rejection method. The CONTROL side is always opposite the side with lead attachments. Lead attachment is a passive heat loss and less impactful if located on the side that attaches to the heat exchanger.

Heat Pumped at Cold Side
 $T_{hot} = 85\text{ }^{\circ}\text{C}$

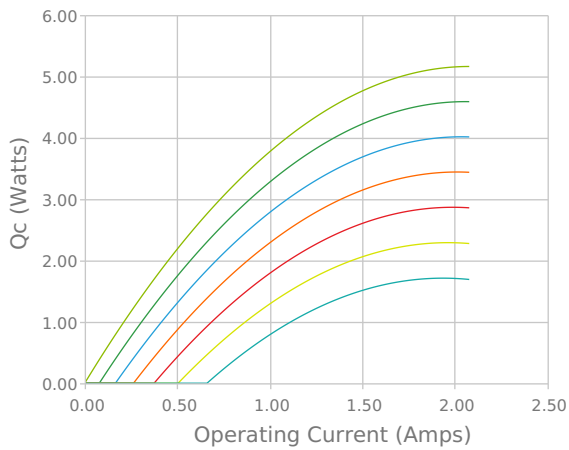

Heat Pumped at Cold Side
 $T_{hot} = 85\text{ }^{\circ}\text{C}$

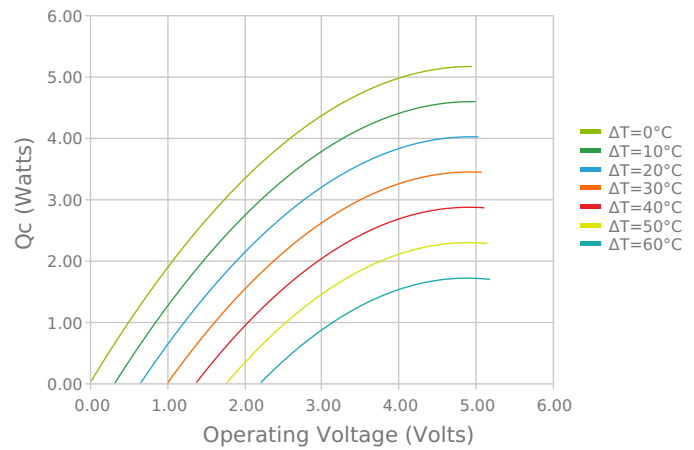

Current vs Voltage (I vs V)
 $T_{hot} = 85\text{ }^{\circ}\text{C}$

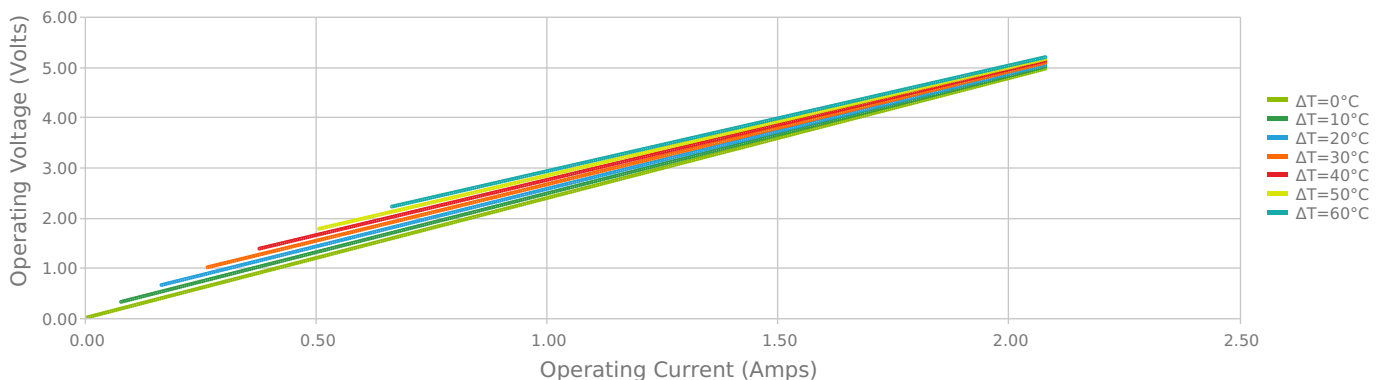

Coefficient of Performance (COP = Qc/Pin)
Thot = 85 °C

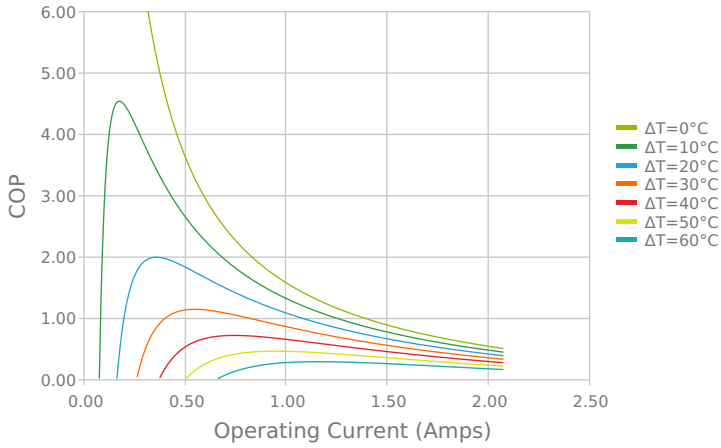

Coefficient of Performance (COP = Qc/Pin)
Thot = 85 °C

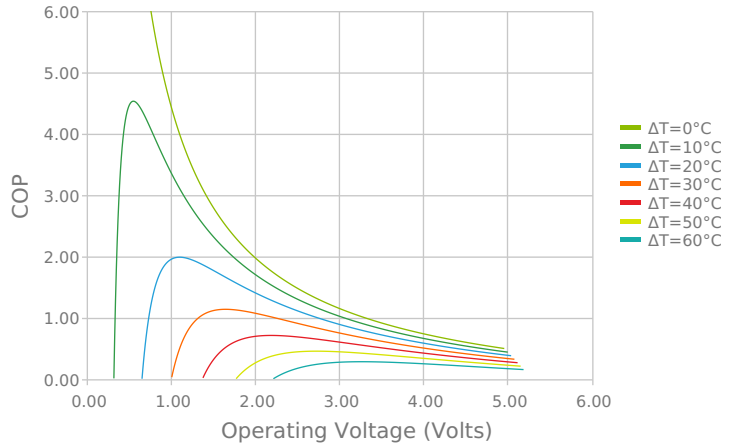

Total Heat Dissipated at Hot Side (Qh=Qc+Pin)
Thot = 85 °C

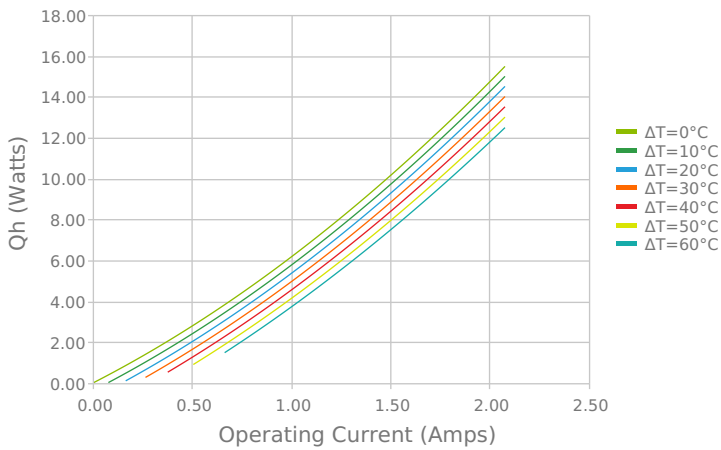

Total Heat Dissipated at Hot Side (Qh=Qc+Pin)
Thot = 85 °C

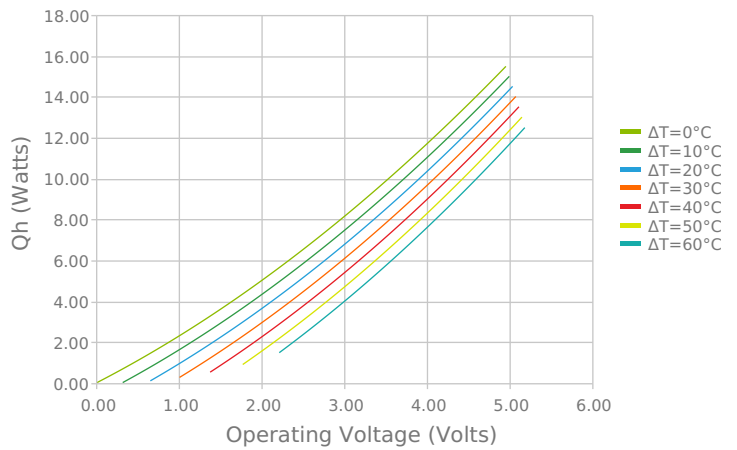

Heat Pumped at Cold Side (Qc)
Thot = 85 °C | Current = 1.6 Amps

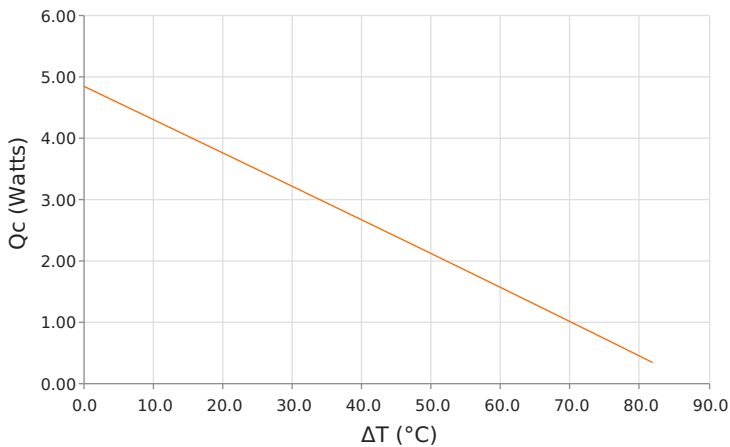

Coefficient of Performance (COP = Qc/Pin)
Thot = 85 °C | Current = 1.6 Amps

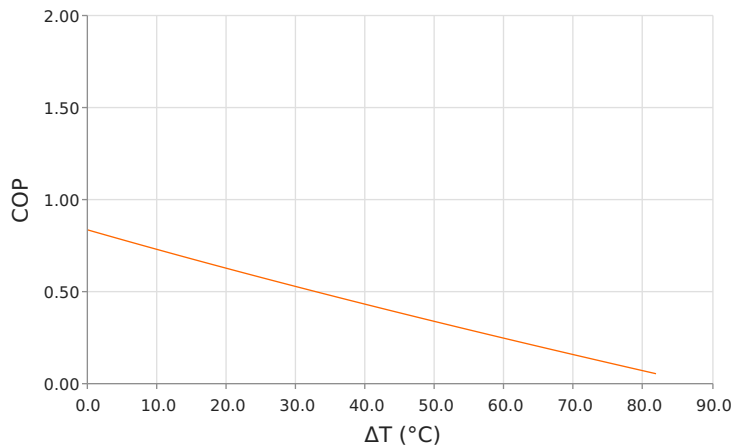

SPECIFICATIONS*

Hot Side Temperature	50.0 °C	85.0 °C	110.0 °C
Qcmax ($\Delta T = 0$)	4.7 Watts	5.2 Watts	5.4 Watts
ΔT_{max} ($Q_c = 0$)	77.9°C	89.3°C	96.2°C
I_{max} (I @ ΔT_{max})	1.9 Amps	1.8 Amps	1.8 Amps
V_{max} (V @ ΔT_{max})	4.2 Volts	4.8 Volts	5.3 Volts
Module Resistance	2.05 Ohms	2.39 Ohms	2.61 Ohms
Max Operating Temperature	150 °C		
Weight	1.0 gram(s)		

* Specifications reflect thermoelectric coefficients updated March 2020

FINISHING OPTIONS

Suffix	Thickness	Flatness / Parallelism	Hot Face	Cold Face	Lead Length
GG	1.981 ±0.127 mm 0.078 ± 0.0050 in	N/A / N/A	Au Plated	Au Plated	50.8 mm 2.00 in

SEALING OPTIONS

Suffix	Sealant	Color	Temp Range	Description
	None			No sealing specified

NOTES

1. Max operating temperature: 150°C
2. Do not exceed I_{max} or V_{max} when operating module
3. Reference assembly guidelines for recommended installation

Any information furnished by Laird and its agents, whether in specifications, data sheets, product catalogues or otherwise, is believed to be (but is not warranted as being) accurate and reliable, is provided for information only and does not form part of any contract with Laird. All specifications are subject to change without notice. Laird assumes no responsibility and disclaims all liability for losses or damages resulting from use of or reliance on this information. All Laird products are sold subject to the Laird Terms and Conditions of sale (including Laird's limited warranty) in effect from time to time, a copy of which will be furnished upon request.

© Copyright 2019-2022 Laird Thermal Systems, Inc. All rights reserved. Laird™, the Laird Ring Logo, and Laird Thermal Systems™ are trademarks or registered trademarks of Laird Limited or its subsidiaries.

Revision: 00 Date: 06-01-2022

Print Date: 06-15-2022